



PDF-XCHANGE



# PDF-Tools V8 USER MANUAL

<https://www.pdf-xchange.com>

[sales@pdf-xchange.com](mailto:sales@pdf-xchange.com)

[support@pdf-xchange.com](mailto:support@pdf-xchange.com)

## Head Office:

Tracker Software Products (Canada) Ltd.  
P.O. Box 79  
9622 Chemainus Road  
Chemainus, British Columbia  
V0R 1K0  
Canada

Sales

Tel: Canada (+00) 1-250-324-1621

Fax: Canada (+00) 1-250-324-1623

## In Europe:

PDF-XChange Co. Ltd  
Horsmanshoad, Pickwell Lane,  
Bolney, West Sussex  
RH17 5RH  
United Kingdom

Sales

Tel: +44 (0)20 8503 8711

Fax: (+00) 1-250-324-1623



|   |            |
|---|------------|
| <b>1. Welcome</b>   | <b>16</b>  |
| <b>2. Installation</b>                                      | <b>18</b>  |
| 2.1 System Requirements .....                               | 21         |
| 2.2 Switches for MSI Installers .....                       | 22         |
| 2.3 Switches for EXE Installers .....                       | 34         |
| 2.4 Licensing .....   | 40         |
| 2.5 The PDF-XChange Updater .....                           | 46         |
| <b>3. Features Overview</b>                                 | <b>51</b>  |
| <b>4. User Interface</b>                                    | <b>57</b>  |
| <b>5. Create Tool</b>                                       | <b>65</b>  |
| <b>6. Clone Tool</b>  | <b>71</b>  |
| <b>7. Actions Library</b>                                   | <b>76</b>  |
| <b>7.1 Create PDF Actions</b> .....                         | <b>78</b>  |
| 7.1.1 Convert Files to PDFs .....                           | 79         |
| 7.1.2 Create PDF from Images .....                          | 86         |
| 7.1.3 Create PDF from Text .....                            | 93         |
| 7.1.4 Extract Pages .....                                   | 97         |
| 7.1.5 Get Images from Scanner .....                         | 99         |
| 7.1.6 Split/Merge Documents .....                           | 103        |
| <b>7.2 Export PDF Actions</b> .....                         | <b>105</b> |
| 7.2.1 Export PDF to Images .....                            | 106        |
| 7.2.2 Export PDF to Microsoft Excel Spreadsheet .....       | 110        |
| 7.2.3 Export PDF to Microsoft PowerPoint Presentation ..... | 113        |
| 7.2.4 Export PDF to Microsoft Word Document .....           | 117        |
| 7.2.5 Export PDF to Plain Text .....                        | 120        |
| 7.2.6 Extract Images from PDF .....                         | 122        |
| 7.2.7 PDF to Audio .....                                    | 124        |
| <b>7.3 Input/Output Actions</b> .....                       | <b>127</b> |
| 7.3.1 Choose Input Files .....                              | 128        |
| 7.3.2 Save Documents .....                                  | 135        |
| 7.3.3 Save Images .....                                     | 137        |
| 7.3.4 Send Mail .....                                       | 140        |
| 7.3.5 Show Files .....                                      | 142        |
| <b>7.4 Bookmark Actions</b> .....                           | <b>144</b> |

|            |   |            |
|------------|---|------------|
| 7.4.1      | Build Table of Contents .....           | 145        |
| 7.4.2      | Export Bookmarks .....                  | 148        |
| 7.4.3      | Export Bookmarks to Text File .....     | 149        |
| 7.4.4      | Find and Replace Bookmark Text .....    | 152        |
| 7.4.5      | Generate Bookmarks from Page Text ..... | 154        |
| 7.4.6      | Import Bookmarks .....                  | 162        |
| 7.4.7      | Import Bookmarks from Text File .....   | 164        |
| <b>7.5</b> | <b>Optimize PDF Actions .....</b>       | <b>166</b> |
| 7.5.1      | Enhance Scanned Pages .....             | 167        |
| 7.5.2      | Optimize Document .....                 | 170        |
| <b>7.6</b> | <b>PDF Standard Actions .....</b>       | <b>179</b> |
| 7.6.1      | Convert to PDF/A .....                  | 180        |
| 7.6.2      | Convert to PDF/X .....                  | 182        |
| 7.6.3      | Discard Special PDF-Standard .....      | 184        |
| <b>7.7</b> | <b>Pages Actions .....</b>              | <b>186</b> |
| 7.7.1      | Add Bates Numbering .....               | 188        |
| 7.7.2      | Add Header and Footer .....             | 192        |
| 7.7.3      | Add Watermarks .....                    | 196        |
| 7.7.4      | Change Page Background .....            | 200        |
| 7.7.5      | Crop Pages .....                        | 204        |
| 7.7.6      | Delete Pages .....                      | 207        |
| 7.7.7      | Duplicate Pages .....                   | 209        |
| 7.7.8      | Insert Empty Pages .....                | 211        |
| 7.7.9      | Insert Pages .....                      | 213        |
| 7.7.10     | Merge Pages .....                       | 216        |
| 7.7.11     | OCR Pages .....                         | 219        |
| 7.7.12     | Overlay PDF .....                       | 224        |
| 7.7.13     | Remove Bates Numbering .....            | 226        |
| 7.7.14     | Remove Headers and Footers.....         | 227        |
| 7.7.15     | Remove Page Background .....            | 228        |
| 7.7.16     | Remove Watermarks .....                 | 229        |
| 7.7.17     | Replace Pages .....                     | 230        |
| 7.7.18     | Resize Pages .....                      | 232        |
| 7.7.19     | Rotate Pages .....                      | 235        |
| 7.7.20     | Setup Page Transitions .....            | 237        |
| 7.7.21     | Split Pages .....                       | 239        |
| <b>7.8</b> | <b>Links Actions .....</b>              | <b>242</b> |
| 7.8.1      | Create Weblinks .....                   | 243        |
| 7.8.2      | Delete Links .....                      | 245        |
| 7.8.3      | Delete Weblinks .....                   | 247        |

|             |                                   |            |
|-------------|-----------------------------------|------------|
| <b>7.9</b>  | <b>Forms Actions</b> .....        | <b>249</b> |
| 7.9.1       | Delete Form Fields .....          | 250        |
| 7.9.2       | Export Form Data .....            | 252        |
| 7.9.3       | Import Form Data .....            | 254        |
| 7.9.4       | Reset Form .....                  | 256        |
| <b>7.10</b> | <b>Comments Actions</b> .....     | <b>257</b> |
| 7.10.1      | Delete All Comments .....         | 258        |
| 7.10.2      | Delete Markup Annotations .....   | 260        |
| 7.10.3      | Export Comments .....             | 262        |
| 7.10.4      | Flatten Comments and Fields ..... | 264        |
| 7.10.5      | Import Comments .....             | 266        |
| 7.10.6      | Summarize Comments .....          | 268        |
| <b>7.11</b> | <b>Protection Actions</b> .....   | <b>271</b> |
| 7.11.1      | Add Digital Signature .....       | 272        |
| 7.11.2      | Add Timestamp .....               | 276        |
| 7.11.3      | Certify Document .....            | 279        |
| 7.11.4      | Clear Digital Signatures .....    | 283        |
| 7.11.5      | Find and Redact .....             | 284        |
| 7.11.6      | Sanitize Document .....           | 287        |
| 7.11.7      | Secure Document .....             | 289        |
| <b>7.12</b> | <b>Advanced Actions</b> .....     | <b>292</b> |
| 7.12.1      | Change Document Properties .....  | 293        |
| 7.12.2      | Convert Colors .....              | 299        |
| 7.12.3      | Filter Documents .....            | 304        |
| 7.12.4      | Filter Files .....                | 306        |
| 7.12.5      | Filter Pages .....                | 308        |
| 7.12.6      | Print Document .....              | 310        |
| <b>8.</b>   | <b>Default Tools</b> .....        | <b>315</b> |
| <b>8.1</b>  | <b>Create PDF Tools</b> .....     | <b>316</b> |
| 8.1.1       | Convert Files to PDFs .....       | 317        |
| 8.1.2       | Create PDF from Images .....      | 319        |
| 8.1.3       | Create PDF from Text .....        | 321        |
| 8.1.4       | Extract Pages .....               | 323        |
| 8.1.5       | Scan to PDF .....                 | 325        |
| 8.1.6       | Split/Merge PDFs .....            | 327        |
| <b>8.2</b>  | <b>Pages Tools</b> .....          | <b>329</b> |
| 8.2.1       | Add Bates Numbering .....         | 331        |
| 8.2.2       | Add Header and Footer .....       | 333        |
| 8.2.3       | Add Watermark .....               | 335        |

|            |   |            |
|------------|---|------------|
| 8.2.4      | Crop Pages .....                        | 337        |
| 8.2.5      | Delete Pages .....                      | 339        |
| 8.2.6      | Duplicate Pages .....                   | 341        |
| 8.2.7      | Insert Empty Pages .....                | 343        |
| 8.2.8      | Insert Pages .....                      | 345        |
| 8.2.9      | Merge Pages .....                       | 347        |
| 8.2.10     | OCR Pages .....                         | 349        |
| 8.2.11     | Overlay PDF .....                       | 351        |
| 8.2.12     | Remove Bates Numbering .....            | 353        |
| 8.2.13     | Remove Headers and Footers .....        | 355        |
| 8.2.14     | Remove Pages Background .....           | 357        |
| 8.2.15     | Remove Watermarks .....                 | 359        |
| 8.2.16     | Replace Pages .....                     | 361        |
| 8.2.17     | Resize Pages .....                      | 363        |
| 8.2.18     | Rotate Pages .....                      | 365        |
| 8.2.19     | Set Page Transitions .....              | 367        |
| 8.2.20     | Set Pages Background .....              | 369        |
| 8.2.21     | Split Pages .....                       | 371        |
| <b>8.3</b> | <b>Links Tools .....</b>                | <b>373</b> |
| 8.3.1      | Create Weblinks .....                   | 374        |
| 8.3.2      | Delete Links .....                      | 376        |
| 8.3.3      | Delete Weblinks .....                   | 378        |
| <b>8.4</b> | <b>Forms Tools .....</b>                | <b>380</b> |
| 8.4.1      | Delete Form Fields .....                | 381        |
| 8.4.2      | Export Form Data .....                  | 383        |
| 8.4.3      | Import Form Data .....                  | 385        |
| 8.4.4      | Reset Forms .....                       | 387        |
| <b>8.5</b> | <b>Comments Tools .....</b>             | <b>389</b> |
| 8.5.1      | Delete All Comments .....               | 390        |
| 8.5.2      | Delete Markup Annotations .....         | 392        |
| 8.5.3      | Export Comments .....                   | 394        |
| 8.5.4      | Flatten Comments and Fields .....       | 396        |
| 8.5.5      | Import Comments .....                   | 398        |
| 8.5.6      | Summarize Comments .....                | 400        |
| <b>8.6</b> | <b>Bookmarks Tools .....</b>            | <b>402</b> |
| 8.6.1      | Build Table of Contents .....           | 403        |
| 8.6.2      | Export Bookmarks .....                  | 405        |
| 8.6.3      | Export Bookmarks to Text File .....     | 407        |
| 8.6.4      | Find and Replace Bookmark Text .....    | 409        |
| 8.6.5      | Generate Bookmarks from Page Text ..... | 411        |

|             |   |            |
|-------------|---|------------|
| 8.6.6       | Import Bookmarks .....                                | 413        |
| 8.6.7       | Import Bookmarks from Text File .....                 | 415        |
| <b>8.7</b>  | <b>Protection Tools .....</b>                         | <b>417</b> |
| 8.7.1       | Add Digital Signature .....                           | 418        |
| 8.7.2       | Certify PDFs .....                                    | 420        |
| 8.7.3       | Clear All Digital Signatures .....                    | 422        |
| 8.7.4       | Find and Redact .....                                 | 424        |
| 8.7.5       | Sanitize Document .....                               | 426        |
| 8.7.6       | Secure PDF .....                                      | 428        |
| 8.7.7       | Timestamp PDFs .....                                  | 430        |
| <b>8.8</b>  | <b>Optimize PDF Tools .....</b>                       | <b>432</b> |
| 8.8.1       | Enhance Scanned Pages .....                           | 433        |
| 8.8.2       | Optimize PDF .....                                    | 435        |
| <b>8.9</b>  | <b>PDF Standard Tools .....</b>                       | <b>437</b> |
| 8.9.1       | Convert to PDF/A .....                                | 438        |
| 8.9.2       | Convert to PDF/X .....                                | 440        |
| 8.9.3       | Discard Special PDF-Standard .....                    | 442        |
| <b>8.10</b> | <b>Export PDF Tools .....</b>                         | <b>444</b> |
| 8.10.1      | Export PDF to Audio .....                             | 445        |
| 8.10.2      | Export PDF to Images .....                            | 447        |
| 8.10.3      | Export PDF to Microsoft Excel Spreadsheet .....       | 449        |
| 8.10.4      | Export PDF to Microsoft Powerpoint Presentation ..... | 451        |
| 8.10.5      | Export PDF to Microsoft Word Document .....           | 453        |
| 8.10.6      | Export PDF to Plain Text .....                        | 455        |
| 8.10.7      | Extract Images from PDF .....                         | 457        |
| <b>8.11</b> | <b>Advanced Tools .....</b>                           | <b>459</b> |
| 8.11.1      | Change Document Properties .....                      | 460        |
| 8.11.2      | Convert Colors .....                                  | 462        |
| 8.11.3      | Print Document .....                                  | 464        |
| 8.11.4      | Send E-Mail .....                                     | 466        |
| <b>9.</b>   | <b>Appendix .....</b>                                 | <b>468</b> |
| 9.1         | Available File Filters .....                          | 469        |
| 9.2         | Command Line Options .....                            | 472        |
| 9.3         | Crop Margins .....                                    | 482        |
| 9.4         | Features Added in Version 8 .....                     | 484        |
| 9.5         | Font and Paragraph Parameters .....                   | 486        |
| 9.6         | Macros .....  | 488        |
| 9.6.1       | Document Title .....                                  | 491        |

|             |  |            |
|-------------|--|------------|
| 9.6.2       | Document Info .....                            | 493        |
| 9.6.3       | Document Index .....                           | 497        |
| 9.6.4       | Page Number .....                              | 501        |
| 9.6.5       | Number of Pages .....                          | 506        |
| 9.6.6       | FileName .....                                 | 509        |
| 9.6.7       | Folder Name .....                              | 511        |
| 9.6.8       | Date .....                                     | 513        |
| 9.6.9       | Year .....                                     | 516        |
| 9.6.10      | Month .....                                    | 519        |
| 9.6.11      | Day .....                                      | 522        |
| 9.6.12      | Time .....                                     | 525        |
| 9.6.13      | Hour .....                                     | 528        |
| 9.6.14      | Minute .....                                   | 531        |
| 9.6.15      | Seconds .....                                  | 534        |
| 9.6.16      | Computer Name .....                            | 537        |
| 9.6.17      | Username .....                                 | 539        |
| 9.6.18      | Environment Variable .....                     | 541        |
| 9.6.19      | Auto Number .....                              | 545        |
| 9.6.20      | Application Version .....                      | 548        |
| <b>9.7</b>  | <b>Media Foundation Installation .....</b>     | <b>550</b> |
| <b>9.8</b>  | <b>Page Range Options .....</b>                | <b>552</b> |
| <b>9.9</b>  | <b>Preferences .....</b>                       | <b>554</b> |
| 9.9.1       | General .....                                  | 556        |
| 9.9.2       | Languages .....                                | 558        |
| 9.9.3       | Passwords .....                                | 560        |
| 9.9.4       | Registration .....                             | 562        |
| 9.9.5       | Color Management .....                         | 564        |
| 9.9.6       | Convert to PDF .....                           | 566        |
| 9.9.7       | Customize UI .....                             | 568        |
| 9.9.8       | Identity .....                                 | 570        |
| 9.9.9       | Measurement .....                              | 571        |
| 9.9.10      | OCR .....                                      | 572        |
| 9.9.11      | Scanner Presets .....                          | 574        |
| 9.9.12      | Send Mail .....                                | 578        |
| 9.9.13      | Signatures .....                               | 580        |
| 9.9.14      | Update .....                                   | 584        |
| <b>9.10</b> | <b>Folder Monitors .....</b>                   | <b>585</b> |
| <b>10.</b>  | <b>PDF-XChange Editor V8 User Manual .....</b> | <b>590</b> |
| <b>10.1</b> | <b>Features Overview .....</b>                 | <b>593</b> |



|             |   |            |
|-------------|---|------------|
| <b>10.2</b> | <b>Explore the User Interface .....</b> | <b>596</b> |
| <b>10.3</b> | <b>Operations Guide .....</b>           | <b>603</b> |
| 10.3.1      | Annotations Guide .....                 | 604        |
| 10.3.2      | Bookmarks Guide .....                   | 624        |
| 10.3.3      | Document Operations Guide .....         | 632        |
| 10.3.3.1    | Create Documents .....                  | 633        |
| 10.3.3.2    | Edit Documents .....                    | 643        |
| 10.3.3.3    | Open Documents .....                    | 715        |
| 10.3.3.4    | Miscellaneous Document Operations ..... | 718        |
| 10.3.3.5    | Save Documents .....                    | 735        |
| 10.3.4      | Editing Panes Guide .....               | 738        |
| 10.3.5      | Forms Guide .....                       | 744        |
| 10.3.6      | Workspace Guide .....                   | 750        |
| 10.3.6.1    | Customize the Workspace .....           | 751        |
| 10.3.6.2    | Navigate the Workspace .....            | 764        |
| <b>10.4</b> | <b>Tabs Guide .....</b>                 | <b>770</b> |
| 10.4.1      | File Tab .....                          | 772        |
| 10.4.1.1    | Open .....                              | 775        |
| 10.4.1.1.1  | Recent Files .....                      | 777        |
| 10.4.1.1.2  | Sessions .....                          | 779        |
| 10.4.1.1.3  | Add a Place .....                       | 782        |
| 10.4.1.2    | Save Options .....                      | 784        |
| 10.4.1.3    | New Document .....                      | 795        |
| 10.4.1.3.1  | With Blank Pages .....                  | 797        |
| 10.4.1.3.2  | Combine Files Into a Single PDF .....   | 799        |
| 10.4.1.3.3  | PDF Portfolio .....                     | 803        |
| 10.4.1.3.4  | From Text Files .....                   | 807        |
| 10.4.1.3.5  | From Markdown .....                     | 812        |
| 10.4.1.3.6  | From CSV File .....                     | 815        |
| 10.4.1.3.7  | From Rich Text Format (RTF) Files ..... | 816        |
| 10.4.1.3.8  | From Image File(s) .....                | 819        |
| 10.4.1.3.9  | From Scanner .....                      | 829        |
| 10.4.1.4    | Print .....                             | 833        |
| 10.4.1.5    | Export .....                            | 838        |
| 10.4.1.6    | Share .....                             | 841        |
| 10.4.1.7    | Document Properties .....               | 843        |
| 10.4.1.8    | Preferences .....                       | 854        |
| 10.4.1.8.1  | Documents .....                         | 857        |
| 10.4.1.8.2  | General .....                           | 860        |
| 10.4.1.8.3  | Page Display .....                      | 863        |
| 10.4.1.8.4  | Page Text .....                         | 867        |
| 10.4.1.8.5  | Registration .....                      | 869        |
| 10.4.1.8.6  | Accessibility .....                     | 871        |
| 10.4.1.8.7  | Color Management .....                  | 873        |
| 10.4.1.8.8  | Commenting .....                        | 875        |

|               |                                   |            |
|---------------|-----------------------------------|------------|
| 10.4.1.8.9    | Convert to/from PDF .....         | 877        |
| 10.4.1.8.10   | Customize UI .....                | 879        |
| 10.4.1.8.11   | Document Info Bar .....           | 881        |
| 10.4.1.8.12   | File Associations .....           | 883        |
| 10.4.1.8.13   | Forms .....                       | 885        |
| 10.4.1.8.14   | Full Screen .....                 | 887        |
| 10.4.1.8.15   | Identity .....                    | 889        |
| 10.4.1.8.16   | JavaScript .....                  | 891        |
| 10.4.1.8.17   | Languages .....                   | 893        |
| 10.4.1.8.18   | Launch Applications .....         | 895        |
| 10.4.1.8.19   | Measurement .....                 | 898        |
| 10.4.1.8.20   | Multimedia 3D .....               | 902        |
| 10.4.1.8.21   | OCR .....                         | 904        |
| 10.4.1.8.22   | Performance .....                 | 906        |
| 10.4.1.8.23   | Places .....                      | 908        |
| 10.4.1.8.24   | Plugins .....                     | 910        |
| 10.4.1.8.25   | Scanner Presets .....             | 912        |
| 10.4.1.8.26   | Search Providers .....            | 914        |
| 10.4.1.8.27   | Security .....                    | 916        |
| 10.4.1.8.28   | Send Mail .....                   | 919        |
| 10.4.1.8.29   | SharePoint .....                  | 921        |
| 10.4.1.8.30   | Signatures .....                  | 922        |
| 10.4.1.8.31   | Snapshot Tool .....               | 926        |
| 10.4.1.8.32   | Speech .....                      | 928        |
| 10.4.1.8.33   | Tools .....                       | 930        |
| 10.4.1.8.34   | Update .....                      | 932        |
| 10.4.1.9      | Manage Settings .....             | 933        |
| <b>10.4.2</b> | <b>Home Tab .....</b>             | <b>938</b> |
| 10.4.2.1      | Hand Tool .....                   | 943        |
| 10.4.2.2      | Selection Options .....           | 946        |
| 10.4.2.3      | Transform .....                   | 948        |
| 10.4.2.4      | Duplicate .....                   | 950        |
| 10.4.2.5      | New Stamp from Selection .....    | 953        |
| 10.4.2.6      | New Document from Selection ..... | 955        |
| 10.4.2.7      | Link Options .....                | 956        |
| 10.4.2.7.1    | Run a JavaScript .....            | 963        |
| 10.4.2.7.2    | Go To Page Options .....          | 965        |
| 10.4.2.7.3    | Open a Web Link .....             | 968        |
| 10.4.2.7.4    | Open a File .....                 | 970        |
| 10.4.2.7.5    | Execute a Command .....           | 972        |
| 10.4.2.7.6    | Reset a Form .....                | 974        |
| 10.4.2.7.7    | Submit a Form .....               | 976        |
| 10.4.2.7.8    | Play a Sound .....                | 979        |
| 10.4.2.7.9    | Go to a 3D/Multimedia View .....  | 981        |
| 10.4.2.7.10   | Show/Hide a Field .....           | 983        |
| 10.4.2.7.11   | Read an Article .....             | 985        |

|             |                               |      |
|-------------|-------------------------------|------|
| 10.4.3      | View Tab .....                | 986  |
| 10.4.3.1    | Editing Panes .....           | 992  |
| 10.4.3.1.1  | Bookmarks .....               | 994  |
| 10.4.3.1.2  | Thumbnails .....              | 1000 |
| 10.4.3.1.3  | Comments .....                | 1007 |
| 10.4.3.1.4  | Attachments .....             | 1014 |
| 10.4.3.1.5  | Fields .....                  | 1016 |
| 10.4.3.1.6  | Signatures .....              | 1021 |
| 10.4.3.1.7  | Layers .....                  | 1024 |
| 10.4.3.1.8  | Content .....                 | 1032 |
| 10.4.3.1.9  | Destinations .....            | 1036 |
| 10.4.3.1.10 | 3D Model Tree .....           | 1039 |
| 10.4.3.1.11 | Links .....                   | 1043 |
| 10.4.3.1.12 | Pan and Zoom .....            | 1047 |
| 10.4.3.1.13 | Stamps Palette .....          | 1050 |
| 10.4.3.1.14 | Comment Styles Palette .....  | 1053 |
| 10.4.3.1.15 | Spell Check Pane .....        | 1057 |
| 10.4.3.1.16 | Document Recovery Pane .....  | 1059 |
| 10.4.3.1.17 | History .....                 | 1061 |
| 10.4.3.1.18 | Properties Pane .....         | 1065 |
| 10.4.3.2    | Zoom In/Out Tool .....        | 1067 |
| 10.4.3.3    | Loupe Tool .....              | 1068 |
| 10.4.3.4    | Pan and Zoom .....            | 1070 |
| 10.4.3.5    | Page Transitions .....        | 1072 |
| 10.4.3.6    | Rulers, Guides and Grid ..... | 1075 |
| 10.4.4      | Comment Tab .....             | 1082 |
| 10.4.4.1    | Select Comments .....         | 1087 |
| 10.4.4.2    | Typewriter Tool .....         | 1089 |
| 10.4.4.3    | Text Box Tool .....           | 1094 |
| 10.4.4.4    | Callout Tool .....            | 1099 |
| 10.4.4.5    | Sticky Note Tool .....        | 1105 |
| 10.4.4.6    | File Attachment Tool .....    | 1110 |
| 10.4.4.7    | Sound Tool .....              | 1115 |
| 10.4.4.8    | Highlight Text Tool .....     | 1120 |
| 10.4.4.9    | Underline Text Tool .....     | 1125 |
| 10.4.4.10   | Strikeout Text Tool .....     | 1130 |
| 10.4.4.11   | Insert Text Tool .....        | 1135 |
| 10.4.4.12   | Replace Text Tool .....       | 1141 |
| 10.4.4.13   | Text Correction Tool .....    | 1147 |
| 10.4.4.14   | Line Tool .....               | 1149 |
| 10.4.4.15   | Arrow Tool .....              | 1156 |
| 10.4.4.16   | Rectangle Tool .....          | 1162 |
| 10.4.4.17   | Oval Tool .....               | 1167 |
| 10.4.4.18   | Polygon Line Tool .....       | 1172 |
| 10.4.4.19   | Polygon Tool .....            | 1178 |
| 10.4.4.20   | Cloud Tool .....              | 1183 |
| 10.4.4.21   | Stamp Tool .....              | 1188 |

|             |   |      |
|-------------|---|------|
| 10.4.4.22   | Pencil Tool .....                               | 1201 |
| 10.4.4.23   | Measuring Tools .....                           | 1206 |
| 10.4.4.23.1 | Distance Tool .....                             | 1208 |
| 10.4.4.23.2 | Perimeter Tool .....                            | 1214 |
| 10.4.4.23.3 | Area Tool .....                                 | 1219 |
| 10.4.4.23.4 | Set Scale .....                                 | 1224 |
| 10.4.4.24   | Add/Edit 3D Annotations .....                   | 1226 |
| 10.4.4.25   | Manage Comments .....                           | 1229 |
| 10.4.4.25.1 | Summarize Comments .....                        | 1231 |
| 10.4.4.25.2 | Import Comments .....                           | 1234 |
| 10.4.4.25.3 | Export Comments .....                           | 1236 |
| 10.4.4.25.4 | Show Comments .....                             | 1237 |
| 10.4.4.25.5 | Flatten Comments .....                          | 1239 |
| 10.4.4.25.6 | Show Comments List .....                        | 1241 |
| 10.4.4.25.7 | Comment Styles Palette .....                    | 1242 |
| 10.4.5      | Protect Tab .....                               | 1244 |
| 10.4.5.1    | Digital Signature Options .....                 | 1248 |
| 10.4.5.2    | Signatures and Initials .....                   | 1255 |
| 10.4.5.3    | Redaction and Sanitization .....                | 1257 |
| 10.4.6      | Form Tab .....                                  | 1265 |
| 10.4.6.1    | Add Text Fields to Documents .....              | 1270 |
| 10.4.6.2    | Add Check Boxes to Documents .....              | 1293 |
| 10.4.6.3    | Add Radio Buttons to Documents .....            | 1305 |
| 10.4.6.4    | Add List Boxes to Documents .....               | 1317 |
| 10.4.6.5    | Add Dropdown Menus to Documents .....           | 1329 |
| 10.4.6.6    | Add Buttons to Documents .....                  | 1356 |
| 10.4.6.7    | Add Digital Signature Fields to Documents ..... | 1374 |
| 10.4.6.8    | Add Barcodes to Documents .....                 | 1392 |
| 10.4.6.9    | Add Date Fields to Documents .....              | 1409 |
| 10.4.6.10   | Add Image Fields to Documents .....             | 1420 |
| 10.4.6.11   | JavaScript Console .....                        | 1429 |
| 10.4.6.12   | Populate Forms .....                            | 1431 |
| 10.4.6.13   | Editing Forms .....                             | 1437 |
| 10.4.7      | Organize Tab .....                              | 1447 |
| 10.4.7.1    | Insert .....                                    | 1451 |
| 10.4.7.2    | Delete Pages .....                              | 1459 |
| 10.4.7.3    | Extract Pages .....                             | 1462 |
| 10.4.7.4    | Duplicate Pages .....                           | 1465 |
| 10.4.7.5    | Move Pages .....                                | 1468 |
| 10.4.7.6    | Replace Pages .....                             | 1470 |
| 10.4.7.7    | Split Options .....                             | 1473 |
| 10.4.7.8    | Swap Pages .....                                | 1477 |
| 10.4.7.9    | Merge Pages .....                               | 1479 |
| 10.4.7.10   | Rotate Pages .....                              | 1482 |
| 10.4.7.11   | Crop .....                                      | 1484 |
| 10.4.7.12   | Resize .....                                    | 1488 |
| 10.4.7.13   | Watermarks .....                                | 1491 |

|                |  |             |
|----------------|--|-------------|
| 10.4.7.14      | Background .....   | 1494        |
| 10.4.7.15      | Header and Footer .....                                  | 1497        |
| 10.4.7.16      | Bates Numbering .....                                    | 1500        |
| 10.4.7.17      | Number Pages .....                                       | 1504        |
| <b>10.4.8</b>  | <b>Convert Tab .....</b>                                 | <b>1515</b> |
| 10.4.8.1       | OCR Pages .....  | 1519        |
| 10.4.8.2       | Enhance Scanned Pages .....                              | 1526        |
| 10.4.8.3       | Convert Colors .....                                     | 1529        |
| 10.4.8.4       | Rasterize Pages .....                                    | 1534        |
| <b>10.4.9</b>  | <b>Share Tab .....</b>                                   | <b>1537</b> |
| <b>10.4.10</b> | <b>Review Tab .....</b>                                  | <b>1541</b> |
| 10.4.10.1      | Spell Check .....  | 1545        |
| <b>10.4.11</b> | <b>Bookmarks Tab .....</b>                               | <b>1549</b> |
| 10.4.11.1      | Generate Bookmarks from Page Text .....                  | 1552        |
| 10.4.11.2      | Bookmark Every Nth Page .....                            | 1560        |
| 10.4.11.3      | Generate Bookmarks from Table of Contents .....          | 1562        |
| 10.4.11.4      | Generate Bookmarks from Text File .....                  | 1564        |
| 10.4.11.5      | Add Text to Bookmark Titles .....                        | 1567        |
| 10.4.11.6      | Change Bookmark Case .....                               | 1569        |
| 10.4.11.7      | Change Bookmarks Zoom Factor .....                       | 1571        |
| 10.4.11.8      | Convert Named Destinations to Regular Destinations ..... | 1573        |
| 10.4.11.9      | Find and Replace Bookmark Text .....                     | 1575        |
| 10.4.11.10     | Remove Actions from Bookmarks .....                      | 1577        |
| 10.4.11.11     | Sort Bookmarks .....                                     | 1580        |
| 10.4.11.12     | Validate Bookmarks .....                                 | 1582        |
| 10.4.11.13     | Build Table of Contents .....                            | 1584        |
| 10.4.11.14     | Create Links from Bookmarks .....                        | 1586        |
| 10.4.11.15     | Sort Pages by Bookmarks .....                            | 1589        |
| 10.4.11.16     | Convert to Named Destinations .....                      | 1590        |
| 10.4.11.17     | Export Bookmarks to HTML .....                           | 1592        |
| 10.4.11.18     | Export Bookmarks to Text File .....                      | 1593        |
| <b>10.4.12</b> | <b>Help Tab .....</b>                                    | <b>1596</b> |
| 10.4.12.1      | Customize Toolbars .....                                 | 1599        |
| 10.4.12.2      | Report a Problem .....                                   | 1622        |
| <b>10.4.13</b> | <b>Format Tab .....</b>                                  | <b>1624</b> |
| <b>10.4.14</b> | <b>Arrange Tab .....</b>                                 | <b>1626</b> |
| <b>10.4.15</b> | <b>Portfolio Tab .....</b>                               | <b>1630</b> |
| <b>10.5</b>    | <b>Appendix .....</b>                                    | <b>1633</b> |
| 10.5.1         | Accessibility Check .....                                | 1635        |
| 10.5.2         | Add/Edit Content .....                                   | 1638        |
| 10.5.3         | Blend Mode .....   | 1659        |
| 10.5.4         | Changing the Layout of Panes .....                       | 1662        |
| 10.5.5         | Command Line Options .....                               | 1669        |
| 10.5.6         | Document Tab Options .....                               | 1680        |
| 10.5.7         | Editing Document Pages .....                             | 1682        |

|             |  |             |
|-------------|--|-------------|
| 10.5.8      | Editing Text in Annotations .....              | 1683        |
| 10.5.9      | Features Added in V8 .....                     | 1686        |
| 10.5.10     | Find .....                                     | 1688        |
| 10.5.11     | Keyboard Shortcuts .....                       | 1691        |
| 10.5.12     | Macros .....                                   | 1707        |
| 10.5.12.1   | Document Title .....                           | 1710        |
| 10.5.12.2   | Document Info .....                            | 1712        |
| 10.5.12.3   | Document Index .....                           | 1718        |
| 10.5.12.4   | Page Number .....                              | 1721        |
| 10.5.12.5   | Number of Pages .....                          | 1726        |
| 10.5.12.6   | FileName .....                                 | 1729        |
| 10.5.12.7   | Folder Name .....                              | 1733        |
| 10.5.12.8   | Folder Title .....                             | 1735        |
| 10.5.12.9   | Date .....                                     | 1737        |
| 10.5.12.10  | Year .....                                     | 1740        |
| 10.5.12.11  | Month .....                                    | 1742        |
| 10.5.12.12  | Day .....                                      | 1744        |
| 10.5.12.13  | Time .....                                     | 1746        |
| 10.5.12.14  | Hour .....                                     | 1749        |
| 10.5.12.15  | Minute .....                                   | 1751        |
| 10.5.12.16  | Seconds .....                                  | 1753        |
| 10.5.12.17  | Computer Name .....                            | 1755        |
| 10.5.12.18  | Username .....                                 | 1757        |
| 10.5.12.19  | Environment Variable .....                     | 1759        |
| 10.5.12.20  | Auto Number .....                              | 1763        |
| 10.5.12.21  | Application Version .....                      | 1766        |
| 10.5.12.22  | Macro-Enabled Operations .....                 | 1768        |
| 10.5.13     | Page Boxes .....                               | 1770        |
| 10.5.14     | Page Range Settings .....                      | 1773        |
| 10.5.15     | Read Out Loud Feature .....                    | 1774        |
| 10.5.16     | Search .....                                   | 1776        |
| 10.5.17     | Shell Extensions .....                         | 1781        |
| 10.5.18     | Tool Content Options .....                     | 1783        |
| 10.5.19     | Tool Properties .....                          | 1788        |
| <b>11.</b>  | <b>PDF-XChange Lite V8 User Manual</b> .....   | <b>1792</b> |
| <b>11.1</b> | <b>Features Overview</b> .....                 | <b>1794</b> |
| <b>11.2</b> | <b>PDF-XChange Lite Printer Settings</b> ..... | <b>1795</b> |
| 11.2.1      | Paper .....                                    | 1797        |
| 11.2.1.1    | Standard Layout .....                          | 1800        |
| 11.2.1.2    | Booklet Layout .....                           | 1802        |
| 11.2.1.3    | Multiple Pages per Sheet .....                 | 1804        |
| 11.2.2      | Custom Forms .....                             | 1806        |
| 11.2.3      | Fonts .....                                    | 1809        |
| 11.2.4      | Document Info .....                            | 1811        |

|              |                                   |             |
|--------------|-----------------------------------|-------------|
| 11.2.5       | Save .....                        | 1813        |
| 11.2.5.1     | Macros .....                      | 1815        |
| 11.2.6       | Languages .....                   | 1822        |
| 11.2.7       | Driver Mode .....                 | 1824        |
| 11.2.8       | PDF Saver .....                   | 1827        |
| 11.2.9       | Features Added in Version 8 ..... | 1830        |
| <b>Index</b> |                                   | <b>1833</b> |

## 1 Welcome

---



### PDF-Tools V8

---

Welcome to **PDF-Tools** - one of the most advanced and customizable PDF software tools available worldwide. This application is a dynamic and user-friendly solution for the creation and manipulation of PDF and image files. **PDF-Tools** features seventy default tools, as well as the option to clone, edit and create fully-customizable tools, which makes it the ideal software to compliment your existing PDF facilities and optimize the efficiency of your workflow. Two additional **PDF-XChange** applications are included with this product:



**PDF-XChange Editor** – one of the smallest, fastest and most feature-rich PDF editor/viewers available worldwide. The **PDF-XChange Editor** manual is available [here](#).<sup>590</sup>



**PDF-XChange Lite** – our award-winning technology that installs as a virtual printer and features an optimized hybrid engine that significantly increases the quality of conversion for images and image-based text characters, and prints-to-PDF from **Windows** applications to both **GDI** and **XPS**. The **PDF-XChange Lite** manual is available [here](#).<sup>1792</sup>

We offer several other cutting-edge applications for the manipulation of PDF and image files. Please see the [PDF-XChange Products Page](#) for further information.

If you have any queries then please [Contact Us](#). We aim to respond to all communication within eight hours - and we are usually much faster. Additionally, the [User Forums](#) are an excellent resource for troubleshooting, and our [Knowledgebase](#) contains over four hundred articles about our software and other relevant information.

This manual is composed of the following sections:

- **Installation** details the installation process, system requirements, installation switch options and licensing details for the software.



- **Features Overview** details the main features of **PDF-Tools**.
- **User Interface** details the various components of the **PDF-Tools** user interface.
- **Create Tool** details the **Create Tool** feature, which is used to create custom tools.
- **Clone Tool** details the **Clone Tool** feature, which is used to clone the default tools and enables the customization of their settings.
- **Actions Library** details the actions that the **Create Tool** feature uses to build tools.
- **Default Tools** details the seventy default tools included in the application.
- **Appendix** details additional information that relates to the software.
- [PDF-XChange Editor V8 User Manual](#)<sup>590</sup> - a comprehensive guide to **PDF-XChange Editor**, the PDF viewer/editing software that is included with this product.
- [PDF-XChange Lite V8 User Manual](#)<sup>1792</sup> - a comprehensive guide to **PDF-XChange Lite**, the virtual printer that is included with this product.

A PDF version of this manual is available [here](#).

---

Note that the icons in the upper left of the screen can be used to browse/search the manual:

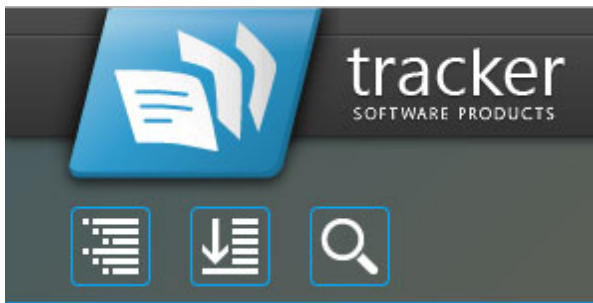

Click the **Table of Contents** to view/move to chapters of the manual.



Click the **Keyword Index** to view keywords, and click keywords to move to their location in the manual.



Click **Search Topics** to enter custom search terms.

---

## 2 Installation

---



### Installation

---

Follow these steps to install **PDF-Tools**:

1. Use the link in your purchase confirmation email or click either link below to download the evaluation version of **PDF-Tools**:

[PDF-Tools](#) (includes the trial version of **PDF-Tools**).

[PDF-XChange Pro](#) (includes the live version of **PDF-Tools**. A serial key/activation code is required for this option).

2. When the download is complete, click the **PDFTools8.zip** file to open the containing folder. ([Winzip](#) and [CnetsDownload.com](#) have free downloads available if you require software to unzip files).

3. **PDF Tools8** is displayed next to an icon. Double-click to open the **Run/Cancel** dialog box.

4. Click **Run** to open the **PDF-Tools V8 Setup**.

5. Click **Install**.

Please note: when the installer is first run a prompt will ask for your registration number/activation code. We recommend copying and pasting this information from your receipt.

If you have already installed the evaluation version of **PDF-Tools** then there is no need to reinstall it. Follow these steps to register:

1. Open **PDF-Tools** and click **Options** in the **Main Toolbar**, then click **Preferences**. The **Preferences** dialog box will open.

2. Click **Registration** in the **Categories** menu. The **Registration Info** dialog box will open.

3. Click **Add new License Key**. The **Add New License Key/Activation Code** dialog box will open.
4. Click **Paste Key from Clipboard** or enter your license key manually.
5. Click **Continue**. The license will then register.

Alternatively, the **XCVault.exe** file attached to your invoice can be used to register your **PDF-Tools** license. Click the file to register the software. Note that the trial version of **PDF-Tools** must first be installed to do this. It is available [here](#). The **XCVault.exe** file can also be accessed from your online account. Login at the [PDF-XChange](#) website and move to the **Your Products & Serial Numbers** tab:

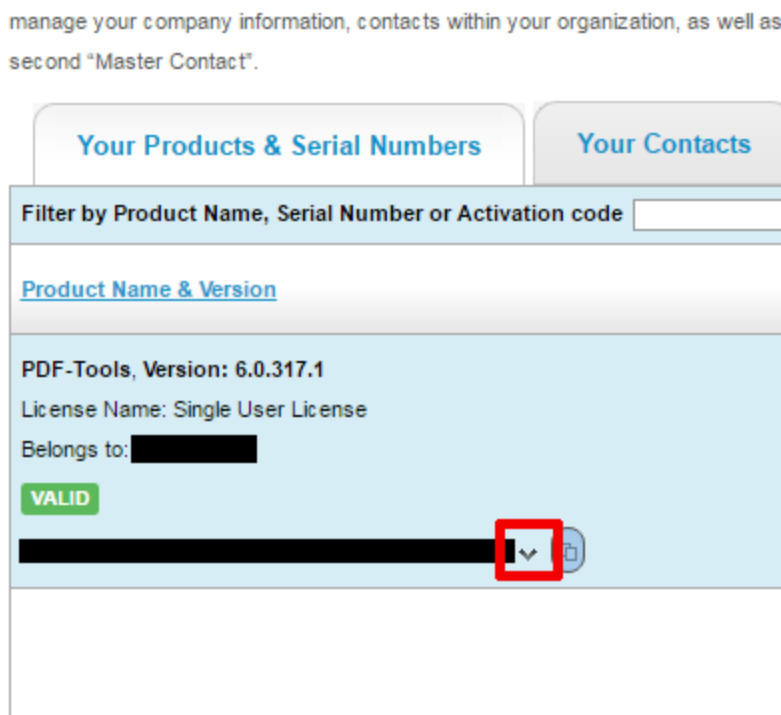

Figure 1. Your Products & Serial Numbers Tab

Click the arrow to open the serial key/activation code window.

Note that it is not necessary to be online to install a license for **PDF-Tools**. If you have a hard copy of your license key (for example on a USB stick) then you can simply copy it into the text box in the **Registration** section detailed above in order to register the license on an offline machine.

## VERY IMPORTANT

Please keep your serial key/activation code safe. Do not share it with other parties, as doing so constitutes an illegal breach of copyright. If we discover evidence of abuse then updates will be disabled for your account. Serial keys/activation codes found on websites offering free and illegal software distribution will be disabled immediately. We monitor such websites on a daily basis. Help us safeguard the integrity of our products to ensure that their future development is made possible. Theft of our software deprives us of investment that improves our products for the benefit of all clients.

---

## 2.1 System Requirements

---



### System Requirements

---

**PDF-Tools** supports all **Windows** (32/64 bit) operating systems from **Windows 7** and later:



Figure 1. Supported Operating Systems

Please note the following:

- All versions from **V4** to **V8** are **Microsoft/Citrix Terminal Server** compatible.
  - All versions from **V4** to **V7** are **Windows XP/Vista** compatible.
  - **V3** is still available for **Windows 95/98**.
  - We recommend that users install the latest **Microsoft Windows** service packs and updates before using our products, as doing so will ensure the greatest possible performance of the software.
  - Our products - in particular the printer drivers that **PDF-XChange Standard** and **PDF-XChange Lite** utilize - are not designed to work in virtualized environments such as the **XenApp** software.
  - There are some limitations to product support for **Windows XP** as **Microsoft** have stopped supporting it. Further information about this issue is available [here](#).
  - If you are using **Windows 7** then please ensure you have the latest release and all available fixes - otherwise you may encounter issues, as detailed [here](#).
-

## 2.2 Switches for MSI Installers

---



### Switches for MSI Installers

---

The most useful options for `msiexec` are detailed below. Please note that parameters are case sensitive. All available options are detailed [here](#).

The command line for installation is: **`msiexec /Option <Required Parameter> [Optional Parameter] [PROPERTY=PropertyValue]`**

---

#### Install Options

---

**`/package`** or **`/i`**

This switch installs or configures the product specified.

#### Syntax

**`<Product.msi>`**

---

**`/a`**

This switch installs the product specified on the network as an administrative install.

#### Syntax

**`<Product.msi>`**

---

**`/j<u|m>`**

This switch advertises the specified product. "**u**" advertises to the current user, "**m**" advertises to all users.

### Syntax

<Product.msi>

### Parameters

- [/t <Transform List>]
  - [/g <Language ID>]
- 

### /uninstall | /x

This switch uninstalls the product specified.

### Syntax

<Product.msi>

### Parameters

The parameter for this switch can be either an .msi file or the relevant product code.

---

## Display Options

---

### /quiet

This switch installs the application without user interaction.

---

### /passive

This switch installs the application in unattended mode. The user will see only the progress bar.

---

**/q[n|b|r|f]**

This switch sets the user interface level. "**b**" installs a basic UI, "**f**" installs a full UI and is the default setting, "**n**" means that no UI is installed, "**r**" installs a reduced UI.

---

**Restart Options**

---

**/norestart**

This switch disables the automatic system restart when installation is complete. (Please note that many **PDF-XChange** products require a restart to function properly).

---

**/promptrestart**

This switch prompts the user for a restart when it is necessary.

---

**/forcerestart**

This switch forces a system restart when installation is complete.

---

**Logging Options**

---

**/l**

This switch defines the logging level for installation.

**Syntax**

<Logfile>

**Modifiers**

**a** - start up of actions.



**c** - initial UI parameters.

**e** - all error messages.

**i** - status messages.

**m** - out of memory or fatal exit information.

**o** - out of disk space messages.

**p** - terminal properties.

**r** - action-specific records.

**u** - user requests.

**v** - verbose output.

**w** - nonfatal warnings.

**x** - extra debugging information.

**+** - append to existing file.

**!** - flush each line to the log.

**\*** - log all information except for verbose output and extra debugging information.

---

## **/log**

This switch is the equivalent for **/!\* <LogFile>**.

## **Syntax**

**<LogFile>**

---

## **Repair Options**

---

**/f**

This switch repairs the product specified.

**Syntax**

**<Product>**

**Parameters**

The parameter for this switch can be either an .msi file or the relevant product code.

**Modifiers**

- a** - forces the reinstallation of all files.
- c** - if a file is missing or checksum does not match the calculated value.
- d** - if a file is missing or a different version is installed.
- e** - if a file is missing or an equal or older version is installed.
- m** - all required computer-specific registry entries. This is a default setting.
- o** - if a file is missing or an older version is installed. This is a default setting.
- p** - only if a file is missing.
- s** - all existing shortcuts. This is a default setting.
- u** - all required user-specific registry entries. This is a default setting.
- v** - runs from source and re-caches the local package.

Additional options and more detailed explanations are available at the Microsoft website.

---

**Standard Properties**

---

**ADDLOCAL**

The value of the **ADDLOCAL** property is a list of features, delimited with commas, that install locally. If it is not used then all available options will be installed. If it is used then all required features must be specified.

## Syntax

**ADDLOCAL**= <list of features>

## Features

- **F\_Viewer** - **PDF-XChange Editor** and its components;
- **F\_Plugins** - the plugins module for **PDF-XChange Editor**. (This requires **F\_Viewer**).
- **F\_Plugin\_SP** - the SpellChecker plugin. (This requires **F\_Plugins**).
- **F\_FileOpenPlugin** - the plugin that provides support for files secured using "FileOpen". (This requires **F\_Plugins**).
- **F\_ReadOutLoudPlugin** - the plugin that provides read-out-loud functionality. (This requires **F\_Plugins**).
- **F\_OCRPlugin** - the plugin that allows OCR-image-based PDF files in the software. (This requires **F\_Plugins**).
- **F\_OptimizerPlugin** - the plugin optimizes PDF files to reduce their size. (This requires **F\_Plugins**).
- **F\_BookmarksPlugin** - the plugin that adds advanced features for editing bookmarks. (This requires **F\_Plugins**).
- **F\_PDFAPPlugin** - the plugin that converts PDF files into PDF/A format. (This requires **F\_Plugins**).
- **F\_SPPlugin** - the plugin that allows the software to work with files located on Sharepoint™/Office 365™ servers. (This requires **F\_Plugins**).
- **F\_GDPlugin** - the plugin that allows the software to work with files located on Google Drive™ cloud storage. (This requires **F\_Plugins**).
- **F\_OFCPlugin** - the plugin that allows the conversion of documents into MS Office formats directly within the software. (This requires **F\_Plugins**).
- **F\_DBPlugin** - the plugin that enables the software to work in conjunction with files located on the Dropbox™ cloud. (This requires **F\_Plugins**).
- **F\_EOCRPlugin** - facilitates the use of the **Enhanced OCR** plugin. (This requires **F\_Plugins**).
- **F\_MDPlugin** - the plugin that enables the conversion of Markdown files into PDF documents. (This requires **F\_Plugins**).
- **F\_ODPlugin** - the plugin that enables working with files located on **Microsoft OneDrive**. (This requires **F\_Plugins**).
- **F\_BoxPlugin** - the plugin that enables working with files located on **Box.com**. (This requires **F\_Plugins**).
- **F\_3DPlugin** - the plugin that enables the viewing of embedded 3D content in PDF documents. (This requires **F\_Plugins**).

- **F\_ColorPlugin** - the plugin that enables the conversion of colors in PDF documents. (This requires **F\_Plugins**).
- **F\_CSVPlugin** - the plugin that enables the conversion of .csv files to tables in PDF documents. (This requires **F\_Plugins**).
- **F\_BrowserPlugins** - the plug-ins for web browsers (Internet Explorer, FireFox, Opera, Safari, and Chrome) that allow the viewing of PDF files inside these browsers. (This requires **F\_Viewer**, as well as **F\_IEPlugin** and/or **F\_NPPlugin**).
- **F\_NPPlugin** - the Firefox, Chrome, Safari and Opera plugin. (This requires **F\_BrowserPlugins** and **F\_Viewer**).
- **F\_IEPlugin** - the IE plugin. (This requires **F\_BrowserPlugins** and **F\_Viewer**).
- **F\_SanitizePlugin** - the plugin that enables the sanitization of documents. (This requires **F\_Plugins**).
- **F\_VLangs** - the language localization files for the software. (This requires **F\_Viewer**).
- **F\_Tools - PDF-Tools** and its components.
- **F\_Tools\_Plugins** - to install the collection of plugins that extend the functionality of **PDF-Tools**. (This requires **F\_Tools**).
- **F\_TLangs** - additional language files for localization in **PDF-Tools**. (This requires **F\_Tools**).
- **F\_Lite** - the **PDF-XChange Lite V8** print driver and its related components.
- **F\_Langs\_Lite** - the files that allow the localization of languages in the **PDF-XChange Lite V8** print driver and its components.
- **F\_ShellExt** - the Windows Explorer and Windows shell extensions. This has multiple features, including the viewing of thumbnails, properties, previews and the inclusion of the **IFilter** component.
- **F\_Updater** - the updater for **PDF-XChange** products. The updater checks automatically for updates to the software.
- **F\_KeyInstaller** - the key installer for **PDF-XChange** applications.

A comprehensive list of properties defined by the **Windows** installer is available [here](#).

---

## Product Specific Properties

---

### INSTALLLOCATION

This property specifies the installation folder.

#### Syntax

**INSTALLLOCATION**= <installation folder>

---

**SET\_AS\_DEFAULT**

If this property is unspecified, or specified with value of "1", then **PDF-XChange Editor** will be set as the default application for PDF files.

**Syntax**

**SET\_AS\_DEFAULT="0"**

---

**PNAME**

This property specifies the printer name. The default value is "PDF-XChange Lite."

**Syntax**

**PNAME= <printer name>**

---

**SET\_LITE\_AS\_DEFAULT**

If this property is unspecified, or specified with a value of "1", then the **PDF-XChange Lite V8** printer will be set as the default system printer.

**Syntax**

**SET\_LITE\_AS\_DEFAULT="0"**

---

**VIEW\_IN\_BROWSERS**

If this property is unspecified, or specified with a value of "1", then **PDF-XChange Editor** will be configured to open PDF files inside browsers.

**Syntax**

**VIEW\_IN\_BROWSERS = "0"**

---

**DESKTOP\_SHORTCUTS**

If this property is unspecified, or specified with a value of "1", then the installer will place shortcuts for installed applications on the desktop.

### Syntax

**DESKTOP\_SHORTCUTS="0"**

---

### PROGRAMSMENU\_SHORTCUTS

If this property is unspecified, or specified with a value of "1", then the installer will create a program menu group for installed applications and their components.

### Syntax

**PROGRAMSMENU\_SHORTCUTS="0"**

---

### USERNAME

This property specifies the username to which applications will be registered.

### Syntax

**USERNAME= <username>**

---

### ORGANIZATION

This property specifies the organization name to which applications will be registered.

### Syntax

**ORGANIZATION= <organization name>**

---

### USERMAIL

This property specifies the user email.

**Syntax****USERMAIL= <user email>**

---

**KEYFILE**

This property specifies the UNC location of the license vault file <filename>.xcvault.

**Syntax****KEYFILE= <path to xcvault file>**

---

**KEYDATA**

This property specifies the registration key.

**Syntax****KEYDATA= <registration key>**

---

**APP\_LANG**

This property specifies a language for **PDF-Tools**, **PDF-XChange Editor** and the **PDF-XChange Lite** printer. (This requires **F\_TLangs** in order to operate for **PDF-Tools**, **F\_Vlangs** in order to operate for **PDF-XChange Editor** and **F\_Langs\_Lite** to operate for **PDF-XChange Lite**). This property uses the "language culture name" to define languages. For example German is "de-DE". The <id> for target languages is available [here](#). The parameters "**Auto**", "**Builtin**" and "**None**" can also be used instead of a language culture name. **Auto** uses the system locale language, **Builtin** uses US English and **None** retains the existing language in cases where the software is being upgraded, or operates in the same manner as **Auto** if the software is being installed for the first time.

**Syntax****APP\_LANG= <id>**

---

**NOUPDATER**

If this property is unspecified, or specified with a value of "0", then the updater will be installed. If specified with a value of "1" then the updater will not be installed. (Available from build 310).

### Syntax

**NOUPDATER= <0>**

---

### SCHEDULEUPDATER

If this property is unspecified, or specified with a value of "1", then the installer will add a task to the task scheduler to check for software updates.

### Syntax

**SCHEDULEUPDATER= <0>**

---

## MSI Installer Examples

---

- Install the software in quiet mode, with a basic UI, to the folder "C:\Program Files\My PDF Applications":

```
msiexec /i ToolsV8.x86.msi /qb INSTALLLOCATION="C:\Program Files\My PDF Applications"
```

- Install the software in quiet mode, with a basic UI, to the default folder and specify the user license information:

```
msiexec /i ToolsV8.x86.msi /qb USERNAME="Dave" USERMAIL="abc@a.b.c" KEYFILE="\UNC\path\to\xcvaultfile"
```

- Install the software with all features, German as the UI language, in quiet mode and with a basic UI (Please note that **ADDLOCAL** is not being used, therefore all components, including **F\_VLangs**, are installed:

```
msiexec /i ToolsV8.x86.msi /qb APP_LANG=de-DE
```

- Install the software in quiet mode, with a basic UI, with specific features only. Editor, Spellcheck and OCR plugins are included. **FileOpen** and **ReadAloud** plugins are not included. The browser



plugin for IE only is included. German is defined as the UI language. A 'basic' UI is defined. **ADDLOCAL** is used, therefore only the features specified will be installed and **F\_VLangs** must be specified separately:

```
msiexec/i ToolsV8.x86.msi /qb  
ADDLOCAL="F_Viewer,F_Plugins,F_Plugin_SP,F_OCRPlugin,F_VLangs,F_BrowserPlug  
ins,F_IEPlugin" APP_LANG=de-DE
```

---

## 2.3 Switches for EXE Installers

---



### Switches for EXE Installers

---

The EXE installers support both 32 and 64 bit versions of MS Windows. However, the Microsoft MSIN is not always compatible with a unified 32/64 bit installation. If there is any uncertainty about the details of the system onto which **PDF-Tools** is being installed, we recommend using the EXE installer. This is because it has the ability to identify the target computer's system architecture and install 32 or 64 bit binaries accordingly.

The command line for installation is: **PDFXTools8.exe/Option [Optional Parameter] [PROPERTY=PropertyValue]**

The most useful EXE installation switches for **PDF-Tools** are detailed below. Please note that parameters are case sensitive. All available options are detailed [here](#).

---

### Install Options

---

#### **/install**

This switch installs or configures the product specified. It is the default setting.

#### **Syntax**

**<Product>**

---

#### **/uninstall**

This switch uninstalls the product specified.

#### **Syntax**

**<Product>**

---

**/layout**

This switch creates a complete local copy of the bundle in the directory.

---

### **Display Options**

(Please note that the default settings display the UI and all prompts during installation).

---

**/quiet**

This switch determines that neither a UI nor prompts are displayed during installation.

---

**/passive**

This switch determines that a minimal UI and no prompts are displayed during installation.

---

### **Restart Options**

---

**/norestart**

This switch suppresses any attempts to restart the computer on which the installation is taking place. The default setting is for the UI to prompt before restarts take place.

---

### **Logging Options**

---

**/log**

This switch logs to a specific file. The default setting is for a log file to be created in %TEMP%. This is also the case if the path is not specified.

### Syntax

<LogFile>

---

## Repair Options

---

### /repair

This switch repairs existing installations of the product.

---

## Product Specific Properties

---

### USERNAME

This property specifies the username for which applications are registered.

### Syntax

**USERNAME= <username>**

---

### ORGANIZATION

This property specifies the organization name for which applications are registered.

### Syntax

**ORGANIZATION= <organization name>**

---

### USERMAIL

This property specifies the user email.

## Syntax

**USERMAIL= <user email>**

---

## SET\_AS\_DEFAULT

If this property is not specified, or is specified with a value of "1", then **PDF-XChange Editor** will be set as the default application for viewing PDF files.

## Syntax

**SET\_AS\_DEFAULT= "0"**

---

## VIEW\_IN\_BROWSERS

If this property is not specified, or is specified with a value of "1", **PDF-XChange Editor** will be configured to open PDF files within browsers.

## Syntax

**VIEW\_IN\_BROWSERS= "0"**

---

## DESKTOP\_SHORTCUTS

If this property is not specified, or is specified with a value of "1", then the installer will place shortcuts for installed applications on the desktop.

## Syntax

**DESKTOP\_SHORTCUTS= "0"**

---

## PROGRAMSMENU\_SHORTCUTS

If this property is not specified, or is specified with a value of "1", then the installer will create a program menu group for installed applications and their components.

**Syntax**

```
PROGRAMSMENU_SHORTCUTS="0"
```

---

**KEYDATA**

This property specifies a registration key.

**Syntax**

```
KEYDATA= <registration key>
```

---

**KEYFILE**

This property specifies the UNC location of the license vault file <filename>.xcvault

**Syntax**

```
KEYFILE= <path to xcvault file>
```

---

**APP\_LANG**

This property specifies a language for **PDF-Tools**, **PDF-XChange Editor** and the **PDF-XChange Lite** printer. This property uses the "language culture name" to define languages. For example German is "de-DE". The <id> for target languages is available [here](#). The parameters "**Auto**", "**Builtin**" and "**None**" can also be used instead of a language culture name. **Auto** uses the system locale language, **Builtin** uses US English and **None** retains the existing language in cases where the software is being upgraded, or operates in the same manner as **Auto** if the software is being installed for the first time.

**Syntax**

```
APP_LANG= <id>
```

---

**NOUPDATER**

If this property is not specified, or is specified with a value of "0", then the updater will be installed. If specified with a value of "1" then the updater will not be installed. (Available from build 310).

## Syntax

**NOUPDATER="0"**

---

## EXE Installer Examples

---

- Install the application in quiet mode to the default install folder "C:\Program Files\Tracker Software":

```
PDFXTools8.exe /quiet
```

- Install the application in quiet mode to the default folder and specify the user license information and key as a vault file:

```
PDFXTools8.exe /quiet USERNAME="John Doe"  
USERMAIL="JohnDoe@emailaddress.com" KEYFILE="C:\license\V8Pro.xcvault"
```

- Install the application in quiet mode to the default folder and specify the user license information and key as a string:

```
PDFXTools8.exe /quiet USERNAME="John Doe"  
USERMAIL="JohnDoe@emailaddress.com" KEYDATA="PVP60 - ZJ2J77DN5kdBuQRhj ...  
dmGZ7VXrd6TkeJoJCz+1i2UTPSA5AvAU14Q="
```

---

## 2.4 Licensing

---



### Licensing

---

Since version 5.5 and build 308 **PDF-XChange** has moved to a new serial key licensing system. The new system offers both the standard serial key method of licensing our applications as well as the option to use a license file. The license file is known as an "XCVault" file, which is a modified .zip file. The main benefit of this feature is that there is no longer a need to re-install the software if you are using an evaluation version and intend to upgrade. Follow the steps below to access and activate XCVault files:

1. Login to your account with **PDF-XChange**.
2. Move to the "**Your products and Serial numbers**" tab.
3. Move to the desired product and click the arrow icon indicated below, which will expand the window:



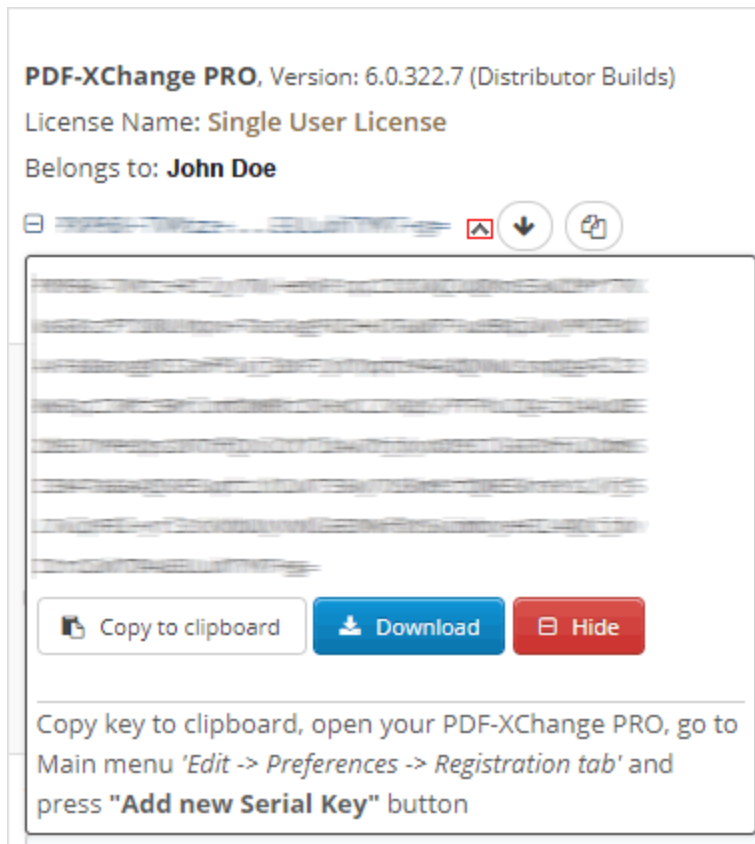

Figure 1. XCVault File Access Point

4. Click the **Download** button. The XCVault file will then download.
5. Click the download icon to launch the XCVault file. All product licenses will then update automatically.

System administrators should note that this information is stored within the Windows Registry. However, the method used to license the application can have an effect on the storage location. When an XCVault file is being used, its information is stored in two locations: **HKCU\Software\Tracker Software\Vault** and **HKLM\SOFTWARE\Tracker Software\Vault**. It should also be noted that license information is stored as a hexadecimal value. Therefore, if a registration key is being used to deploy the license, it is advisable to first license a single machine in order to create the first registration key.

## Standard Deployment

Copy and paste serial keys into the installer to implement them during installation. Alternatively, click the personal.xcvault file after installation has taken place.

## Silent Deployment

XCVault files can also be used for silent deployment of serial keys after installation has taken place. A windows command line can be used to push the XCVault file to each user that qualifies for a full license. The command line for operation is: **XCVault.exe /Option <path\_to\_xcvault\_file>**. Available command line options are detailed below:

---

### XCVault Command Line Options

---

#### **/s**

Installs the software in silent mode.

---

#### **/m**

Per machine - administrative rights are required for this option.

---

#### **/Install**

This command designates the utility as the default handler of **.xcvault** files in the system. Please note that this requires administrative rights.

#### **Example**

```
xcvault.exe /Install
```

---

#### **/AddKeys**

This command installs all license keys from **.xcvault** files.

#### **Syntax**

```
xcvault.exe [/AddKeys] [/M|/S|/R] <xcvault_file>
```

**/M** – specifies that new keys are added in the **HKEY\_LOCAL\_MACHINE** registry section and administrative rights are required.

**/R** – specifies that new keys will be unencrypted when added. Please note that this does not affect existing keys.

**/S** – specifies that the command is not permitted to show error/information messages.

### Examples

```
xcvault.exe /AddKeys "c:\Personal.xcvault"
```

```
xcvault.exe "c:\Personal.xcvault"
```

---

### /OpenKeys

This command removes protection for all installed, protected license keys on the machine and converts them into unencrypted, readable text. Additionally, this command places a permanent flag in the system registry that forces all products from **PDF-XChange** to add new license keys without the standard encryption.

Please note: the software encrypts new keys by default for security reasons. Encrypted keys cannot be exported from the registry and used on other machines. Therefore this command is available only in special cases and may require administrative rights.

### Syntax

```
xcvault.exe /OpenKeys [/M|/S]
```

**/M** – keys stored in **HKEY\_LOCAL\_MACHINE** registry section only will be converted. If this option is not specified then all keys in **HKEY\_CURRENT\_USER** and **HKEY\_LOCAL\_MACHINE** will be converted. If this option is not specified and the utility has no administrative rights then only the keys in **HKEY\_CURRENT\_USER** will be processed.

**/S** – specifies that the command is not permitted to show error/information messages.

### Example

```
xcvault.exe /OpenKeys
```

---

### /ProtectKeys

This command encrypts all installed license keys on the machine. Please note that administrator rights may be required to use this command.

### Syntax

**xcvault.exe /ProtectKeys [/M]/S]**

**/M** – keys stored in **HKEY\_LOCAL\_MACHINE** registry section only will be converted. If this option is not specified then all keys in **HKEY\_CURRENT\_USER** and **HKEY\_LOCAL\_MACHINE** will be converted. If this option is not specified and the utility has no administrative rights then only the keys in **HKEY\_CURRENT\_USER** will be processed.

**/S** – specifies that the command is not permitted to show error/information messages.

### Example

```
xcvault.exe /ProtectKeys
```

---

A sample script and associated literal path is detailed below:

**C:\Program Files\Tracker Software\Vault>XCVault.exe /s** with literal path **D:\Documents\Ref\Personal.xcvault**

Activating silent deployment is a two-step process. The first step is to call on the XCVault.exe that will apply the key. The second step is to specify the literal path to the personal.xcvault file. The presence of the script means that users are not notified of serial key deployment.

---

### Passing License Details During Installation

The inclusion of XCVault files since version 5.5 and build 308 means that the command line install option **KEY= <regkey>** no longer passes license details to associated products. The command line can be used to resolve this issue and there are two methods available:

The first method is to use the option **KEYFILE= <xcvault file>** to specify the UNC location of the license vault file <filename>.xcvault. For example:

**KEYFILE= "C:\Users\JohnDoe\Desktop\Personal.xcvault".**

The second method is use the option **KEYDATA= <regkey>** to specify the registration key with a text string. For example:

**KEYDATA="PXP50-Y5EN....cFrBqnyKhv6eOw=".**

The first method is recommended as the new keys are very complex and therefore less suited to being passed as strings at the command line. The details of these switches and examples of their use are available [here](#).<sup>[31]</sup>

---

## 2.5 The PDF-XChange Updater



### The PDF-XChange Updater

The **PDF-XChange Updater** is used to check for and download updates to **PDF-Tools**. Click **Check for Updates** in the **Help** dropdown menu to open the **PDF-XChange Updater**:

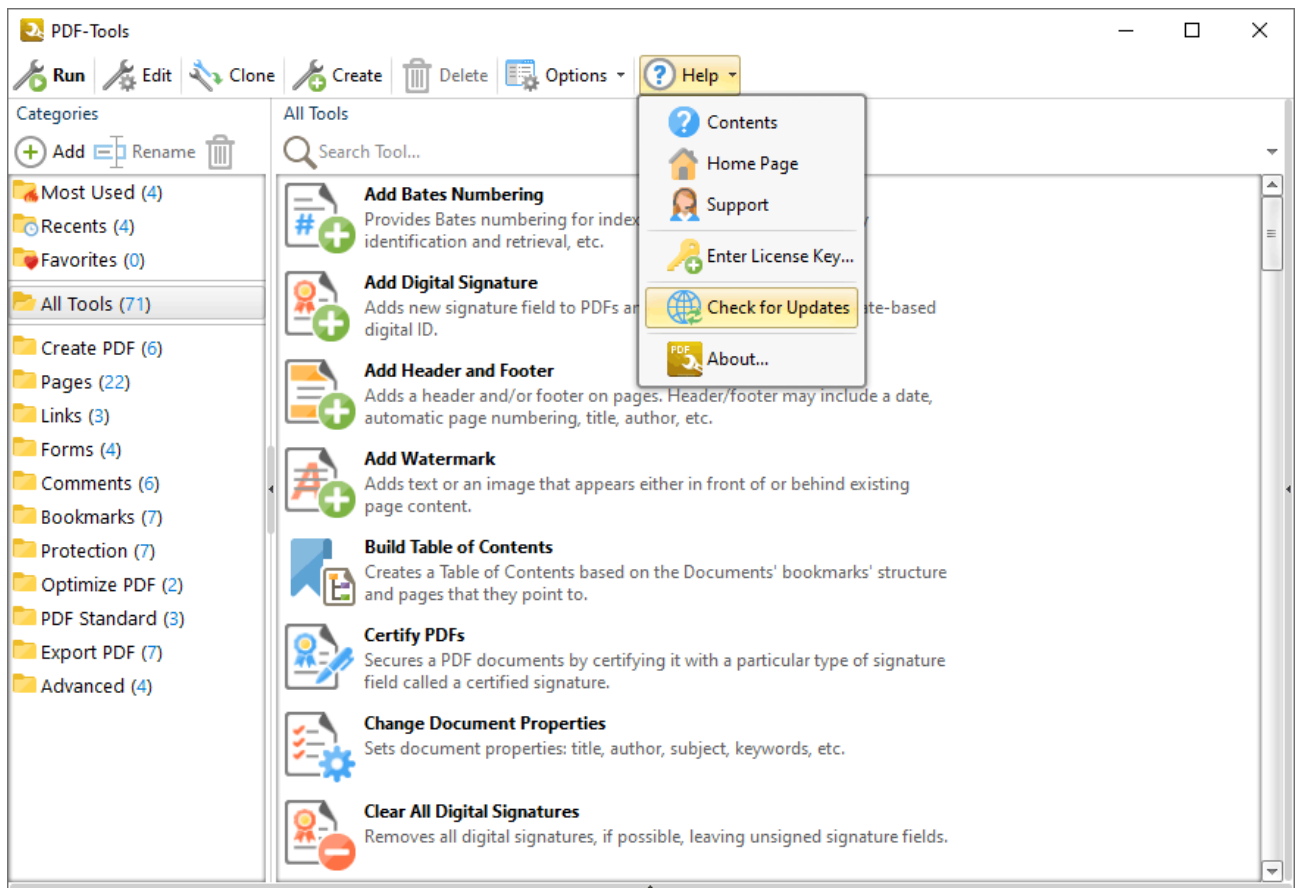

Figure 1. Help Dropdown Menu, Check for Updates

The **PDF-XChange Updater** dialog box will open:

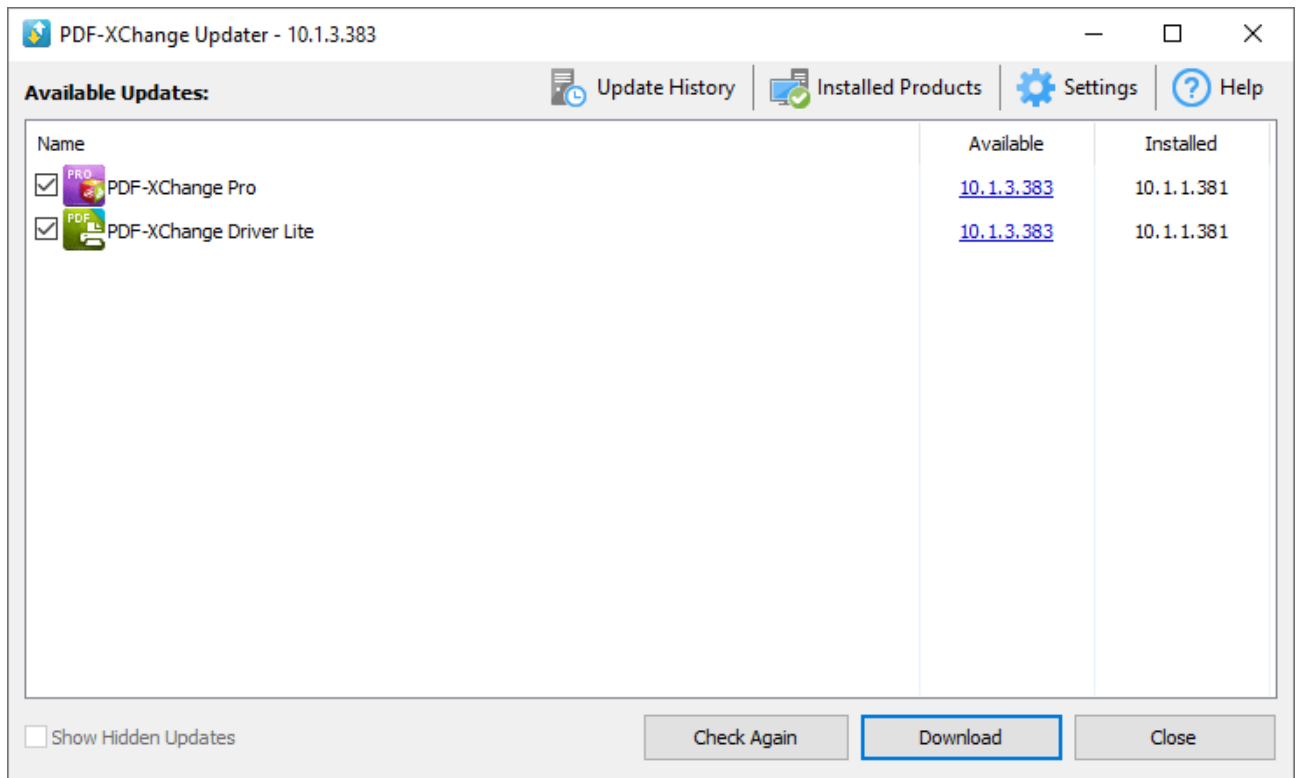

Figure 2. PDF-XChange Updater Dialog Box

- Available updates are displayed in the main window. Click the **Download** button to download and install available updates.
- Click **Update History** to view a breakdown of recent updates.
- Click **Installed Products** to view a breakdown of installed products from **PDF-XChange**.
- Click **Settings** to customize settings for the **PDF-XChange Updater**. These options are detailed beneath (*figure 3*) below.
- Click **Help** to launch the online help for the **PDF-XChange Updater**.
- Select/clear the **Show Hidden Updates** box to show/hide hidden updates.
- Click **Check Again** to check for more recent updates.
- Click **Close** to close the **PDF-XChange Update** dialog box.

## Settings

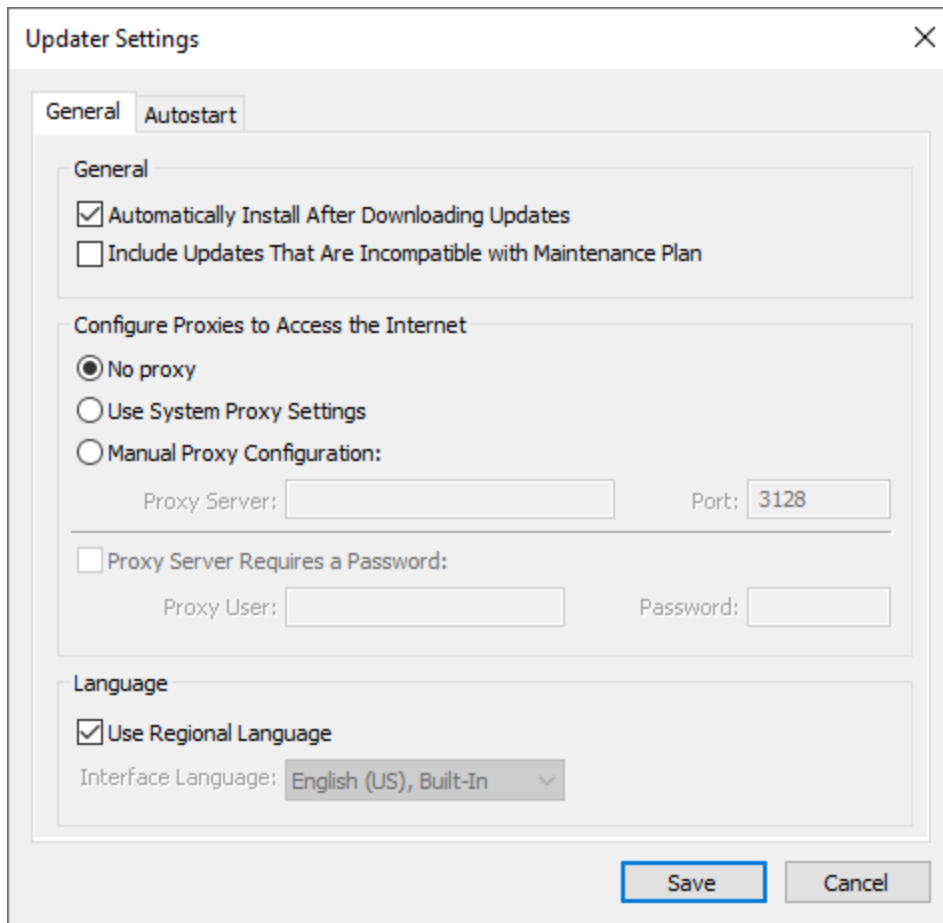

Figure 3. Updater Settings Dialog Box

- Select/clear the **Automatically Install After Downloading Updates** box to enable/disable the automatic installation of downloaded updates.
- Select/clear the **Include Updates That Are Incompatible with Maintenance Plan** box to include/exclude products that are not included in your current maintenance plan. Note that if updates are listed here and your license has expired, then the software will revert to evaluation mode when the updates are downloaded.
- Select an option in the **Configure Proxies to Access the Internet** section to determine the proxy that the updater uses to access the internet:
  - Select **No Proxy** to disable the use of a proxy to access the internet.
  - Select **Use System Proxy Settings** to use the current system proxy settings to access the internet.
  - Select **Manual Proxy Configuration** to use a custom proxy, then enter the **Proxy Server** and **Port** number details in the text boxes.
- Select the **Proxy Server Requires a Password** box to set a password for the use of **Proxy Server** when the **Manual Proxy Server** option above is used, then enter the **Proxy User** and **Password** details in the text boxes.



- Select the **Use Regional Language** box to use the regional language as the interface language for downloaded updates, or select a different option from the dropdown menu. Note that the language of the user interface can be subsequently changed as desired in the user preferences.
- Click **Save** to save settings.

## Autostart

Use the **Autostart** tab to set a schedule for automatically checking for updates to the software:

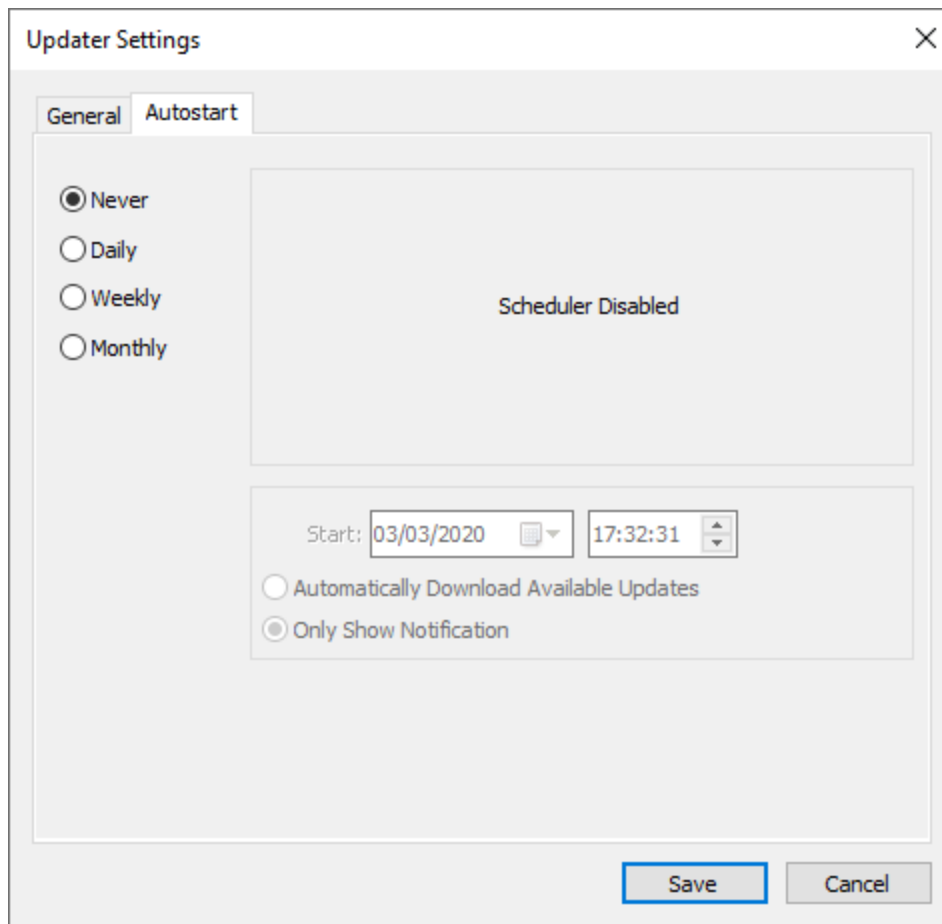

Figure 4. Updater Settings Dialog Box, Autostart Tab

- Select **Never** to disable this feature.
- Select **Daily**, **Weekly** or **Monthly** to check for updates automatically on a daily, weekly or monthly basis as desired. Note that different scheduling options are available depending on which option is used.
- Use the **Start** text box to determine the date and time at which the schedule starts.
- Select **Automatically Download Available Updates** to download available updates automatically, or select **Only Show Notification** to receive a notification that updates are available instead.

Click **Save** to save settings.

---

### 3 Features Overview

---



## Features Overview

---

The main features of **PDF-Tools** are as follows:

- The seventy **Default Tools**, which are used to edit, enhance and manipulate documents. These tools are listed below.
- The [Clone Tool](#)<sup>[71]</sup> feature, which can be used to clone and customize the **Default Tools**.
- The [Create Tool](#)<sup>[65]</sup> feature, which can be used to build new tools. There are seventy-seven actions in the [Actions Library](#)<sup>[76]</sup> that can be combined as desired to create tools.
- The [Folder Monitors](#)<sup>[585]</sup> can be used to set up folder-monitoring and automatically perform tool operations on files that are moved into designated folders.
- The **Import/Export** tool features can be used to import/export customized tool settings and custom tools.
- The **Tool Report** pane can be used to view a breakdown of operations when tools run.

Note that source files to be used in conjunction with tools can be located on the local computer or scanned directly into the application from the scanner. A list of supported file types is available [here](#).<sup>[469]</sup>

### Default Tools





There are seventy default tools in **PDF-Tools**. These tools enable the simple and effective manipulation of PDF/image files. They are grouped into eleven categories:

#### Create PDF Tools

These tools create PDF documents:























[Convert Files to PDFs](#)<sup>[317]</sup> converts input files to PDF.

-  [Create PDF from Images](#)<sup>[319]</sup> converts images to PDF.
-  [Create PDF from Text](#)<sup>[321]</sup> converts text files to PDF.
-  [Extract Pages](#)<sup>[323]</sup> extracts specified page ranges from documents and converts them to a new PDF document.
-  [Scan to PDF](#)<sup>[325]</sup> converts scanned content into PDF documents.
-  [Split/Merge PDFs](#)<sup>[327]</sup> splits documents into separate PDF documents or combines documents into a single PDF document.

## Pages Tools



These tools edit the pages of PDF documents:

-  [Add Bates Numbering](#)<sup>[331]</sup> inserts Bates numbering into documents.
-  [Add Header and Footer](#)<sup>[333]</sup> inserts headers and/or footers.
-  [Add Watermark](#)<sup>[335]</sup> adds text/image watermarks to documents.
-  [Crop Pages](#)<sup>[337]</sup> adjusts the visible page area/margins/editing boxes.
-  [Delete Pages](#)<sup>[339]</sup> deletes document pages.
-  [Duplicate Pages](#)<sup>[341]</sup> duplicates document pages.
-  [Insert Empty Pages](#)<sup>[343]</sup> inserts empty pages into documents.
-  [Insert Pages](#)<sup>[345]</sup> inserts pages from input documents into a specified document.
-  [Merge Pages](#)<sup>[347]</sup> merges pages into a single page.
-  [OCR Pages](#)<sup>[349]</sup> performs optical character recognition on documents.
-  [Overlay PDF](#)<sup>[351]</sup> overlays PDF documents with other documents.
-  [Remove Bates Numbering](#)<sup>[353]</sup> removes Bates numbering from documents.
-  [Remove Headers and Footers](#)<sup>[355]</sup> removes headers and footers from documents.
-  [Remove Pages Background](#)<sup>[357]</sup> resets page backgrounds to their default state.
-  [Remove Watermarks](#)<sup>[359]</sup> removes watermarks from documents.
-  [Replace Pages](#)<sup>[361]</sup> replaces document pages with pages from another document.

-  [Resize Pages](#)<sup>[363]</sup> adjusts the size of pages, and scales page content as desired.
-  [Rotate Pages](#)<sup>[365]</sup> rotates document pages.
-  [Set Page Transitions](#)<sup>[237]</sup> determines how transitions are made between pages in full screen mode.
-  [Set Pages Background](#)<sup>[367]</sup> adds backgrounds to documents.
-  [Split Pages](#)<sup>[371]</sup> splits documents pages.

## Links Tools

These tools are used to create/delete links:

-  [Create Weblinks](#)<sup>[374]</sup> creates weblinks from document text.
-  [Delete Links](#)<sup>[376]</sup> deletes links from documents.
-  [Delete Weblinks](#)<sup>[376]</sup> deletes weblinks from documents.



## Forms Tools



These tools are used to delete, export, import and/or reset form fields:

-  [Delete Form Fields](#)<sup>[381]</sup> deletes form fields from documents.
-  [Export Form Data](#)<sup>[383]</sup> exports form data from documents.
-  [Import Form Data](#)<sup>[385]</sup> imports form data from file.
-  [Reset Forms](#)<sup>[387]</sup> removes all form data from documents.

## Comments Tools







These tools create/delete/manipulate comments in PDF documents:

-  [Delete All Comments](#)<sup>[390]</sup> deletes all comments from documents.
-  [Delete Markup Annotations](#)<sup>[392]</sup> deletes markup annotations from documents.
-  [Export Comments](#)<sup>[394]</sup> exports document comments to file.

-  [Flatten Comments and Fields](#)<sup>[396]</sup> converts comments and forms into base content items.
-  [Import Comments](#)<sup>[398]</sup> imports comments into documents.
-  [Summarize Comments](#)<sup>[400]</sup> creates a summary of document comments.







## Bookmarks Tools

These tools convert, export/import or generate bookmarks in PDF documents:

-  [Build Table of Contents](#)<sup>[403]</sup> uses document bookmarks to create tables of contents.
-  [Export Bookmarks](#)<sup>[405]</sup> exports a copy of document bookmarks.
-  [Export Bookmarks to Text File](#)<sup>[407]</sup> exports a copy of document bookmarks to a text file.
-  [Generate Bookmarks from Page Text](#)<sup>[411]</sup> creates bookmarks from document text.
-  [Find and Replace Bookmark Text](#)<sup>[409]</sup> finds and replaces text in bookmark titles.
-  [Import Bookmarks](#)<sup>[413]</sup> imports bookmarks into documents.
-  [Import Bookmarks from Text File](#)<sup>[415]</sup> imports bookmarks into documents from text files.

## Protection Tools

These tools protect and enhance the security of PDF documents:

-  [Add Digital Signature](#)<sup>[418]</sup> adds digital signatures to documents.
-  [Certify PDFs](#)<sup>[420]</sup> adds certified digital signatures to documents.
-  [Clear All Digital Signatures](#)<sup>[422]</sup> removes digital signatures from documents.
-  [Find and Redact](#)<sup>[424]</sup> searches for specific words or patterns and then either marks them for redaction or redacts them immediately.
-  [Sanitize Document](#)<sup>[426]</sup> removes sensitive information from input documents.
-  [Secure PDF](#)<sup>[428]</sup> adds passwords to documents.
-  [Timestamp PDFs](#)<sup>[430]</sup> adds timestamps to documents.

## Optimize PDF Tools

These tools enhance and optimize PDF documents:



[Enhance Scanned Pages](#)<sup>[433]</sup> enhances the image quality in scanned documents.



[Optimize PDF](#)<sup>[435]</sup> optimizes the content of PDF files in order to reduce their size.

## PDF Standard Tools

These tools add/remove compliance with PDF standards:



[Convert to PDF/A](#)<sup>[440]</sup> makes PDF documents compliant with the PDF/A standard, which is used for long-term archiving.



[Convert to PDF/X](#)<sup>[440]</sup> makes PDF documents compliant with the PDF/X standard, which facilitates graphics exchange.



[Discard Special PDF-Standard](#)<sup>[442]</sup> discards components of documents that comply with PDF standards such as PDF/A, PDF/X and PDF/E.

## Export PDF Tools

These tools export a copy of PDF documents and/or images to alternative formats:



[Export PDF to Audio](#)<sup>[445]</sup> exports a copy text in PDF documents to audio file format.



[Export PDF to Images](#)<sup>[447]</sup> exports a copy of document pages to image format.



[Export PDF to Microsoft Excel Spreadsheet](#)<sup>[449]</sup> exports a copy of document pages to **MS Excel** format.



[Export PDF to Microsoft Powerpoint Presentation](#)<sup>[451]</sup> exports a copy of document pages to **MS PowerPoint** format.



[Export PDF to Microsoft Word Document](#)<sup>[453]</sup> exports a copy of document pages to **MS Word** format. Note that files exported to **(\* .docx)** format are compatible with **MS Word 2010** and later.



[Export PDF to Plain Text](#)<sup>[455]</sup> exports a copy of PDF documents to plain text (\*.txt) format.





[Extract Images from PDF](#)<sup>[457]</sup> extracts a copy of images from PDF documents to a new file.

## Advanced Tools

These tools perform advanced operations:

 [Change Document Properties](#)<sup>[460]</sup> edits document metadata such as the Title, Author, Subject and Keywords.

 [Convert Colors](#)<sup>[462]</sup> converts the colors of input documents.

 [Print Document](#)<sup>[464]</sup> prints input documents.

 [Send E-mail](#)<sup>[466]</sup> sends documents via email.

---



4 User Interface



User Interface

The **PDF-Tools** user interface has two workplaces: the **Main** window and the **Edit** window:

Main Window

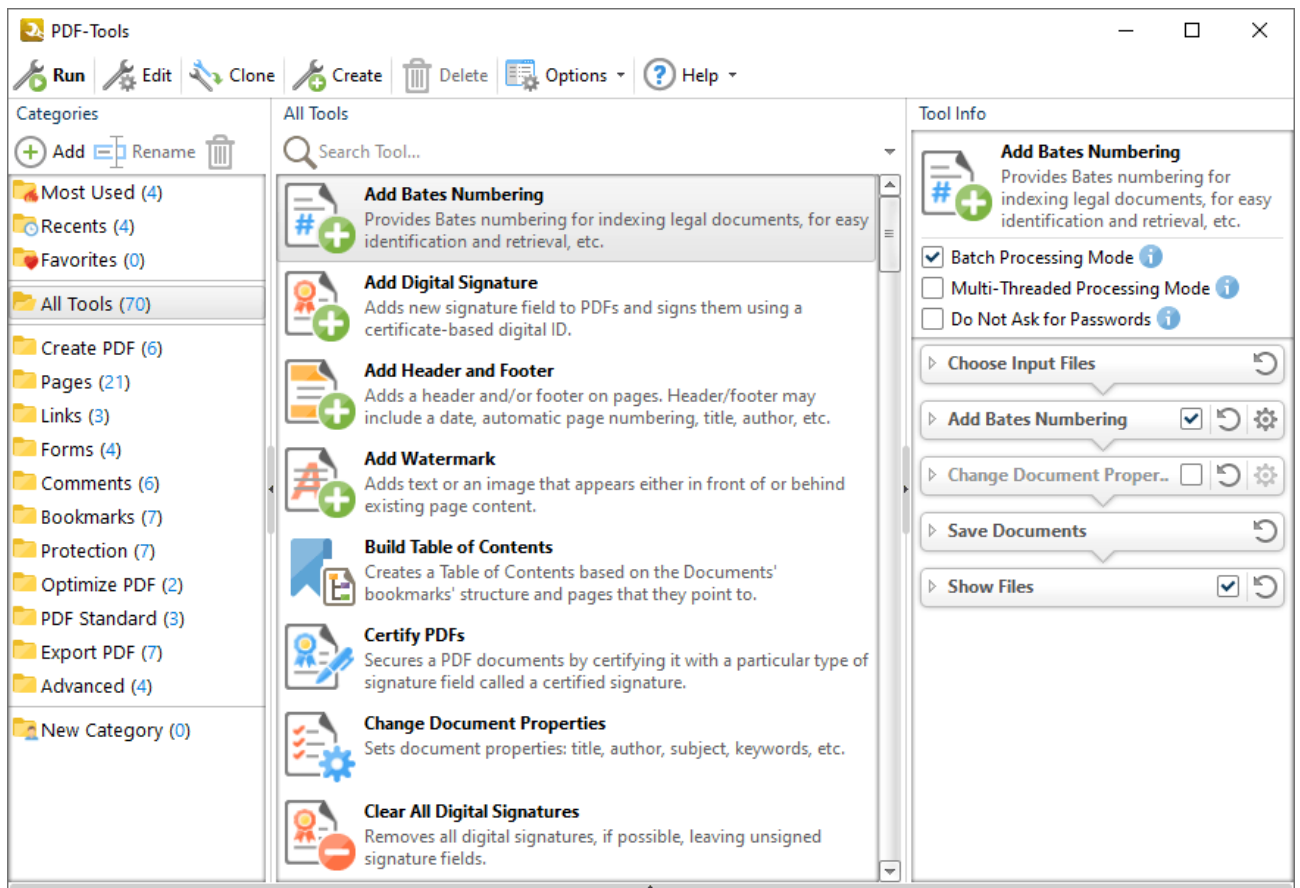











Figure 1. Main Window

The **Main** window is used to view, select, edit, clone and launch tools:

- Click tool **Categories** to view the tools that they contain, which will display in the main window. All tool categories are detailed below.
- The **Tool Info** pane displays the name, description, optional settings and actions of selected tools, and contains the following settings:
  - The **Batch Processing Mode** setting determines the processing method in cases of multiple input files. It is enabled by default, which means files are processed simultaneously. Clear the **Batch Processing Mode** box to process input files one at a time instead. Disabling this option should reduce memory usage, but it may also result in unexpected output for tools that combine input files into single documents.
  - The **Multi-Threaded Processing Mode** setting is disabled by default. Select the box to enable multi-threaded processing, which will use all available CPU cores when tools run. This improves the processing performance but also increases the demand on your computer, which may be detrimental to other processes running at the same time.
  - The **Do Not Ask for Passwords** setting is disabled by default. This means that **PDF-Tools** will prompt for passwords in cases of password-protected input files that do not have corresponding passwords in [Predefined Passwords Storage](#).<sup>[560]</sup> Enable this option to skip these files when tools run.
  - Click the dropdown arrows in the **Tool Info** pane to customize tool action parameters. These parameters are detailed in the [Actions Library](#).<sup>[76]</sup> Click the circular reset arrow to reset tool action parameters to their default values.
  - Select/clear tool action check boxes (where possible) to include/exclude them when the tool runs.
- Click  **Add** to add a custom category to the list of categories. Click and drag tools to add them to custom categories. Note that default tools cannot be moved from their home categories.
- Click  **Rename** or  **Remove** to rename/remove custom categories.
- Use the  **Search Tool** to search for tools.
- Click  **Run** (or double-click) to launch the selected tool.
- Click  **Edit** to edit the selected tool, as detailed in *(figure 6)*.
- Click  **Clone** to create a clone of the selected tool, which enables the full customization of its actions/parameters, as detailed [here](#).<sup>[71]</sup>
- Click  **Create** to create a new tool, as detailed [here](#).<sup>[65]</sup>
- Click  **Delete** to remove the selected tool. Note that this option is available only for custom tools.
- Click  **Options** to view program options:

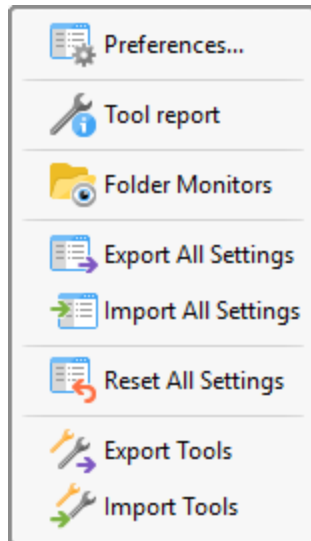



Figure 2. Options Tab

- Click **Preferences** to view/edit the preferences of **PDF-Tools**, as detailed [here](#).<sup>554</sup>
  - Click **Tool Report** to enable/disable the **Tool Report** pane, which details a breakdown of operations when tools run.
  - Click **Folder Monitors** to view/edit folder monitors, which are used to watch user-specified folders and automatically perform tool operations on files moved into them. Folder monitors are detailed [here](#).<sup>585</sup>
  - Click **Export All Settings** to export the current tool settings and custom tools to file. This is a useful feature in cases where several parties require the same settings, such as employees of the same organization.
  - Click **Import All Settings** to import settings that the **Export All Settings** feature has been used to export.
  - Click **Reset All Settings** to reset all settings and remove all custom tools.
  - Click **Export Tools** to export a selection of tools to file.
  - Click **Import Tools** to import tools that the **Export Tools** feature has been used to export.
- 
- Click  **Help** to view help options:

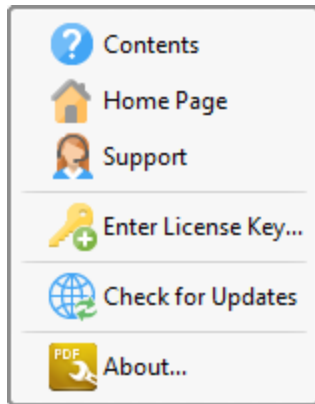

Figure 3. Help Tab

- Click **Contents** to navigate to the online help manual.
- Click **Home Page** to navigate to the **PDF-Tools** page on the **PDF-XChange** website.
- Click **Support** to navigate to the **PDF-XChange** support forums.
- Click **Enter License Key** to view/edit license keys for **PDF-Tools**, as detailed [here](#).<sup>[562]</sup>
- Click **Check for Updates** to launch the **PDF-XChange Updater** and check for updates to all **PDF-XChange** applications installed on the local computer.
- Click **About** to view license/version information, and further details about **PDF-Tools**.

Right-click tools for additional options:

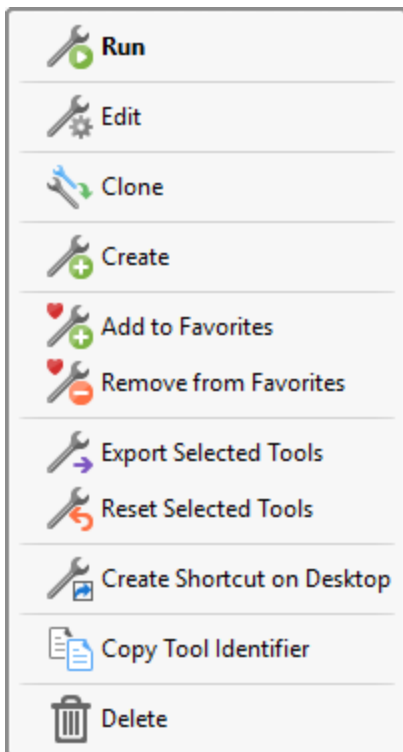

Figure 4. Tool Options Menu

- Click **Run** (or double-click) to launch the selected tool.

- Click **Edit** to edit the selected tool, as detailed in *(figure 6)*.
- Click **Clone** to create a clone of the selected tool, which enables the full customization of its actions/parameters, as detailed [here](#).<sup>[71]</sup>
- Click **Create** to create a new tool, as detailed [here](#).<sup>[65]</sup>
- Click **Add to Favorites** to add tools to the **Favorites** category.
- Click **Remove from Favorites** to remove tools from the **Favorites** category.
- Click **Export Selected Tools** to export tools. The **Save Export File** dialog box will open. Select a name and location for the file. Tools will be saved as a **.pdtex** file. The **Import Tools** option detailed above can be used to import these files.
- Click **Reset Selected Tools** to revert the settings of selected tools to their default values.
- Click **Create Shortcut on Desktop** to create a desktop shortcut for tools. A shortcut icon will appear on the desktop when this feature is used. Double-click icons, or drag and drop files onto them, in order to launch the associated tool.
- Click **Copy Tool Identifier** to copy the unique tool identifier to the clipboard for the selected tool. Tool identifiers are used in conjunction with the **/RunTool** command line in order to run tools from the command prompt.
- Click **Delete** to delete tools. Note that this option is not available for default tools.

## Tool Categories

**PDF-Tools** contains the following default tool categories:

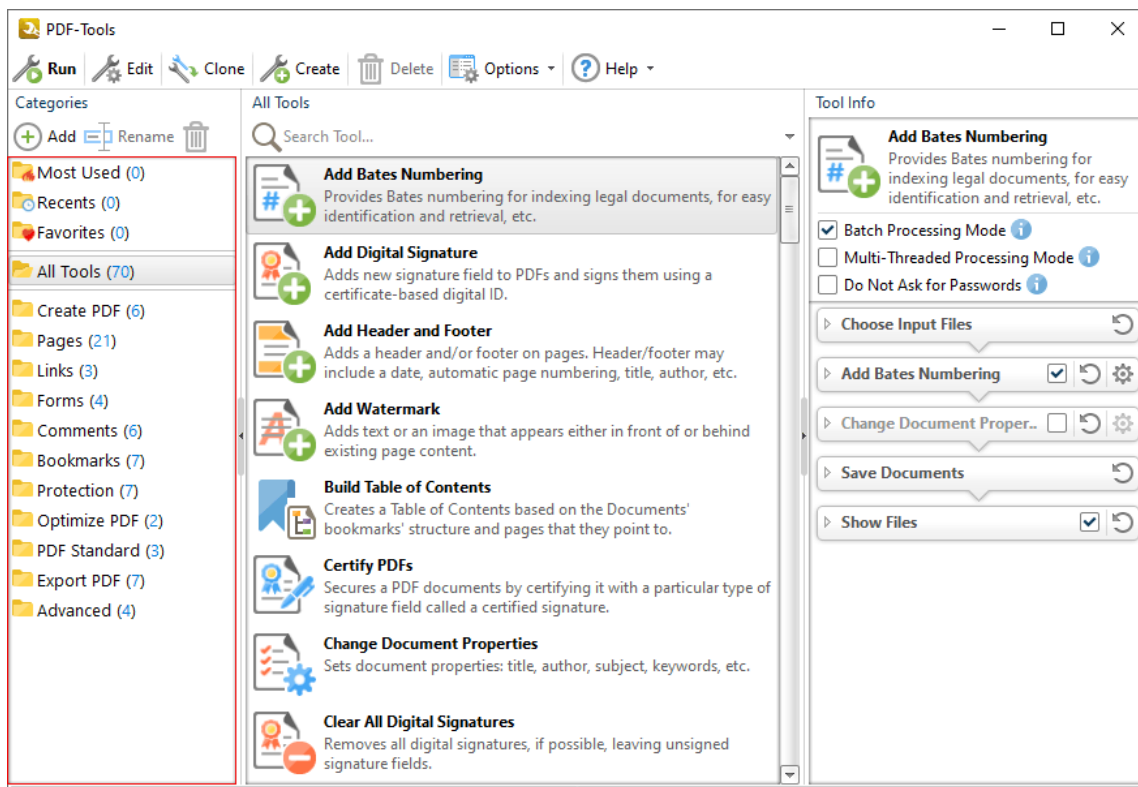

Figure 5. Default Tool Categories

- The **Most Used** category contains the five most-often used tools.
- The **Recents** category contains the ten most recently used tools.
- The **Favorites** category contains the favorite tools of the user. Drag tools to add them to this folder. Alternatively, click the heart in the upper-left of the tool pane to add/remove tools to/from the **Favorites** category.
- **All Tools** contains all seventy default tools, which are detailed [here](#).<sup>[315]</sup>
- **Create PDF** contains the tools used to create PDF files. These tools are detailed [here](#).<sup>[316]</sup>
- **Pages** contains the tools used to edit, update and delete document pages. These tools are detailed [here](#).<sup>[329]</sup>
- **Links** contains the tools used to create/delete links and weblinks. These tools are detailed [here](#).<sup>[373]</sup>
- **Forms** contains the tools used to import/export, delete or reset forms and form data. These tools are detailed [here](#).<sup>[380]</sup>
- **Comments** contains the tools used to manipulate document comments such as weblinks and form fields. These tools are detailed [here](#).<sup>[389]</sup>
- **Bookmarks** contains the tools used to create and manipulate document bookmarks. These tools are detailed [here](#).<sup>[402]</sup>
- **Protection** contains the tools used to protect and secure documents. These tools are detailed [here](#).<sup>[417]</sup>
- **Optimize PDF** contains the tools used to optimize and enhance documents. These tools are detailed [here](#).<sup>[432]</sup>
- **PDF Standard** contains the tools used to add/remove PDF subset compliance to PDF documents, such as the PDF/A and PDF/X formats. These tools are detailed [here](#).<sup>[437]</sup>
- **Export PDF** contains the tools used to export copies of PDF documents to different output formats, such as plain text, image format and **MS Word/Excel/Powerpoint**. (Note that files exported to **(\* .docx)** format are compatible with **MS Word 2010** and later). These tools are detailed [here](#).<sup>[444]</sup>
- **Advanced** contains the tools used to perform more advanced operations, such as changing document properties and emailing documents. These tools are detailed [here](#).<sup>[459]</sup>

## Edit Window

Right-click tools and then click **Edit** to view the **Edit** window for the tool. The **Edit** window is used to view and customize tool functions. For example, the **Edit** window for the [Convert Files to PDFs](#)<sup>[317]</sup> tool is detailed below:

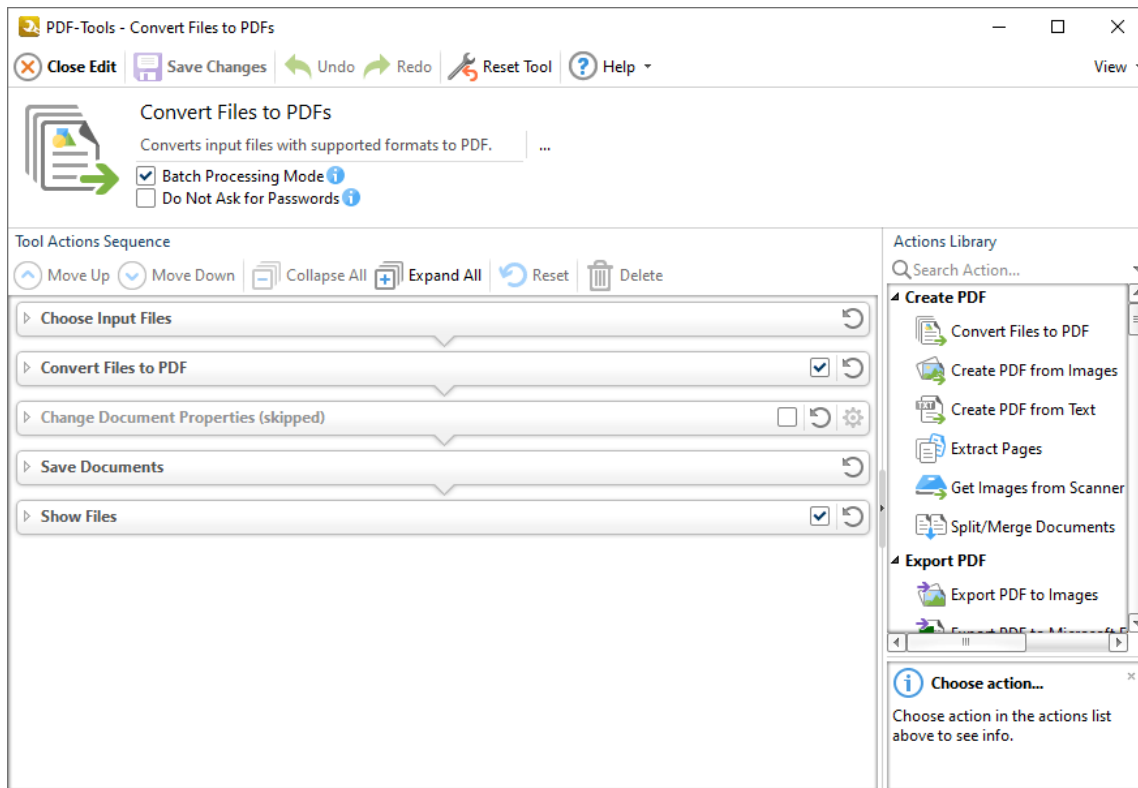













Figure 6. Edit Window, Convert Files to PDFs

The name, icon and description of the selected tool is displayed in the **Edit** window. These parameters can be edited for cloned/custom tools. All tools feature actions that can be adjusted to meet specific requirements. These actions are contained in the **Tool Actions Sequence**. The order of actions in the **Tool Actions Sequence** determines the order of actions when tools run, and can be reordered in cloned/custom tools. Click the arrow icons on the left side of actions to expand their parameters, which can then be customized, as detailed in the the [Actions Library](#).<sup>[76]</sup> Use the icons in the **Edit** window to perform the following operations:

- Click  **Close Edit** to close the editing session.
- Click  **Save Changes** to save changes made to the tool.
- Click  **Undo** to undo the most recent editing action.
- Click  **Redo** to redo the most recent undo action.
- Click  **Reset Tool** to reset all tool settings.
- Click  **Move Up** to move the selected action up in the **Tool Actions Sequence**.
- Click  **Move Down** to move the selected action down in the **Tool Actions Sequence**.
- Click  **Collapse All** to collapse all actions in the **Tool Actions Sequence**.

- Click  **Expand All** to expand all actions in the **Tool Actions Sequence**.
  - Click  **Reset** to reset the selected action options in the **Tool Actions Sequence**.
  - Click  **Delete** to delete selected actions.
  - Select/clear  boxes to include/exclude actions when tools run.
  - Click  **Reset** to reset action options to their default values.
-



## 5 Create Tool



### Create Tool

The **Create Tool** feature of **PDF-Tools** is used to create custom tools. Follow the steps below to create tools:

1. Click **Create** in the main toolbar:

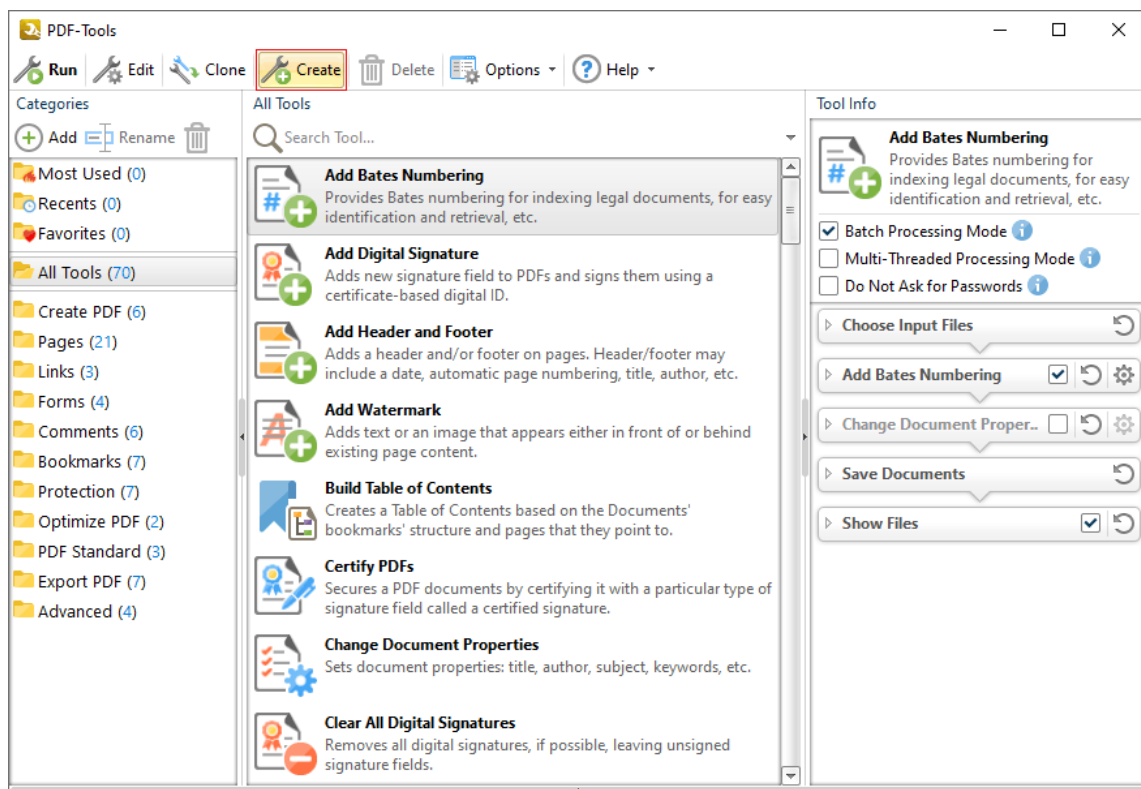

Figure 1. Main Window, Create Tool Option

The **Edit** window will open:

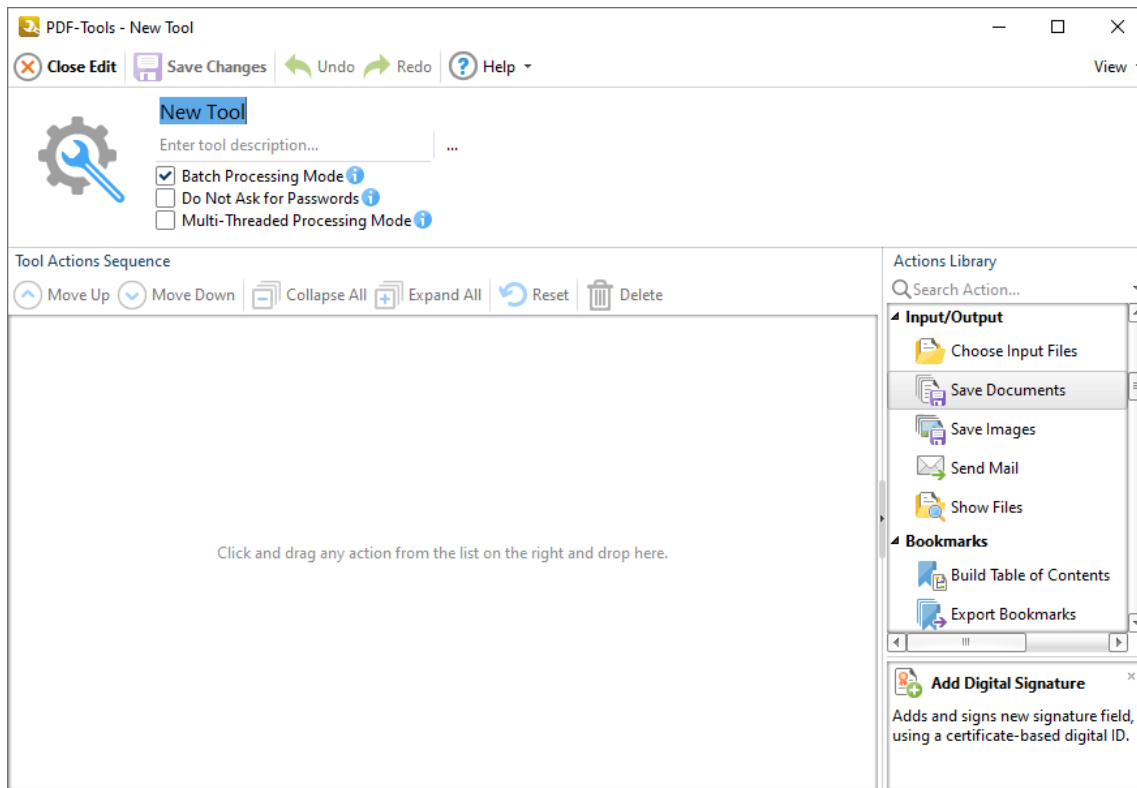

Figure 2. Edit Window, New Tool Creation

2. Enter a name and description for the new tool. Click the  icon to select an icon for tools. (Note that icons must be in the \*.ico format).

3. Build the **Tool Actions Sequence**. The **Tool Actions Sequence** determines the functionality of tools and is composed of actions from the **Actions Library**. Therefore it is necessary to add actions from the **Actions Library** to the **Tool Actions Sequence** in order to create tools. Drag actions from the **Actions Library** (or double-click them) to add them to the **Tool Actions Sequence**. There are seventy-seven available actions. See the [Actions Library](#)<sup>[76]</sup> for an explanation of all actions and their associated parameters. Please note:

- All tools require input files to operate. Therefore it is necessary to start the **Tools Actions Sequence** with either the **Choose Input Files** or the **Get Images from Scanner** action.
- Almost all tools require files to be saved after they are created/converted, and in those cases either the **Save Documents** or the **Save Images** action must be included.
- Note that the order of actions in the **Tools Actions Sequence** determines the order in which actions are performed when tools run. Select actions and then click the **Move Up** or **Move Down** buttons displayed in *(figure 2)* to change their order in the **Tool Actions Sequence**. Several actions require additional actions in order to function correctly. Additional actions may be required before (prerequisite) or after (postrequisite) actions. For example the **Convert Files to PDF** action requires both an action that sources input







files to convert to PDF and an action that saves converted files. If an ordering mistake is made then a warning icon will appear. Click the icon for further information and a solution to the issue.

- The **Batch Processing Mode** setting determines the processing method in cases of multiple input files. It is enabled by default, which means files are processed simultaneously. Clear the **Batch Processing Mode** box to process input files one at a time instead. Disabling this option should reduce memory usage, but it may also result in unexpected output for tools that combine input files into single documents.
- The **Do Not Ask for Passwords** setting is disabled by default. This means that **PDF-Tools** will prompt for passwords in cases of password-protected input files that do not have corresponding passwords in [Predefined Passwords Storage](#).<sup>[560]</sup> Enable this option to skip these files when tools run.
- The **Edit** window (*figure 2*) and the options it contains are detailed [here](#).<sup>[62]</sup>

4. Click  **Save Changes** to save the new tool.

## Example

This example will build a tool that creates a PDF document from text files, changes the document properties, adds a watermark and a digital signature, then saves the document to the local computer. The following actions are required from the **Actions Library** for these operations:

1.  **Choose Input Files**
2.  **Create PDF from Text**
3.  **Change Document Properties**
4.  **Add Watermarks**
5.  **Add Digital Signature**
6.  **Save Documents**

Follow the steps below to create the tool:

1. Click **Create** in the main window:

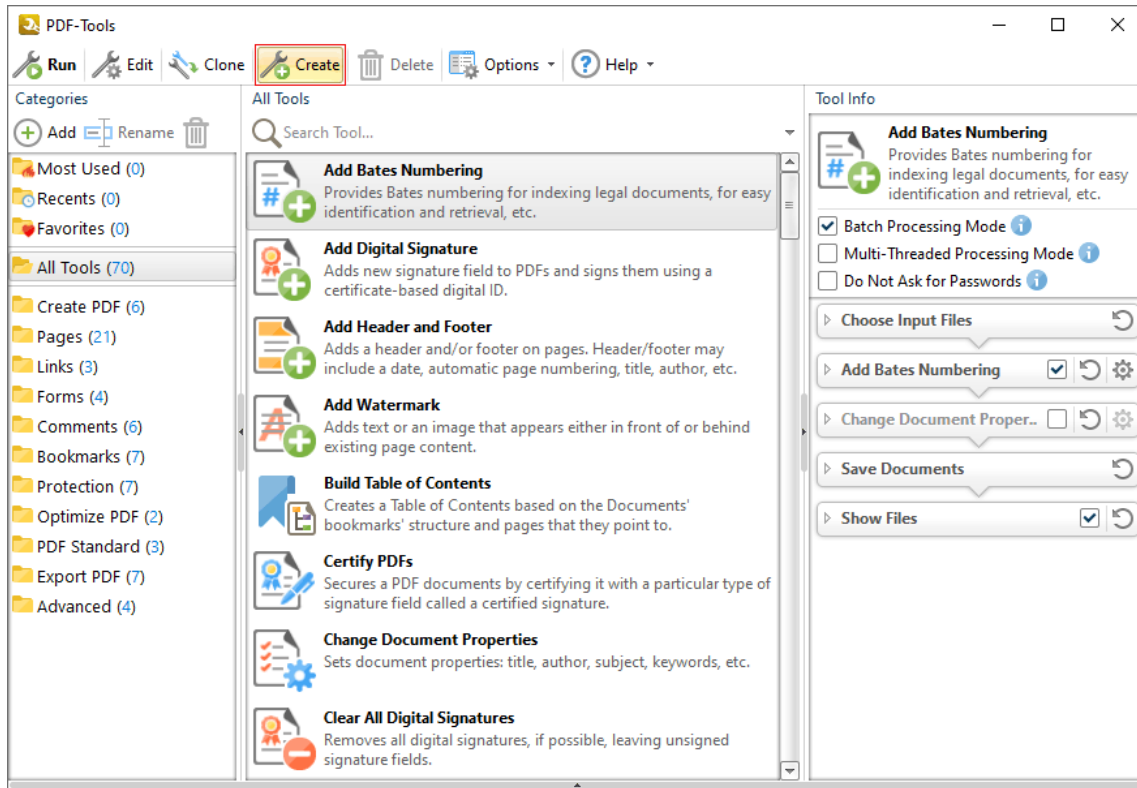

Figure 3. Main Window, Create Tool Option

The **Edit** window for the new tool will open:

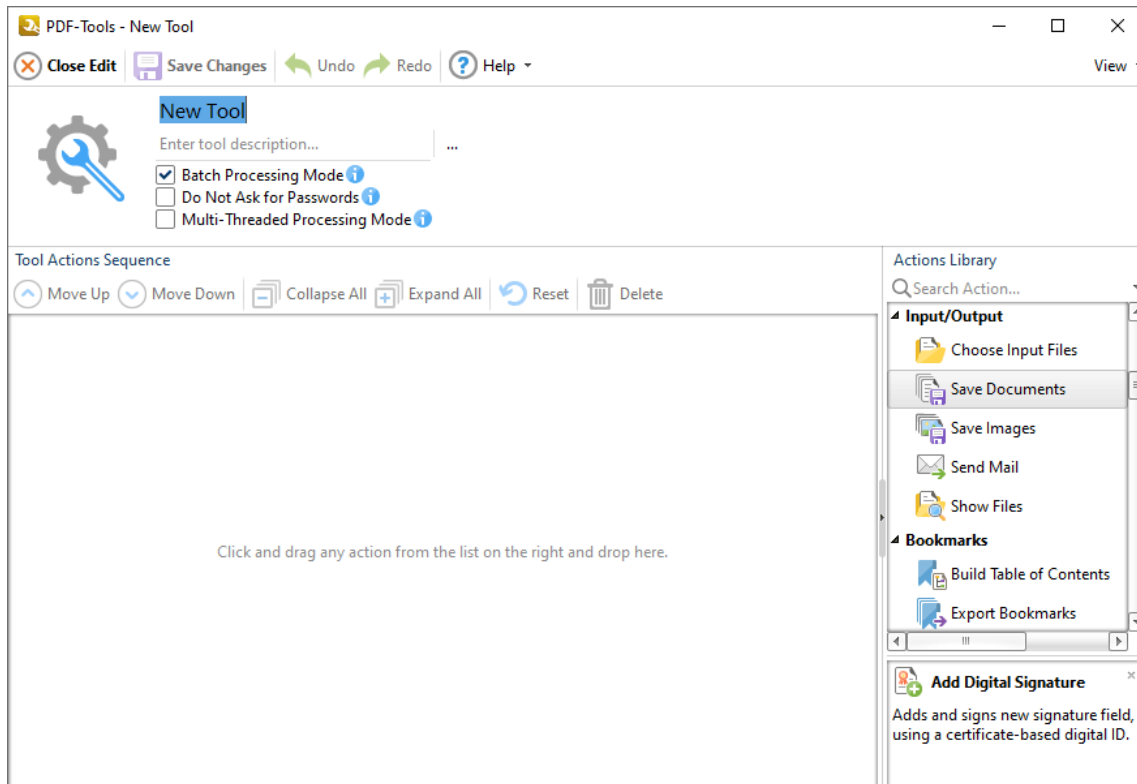

Figure 4. Edit Window, New Tool Creation

2. Enter a name and description for the tool, then drag the necessary actions from the **Actions Library** into the **Tool Actions Sequence**:

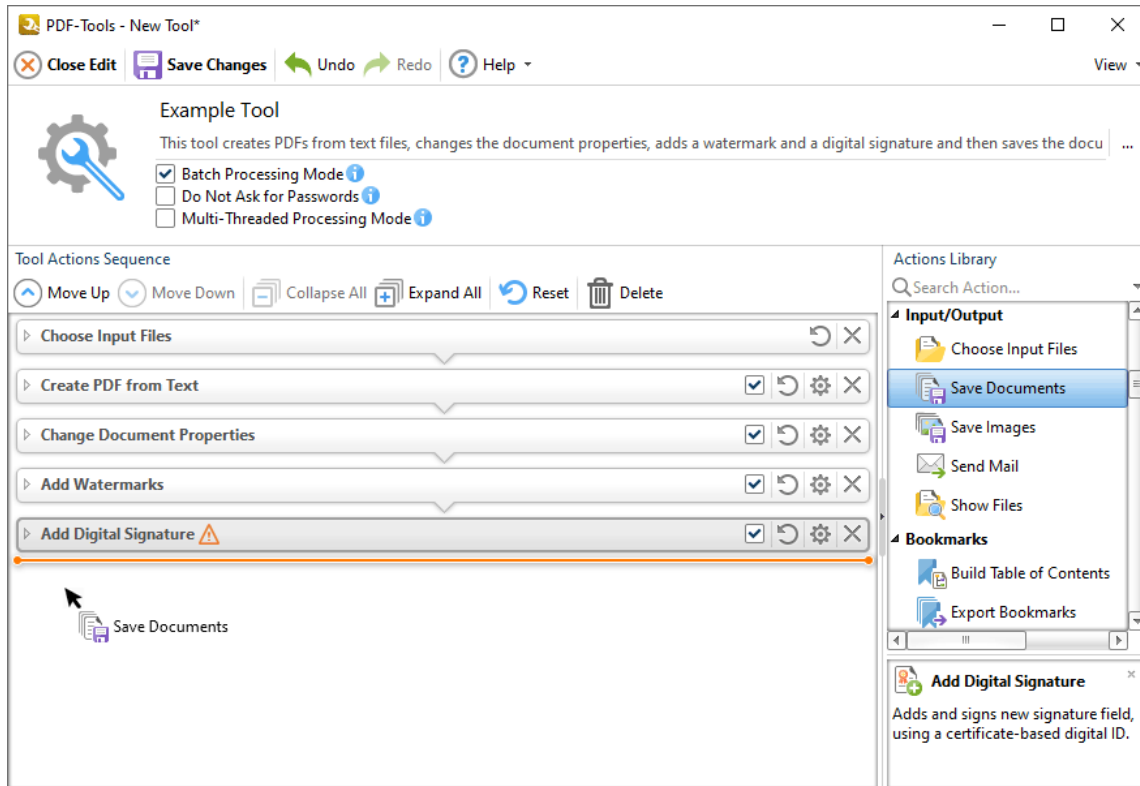



Figure 5. Edit Window, Adding Actions

Note that the the order of actions in the **Tool Actions Sequence** determines the order in which they are performed when the tool runs.

- Click the ▶ icon to expand/collapse actions. Available parameters are displayed when actions are expanded. A complete breakdown of all actions and their parameters is available [here](#).<sup>[76]</sup>
- Click the ↺ icon to revert to default parameters after action parameters have been changed.
- Click the ✕ icon to remove actions from the **Tool Actions Sequence**.
- Actions that feature a check box are optional. A selected box means actions are included in the **Tool Actions Sequence** when the tool runs. A cleared box means that actions are skipped when the tool runs, but are retained in the **Tool Actions Sequence** for subsequent use. (This is a useful feature in cases where actions are required only some of the time).

3. Click  **Save Changes** to save the tool, which will then be available in the **Main Window**:

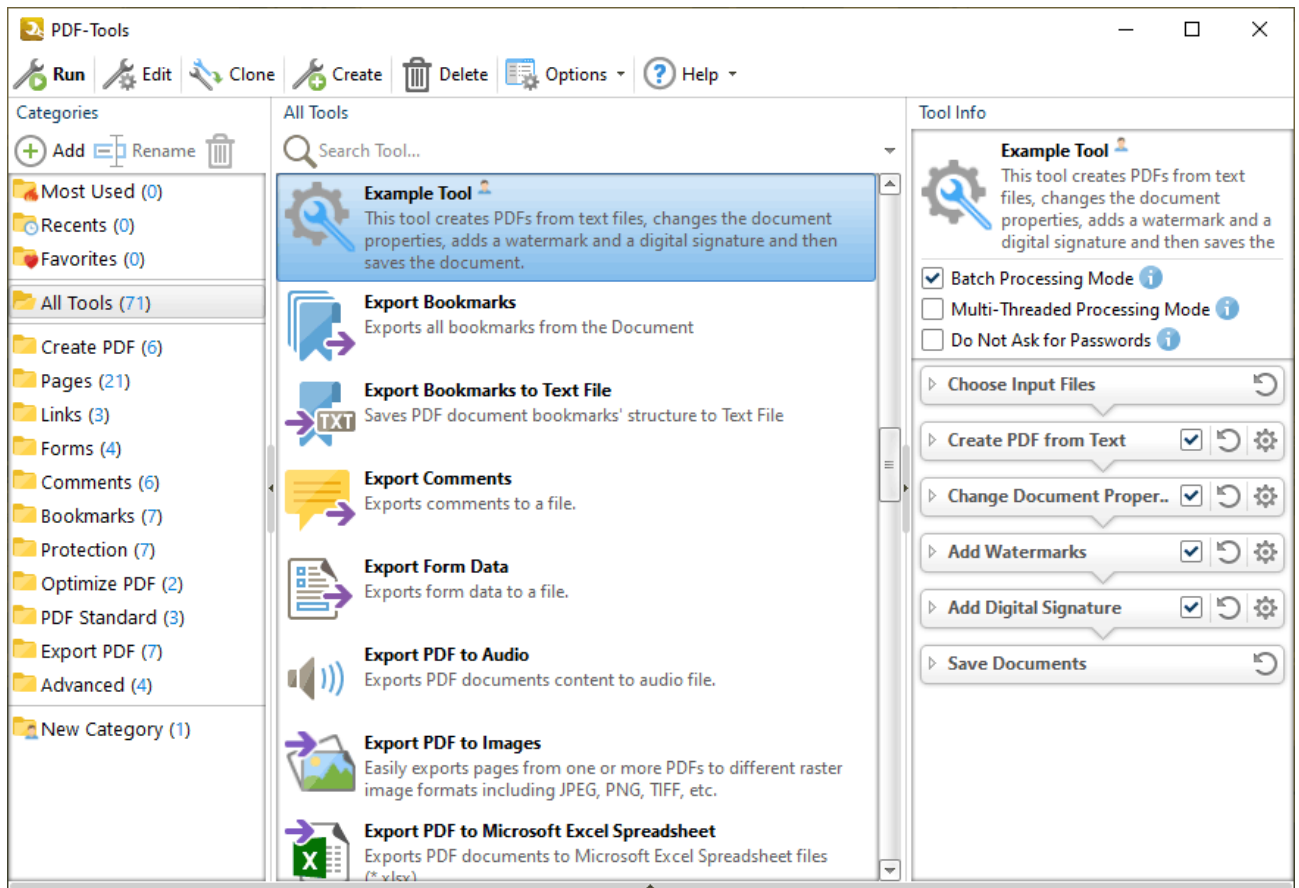

Figure 6. Main Window, New Tool Complete

- Double-click to launch the tool, or right-click for further options, as detailed [here](#).
- Note that new tools are moved into the tool category that was open when the **Create** button was clicked. Drag tools into different categories as desired. Alternatively, click and drag tools onto the desktop to create a shortcut to the tool.

6 Clone Tool



Clone Tool

The **Clone Tool** feature of **PDF-Tools** is used to clone tools. This makes it possible to duplicate tools and then customize their settings whilst retaining the existing tool and its parameters. This is especially useful in the case of the default tools, as many of their parameters are locked by default. Cloning the default tools makes it possible to add/remove actions to/from the **Tool Actions Sequence** as desired, and thus enables the advanced customization of tools. For example, the [Create PDF from Text](#)<sup>[321]</sup> tool is used to convert text files into PDF format, and it uses five actions from the [Actions Library](#)<sup>[76]</sup> to achieve this:

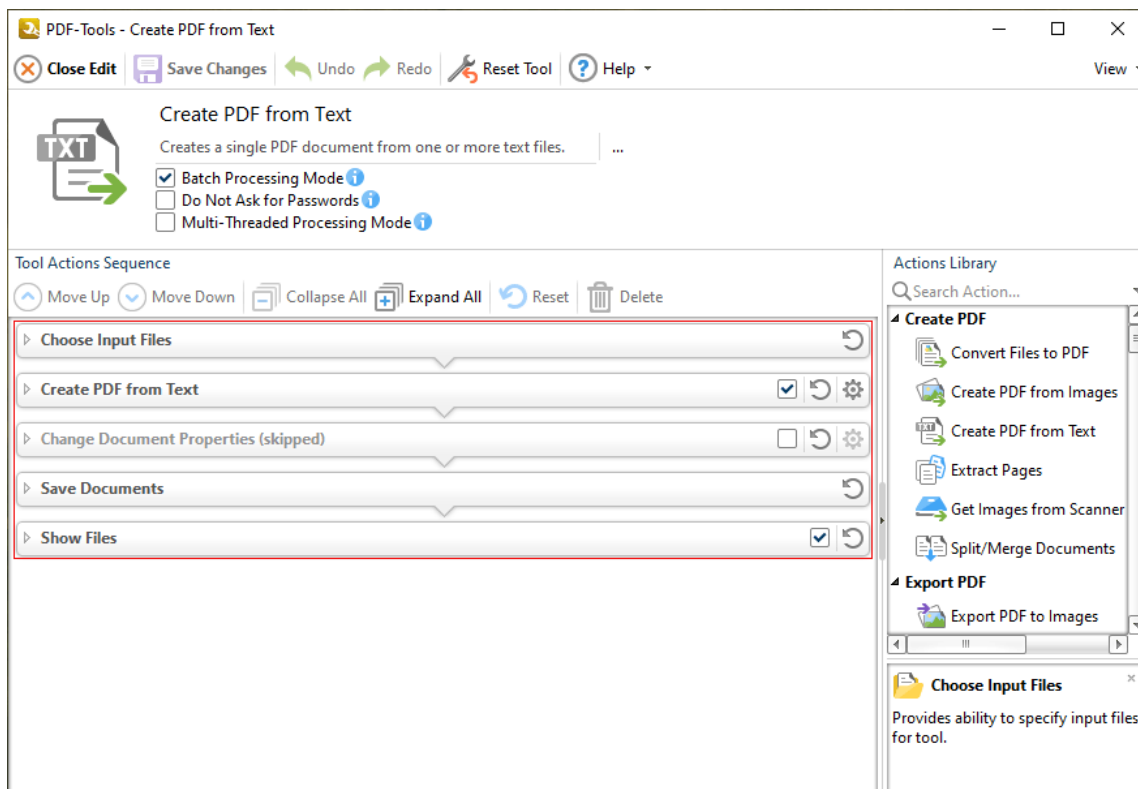

Figure 1. Create PDF from Text, Tool Actions Sequence

When the tool is launched it will prompt the user for input text files, convert them into PDF format, change document properties, save the files according to the user specifications and

display them in their desktop folder. If this tool is cloned then further options become possible. For example, the **Show Files** action could be removed and the **Add Watermarks** and **Add Digital Signature** actions could be added. The **Tool Actions Sequence** would then appear as follows:

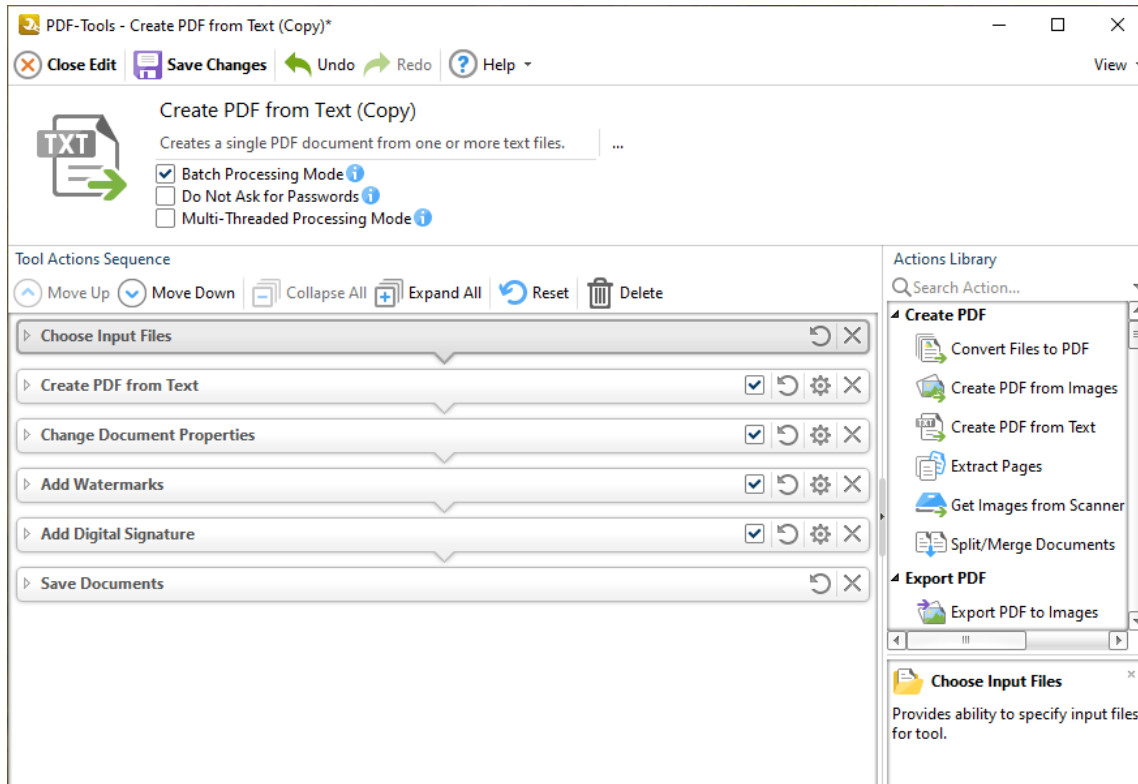

Figure 2. Create PDF from Text Tool Clone, Updated Tool Actions Sequence

The tool would then prompt the user for input text files, convert them into PDF format, change document properties, add a customized watermark and digital signature, and save them according to the user's specifications (but not display them in their containing folder on the desktop, as the **Show Files** action has been removed).

## Cloning and Editing Tools

Follow the steps below to clone tools:

1. Right-click the desired tool and click **Clone** in the submenu:



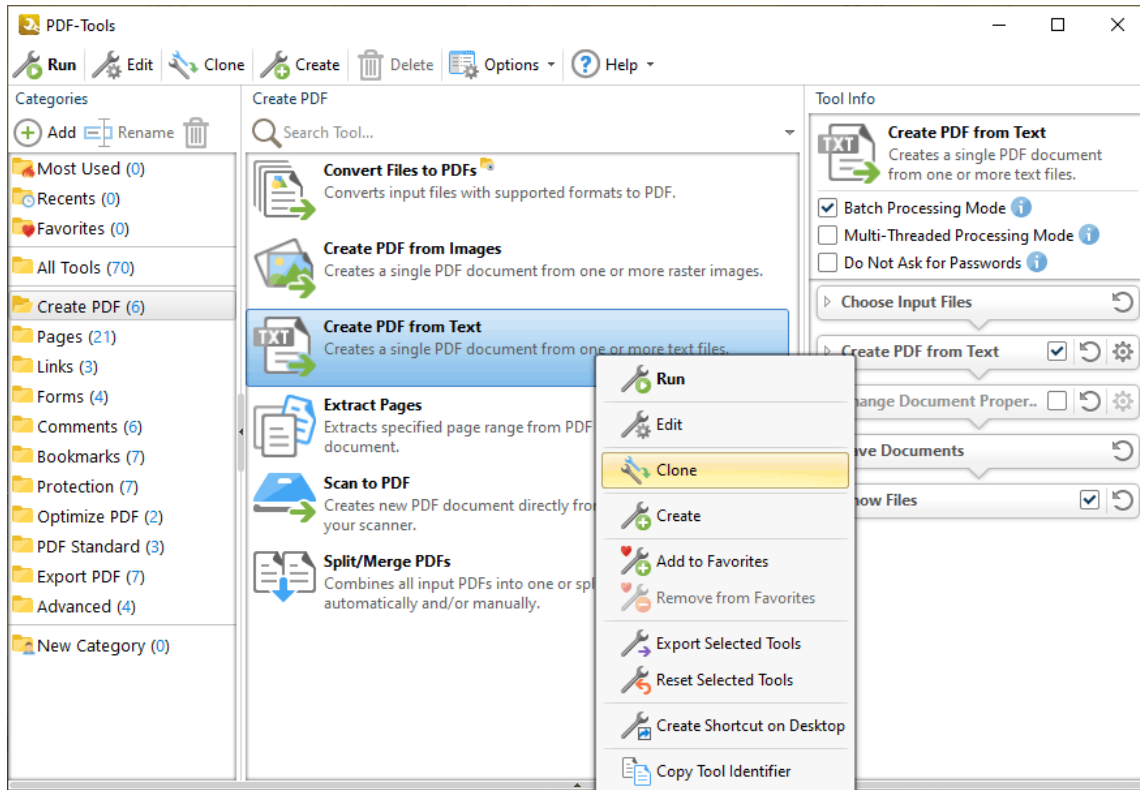

Figure 3. Right-Click Content Menu for Tool, Clone Option

The **PDF-Tools** dialog box will open:

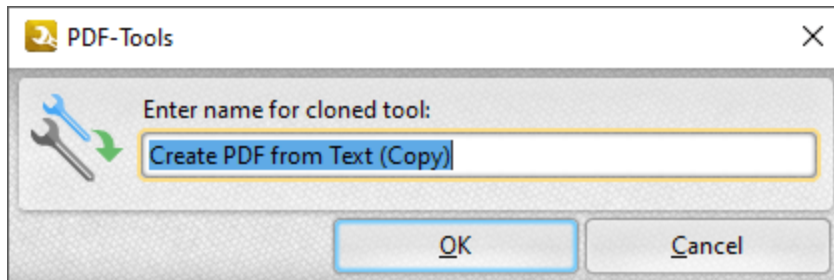

Figure 4. PDF-Tools Dialog Box, Tool Name Text Box

2. Enter a name for the cloned tool and click **OK**. It will then be available in the main window. Right-click the cloned tool and then click **Edit**:

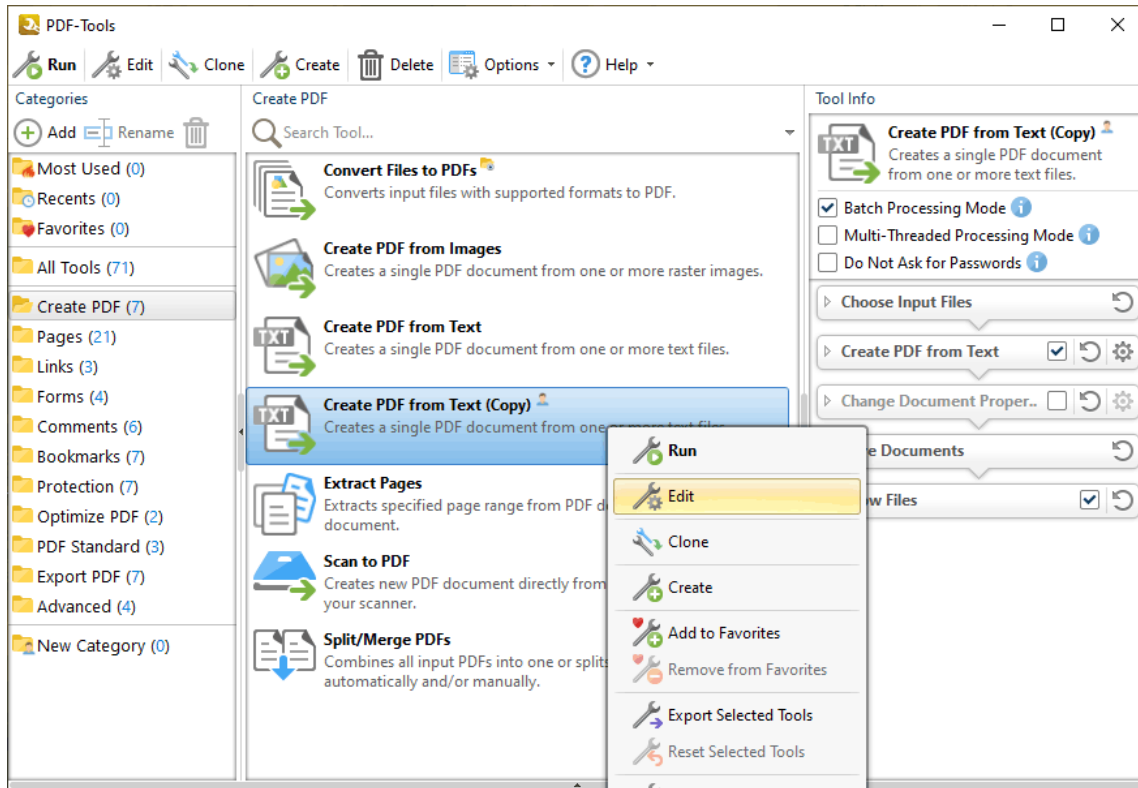
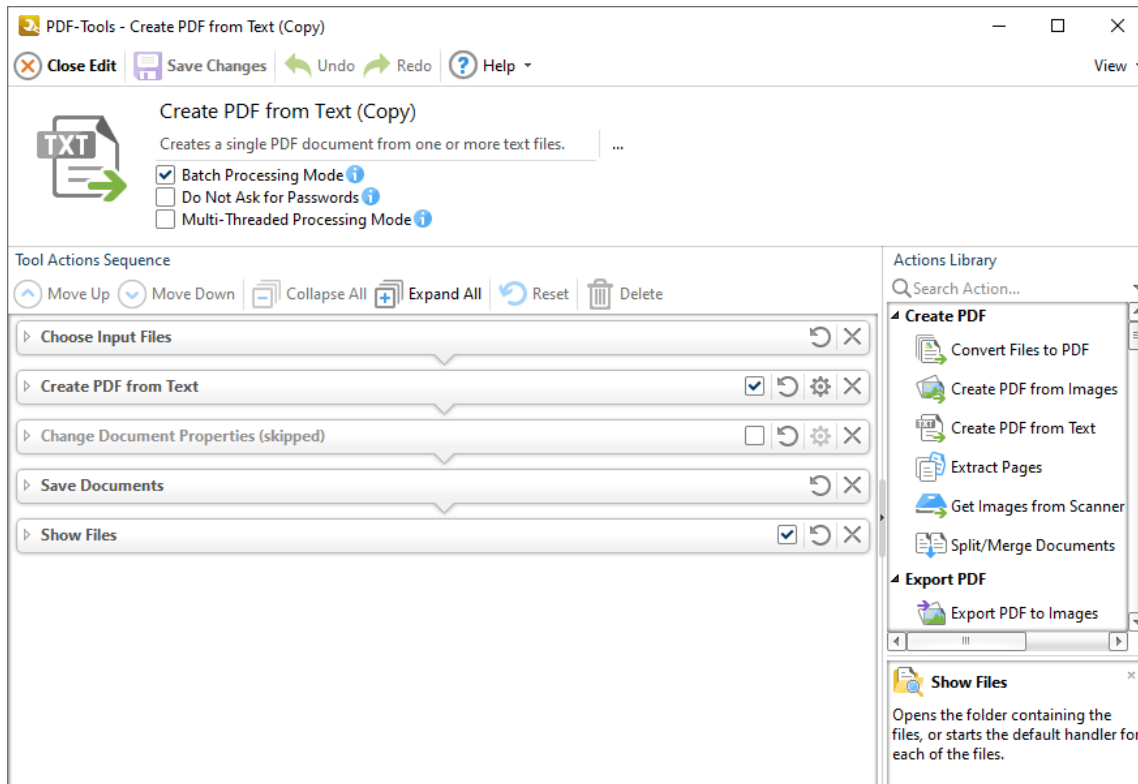

Figure 5. Main Window, Cloned Tool Right-Click Menu

The **Edit** window for the tool will open:



**Figure 6.** Cloned Tool Edit Window

- Click the ▶ icon to expand/collapse actions. Available parameters are displayed when actions are expanded. A complete breakdown of all actions and their parameters is available [here](#).<sup>[76]</sup>
- Click the ↺ icon to revert to default parameters after action parameters have been changed.
- Click the ✕ icon to remove actions from the **Tool Actions Sequence**.
- Actions that feature a check box are optional. A selected box means actions are included in the **Tool Actions Sequence** when the tool runs. A cleared box means that actions are skipped when the tool runs, but are retained in the **Tool Actions Sequence** for subsequent use. (This is a useful feature in cases where actions are required only some of the time).
- Drag actions from the **Actions Library** (or double-click them) to add them to the **Tool Actions Sequence**. There are seventy-seven available actions. See the [Actions Library](#).<sup>[76]</sup> for an explanation of all actions and their associated parameters.
- The order of actions in the **Tool Actions Sequence** determines their order of operation when tools run. Select actions and then click the **Move Up** or **Move Down** buttons displayed in *(figure 6)* to change their order in the **Tool Actions Sequence**. Several actions require additional actions in order to function correctly. Additional actions may be required before (prerequisite) or after (postrequisite) actions. For example the **Create PDF From Text** action requires both an action that sources input files to convert to PDF and an action that saves converted files. If an ordering mistake is made then a warning icon will appear. Click the icon for further information and a solution to the issue.
- The **Batch Processing Mode** setting determines the processing method in cases of multiple input files. It is enabled by default, which means files are processed simultaneously. Clear the **Batch Processing Mode** box to process input files one at a time instead. Disabling this option should reduce memory usage, but it may also result in unexpected output for tools that combine input files into single documents.
- The **Do Not Ask for Passwords** setting is disabled by default. This means that **PDF-Tools** will prompt for passwords in cases of password-protected input files that do not have corresponding passwords in [Predefined Passwords Storage](#).<sup>[560]</sup> Enable this option to skip these files when tools run.
- The **Edit** window *(figure 6)* and the options it contains are detailed [here](#).<sup>[62]</sup>

3. Click  **Save Changes** to save changes to tools.

## 7 Actions Library



### Actions Library

The **Actions Library** contains the seventy-seven available actions in **PDF-Tools**. These actions are used to create the **Tool Actions Sequence**, which determines the functionality of tools. The **Actions Library** is located on the right side of the **Edit** window:

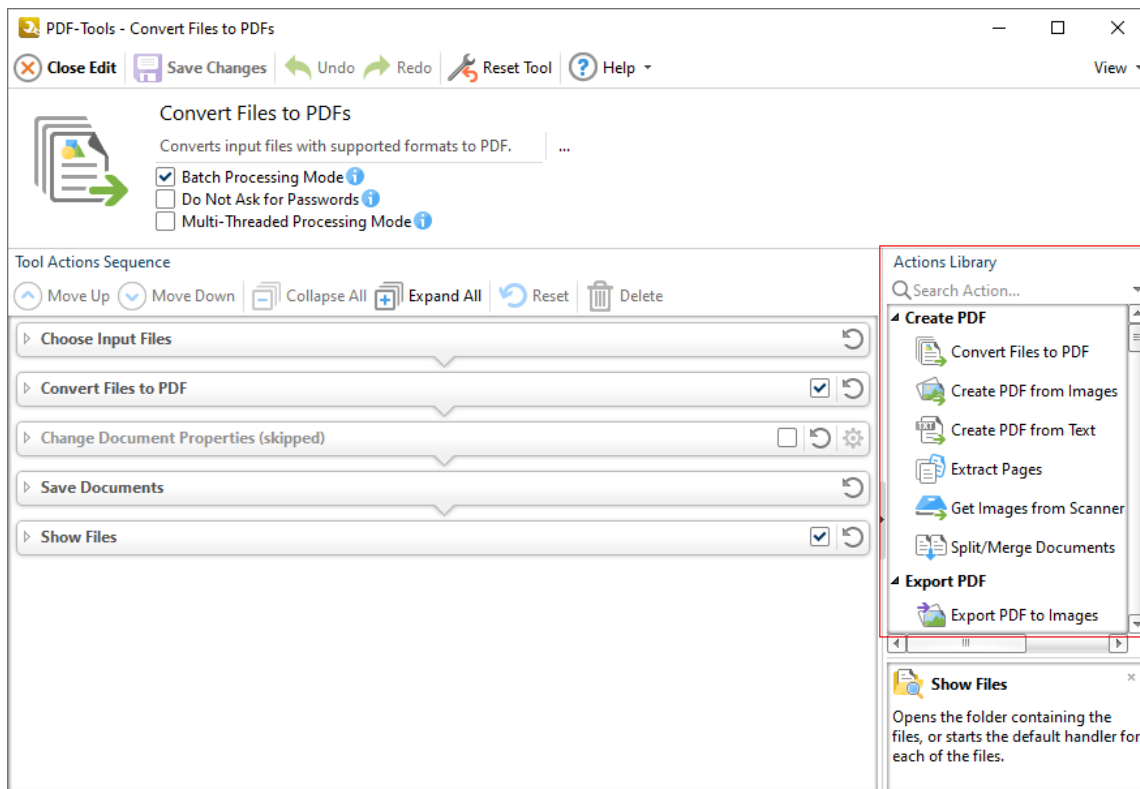













Figure 1. Edit Window, Actions Library Highlighted

The actions are grouped into twelve categories:

 The **Create PDF Actions** <sup>[78]</sup> are used to create PDF documents from documents of other formats, image files, scanned input or through splitting/merging existing PDF documents.

-  The [Export PDF Actions](#)<sup>[105]</sup> are used to export content from PDF documents into alternative formats such as image files and **MS Office** formats.
-  The [Input/Output Actions](#)<sup>[127]</sup> relate to input/output processes when files are sourced/saved.
-  The [Bookmarks Actions](#)<sup>[144]</sup> are used to create and manipulate document bookmarks.
-  The [Optimize PDF Actions](#)<sup>[166]</sup> are used to enhance the quality of scanned pages and optimize the size of documents.
-  The [PDF Standard Actions](#)<sup>[179]</sup> are used to add/remove compliance with the PDF subsets **PDF/A** and **PDF/X**.
-  The [Pages Actions](#)<sup>[186]</sup> are used to edit and enhance document pages.
-  The [Links Actions](#)<sup>[242]</sup> are used to create/delete links and weblinks.
-  The [Forms Actions](#)<sup>[242]</sup> are used to import, export, reset or delete forms and form data.
-  The [Comments Actions](#)<sup>[257]</sup> are used to import/export, remove and interact with document comments, annotations and form fields.
-  The [Protection Actions](#)<sup>[271]</sup> are used to determine document security via digital signatures, timestamps and passwords.
-  The [Advanced Actions](#)<sup>[292]</sup> are used to change the document properties or email documents.

Click action categories for further information.

---

## 7.1 Create PDF Actions







---



### Create PDF Actions

---

The **Create PDF** actions are used to create PDF documents from documents of other formats, image files, scanned input or through splitting/merging existing PDF documents:

-  [Convert Files to PDFs](#)<sup>[79]</sup> creates PDF documents from documents of other formats.
  -  [Create PDF from Images](#)<sup>[86]</sup> creates PDF documents from image files.
  -  [Create PDF from Text](#)<sup>[93]</sup> creates PDF documents from text files.
  -  [Extract Pages](#)<sup>[97]</sup> creates PDF documents from pages of existing documents.
  -  [Get Images From Scanner](#)<sup>[99]</sup> sources images from the local scanner for use with other actions from the **Actions Library**.
  -  [Split/Merge Documents](#)<sup>[103]</sup> splits single documents into several smaller documents, or combines multiple documents into a single file.
-

### 7.1.1 Convert Files to PDFs

---



## Convert Files to PDFs

---

The **Convert Files to PDF** action creates PDF documents from documents of other formats. Please note:

- This action is intended for use with files that contain both text and images. Use the [Create PDF from Text](#)<sup>[93]</sup> action to create PDF documents from text files and the [Create PDF from Images](#)<sup>[86]</sup> action to create PDF documents from image files.
- This action creates a new PDF document from each input file. Use the [Split/Merge Documents](#)<sup>[103]</sup> action to create a single PDF document from multiple input files.
- This action must be ordered after the [Choose Input Files](#)<sup>[128]</sup> action in the **Tool Actions Sequence** or the tool will not run.
- A complete list of supported file formats is available [here](#).<sup>[469]</sup>

The **Convert Files to PDF** action contains the following customizable parameters:

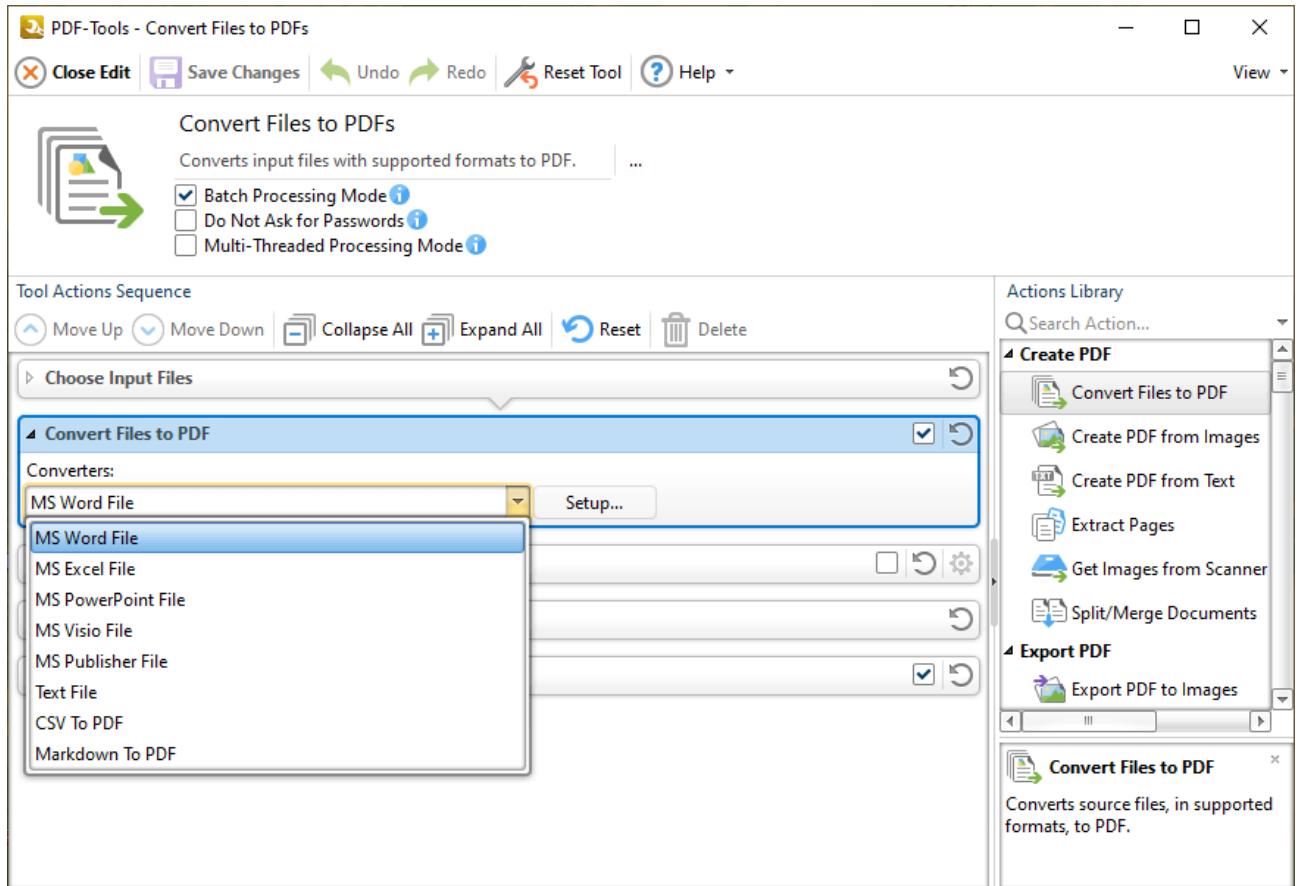

Figure 1. Convert Files to PDF Action Parameters

- The **Converters** dropdown menu details input formats that have adjustable parameters that can be customized. Select a format and click **Setup** to determine adjustable parameters when files of the specified format are converted to PDF.
  - The **MS Word File** option contains three parameters:
    - Select the **Allow for the conversion of RTF files with Microsoft Word** box to allow **MS Word** to convert (\*.rtf) files to **MS Word** format.
    - Select the **Enable macros in macro-enabled documents** box to enable [macros](#)<sup>488</sup> in converted **MS Word** files.
    - Select the **Include markups in conversion** box to include markups made to **MS Word** files in the conversion to PDF.
  - The **MS Excel**, **MS Powerpoint** and **MS Visio File** options contain one parameter:
    - Select the **Enable macros in macro-enabled documents** box to enable [macros](#)<sup>488</sup> in converted **MS Excel/Powerpoint/Visio** files.
  - The **Text File** options are detailed below:



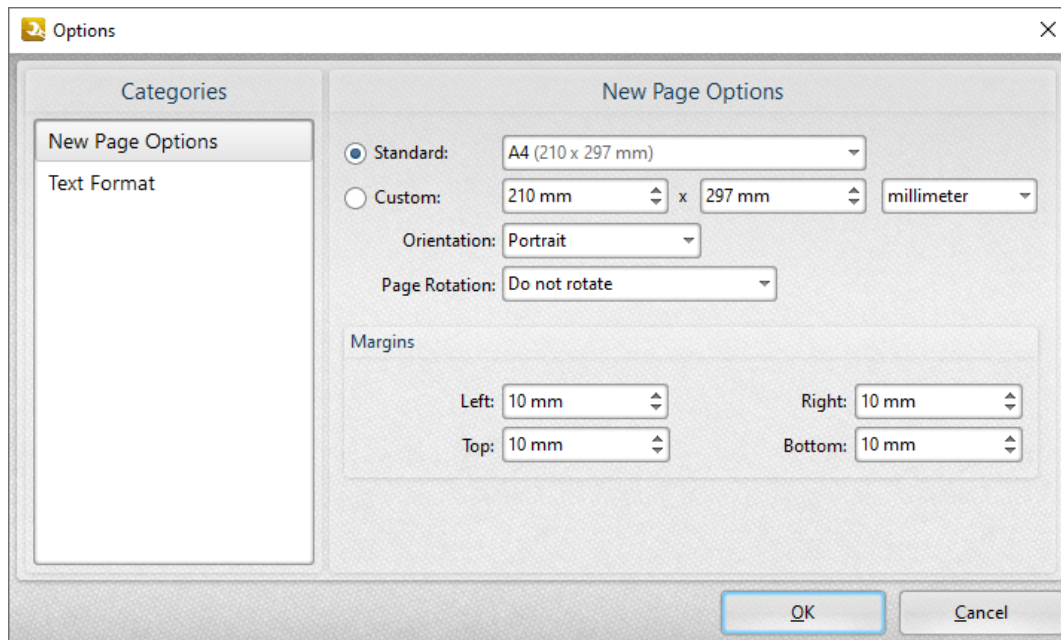

Figure 2. Text File Options Dialog Box, New Page Options

These options are used to determine the size and layout parameters for converted text files:

- Select **Standard** to convert text files into a PDF of standard dimensions, then select a standard size in the dropdown menu.
- Select **Custom** to convert text files into a PDF of custom dimensions, then enter the desired dimensions in the number boxes and select the desired units of measurement, orientation and page rotation.
- Use the **Margins** number boxes to determine the page margins.

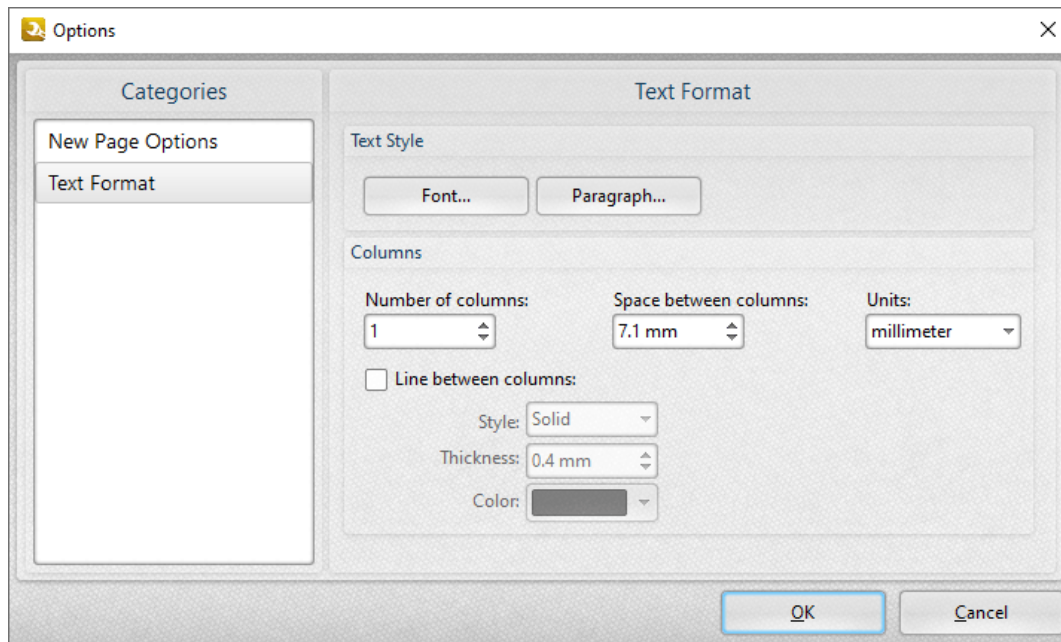

Figure 3. Text File Options Dialog Box, Text Format Options

- Click **Font/Paragraph** to determine font/paragraph options, as detailed [here](#).<sup>486</sup>
- Use the **Number of columns** dropdown menu to determine the number of columns of text.
- Use the **Space between columns** dropdown menu to determine the distance between columns and the **Units** dropdown menu to determine the units of measurement.
- Select the **Line between columns** box to insert a line between columns of text, then use the dropdown menus to determine the **Style, Thickness** and **Color** of columns as desired.

The **CSV to PDF** options are detailed below:

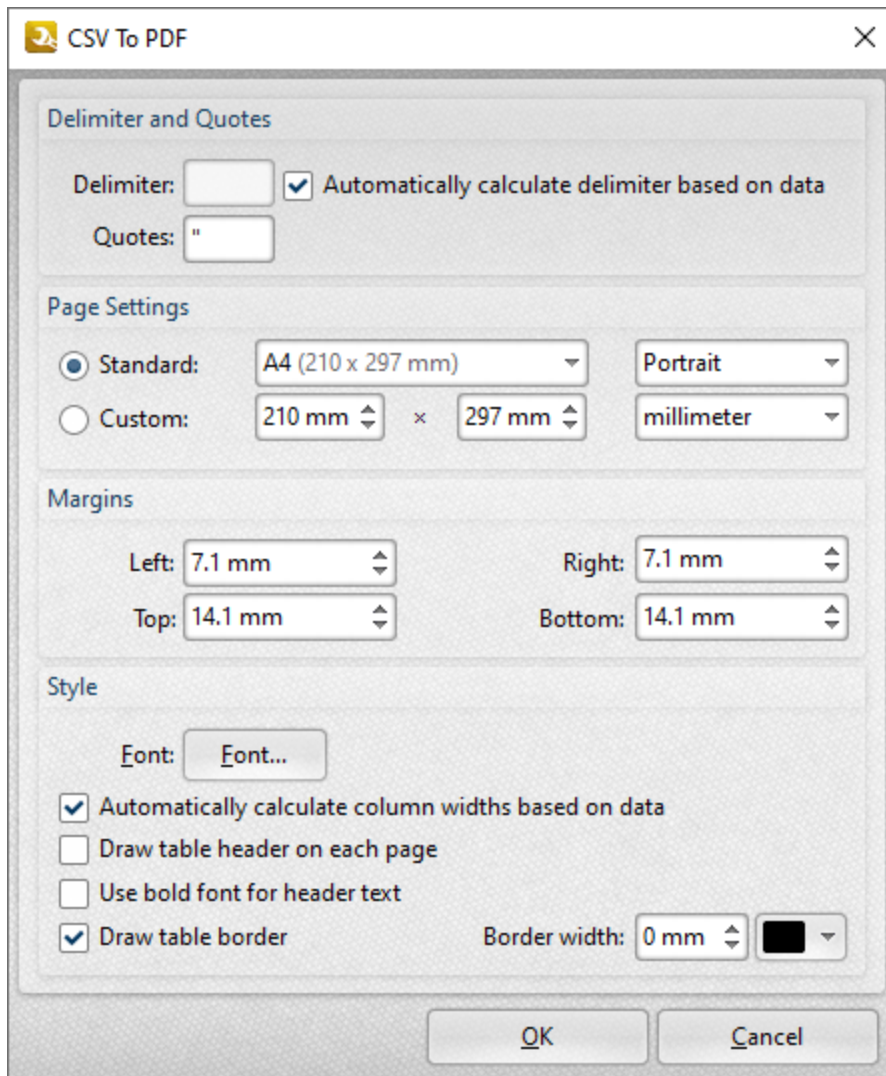

Figure 4. CSV to PDF Dialog Box

- Use the **Delimiter** text box to specify the delimiter used to delimit values in input CSV documents. Alternatively, select the **Automatically calculate delimiter based on data** box to detect delimiters automatically.
- Use the **Quotes** text box to specify the quotes used in input CSV documents.
- Use the **Page Settings** to determine the size and orientation of converted files:
  - Use the **Standard** dropdown menu to specify standard page dimensions such as those used by the **ISO** and **ANSI**, then use the adjacent dropdown menu to specify either **Portrait** or **Landscape** as the orientation of output documents.
  - Click the **Custom** button to use custom dimensions, then enter the desired dimensions in the adjacent number boxes. Use the adjacent dropdown menu to specify the units of measurement used.
- Use the **Style** options to specify the style of output documents:
  - Use the **Margins** boxes to specify the margins of output documents.

- Click the **Font** button to specify the font of output documents. The **Select Font** dialog box will open. Select the font, style and size of the desired font and then click **OK** to save changes.
- Use the **Border Width** number box to specify the border width on the pages of output documents, and use the adjacent dropdown menu to specify the border color.
- Use the check boxes to enable/disable additional options as desired.

Click **OK** to save changes.

The **Markdown to PDF** options are detailed below:

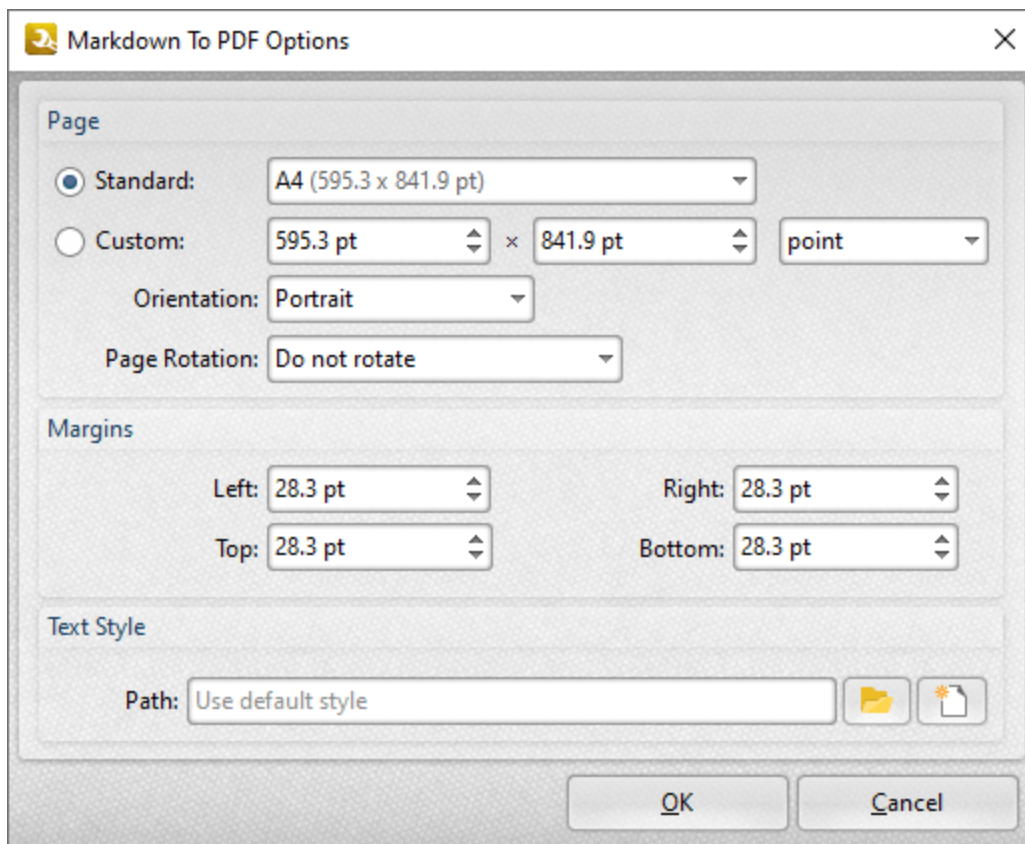

**Figure 5.** Markdown to PDF Options Dialog Box

- Use the **Standard** dropdown menu to specify standard page dimensions such as those used by the **ISO** and **ANSI**.
- Click the **Custom** button to use custom dimensions, then enter the desired dimensions in the adjacent number boxes. Use the adjacent dropdown menu to specify the units of measurement used.
- Use the **Orientation** dropdown menu to specify the orientation of output documents.

- Use the **Page Rotation** dropdown menu to specify the page rotation of output documents.
- Use the **Margins** number boxes to specify the margins of output documents.
- Use the **Path** text box to specify the path to a **CSS** file in order to specify text style options in output documents.

Click **OK** to save changes.

---

## 7.1.2 Create PDF from Images



The **Create PDF from Images** action creates PDF documents from image files. It contains the following customizable parameters:

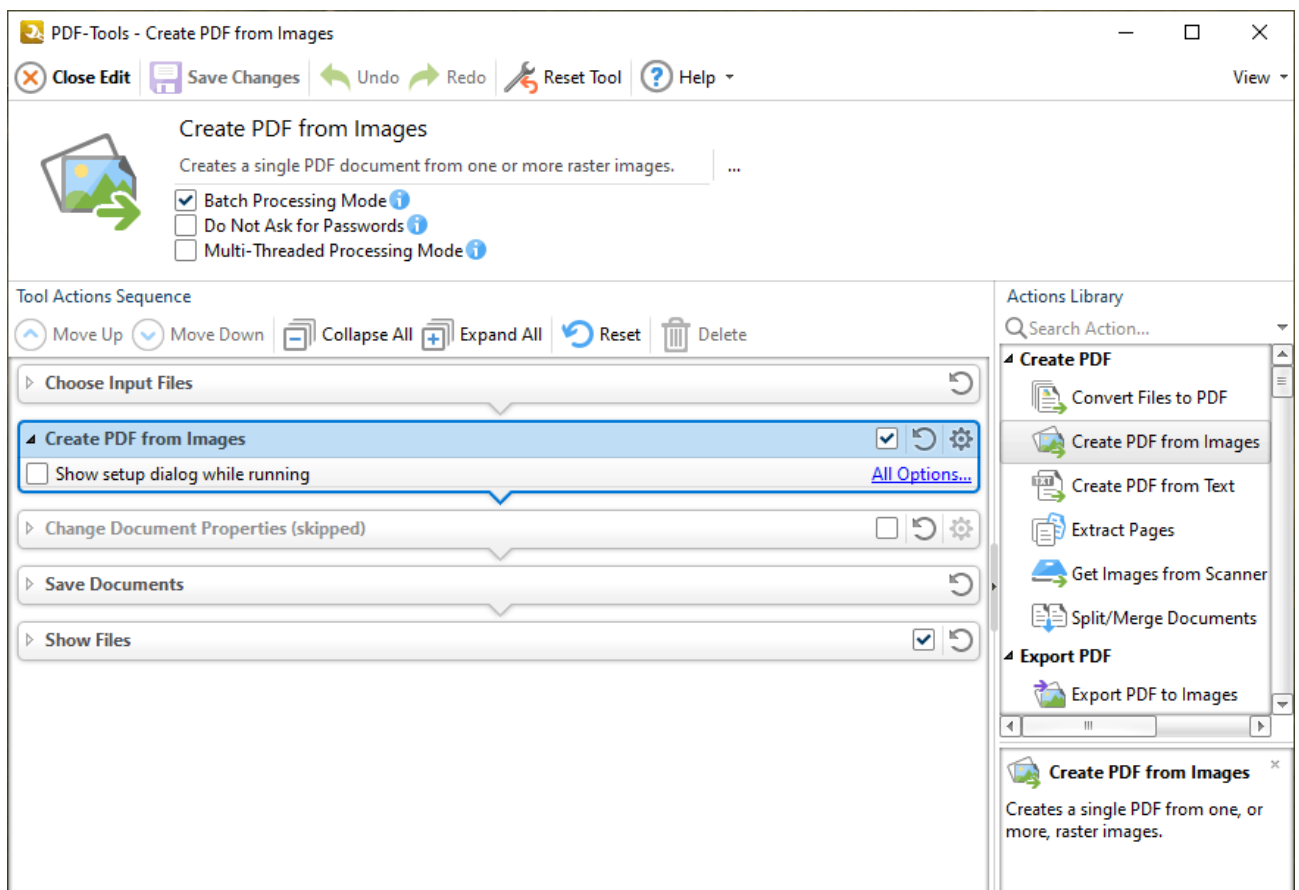

Figure 1. Create PDF from Images Action Parameters

- Click **All Options** to determine conversion options for images. The **Image to PDF Options** dialog box will open, as detailed below.
- Select the **Show setup dialog while running** box to launch the **Image to PDF Options** dialog box and customize settings each time this action is used. Clear this box to disable the **Image to PDF Options** dialog box from opening each time the action is used, which is useful when the same settings are used consistently.

## New Page Options

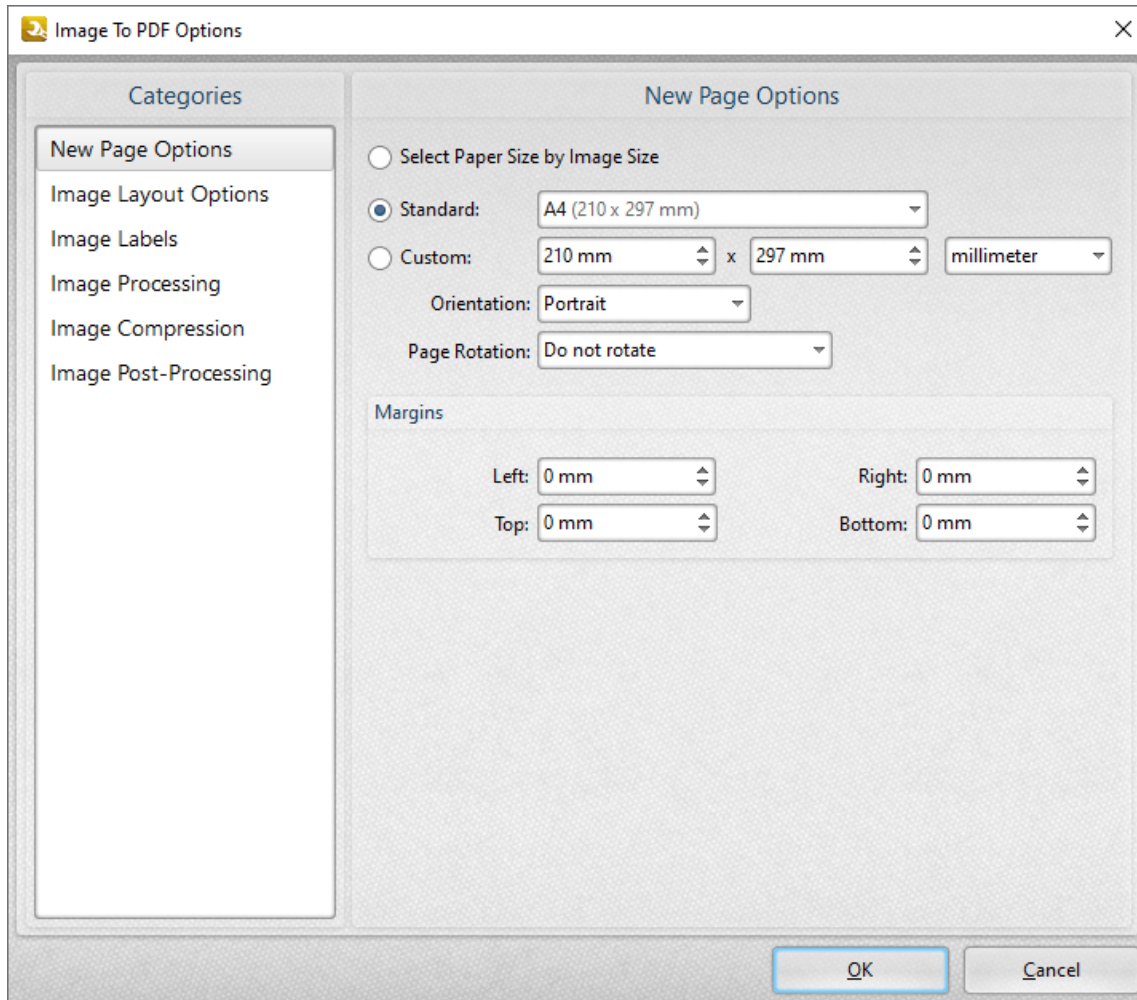

Figure 2. Image to PDF Options Dialog Box, New Page Options

- The **New Page Options** determine the page dimensions of output documents:
  - Select the **Select Paper Size by Image Size** option to use the dimensions of input images as the page size of output documents.
  - Select the **Standard** option to use an industry-standard size for output documents, then select an option from the dropdown menu.
  - Select the **Custom** option to use custom dimensions for output documents, then enter the dimensions in the number boxes and select the desired units of measurement, orientation and page rotation.
  - Use the **Margins** number boxes to determine the page margins of output documents.

## Image Layout Options

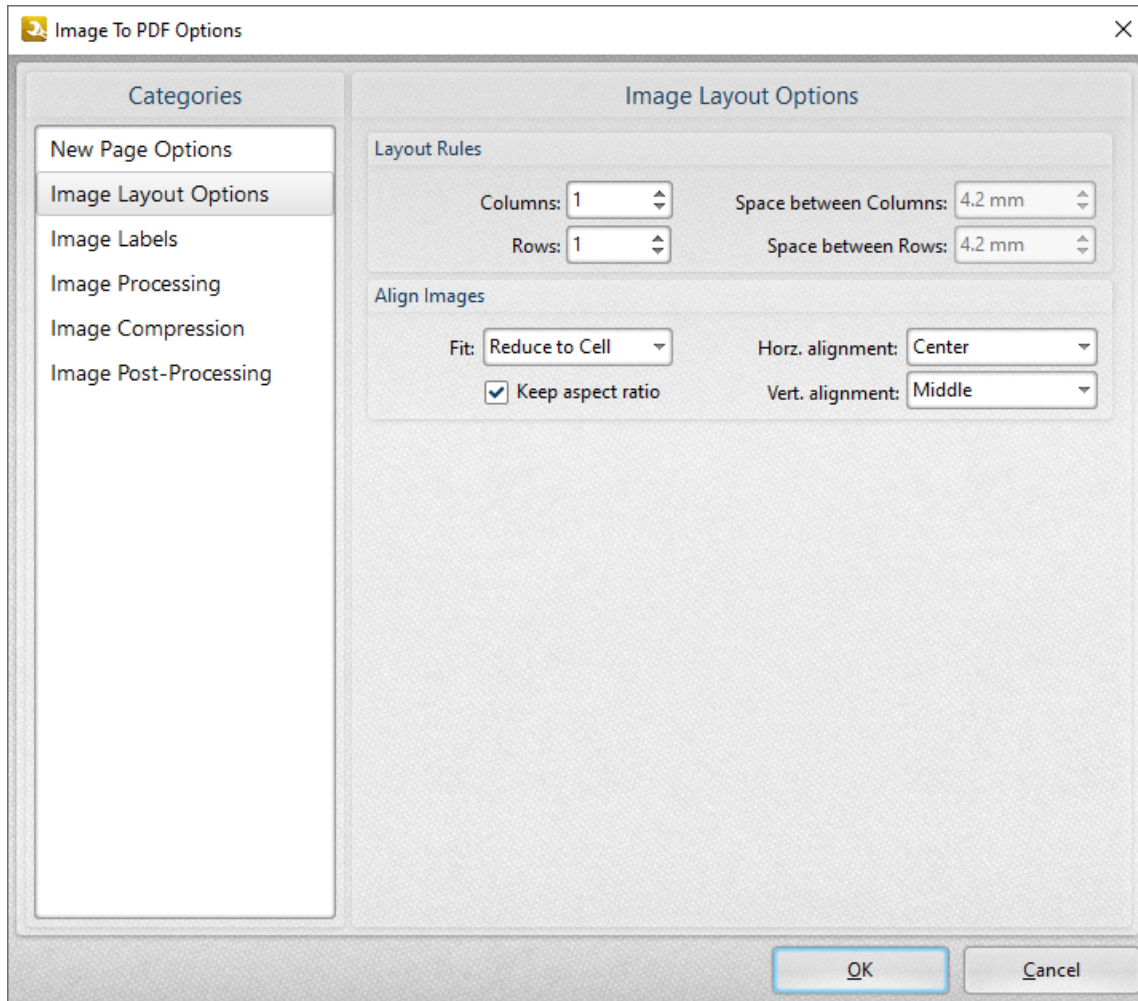

Figure 3. Image to PDF Options Dialog Box, Image Layout Options

These settings are used to customize the layout of images in output documents:

- Use the **Columns** and **Rows** number boxes to determine the layout of output documents that feature multiple images. Use the number boxes on their right to determine the distance between columns and rows of images in output documents.
- Use the **Fit** dropdown menu to determine how images fit into the dimensions of the output document:
  - Select **Reduce to Cell** to reduce the size of images to fit the dimensions of the PDF document. If images are smaller than the PDF document then they will remain at their original size.
  - Select **Fit to Cell** to fit images to the dimensions of the PDF document. If images are smaller than the PDF document then they will be increased in size.
  - The **Keep Aspect Ratio** check box is selected by default, which means images retain their proportions and fit the specified dimensions of the output documents as far as possible within those proportions. Clear the check box to



disable the aspect ratio. Images will then match the specified dimensions of the output document, but they may distort as a result.

- The **Horizontal/Vertical Alignment** dropdown menus determine the location at which images appear in the output document.

## Image Labels

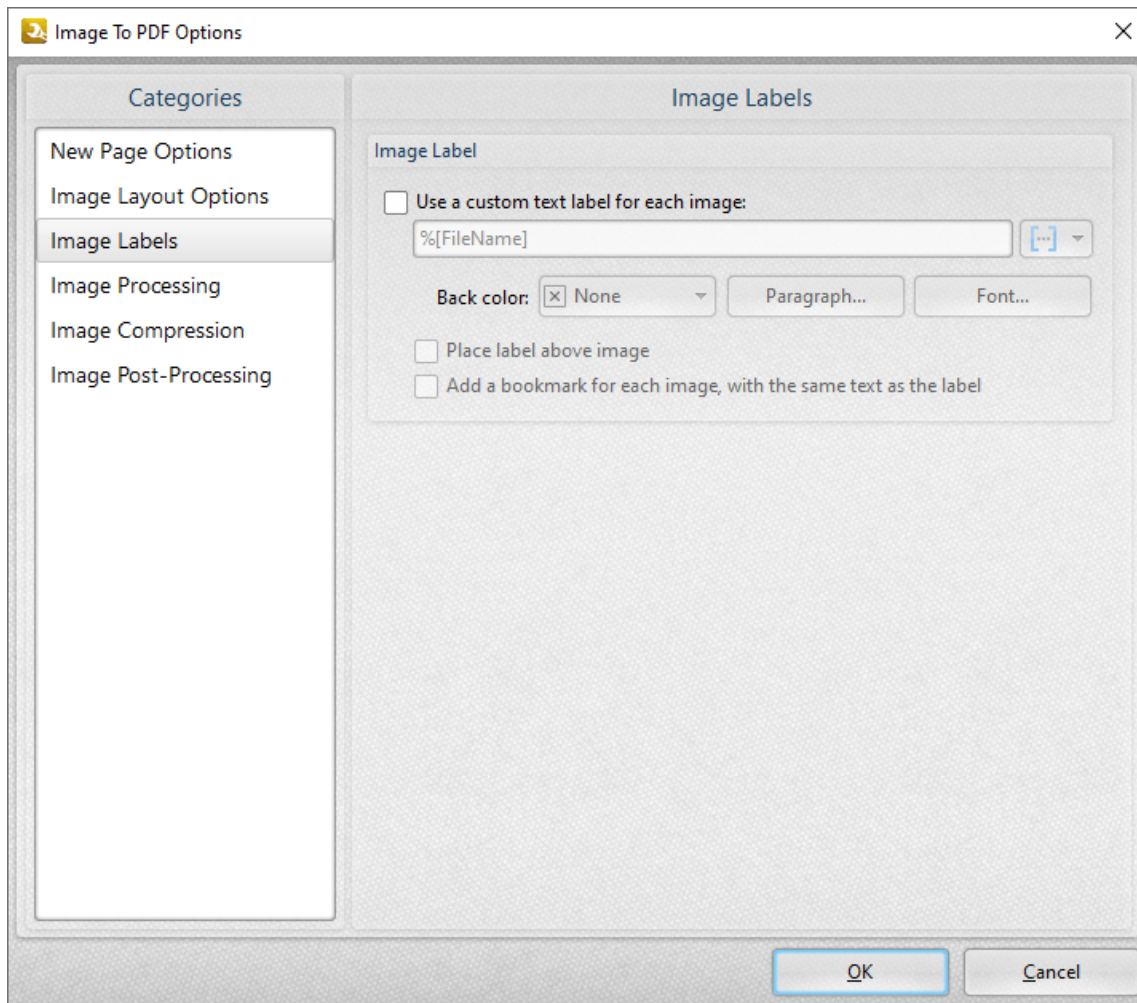

**Figure 4.** Image to PDF Options Dialog Box, Image Labels

These settings are used to add labels to images in output documents:

- Select the **Use a custom text label for each image** box to add a label to images, then use the remaining settings to customize the label:
  - Enter the desired text for the label in the text box. Click the blue icon to view/add [macros](#).<sup>[488]</sup>
  - Use the **Back Color** dropdown menu to determine the back color of the label.
  - Click the **Paragraph** and **Font** buttons to determine paragraph and font settings, as detailed [here](#).<sup>[486]</sup>

- Select the **Place label above image** box to place the labels above images. If this box is cleared then labels are placed below images.
- Select the **Add bookmark for each image, with the same text as the label** option as desired. If this option is selected then a bookmark will be created for each image in the output document. The bookmark titles will be the same as the text entered in the text box in **(figure 4)** - which means the text will be the same for all bookmark titles unless **macros** <sup>488</sup> are used, which is the advisable option.

## Image Processing

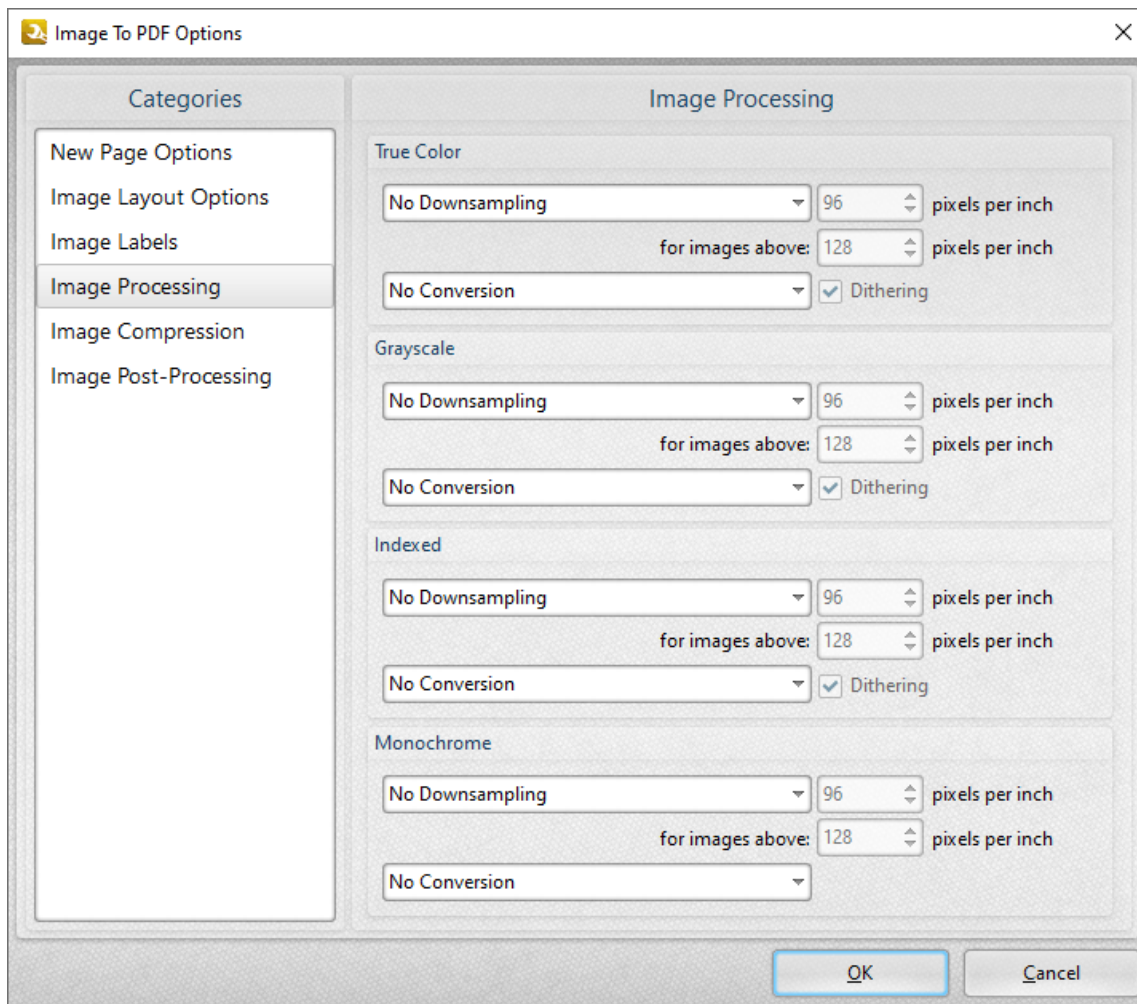

**Figure 5.** Image Processing Options

These settings determine image processing options, which are the same for **True Color**, **Grayscale**, **Indexed** and **Monochrome** images:

- Select an option in the **Downsampling** dropdown menus to enable **Linear**, **Bilinear** or **Bicubic** downsampling for converted images. Further information about these

options is available [here](#). Use the **pixels per inch** number boxes to set the resolution to which images are downsampled, and the minimum resolution at which images are downsampled.

- Select an option in the **Conversion** dropdown menus to convert images to a different format. Select the **Dithering** box to enable [dithering](#) as desired.

## Image Compression

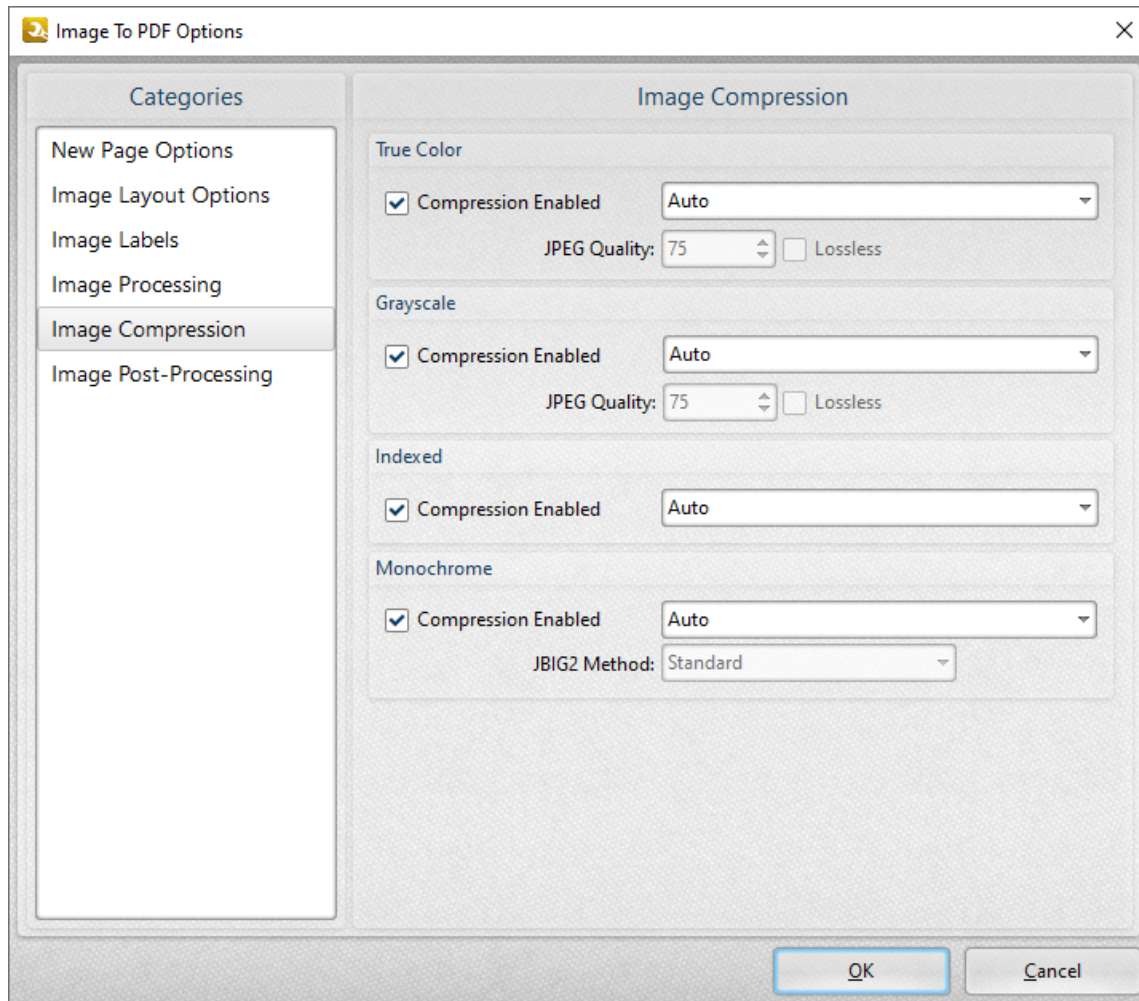

Figure 6. Image Compression Options

These settings determine image compression options:

- Select/clear the **Compression Enabled** boxes to enable/disable compression for **True Color, Grayscale, Indexed** and/or **Monochrome** images.
- Use the **Auto** dropdown menus to determine the format of compression used for **True Color, Grayscale, Indexed** and/or **Monochrome** images.
- Select options in the the **JPEG Quality/JBIG2 Method** dropdown menus and select/clear the **Lossless** boxes as desired.

## Image Post-Processing

These settings determine post-processing options for images:

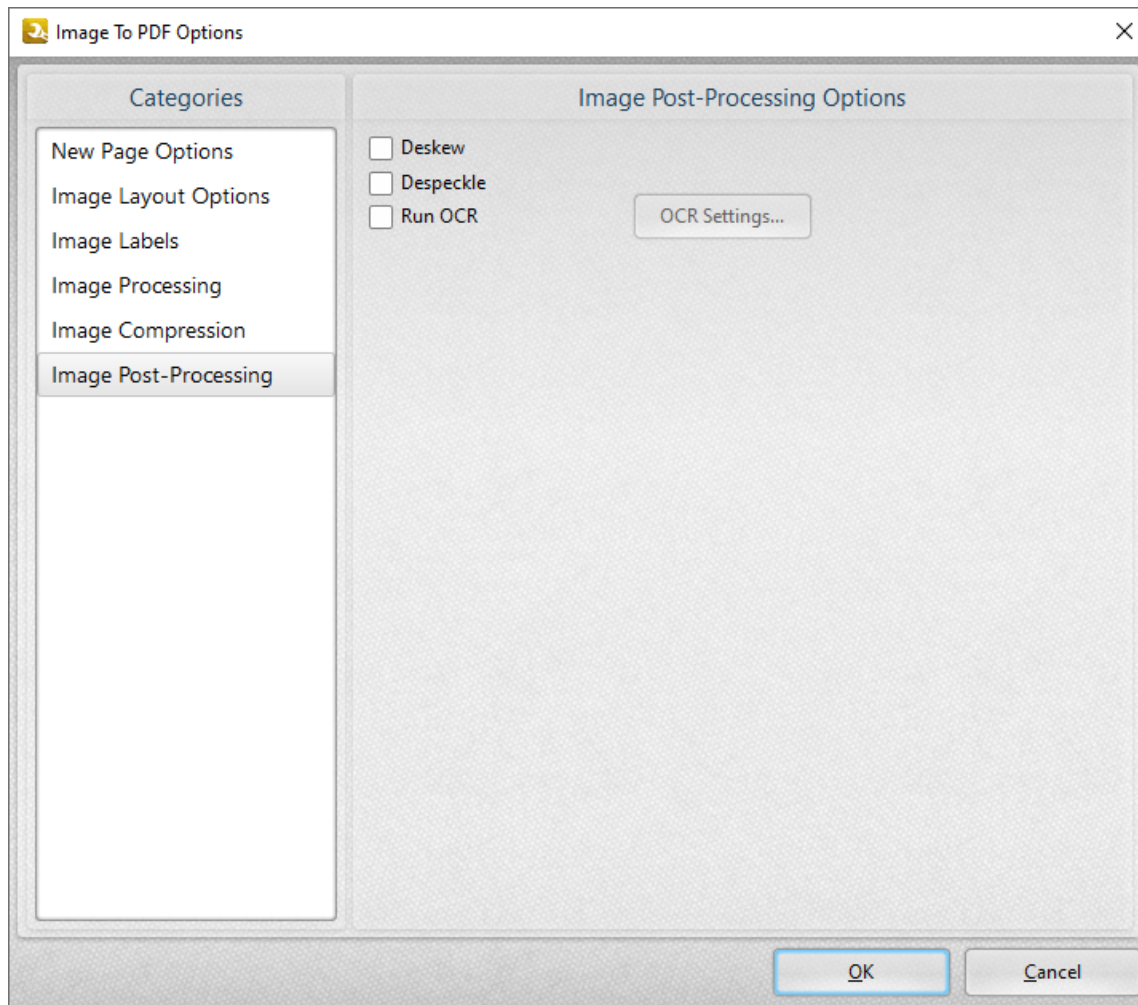

**Figure 7.** Image Post-Processing Options

- Select the **Deskew** box to deskew images. Deskewing is used to straighten the edges of images that have been scanned/photographed crookedly.
- Select the **Despeckle** box to despeckle images. Despeckling is used to remove speckles from images during conversion.

Click **OK** to save changes.

## 7.1.3 Create PDF from Text



The **Create PDF from Text** action creates PDF documents from text files. It contains the following customizable parameters:

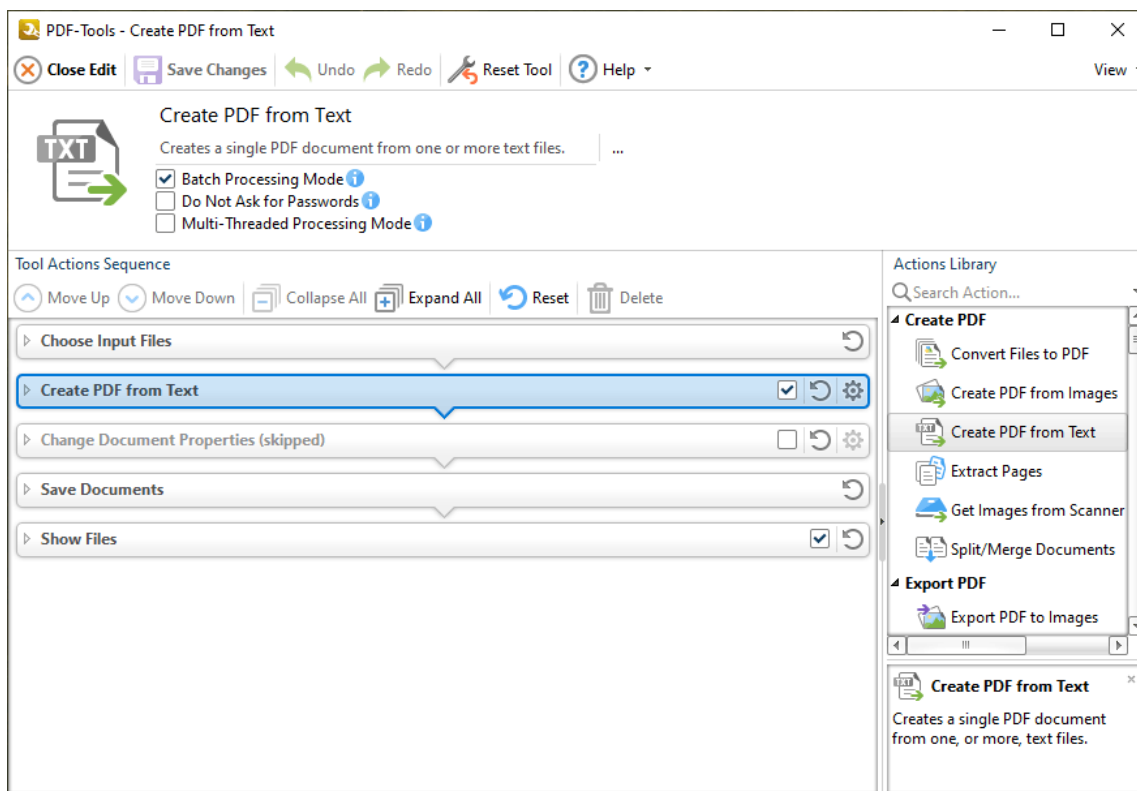

**Figure 1.** Create PDF from Text Action Parameters

- Click **All Options** to determine conversion options for documents. The **Options** dialog box will open, as detailed below.
- Select the **Show setup dialog while running** box to launch the **Options** dialog box and customize settings each time this action is used. Clear this box to disable the **Options** dialog box from opening each time the action is used, which is useful when the same settings are used consistently.

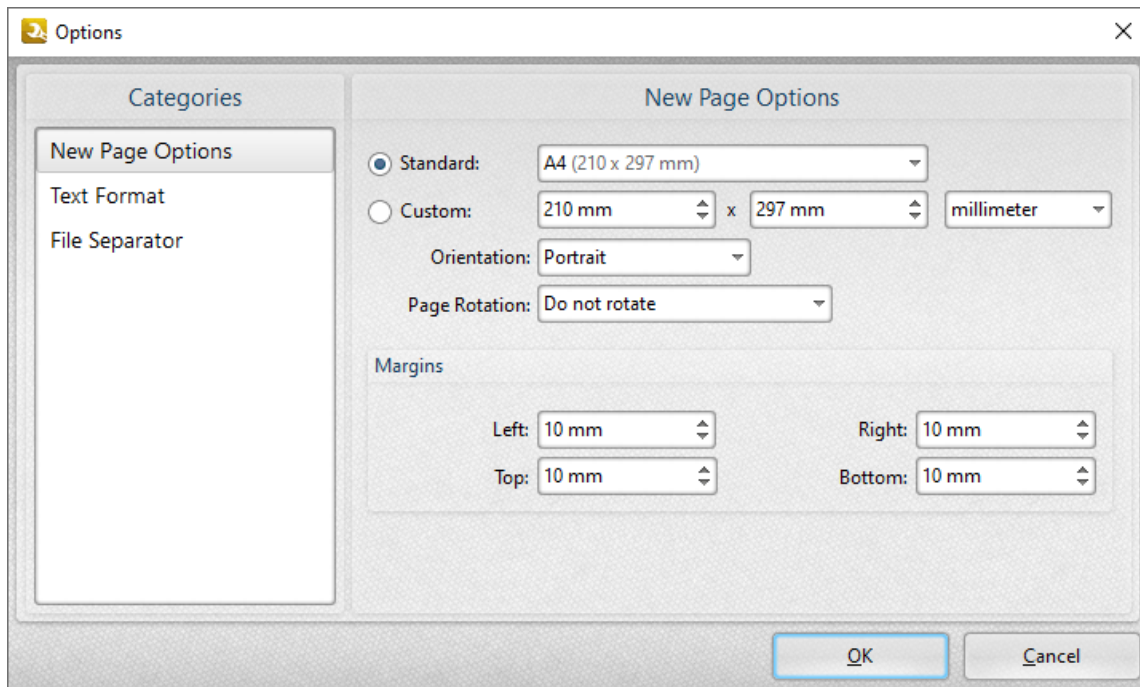

Figure 2. Options Dialog Box

## New Page Options

These options determine the page dimensions of output documents:

- Select the **Standard** option to use an industry-standard size for output documents, then select an option from the dropdown menu.
- Select the **Custom** option to use custom dimensions for output documents, then enter the dimensions in the number boxes and select the desired units of measurement, orientation and page rotation.
- Use the **Margins** number boxes to determine the page margins of output documents.

## Text Format Options

These options determine the font, paragraph and layout of text during conversion to PDF:

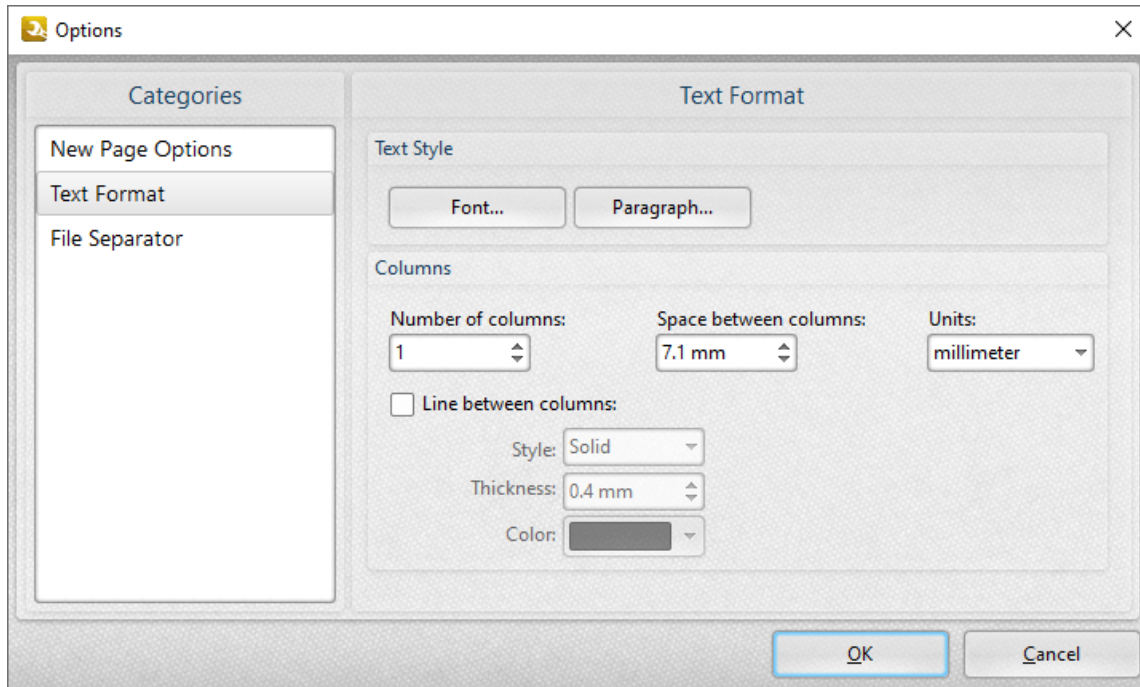

Figure 3. Text Format Options

- Use the **Font** and **Paragraph** buttons to determine the font and paragraph settings of the text, as detailed [here](#).<sup>486</sup>
- Use the **Columns** options settings to determine the number of columns of text and the distance between columns.
- Select the **Line between columns** box to insert lines between the columns of text, then use the **Style**, **Thickness** and **Color** boxes to determine the parameters of the lines.

### File Separator Options

The file separator option inserts labels to indicate spaces between converted documents. The following customizable parameters are available:

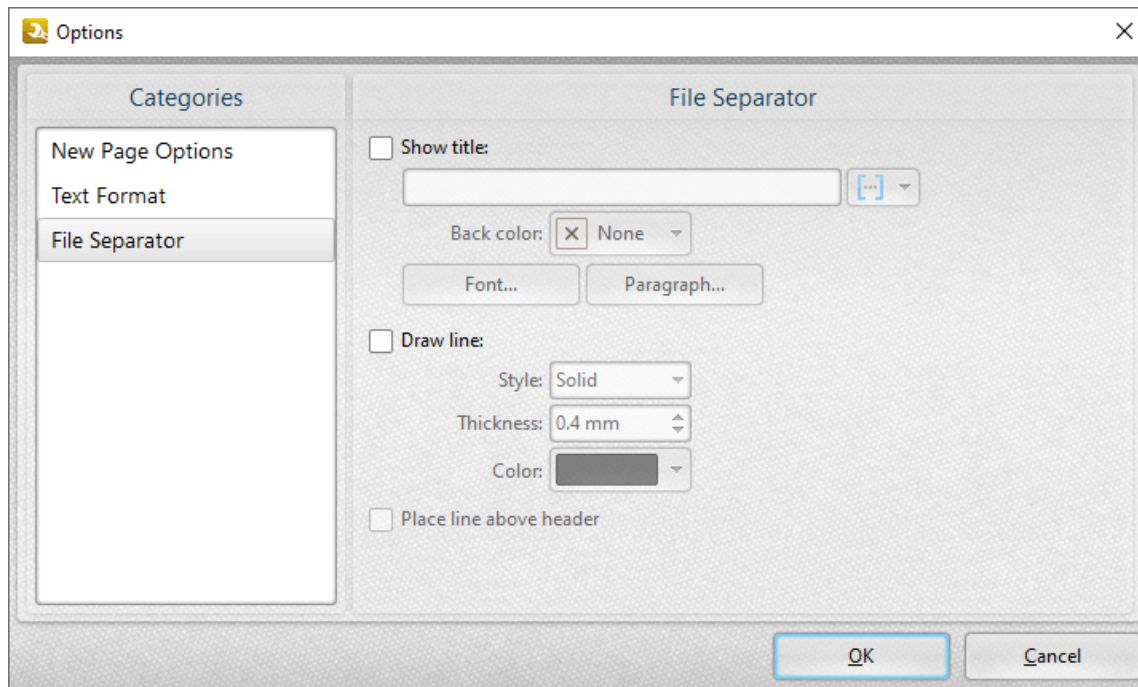

Figure 4. File Separator Options

- Select the **Show title** box to display a title with file separators, then enter the desired title in the text box. Click the blue icon to add [macros](#).<sup>486</sup>
- Use the **Back color** dropdown menu to determine the color of file separators.
- Use the **Font** and **Paragraph** settings to determine the font and paragraph layout of file separators, as detailed [here](#).<sup>486</sup>
- Select the **Draw line** box to add a line to file separators. Select the **Style, Thickness and Color** options as desired.
- Select the **Place line above header** box to position the line above the document header.

Click **OK** to save changes.

---



## 7.1.4 Extract Pages



### Extract Pages

The **Extract Pages** action creates PDF documents from pages of existing documents. It contains the following customizable parameters:

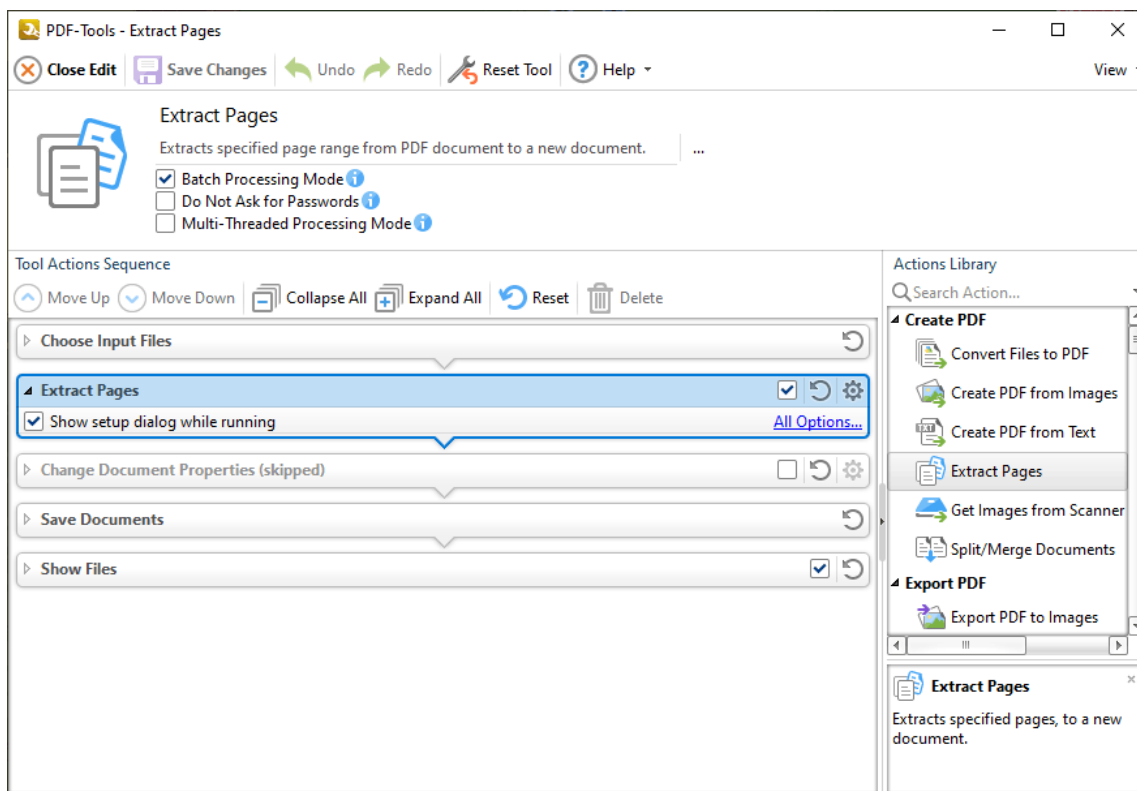

Figure 1. Extract Pages Action Parameters

- Click **All Options** to determine conversion options for extracted pages. The **Extract Pages** dialog box will open, as detailed below.
- Select the **Show setup dialog while running** box to launch the **Extract Pages** dialog box and customize settings each time this action is used. Clear this box to disable the **Extract Pages** dialog box from opening each time the action is used, which is useful when the same settings are used consistently.

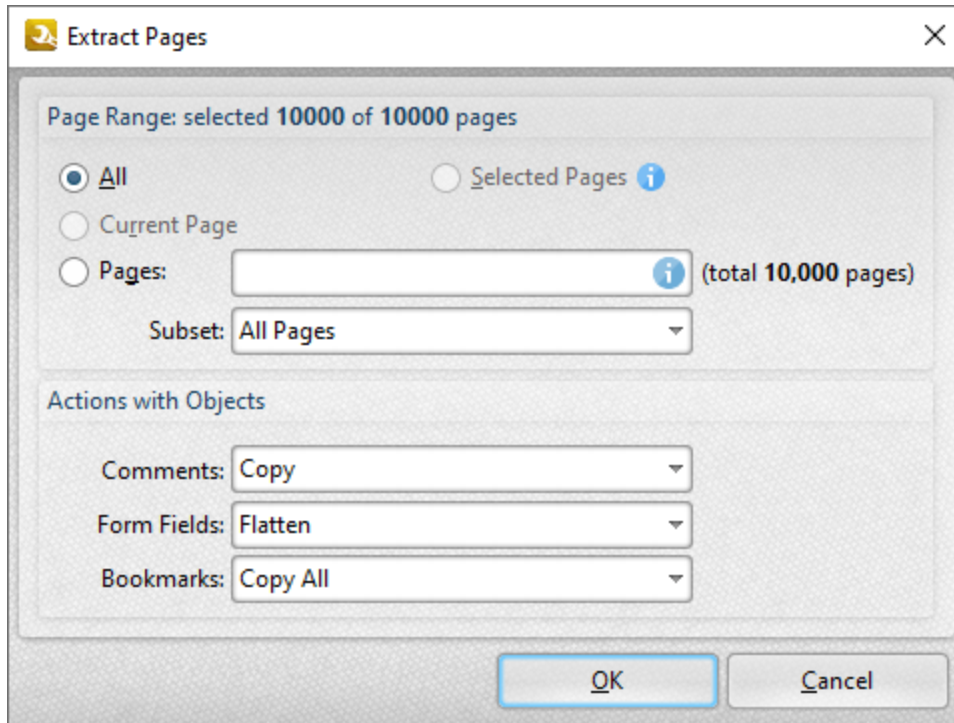

Figure 2. Extract Pages Dialog Box

- Use the **Page Range** options to determine which pages from the source document are extracted to create the new PDF document. Further information on page range options is available [here](#).
- Use the **Actions with Objects** dropdown menus to determine conversion options for **Comments, Form Fields and Bookmarks** in extracted pages.
- Note that the **Current Page** and **Selected Pages** options are not currently available. These options will be added in a future build.

Click **OK** to save changes.

## 7.1.5 Get Images from Scanner



The **Get Images from Scanner** action sources images from the local scanner for use with other actions from the **Actions Library**. It contains the following customizable parameters:

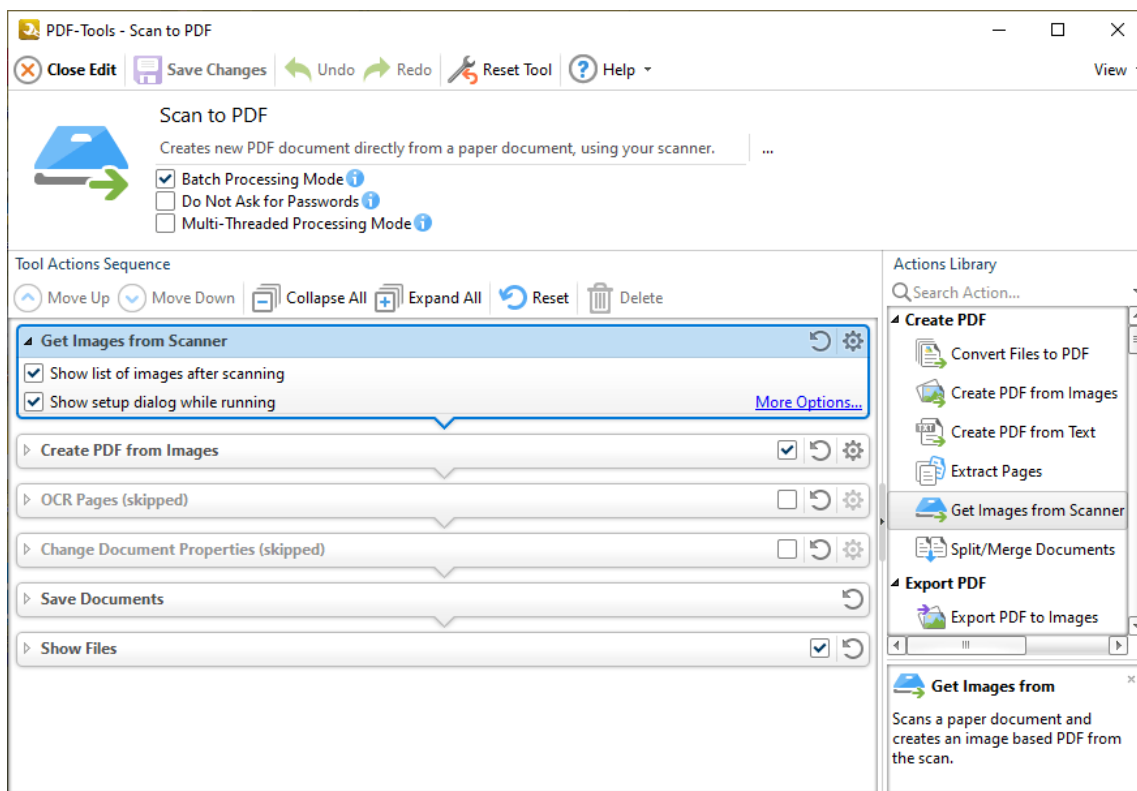

**Figure 1.** Get Images from Scanner Action Options

- Click **More Options** to determine scan parameters. The **Scan Properties** dialog box will open, as detailed below.
- Select the **Show setup dialog while running** box to launch the **Scan Properties** dialog box and customize scan parameters each time this action is used. Clear this box to disable the **Scan Properties** dialog box from opening each time the action is used, which is useful when the same settings are used consistently.

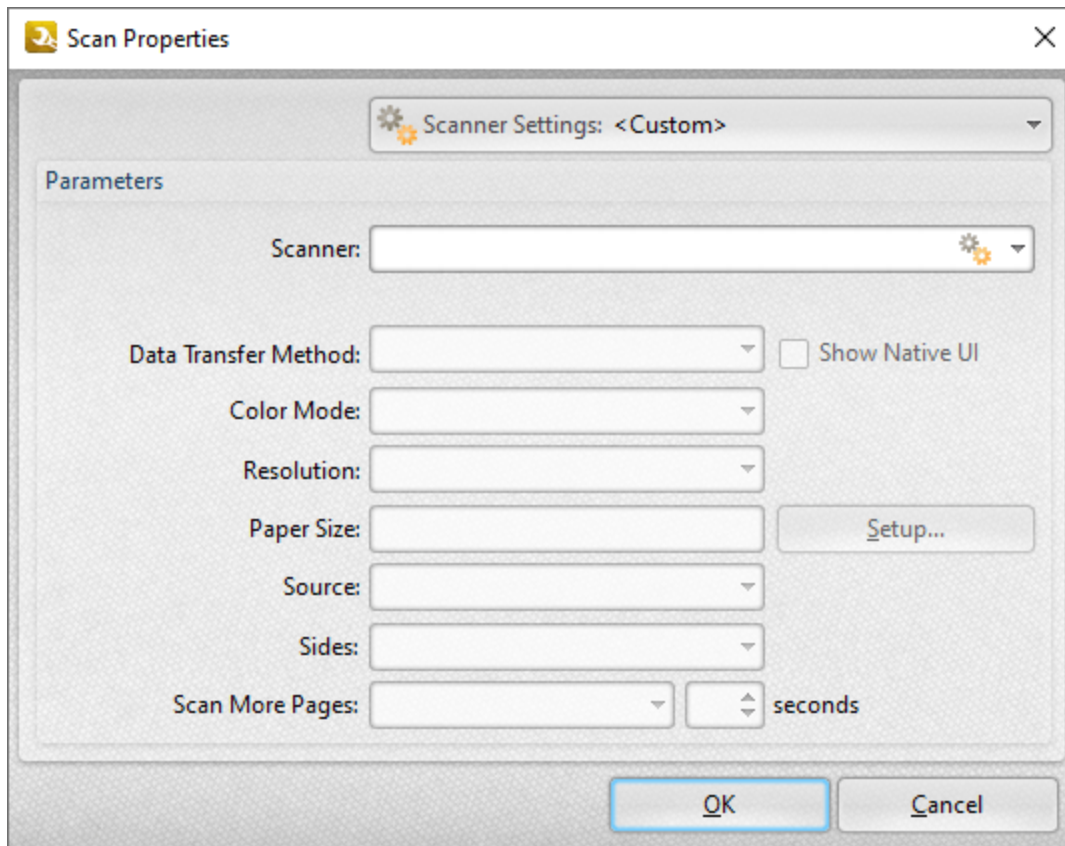

Figure 2. Scan Properties Dialog Box

- Use the **Scanner Settings** dropdown menu to save/select scanning profiles, as detailed in (figure 3).
- Use the **Scanner** dropdown menu to determine the scanner used to source images.
- Select either **Native Mode** or **Memory Mode** in the **Data Transfer Method** dropdown menu:
  - **Native Mode** uses a single memory buffer. This is the default and fastest mode, and is compatible with the broadest range of scanners.
  - **Memory Mode** enables the use of multiple memory buffers. This is a useful function in cases where memory is low and/or when large images are being scanned.
- The **Show Native UI** box is selected by default, which means the user interface of the device driver is used. This is the most reliable option, and the scanner will select certain parameters of the scan itself: **Color Mode**, **Resolution**, **Paper Size** and **Source**. Clear the **Show Native UI** box to customize these options:
  - Use the **Color Mode** dropdown menu to select **Auto detect**, **Color**, **Grayscale** or **Black & White** as the format of scanned documents.
  - Use the **Resolution** dropdown menu to set the **dpi** (dots per inch) of scanned documents.
  - Use the **Paper Size** number box to determine the paper size of scanned documents. Click **Setup** for further options:
    - Select **Automatic** to allow the paper size to be determined automatically.
    - Select **Standard** to use an industry-standard paper size.

- Select **Custom** to use custom dimensions.
- Use the **Source** dropdown menu to specify **Auto**, **Flatbed** or **Feeder** as the type of scanner used in the operation.
- Use the **Sides** dropdown menu to determine which sides of documents are scanned. There are three options: **Simple Scan**, **Manual Duplex** and **Manual Duplex Reversed**. Click the dropdown arrow on the right side of the box to view an explanation of these options.
- Use the **Scan More Pages** dropdown menu and number box to determine when additional pages are scanned.

Click **OK** to save changes.

## Scanner Settings

Use the **Scanner Settings** dropdown menu to select preset scanning modes or save/manage/delete custom settings:

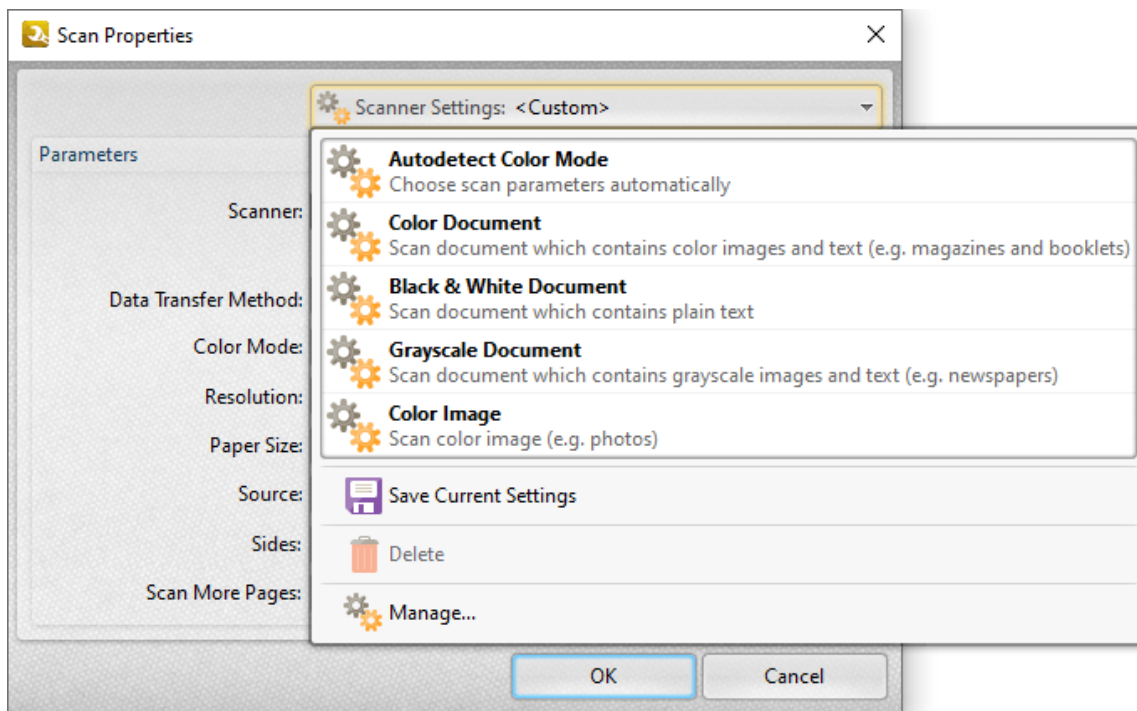

**Figure 3.** Scanner Settings Dropdown Menu Options

- Select predefined modes as desired.
- Click **Save Current Settings** to save the current settings as a profile for subsequent use.
- Click **Delete** to delete selected profiles. Note that this option is only available for customized profiles.

- Click **Manage** to manage preset/customized profiles. The **Manage Presets** dialog box will open:

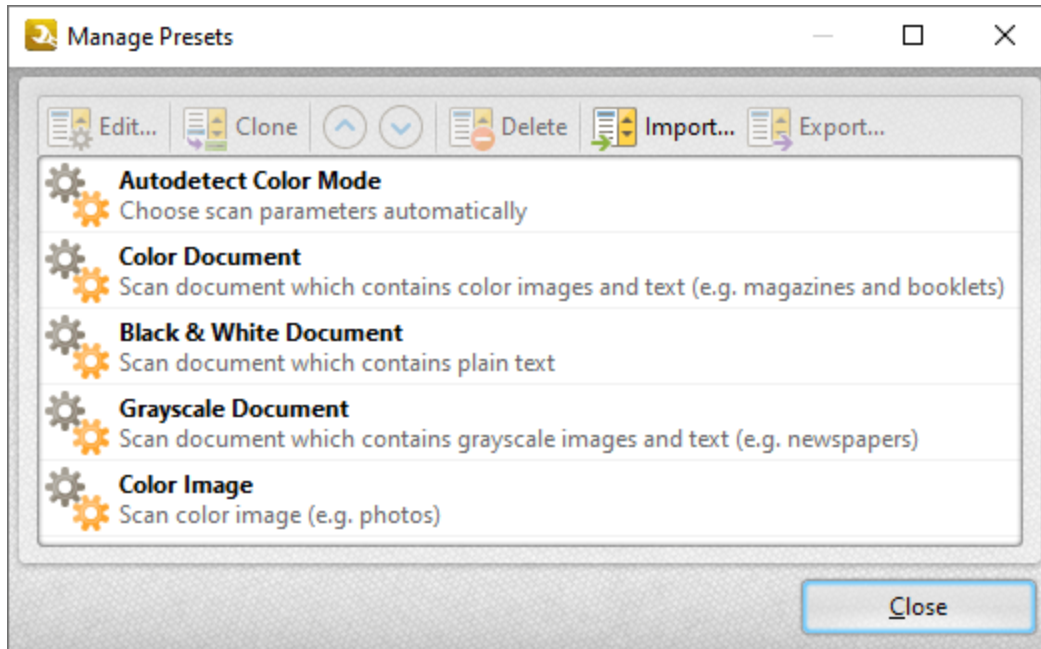

Figure 4. Manage Presets Dialog Box

- Click **Edit** to edit selected profiles. Note that this option is only available for customized profiles.
  - Click **Clone** to clone selected profiles. This option can be used to customize the settings of preset profiles, which cannot be customized in the default state.
  - Use the up and down arrows to move selected profiles up or down in the list.
  - Click **Delete** to delete selected profiles. Note that this option is only available for customized profiles.
  - Click **Import** to import profiles from a saved file.
  - Click **Export** to export profiles to file.
-

## 7.1.6 Split/Merge Documents



### Split/Merge Documents

The **Split/Merge Documents** action splits single documents into several smaller documents, or combines multiple documents into a single file. It contains the following customizable parameters:

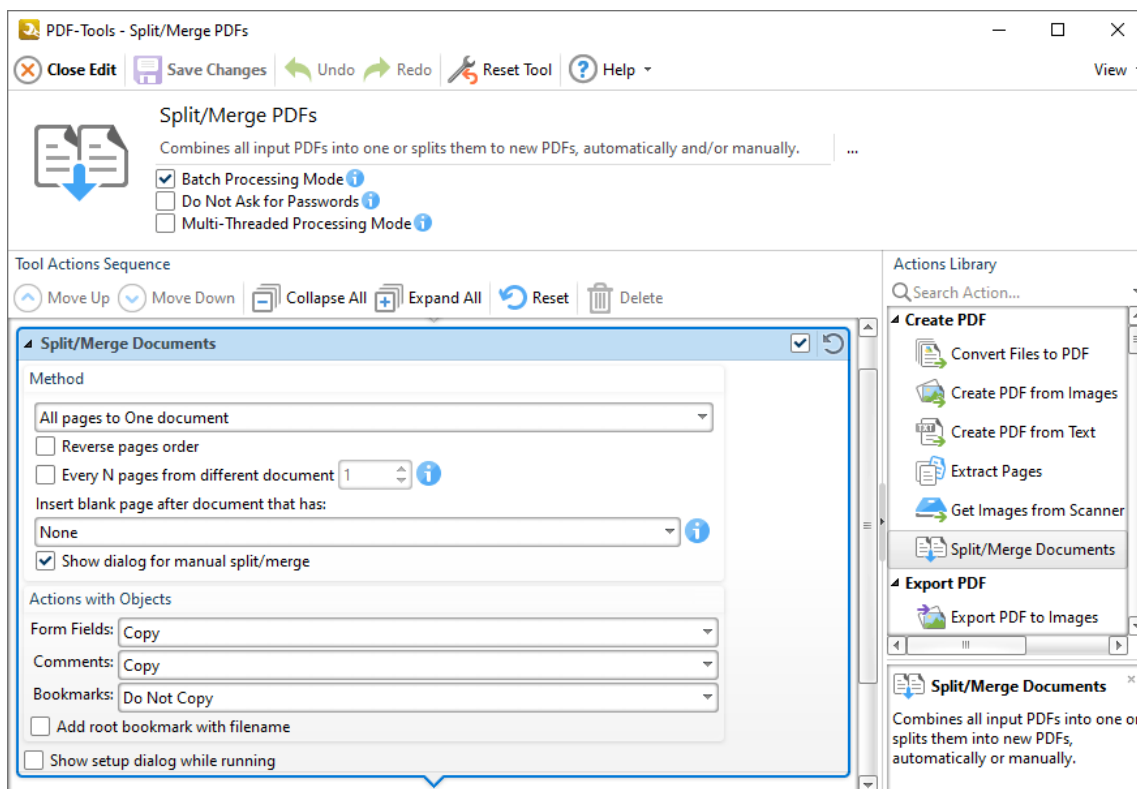

**Figure 1.** Split/Merge Documents Action Options

- Use the **Method** options to determine how pages are split/merged:
  - Select an option in the dropdown menu to determine the split/merge mode:
    - **All pages to One document** merges all input pages into a single document.
    - **Every N pages in Separate document** splits an input document into smaller documents of  $n$  pages. Enter a value for  $n$  in the adjacent number box. For example, if a document of nine pages is selected and the value of  $n$  is three, then three documents of three pages will be created from pages 1-3, 4-6 and 7-9.

- **Keep input document(s) as is** retains the original format of input documents.
- **Split by top bookmarks** splits an input document into smaller documents that are defined by the top-level bookmarks of the input document. If this option is selected then the **Generate document name from** dropdown menu will be displayed. Select an option from the dropdown menu to determine the source of the document name.
- Select the **Reverse pages order** box to reverse the order of pages of input documents.
- Select the **Every N pages from different document** box to interleaf merged documents. Use the adjacent number box to specify the intervals at which interleaving takes place.
- Use the **Insert blank page after document that has:** dropdown menu to insert a blank page into output documents. The options are as follows:
  - Select **None** to disable this feature.
  - Select **Odd Pages Count** to insert a blank page at the end of output documents that have an odd number of pages.
  - Select **Even Pages Count** to insert a blank page at the end of output documents that have an even number of pages.
- Select the **Show dialog for manual split/merge** to open the **Manual Split/Merge Documents** dialog box when the tool runs. This dialog box is used to reorder, add and/or remove pages and to preview output documents.
- Use the **Actions with Objects** options to determine actions for objects in input documents:
  - Select an option in the **Form Fields, Comments** and **Bookmarks** dropdown menus to determine the action taken for these objects.
  - Select the **Add root bookmark with filename** box to add a root bookmark to output documents. The filename of the input file will be used as the bookmark title.
- Select the **Show setup dialog while running** box to launch the **Split/Merge Documents** dialog box and customize settings each time this action is used. Clear this box to disable the **Split/Merge Documents** dialog box from opening each time the action is used, which is useful when the same settings are used consistently.

Click  **Save Changes** to save changes.

---



## 7.2 Export PDF Actions

---



### Export PDF Actions

---

The **Export PDF** actions copy and convert PDF documents and images to alternative formats:

 [Export PDF to Images](#)<sup>[106]</sup> copies PDF documents and converts them to raster images.

 [Export PDF to Microsoft Excel Spreadsheet](#)<sup>[110]</sup> copies PDF documents and converts them to **Microsoft Excel (.xlsx)** format.

 [Export PDF to Microsoft Powerpoint Presentation](#)<sup>[113]</sup> copies PDF documents and converts them to **Microsoft Powerpoint Presentation (\*.pptx)** format.

 [Export PDF to Microsoft Word Document](#)<sup>[117]</sup> copies PDF documents and converts them to **Microsoft Word (.docx)** format.

 [Export PDF to Plain Text](#)<sup>[120]</sup> copies PDF documents and converts them to plain text (\*.txt) format.

 [Extract Images from PDF](#)<sup>[122]</sup> copies images in PDF documents and saves them to file.

 [PDF to Audio](#)<sup>[124]</sup> copies text in PDF documents to audio file format.

---

## 7.2.1 Export PDF to Images



The **Export PDF to Images** action copies PDF documents and converts them to raster images. It contains the following customizable parameters:

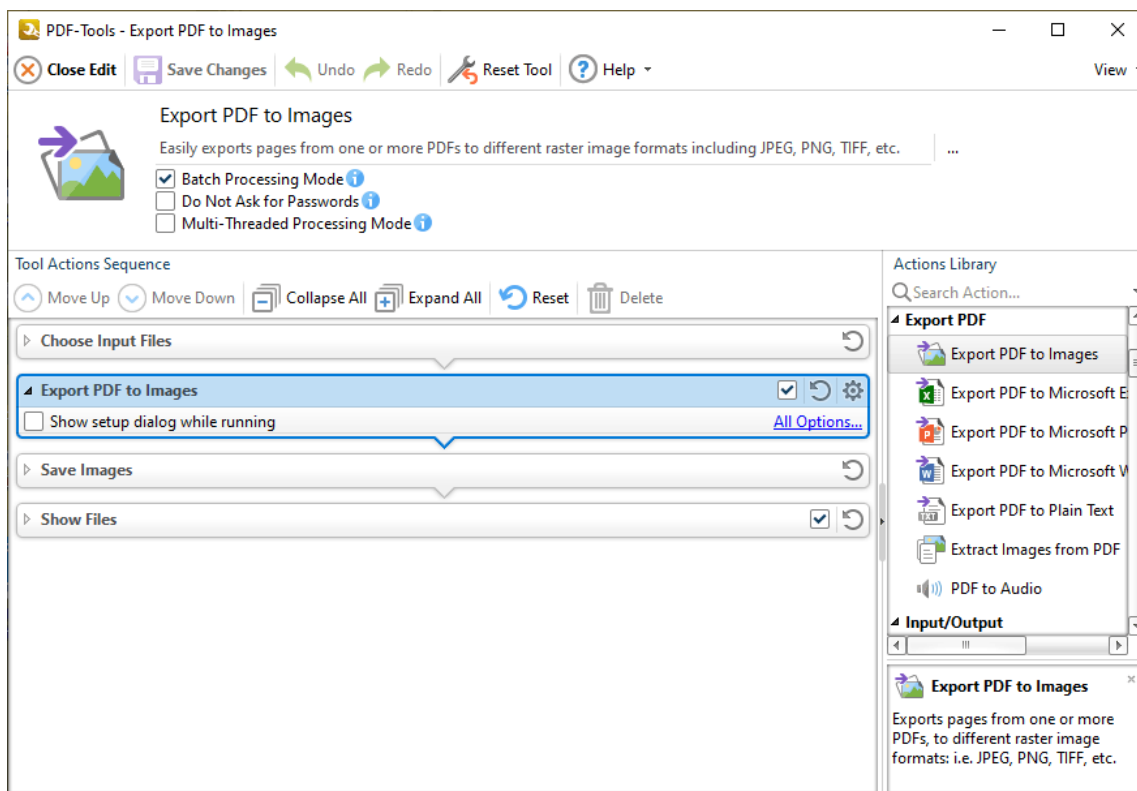

**Figure 1.** Export PDF to Images Action Options

- Click **All Options** to determine conversion options for extracted pages. The **Export to Images** dialog box will open, as detailed below.
- Select the **Show setup dialog while running** box to launch the **Export to Images** dialog box and customize settings each time this action is used. Clear this box to disable the **Export to Images** dialog box from opening each time the action is used, which is useful when the same settings are used consistently.

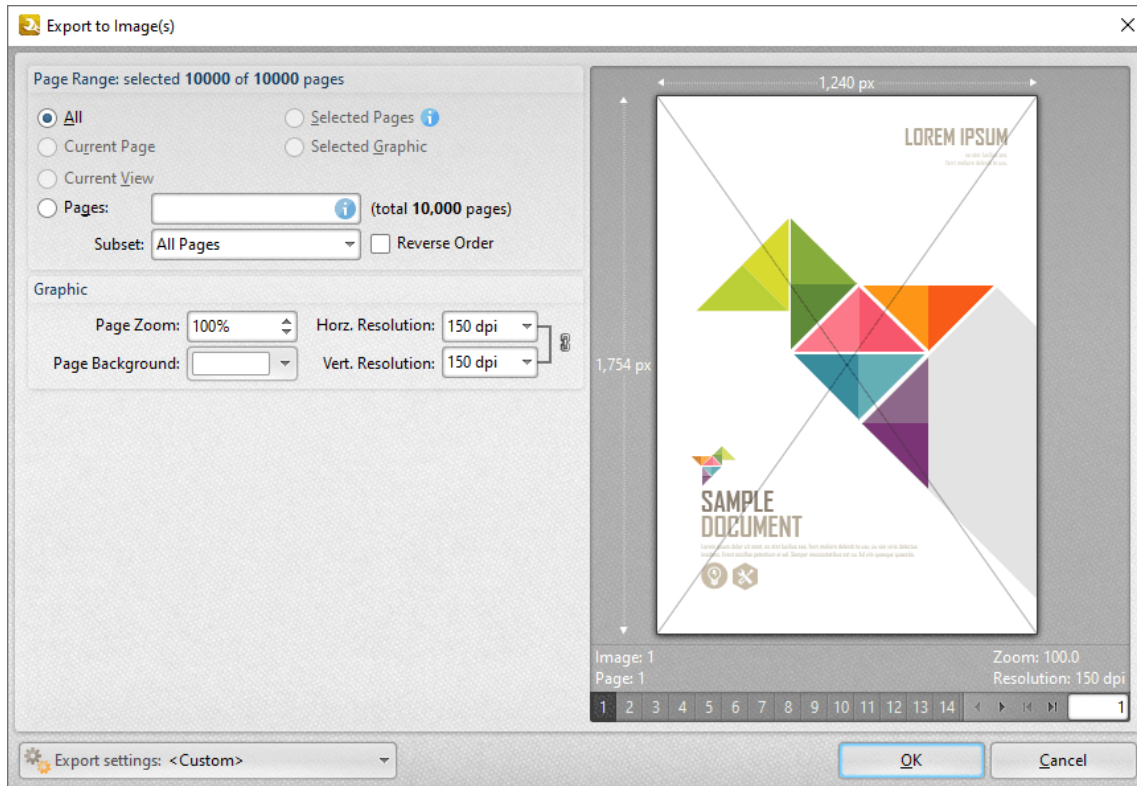

Figure 2. Export to Images Dialog Box

- Use the **Page Range** options to determine the page range from which to export pages to image format. Further information on page range options is available [here](#). Please note that the **Current Page**, **Current View**, **Selected Page** and **Selected View** options are not yet available. They will be available in a future build of **PDF-Tools**.
- Use the **Graphics** options to determine settings for exported graphics:
  - Use the **Page Zoom** number box to determine the level of zoom used when pages are exported.
  - Use the **Page Background** dropdown menu to determine the background color of exported pages.
  - Use the **Resolution** number boxes to determine the horizontal and vertical resolution of exported pages.
- Use the **Export Settings** dropdown menu to save/manage/delete custom profiles:

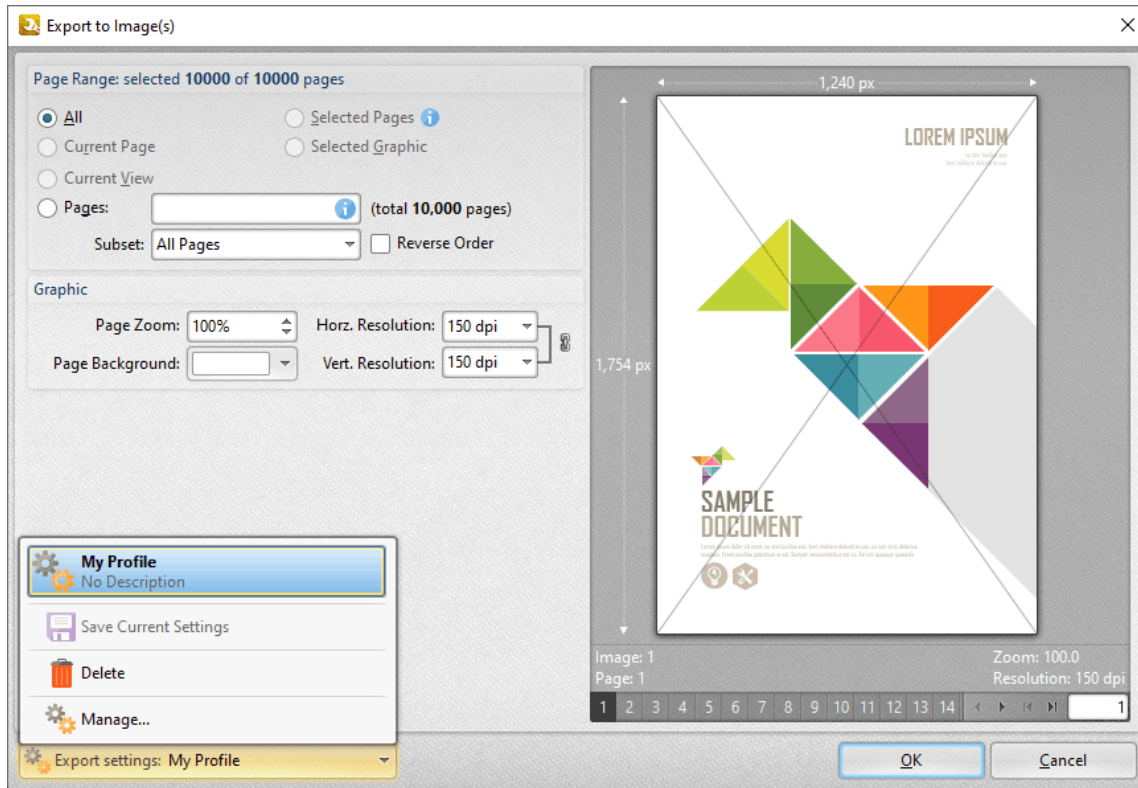

Figure 3. Export to Images Dialog Box, Custom Profiles

- Click **Save Current Settings** to save custom settings for subsequent use. Saved profiles are detailed in the **Export Settings** dropdown menu.
- Click **Delete** to delete selected profiles.
- Click **Manage** to manage saved custom settings. The **Manage Presets** dialog box will open, as detailed below.

Click **OK** to save changes.

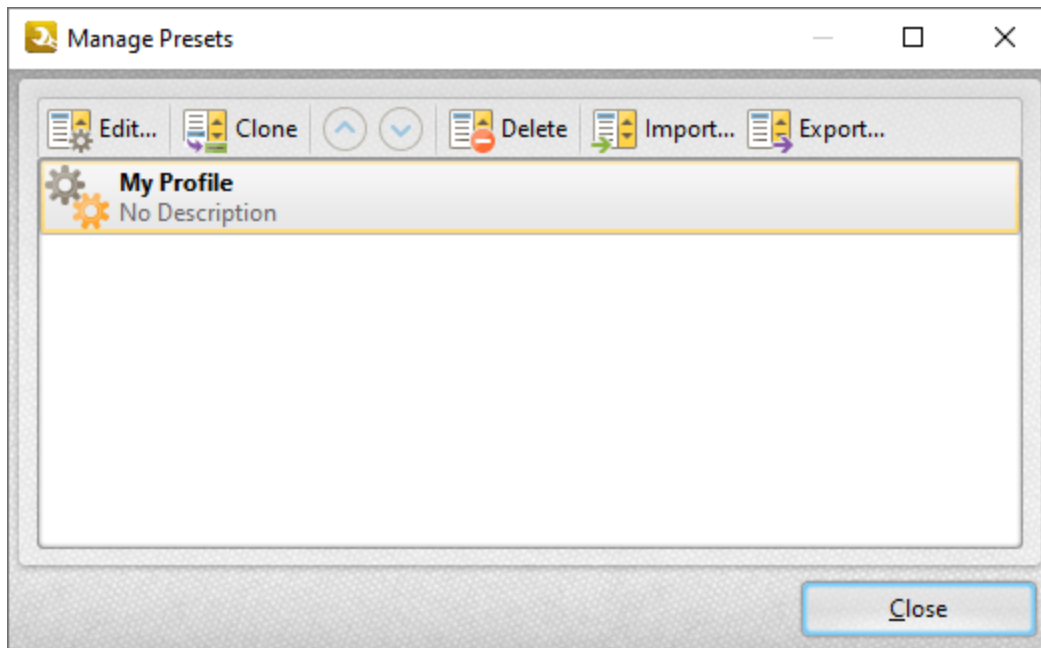

Figure 4. Manage Presets Dialog Box

- Click **Edit** to edit selected profiles.
  - Click **Clone** to clone selected profiles. This makes it possible to duplicate profiles and then customize their settings whilst retaining the existing profile and its parameters.
  - Use the up and down arrow to move selected profiles up or down in the list.
  - Click **Delete** to delete selected profiles.
  - Click **Import** to import profiles from a saved file.
  - Click **Export** to export profiles to file.
-

## 7.2.2 Export PDF to Microsoft Excel Spreadsheet



### Export PDF to Microsoft Excel Spreadsheet

The **Export PDF to Microsoft Excel Spreadsheet** action copies PDF documents and converts them to **Microsoft Excel (\*.xlsx)** format. Please note that it is necessary to have **Microsoft Office** installed on the local computer for this action to operate. It contains the following customizable parameters:

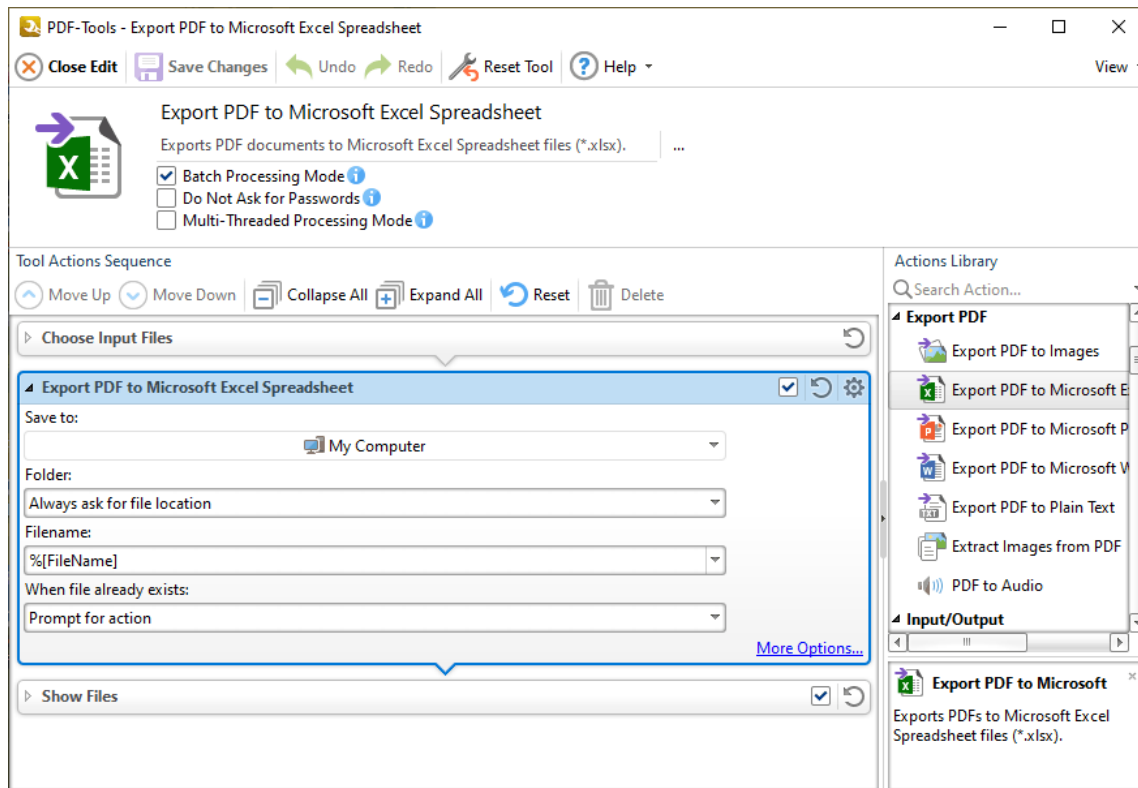

**Figure 1.** Export PDF to Microsoft Excel Spreadsheet Action Options

- Use the **Save to** dropdown menu to determine where output files are saved:
  - Click **My Computer** to save files to the local computer.
  - Hover over **Add Place** to add a new place at which to save files, then click **Box.com**, **Dropbox**, **Google Drive**, **OneDrive** or **Sharepoint** to add accounts from these locations. **PDF-Tools** will prompt for the login information for the selected account. When this information has been entered, the account will be detailed in the list and can be used to save files as desired.
- Use the **Folder** dropdown menu to determine where converted files are saved:

- **Always ask for file location** prompts the user to select a location each time the action is used.
- **Use source folder as destination** uses the source folder of input files as the save location.
- **Use custom folder specified** enables the user to specify a folder. If this option is used then the folder location must be specified in the text box beneath the dropdown menu.
- Use the **Filename** text box to name output files. The default name is defined by the macro **%[Filename]**, which uses the name of the source file. Click the dropdown arrow to add additional [macros](#).<sup>[488]</sup>
- Use the **When File Already Exists** dropdown menu to determine the action taken when filenames are already in use:
  - **Prompt for action** prompts the user for an action to take.
  - **Overwrite with a new file** overwrites the existing file with the new file.
  - **Keep existing file unchanged** retains the existing file and does not save the new file.
  - **Save new with other unique name** inserts a prefix to the filename and then saves the new file.
- Click **More Options** for further options:

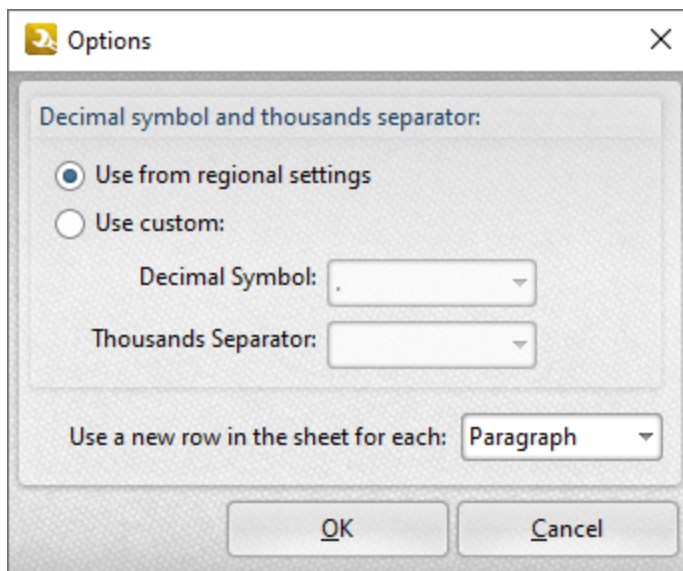

Figure 2. Options Dialog Box

These options determine the symbols used as decimal points and to delineate thousands in numerical values of one thousand or more:

- Select **Use from regional settings** to use the settings of the local region.
- Select **Use custom** to set these symbols manually, then use the dropdown menus to select symbols.

- Select either **Paragraph** or **Line** in the lower dropdown menu to determine how rows are created in output (**\*.xlsx**) documents. If **Paragraph** is selected then each paragraph in the source PDF file is converted to a new row in the output (**\*.xlsx**) document. If **Line** is selected then each line in the source PDF file is converted to a new row in the output (**\*.xlsx**) document.

Click **OK** to save changes.

---



## 7.2.3 Export PDF to Microsoft PowerPoint Presentation



### Export PDF to Microsoft Powerpoint Presentation

The **Export PDF to Microsoft Powerpoint Presentation** action copies PDF documents and converts them to **Microsoft Powerpoint Presentation (\*.pptx)** format. Please note that it is necessary to have **Microsoft Office** installed on the local computer for this action to operate. It contains the following customizable parameters:

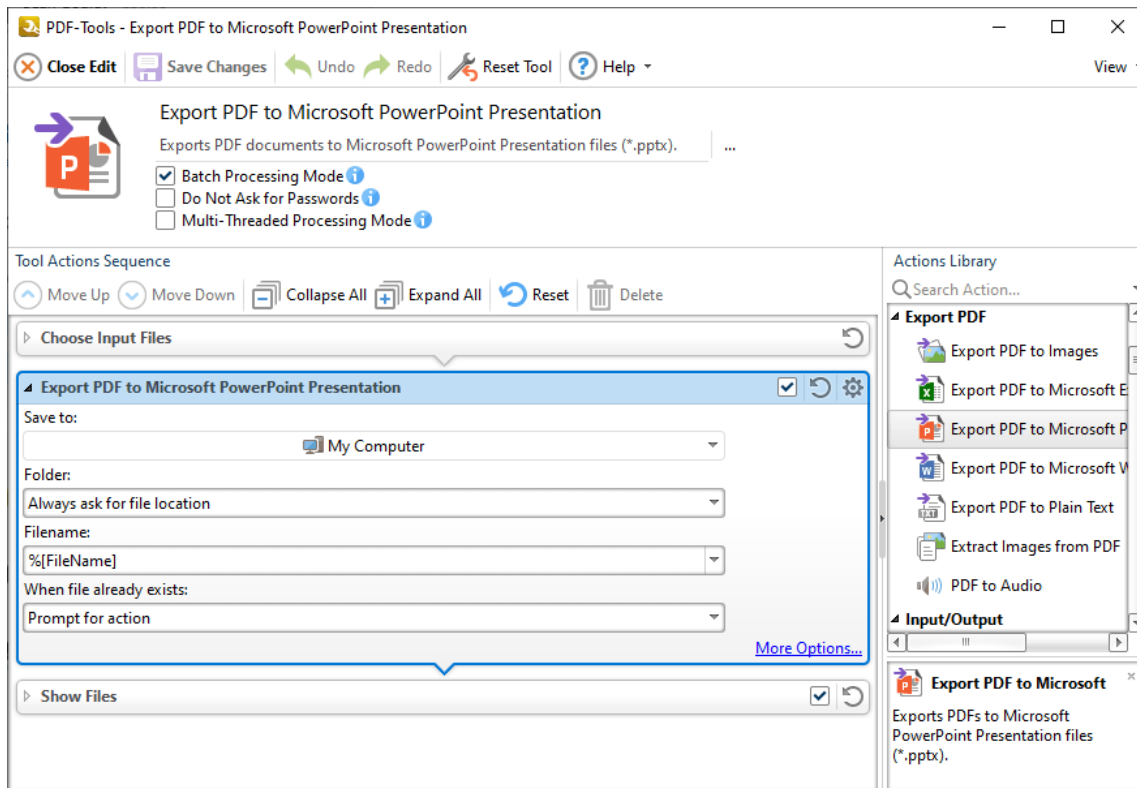

Figure 1. Export PDF to Microsoft Powerpoint Presentation Action Options

- Use the **Save to** dropdown menu to determine where output files are saved:
  - Click **My Computer** to save files to the local computer.
  - Hover over **Add Place** to add a new place at which to save files, then click **Box.com**, **Dropbox**, **Google Drive**, **OneDrive** or **Sharepoint** to add accounts from these locations. **PDF-Tools** will prompt for the login information for the selected account. When this information has been entered, the account will be detailed in the list and can be used to save files as desired.
- Use the **Folder** dropdown menu to determine where converted files are saved:

- **Always ask for file location** prompts the user to select a location each time the action is used.
- **Use source folder as destination** uses the source folder of input files as the save location.
- **Use custom folder specified** enables the user to specify a folder. If this option is used then the folder location must be specified in the text box beneath the dropdown menu.
- Use the **Filename** text box to name output files. The default name is defined by the macro **%[Filename]**, which uses the name of the source file. Click the dropdown arrow to add additional [macros](#).<sup>[488]</sup>
- Use the **When File Already Exists** dropdown menu to determine the action taken when filenames are already in use:
  - **Prompt for action** prompts the user for an action to take.
  - **Overwrite with a new file** overwrites the existing file with the new file.
  - **Keep existing file unchanged** retains the existing file and does not save the new file.
  - **Save new with other unique name** inserts a prefix to the filename and then saves the new file.
- Click **More Options** for further options:

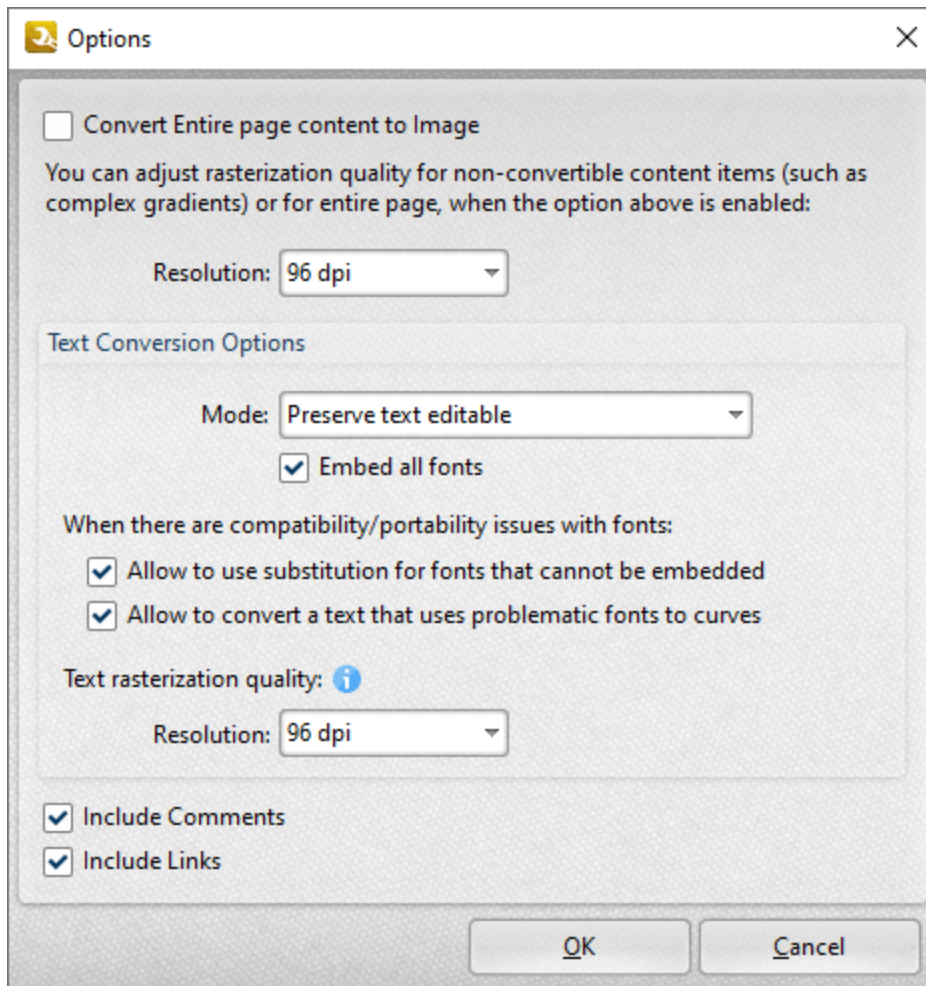

Figure 2. Options Dialog Box

- Select the **Convert Entire page content to image** box to convert all page content into image format in output documents.
- Use the **Resolution** dropdown menu to determine the resolution of output documents.
- Use the **Text Conversion Options** determine how text is converted:
  - Use the **Mode** dropdown menu to determine the text conversion mode:
    - Select **Preserve text editable** to preserve the existing format of text and retain the option of editing text in output documents.
    - Select **Convert to curves** to convert text into vector curves. Please note that curves cannot be edited.
    - Select **Convert to images** to convert text into image format.
  - Select the **Embed all fonts** box to embed all fonts in converted documents. (This increases the file size but ensures compatibility on all machines).
  - Select the **Allow to use substitution for fonts that cannot be embedded** box to enable the use of substitute fonts in cases where fonts cannot be embedded.

- Select the **Allow to convert a text that uses problematic fonts to curves** box to enable the conversion of problematic fonts into curves.
- Use the **Resolution** dropdown menu to determine the rasterization resolution of converted text. Text will be rasterized in cases where it cannot be converted with the specified **Text Conversion Options**.
- Select the **Include Comments** and/or **Include Links** boxes to include comments and/or links when files are converted.

Click **OK** to save changes.

---

## 7.2.4 Export PDF to Microsoft Word Document



### Export PDF to Microsoft Word Document

The **Export PDF to Microsoft Powerpoint Word Document** action copies PDF documents and converts them to **Microsoft Word Document (\*.docx)** format. Please note that it is necessary to have **Microsoft Office** installed on the local computer for this action to operate, and files exported to **(\*.docx)** format are compatible with **MS Word 2010** and later. This action contains the following customizable parameters:

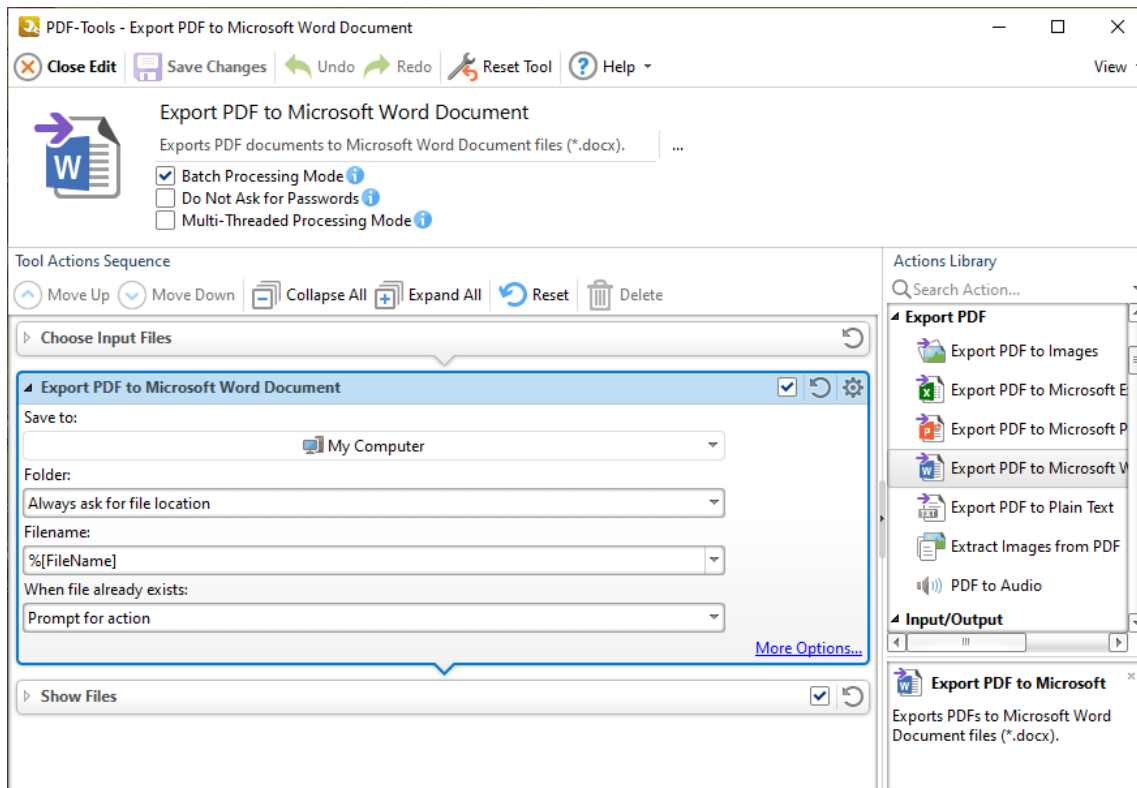

**Figure 1.** Export PDF to Microsoft Word Document Action Options

- Use the **Save to** dropdown menu to determine where output files are saved:
  - Click **My Computer** to save files to the local computer.
  - Hover over **Add Place** to add a new place at which to save files, then click **Box.com, Dropbox, Google Drive, OneDrive** or **Sharepoint** to add accounts from these locations. **PDF-Tools** will prompt for the login information for the selected account. When this information has been entered, the account will be detailed in the list and can be used to save files as desired.

- Use the **Folder** dropdown menu to determine where converted files are saved:
  - **Always ask for file location** prompts the user to select a location each time the action is used.
  - **Use source folder as destination** uses the source folder of input files as the save location.
  - **Use custom folder specified** enables the user to specify a folder. If this option is used then the folder location must be specified in the text box beneath the dropdown menu.
- Use the **Filename** text box to name output files. The default name is defined by the macro **%[Filename]**, which uses the name of the source file. Click the dropdown arrow to add additional [macros](#).<sup>[488]</sup>
- Use the **When File Already Exists** dropdown menu to determine the action taken when filenames are already in use:
  - **Prompt for action** prompts the user for an action to take.
  - **Overwrite with a new file** overwrites the existing file with the new file.
  - **Keep existing file unchanged** retains the existing file and does not save the new file.
  - **Save new with other unique name** inserts a prefix to the filename and then saves the new file.
- Click **More Options** for further options:

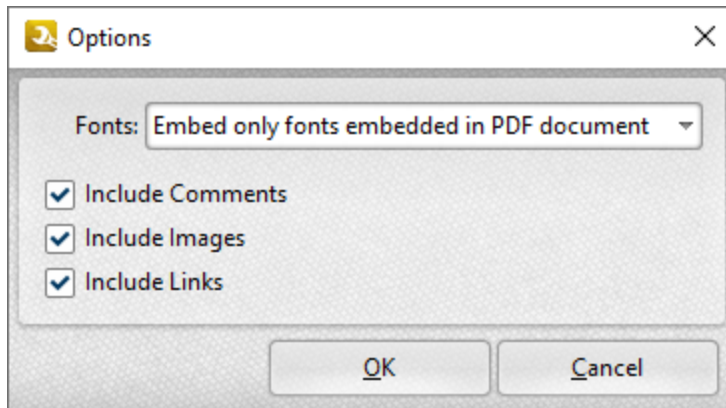

Figure 2. Options Dialog Box

- Use the **Fonts** dropdown menu to determine embedding options for fonts in output documents:
  - Select **Embed only fonts embedded in PDF document** to embed the embedded fonts of source documents in output documents.
  - Select **No Embed** to exclude font embedding in output documents.
- Select/clear the **Include Comments** box to include/exclude comments in the conversion process.
- Select/clear the **Include Images** box to include/exclude images in the conversion process.

- Select/clear the **Include Links** box to include/exclude links in the conversion process.

Click **OK** to save changes.

---

## 7.2.5 Export PDF to Plain Text



### Export PDF to Plain Text

The **Export PDF to Plain Text** action copies PDF documents and converts them to plain text (\*.txt) format. It contains the following customizable parameters:

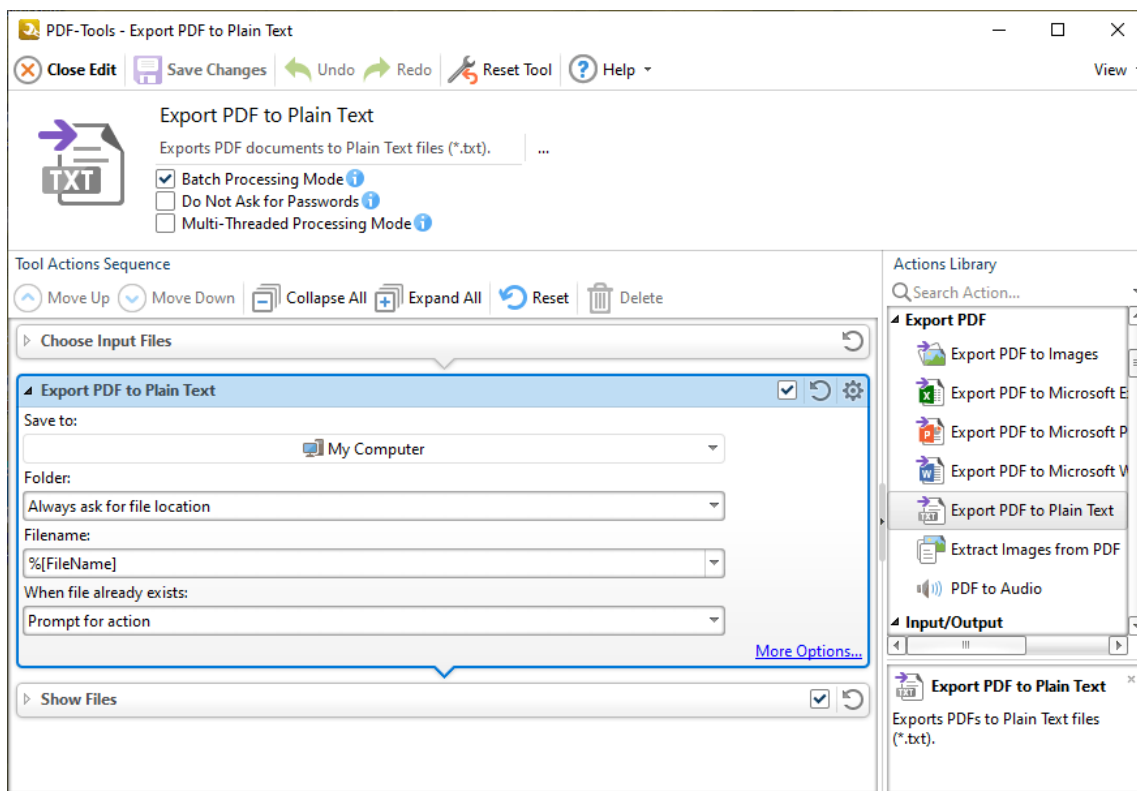

Figure 1. Export PDF to Plain Text Action Options

- Use the **Save to** dropdown menu to determine where output files are saved:
  - Click **My Computer** to save files to the local computer.
  - Hover over **Add Place** to add a new place at which to save files, then click **Box.com, Dropbox, Google Drive, OneDrive** or **Sharepoint** to add accounts from these locations. **PDF-Tools** will prompt for the login information for the selected account. When this information has been entered, the account will be detailed in the list and can be used to save files as desired.
- Use the **Folder** dropdown menu to determine where converted files are saved:
  - **Always ask for file location** prompts the user to select a location each time the action is used.



- **Use source folder as destination** uses the source folder of input files as the save location.
- **Use custom folder specified** enables the user to specify a folder. If this option is used then the folder location must be specified in the text box beneath the dropdown menu.
- Use the **Filename** text box to name output files. The default name is defined by the macro **%[Filename]**, which uses the name of the source file. Click the dropdown arrow to add additional [macros](#).<sup>[488]</sup>
- Use the **When File Already Exists** dropdown menu to determine the action taken when filenames are already in use:
  - **Prompt for action** prompts the user for an action to take.
  - **Overwrite with a new file** overwrites the existing file with the new file.
  - **Keep existing file unchanged** retains the existing file and does not save the new file.
  - **Save new with other unique name** inserts a prefix to the filename and then saves the new file.
- Click **More Options** for further options:

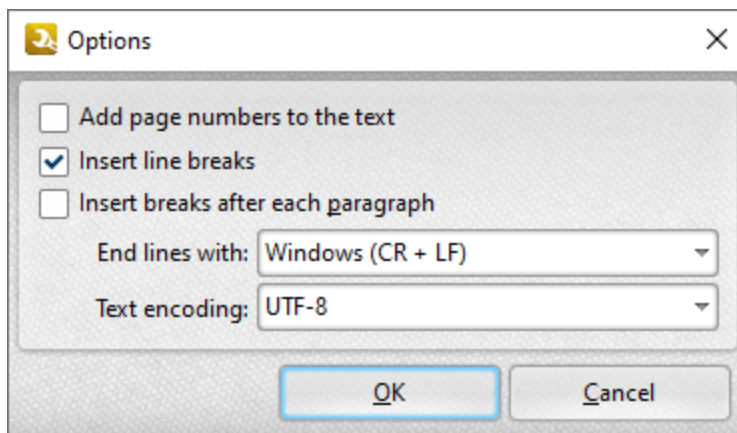

Figure 2. Options Dialog Box

- Select the **Add page numbers to the text** and/or **Insert line breaks** boxes as desired.
- Select an option from the **End lines with** dropdown menu to determine the newline character. Further information on newline characters is available [here](#).
- Select an option from the **Text encoding** dropdown menu to determine the text encoding format.

Click **OK** to save changes.

## 7.2.6 Extract Images from PDF



### Extract Images from PDF

The **Extract Images from PDF** action copies images from PDF documents and saves them to file. It contains the following customizable parameters:

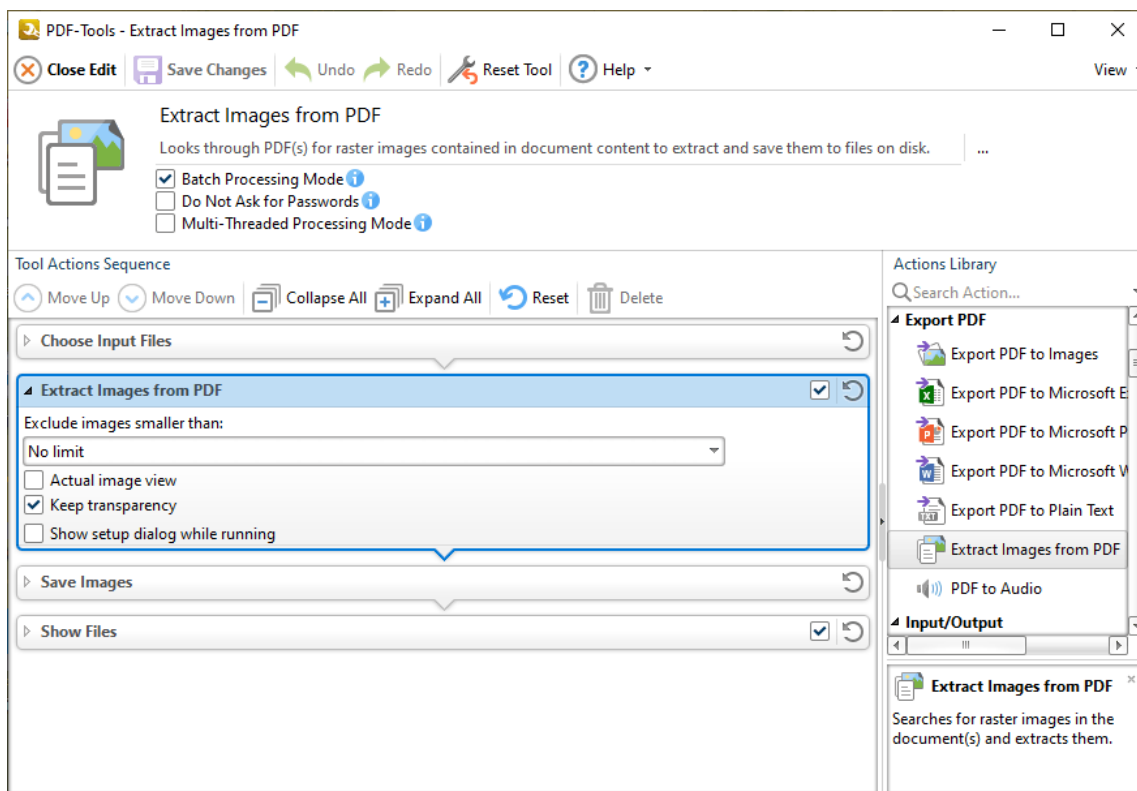

Figure 1. Extract Images from PDF Action Options

- Use the **Exclude images smaller than** dropdown menu to set a minimum size for extracted images, or enter a custom size in the text box.
- Select the **Actual image view** box to save images as they appear in the original document.
- Select the **Keep Transparency** box to retain transparency in images.
- Select the **Show setup dialog while running** box to launch the **Extract Images from PDF** dialog box and customize settings each time this action is used. Clear this box to disable the **Extract Images from PDF** dialog box from opening each time the action is used, which is useful when the same settings are used consistently.

Click  **Save Changes** to save changes.

---

## 7.2.7 PDF to Audio



### PDF to Audio

The **PDF to Audio** action copies text in PDF documents to audio file format. It contains the following customizable parameters:

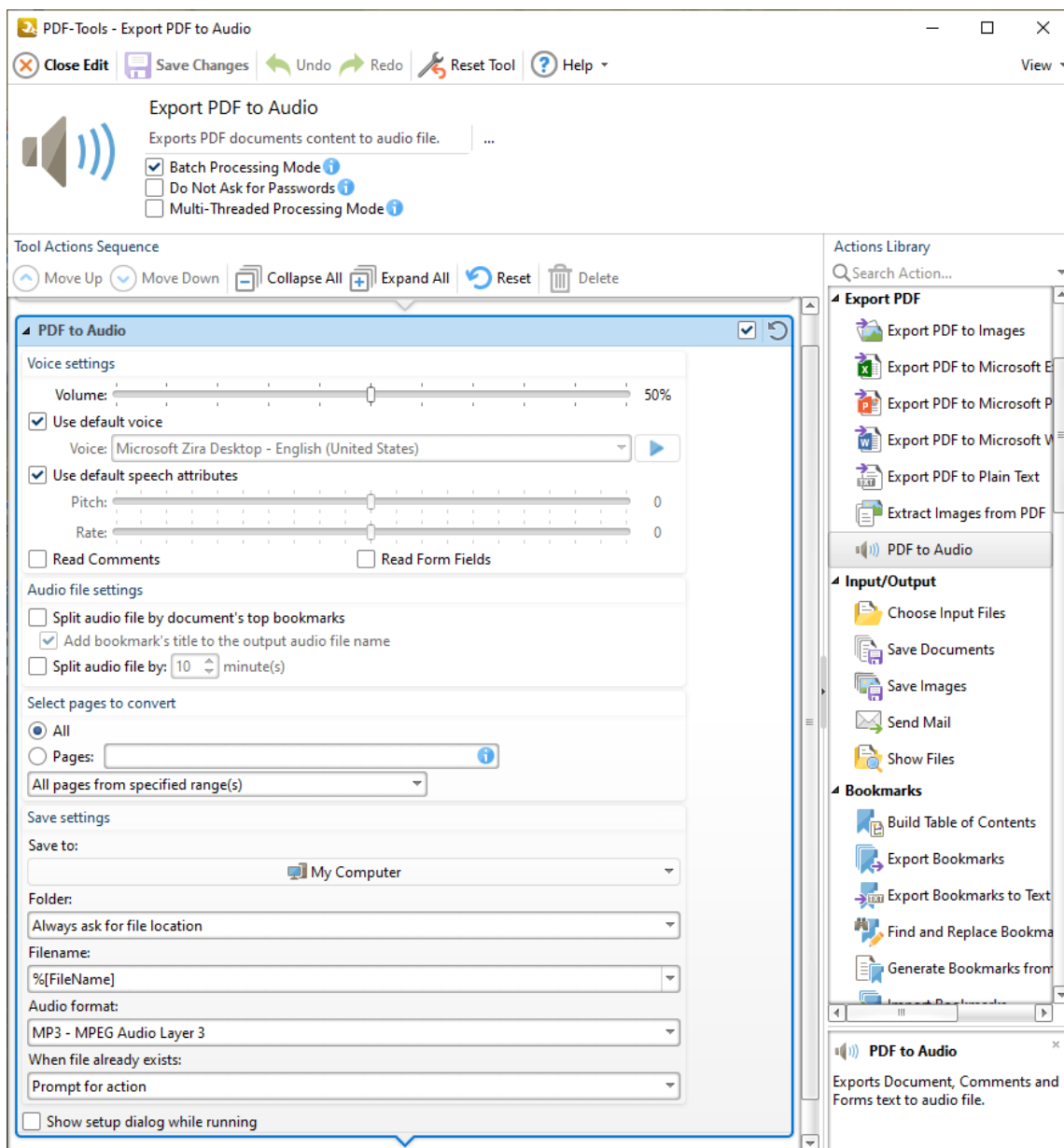

Figure 1. Export PDF to Audio Action Options

- Use the **Volume** slider to determine the volume of the voice used in the audio file.
- If you do not want to use the default voice for the audio file, then clear the **Use default voice** box and select an alternative voice in the dropdown menu.
- Use the **Pitch** and **Rate** sliders to determine the pitch and speed of the voice used in the audio file.
- Select the **Read Comments** and/or **Read Form Fields** box to include the text of comments and form fields in the audio file. Text from comments and form fields is placed at the end of the audio file recording.
- Select the **Split audio file by document's top bookmarks** to split input documents into output documents according to the top bookmarks of the input document.
- Select the **Split audio file by** box to split input documents into output documents of the length specified in the dropdown menu. The default length is ten minutes. Use the dropdown menu to specify an alternative length as desired.
- Select **All** to convert the text from all pages.
- Select **Pages** to specify a page range for conversion. Information on how to specify page ranges is available [here](#).<sup>[552]</sup>
- Use the **Save to** dropdown menu to determine where output files are saved:
  - Click **My Computer** to save files to the local computer.
  - Hover over **Add Place** to add a new place at which to save files, then click **Box.com, Dropbox, Google Drive, OneDrive or Sharepoint** to add accounts from these locations. **PDF-Tools** will prompt for the login information for the selected account. When this information has been entered, the account will be detailed in the list and can be used to save files as desired.
- Use the **Folder** dropdown menu to determine where converted files are saved:
  - **Always ask for file location** prompts the user to select a location each time the action is used.
  - **Use source folder as destination** uses the source folder of input files as the save location.
  - **Use custom folder specified** enables the user to specify a folder. If this option is used then the folder location must be specified in the text box beneath the dropdown menu.
- Use the **Filename** text box to name output files. The default name is defined by the macro **%[Filename]**, which uses the name of the source file. Click the dropdown arrow to add additional [macros](#).<sup>[488]</sup>
- Use the **Audio format** dropdown menu to determine the format of the audio file.
- Use the **When File Already Exists** dropdown menu to determine the action taken when filenames are already in use:
  - **Prompt for action** prompts the user for an action to take.
  - **Overwrite with a new file** overwrites the existing file with the new file.
  - **Keep existing file unchanged** retains the existing file and does not save the new file.

- **Save new with other unique name** inserts a prefix to the filename and then saves the new file.
- Select the **Show setup dialog while running** box to launch the **PDF to Audio** dialog box and customize settings each time this action is used. Clear this box to disable the **PDF to Audio** dialog box from opening each time the action is used, which is useful when the same settings are used consistently.

Click  **Save Changes** to save changes.

Note that it is necessary to have **Media Foundation** installed on the local machine for this action to operate, as detailed [here](#).<sup>550</sup>

---

## 7.3 Input/Output Actions

---





### Input/Output Actions

---

The **Input/Output** actions determine parameters for the input/output process when tools run:

 [Choose Input Files](#)<sup>[128]</sup> prompts the user to select input files to use in conjunction with other tool actions.

 [Save Documents](#)<sup>[135]</sup> determines the save options for output documents.

 [Save Images](#)<sup>[137]</sup> determines the save options for output images.

 [Send Mail](#)<sup>[140]</sup> sends output documents/images via the user's desktop email client.

 [Show Files](#)<sup>[142]</sup> displays output documents.

---

## 7.3.1 Choose Input Files



### Choose Input Files

The **Choose Input Files** action sources files for use in conjunction with other actions in **PDF-Tools**. It contains the following customizable parameters:

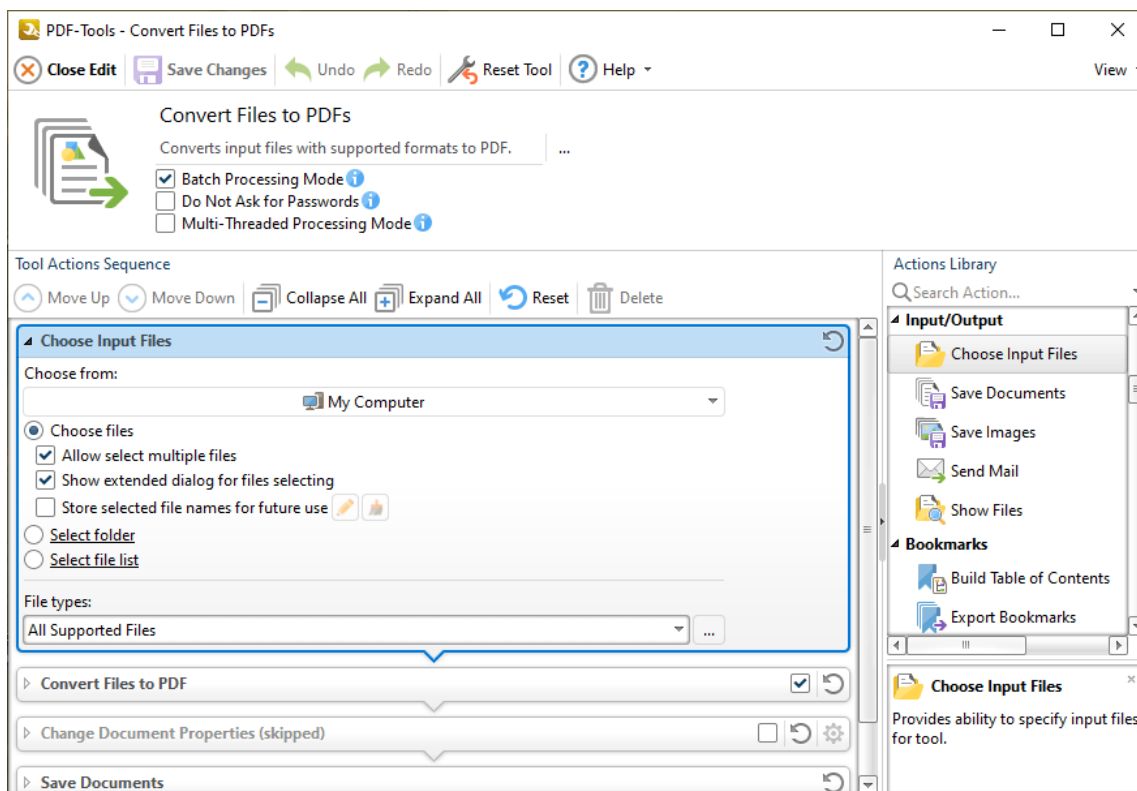



Figure 1. Choose Input Files Action Options

- Use the **Choose From** dropdown menu to determine where source files are taken from:
  - Click **My Computer** to use files from the local computer.
  - Hover over **Add Place** to add a new place from which to take files, then click **Box.com, Dropbox, Google Drive, OneDrive** or **Sharepoint** to add accounts from these locations. **PDF-Tools** will prompt for the login information for the selected account. When this information has been entered, the account will be detailed in the list and can be used to source files as desired.
- Select **Choose files** to source individual input files. If this option is selected then the following options are available:



- Select the **Allow select multiple files** box to enable the selection of multiple files.
- Select the **Show extended dialog for files selecting** box to launch the **Choose Input Files** dialog box each time this action is used. The **Choose Input Files** dialog box is detailed in *(figure 4)*. It is used to view, edit and reorder input files. Clear the **Allow extended dialog for files selecting** box to disable the launching of the **Choose Input File** dialog box each time this action is used.
- Select the **Store selected file names for future use** box to create a record of the input files used next time the tool runs. These files will be added automatically on subsequent runs of the tool. Click the pencil icon to view/edit stored files, or the brush icon to remove stored files. Note that if this option has been used to store files for subsequent use then it is not possible to select different files for use with the tool.
- Select **Select folder** to source all files from one folder to use as input files. Parameters for this setting are detailed in *(figure 3)*.
- Select **Select file list** to source files from a list of files. Note that files must saved with the extension **(\* .pdftf)** to be compatible with this option. List files can be created in text editors such as **Microsoft Notepad**, and should contain only a list of source files, as detailed in *(figure 2)* below.
- Select an option in the **File types** dropdown menu to determine the permitted file types for the **Choose Input Files** action. Click the ellipsis icon to view/edit [Available File Filters](#).

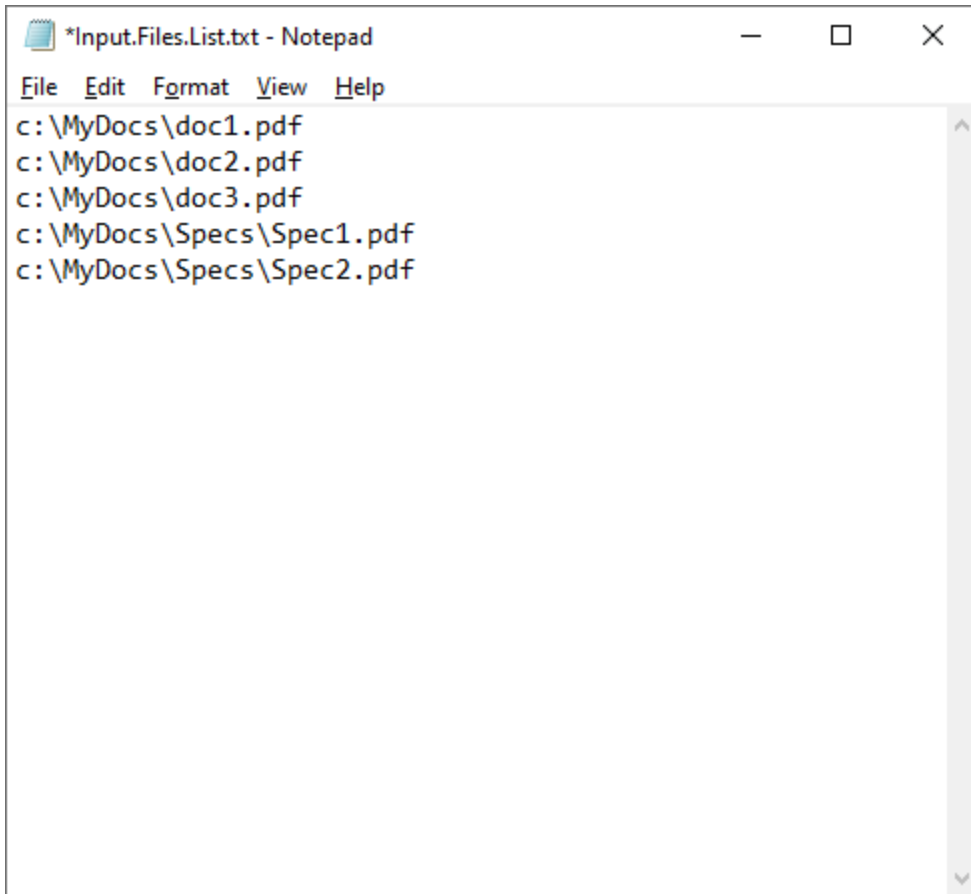

Figure 2. Sample List File

## Select Folder Options

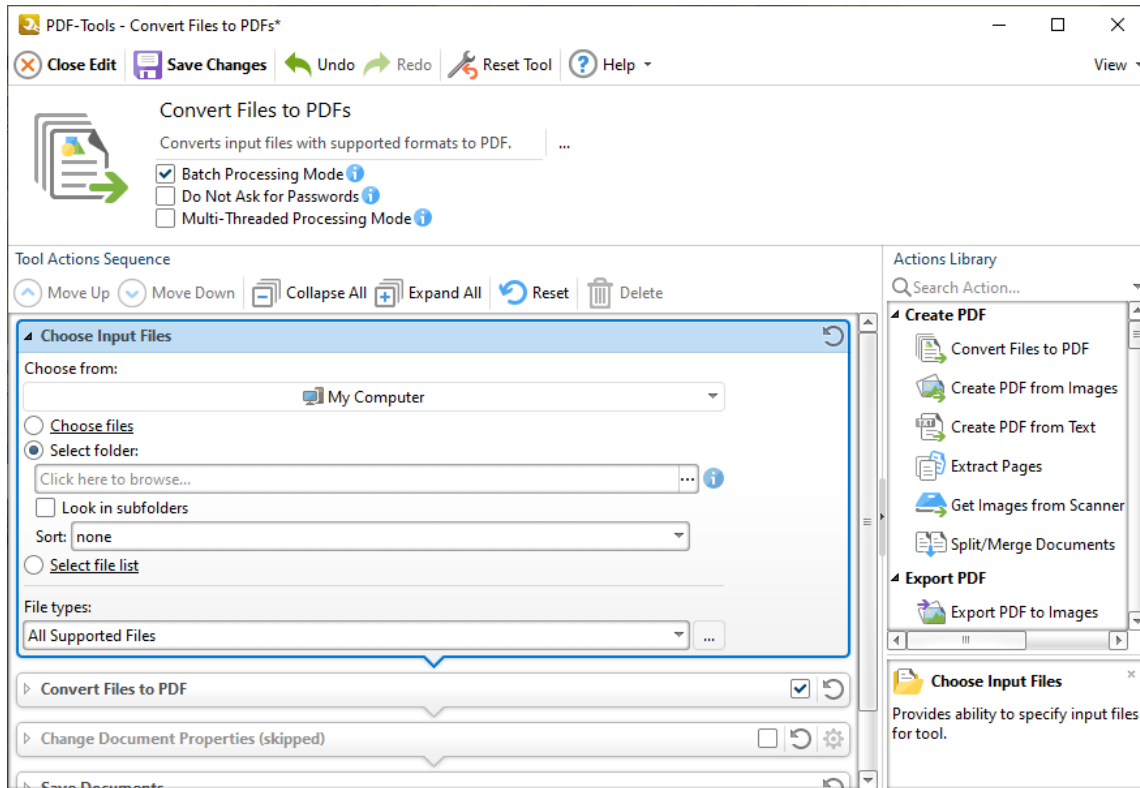

Figure 3. Select Folder Options

- Click the text box or the ellipsis icon to select a folder.
- Select the **Look in subfolders** box to include files located in subfolders.
- Select an option in the **Sort** dropdown menu to determine the order in which input files are processed.

## Choose Input Files

The **Choose Input Files** dialog box is used to view, edit and reorder input files:

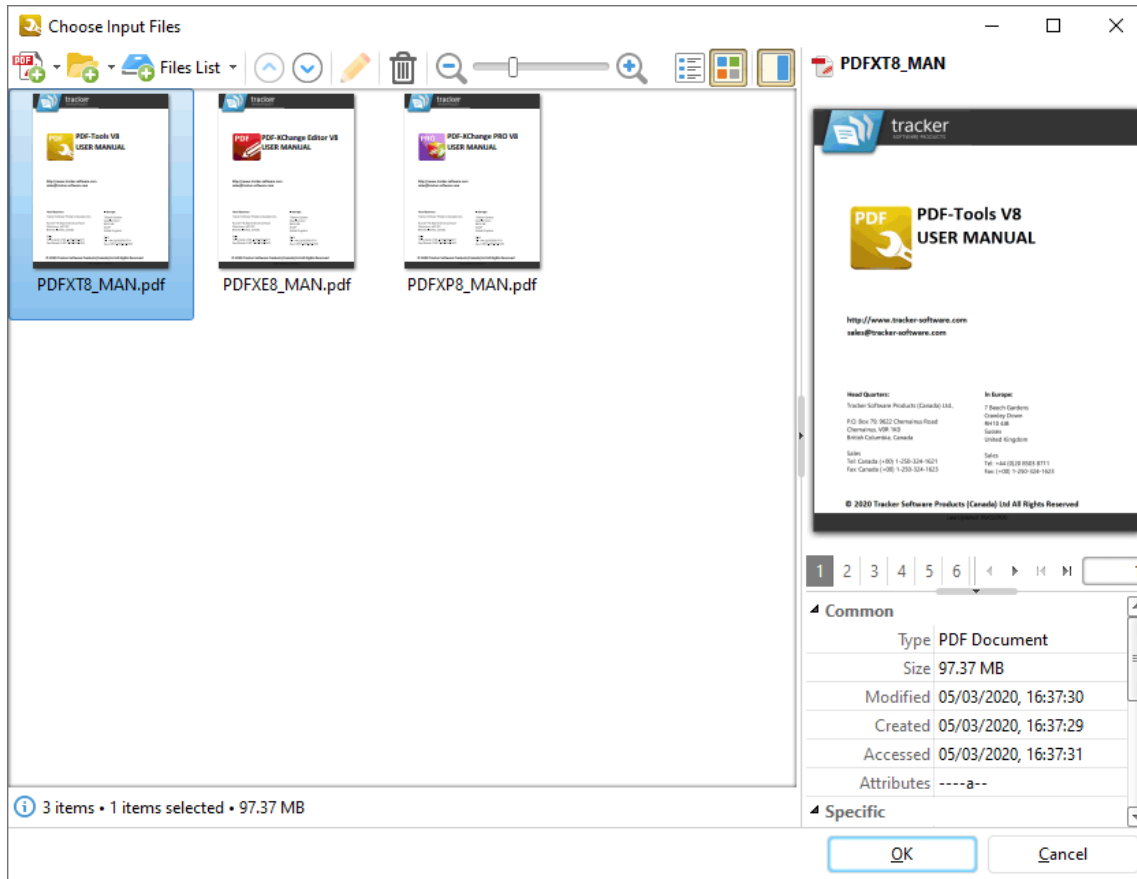





Figure 4. Choose Input Files Dialog Box

Use the icons as follows:

- Click **Add Files** to add files from the local computer.
- Click **Add Folder** to add all files from a specified folder.
- Click **Add From Scanner** to add input files via a scanner. The **Scan Properties** dialog box will open, which is used to determine scanning parameters. Further information on this dialog box is available [here](#).<sup>99</sup>
- Click **Move Up** to move selected files up in the order of processing.
- Click **Move Down** to move selected files down in the order of processing.
- Click **Edit** to edit selected image files. The **Edit Image** dialog box will open. This dialog box is detailed in (figure 5).
- Click **Zoom Out** or **Zoom In**, or use the slider, to zoom out from/in on page thumbnails.
- Click **Delete** to remove selected files from the dialog box.

- Click  **Details** to view the details of files added to the dialog box. Alternatively, click  **Thumbnails** to view files as thumbnails.
- Click  **Preview** to view a post-conversion preview of selected files, which will display on the right of the dialog box, as detailed in **(figure 4)**.

Click **OK** to proceed with the tool operation.





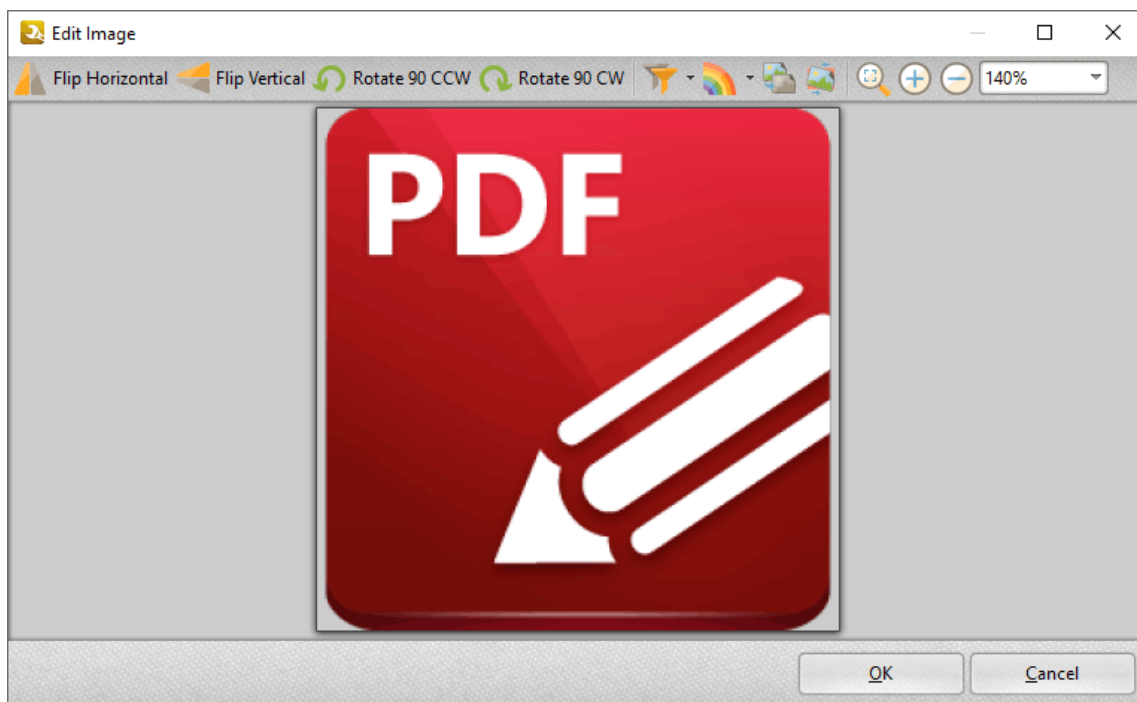

## Edit Image





The **Edit Image** dialog box is used to edit images before they are processed by tools:



**Figure 5.** Edit Image Dialog Box

Use the icons as follows:

- Click  **Flip Horizontal** to flip images horizontally.
- Click  **Flip Vertical** to flip images vertically.
- Click  **Rotate 90 CCW** to rotate images ninety degrees counter-clockwise.
- Click  **Rotate 90 CW** to rotate images ninety degrees clockwise.
- Click  the **Apply Filter** dropdown menu to view/select filters for images.
- Click  the **Convert to** dropdown menu to view/select color depths for images.
- Click  **Grayscale** to convert images to grayscale format.

- Click  **Deskew** to deskew images. Deskewing is used to straighten the edges of images that have been scanned/photographed crookedly.
- Click  **Fit Visible** to fit images to the border of the editing pane.
- Click  the **Zoom In** or  **Zoom Out** button to zoom in on/out from images, or use the number box to adjust the zoom level manually.

Click **OK** to save changes and proceed with the tool operation.

---

## 7.3.2 Save Documents



### Save Documents

The **Save Documents** action determines the save options for output documents. It contains the following customizable parameters:

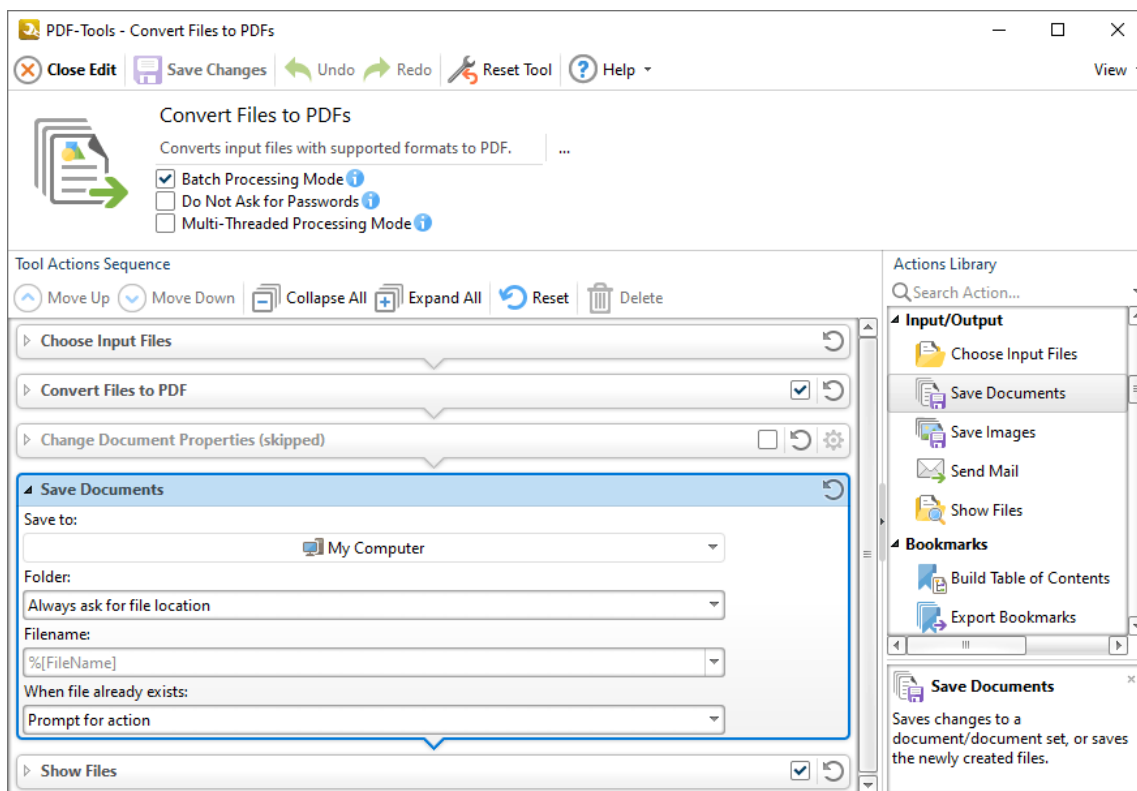

Figure 1. Save Documents Action Options

- Use the **Save to** dropdown menu to determine where output files are saved:
  - Click **My Computer** to save files to the local computer.
  - Hover over **Add Place** to add a new place at which to save files, then click **Box.com, Dropbox, Google Drive, OneDrive** or **Sharepoint** to add accounts from these locations. **PDF-Tools** will prompt for the login information for the selected account. When this information has been entered, the account will be detailed in the list and can be used to save files as desired.
- Use the **Folder** dropdown menu to determine where converted files are saved:
  - **Always ask for file location** prompts the user to select a location each time the action is used.

- **Use source folder as destination** uses the source folder of input files as the save location.
- **Use custom folder specified** enables the user to specify a folder. If this option is used then the folder location must be specified in the text box beneath the dropdown menu.
- Use the **Filename** text box to name output files. The default name is defined by the macro **%[Filename]**, which uses the name of the source file. Click the dropdown arrow to add additional [macros](#).<sup>[488]</sup>
- Use the **When File Already Exists** dropdown menu to determine the action taken when filenames are already in use:
  - **Prompt for action** prompts the user for an action to take.
  - **Overwrite with a new file** overwrites the existing file with the new file.
  - **Keep existing file unchanged** retains the existing file and does not save the new file.
  - **Save new with other unique name** inserts a prefix to the filename and then saves the new file.

Click  **Save Changes** to save changes.

---



## 7.3.3 Save Images



The **Save Images** action determines the save options for output images. It contains the following customizable parameters:

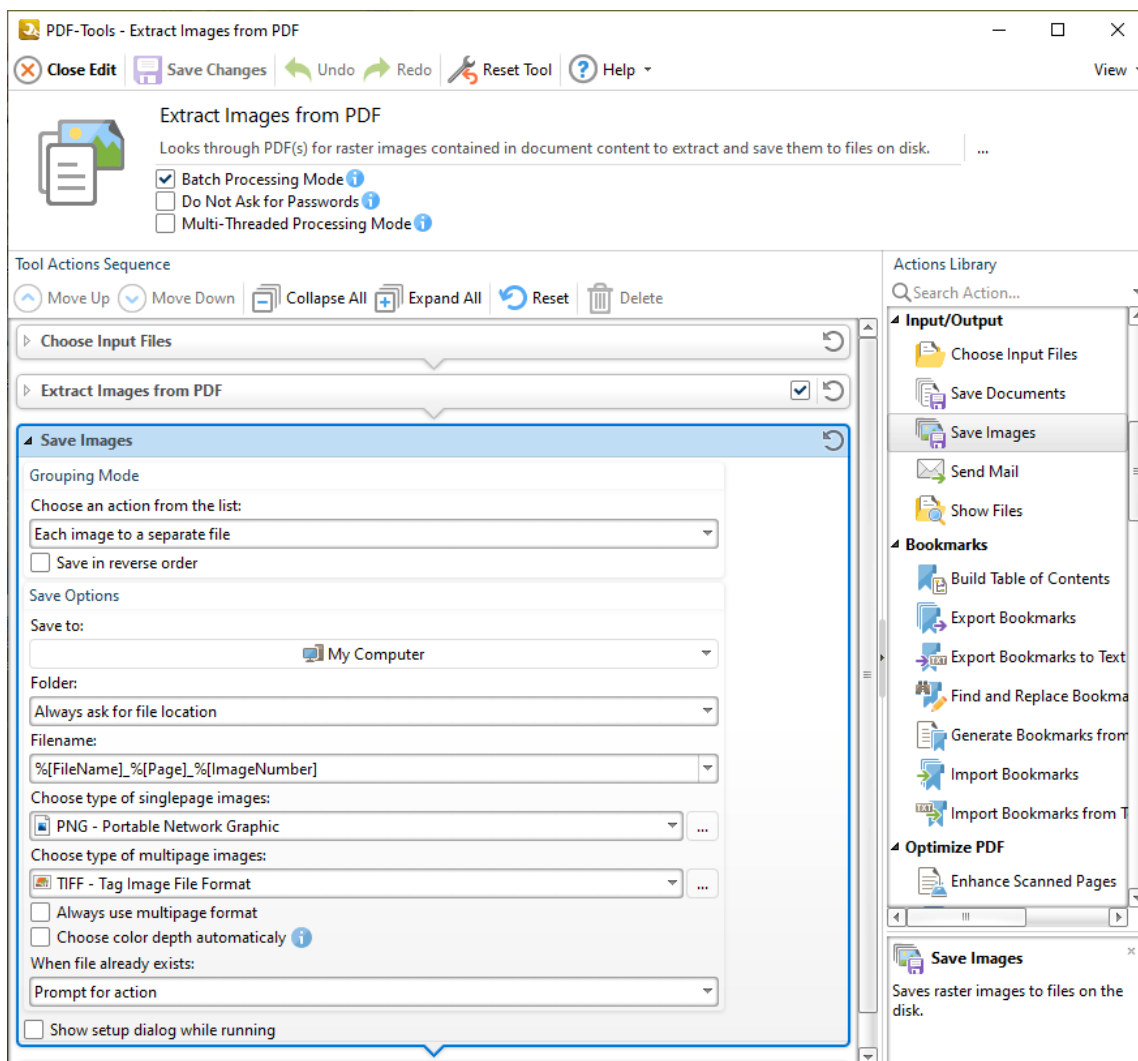

Figure 1. Save Images Action Options

- Use the **Grouping Mode** options to determine how saved images are grouped:
  - Select **Each image to a separate file** to save each image to a separate file.

- Select **All images from one page to one multipage image file** to save all images from each page to one multi-page image file.
- Select **All images to one multipage image file** to save all images to one multi-page image file.
- Select **All images from one document to one multipage image file** to save all images from each document to one multi-page image file.
- Select the **Save in reverse order** box to save images in reverse order.
- Use the **Save to** dropdown menu to determine where output files are saved:
  - Click **My Computer** to save files to the local computer.
  - Hover over **Add Place** to add a new place at which to save files, then click **Box.com, Dropbox, Google Drive, OneDrive or Sharepoint** to add accounts from these locations. **PDF-Tools** will prompt for the login information for the selected account. When this information has been entered, the account will be detailed in the list and can be used to save files as desired.
- Use the **Folder** dropdown menu to determine where converted files are saved:
  - **Always ask for file location** prompts the user to select a location each time the action is used.
  - **Use source folder as destination** uses the source folder of input files as the save location.
  - **Use custom folder specified** enables the user to specify a folder. If this option is used then the folder location must be specified in the text box beneath the dropdown menu.
- Use the **Filename** text box to name output files. The default name is defined by the macro **%[Filename]**, which uses the name of the source file. Click the dropdown arrow to add additional [macros](#).<sup>[488]</sup>
  - Select an option in the **Choose type of singlepage images** dropdown menu to determine the format for single-page output.
  - Select an option in the **Choose type of multipage images** dropdown menu to determine the format for multi-page output.
  - Select the **Always use multipage format** box to use multi-page output in for all images.
  - Select the **Choose color depth automatically** box to enable the auto-selection of color depth for output images. Note that the image type parameter of the image format will be ignored.
  - Use the **When File Already Exists** dropdown menu to determine the action taken when filenames are already in use:
    - **Prompt for action** prompts the user for an action to take.
    - **Overwrite with a new file** overwrites the existing file with the new file.
    - **Keep existing file unchanged** retains the existing file and does not save the new file.
    - **Save new with other unique name** inserts a prefix to the filename and then saves the new file.

- Select the **Show setup dialog while running** box to launch the **Save Images** dialog box and customize settings each time this action is used. Clear this box to disable the **Save Images** dialog box from opening each time the action is used, which is useful when the same settings are used consistently.

Click  **Save Changes** to save changes.

---

## 7.3.4 Send Mail



The **Send Mail** action sends output documents/images via the user's desktop email client. It contains the following customizable parameters:

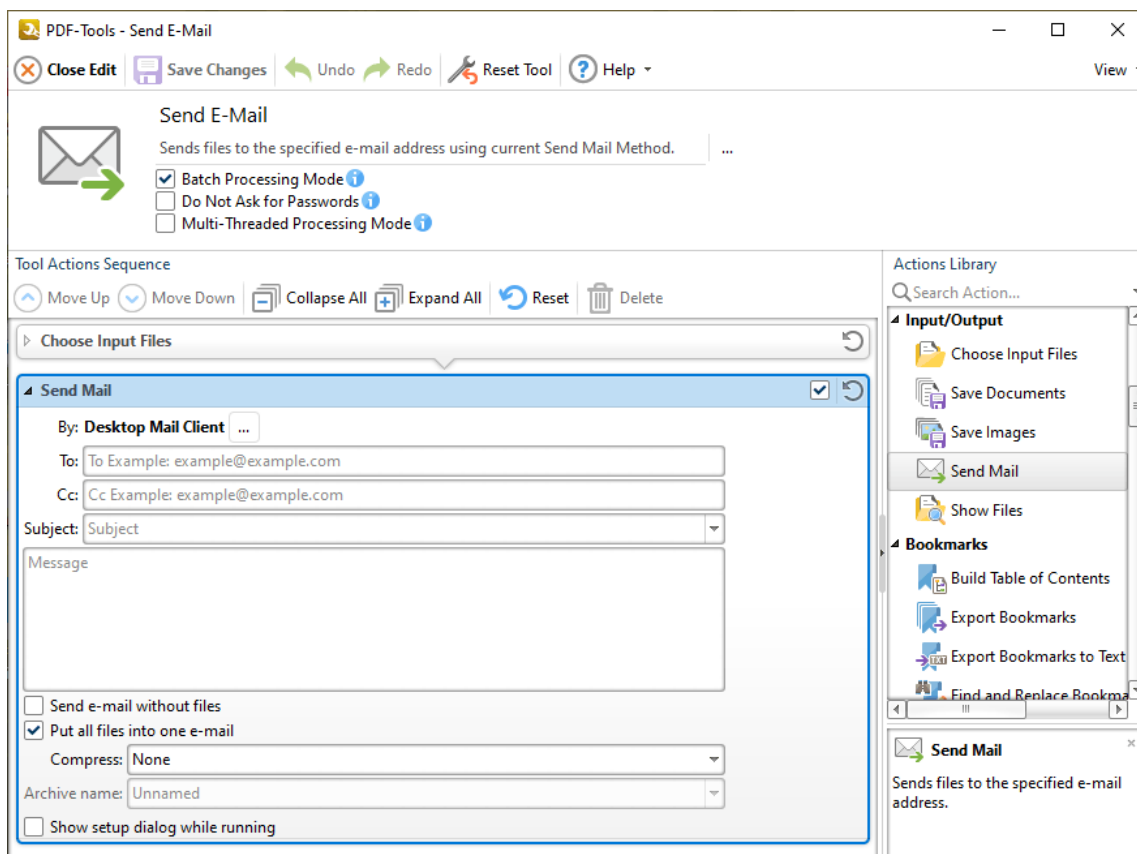

Figure 1. Send Mail Action Options

- Click the ellipsis icon next to **Desktop Mail Client** to view/edit the settings of the current desktop email client, as detailed [here](#).
- Enter the email address of the recipient in the **To** text box.
- Enter the email address of additional recipients in the **Cc** text box.
- Enter the subject of the email in the **Subject** text box and the text of the email in the **Message** text box.
- Select the **Send e-mail without files** box to send the email without attaching files. This can be used as a notification method for when the tool has finishing running.

- Select the **Put all files into one e-mail** box to place all files in a single email. Clear this box to send one file per email.
- Select an option in the **Compress** dropdown menu to compress files before they are sent:
  - Select **each file to a separate archive** or **All files to one archive** as desired, then enter a name for the archive in the **Archive name** text box.
- Select the **Show setup dialog while running** box to launch the **Send Mail** dialog box and customize settings each time this action is used. Clear this box to disable the **Send Mail** dialog box from opening each time the action is used, which is useful when the same settings are used consistently.

Click  **Save Changes** to save changes.

---

## 7.3.5 Show Files



The **Show Files** action displays output documents. It contains the following customizable parameters:

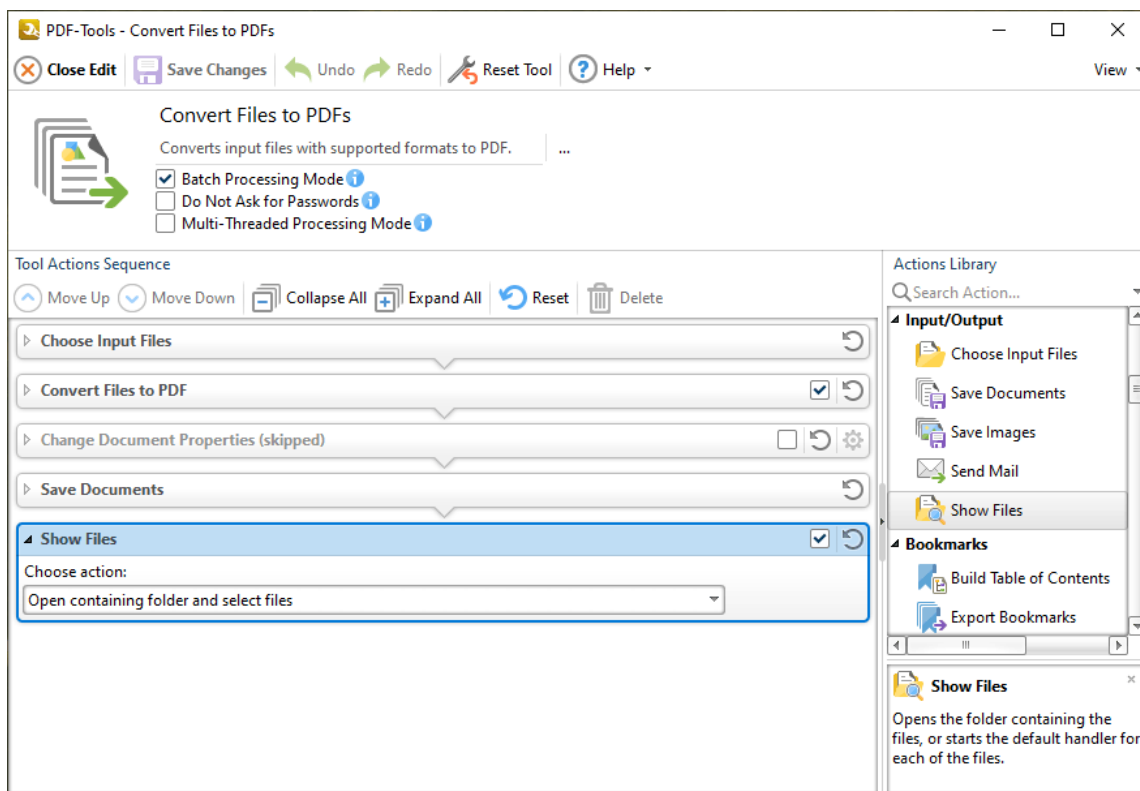

Figure 1. Show Files Action Options

- Use the **Choose action** dropdown menu to determine how output files are displayed:
  - Select **Open containing folder and select files** to open the specified output folder and highlight the output files.
  - Select **View files using the external program associated with them** to open files using the default program for the format of output files.

Click  **Save Changes** to save changes.



## 7.4 Bookmark Actions







---



### Bookmark Actions

---

The **Bookmark** actions determine parameters for creating, importing, exporting and manipulating bookmarks:

-  [Build Table of Contents](#)<sup>[145]</sup> uses bookmarks to create a table of contents for input documents.
  -  [Export Bookmarks](#)<sup>[148]</sup> create a copy of the bookmarks in input documents and then saves them to file.
  -  [Export Bookmarks to Text File](#)<sup>[149]</sup> creates a copy of the bookmarks in input documents and then saves them to a plain text (\*.txt) file.
  -  [Find and Replace Bookmark Text](#)<sup>[152]</sup> finds and replaces text in bookmark titles.
  -  [Generate Bookmarks from Page Text](#)<sup>[154]</sup> creates bookmarks from the text of input documents.
  -  [Import Bookmarks](#)<sup>[162]</sup> imports bookmarks into documents.
  -  [Import Bookmarks from Text File](#)<sup>[164]</sup> imports bookmarks from a text file into documents.
-



## 7.4.1 Build Table of Contents



### Build Table of Contents

The **Build Table of Contents** action uses bookmarks to create a table of contents for documents. It contains the following customizable parameters:

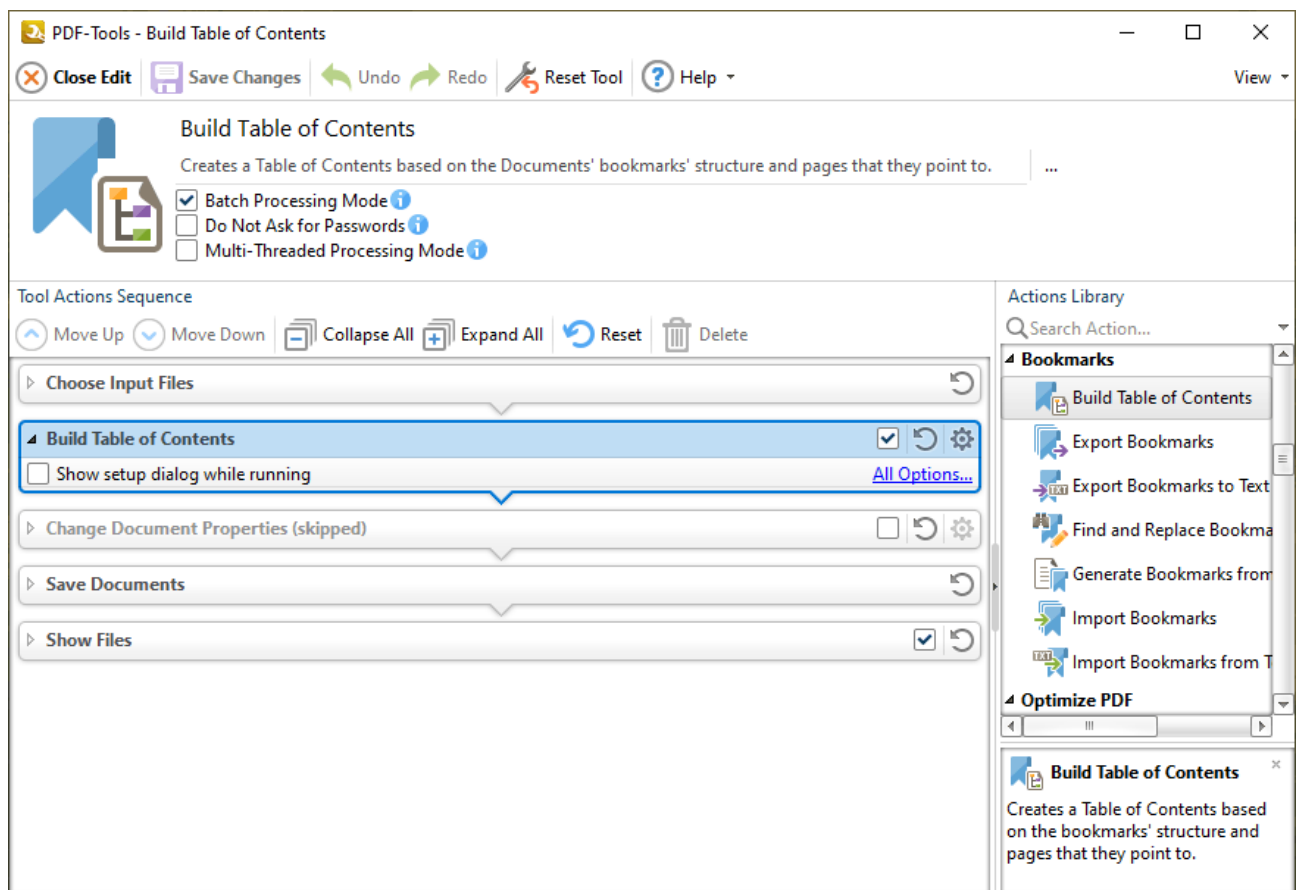

Figure 1. Build Table of Contents Action Options

- Click **All Options** to determine conversion options for the table of contents. The **Build Table of Contents** dialog box will open, as detailed below.
- Select the **Show setup dialog while running** box to launch the **Build Table of Contents** dialog box and customize settings each time this action is used. Clear this box to disable the **Build Table of Contents** dialog box from opening each time the action is used, which is useful when the same settings are used consistently.

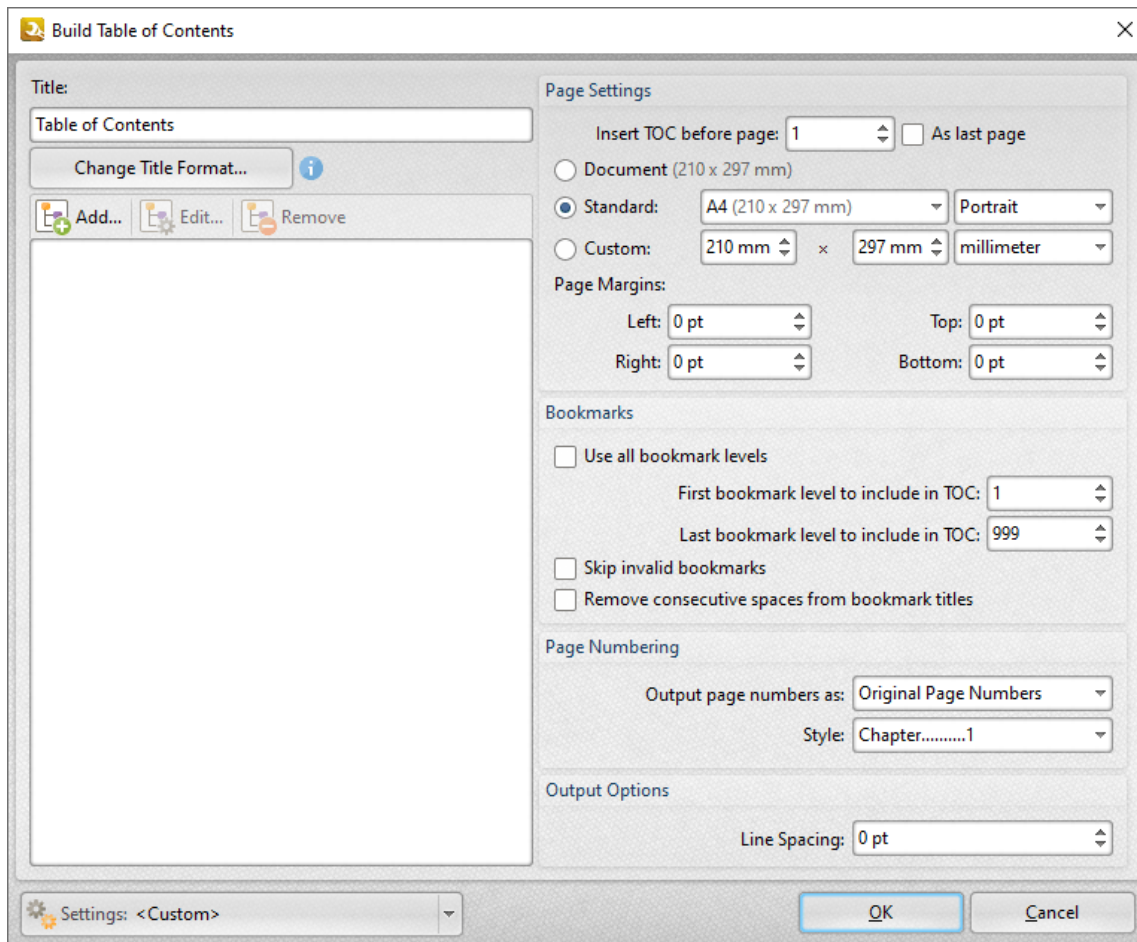

Figure 2. Build Table of Contents Dialog Box

- Use the **Title** text box to enter a title for the table of contents. Click **Change Title Format** to change the font style of the title, as detailed [here](#).<sup>[486]</sup>
- Click **Add** to add font styles to bookmark levels. Font styles are detailed [here](#).<sup>[486]</sup>
- Use the **Page Settings** to determine settings for the table of contents:
  - Use the **Insert TOC before page** number box to determine where the table of contents is inserted, or selected the **As last page** box to append it to the document.
  - Select **Document** to set the page size of the table of contents as the same size of the input document pages.
  - Select **Standard** to set the page size of the table of contents to a standard size, then select a size in the dropdown menu and either **Portrait** or **Landscape** as the orientation.
  - Select **Custom** to set a custom page size, then use the number boxes and the units of measurement dropdown menu to determine the size.
  - Use the **Page Margins** number boxes to determine the margins in the table of contents.
- Use the **Bookmarks** settings to determine the bookmarks used in the creation of the table of contents:

- Select the **Use all bookmark levels** box to use all bookmark levels. Alternatively, use the number boxes to determine the first and last bookmark level used.
- Select the **Skip invalid bookmarks** box to exclude invalid bookmarks, such as those that do not have a destination, from the table of contents.
- Select the **Remove consecutive spaces from bookmark titles** box as desired.
- Use the **Page Numbering** options to determine how page numbers are displayed in the table of contents:
  - Select an option in the **Output Page Numbers as** dropdown menu to determine the reference used for entries in the table of contents.
  - Select an option in the **Style** dropdown menu to determine the style of entries in the table of contents.

Click **OK** to save changes.

---

## 7.4.2 Export Bookmarks



The **Export Bookmarks** action creates a copy of the bookmarks in documents and then saves them to file:

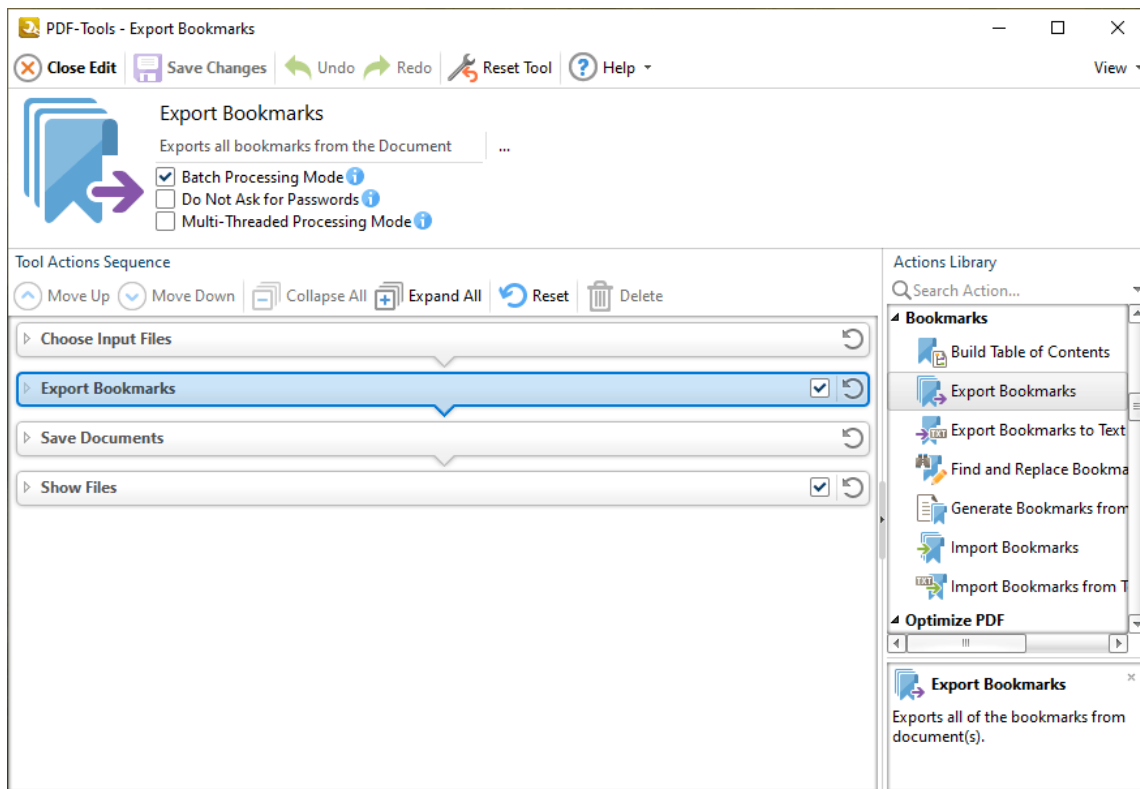

Figure 1. Export Bookmarks Action Options

Select/clear the check box to enable/disable this action, then click **Save Changes** to save changes.

## 7.4.3 Export Bookmarks to Text File



### Export Bookmarks to Text File

The **Export Bookmarks to Text File** action creates a copy of the bookmarks in input documents and then saves them to a plain text (\*.txt) file. It contains the following customizable parameters:

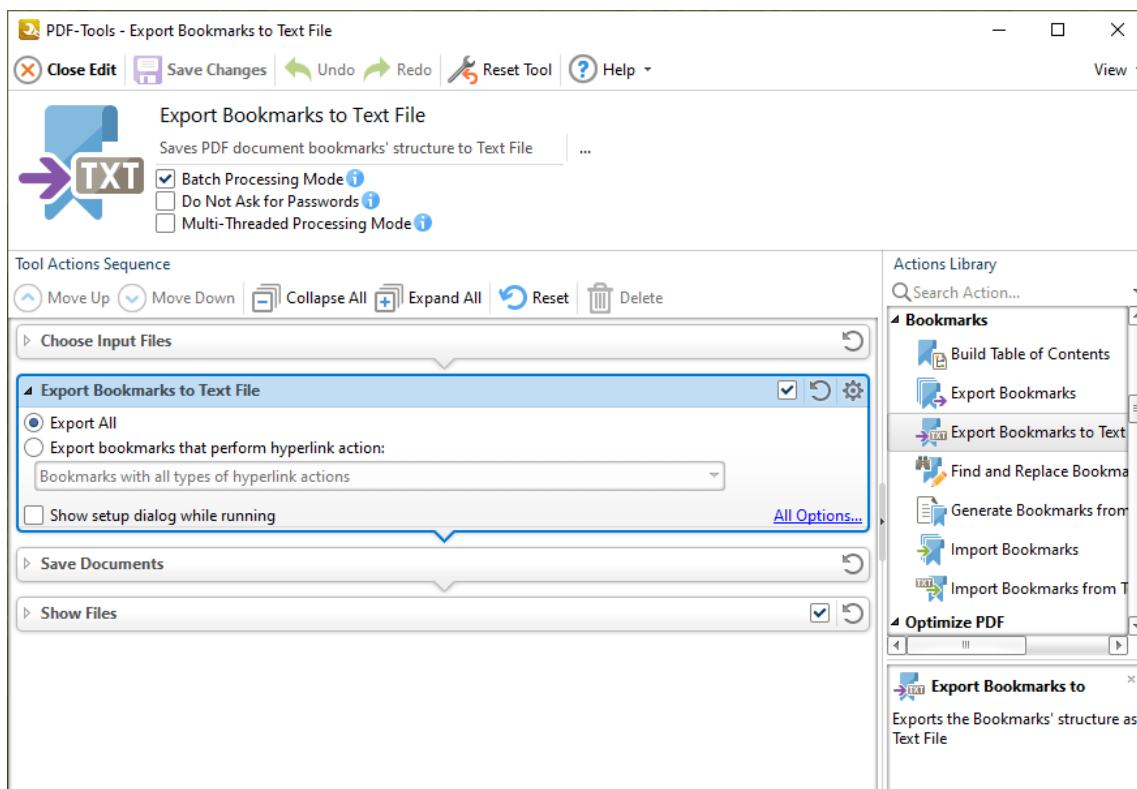

**Figure 1.** Export Bookmarks to Text File Action Options

- Select **Export All** to export all bookmarks to text file.
- Select **Export bookmarks that perform hyperlink action** to export only bookmarks that perform hyperlink actions, then use the dropdown menu to determine which hyperlinks are exported.
- Click **All Options** to view/edit export options. The **Export Bookmarks to Text File** dialog box will open, as detailed below.
- Select the **Show setup dialog while running** box to launch the **Export Bookmarks to Text File** dialog box and customize settings each time this action is used. Clear this box to disable the **Export Bookmarks to Text File** dialog box from opening

each time the action is used, which is useful when the same settings are used consistently.

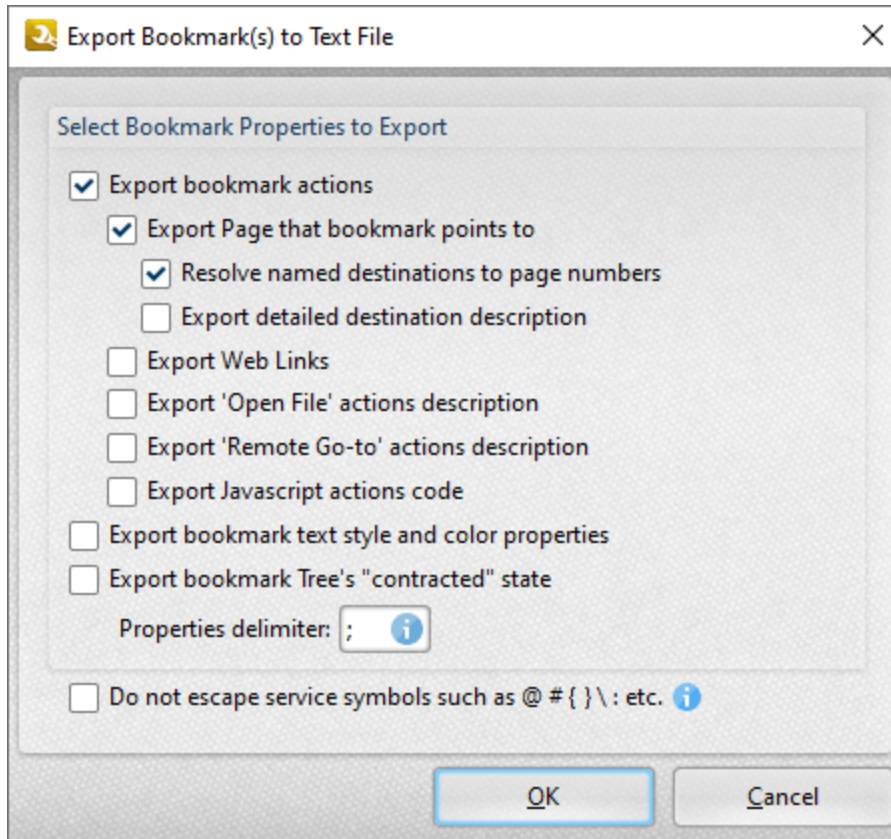

Figure 2. Export Bookmarks to Text File Dialog Box

- Select the **Export bookmark actions** box to include bookmark actions in the export.
- Select the **Export Page that bookmark points to** box to include the page number of bookmark links.
- Select the **Resolve named destinations to page numbers** box to display named destinations as page numbers in the created text file. If this box is not selected then the name of the named destination will be exported instead.
- Select the **Export detailed destination description** box to export a more detailed description of named destinations.
- Select the **Export Web Links** box to include weblinks in the export file.
- Select the **Export 'Open File' actions description** to include a description of **'Open File'** actions in the export file. These actions open files when bookmarks are clicked.
- Select the **Export 'Remote Go-to' actions description** box to include a description of **'Go-To'** actions in the export file. These actions navigate to a document page when bookmarks are clicked. Document pages can be located in the current document, a different document or an embedded document.
- Select the **Export JavaScript actions code** box to include bookmark JavaScript actions in the export file. These actions execute JavaScript when bookmarks are clicked.

- Select the **Export Bookmark text style and color properties** box as desired.
- Select the **Export bookmark tree's "contracted" state** box to export bookmarks in collapsed format.
- Use the **Properties delimiter** box to set the delimiter that separates bookmark properties in the text file.
- Select the **Do not escape service symbols** box as desired. If the files that the **Export Bookmarks to Text Files** action creates will be used in conjunction with the [Generate Bookmarks from Page Text](#)<sup>154</sup> action then it is advisable to select this box.

Click **OK** to save changes.

---

## 7.4.4 Find and Replace Bookmark Text



### Find and Replace Bookmark Text

The **Find and Replace Bookmark Text** action finds and replaces text in bookmark titles. It contains the following customizable parameters:

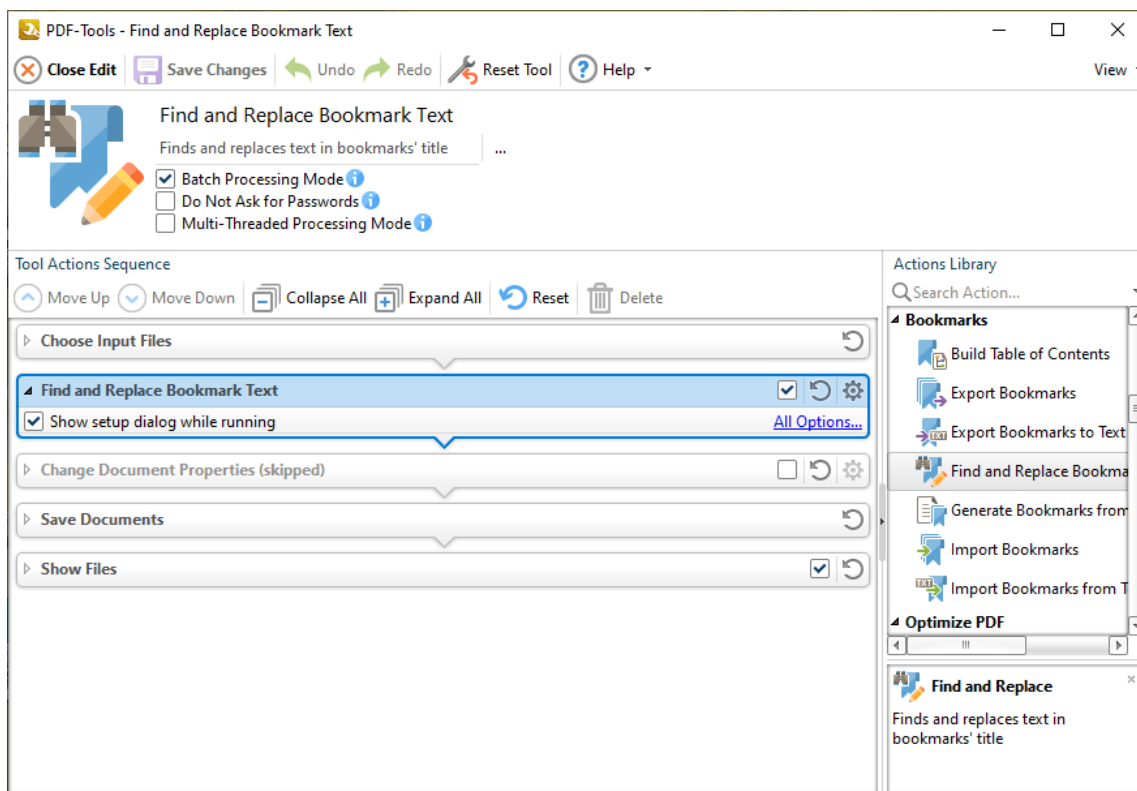
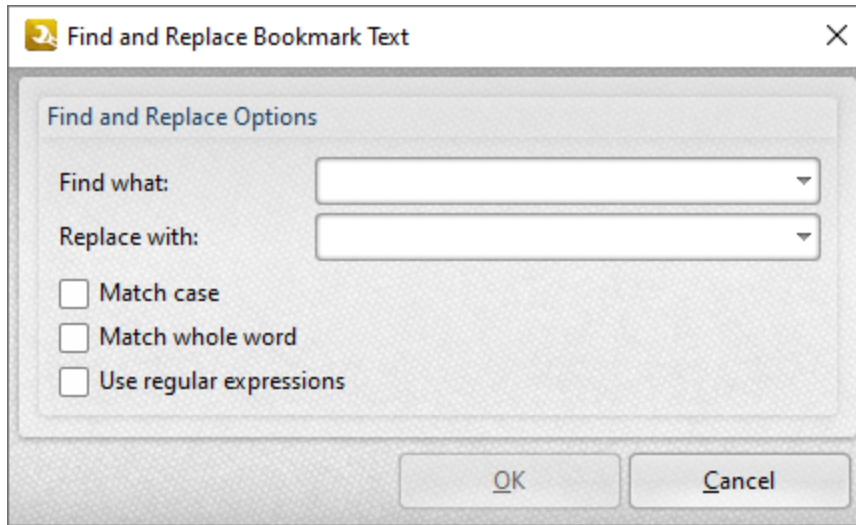

Figure 1. Find and Replace Bookmark Text Action Options

- Click **All Options** to view/edit action options. The **Find and Replace Bookmark Text** dialog box will open, as detailed below.
- Select the **Show setup dialog while running** box to launch the **Find and Replace Bookmark Text** dialog box and customize settings each time this action is used. Clear this box to disable the **Find and Replace Bookmark Text** dialog box from opening each time the action is used, which is useful when the same settings are used consistently.





**Figure 2.** Find and Replace Bookmark Text Dialog Box

- Enter the terms to be replaced in the **Find what** text box.
- Enter the replacement terms in the **Replace with** text box.
- Select the **Match case**, **Match whole word** and **Use regular expressions** boxes as desired. Further information on regular expressions is available [here](#).

Click **OK** to save changes.

---

7.4.5 Generate Bookmarks from Page Text



## Generate Bookmarks from Page Text

The **Generate Bookmarks from Page Text** action creates bookmarks from the text of input documents. It contains the following customizable parameters:

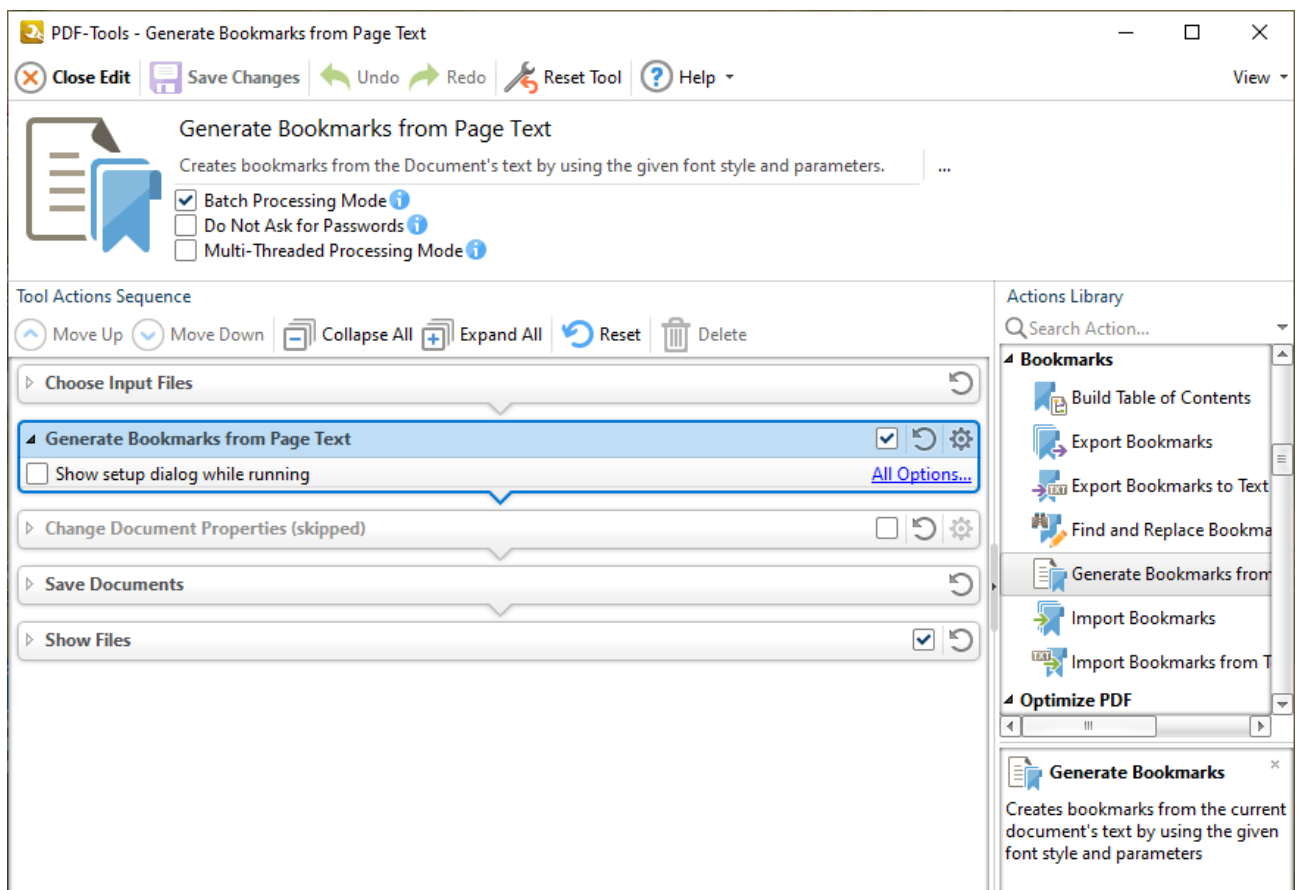

Figure 1. Generate Bookmarks from Page Text Action Options

- Click **All Options** to view/edit all options. The **Generate Bookmarks from Page Text** dialog box will open, as detailed below.
- Select the **Show setup dialog while running** box to launch the **Generate Bookmarks from Page Text** dialog box and customize settings each time this action is used. Clear this box to disable the **Generate Bookmarks from Page Text** dialog box from opening each time the action is used, which is useful when the same settings are used consistently.

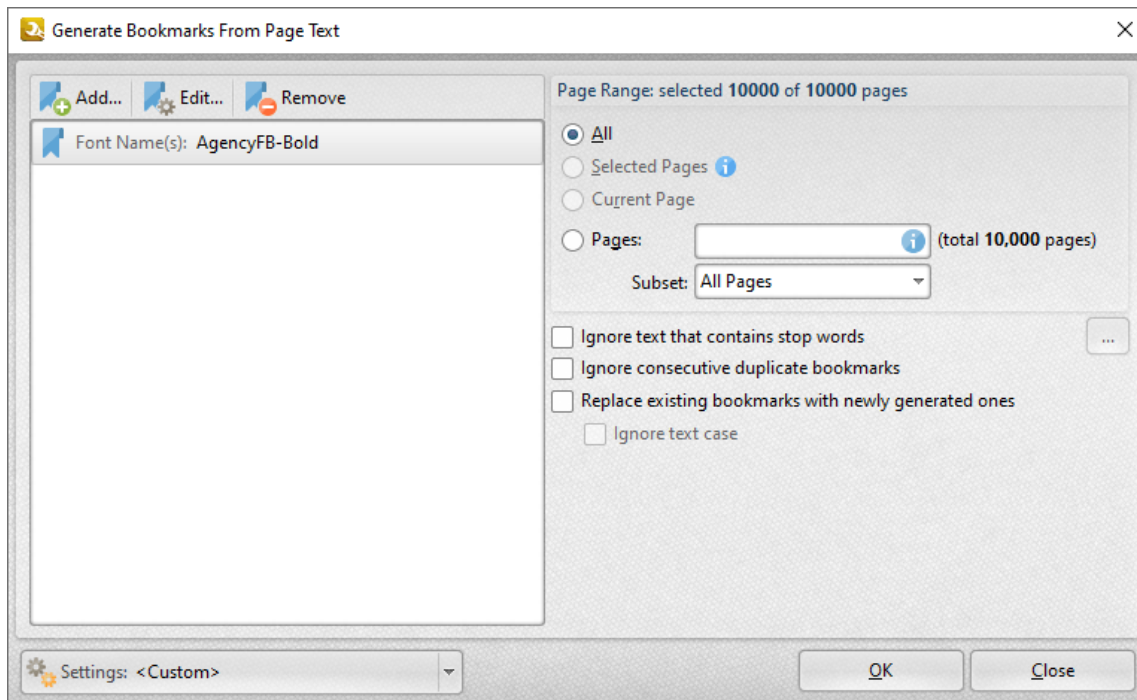

Figure 2. Generate Bookmarks from Page Text Dialog Box

Note that it is necessary to create bookmark generators in order to generate bookmarks from page text.

- Click **Add** to add a new bookmark generator. The **Bookmark Generation Properties** dialog box will open, as detailed in *(figure 5)*.
- Click **Edit** to edit the selected bookmark generator.
- Click **Remove** to remove the selected bookmark generator.
- The **Page Range** options determine the pages included in the generation of bookmarks:
  - Select **All** to use all document pages.
  - The **Select Pages** and **Current Page** options are not yet available. They will be available in a future build of **PDF-Tools**.
  - Use the **Pages** box to determine specific pages/page ranges. Further information on the specification of page ranges is available [here](#).<sup>[552]</sup>
  - Use the **Subset** option to select **All Pages**, **Odd Pages Only** or **Even Pages Only** for specified page ranges.
- Select the **Ignore text that contains stop words** box as desired. Text containing stop words will be excluded from the bookmark generation process when this option is enabled. Click the ellipsis icon to view/edit the list of stop words.
- Select the **Ignore consecutive duplicate bookmarks** box to prevent the creation of consecutive identical bookmarks.
- Click the **Settings** dropdown arrow to save/manage/delete bookmark generator settings:

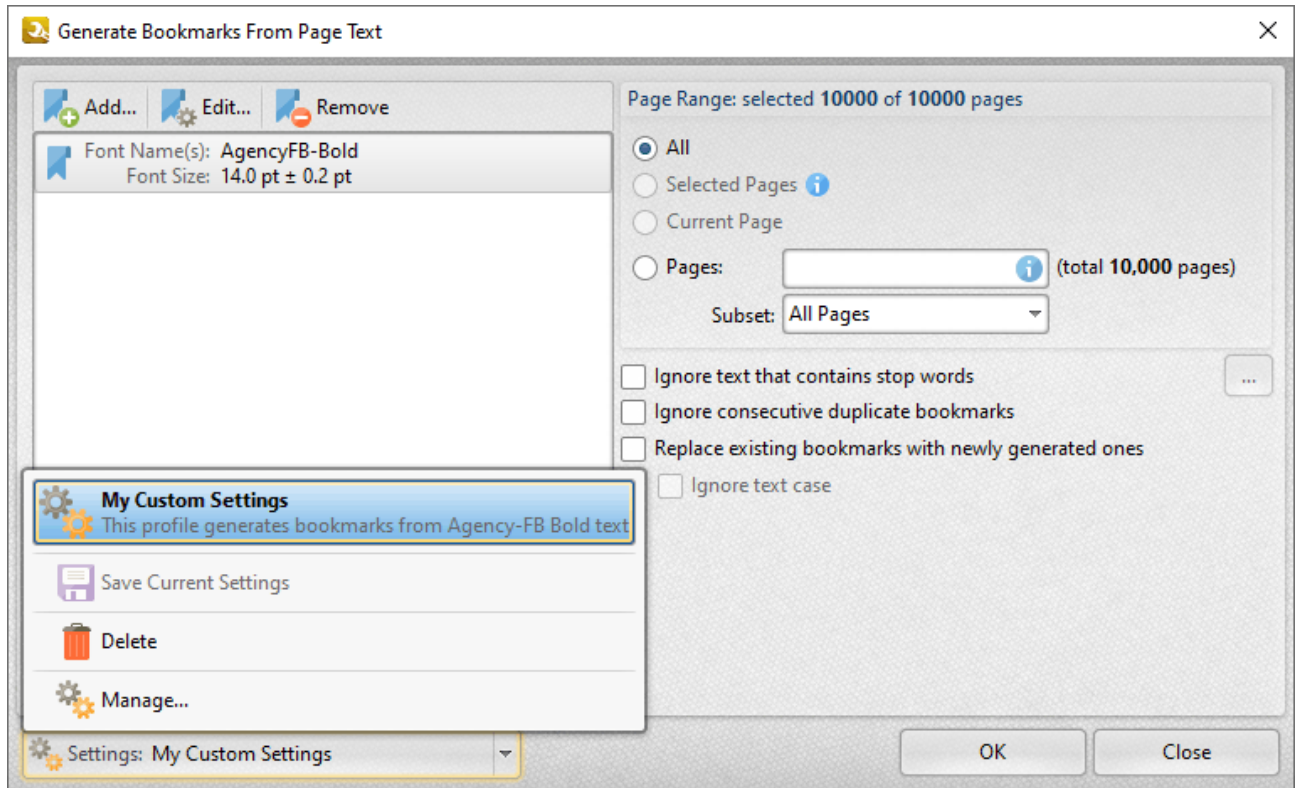

Figure 3. Generate Bookmarks from Page Text Dialog Box, Save/Manage/Delete Options

- Click **Save Current Settings** to save the current settings as a profile for subsequent use.
- Click **Delete** to delete the current profile.
- Click **Manage** to manage profiles. The **Manage Presets** dialog box will open:

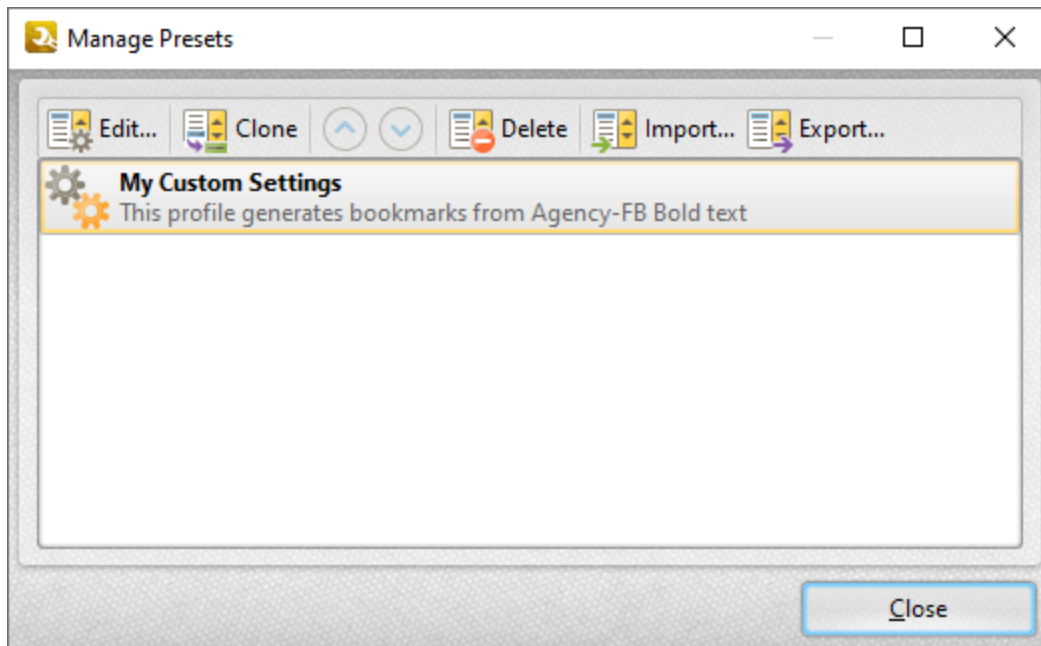

Figure 4. Manage Presets Dialog Box

- Click **Edit** to edit selected profiles.
- Click **Clone** to clone selected profiles.
- Use the up and down arrows to move selected profiles up or down in the list.
- Click **Delete** to delete selected profiles.
- Click **Import** to import profiles from a saved file.
- Click **Export** to export profiles to file.

## Bookmark Generation Properties

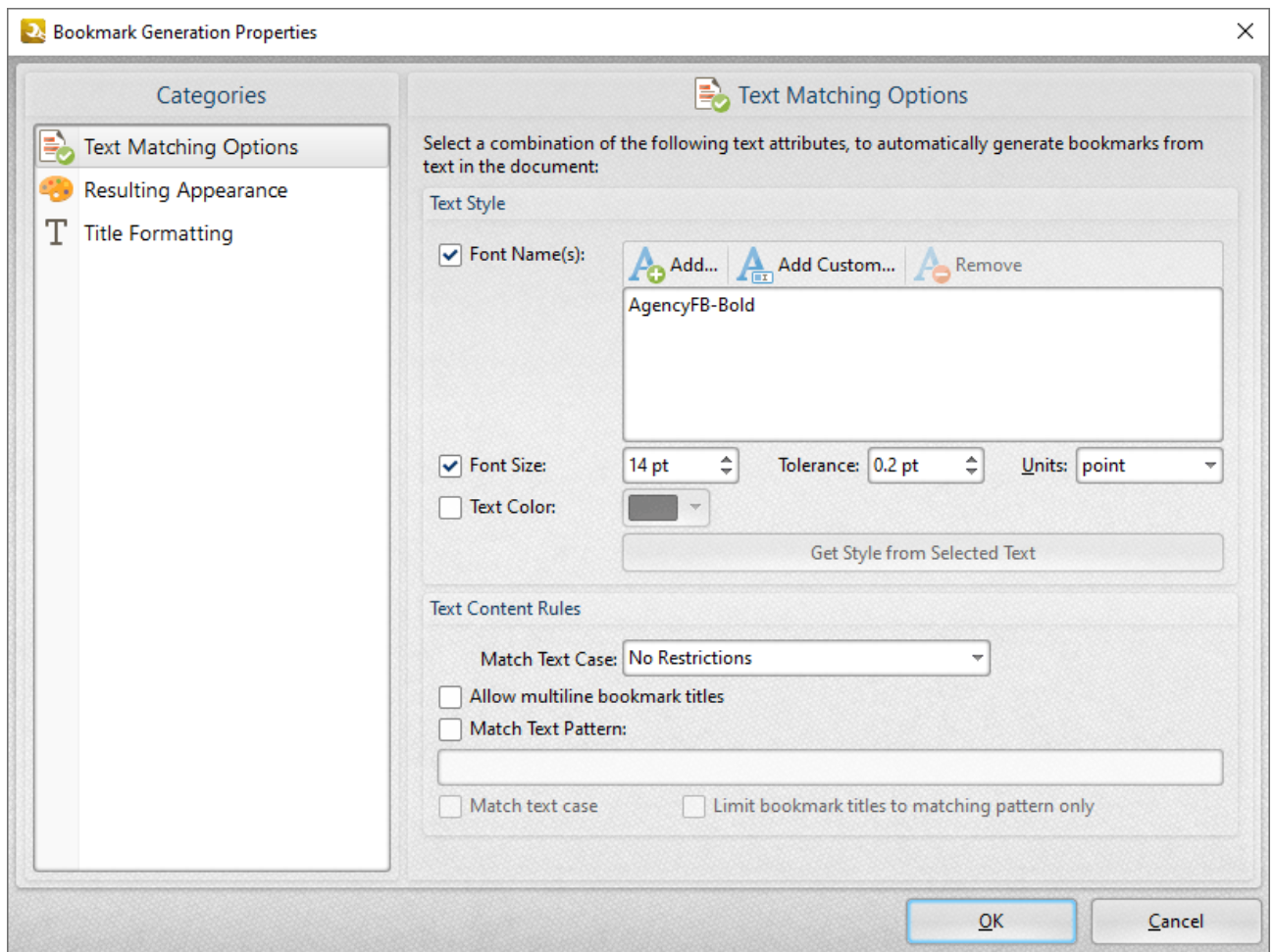

Figure 5. Bookmark Generation Properties Dialog Box, Text Matching Options Category

The options selected in the **Bookmark Generation Properties** dialog box determine the text used to generate bookmarks, and the style of the generated bookmarks:

### Text Matching Options

These options determine text used in the generation of bookmarks according to font, size and color:

- Select the **Font Names** box to include text of specific fonts in the generation of bookmarks. Click **Add** to add fonts to the list, **Add Custom** to add custom fonts, or **Remove** to remove selected fonts.
- Select the **Font Size** box to include text of a specific size in the generation of bookmarks. Use the number boxes to determine the **Size**, **Tolerance** and **Units** of text included in the generation of bookmarks. The **Tolerance** value determines the degree to which selected text can differ from the specified **Font Size** and remain included in the generation of bookmarks.
- Select the **Text Color** box to include text of a specific color in the generation of bookmarks, then select a color in the dropdown menu.
- The **Get Style from Selected Text** option is not currently available. It will be available in a future build of **PDF-Tools**.
- The option selected in the **Match Text Case** dropdown menu determines text used in the generation of bookmarks according to text case:
  - Select **No Restrictions** to include text of all cases in the generation of bookmarks.
  - Select **All Characters Are Capital** to include only upper-case text in the generation of bookmarks.
  - Select **First Character is Capital** to include only text that starts with a capital letter in the generation of bookmarks.
  - Select **First Character is Digit** to include only text that starts with a digit in the generation of bookmarks.
- Select the **Allow multiline bookmark titles** box to allow bookmark titles to exceed one line in length. This is useful in cases where it is not possible to shorten bookmark titles.
- Select the **Match Text Pattern** box to specify a sequence of words that document text must match in order to be included in the generation of bookmarks. Enter the desired text pattern in the text box.
- Select the **Match text case** box to include only text that matches the case of the text entered in the **Match Text Pattern** box. If this box is not selected then all matching text will be included regardless of its case.
- Select the **Limit bookmark titles to matching pattern only** box to determine that only text matching the specified pattern will be included in the generation of bookmarks.

## Resulting Appearance

These options determine characteristics of generated bookmarks:

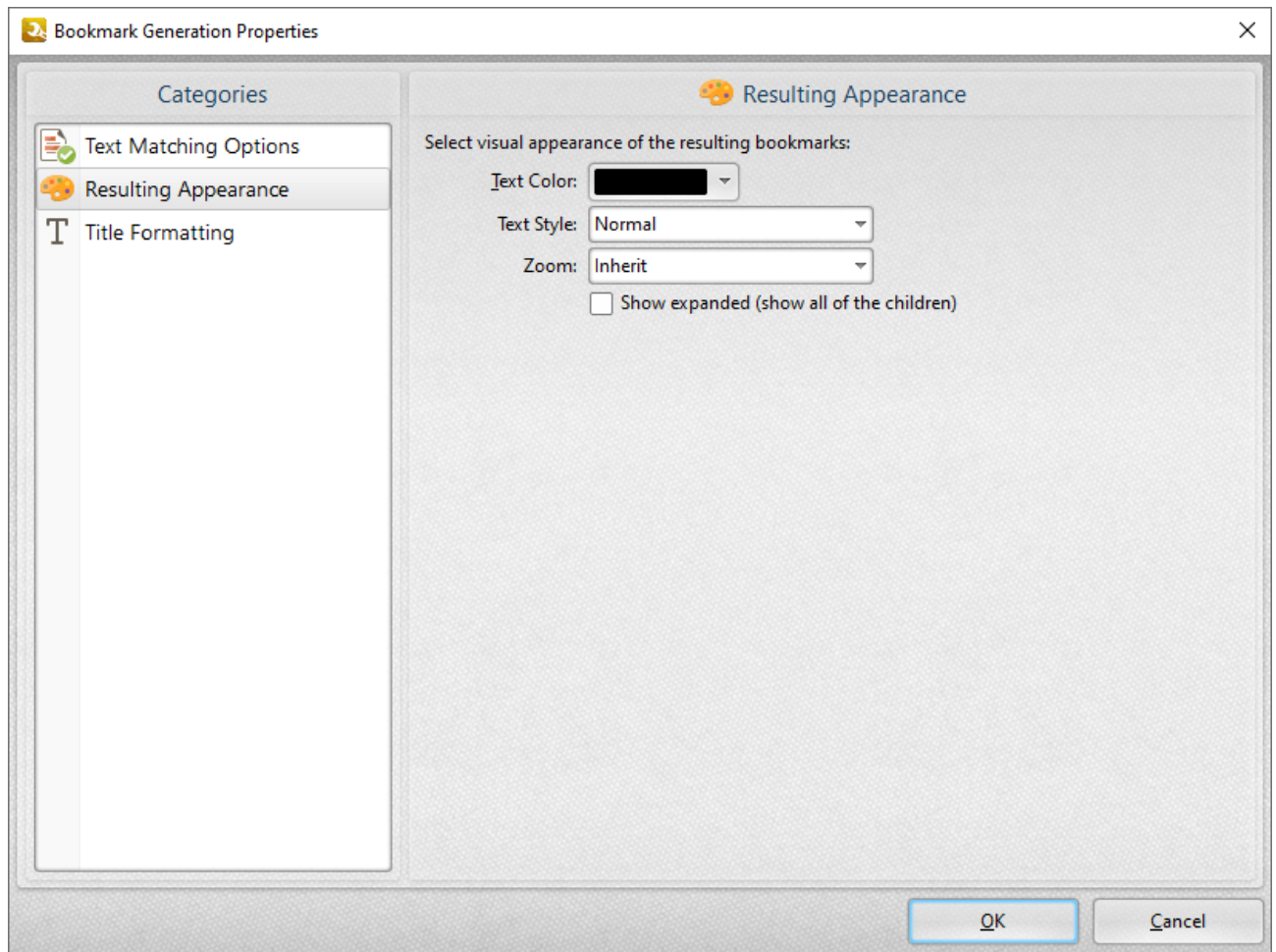

**Figure 6.** Bookmark Generation Properties Dialog Box, Resulting Appearance Category

- Use the **Text Color** menu to determine the text color of bookmarks.
- Use the **Text Style** menu to determine the text style of bookmarks.
- Use the **Zoom** menu to determine the zoom level when bookmarks are clicked. Select **Inherit** to use the current zoom level.
- Select the **Show expanded** box to expand all generated bookmarks.

### **Title Formatting**

These options are used to format bookmark titles:

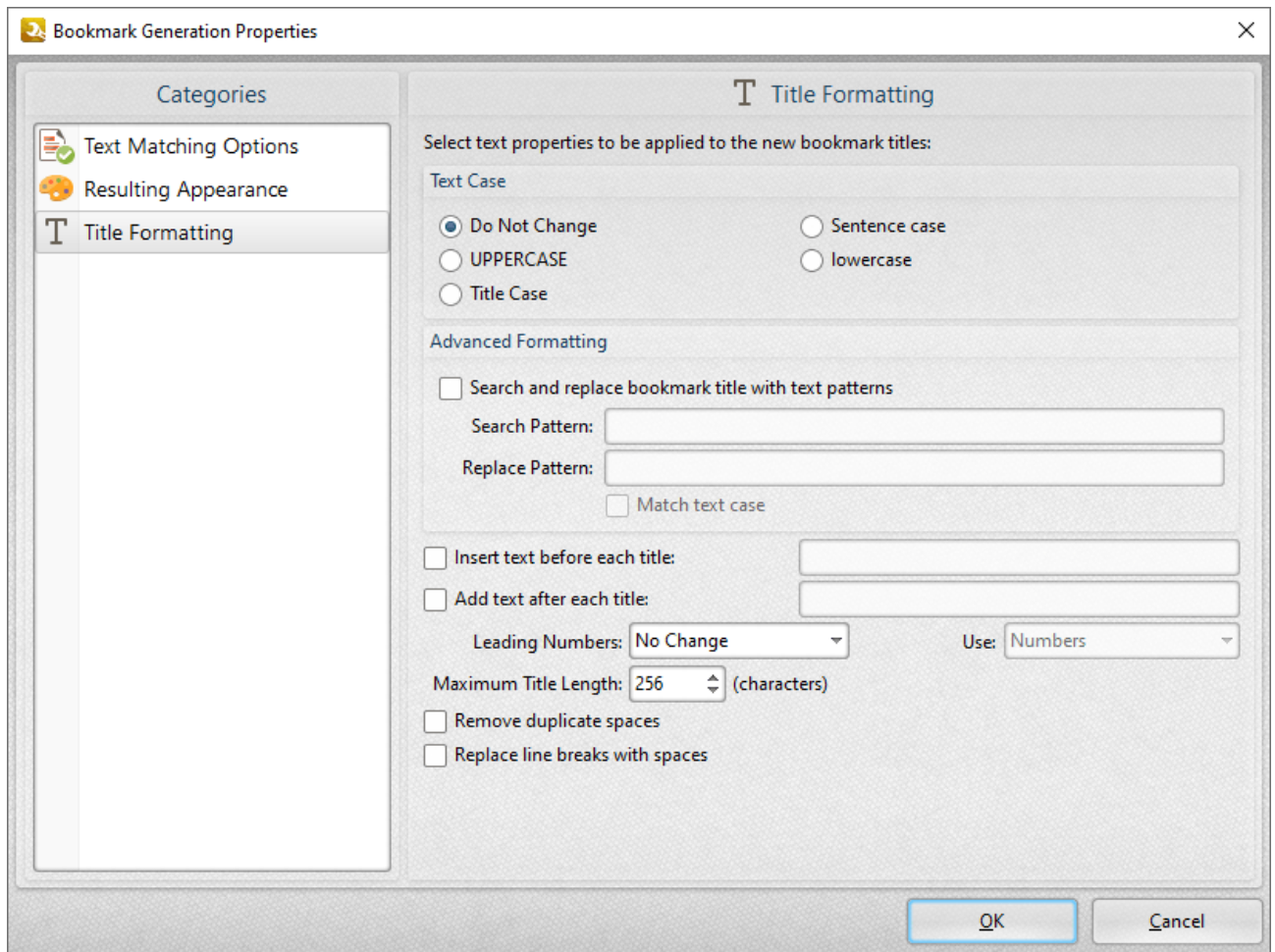

Figure 7. Bookmark Generation Properties Dialog Box, Title Formatting Category

- Select a **Text Case** option to determine the text case of generated bookmark titles.
- Select the **Search and replace bookmark title with text patterns** box to search for specific text in bookmark titles and replace it with customized text:
  - Enter the text to be replaced in the **Search Pattern** text box.
  - Enter the replacement text in the **Replace Pattern** text box.
  - Select the **Match text case** box as desired.
- Select the **Insert text before each title** box to add text before bookmark titles. Enter the desired text in the text box.
- Select the **Add text after each title** box to add text after bookmark titles. Enter the desired text in the text box.
- The **Leading Numbers** dropdown menu is used to add/remove/retain leading numbers for bookmarks. Select **No Change**, **Add** or **Remove** as desired. If leading numbers are being added then use the **Use** dropdown menu to select **Numbers**, **Letters** or **Roman Numerals**.
- Use the **Maximum Title Length** text box to set the maximum number of characters for generated bookmarks.
- Select the **Remove duplicate spaces** box to remove instances of adjacent blank characters.



- Select the **Replace line breaks with spaces** box to use spaces instead of line breaks for bookmarks.

Click **OK** to save changes.

---

## 7.4.6 Import Bookmarks



The **Import Bookmarks** action imports bookmarks into documents. It contains the following customizable parameters:

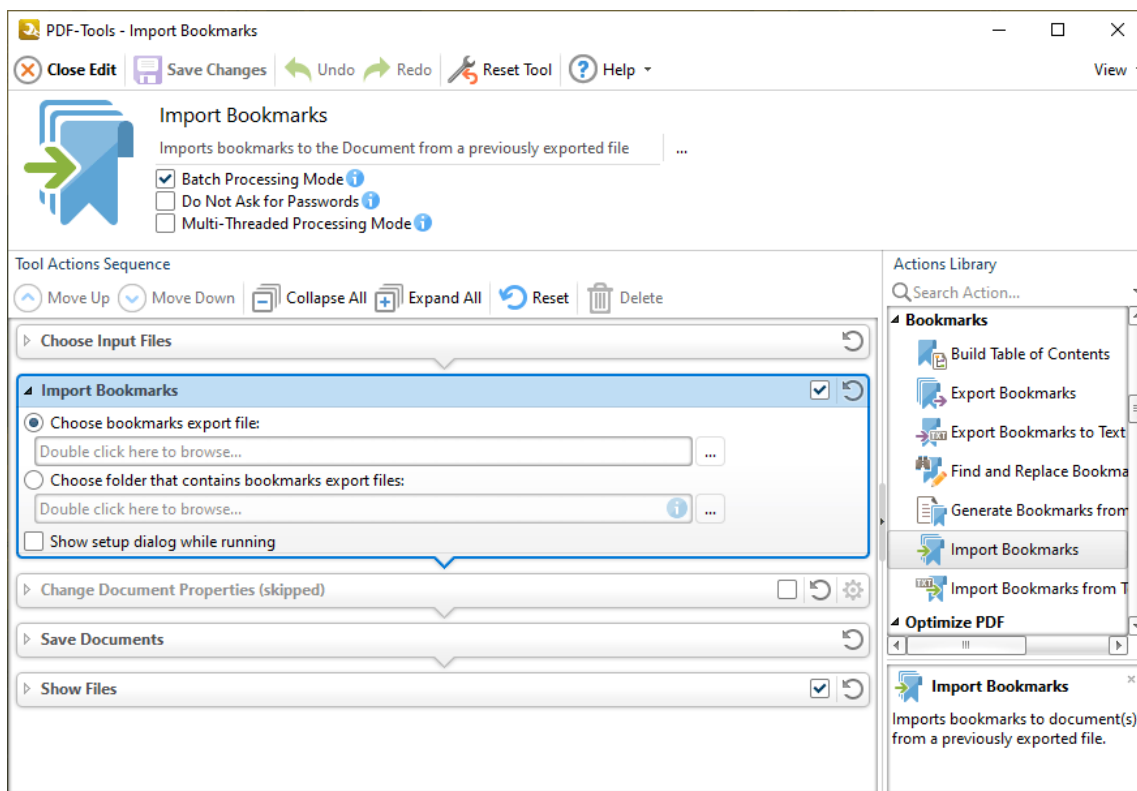

Figure 1. Import Bookmarks Action Options

Note that imported bookmarks must be contained in a (\*.xcbkm) format file. The [Export Bookmarks](#)<sup>[405]</sup> tool can be used to create these files.

- Select **Choose bookmarks export file** to select a bookmarks file to import. Enter the path of the file in the text box, or click the ellipsis icon to select a file manually.
- Select **Choose folder that contains bookmarks export files** to specify a folder that contains a (\*.xcbkm) format file to use for the import. Enter the location of the folder in the text box, or click the ellipsis icon to select a folder manually.
- Select the **Show setup dialog while running** box to launch the **Import Bookmarks** dialog box and customize settings each time this action is used. Clear this box to

disable the **Import Bookmarks** dialog box from opening each time the action is used, which is useful when the same settings are used consistently.

Click  **Save Changes** to save changes.

---

## 7.4.7 Import Bookmarks from Text File



### Import Bookmarks from Text File

The **Import Bookmarks from Text File** action imports bookmarks from a text file into documents. It contains the following customizable parameters:

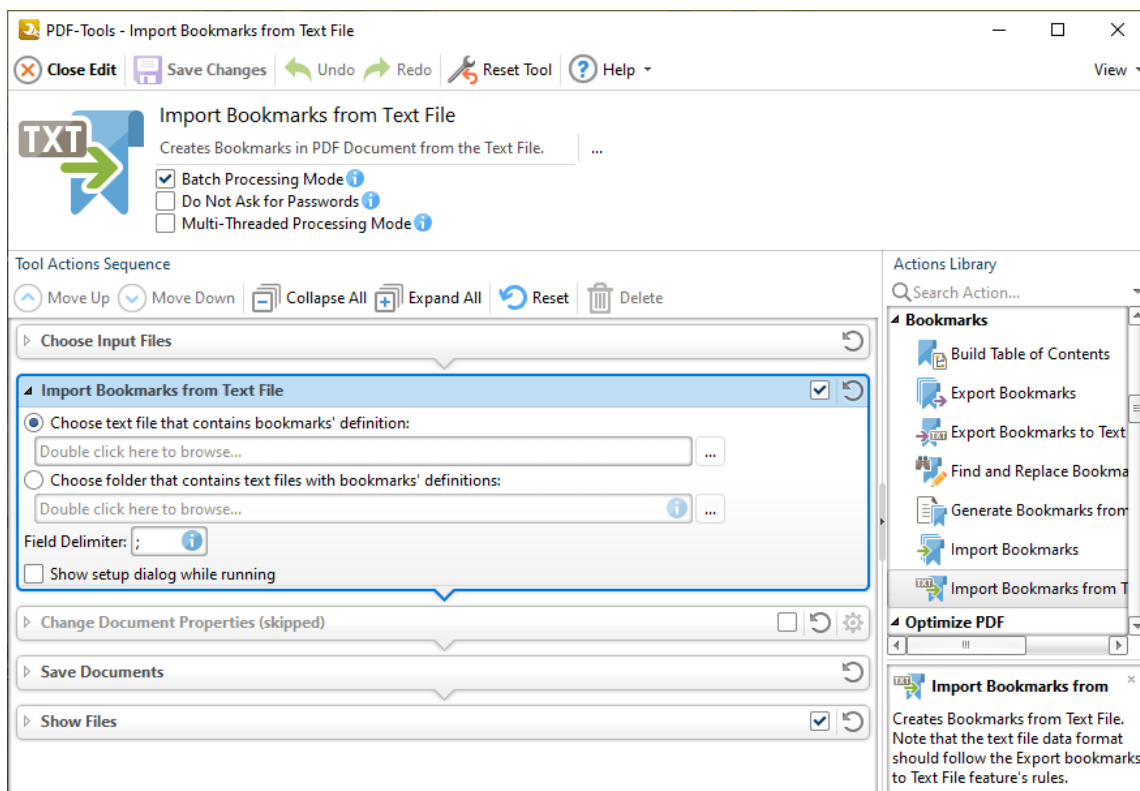

Figure 1. Import Bookmarks from Text File Action Options

Note that imported bookmarks must be contained in a (\*.txt) file and formatted in the same manner as output files from the [Export Bookmarks to Text File](#)<sup>[407]</sup> tool.

- Select **Choose bookmarks export file** to select a bookmarks file to import. Enter the path of the file in the text box, or click the ellipsis icon to select a file manually.
- Select **Choose folder that contains bookmarks export files** to specify a folder that contains a (\*.txt) file to use for the import. Enter the location of the folder in the text box, or click the ellipsis icon to select a folder manually.
- Select the **Show setup dialog while running** box to launch the **Import Bookmarks from Text File** dialog box and customize settings each time this action is used.

Clear this box to disable the **Import Bookmarks from Text File** dialog box from opening each time the action is used, which is useful when the same settings are used consistently.

Click  **Save Changes** to save changes.

---

## 7.5 Optimize PDF Actions

---



### Optimize PDF Actions

---

The **Optimize PDF** actions determine parameters for the optimization of input files:

 [Enhance Scanned Pages](#) <sup>167</sup> enhances scanned images in PDF documents to improve quality and reduce the file size.

 [Optimize PDF](#) <sup>170</sup> optimizes document content in order to reduce the file size.

---

## 7.5.1 Enhance Scanned Pages



### Enhance Scanned Pages

The **Enhance Scanned Pages** action enhances scanned images in PDF documents to improve their quality and reduce the file size. It contains the following customizable parameters:

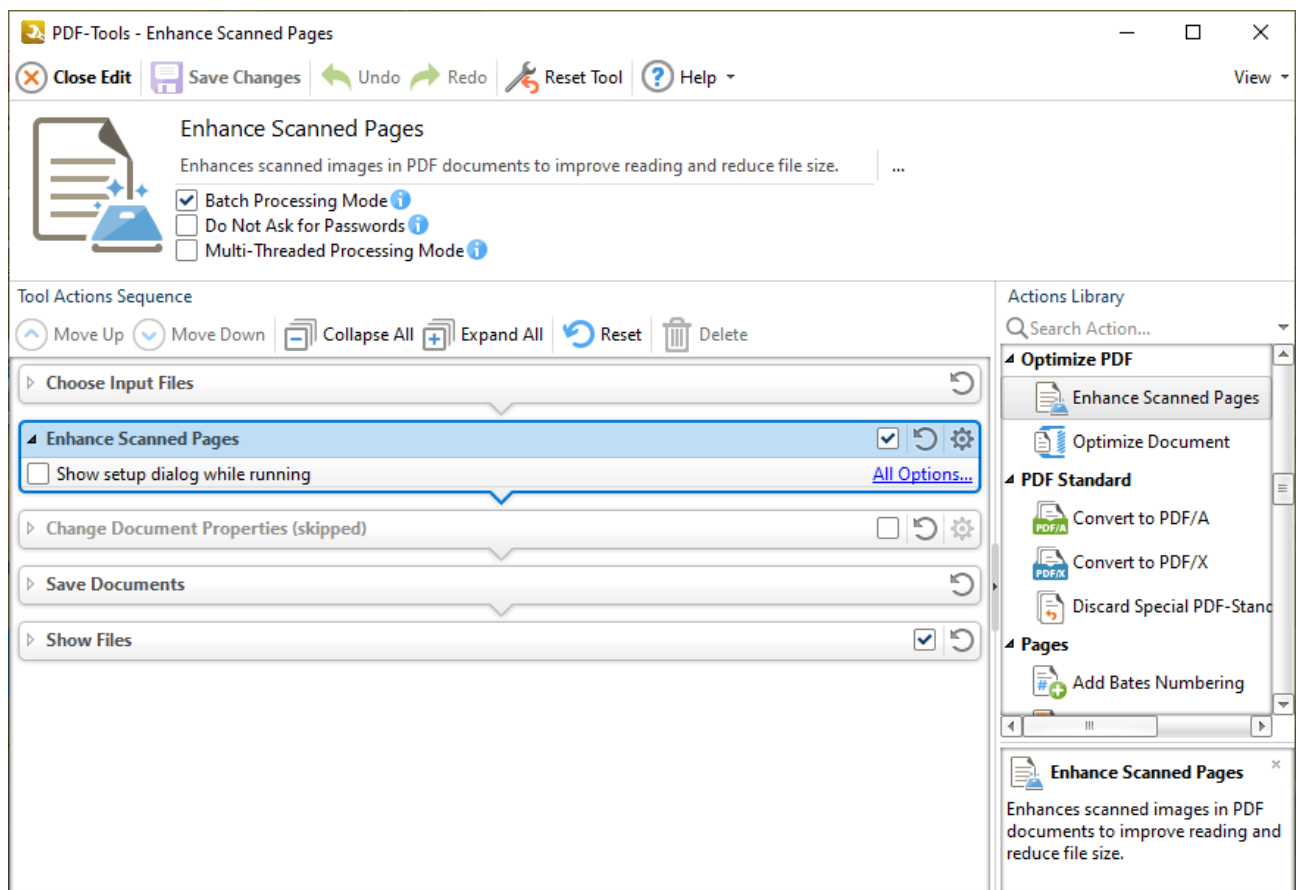

**Figure 1.** Enhance Scanned Pages Action Options

- Click **All Options** to view/edit all options. The **Enhance Scanned Pages** dialog box will open, as detailed below.
- Select the **Show setup dialog while running** box to launch the **Enhance Scanned Pages** dialog box and customize settings each time this action is used. Clear this box to disable the **Enhance Scanned Pages** dialog box from opening each time the action is used, which is useful when the same settings are used consistently.

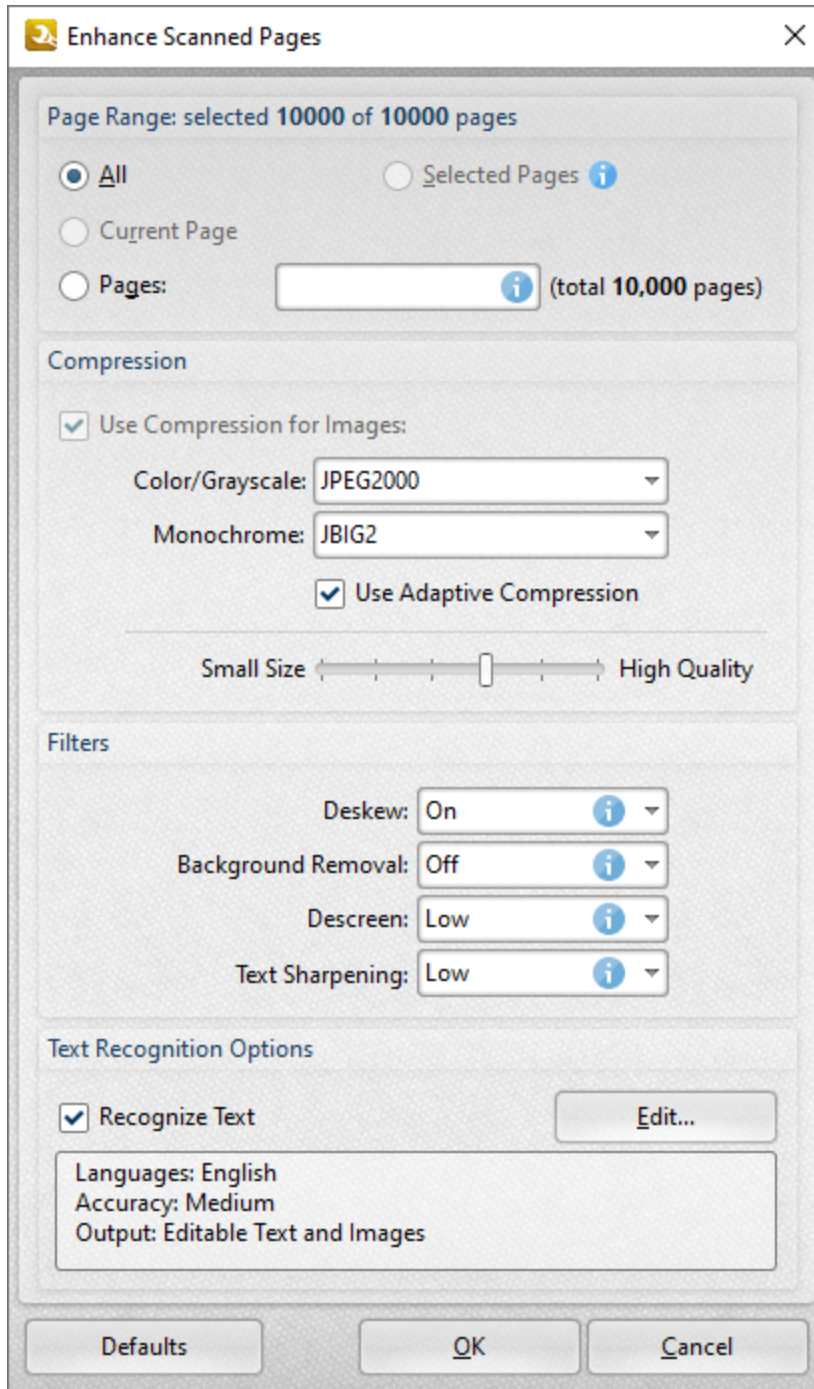

Figure 2. Enhance Scanned Pages Dialog Box

- Use the **Page Range** options to determine which pages are enhanced. Page range options are detailed [here](#).<sup>552</sup>
- Select the **Apply Adaptive Compression** box to apply adaptive compression to scanned pages. Adaptive compression is a method of data compression that dynamically adjusts the algorithm used to compress data. The adjustments made depend on the content of the data.



- Use the **Color/Grayscale** and **Monochrome** dropdown menus to determine the format of compression used for **Color/Grayscale** and **Monochrome** content respectively.
- Use the slider to determine the resolution used for compressed content.
- Use the **Filters** to determine additional filters:
  - Enable the **Deskew** filter to deskew scanned pages. Deskewing is used to straighten the edges of pages that have been scanned crookedly.
  - Select an option in the **Background Removal** dropdown menu to adjust the level of background removal for scanned pages. Background removal is used to whiten off-white areas in the pages of grayscale and/or color-based input.
  - Select an option in the **Descreen** dropdown menu to adjust the descreening level for scanned pages. Descreening is used to remove the halftone dot structure that is common in printed images and causes issues in scanned content.
  - Select an option in the **Text Sharpening** dropdown menu to adjust the level of text sharpening used for scanned pages.
- Use the **Text Recognition Options** to perform optical character recognition on scanned pages:
  - Select the **Recognize Text** box to enable optical character recognition. The process of optical character recognition analyzes scanned content, recognizes text and then makes it selectable and searchable. Note that the current languages and accuracy level for the OCR process are detailed in the pane. Click **Edit** to add/remove language and/or adjust the level of accuracy. (Decreasing the level of accuracy has the benefit of decreasing the time taken to perform the operation).
- Click **Defaults** to revert all values in the **Enhance Scanned Pages** dialog box to their default values.

Click **OK** to save changes.

---

## 7.5.2 Optimize Document



The **Optimize Document** action optimizes the size of PDF documents. It contains the following customizable parameters:

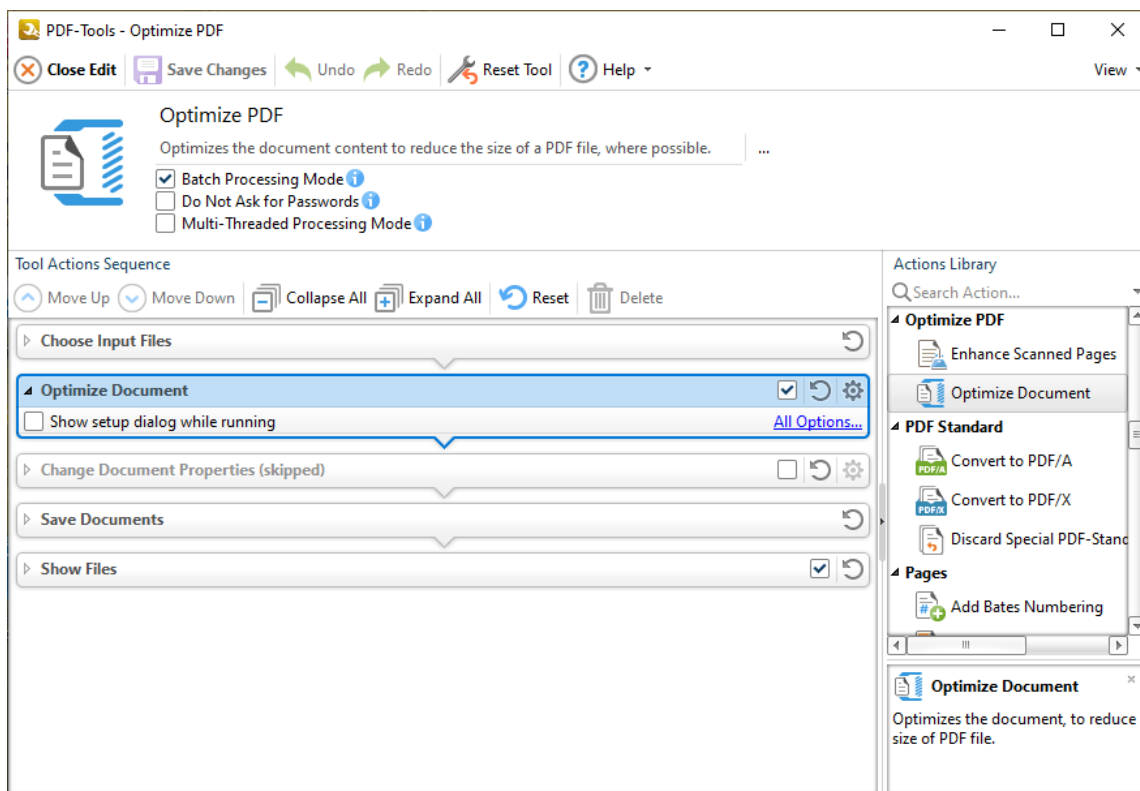

**Figure 1.** Optimize Document Action Options

- Click **All Options** to view/edit all options. The **Optimize PDF** dialog box will open, as detailed below.
- Select the **Show setup dialog while running** box to launch the **Optimize PDF** dialog box and customize settings each time this action is used. Clear this box to disable the **Optimize PDF** dialog box from opening each time the action is used, which is useful when the same settings are used consistently.

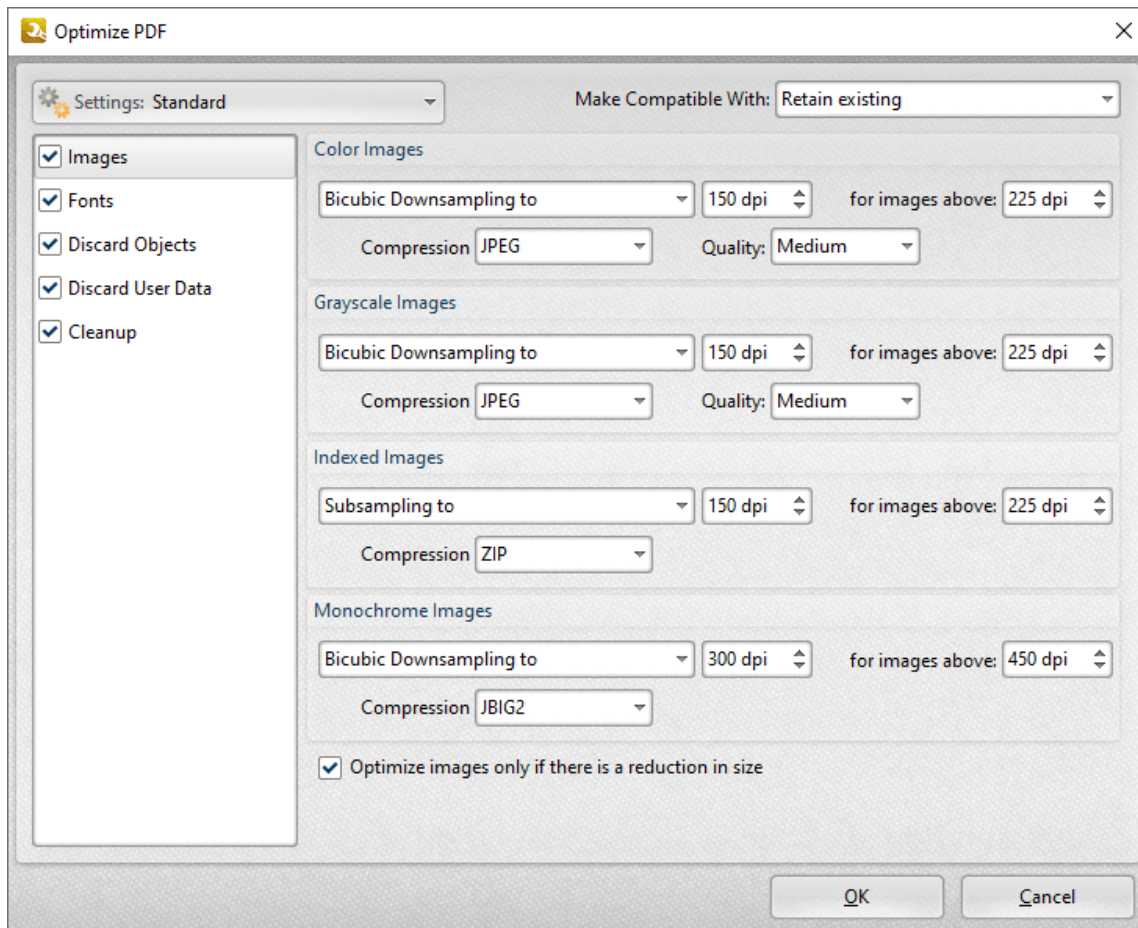

Figure 2. Optimize PDF Dialog Box, Images Tab

These settings are used to optimize PDF content:

## Images

The options for optimizing images are detailed in *(figure 2)*. They are as follows:

- Click the **Color Images**, **Grayscale Images**, **Indexed Images** and **Monochrome Images** menus to select settings for the respective image formats.
- Click the **Bicubic Downsampling/Subsampling** menus to increase/reduce the resolution of images.
- Click the arrows in the **dpi** box, or enter a figure manually, to select the dots-per-inch resolution for new images.
- Click the arrows in the **for images above** box, or enter a figure manually, to select the minimum **dpi** at which images are downsampled/subsampled.
- Click the **Compression** menus to select the compression format of images. Where applicable click the **Quality** menu to select the compression quality.
- The **Optimize images only if there is a reduction in size** box is selected by default. Clear this box to optimize images even when there is no reduction in size.

## Fonts

Click **Fonts** to determine the settings for font optimization:

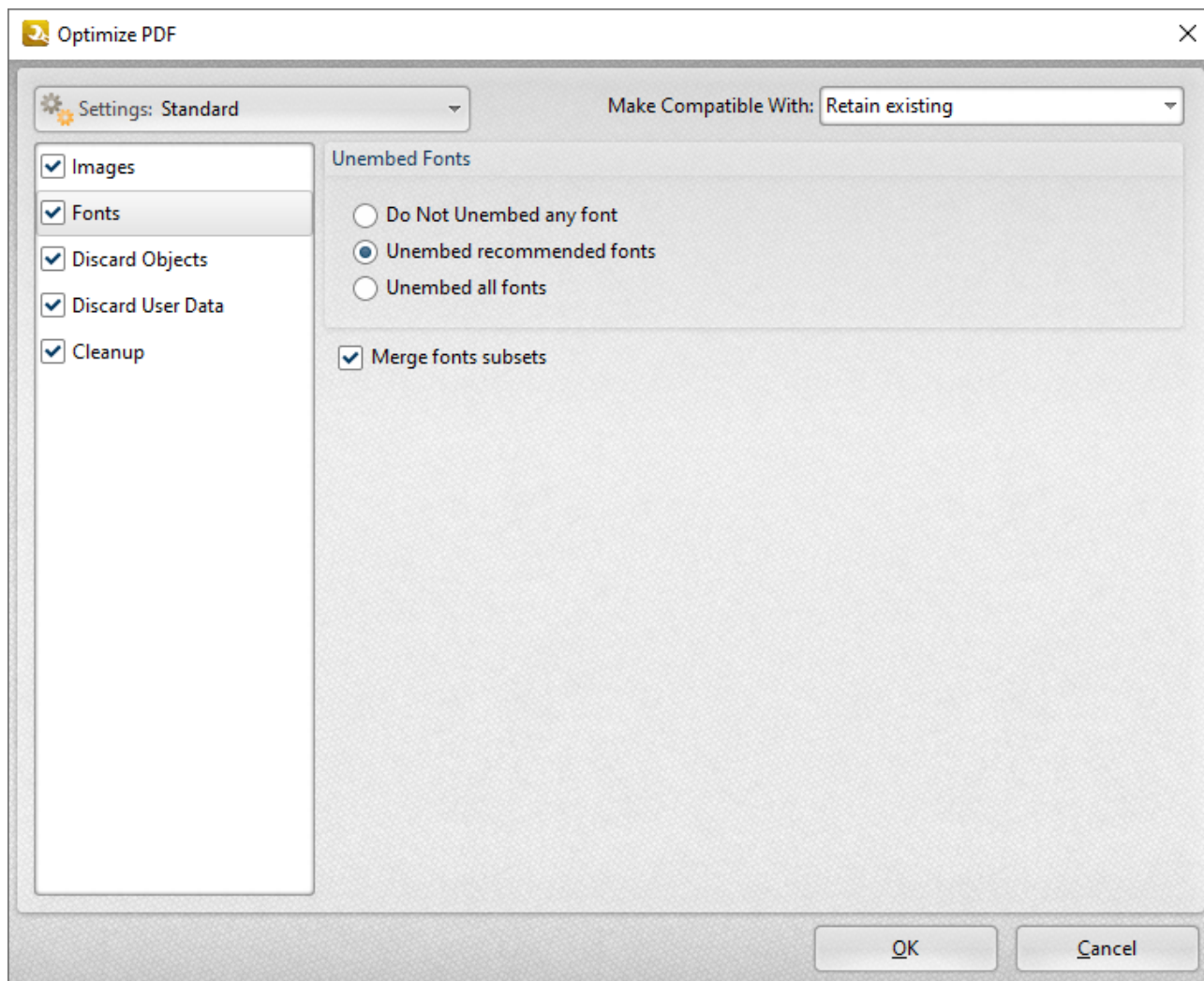

Figure 3. Optimize PDF Dialog Box, Fonts Tab

- Select **Do Not Unembed any font** to retain all embedded fonts.
- Select **Unembed recommended fonts** to unembed recommended fonts, which will result in the unembedding of the most common fonts in order to reduce the file size.
- Select **Unembed all fonts** to unembed all fonts. This will reduce the size of files as far as possible with regard to fonts. However, it also increases the risk of compatibility issues for subsequent users of the document. This is because they will not be able to read the document unless the application they are using to view the document contains the font. Therefore this setting should be used only in cases where documents contain only common fonts.
- Select the **Merge fonts subsets** box to merge duplicated font subsets.

## Discard Objects

Click **Discard Objects** to determine the settings for discarding objects:

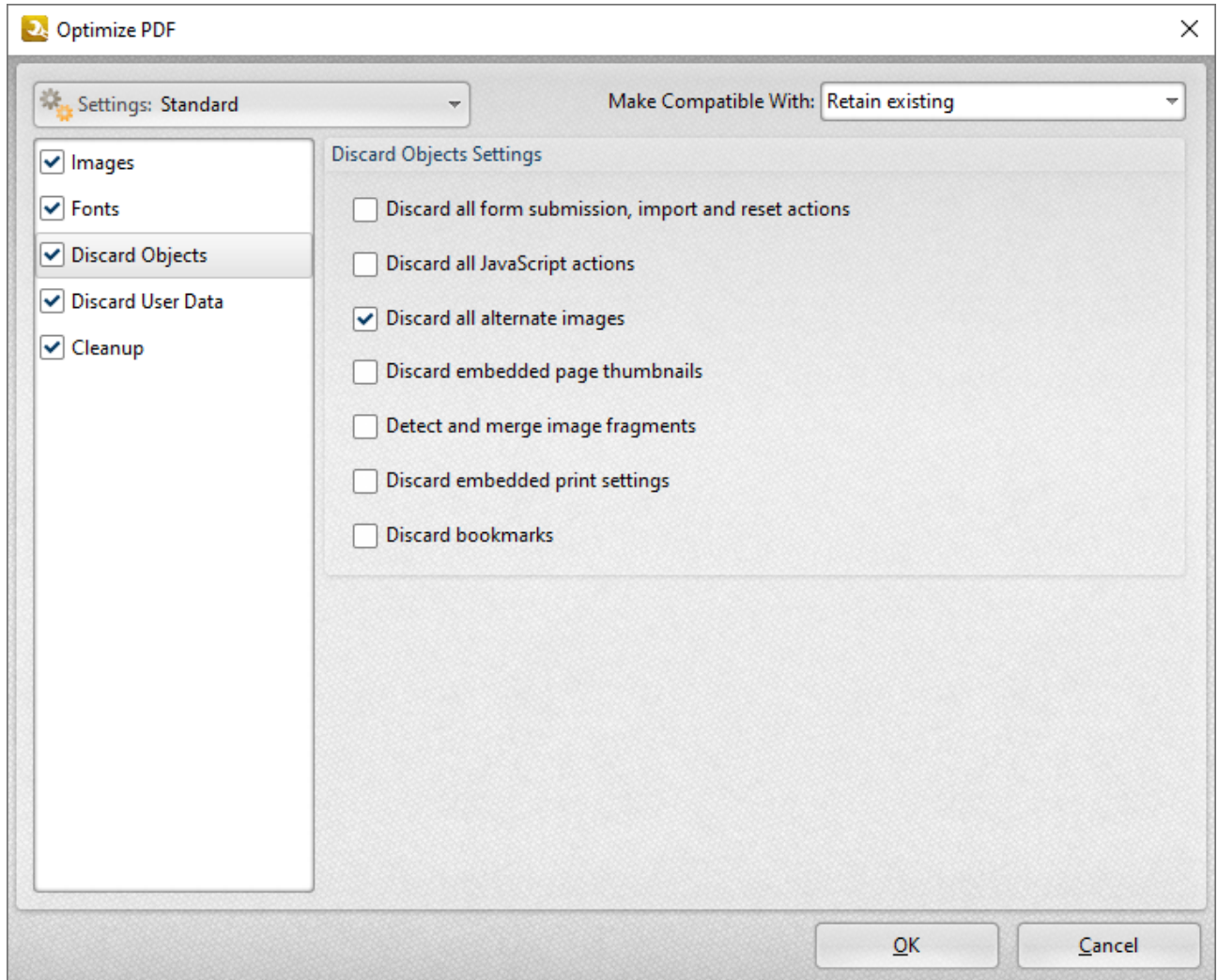

Figure 4. Optimize PDF Dialog Box, Discard Objects Tab

- Select the **Discard all form submissions, import and reset actions** box to remove these elements from the document.
- Select the **Discard all JavaScript actions** box to remove JavaScript actions from the document.
- Select the **Discard all alternate images** box to remove alternate images from the document. Alternate images are additional versions of existing images that may differ slightly, such as in resolution or color space.
- Select the **Discard embedded page thumbnails** box to remove embedded page thumbnails from the document.
- Select the **Detect and merge image fragments** box to merge image fragments. Note that some images are composed of fragmented sections that are spliced together. Merging these fragments will reduce the file size.

- Select the **Discard embedded print settings** box to discard remnant encoding in cases where documents were created with a virtual printer.
- Select the **Discard bookmarks** box to remove all bookmarks from the document.

## Discard User Data

Click **Discard User Data** to determine the settings for discarding user data:

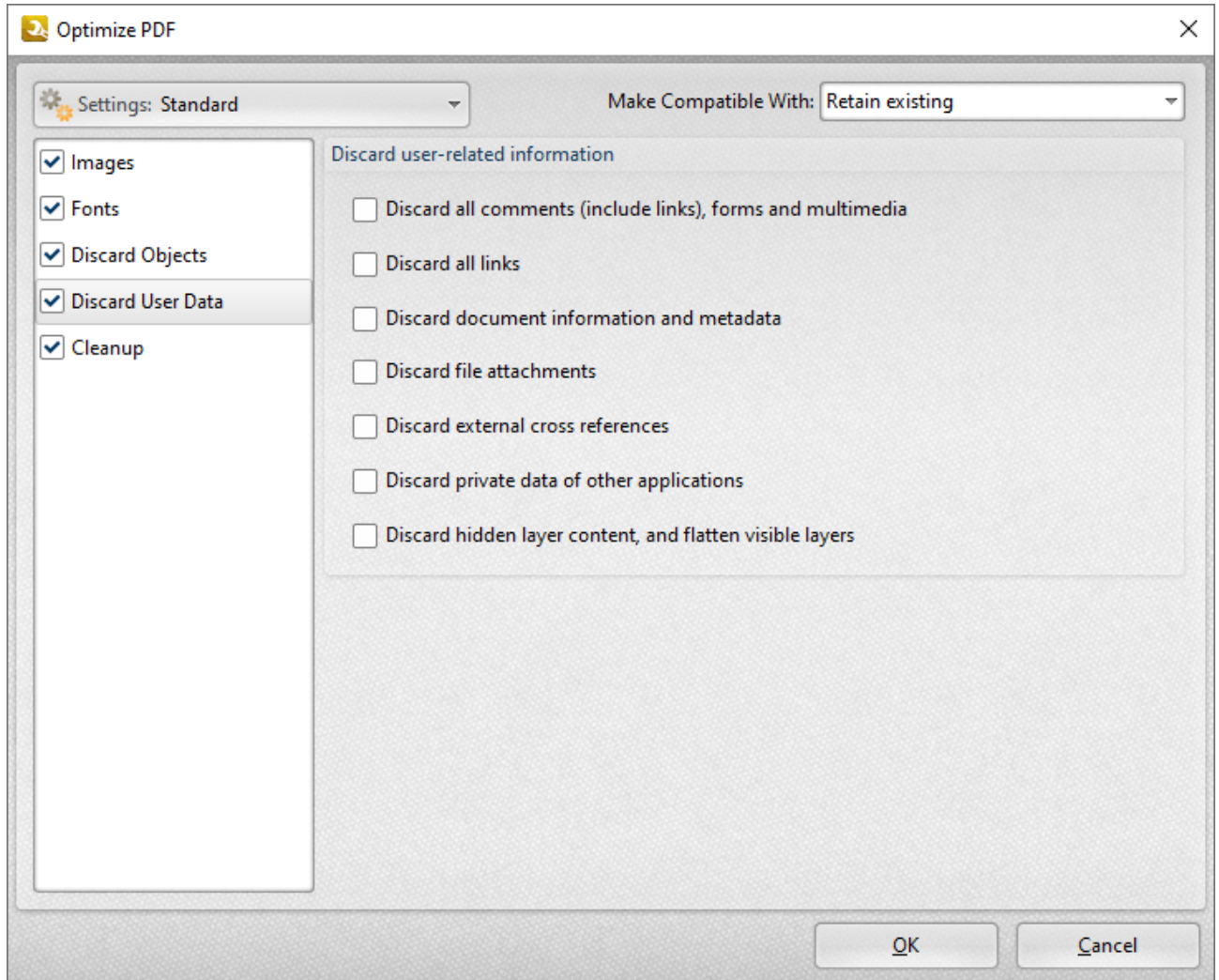

Figure 5. Optimize PDF Dialog Box, Discard User Data Tab

- Select the **Discard all comments, forms and multimedia** box to remove these elements from the document.
- Select the **Discard document information and metadata** box to remove all metadata from the document.
- Select the **Discard file attachments** box to remove attached/embedded files from the document.

- Select the **Discard private data of other applications** box to remove information from the document that is useful only to the application used to create it.
- Select the **Discard hidden layer content and flatten visible layers** box to remove hidden layers from the document and flatten the visible layers to base content.

## Cleanup

Click **Cleanup** to determine cleanup options:

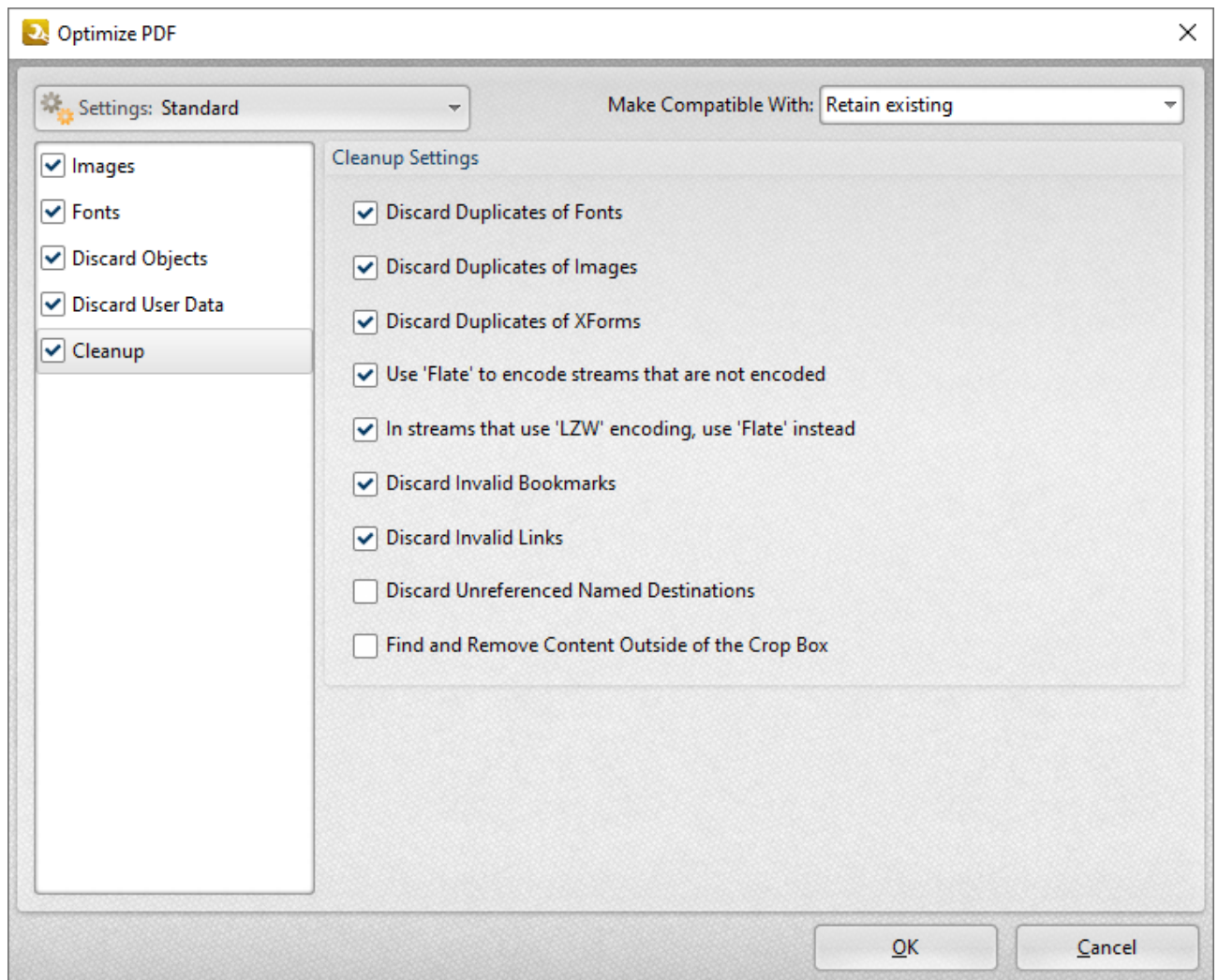

Figure 6. Optimize PDF Dialog Box, Cleanup Tab

- Select the **Discard Duplicates of Fonts** box to remove redundant fonts from the document.
- Select the **Discard Duplicates of Images** box to remove duplicate images from the document.
- Select the **Discard duplicates of XForms** box to remove duplicate XForms from the document.
- Select the **Use Flate to encode streams that are not encoded** box to compress document information that is pending for compression.

- Select the **In Streams that use LZW encoding use Flate instead** box to use **Flate** compression instead of LZW encoding. This is recommended as **Flate** is compatible with a wider range of platforms.
- Select the **Discard Invalid Bookmarks** box to discard bookmarks that do not contain actions/valid destinations.
- Select the **Discard Unreferenced Named Destinations** box to remove named destinations that are not referenced in the document.
- Select the **Find and Remove Content Outside of the Crop Box** box to remove content outside the crop box. Note that this content is hidden when documents are displayed.

**Settings**

Click the **Settings** dropdown menu to toggle between **Standard Mode**, which is best for computers, and **Mobile Mode**, which is best for tablets and cell phones:

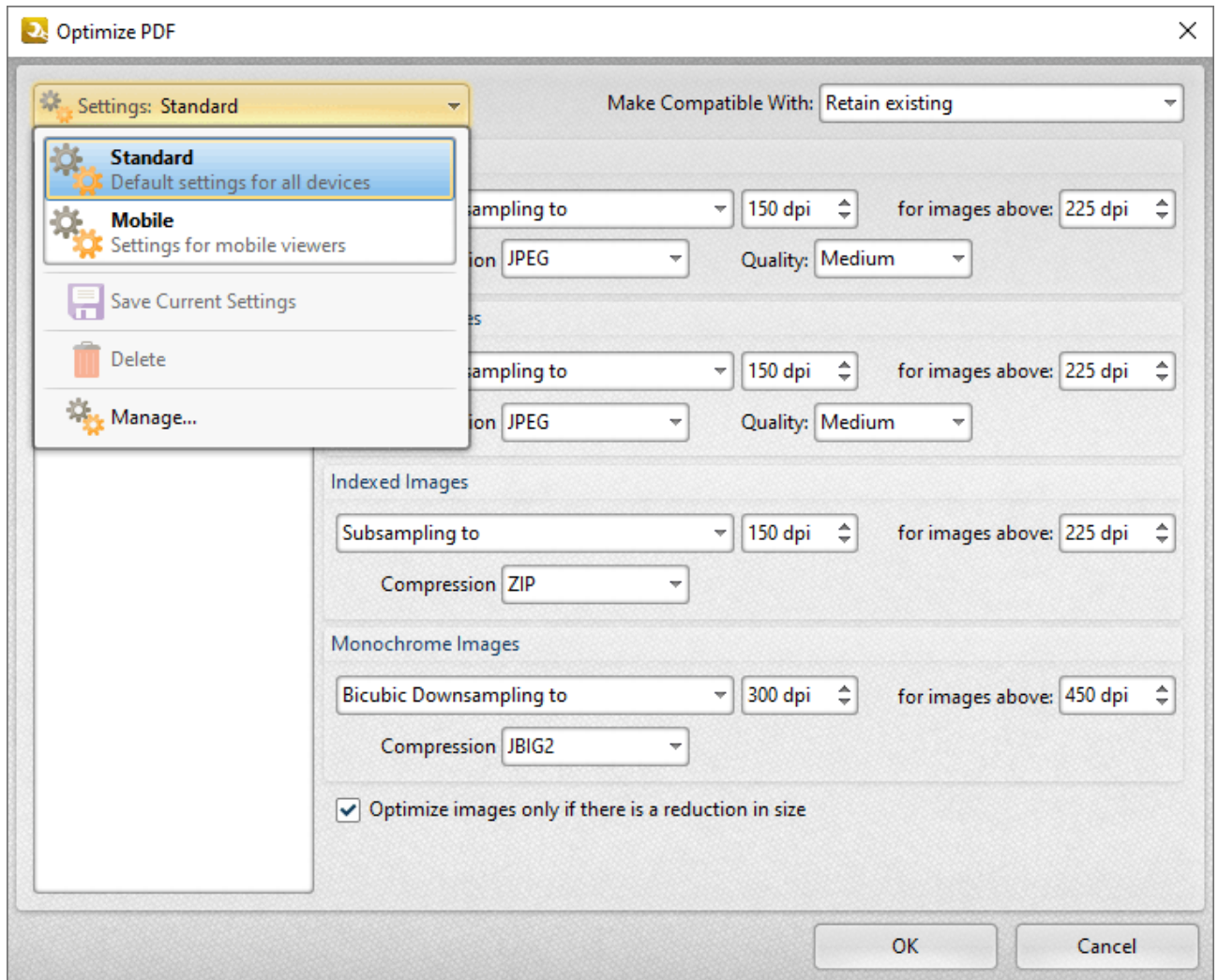
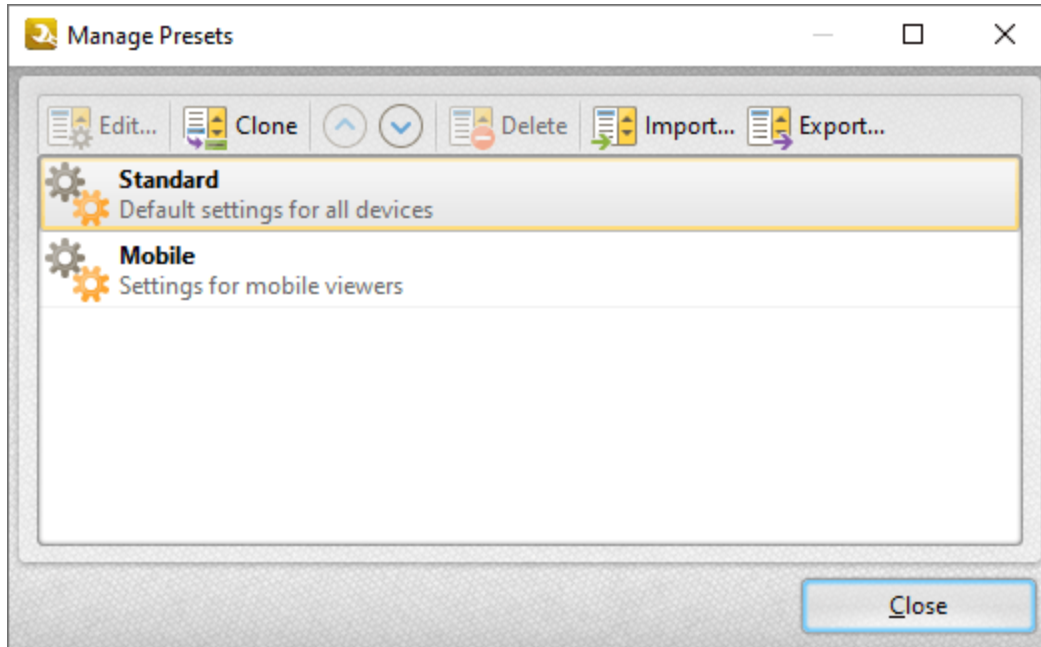

Figure 7. Optimize PDF Dialog Box, Settings Dropdown Menu



The **Settings** dropdown menu is also used to save, manage and delete customized settings:

- Click **Save Current Settings** to save custom settings for subsequent use. Saved profiles are detailed in the **Settings** dropdown menu.
- Click **Delete** to delete selected profiles.
- Click **Manage** to manage saved custom settings. The **Manage Presets** dialog box will open, as detailed below.



**Figure 8.** Manage Presets Dialog Box

- Click **Edit** to edit selected profiles.
- Click **Clone** to clone selected profiles. This makes it possible to duplicate profiles and then customize their settings whilst retaining the existing profile and its parameters.
- Use the up and down arrow to move selected profiles up or down in the list.
- Click **Delete** to delete selected profiles.
- Click **Import** to import profiles from a saved file.
- Click **Export** to export profiles to file.

Select an option in the **Make Compatible With** dropdown menu to make optimized documents compatible with specified versions of **Acrobat**:

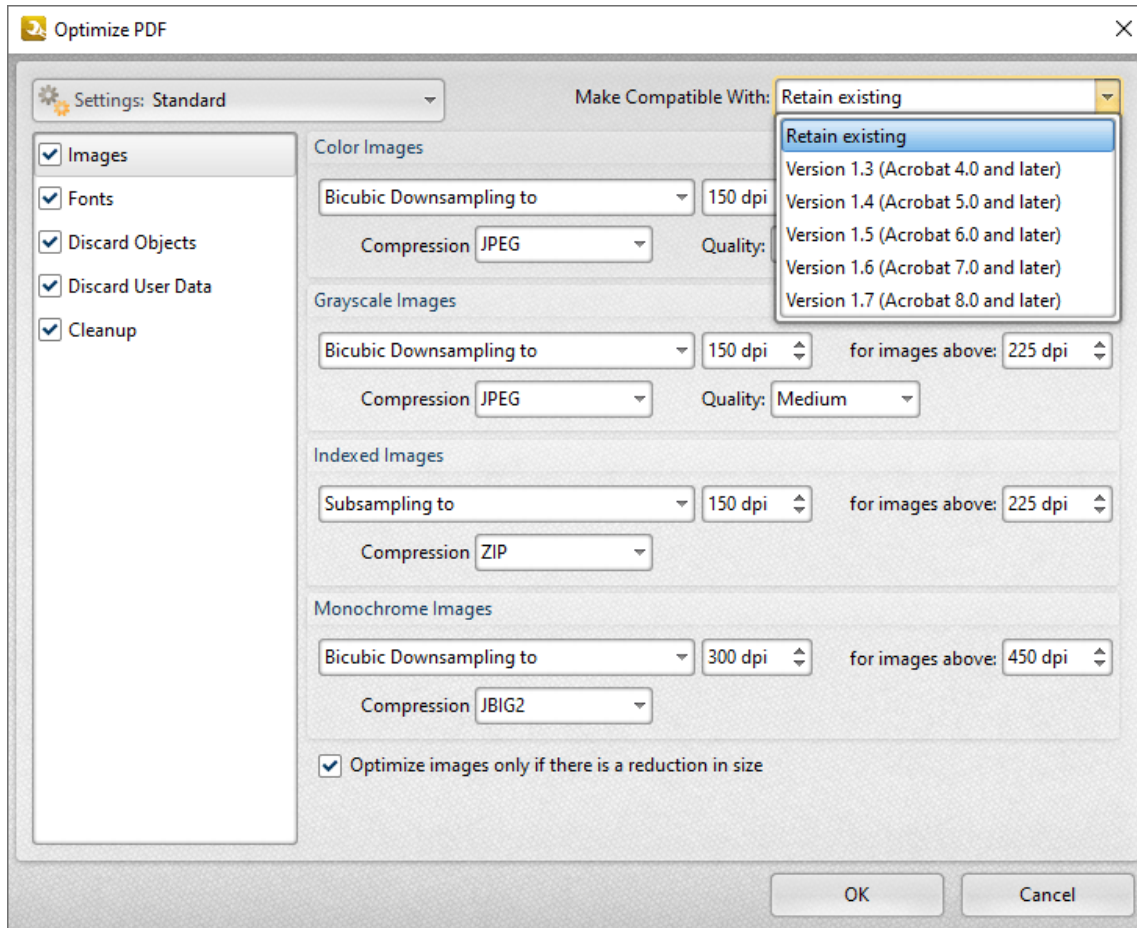

Figure 9. Optimize PDF Dialog Box, Make Compatible Dropdown Menu

Click **OK** to save changes.

## 7.6 PDF Standard Actions

---





### PDF Standard Actions

---

The **PDF Standard** actions make documents compliant with alternative PDF formats:

 **Convert to PDF/A**<sup>180</sup> makes documents compliant with the PDF/A format, which is used for long-term archiving.

 **Convert to PDF/X**<sup>182</sup> makes documents compliant with the PDF/X standard, which is used to exchange printing data.

 **Discard Special PDF-Standard**<sup>184</sup> discards special PDF information from documents such as PDF/X, PDF/A and PDF/E information.

---

## 7.6.1 Convert to PDF/A



The **Convert to PDF/A** action makes documents compliant with the PDF/A format, which is used for long-term archiving. It contains the following customizable parameters:

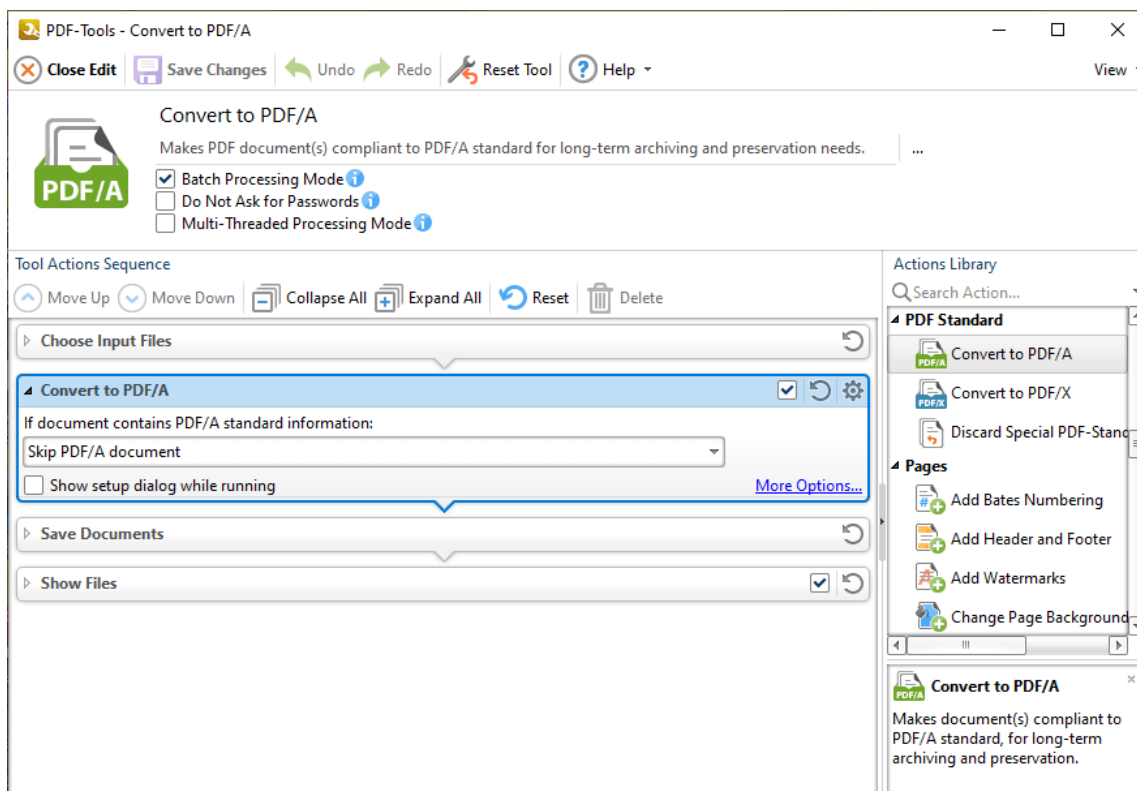

Figure 1. Convert to PDF/A Action Options

- Select an option in the dropdown menu to determine the action taken in cases where input documents already contain PDF/A information:
  - **Skip PDF/A document** excludes the document from the process.
  - **Keep PDF/A document unchanged** retains the existing version of the document.
  - **Reconvert document** performs a fresh conversion of the document to PDF/A format.
- Click **More Options** to view/edit all options. The **Convert to PDF/A** dialog box will open, as detailed below.

- Select the **Show setup dialog while running** box to launch the **Convert to PDF/A** dialog box and customize settings each time this action is used. Clear this box to disable the **Convert to PDF/A** dialog box from opening each time the action is used, which is useful when the same settings are used consistently.

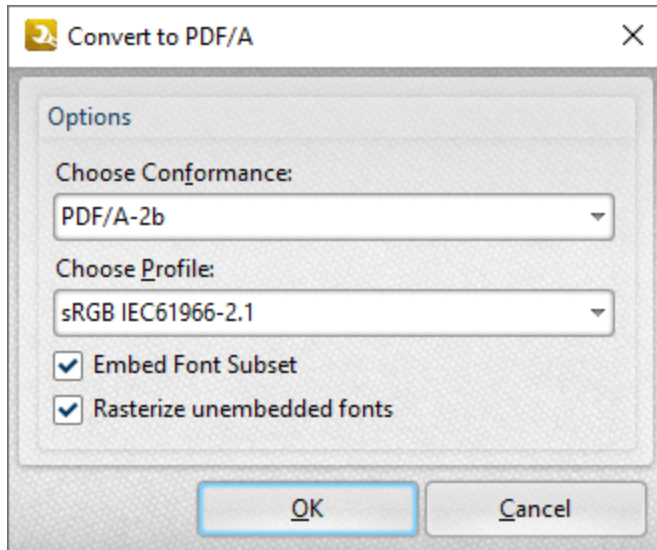

Figure 2. Convert to PDF/A Dialog Box

- Select an option in the **Choose conformance** dropdown menu to determine the file conformance. Further information on conformance options is available [here](#).
- Select an option in the **Choose profile** dropdown menu to select a color profile.
- Select/clear the **Embed Font Subset** and **Rasterize unembedded fonts** boxes as desired.

Click **OK** to save changes.

---

## 7.6.2 Convert to PDF/X



The **Convert to PDF/X** action makes documents compliant with the PDF/X standard, which is used to exchange printing data. It contains the following customizable parameters:

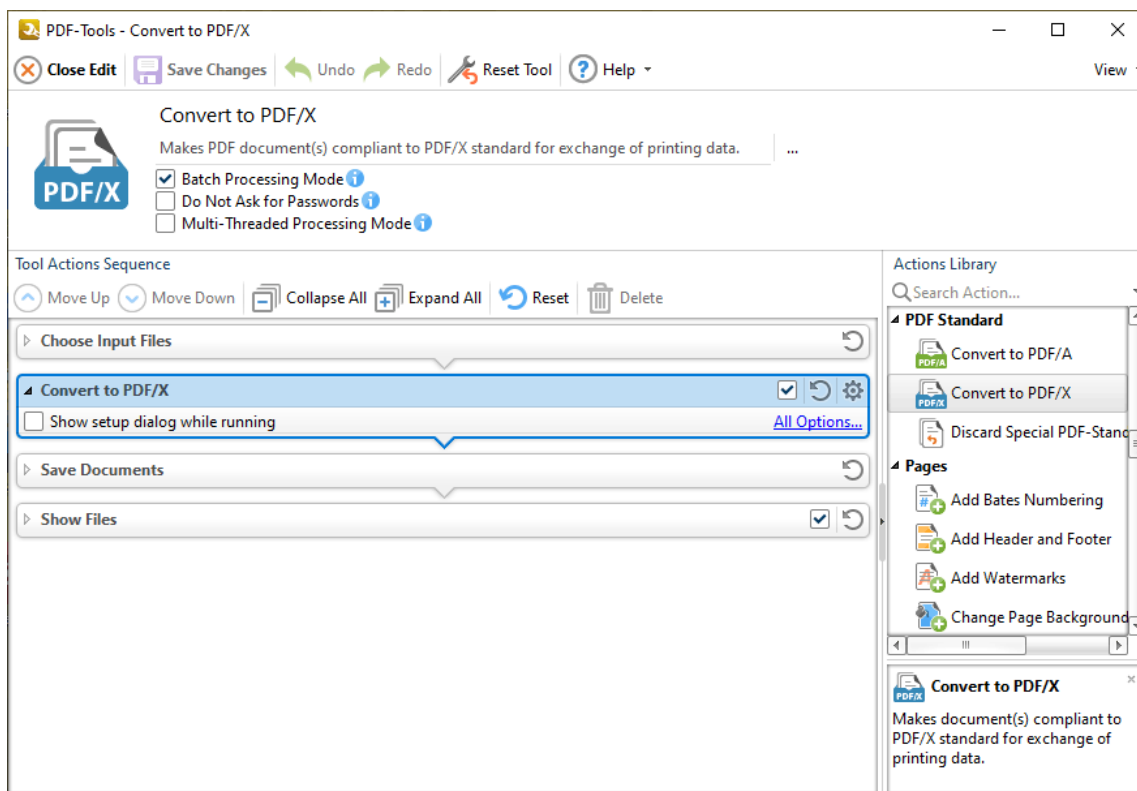

Figure 1. Convert to PDF/A Action Options

- Click **All Options** to view/edit all options. The **Convert to PDF/X** dialog box will open, as detailed below.
- Select the **Show setup dialog while running** box to launch the **Convert to PDF/X** dialog box and customize settings each time this action is used. Clear this box to disable the **Convert to PDF/X** dialog box from opening each time the action is used, which is useful when the same settings are used consistently.

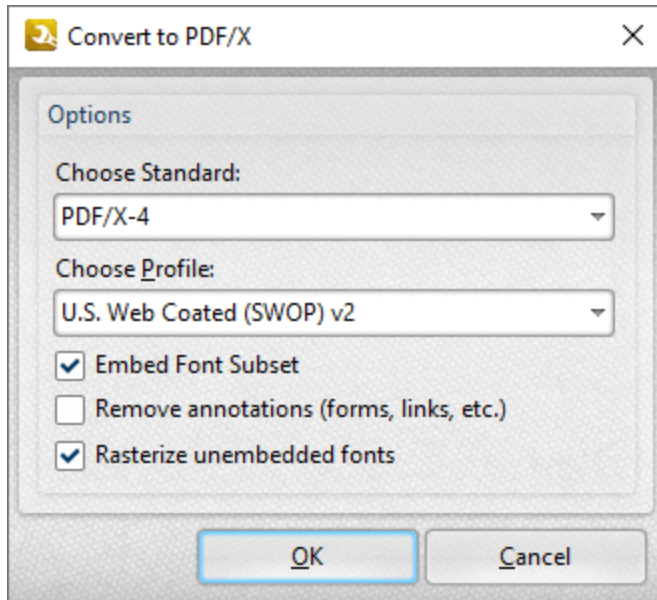

Figure 2. Convert to PDF/X Dialog Box

- Use the **Choose Standard** dropdown menu to select a PDF/X format. Further information on these formats is available [here](#).
- Use the **Choose Profile** dropdown menu to select a color profile.
- Select the **Embed Font Subset** box to embed font subsets in output documents.
- Select the **Remove annotations** box to remove annotations in output documents.
- Select the **Rasterize unembedded fonts** box to rasterize unembedded fonts.

Click **OK** to save changes.

---

## 7.6.3 Discard Special PDF-Standard



### Discard Special PDF-Standard

The **Discard Special PDF-Standard** action discards special PDF-standard information from documents. It contains the following customizable parameters:

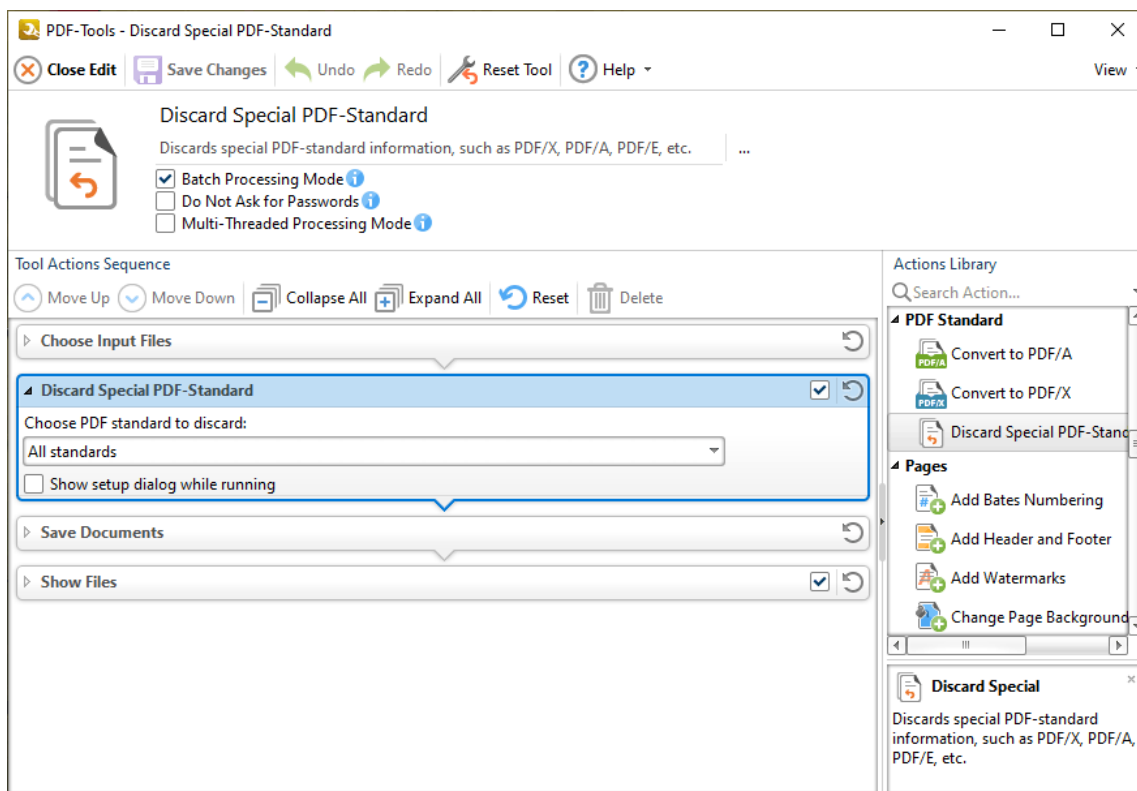

Figure 1. Convert to PDF/A Action Options

- Select an option from the **Choose PDF Standard to discard** dropdown menu to determine the PDF standard discarded from documents when the tool runs.
- Select the **Show setup dialog while running** box to launch the **Discard Special PDF-Standard** dialog box and customize settings each time this action is used. Clear this box to disable the **Discard Special PDF-Standard** dialog box from opening each time the action is used, which is useful when the same settings are used consistently.

Click  **Save Changes** to save changes.





## 7.7 Pages Actions



















---





### Pages Actions

---

The **Pages** actions edit and enhance the pages of input documents:

-  [Add Bates Numbering](#)<sup>[188]</sup> inserts Bates numbering into input documents.
-  [Add Header and Footer](#)<sup>[192]</sup> inserts headers and footers into input documents.
-  [Add Watermarks](#)<sup>[196]</sup> inserts watermarks into input documents.
-  [Change Page Background](#)<sup>[200]</sup> changes the background of input documents.
-  [Crop Pages](#)<sup>[204]</sup> adjusts document dimensions, white margins and page boxes in input documents.
-  [Delete Pages](#)<sup>[207]</sup> deletes pages of input documents.
-  [Duplicate Pages](#)<sup>[209]</sup> duplicates pages of input documents.
-  [Insert Empty Pages](#)<sup>[211]</sup> inserts empty pages into input documents.
-  [Insert Pages](#)<sup>[213]</sup> inserts pages from existing documents into input documents.
-  [Merge Pages](#)<sup>[216]</sup> merges pages into a single page.
-  [OCR Pages](#)<sup>[219]</sup> performs optical character recognition on input documents.
-  [Overlay PDF](#)<sup>[224]</sup> overlays input documents with existing files.
-  [Remove Bates Numbering](#)<sup>[226]</sup> removes Bates numbering from input documents.
-  [Remove Headers and Footers](#)<sup>[227]</sup> headers and footers from input documents.
-  [Remove Page Background](#)<sup>[228]</sup> removes backgrounds from input documents.
-  [Remove Watermarks](#)<sup>[229]</sup> removes watermarks from input documents.
-  [Replace Pages](#)<sup>[230]</sup> replaces specified pages of input documents with pages from existing documents.
-  [Resize Pages](#)<sup>[232]</sup> resizes specified pages of input documents.
-  [Rotate Pages](#)<sup>[235]</sup> rotates specified pages of input documents.

 [Setup Page Transitions](#)<sup>237</sup> determines the animated effect when moving between document pages in fullscreen mode.

 [Split Pages](#)<sup>239</sup> splits the pages of input documents into custom sections.

---

## 7.7.1 Add Bates Numbering



The **Add Bates Numbering** action inserts Bates numbering into input documents. It contains the following customizable parameters:

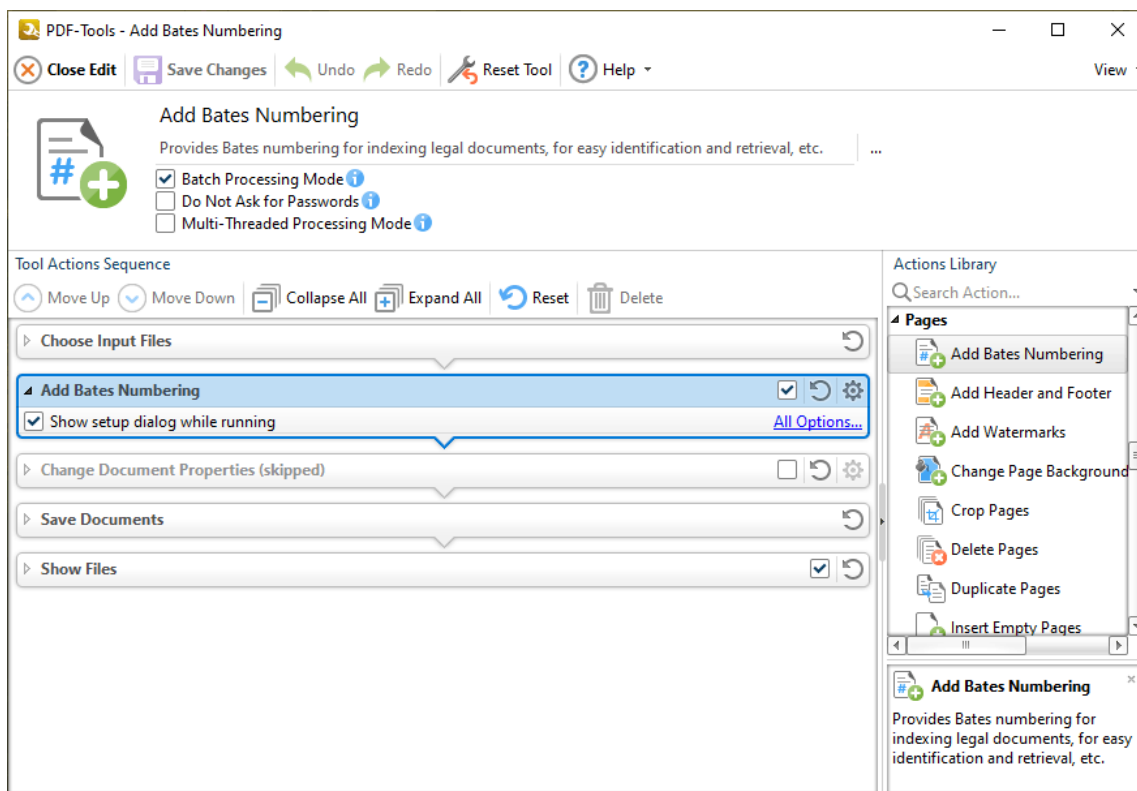

**Figure 1.** Add Bates Numbering Action Options

- Click **All Options** to view/edit all options. The **Add Bates Numbering** dialog box will open, as detailed below.
- Select the **Show setup dialog while running** box to launch the **Add Bates Numbering** dialog box and customize settings each time this action is used. Clear this box to disable the **Add Bates Numbering** dialog box from opening each time the action is used, which is useful when the same settings are used consistently.

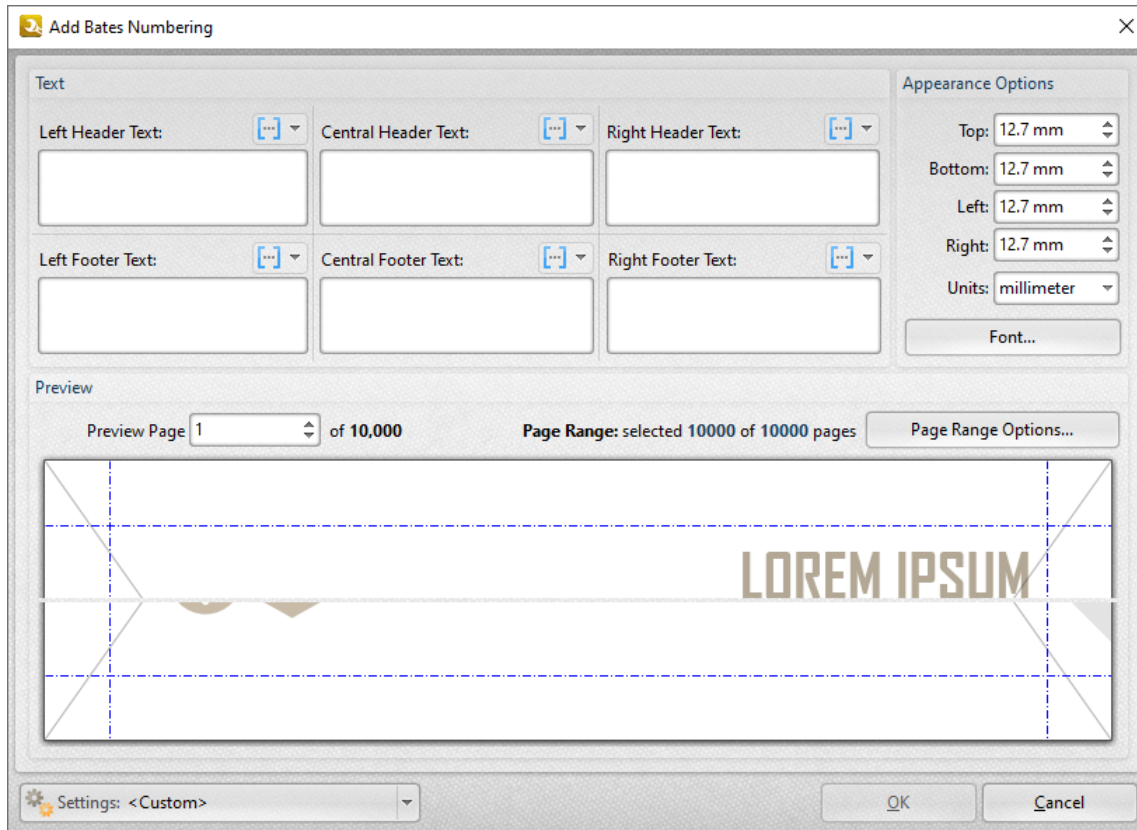



Figure 2. Add Bates Numbering Dialog Box

- Enter text in the text boxes to insert Bates numbering on the left/center/right and as a header/footer of pages as desired. Alternatively, click the  macro icon to use [macros](#)<sup>488</sup> as the source of Bates numbering content. Select **Bates Numbering** in the macro dropdown menu to add Bates numbering in the default style, or click **Bates Numbering Settings** to customize the style of Bates numbering used. Further information about macros is available [here](#).<sup>488</sup>
- Click **Font** to determine the font settings for Bates numbering, as detailed [here](#).<sup>486</sup>
- Use the **Appearance Options** settings to reposition the location of Bates numbering.
- Enter page numbers in the **Preview Page** number box to view a preview of Bates numbering in the preview window.
- Click **Page Range Options** to select the pages of the document that will feature Bates numbering. Further information on the specification of page ranges is available [here](#).<sup>552</sup>
- Click the **Settings** dropdown arrow to save/delete customized settings and/or manage existing customized settings, as detailed below.

Click **OK** to save settings.

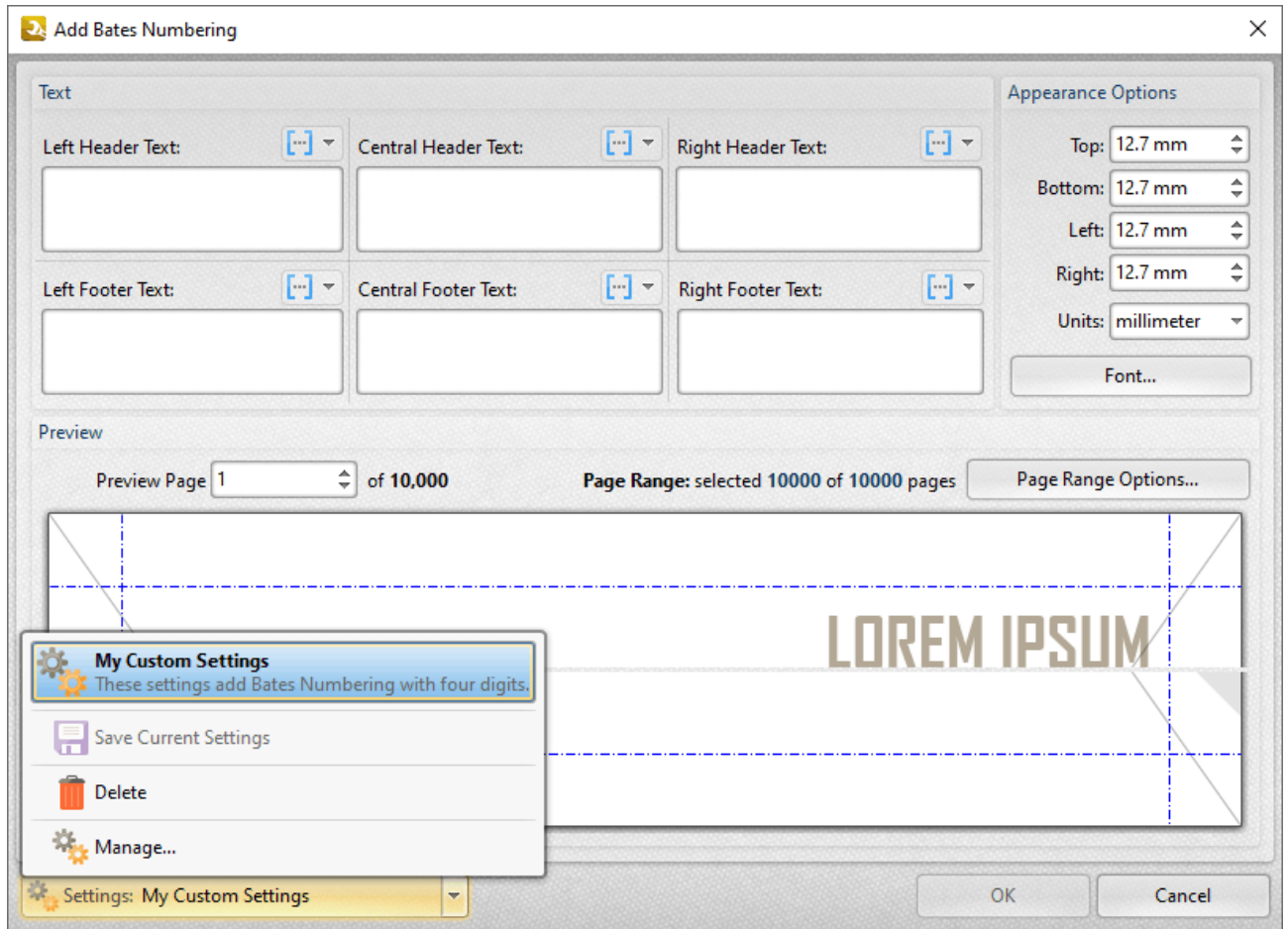





Figure 3. Add Bates Numbering Dialog Box, Settings Dropdown Menu

- Click  **Save** to save the current settings to a profile for subsequent use.
- Click  **Delete** to delete the current profile.
- Click  **Manage** to manage saved profiles. The **Manage Presets** dialog box will open:

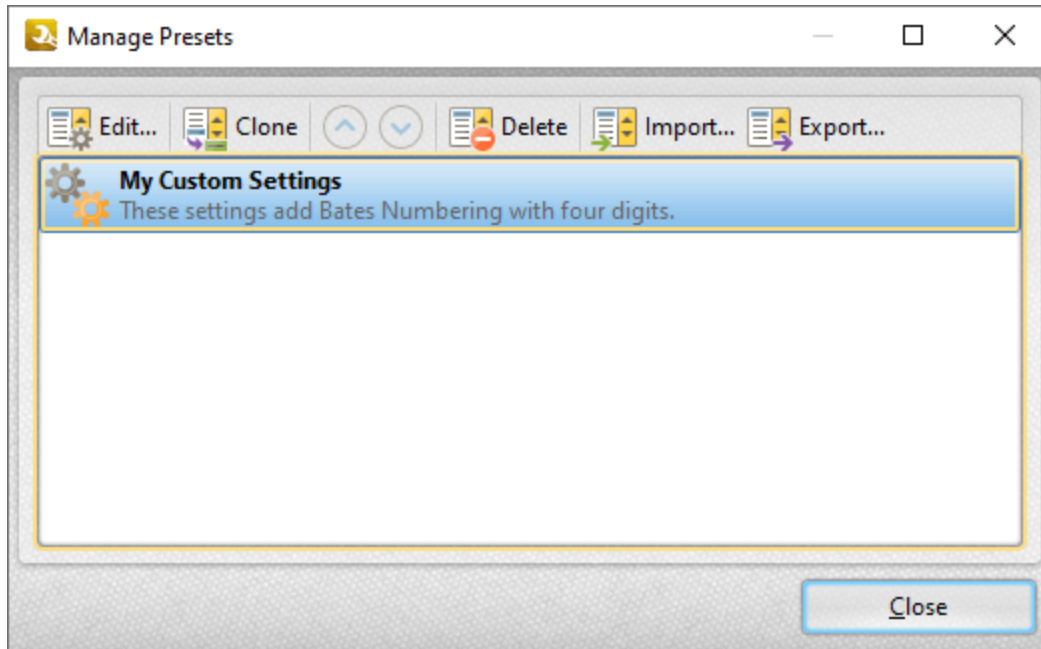

Figure 4. Manage Presets Dialog Box

- Click **Edit** to edit selected profiles.
- Click **Clone** to clone selected profiles.
- Use the up and down arrows to move selected profiles up or down in the list.
- Click **Delete** to delete selected profiles.
- Click **Import** to import profiles from a saved file.
- Click **Export** to export profiles to file.

## 7.7.2 Add Header and Footer



The **Add Header and Footer** action inserts headers and footers into input documents. It contains the following customizable parameters:

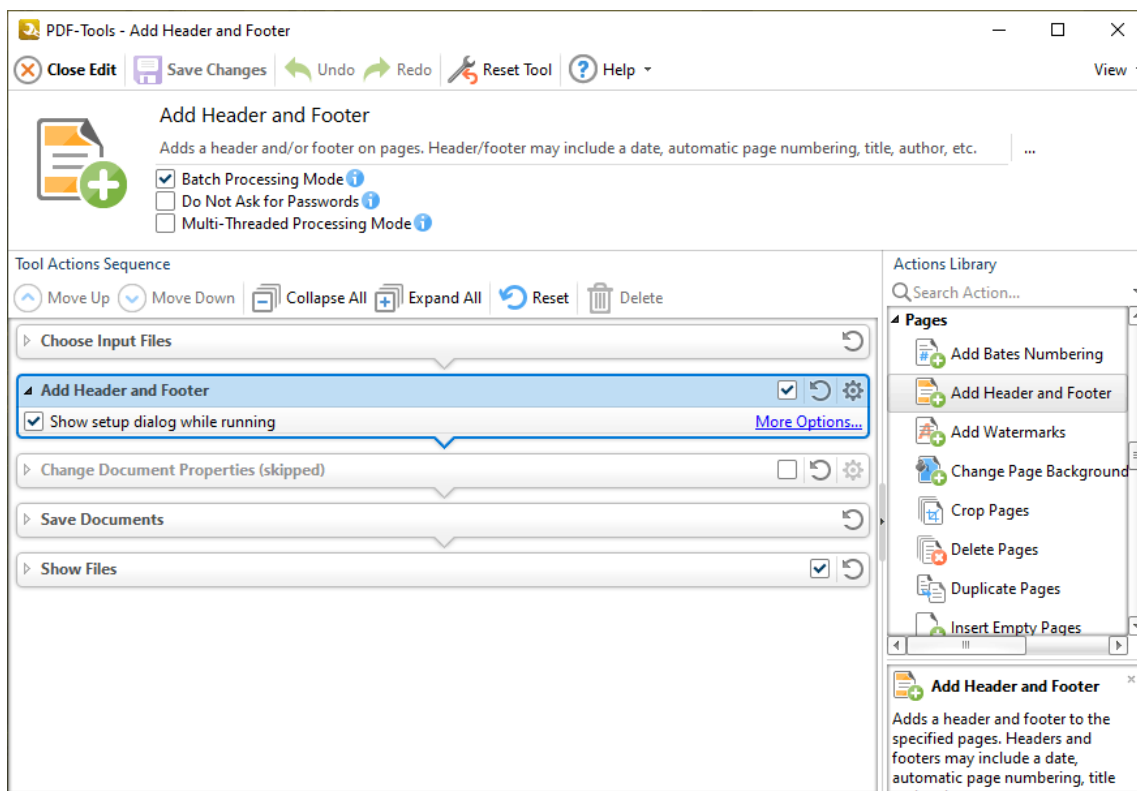

Figure 1. Add Header and Footer Action Options

- Click **More Options** to view/edit more options. The **Add Header and Footer** dialog box will open, as detailed below.
- Select the **Show setup dialog while running** box to launch the **Add Header and Footer** dialog box and customize settings each time this action is used. Clear this box to disable the **Add Header and Footer** dialog box from opening each time the action is used, which is useful when the same settings are used consistently.



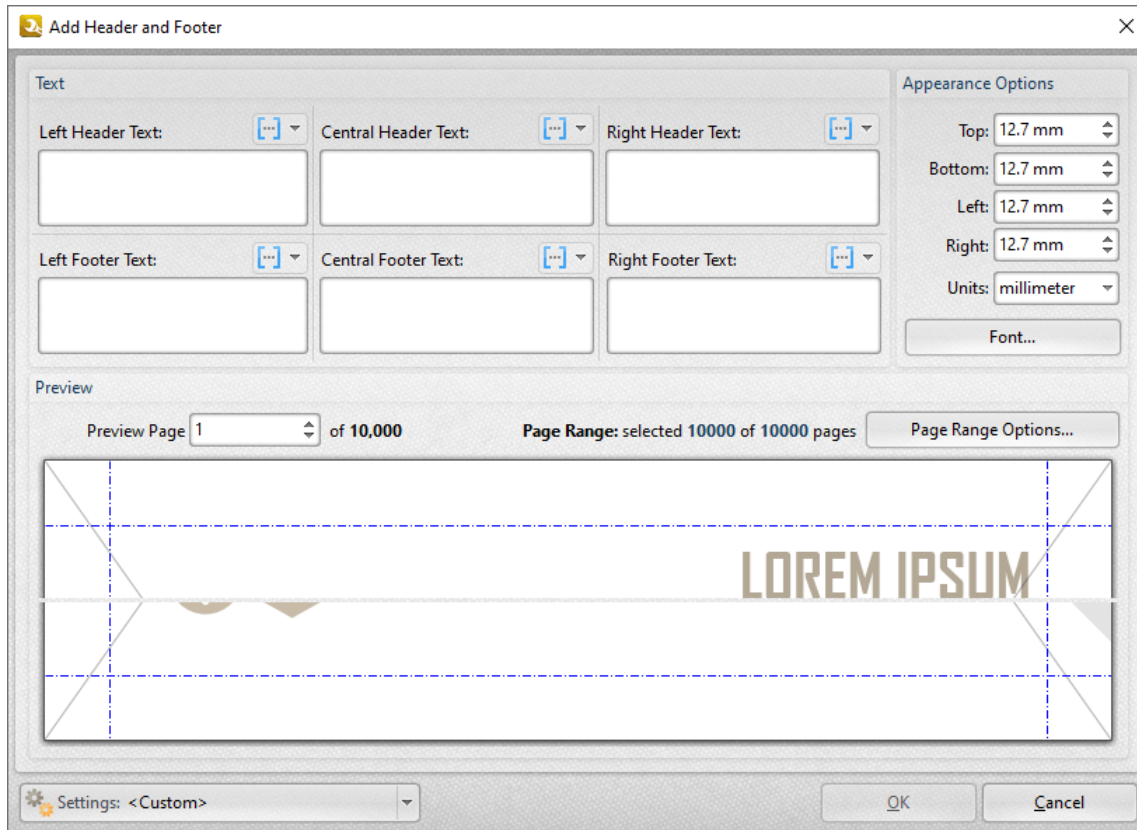



Figure 2. Add Header and Footer Dialog Box

- Enter text in the text boxes to insert headers/footers on the left/center/right of documents. Alternatively, click the  macro icon to source the content of headers/footers with macros. Note that the current page numbering style is detailed in the macro dropdown menu. Click **Edit Page Numbering Style** to change the page numbering style. Further information about macros is available [here](#).<sup>[488]</sup>
- Click **Font** to determine the font settings for headers/footers, as detailed [here](#).<sup>[486]</sup>
- Use the **Appearance Options** settings to reposition the location of headers/footers.
- Enter page numbers in the **Preview Page** number box to view a preview of headers/footers in the preview window.
- Click **Page Range Options** to select the pages of the document that will feature headers/footers. Further information on the specification of page ranges is available [here](#).<sup>[552]</sup>
- Click the **Settings** dropdown arrow to save/delete customized settings and/or manage existing customized settings, as detailed below.

Click **OK** to save settings.

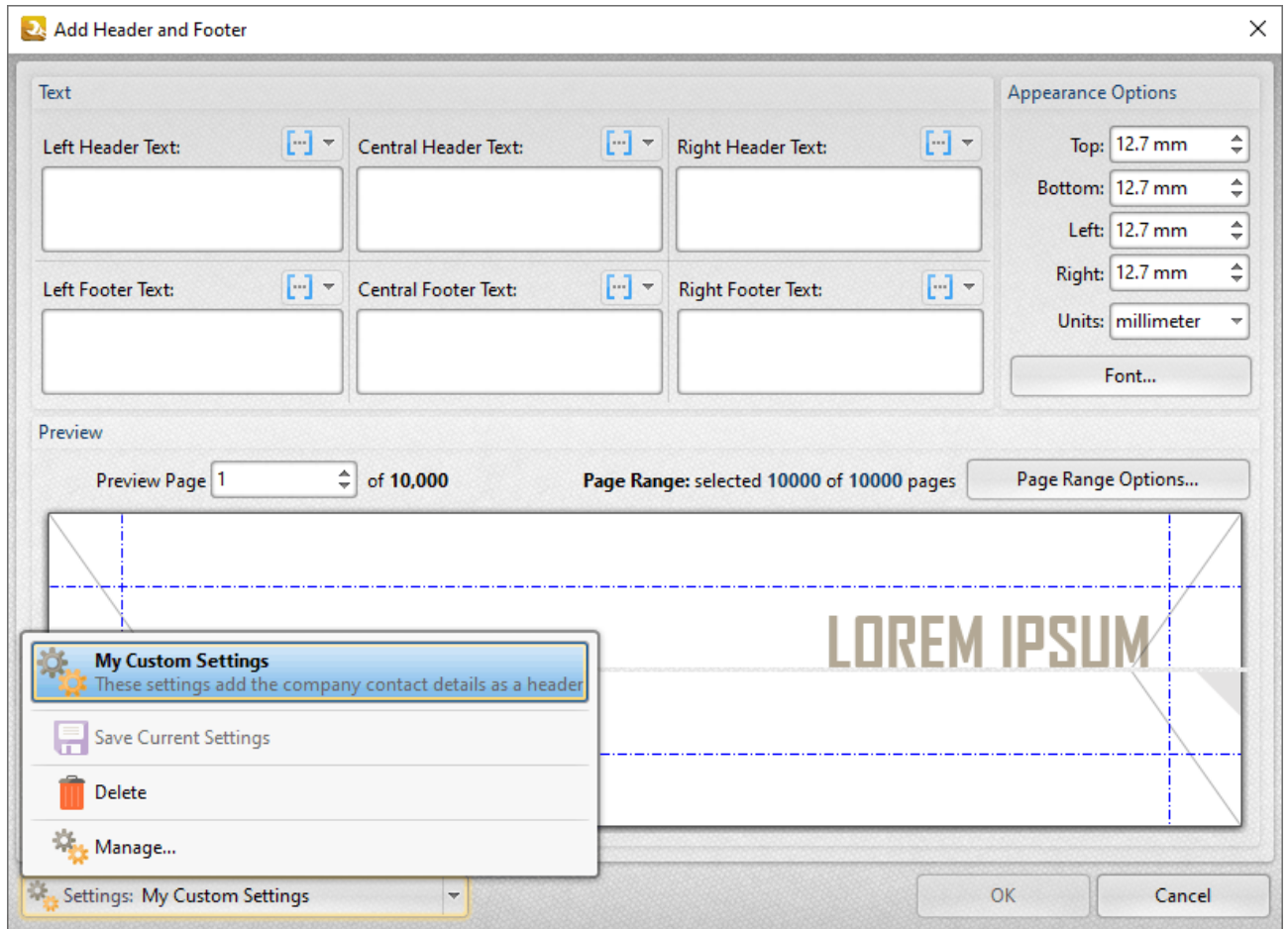



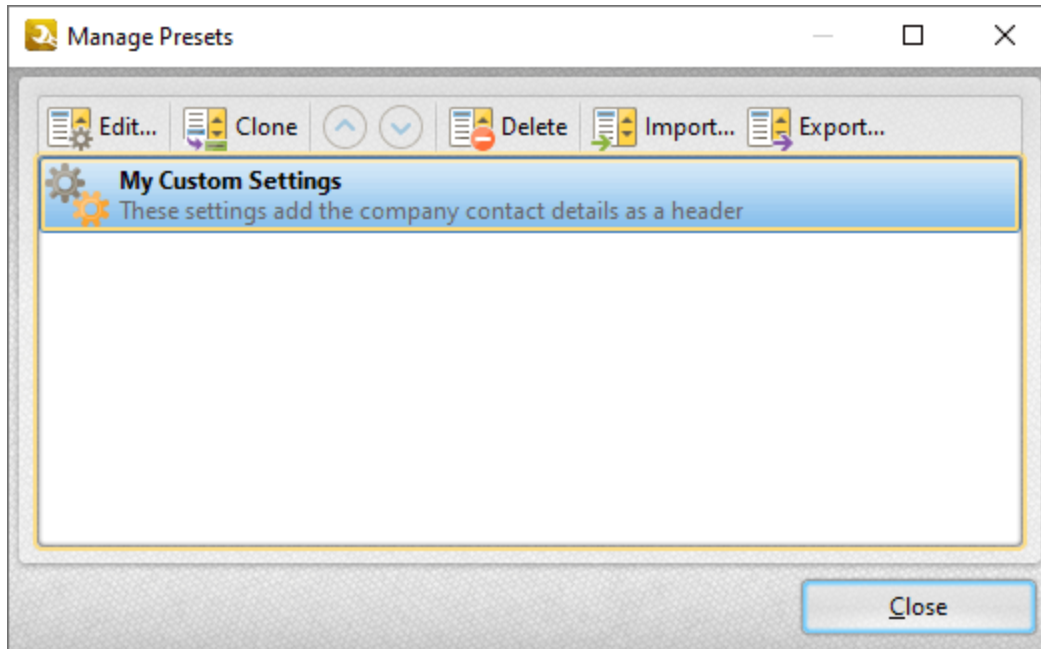

Figure 3. Add Bates Numbering Dialog Box, Settings Dropdown Menu

- Click  **Save** to save the current settings to a profile for subsequent use.
- Click  **Delete** to delete the current profile.
- Click  **Manage** to manage saved profiles. The **Manage Presets** dialog box will open:



**Figure 4.** Manage Presets Dialog Box

- Click **Edit** to edit selected profiles.
- Click **Clone** to clone selected profiles.
- Use the up and down arrows to move selected profiles up or down in the list.
- Click **Delete** to delete selected profiles.
- Click **Import** to import profiles from a saved file.
- Click **Export** to export profiles to file.

## 7.7.3 Add Watermarks



The **Add Watermarks** action inserts watermarks into input documents. It contains the following customizable parameters:

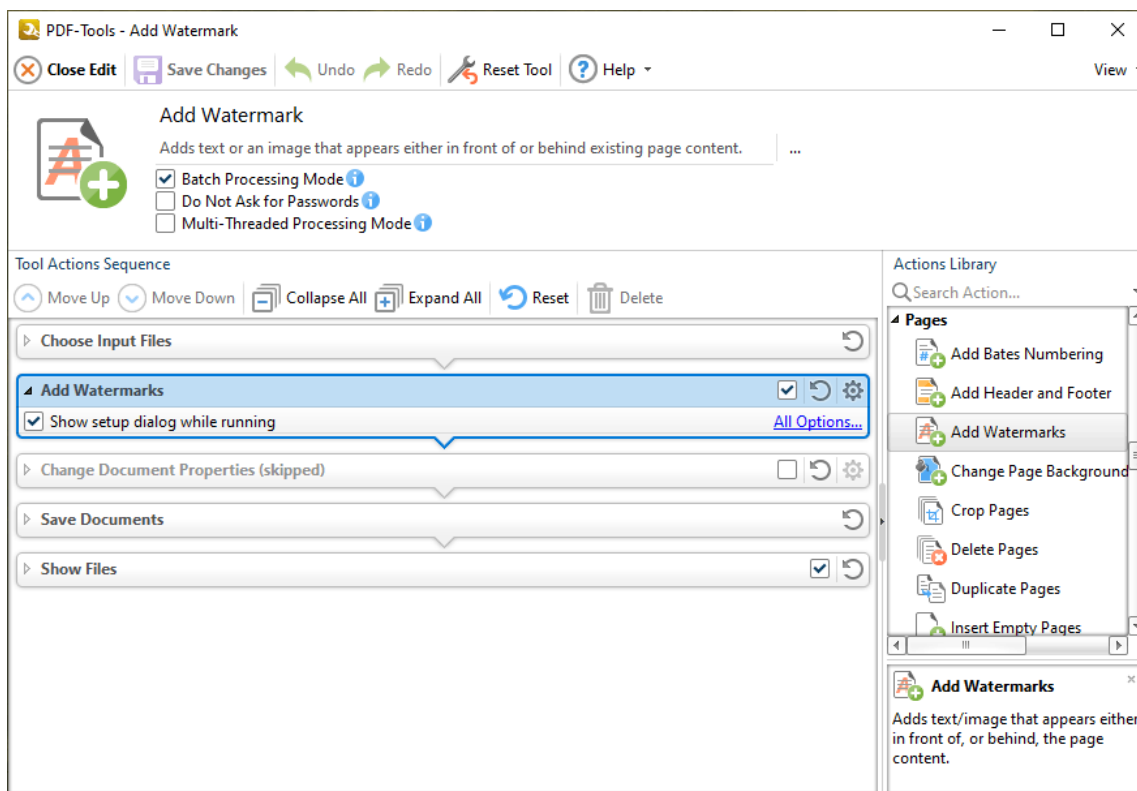

**Figure 1.** Add Watermark Action Options

- Click **All Options** to view/edit all options. The **Add Watermark** dialog box will open, as detailed below.
- Select the **Show setup dialog while running** box to launch the **Add Watermark** dialog box and customize settings each time this action is used. Clear this box to disable the **Add Watermark** dialog box from opening each time the action is used, which is useful when the same settings are used consistently.

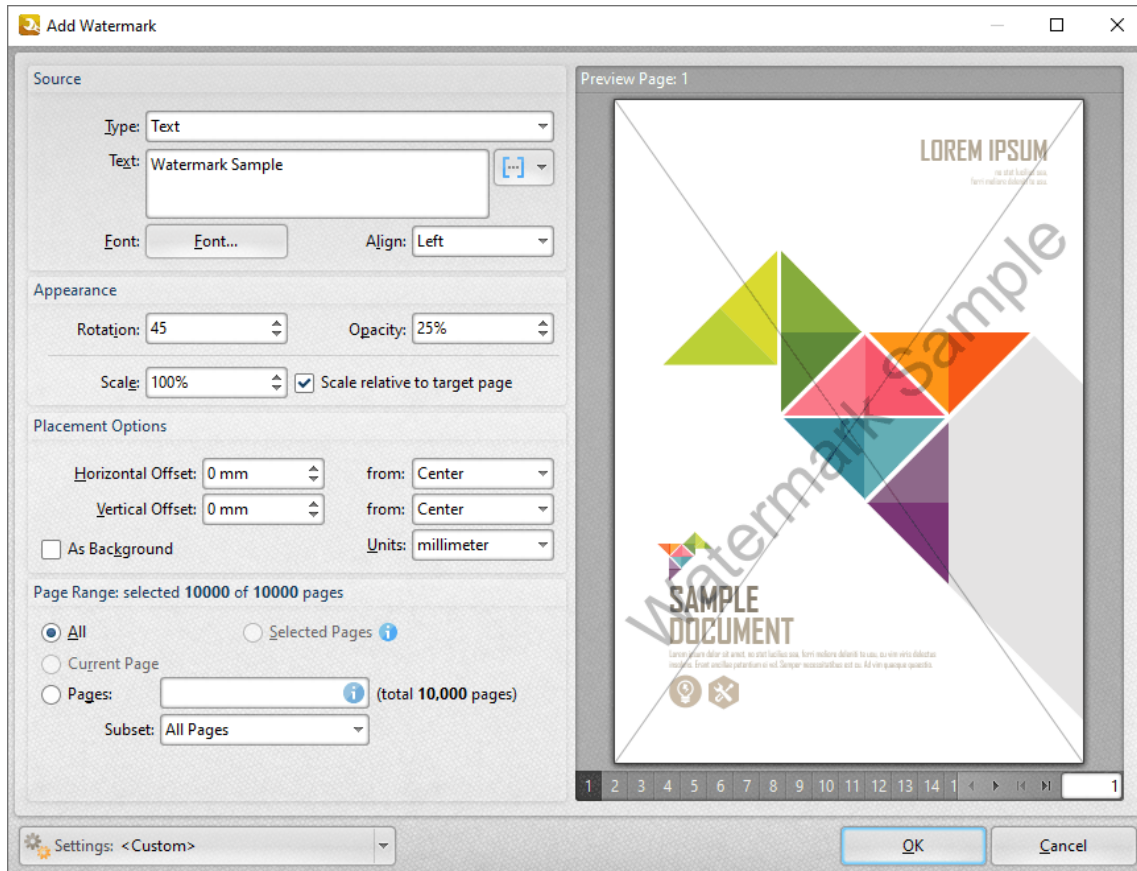
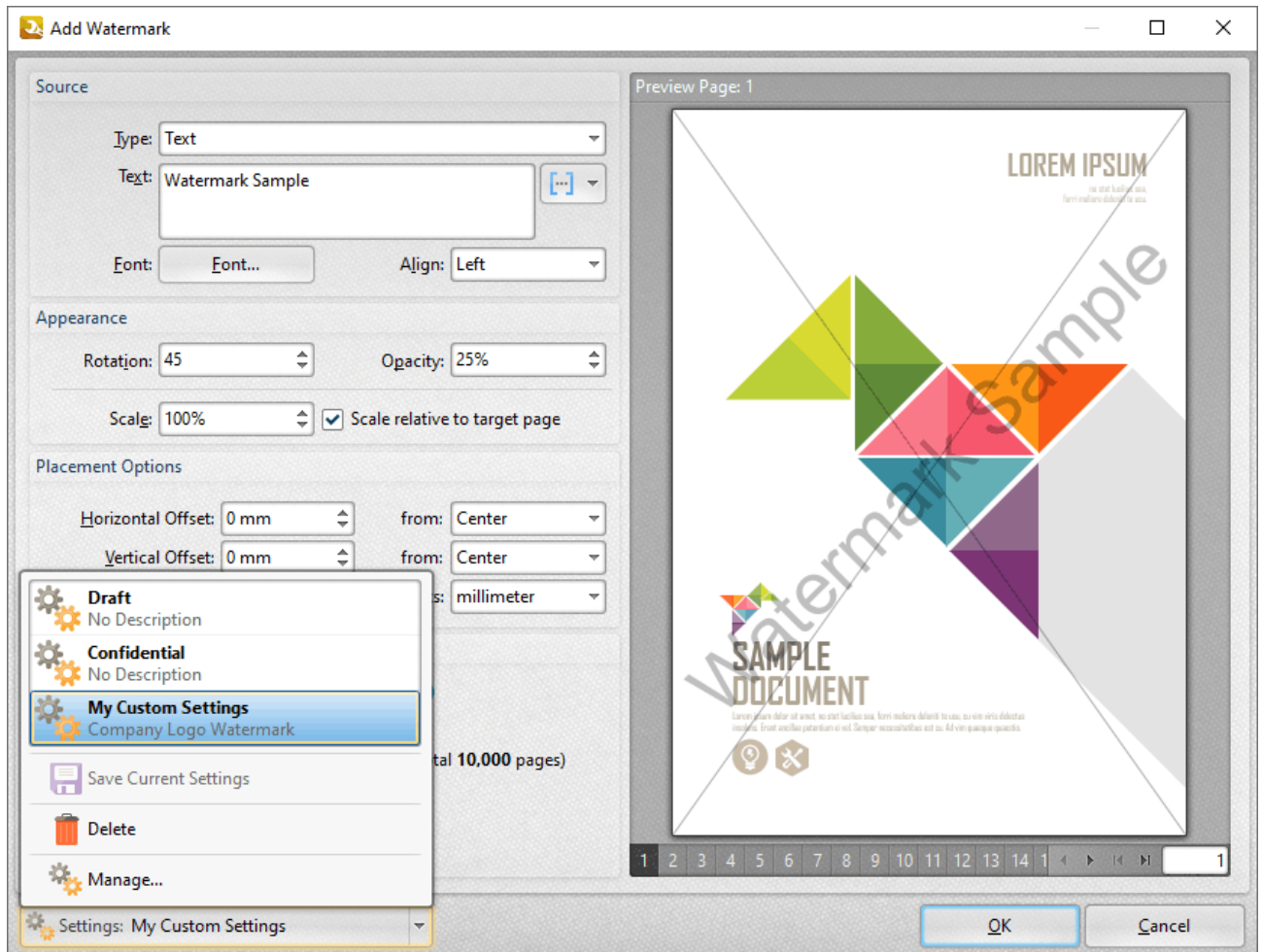

Figure 2. Add Watermark Dialog Box



- The **Source** options determine the source of watermarks. Enter text into the box or select a file. Use the font, [macro](#)<sup>488</sup> and alignment options to customize watermarks when text is used as the source.
- The **Appearance** options determine the rotation, opacity and scale of the watermark:
  - The **Rotation** value determines the rotation (in degrees) of watermarks.
  - The **Opacity** value determines the opacity (transparency) of watermarks.
  - The **Scale** value determines the scale of watermarks. Select the check box to scale watermarks to the target page. If this box is not selected then the scale is relative to the size of the original image used as the source for the watermark.
- The **Placement** options determine the horizontal and/or vertical offset of the watermark from the left, right or center of the document.
- Select the **As Background** box to insert watermarks into the background as opposed to the foreground of documents.
- The **Page Range** options are as follows:
  - Select **All** to add watermarks to all pages.
  - The **Current Page** and **Selected Page** options are not currently available. They will be available in a future build.
  - Use the **Pages** box to determine watermarks for specific page ranges. Further information on the specification of page ranges is available [here](#).<sup>552</sup>

- Use the **Subset** option to select **All Pages**, **Odd Pages Only** or **Even Pages Only**.
- The **Preview Page** pane displays a preview of pages. Select the numbers beneath the pane to preview the corresponding document pages.
- Click the **Settings** dropdown arrow to save/delete/manage customized settings, as detailed below.

Click **OK** to save changes.



**Figure 3.** Add Watermark Dialog Box, Settings Dropdown Menu

- Click **Draft** or **Confidential** to load these preset watermark profiles.
- Click  **Save** to save the current settings to a profile for subsequent use.
- Click  **Delete** to delete the current profile.
- Click  **Manage** to manage saved profiles. The **Manage Presets** dialog box will open:

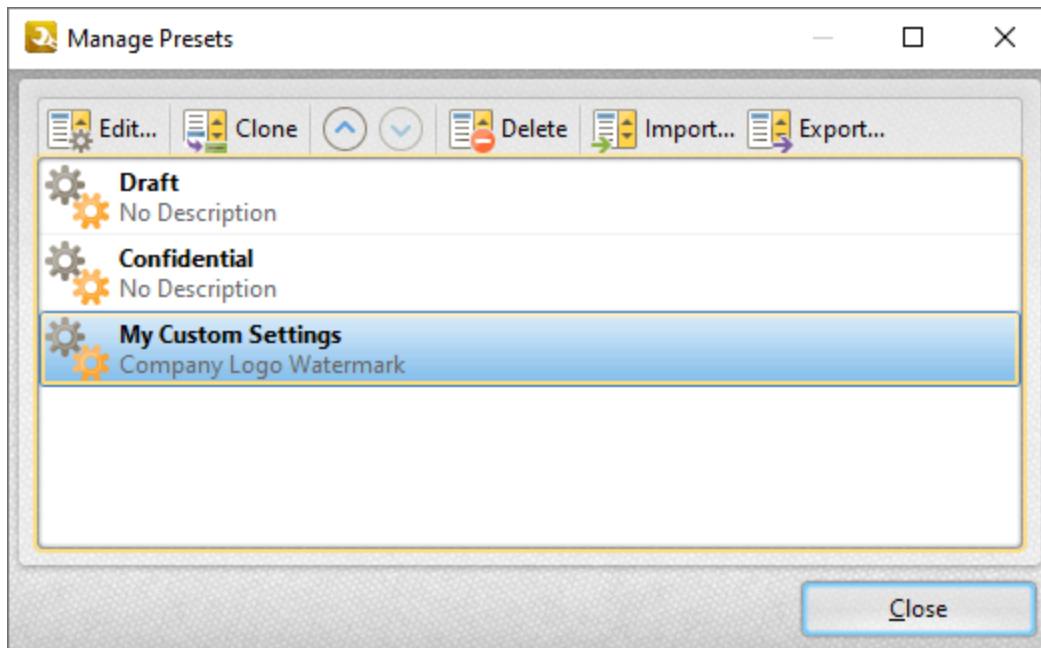

Figure 4. Manage Presets Dialog Box

- Click **Edit** to edit selected profiles. Note that preset profile cannot be edited or deleted.
  - Click **Clone** to clone selected profiles.
  - Use the up and down arrows to move selected profiles up or down in the list.
  - Click **Delete** to delete selected profiles.
  - Click **Import** to import profiles from a saved file.
  - Click **Export** to export profiles to file.
-

## 7.7.4 Change Page Background



### Change Page Background

The **Change Page Background** action changes the background of input documents. It contains the following customizable parameters:

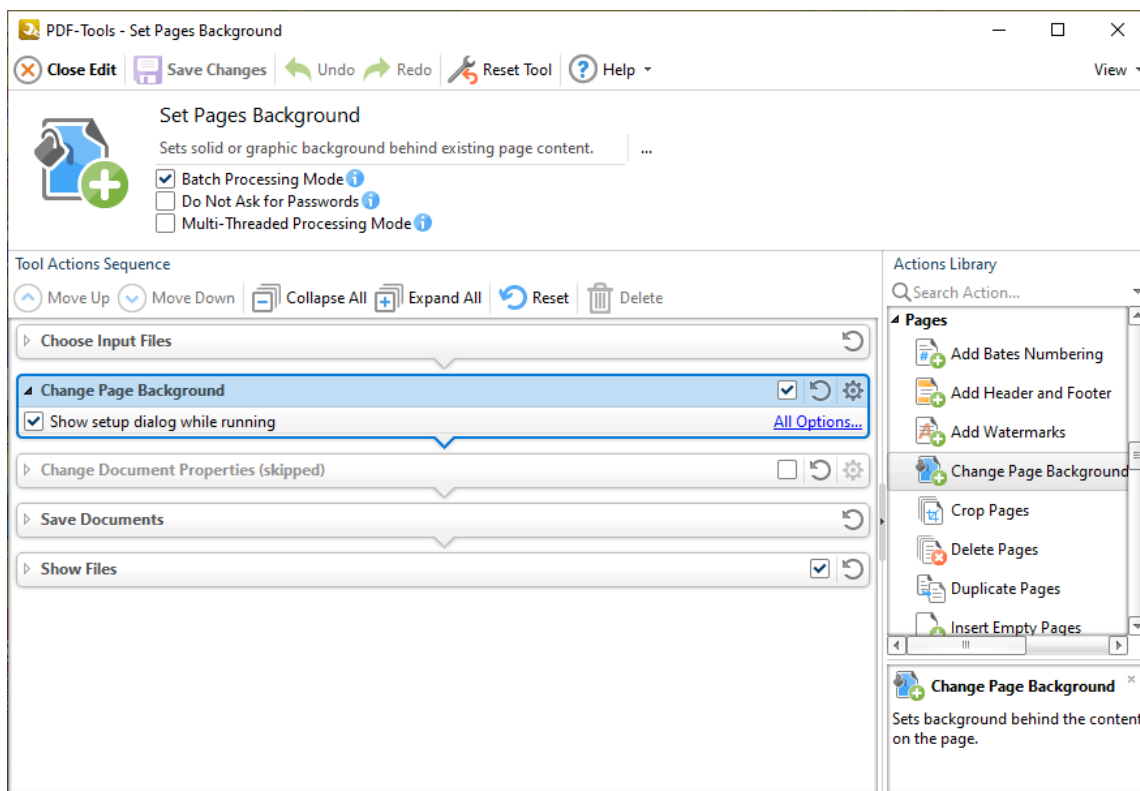

**Figure 1.** Change Page Background Action Options

- Click **All Options** to view/edit all options. The **Add Background** dialog box will open, as detailed below.
- Select the **Show setup dialog while running** box to launch the **Add Background** dialog box and customize settings each time this action is used. Clear this box to disable the **Add Background** dialog box from opening each time the action is used, which is useful when the same settings are used consistently.



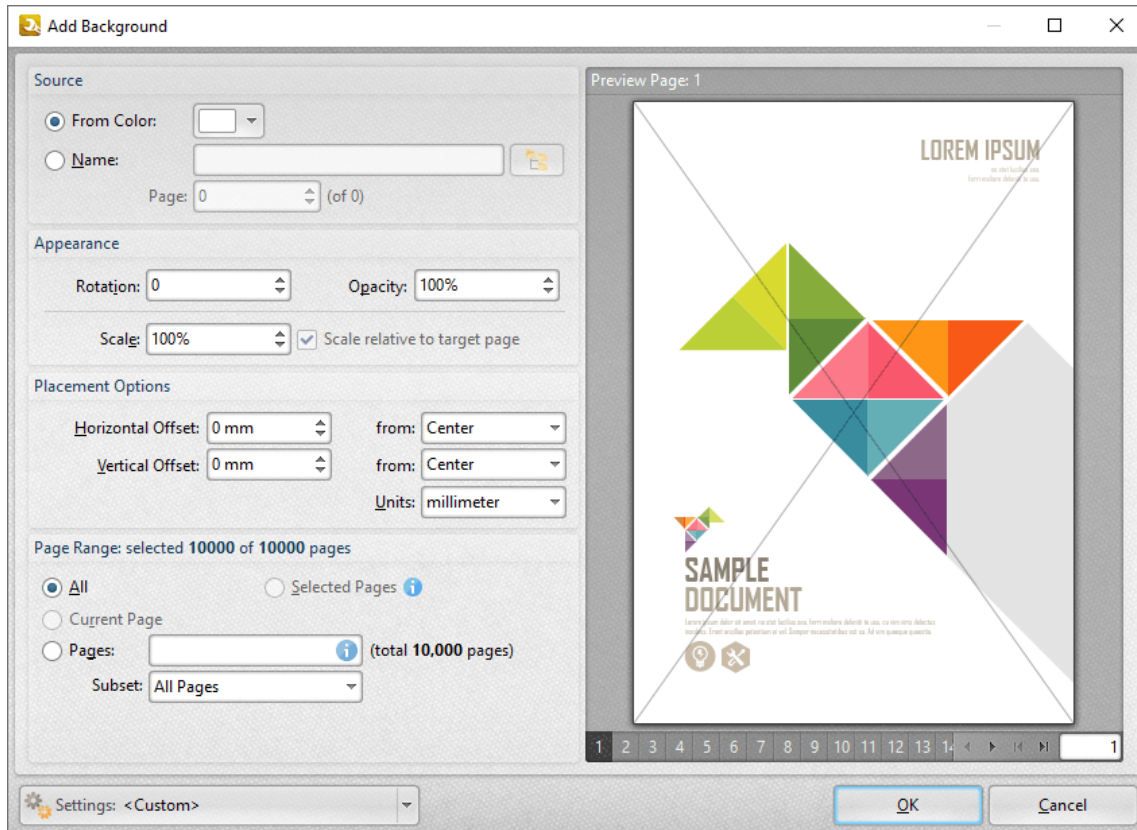
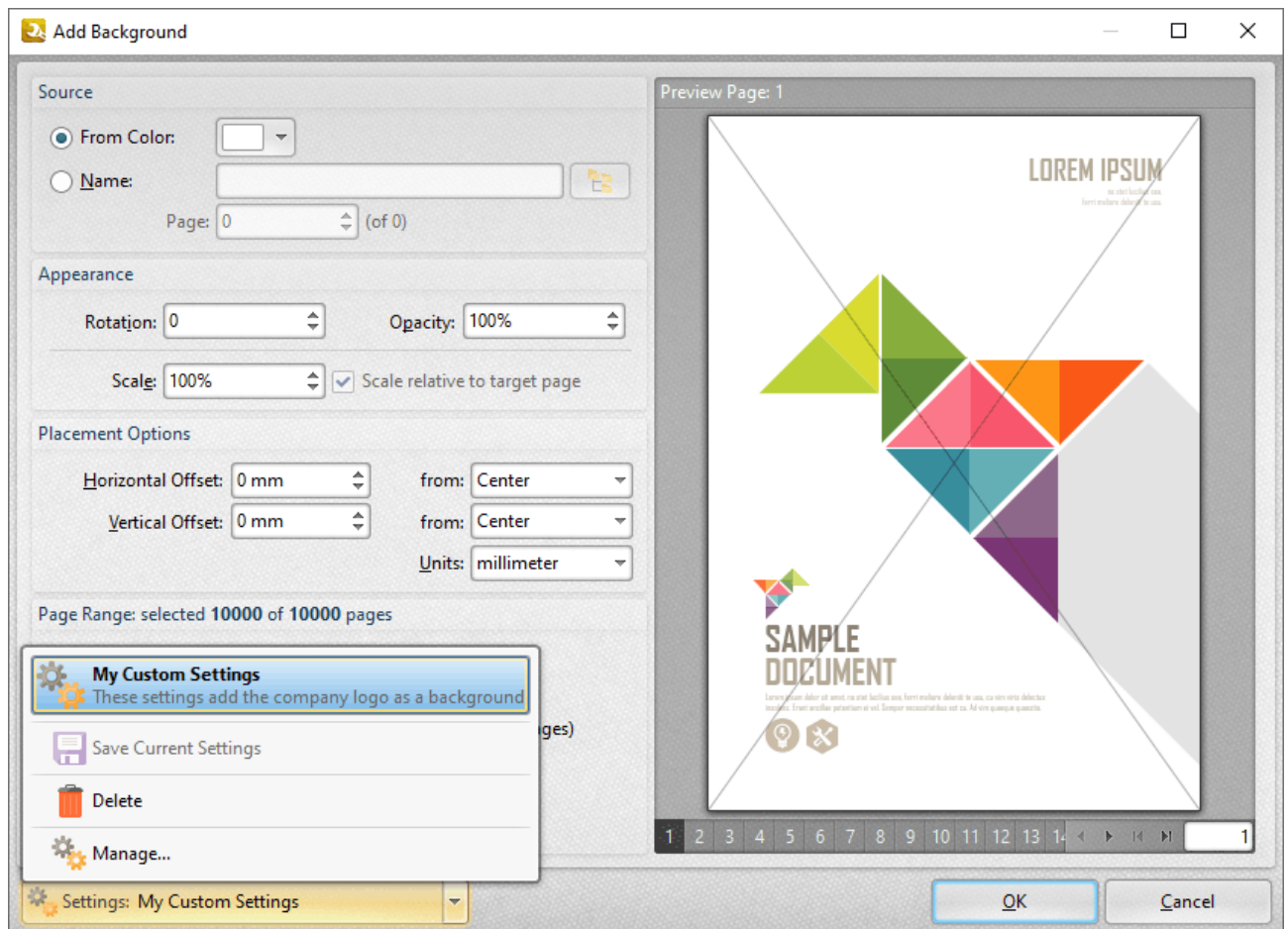

Figure 2. Add Background Dialog Box



- The **Source** options determine the source of the background:
  - Select **From Color** to add a color-based background.
  - Select **Name** to enter a file to be used as the background, or click the icon to select a file from the local computer. Enter the page number of the desired background in the **Page** number box.
- The **Appearance** options determine the rotation, opacity and scale of the background:
  - The **Rotation** value determines the rotation (in degrees) of the background.
  - The **Opacity** value determines the opacity (transparency) of the background.
  - The **Scale** value determines the scale of backgrounds. Select the check box to scale watermarks to the target page. If this box is not selected then the scale is relative to the size of the original image used as the source for the background.
- The **Placement** options determine the horizontal and/or vertical offset of the background from the left, right or center of the document.
- The **Page Range** options are as follows:
  - Select **All** to add backgrounds to all pages.
  - Select **Current Page** to add a background to only the current page.
  - Use the **Pages** box to determine backgrounds for specific page ranges. Further information on this process is available [here](#).<sup>552</sup>
  - Use the **Subset** option to select **All Pages**, **Odd Pages Only** or **Even Pages Only**.

- Please note that it is possible to create more than one background for pages within the same document as long as they are not located within the same page/page range.
- The **Preview Page** pane displays a preview of pages. Select the numbers beneath the pane to preview the corresponding document pages.
- Click the **Settings** dropdown arrow to save/delete customized settings, or manage existing customized settings, as detailed below.

Click **OK** to save changes.



**Figure 3.** Add Background Dialog Box, Settings Dropdown Menu

- Click  **Save** to save the current settings to a profile for subsequent use.
- Click  **Delete** to delete the current profile.
- Click  **Manage** to manage saved profiles. The **Manage Presets** dialog box will open:

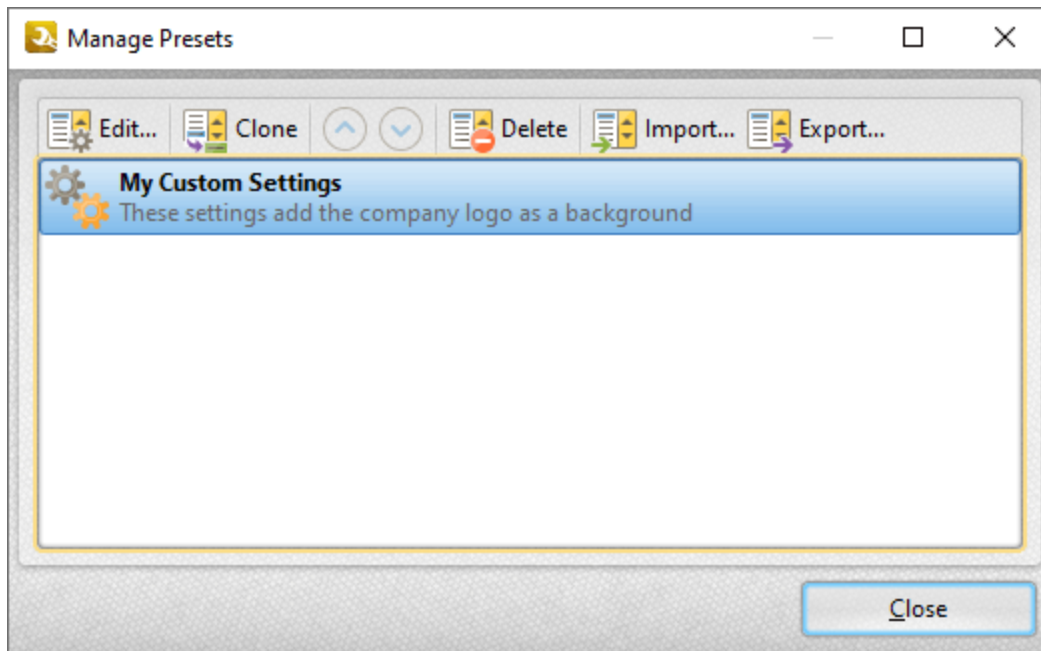

Figure 4. Manage Presets Dialog Box

- Click **Edit** to edit selected profiles.
- Click **Clone** to clone selected profiles.
- Use the up and down arrows to move selected profiles up or down in the list.
- Click **Delete** to delete selected profiles.
- Click **Import** to import profiles from a saved file.
- Click **Export** to export profiles to file.

## 7.7.5 Crop Pages



The **Crop Pages** action adjusts dimensions, white margins and page boxes in input documents. It contains the following customizable parameters:

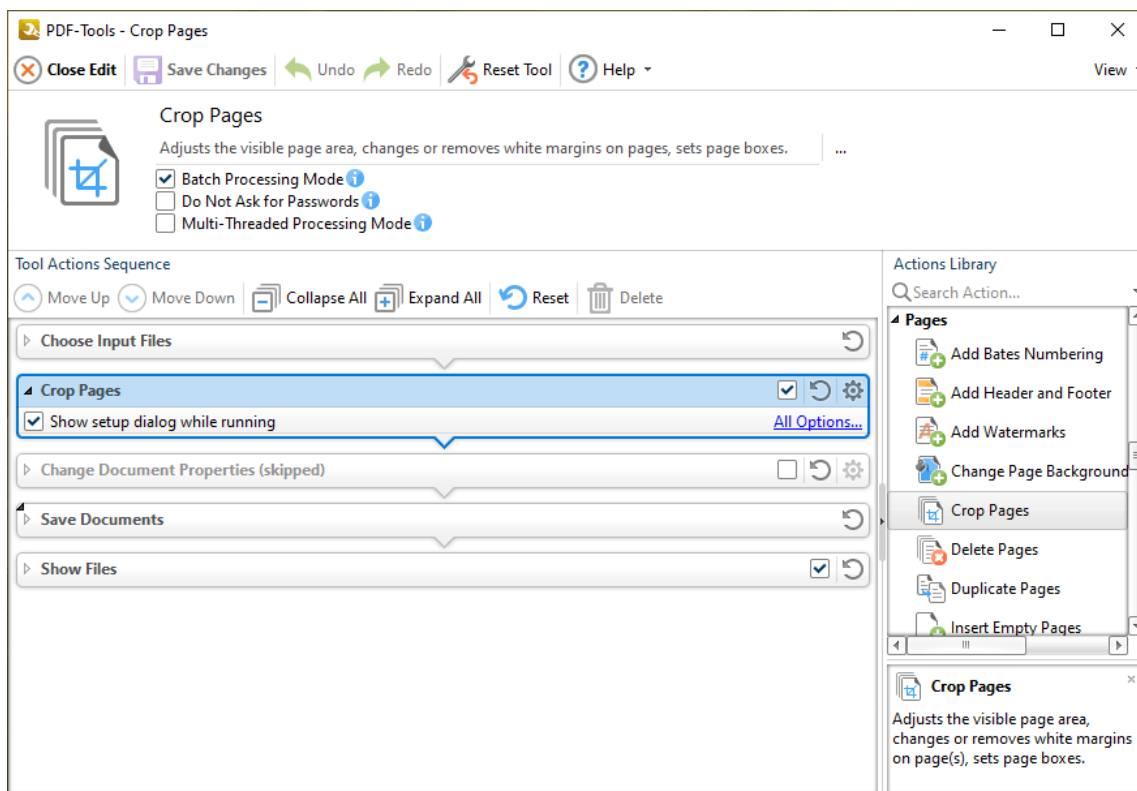

Figure 1. Crop Pages Action Options

- Click **All Options** to view/edit all options. The **Crop Pages** dialog box will open, as detailed below.
- Select the **Show setup dialog while running** box to launch the **Crop Pages** dialog box and customize settings each time this action is used. Clear this box to disable the **Crop Pages** dialog box from opening each time the action is used, which is useful when the same settings are used consistently.

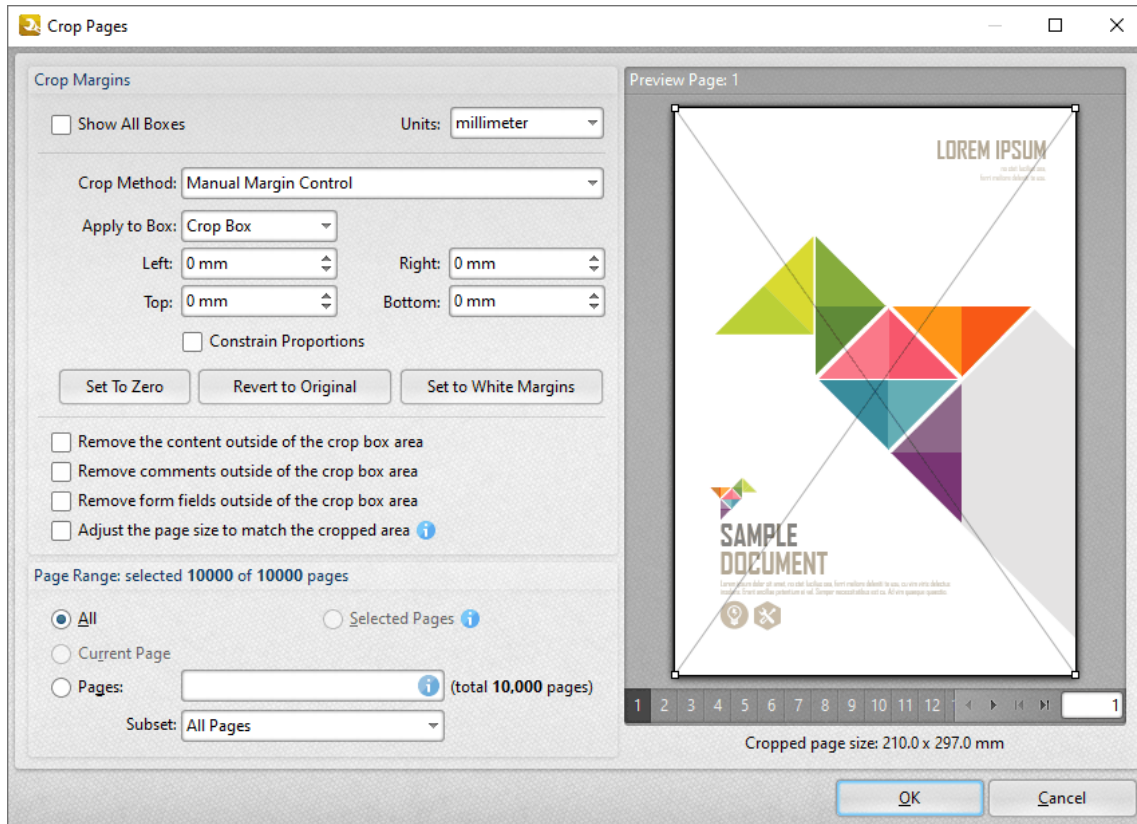

Figure 2. Crop Pages Dialog Box

PDF documents define five boundaries that control the imaging process: the **Crop Box**, **Bleed Box**, **Trim Box**, **Art Box** and **Media Box**. PDF-Tools uses these boxes to determine areas when the **Crop Pages** feature is used. Use the **Apply to Box** dropdown menu, detailed below, to display the editing boxes in the preview pane, then click and drag boxes and/or use the number boxes to adjust their dimensions. Further information about editing boxes is available [here](#).<sup>482</sup> The following options are available in the **Crop Pages** dialog box:

- Click **Show All Boxes** to view the **Crop Box**, **Bleed Box**, **Trim Box** and **Art Box** in the preview pane. (Please note that the **Bleed Box**, **Trim Box** and **Art Box** use the same dimensions as the **Crop Box** by default.
- Use the **Crop Method** dropdown menu to determine the crop method used:
  - **Manual Margin Control** enables the user to determine the cropping margins. Click the text of menu entries in the **Apply to Box** dropdown menu to view them in the preview pane. Click and drag boxes in the preview pane, or use the number boxes, to adjust their dimensions. Select the check boxes of menu entries in the **Apply to Box** dropdown menu to include them in the **Crop Pages** operation.
  - **Remove All White Space** is a predefined mode that removes all white space from documents.
  - **Remove Horizontal White Space/Remove Vertical White Space** are predefined modes that remove horizontal/vertical white space as required.

- Select the **Constrain Proportions** box to maintain the ratio of margins. For example if the margin in the **Left** box is changed to 5mm then the margins in the **Right, Top** and **Bottom** boxes will also be changed to 5mm.
- Use **Set to Zero, Revert to Original** and **Set To White Margins** to apply these functions to boxes selected in the **Apply to Box** dropdown menu.
- Select the **Remove the content outside of the crop box area** box to remove content outside of the **Crop box**. Please note that cropping pages reduces the visible page content, but the cropped content is still present in the file's underlying code and, for example, will be visible if the document pages are increased in size. Select this option to remove cropped content from the file.
- Use the **Page Range** settings to determine the page range of cropped pages:
  - Select **All** to crop all pages.
  - Select **Current Page** to crop only the current page.
  - Select **Pages** to create a custom page range, as detailed [here](#).<sup>186</sup>
  - Use the **Subset** option to select **All Pages, Odd Pages Only** or **Even Pages Only**.

Click **OK** to save changes.

---

## 7.7.6 Delete Pages



The **Delete Pages** action deletes pages of input documents. It contains the following customizable parameters:

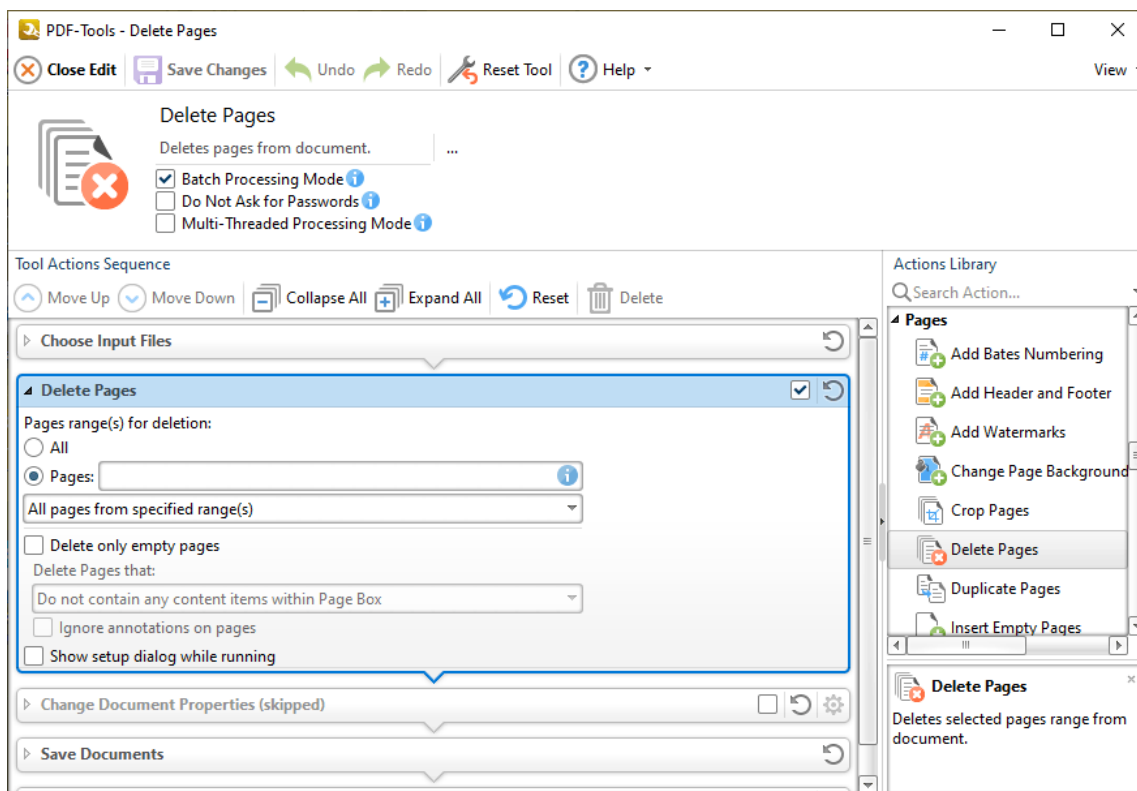

Figure 1. Delete Pages Action Options

- Use the **Page range(s) for deletion** number box to determine the page range to be deleted:
  - Select **All** to delete all document pages.
  - Select **Pages** to specify a custom page range, as detailed [here](#).
  - If a custom range is specified, then select an option in the dropdown menu to determine a subset of pages.
- Select the **Delete only empty pages** box to delete only empty pages from the specified range.
- Use the **Delete pages that:** dropdown menu to specify the deletion of specific types of pages:

- Select **Do no contain any content items within Page Box** to delete only pages that do not contain content items in the page box of the document. The page box is defined as the intersection between the crop box and the media box, as detailed [here](#).<sup>482</sup>
- Select **Do not contain any content items** to delete only pages that do not contain content items.
- Select **Have only a solid background** to delete pages that contain only a solid background.
- Select the **ignore annotations on pages** box to ignore annotations when **PDF-Tools** decides which pages to delete.
- Select the **Show setup dialog while running** box to launch the **Delete Pages** dialog box and customize settings each time this action is used. Clear this box to disable the **Delete Pages** dialog box from opening each time the action is used, which is useful when the same settings are used consistently.

Click  **Save Changes** to save changes.

---



## 7.7.7 Duplicate Pages



### Duplicate Pages

The **Duplicate Pages** action duplicates pages of input documents. It contains the following customizable parameters:

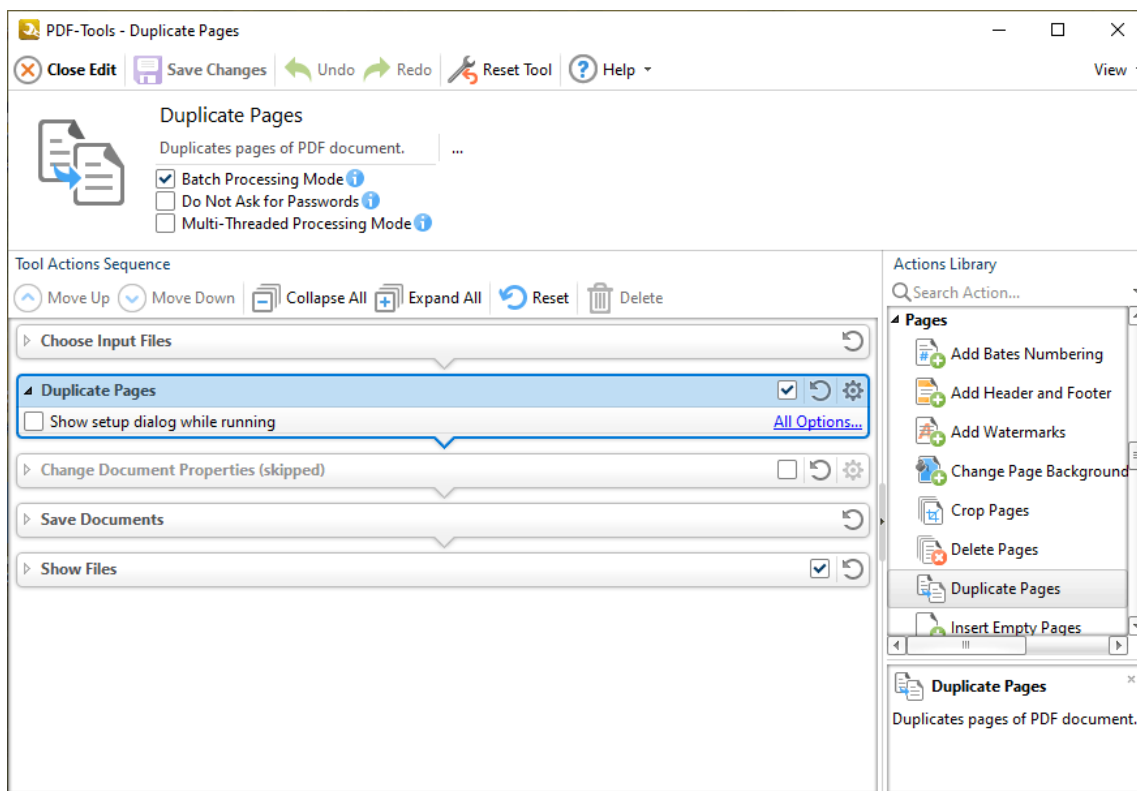

Figure 1. Duplicate Pages Action Options

- Click **All Options** to view/edit all options. The **Duplicate Pages** dialog box will open, as detailed below.
- Select the **Show setup dialog while running** box to launch the **Duplicate Pages** dialog box and customize settings each time this action is used. Clear this box to disable the **Duplicate Pages** dialog box from opening each time the action is used, which is useful when the same settings are used consistently.

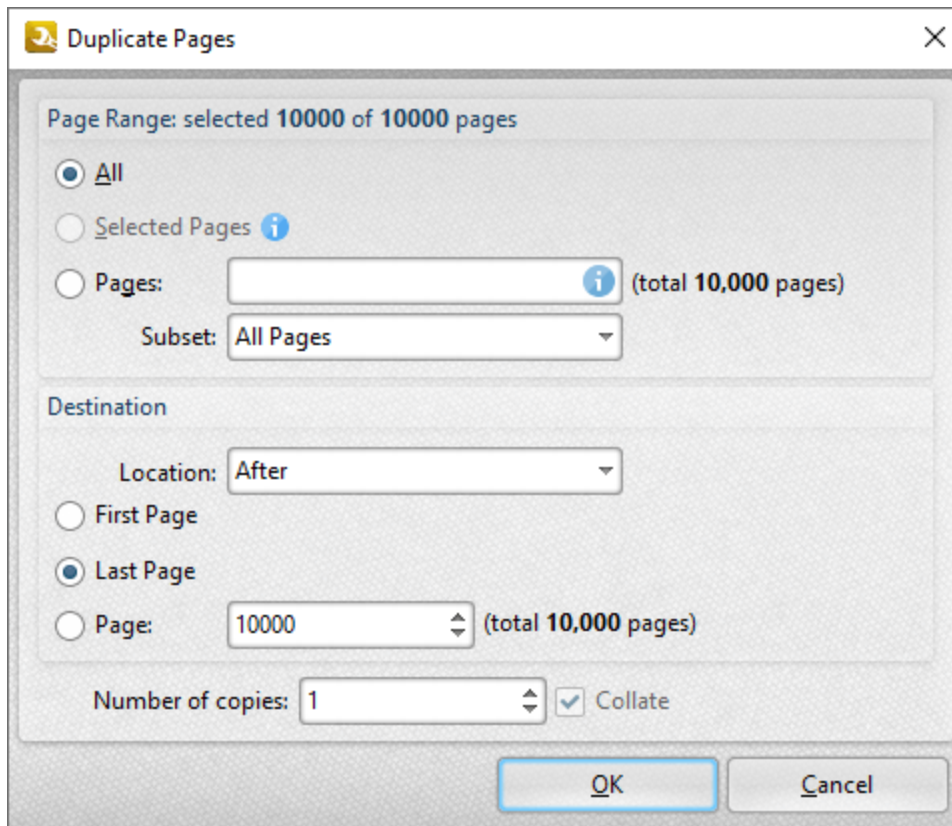

Figure 2. Duplicate Pages Dialog Box

Use the **Page Range** settings to determine which pages are duplicated:

- Select **All** to specify all pages.
- The **Selected Pages** option is not currently available. It will be available in a future build.
- Select **Pages** to specify a custom page range, as detailed [here](#).<sup>[552]</sup>
- If a custom range is specified, then select an option in the **Subset** dropdown menu to determine a subset of pages.

Use the **Destination** settings to determine the insertion location of duplicated pages:

- Select either **Before** or **After** in the **Location** dropdown menu.
- Select **First Page** or **Last Page** as desired. Alternatively, select **Page** to specify a different document page.
- Use the **Number of copies** dropdown menu to determine the amount of duplicates created.

Click **OK** to save changes.

---

## 7.7.8 Insert Empty Pages



The **Insert Empty Pages** action inserts empty pages into input documents. It contains the following customizable parameters:

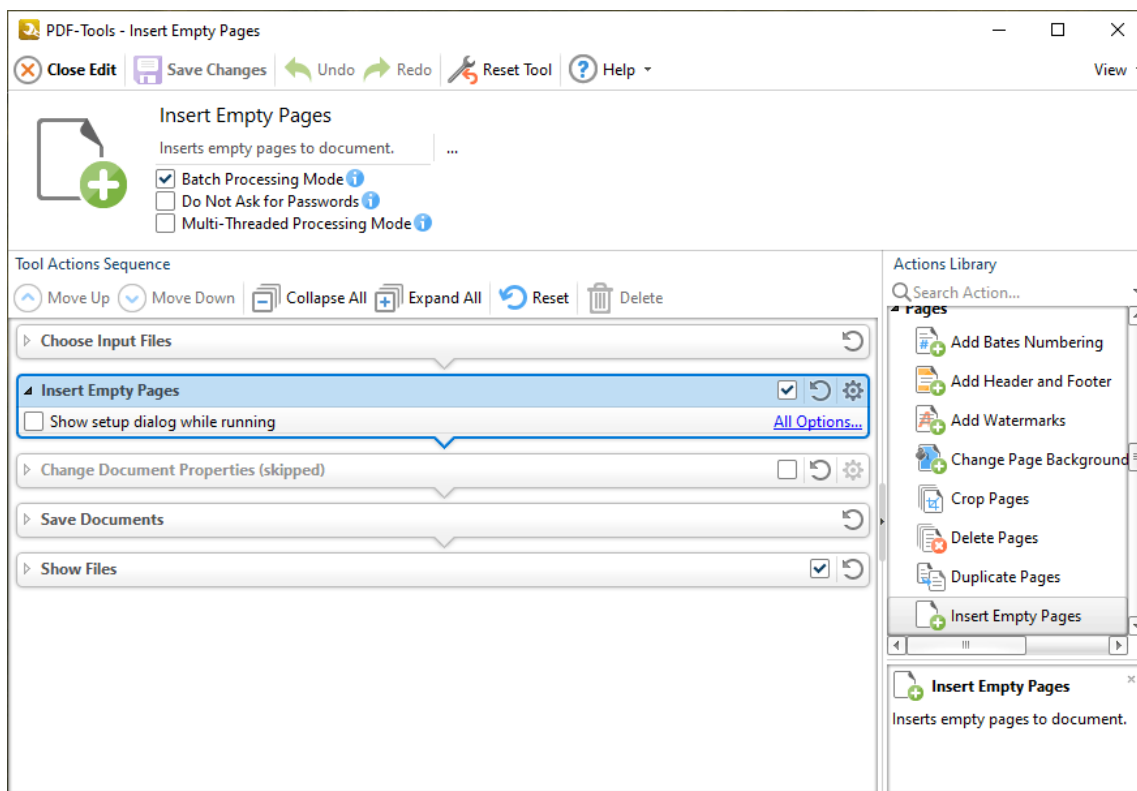

Figure 1. Insert Pages Action Options

- Click **All Options** to view/edit all options. The **Insert Empty Pages** dialog box will open, as detailed below.
- Select the **Show setup dialog while running** box to launch the **Insert Empty Pages** dialog box and customize settings each time this action is used. Clear this box to disable the **Insert Empty Pages** dialog box from opening each time the action is used, which is useful when the same settings are used consistently.

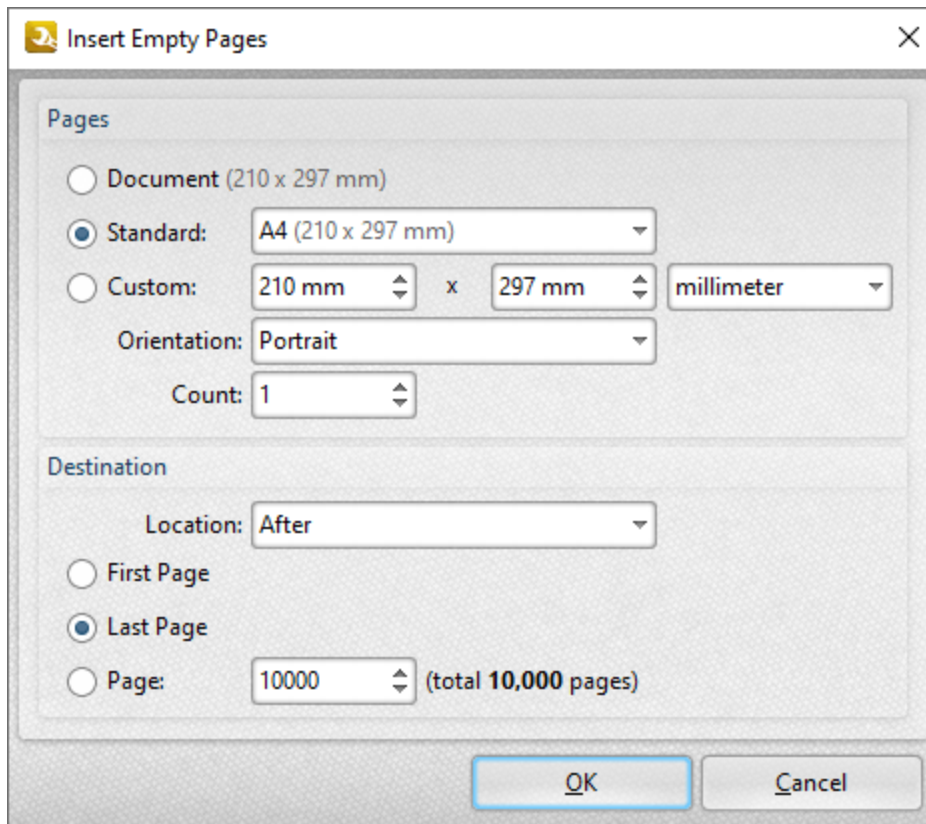

Figure 2. Insert Pages Dialog Box

- Select an option in the **Pages** section to determine the dimensions of new pages:
  - Select **Document** to match the dimensions of the current document.
  - Select **Standard** to select a standard document size, such as those used by the **ISO** and **ANSI**.
  - Select **Custom** to enter custom dimensions. Enter the desired dimensions into the number boxes.
  - Select either **Portrait** or **Landscape** for the orientation of new pages.
  - Use the **Count** menu to determine the number of pages inserted.
- Use the **Destination** options to determine the location at which the new pages are inserted.

Click **OK** to save settings.

---

## 7.7.9 Insert Pages



The **Insert Pages** action inserts pages from existing documents into input documents. It contains the following customizable parameters:

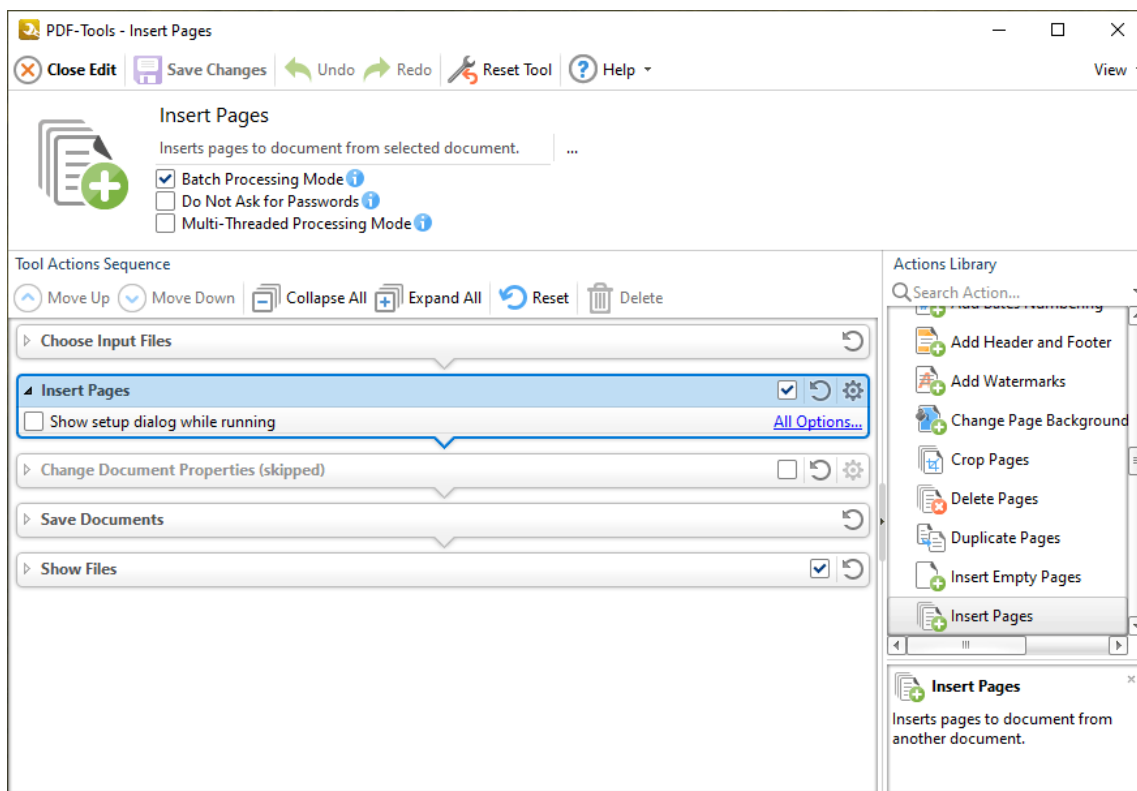

Figure 1. Insert Pages Action Options

- Click **All Options** to view/edit all options. The **Insert Pages** dialog box will open, as detailed below.
- Select the **Show setup dialog while running** box to launch the **Insert Pages** dialog box and customize settings each time this action is used. Clear this box to disable the **Insert Pages** dialog box from opening each time the action is used, which is useful when the same settings are used consistently.

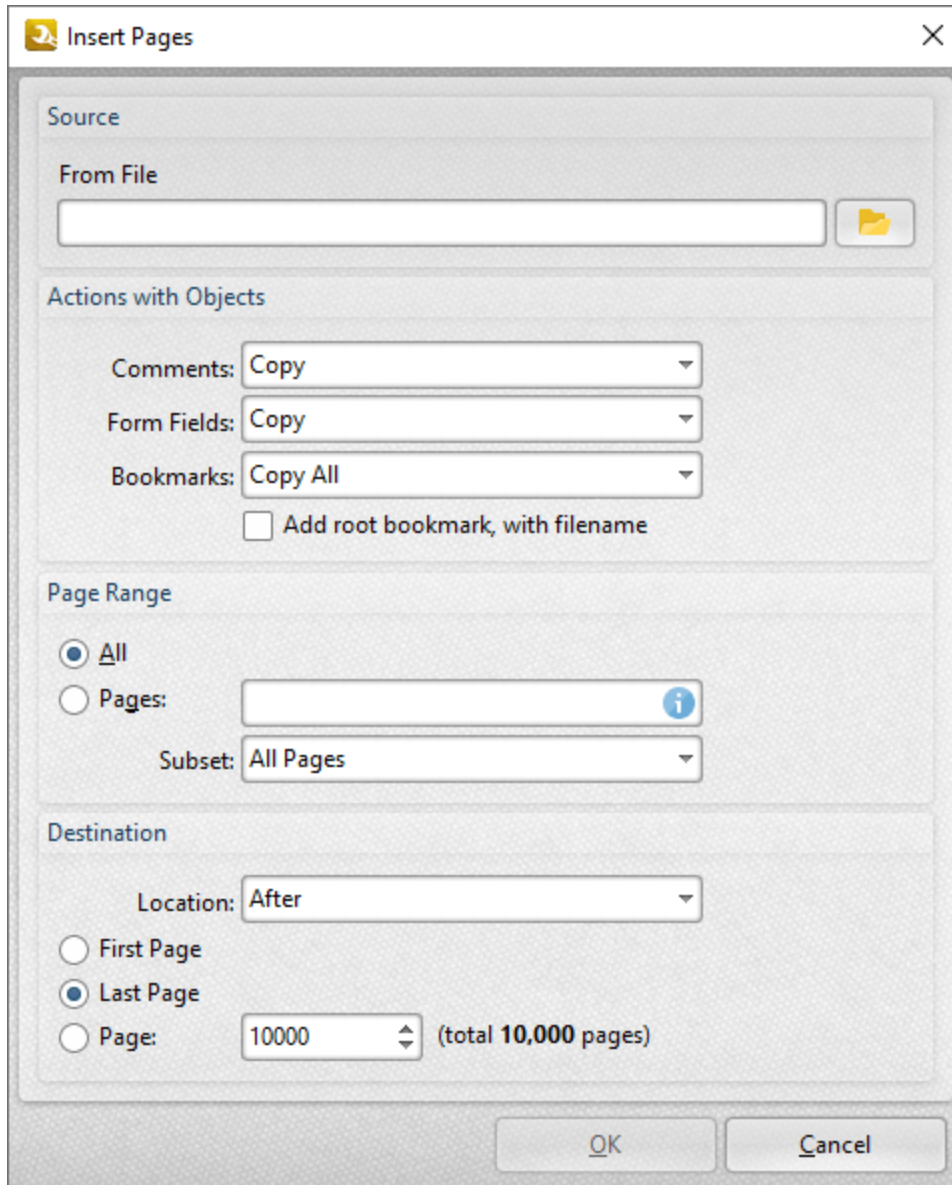

Figure 2. Insert Pages Dialog Box

- Use the **From File** text box to specify the document from which to insert pages, or click the folder icon to select a file manually.
- Use the **Actions with Objects** options to determine the action taken for **Comments**, **Form Fields** and **Bookmarks** contained in the inserted pages.
- Select the **Add root bookmark, with file name** box to create a root bookmark from inserted pages.
- Use the **Page Range** options to determine which pages are inserted:
  - Select **All** to insert all pages.
  - Use the **Pages** number box to specify individual pages, separated with a comma, and/or page ranges, separated with a hyphen. Further information on the specification of page ranges is available [here](#).<sup>552</sup>

- If a custom range is specified, then select an option in the **Subset** dropdown menu to determine a subset of pages.
- Use the **Destination** options to determine the location at which the new pages are inserted.

Click **OK** to save settings.

---

## 7.7.10 Merge Pages



### Merge Pages

The **Merge Pages** action merges pages into a single page. It contains the following customizable parameters:

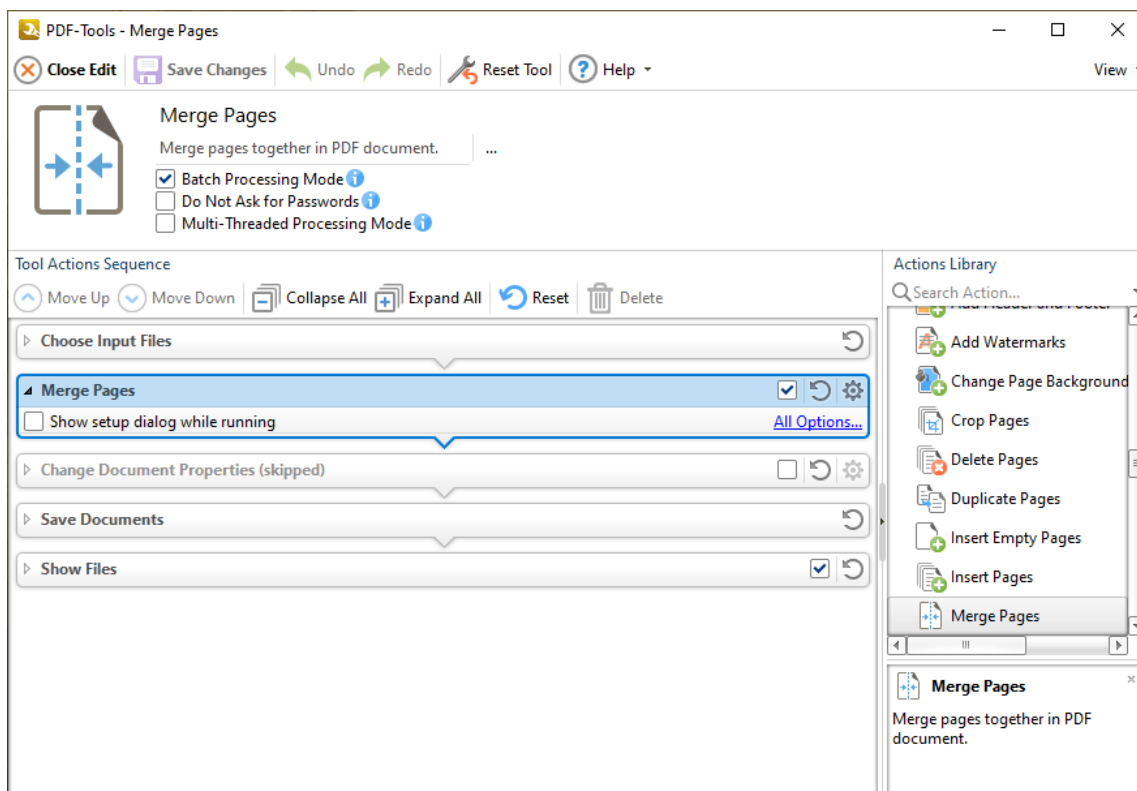

Figure 1. Merge Pages Action Options

- Click **All Options** to view/edit all options. The **Merge Pages** dialog box will open, as detailed below.
- Select the **Show setup dialog while running** box to launch the **Merge Pages** dialog box and customize settings each time this action is used. Clear this box to disable the **Merge Pages** dialog box from opening each time the action is used, which is useful when the same settings are used consistently.



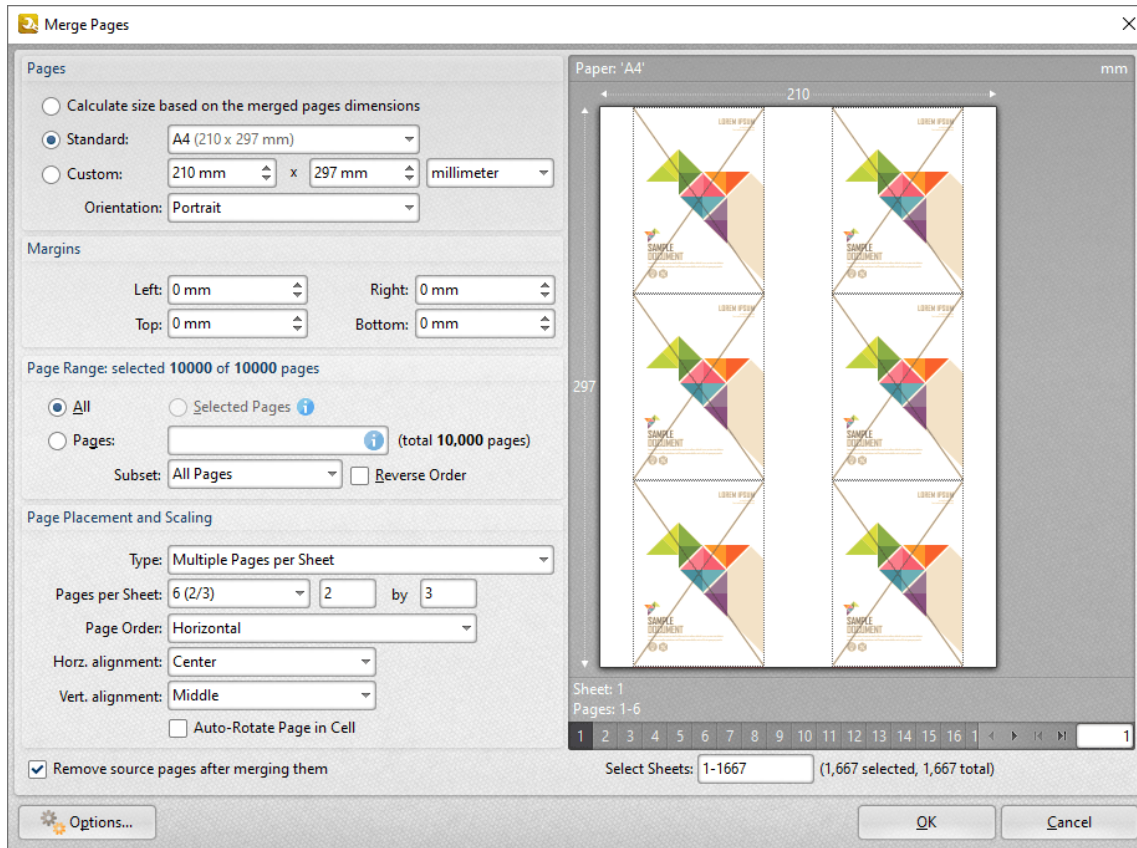

Figure 2. Merge Pages Dialog Box

- Use the **Pages** options to determine the size of the new page:
  - Click **Calculate Size based on the merged pages dimensions** to retain the size of the source pages in the output document.
  - Click **Standard** to use a standard page size for the output document, then select an option in the dropdown menu.
  - Click **Custom** to use a custom page size for the output document, then enter the measurements in the combo boxes and select a unit of measurement as desired.
  - Use the **Orientation** dropdown menu to determine the orientation of the output document.
- Use the **Margins** number boxes to determine the margins of the output document.
- Use the **Page Range** options to determine the page range of the source document used to create the output document:
  - Click **All** to include all pages.
  - Click **Select Pages** to use the pages currently selected in the **Thumbnails** pane.
  - Click **Pages** to specify a custom page range, then enter the desired range in the box. Information on the specification of page ranges is available [here](#).<sup>552</sup>
- Use the **Page Placement and Scaling** options to determine how source pages are placed in the output document, as detailed in the preview pane when settings are edited.
- Select/clear the **Remove source pages after merging them** box as desired.

Click **OK** to save settings.

---

## 7.7.11 OCR Pages



The **OCR Pages** action performs optical character recognition on documents. Note that two optical character recognition engines are available in **PDF-Tools**: the **Default** OCR engine and the **Enhanced** OCR engine, which is an optional extra in **PDF-Tools** that was added in version 8. The **Enhanced** OCR engine is faster, more accurate and more dynamic than the default OCR engine, and it also contains some extra features. Further information about the **Enhanced** OCR engine is available [here](#). If you have purchased the **Enhanced** OCR engine, then you can use the **OCR** preferences detailed [here](#)<sup>572</sup> to switch between the **Default** and **Enhanced** OCR engines.

This action contains the following customizable parameters:

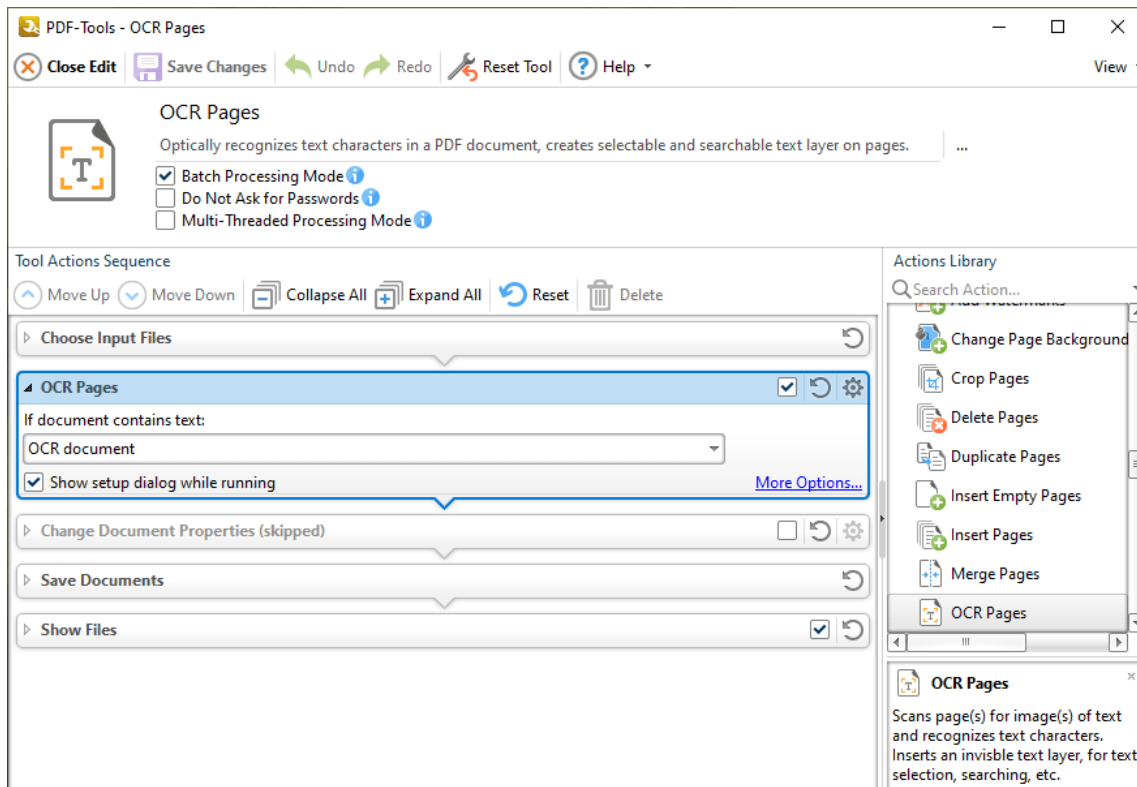

Figure 1. OCR Pages Action Options

- Select an option in the dropdown menu to determine the action taken when input documents contain text:

- Select **OCR Document** to perform OCR on input documents.
- Select **Do not OCR but continue processing** to omit the OCR process from the operation and continue with the remaining actions.
- Select **Skip processing the document** to exclude the document from processing.
- Click **More Options** to view/edit all options. The **OCR Pages** dialog box will open, as detailed below.
- Select the **Show setup dialog while running** box to launch the **OCR Pages** dialog box and customize settings each time this action is used. Clear this box to disable the **OCR Pages** dialog box from opening each time the action is used, which is useful when the same settings are used consistently.

Note that the options in the **OCR Pages** dialog box depend on the OCR engine being used:

### Default OCR Engine

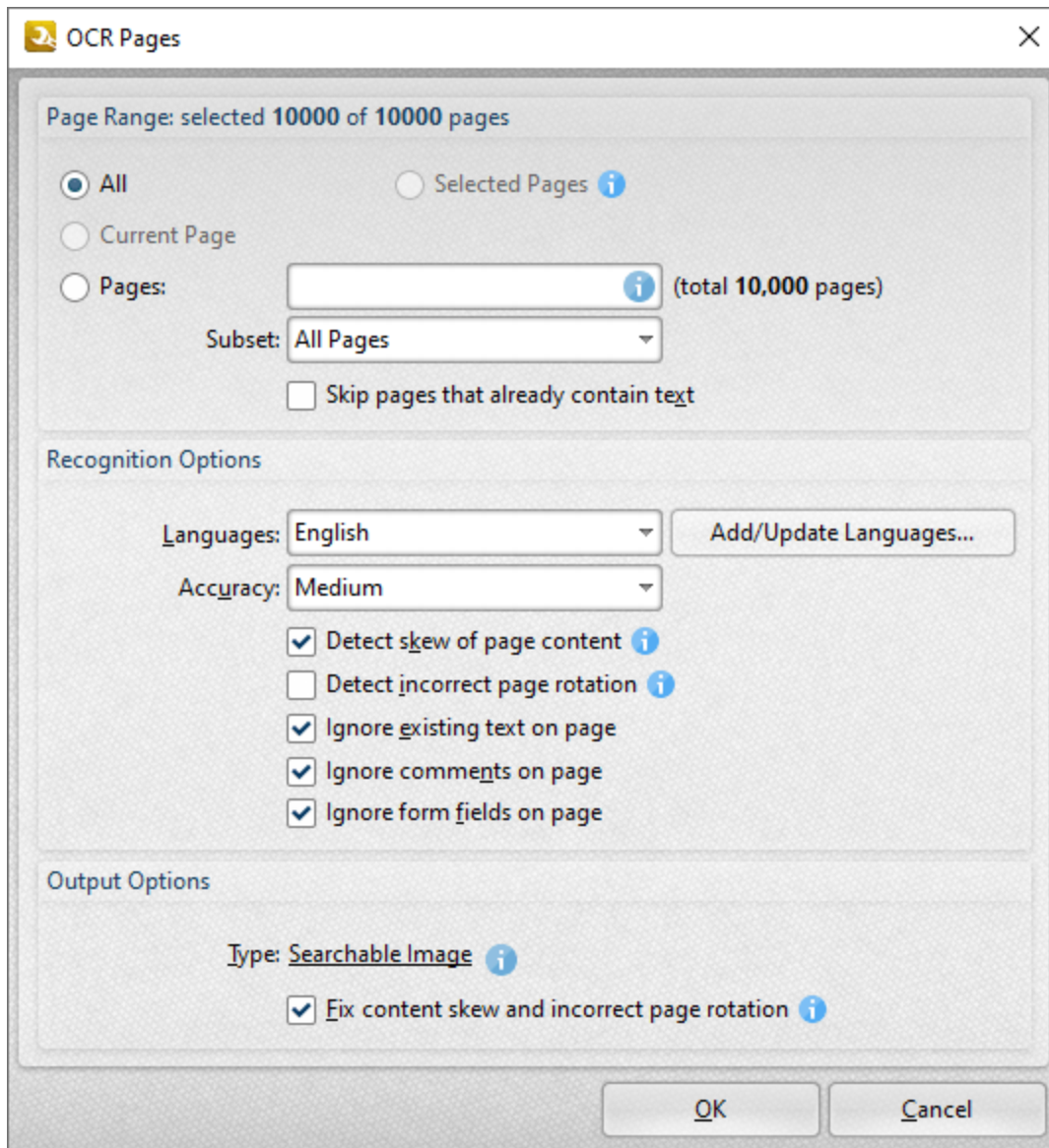

Figure 2. OCR Pages Dialog Box

Use the **Page Range** settings to determine the page range for OCR:

- Select **All** to specify all pages.
- The **Current Page** option is not currently available. It will be available in a future build.
- Select **Pages** to specify a custom page range. Further information on defining page ranges is available [here](#).<sup>[552]</sup>
- If a custom range is specified, then select an option in the **Subset** dropdown menu to determine a subset of pages.
- Select the **Skip pages that already contain text content items** box to omit pages that contain text content from the **OCR** process.

Use the **Recognition** settings to determine the language and accuracy of the OCR process. Please note that increasing the accuracy also increases the time that the process takes and vice versa. Additionally,

it should be noted that setting the accuracy to high may result in unusual output if the document contains imperfections. This is because the software will search to a greater depth and may attempt to recognize imperfections as text. Click **More Languages** to view available language packs.

Click **OK** to save settings.

## Enhanced OCR Engine

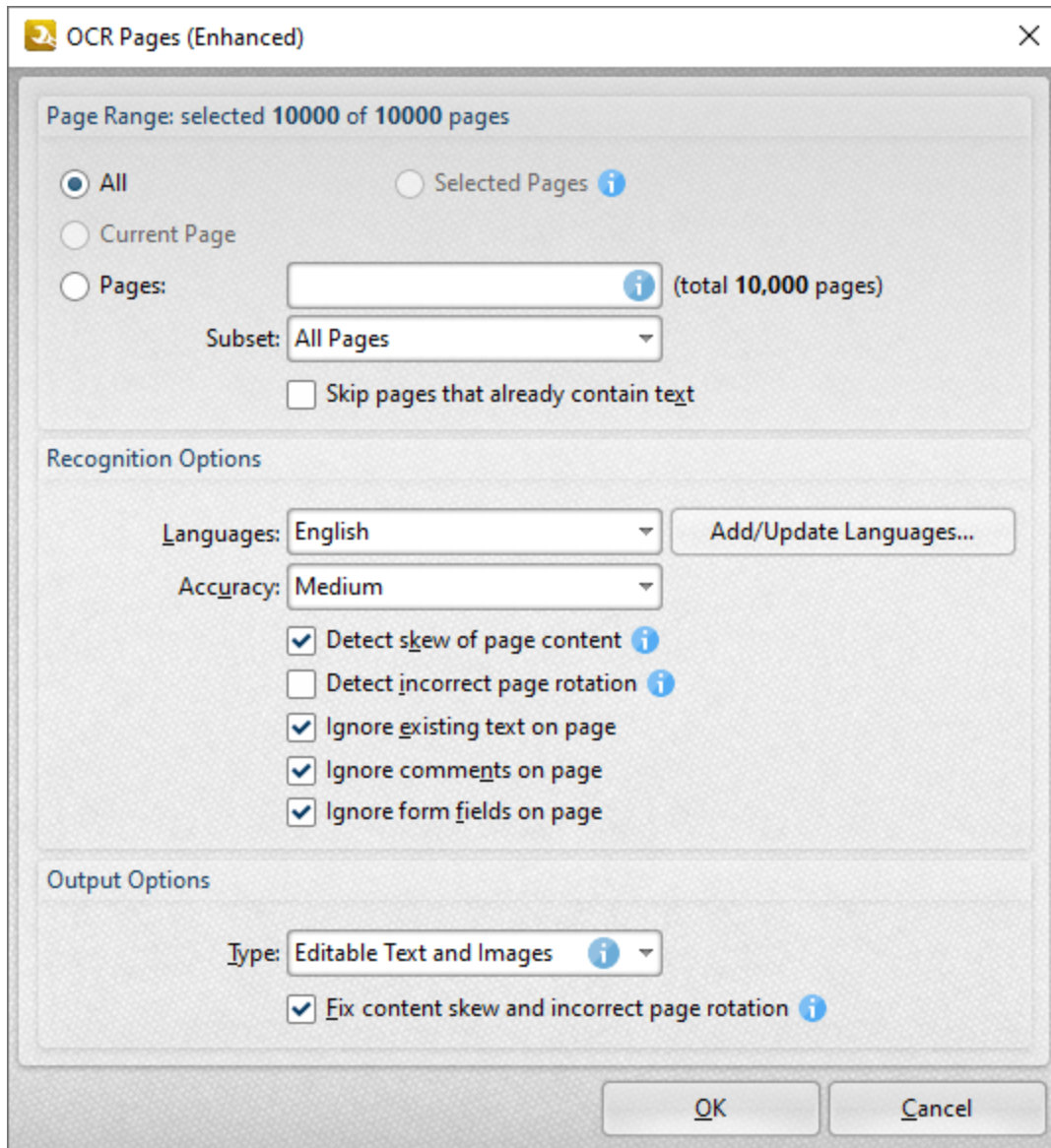

Figure 3. OCR Pages (Enhanced) Dialog Box

The options in this dialog box are the same as those detailed in (figure 2) but with additional **Output Options**, which are available in the dropdown menu:

- Select **Searchable Image** to retain the image-based content on which OCR is performed and insert a duplicate, invisible text layer on the text recognized during the operation. This will make the source text selectable and searchable in the same manner as ordinary text.
- Select **Editable Text and Images** to replace image-based text in source documents with the text recognized in the process of optical character recognition. This will convert image-based text into editable text.
- Select **Fine Page Content** to replace the content of source documents with new content that contains only the text and images recognized during optical character recognition.

Click **OK** to OCR documents.

---

## 7.7.12 Overlay PDF



The **Overlay PDF** action overlays input documents with existing files. It contains the following customizable parameters:

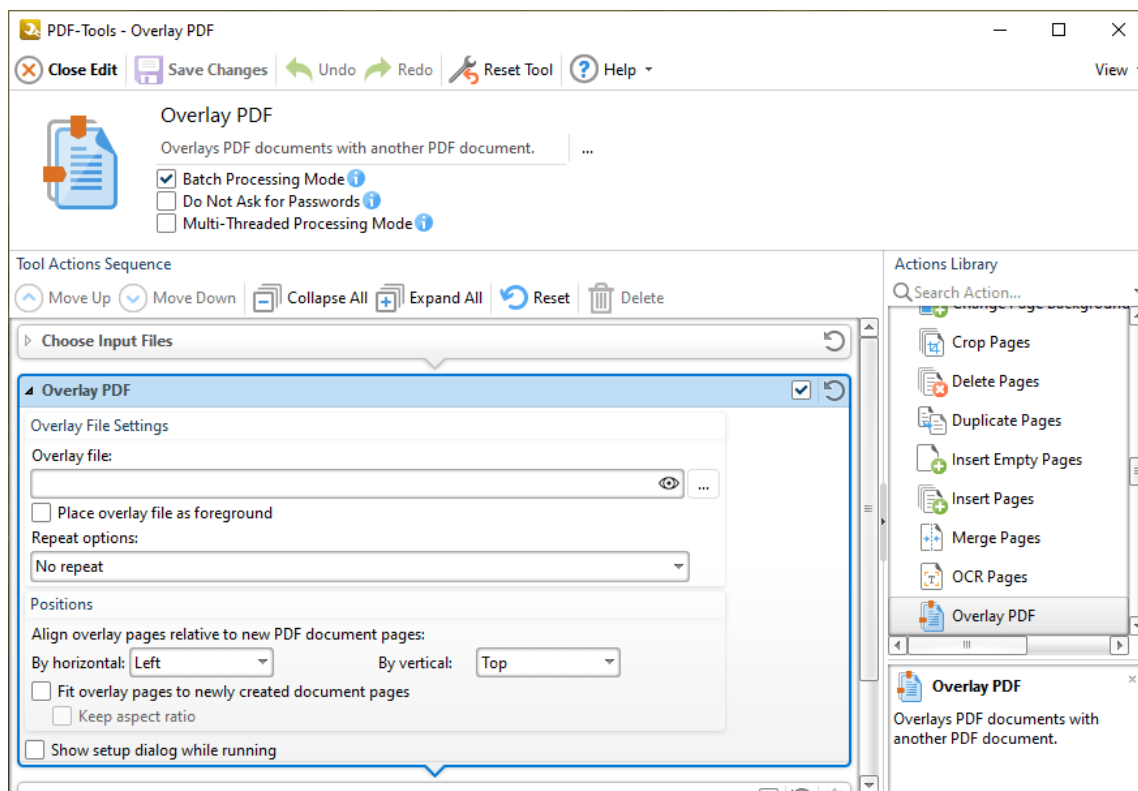



Figure 1. Overlay PDF Action Options

- Enter the name of the file to be used in the **Overlay File** text box, or click the ellipsis icon to select a file manually. Click the  icon to preview the overlay file.
- Select the **Place overlay file as foreground** box to position the overlay in the foreground of the document.
- Select an option in the **Repeat Options** dropdown menu to determine the outcome when there are fewer pages in the overlay document than the printed document:
  - Select **No Repeat** to not repeat the overlay document. Pages in the printed document that exceed the range of the overlay document will not feature an overlay.



- Select **Repeat Last Page of Shorter Overlay File** to repeat the final page of the overlay document on the pages of the printed document that exceed the range of the overlay document.
- Select **Continuous Repeat of Shorter Overlay File** to repeat the overlay document from its first page on the pages of the printed document that exceed the range of the overlay document.
- Use the **Positions** settings to determine the placement of overlay files relative to input documents:
  - Select an option from the **By Horizontal** dropdown menu to determine the horizontal position.
  - Select an option from the **By Vertical** dropdown menu to determine the vertical position.
- Select the **Fit overlay pages to newly created document pages** box to fit overlay pages to the page size of printed documents.
- Select the **Keep Aspect Ratio** box to retain the aspect ratio of overlays when the **Fit Overlay Pages to Newly Created Document Pages** option is used.
- Select the **Show setup dialog while running** box to launch the **Overlay PDF** dialog box and customize settings each time this action is used. Clear this box to disable the **Overlay PDF** dialog box from opening each time the action is used, which is useful when the same settings are used consistently.

Click  **Save Changes** to save changes.

---

## 7.7.13 Remove Bates Numbering



The **Remove Bates Numbering** action removes Bates numbering from input documents:

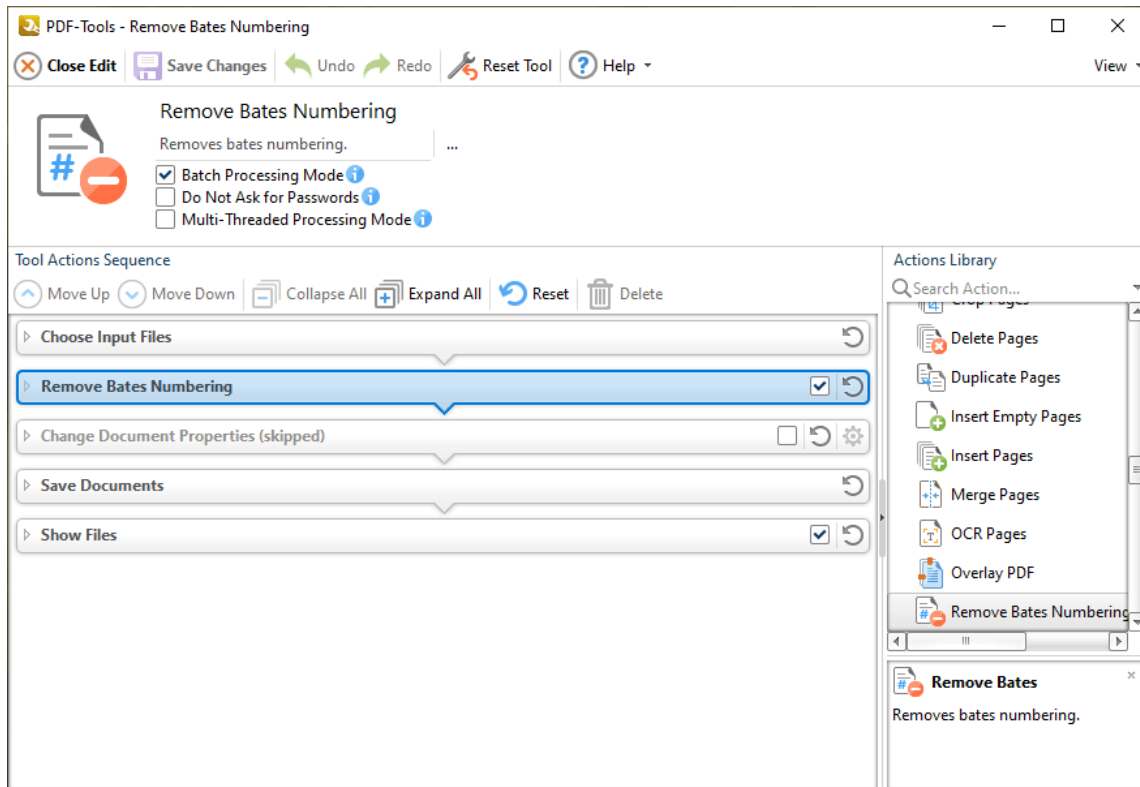

**Figure 1.** Remove Bates Numbering Action Options

Select/clear the check box to enable/disable this action, then click **Save Changes** to save changes.

## 7.7.14 Remove Headers and Footers



### Remove Headers and Footers

The **Remove Headers and Footers** action removes headers and footers from input documents:

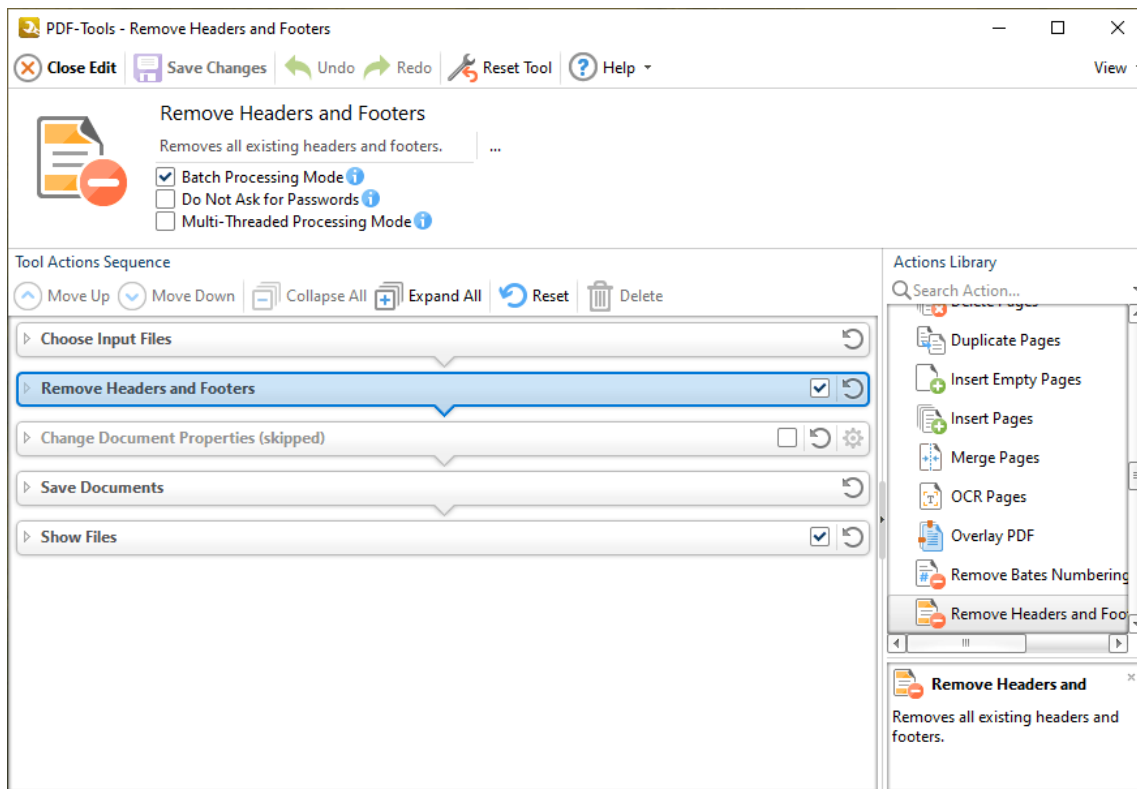



Figure 1. Remove Headers and Footers Action Options

Select/clear the check box to enable/disable this action, then click  **Save Changes** to save changes.

## 7.7.15 Remove Page Background



The **Remove Page Background** action removes backgrounds from input documents:

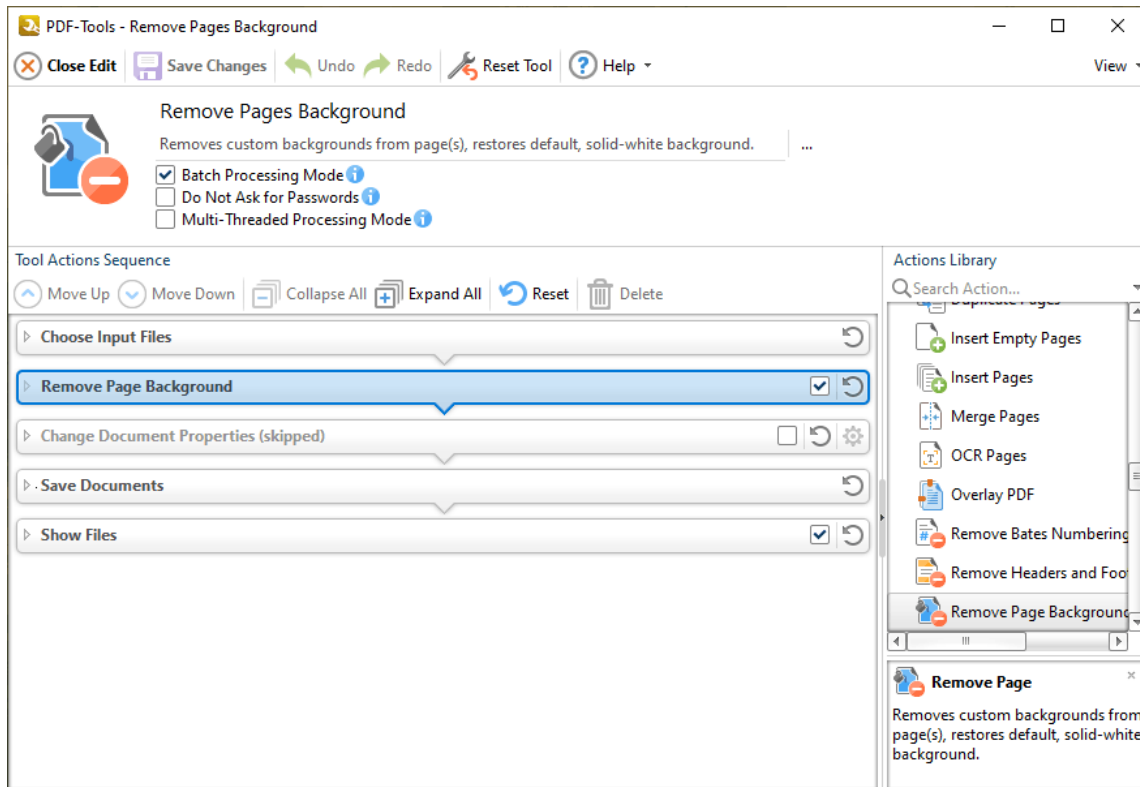

**Figure 1.** Remove Page Background Action Options

Select/clear the check box to enable/disable this action, then click  **Save Changes** to save changes.

## 7.7.16 Remove Watermarks



The **Remove Watermarks** action removes watermarks from input documents:

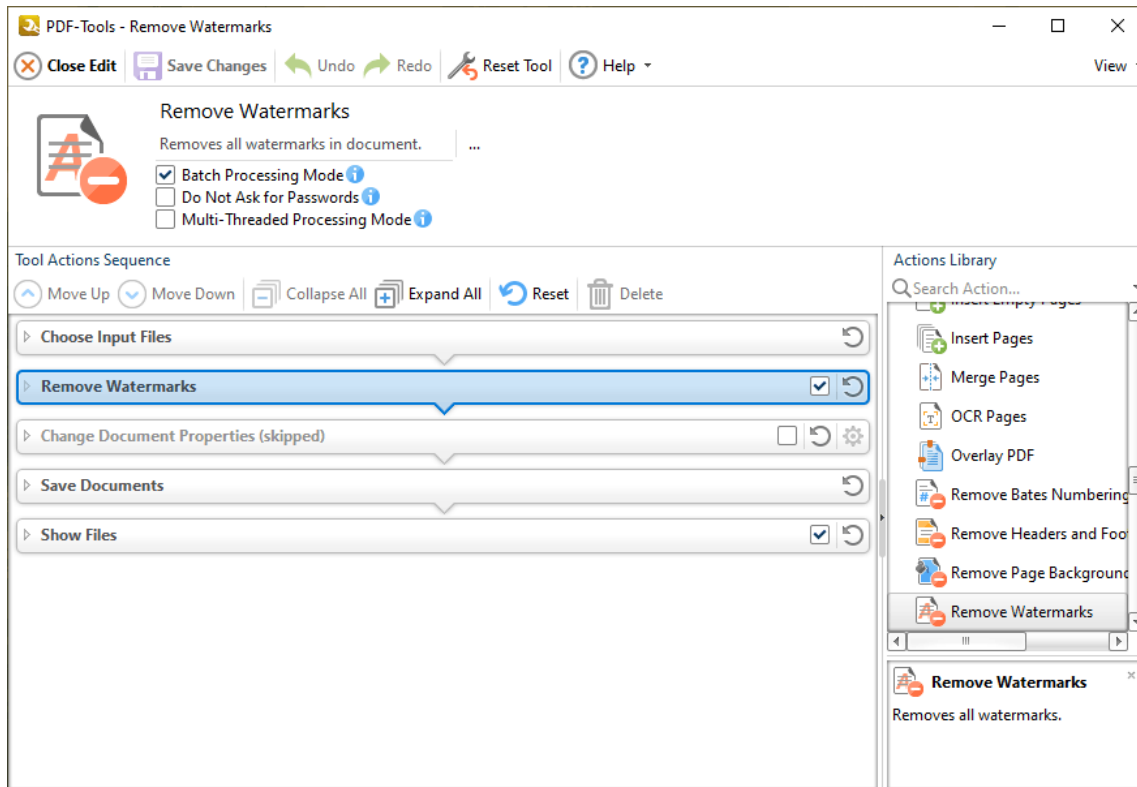

**Figure 1.** Remove Watermarks Action Options

Select/clear the check box to enable/disable this action, then click  **Save Changes** to save changes.

## 7.7.17 Replace Pages



The **Replace Pages** action replaces specified pages of input documents with pages from existing documents. It contains the following customizable parameters:

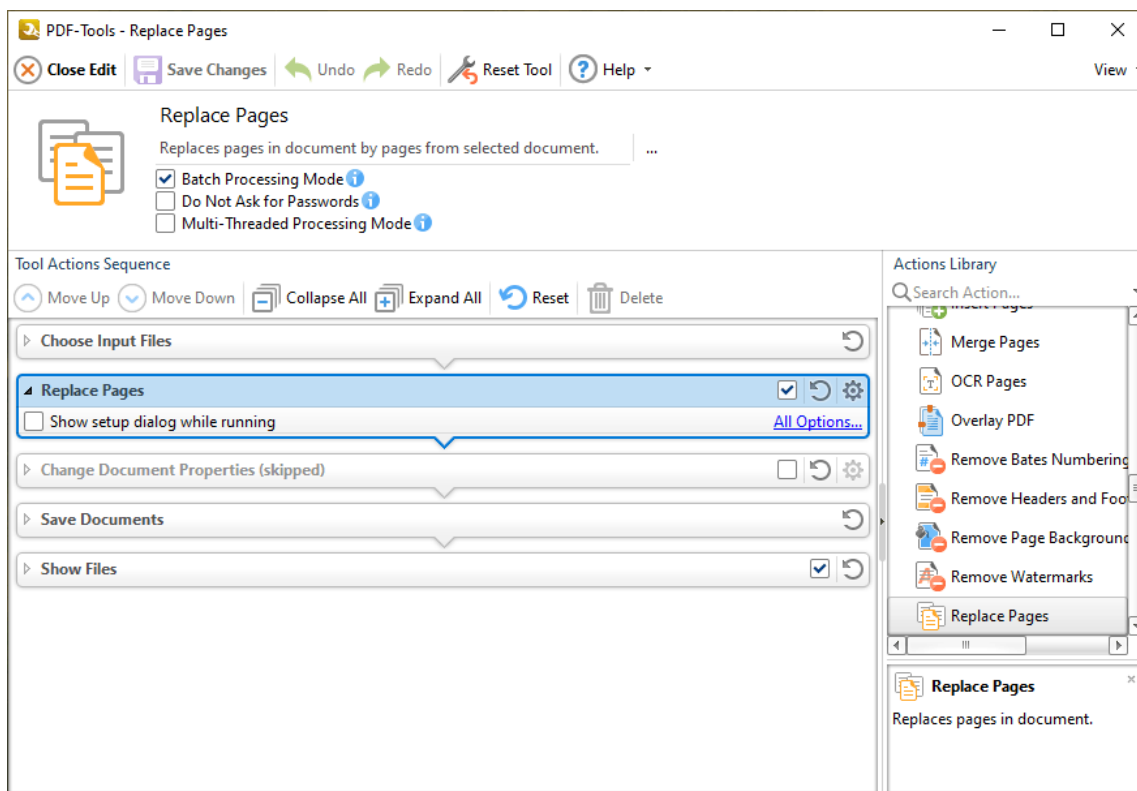

**Figure 1.** Replace Pages Action Options

- Click **All Options** to view/edit all options. The **Replace Pages** dialog box will open, as detailed below.
- Select the **Show setup dialog while running** box to launch the **Replace Pages** dialog box and customize settings each time this action is used. Clear this box to disable the **Replace Pages** dialog box from opening each time the action is used, which is useful when the same settings are used consistently.

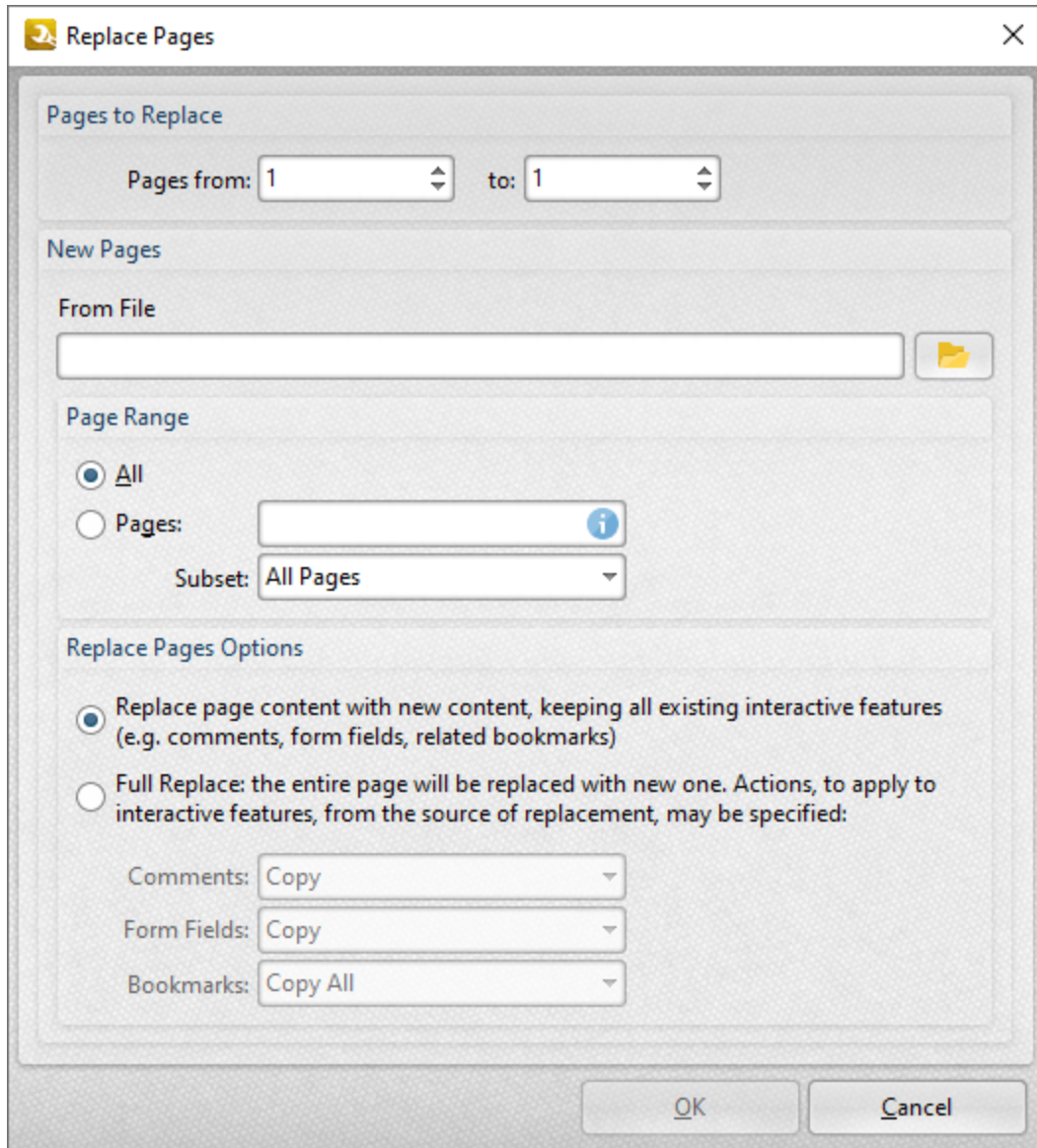

Figure 2. Replace Pages Dialog Box

- Enter the page numbers of the pages to be replaced in the **Page to Replace** number boxes.
- Select either **From File** or **From an Open Document** to determine the source of the replacement pages, then use the **Page Range** settings to determine the page range used. Further information on the specification of page ranges is available [here](#).<sup>552</sup>
- Select a **Replace Pages Options** radio button to determine the parameters of the page replacement, as detailed in *(figure 2)*. Use the dropdown menus to determine the action taken for **Comments**, **Form Fields** and **Bookmarks** in replacement files.

Click **OK** to save changes.

## 7.7.18 Resize Pages



### Resize Pages

The **Resize Pages** action resizes specified pages of input documents. It contains the following customizable parameters:

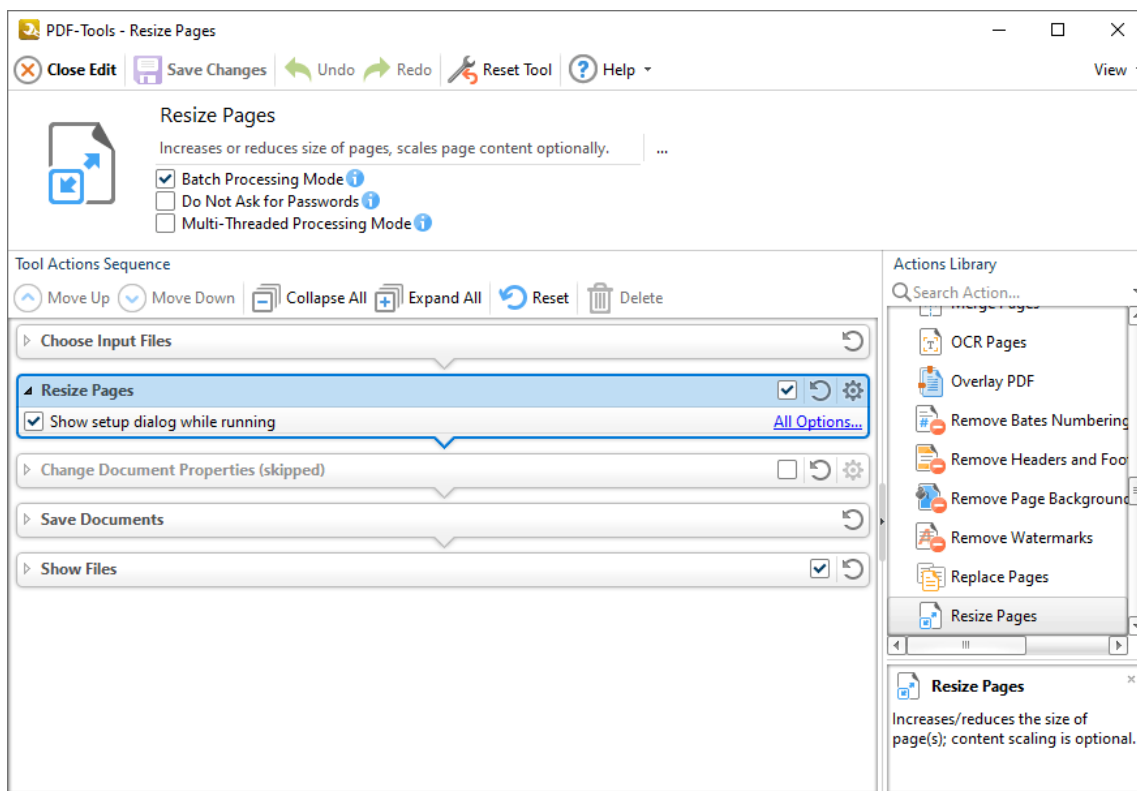

Figure 1. Resize Pages Action Options

- Click **All Options** to view/edit all options. The **Resize Pages** dialog box will open, as detailed below.
- Select the **Show setup dialog while running** box to launch the **Resize Pages** dialog box and customize settings each time this action is used. Clear this box to disable the **Resize Pages** dialog box from opening each time the action is used, which is useful when the same settings are used consistently.



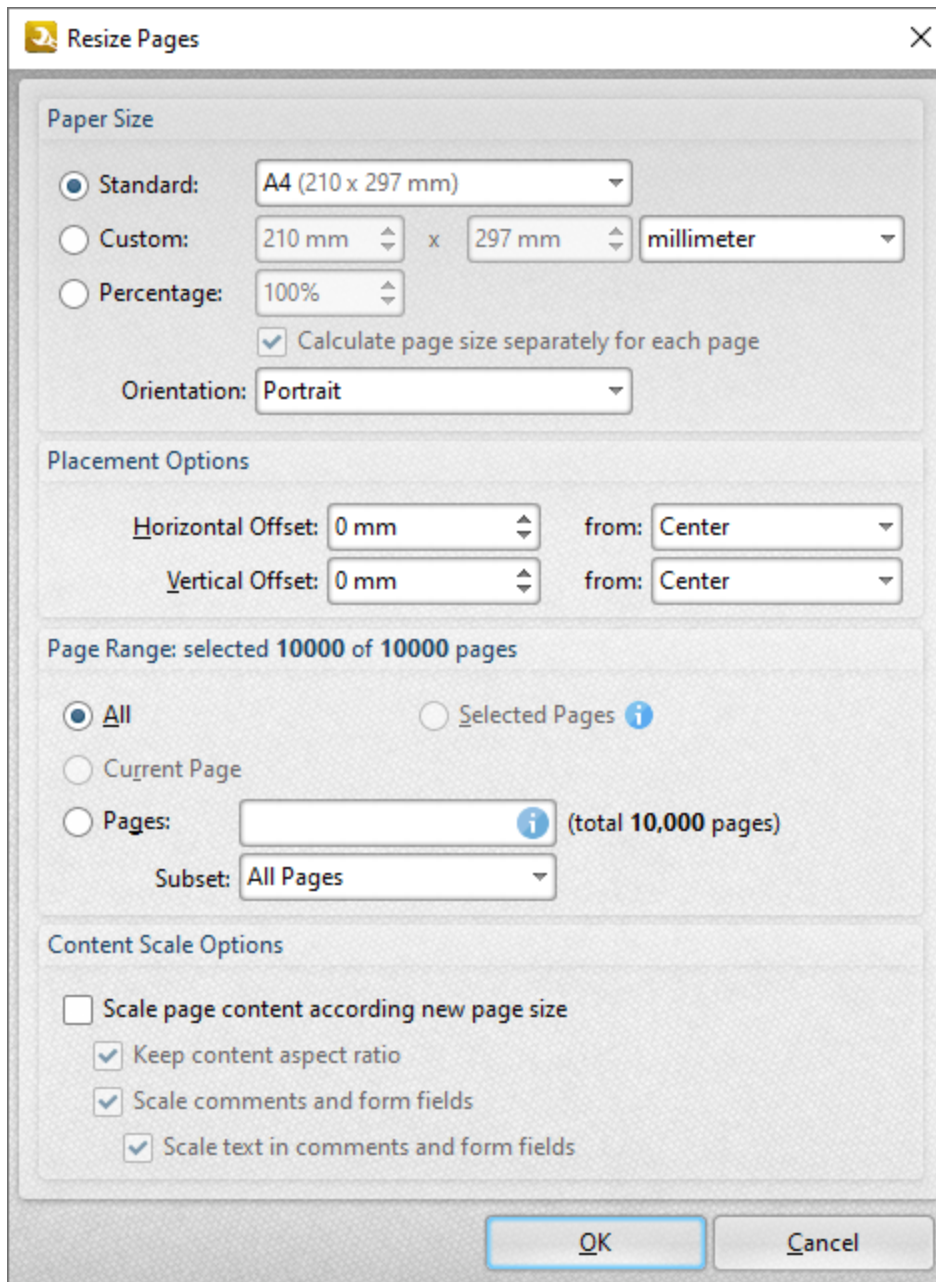

Figure 2. Resize Pages Dialog Box

- Use the **Paper Size** options to determine the size and layout of resized pages:
  - Select **Standard** to use a standard size, such as those used by the **ISO** and **ANSI**. Use the adjacent box to select either **Landscape** or **Portrait** as the page orientation.
  - Select **Custom** to enter custom dimensions. Enter the dimensions in the number boxes and select the units of measurement as desired.
  - Select **Percentage** to set the new paper size as a percentage of the existing paper size, then enter the desired percentage in the number box.
- Use the **Placement** options to determine the horizontal/vertical offset of resized pages and the location from which the offset is made.

- Use the **Page Range** settings to determine the page range of resized pages:
  - Select **All** to resize all pages.
  - The **Current Page** and **Selected Pages** options are not currently available. They will be available in a future build.
  - Select **Pages** to specify a custom page range. Further information on the specification of page ranges is available [here](#).<sup>552</sup>
  - Use the **Subset** option to specify a subset of specified page ranges as desired.
- Use the **Content Scale Options** to determine the scale of page content in relation to the new page size:
  - Select the **Scale page content according new page size** box to scale the content of resized pages to the new page size.
  - Clear the **Keep content aspect ratio** box to scale all content of resized pages to the new page size.
  - Select the **Scale comments and form fields** and **Scale text in comments and form fields** boxes as desired.

Click **OK** to save settings.

---

## 7.7.19 Rotate Pages



The **Rotate Pages** action rotates specified pages of input documents. It contains the following customizable parameters:

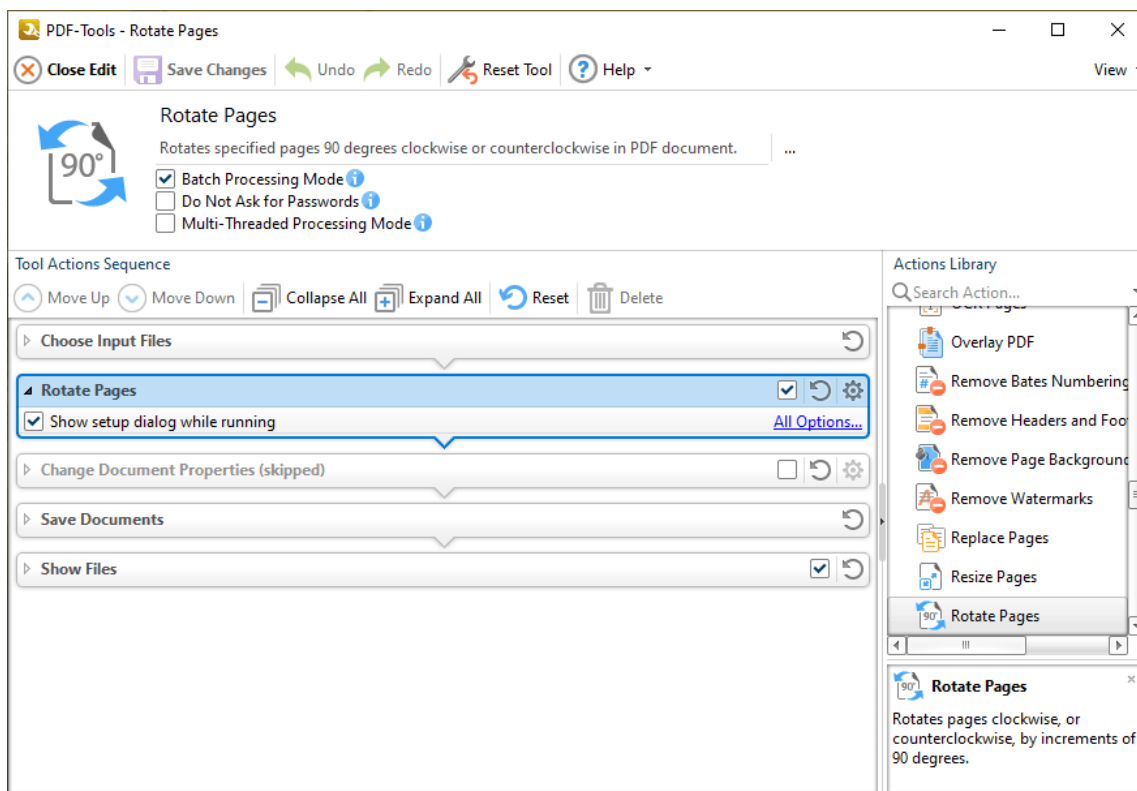

Figure 1. Rotate Pages Action Options

- Click **All Options** to view/edit all options. The **Rotate Pages** dialog box will open, as detailed below.
- Select the **Show setup dialog while running** box to launch the **Rotate Pages** dialog box and customize settings each time this action is used. Clear this box to disable the **Rotate Pages** dialog box from opening each time the action is used, which is useful when the same settings are used consistently.

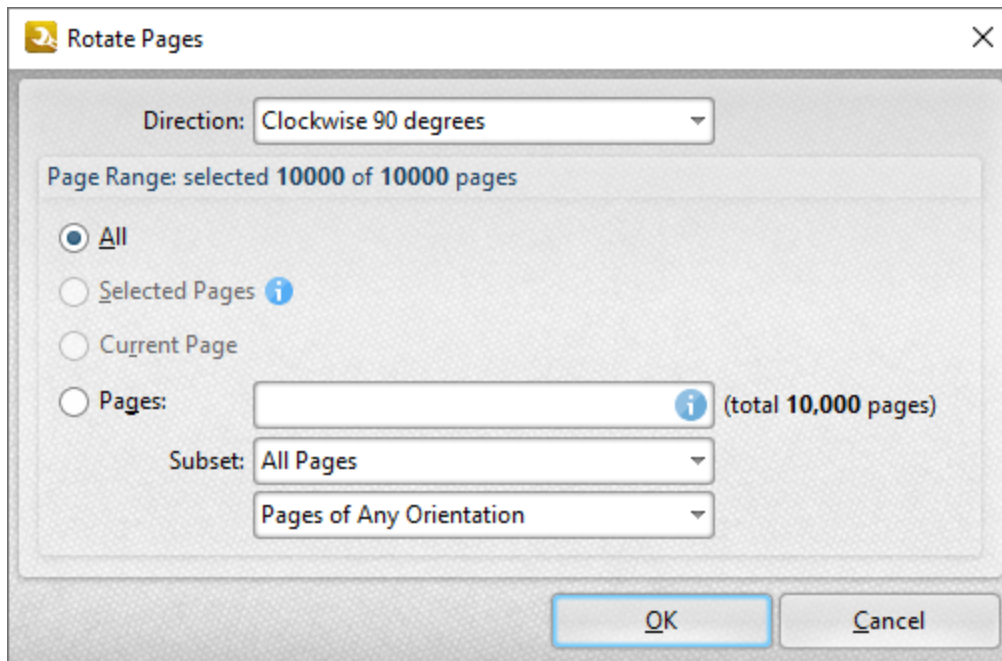

Figure 2. Rotate Pages Dialog Box

- Use the **Direction** dropdown menu to determine the rotation.
- Use the **Page Range** options to determine the page range of rotated pages:
  - Select **All** to rotate all pages.
  - The **Current Page** and **Selected Pages** options are not currently available. They will be available in a future build.
  - Select **Pages** to specify a custom page range. Further information on the specification of page ranges is available [here](#).<sup>552</sup>
  - Use the **Subset** dropdown menu to select a subset of the specified page range. Select **All Pages**, **Odd Pages Only** or **Even Pages Only** as desired.

Click **OK** to save settings.

---

## 7.7.20 Setup Page Transitions



### Setup Page Transitions

The **Setup Page Transitions** action determines the animated effect when moving between document pages in fullscreen mode. It contains the following customizable parameters:

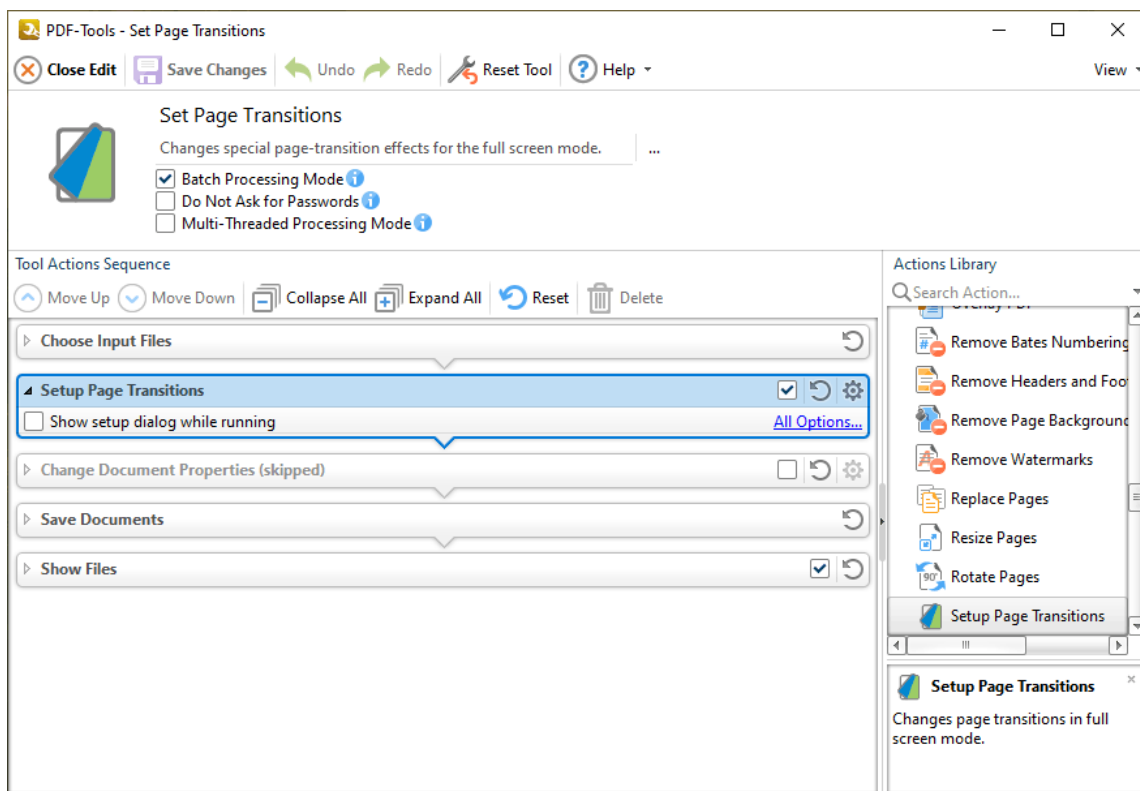

Figure 1. Setup Page Transitions Action Options

- Click **All Options** to view/edit all options. The **Page Transitions** dialog box will open, as detailed below.
- Select the **Show setup dialog while running** box to launch the **Page Transitions** dialog box and customize settings each time this action is used. Clear this box to disable the **Page Transitions** dialog box from opening each time the action is used, which is useful when the same settings are used consistently.

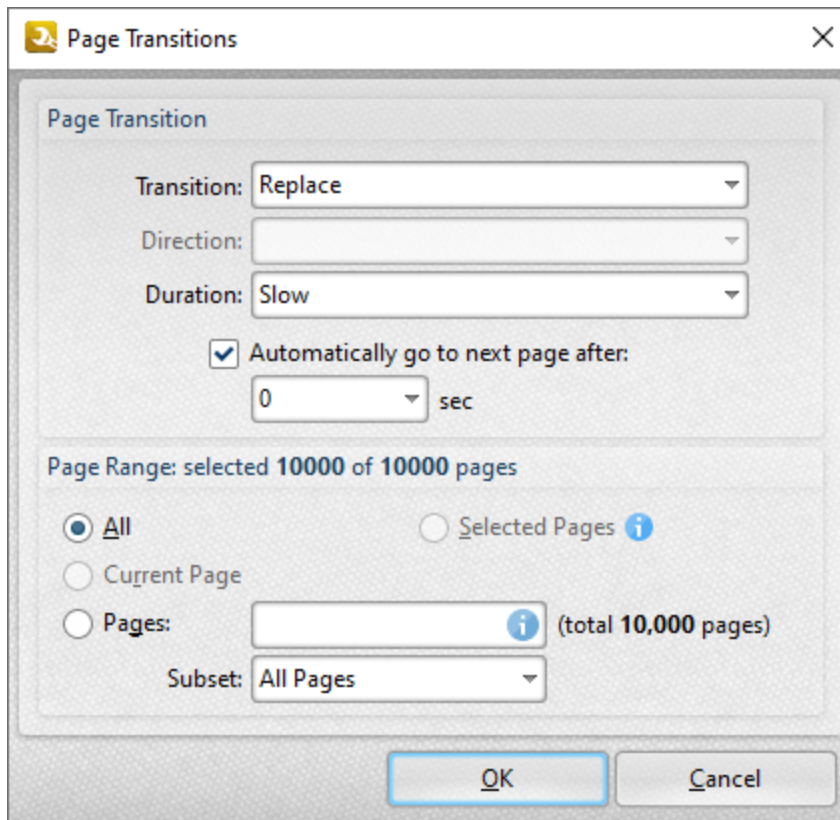

Figure 2. Page Transitions Dialog Box

Use the **Page Transition** settings to determine transition parameters:

- Use the **Transition** dropdown menu to determine the transition style.
- Use the **Direction** dropdown menu to determine the direction of transitions.
- Use the **Duration** dropdown menu to determine the rate of transitions.
- Select the check box to move automatically through pages, then select an option from the dropdown menu to set an automatic scrolling rate.

Use the **Page Range** settings to determine the page range to which the specified transition settings apply:

- Select **All** to specify all pages.
- The **Current Page** and **Selected Pages** options are not currently available. They will be available in a future build.
- Select **Pages** to specify a custom page range. Further information on the specification of page ranges is available [here](#).<sup>[552]</sup> Use the **Subset** dropdown menu to specify a subset of page ranges. Select **All Pages**, **Odd Pages Only** or **Even Pages Only** as desired.

Click **OK** to save changes.

## 7.7.21 Split Pages



The **Split Pages** action splits the pages of input documents into custom sections.. It contains the following customizable parameters:

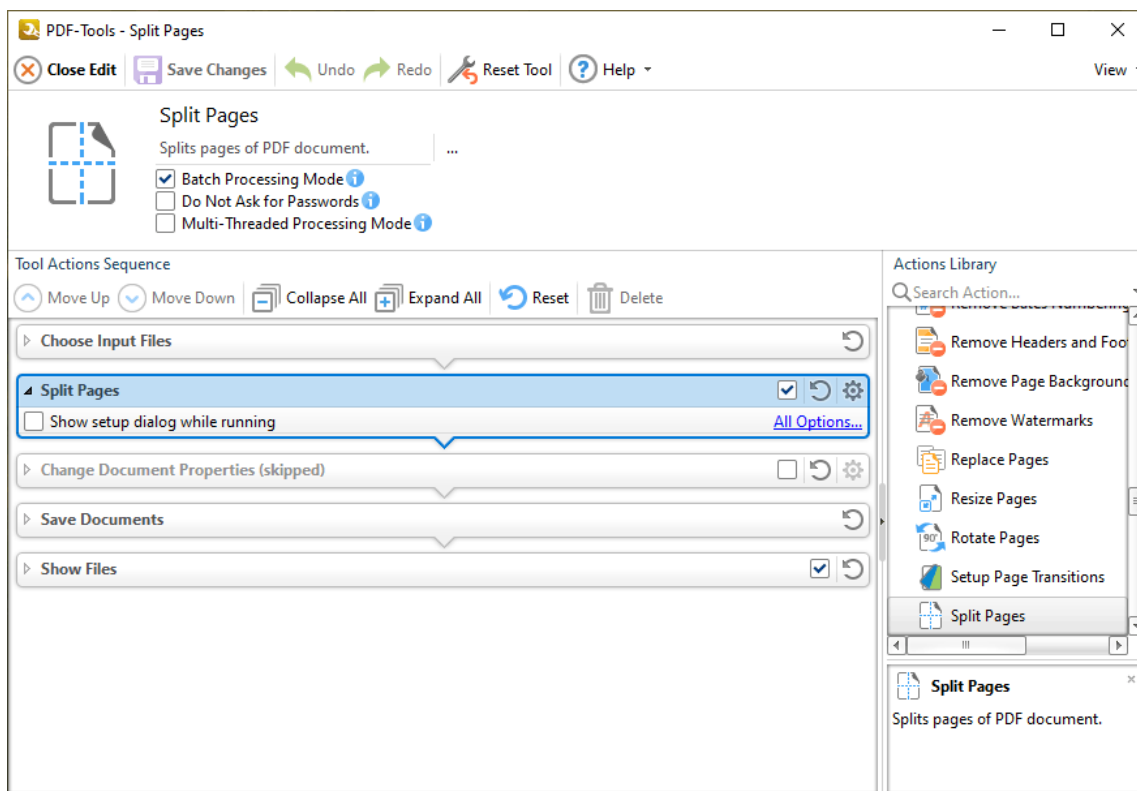

Figure 1. Setup Page Transitions Action Options

- Click **All Options** to view/edit all options. The **Split Pages** dialog box will open, as detailed below.
- Select the **Show setup dialog while running** box to launch the **Split Pages** dialog box and customize settings each time this action is used. Clear this box to disable the **Split Pages** dialog box from opening each time the action is used, which is useful when the same settings are used consistently.

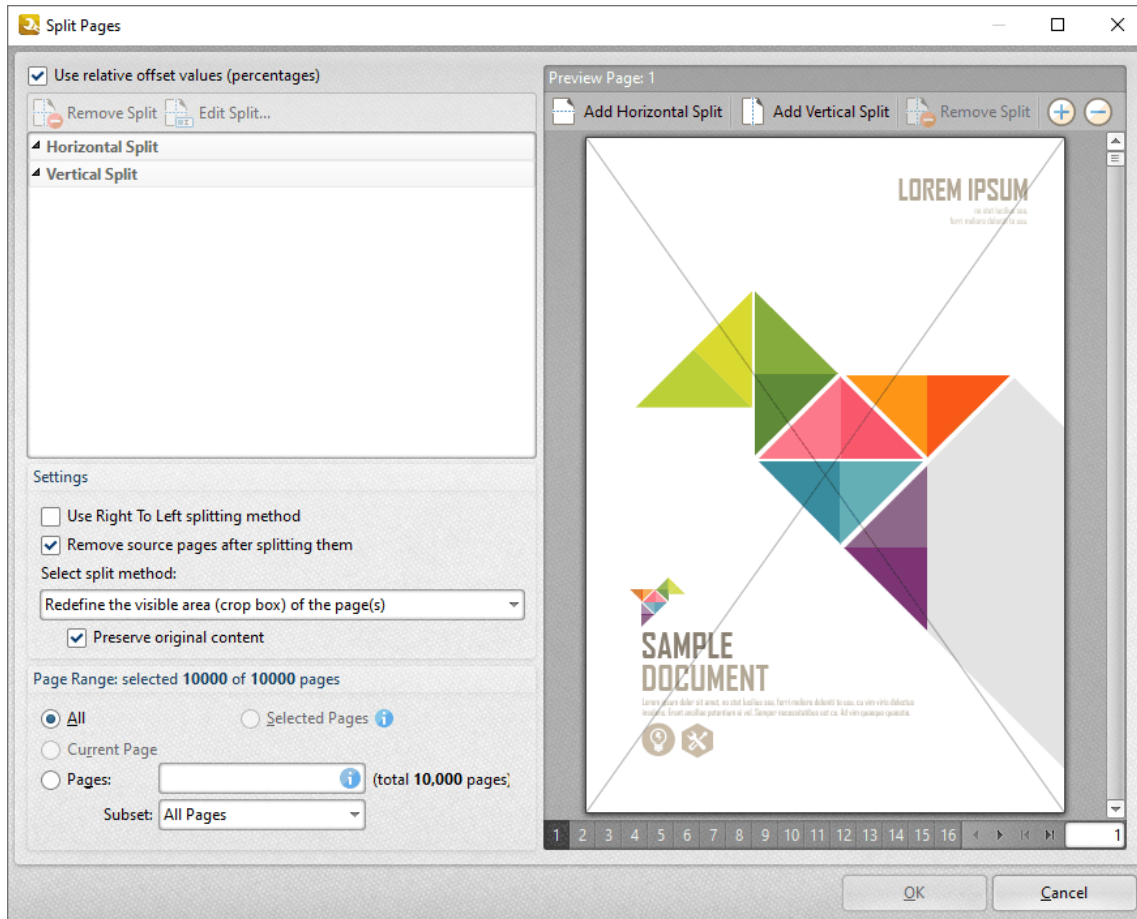

Figure 2. Split Pages Dialog Box

- Percentage is the default method used to split pages. Clear the **Use relative offset values** box to use metric measurements instead.
- Click **Add Horizontal Split** and/or **Add Vertical Split** at the top of the preview pane to add splits to documents. Splits are inserted at 50% by default and will appear in the preview pane and the list of splits when these options are used. Click and drag to reposition splits as desired.
- Use the plus and minus zoom icons to edit the view of the preview pane.
- Click **Edit Split/Remove Split** to edit/remove selected splits in the list of splits.
- Select the **Use Right To Left splitting method** box to split documents from right to left. Note that the order in which documents are split determines the order of sections in the split document.
- Select the **Remove source pages after splitting them** to remove the original document from the active pane when pages are split. If this box is cleared then both the original document and the split pages will be present after pages are split.
- Select an option from the **Select split method** dropdown menu to determine the method used to split documents:
  - **Change the physical size of the pages** adjusts the size of pages in order to split them.
  - **Redefine the visible area (crop box) of the pages** adjusts the crop box of pages. Further information about crop boxes is available [here](#).<sup>482</sup> When this option is used the **Preserve**



**original content** box is available. If this option is enabled then the visible page area will be reduced, but the cropped content will remain available and be present if, for example, pages are resized subsequently.

- The **Page Range** settings are as follows:
  - Select **All** to split all the pages of the document.
  - The **Current Page** and **Selected Pages** options are not currently available. They will be available in a future build.
  - Use the **Pages** box to determine specific pages of the document to be split. Further information on the specification of page ranges is available [here](#).<sup>[552]</sup> Use the **Subset** option to select **All Pages**, **Odd Pages Only** or **Even Pages Only** for page ranges specified in the **Pages** number box.

Click **OK** to save changes.

---

## 7.8 Links Actions

---





### Links Actions

---

The **Links** actions create/delete links and weblinks:

 **Create Weblinks** <sup>[243]</sup> creates weblinks from the text of input documents.

 **Delete Links** <sup>[245]</sup> deletes links from input documents.

 **Delete Weblinks** <sup>[247]</sup> deletes weblinks from input documents.

---

## 7.8.1 Create Weblinks



The **Create Weblinks** action creates weblinks from the text of input documents. It contains the following customizable parameters:

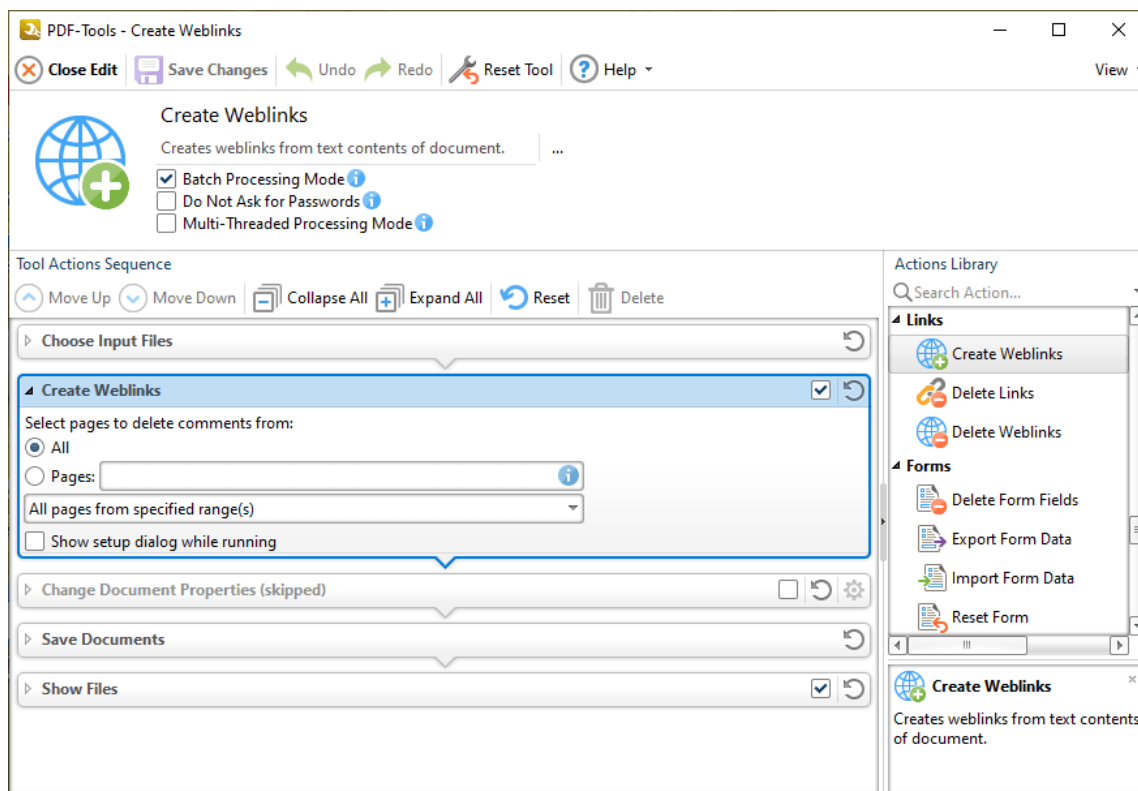

Figure 1. Create Weblinks Action Options

- Select **All** to create weblinks from the appropriate text of all pages in the input document.
- Select **Pages** to specify a custom page range, then enter the desired range in the text box. Further information on the specification of page ranges is available [here](#).
- Use the dropdown menu to select a subset of specified page ranges as desired.
- Select the **Show setup dialog while running** box to launch the **Create Weblinks** dialog box and customize settings each time this action is used. Clear this box to disable the **Create Weblinks** dialog box from opening each time the action is used, which is useful when the same settings are used consistently.

Click  **Save Changes** to save changes.

---

## 7.8.2 Delete Links



The **Delete Links** action deletes links from input documents. It contains the following customizable parameters:

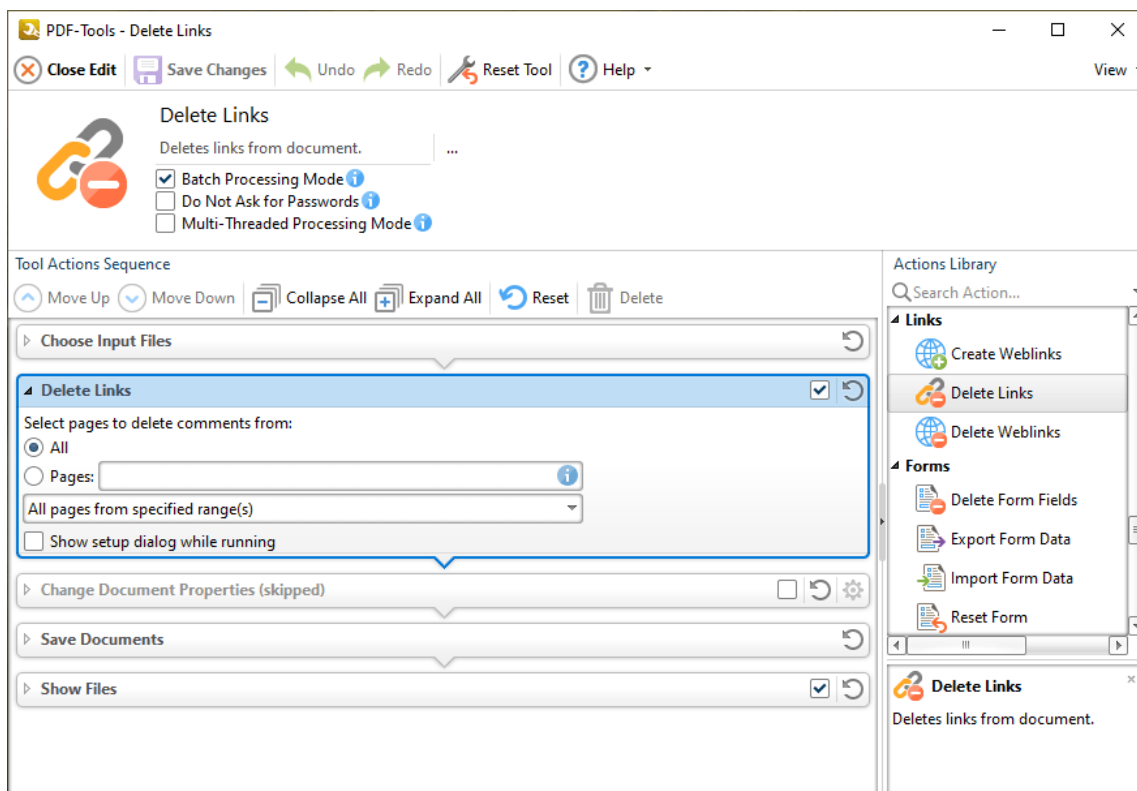

Figure 1. Delete Links Action Options

- Select **All** to delete links from all pages of the input document.
- Select **Pages** to specify a custom page range, then enter the desired range in the text box. Further information on the specification of page ranges is available [here](#).<sup>552</sup>
- Use the dropdown menu to select a subset of specified page ranges as desired.
- Select the **Show setup dialog while running** box to launch the **Delete Links** dialog box and customize settings each time this action is used. Clear this box to disable the **Delete Links** dialog box from opening each time the action is used, which is useful when the same settings are used consistently.

Click  **Save Changes** to save changes.

---

7.8.3 Delete Weblinks



The **Delete Weblinks** action deletes weblinks from input documents. It contains the following customizable parameters:

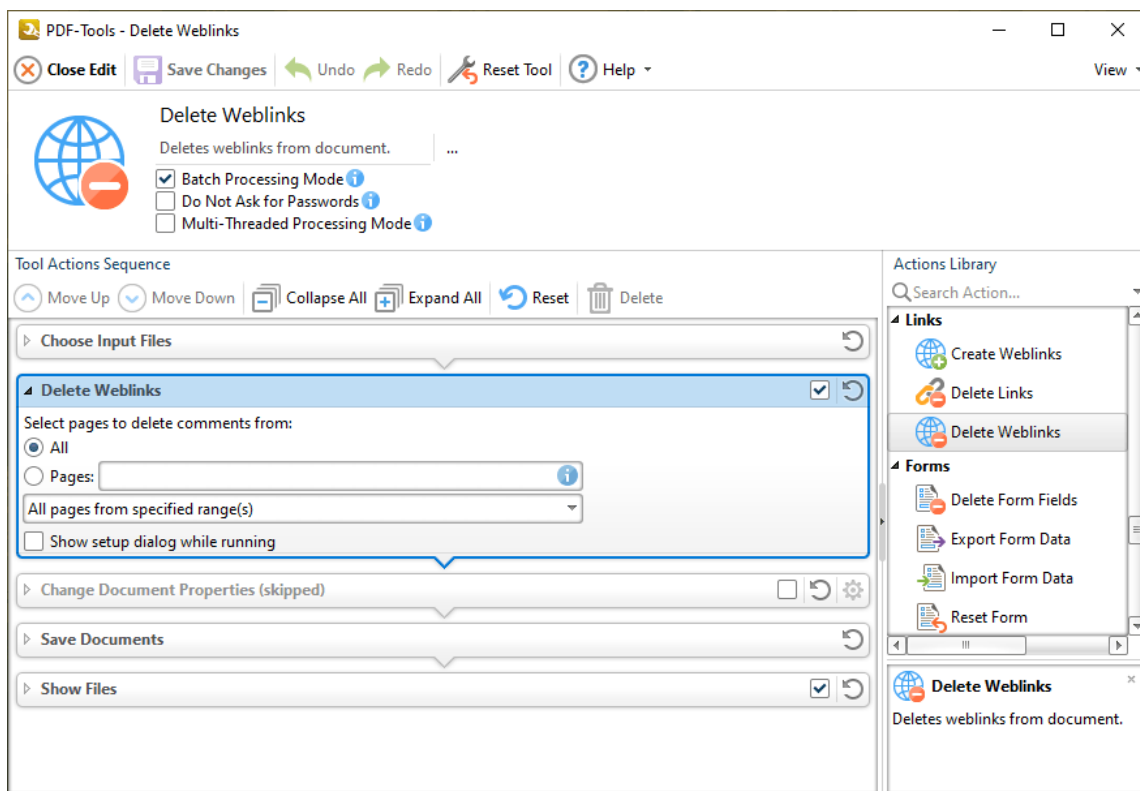

Figure 1. Delete Weblinks Action Options

- Select **All** to delete weblinks from all pages of the input document.
- Select **Pages** to specify a custom page range, then enter the desired range in the text box. Further information on the specification of page ranges is available [here](#).<sup>552</sup>
- Use the dropdown menu to select a subset of specified page ranges as desired.
- Select the **Show setup dialog while running** box to launch the **Delete Weblinks** dialog box and customize settings each time this action is used. Clear this box to disable the **Delete Weblinks** dialog box from opening each time the action is used, which is useful when the same settings are used consistently.

Click  **Save Changes** to save changes.

---



## 7.9 Forms Actions





---



### Forms Actions

---

The **Forms** actions create/delete links and weblinks:

-  [Delete Form Fields](#)<sup>[250]</sup> deletes form fields from input documents.
  -  [Export Form Data](#)<sup>[252]</sup> exports form data to a file.
  -  [Import Form Data](#)<sup>[254]</sup> imports form data from a file.
  -  [Reset Form](#)<sup>[256]</sup> resets all form fields in input documents.
-

## 7.9.1 Delete Form Fields



The **Delete Form Fields** action deletes form fields from input documents. It contains the following customizable parameters:

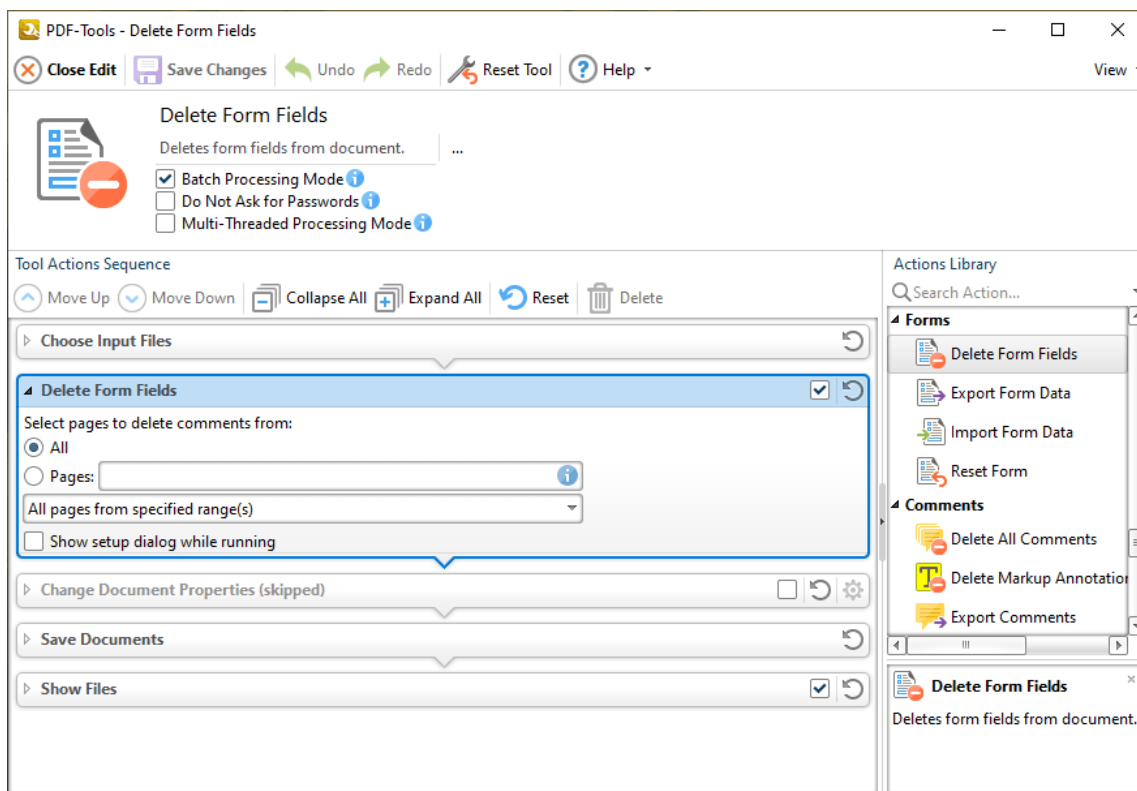

Figure 1. Delete Form Fields Action Options

- Select **All** to delete form fields from all pages of the input document.
- Select **Pages** to specify a custom page range, then enter the desired range in the text box. Further information on the specification of page ranges is available [here](#).<sup>552</sup>
- Use the dropdown menu to select a subset of specified page ranges as desired.
- Select the **Show setup dialog while running** box to launch the **Delete Form Fields** dialog box and customize settings each time this action is used. Clear this box to disable the **Delete Form Fields** dialog box from opening each time the action is used, which is useful when the same settings are used consistently.

Click  **Save Changes** to save changes.

---

## 7.9.2 Export Form Data



### Export Form Data

The **Export Form Data** action exports form data from documents to a file. It contains the following customizable parameters:

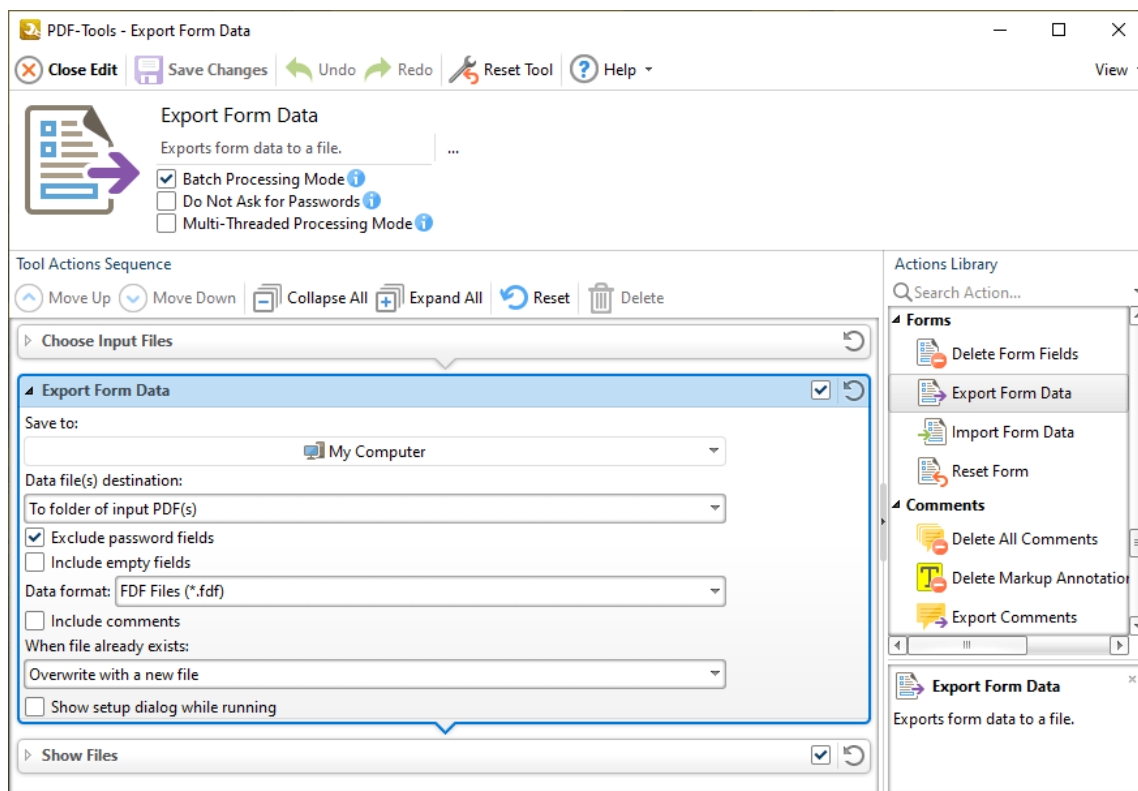

Figure 1. Export Form Data Action Options

- Select an option in the **Data file(s) destination** dropdown menu to determine the folder of output documents:
  - Select **To folder of input PDF(s)** to place output documents in the same folder as the source documents.
  - Select **to custom folder** to place output documents in a custom folder, then click the text box or the ellipsis icon to select a folder.
- Select/clear the **Exclude password fields** box to exclude/include password fields in the exported data when this action is used.
- Select/clear the **Include empty fields** box to include/exclude empty fields in the exported data when this action is used.

- Select an option in the **Data Format** dropdown menu to determine the format of output files.
- Select/clear the **Include comments** box to include/exclude comments in the exported data when this action is used.
- Select an option in the **When File Already Exists** dropdown menu to determine the action taken when the filename specified for output documents is already in use:
  - **Overwrite with a new file** overwrites the existing file with the new file.
  - **Keep existing file unchanged** retains the existing file and does not save the new file.
- Select the **Show setup dialog while running** box to launch the **Export Form Data** dialog box and customize settings each time this action is used. Clear this box to disable the **Export Form Data** dialog box from opening each time the action is used, which is useful when the same settings are used consistently.

Click  **Save Changes** to save changes.

---

7.9.3 Import Form Data



The **Import Form Data** action imports form data from a file. It contains the following customizable parameters:

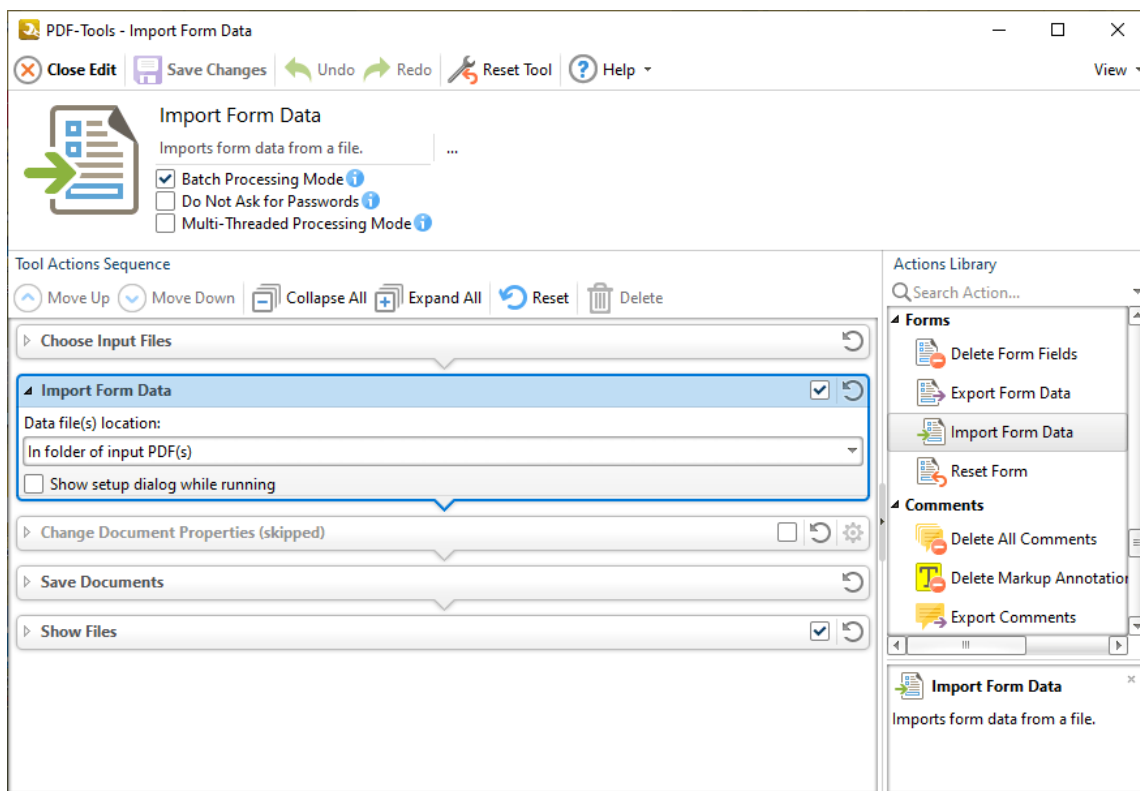

Figure 1. Import Form Action Options

- Select an option in the **Data file(s) destination** dropdown menu to specify the location of the file that contains the form data to be imported:
  - Select **In folder of input PDF(s)** to specify a file that is located in the same folder as the source documents.
  - Select **In custom folder** to specify a custom folder, then click the text box or the ellipsis icon to select a folder.
  - Select **In specific file** to specify a specific file, then click the text box or the ellipsis icon to select a file.
- Select the **Show setup dialog while running** box to launch the **Import Form Data** dialog box and customize settings each time this action is used. Clear this box to

disable the **Import Form Data** dialog box from opening each time the action is used, which is useful when the same settings are used consistently.

Please note that the field names of forms must match in order for form data to be imported. For example, if there are three forms in the file from which data is imported that have the field names 'Text1', 'Text2' and 'Text3' respectively, then the target document must contain forms with the same field names in order for form data to import.

Additionally, the file format of the files that contain the imported form data must be **(\* .fdf)**, **(\* .xfdf)** or **(\* .csv)**. The [Export Form Data](#)<sup>383</sup> tool can be used to export form data from documents to these formats.

Click  **Save Changes** to save changes.

---

## 7.9.4 Reset Form



The **Reset Form** action removes all form data from input documents:

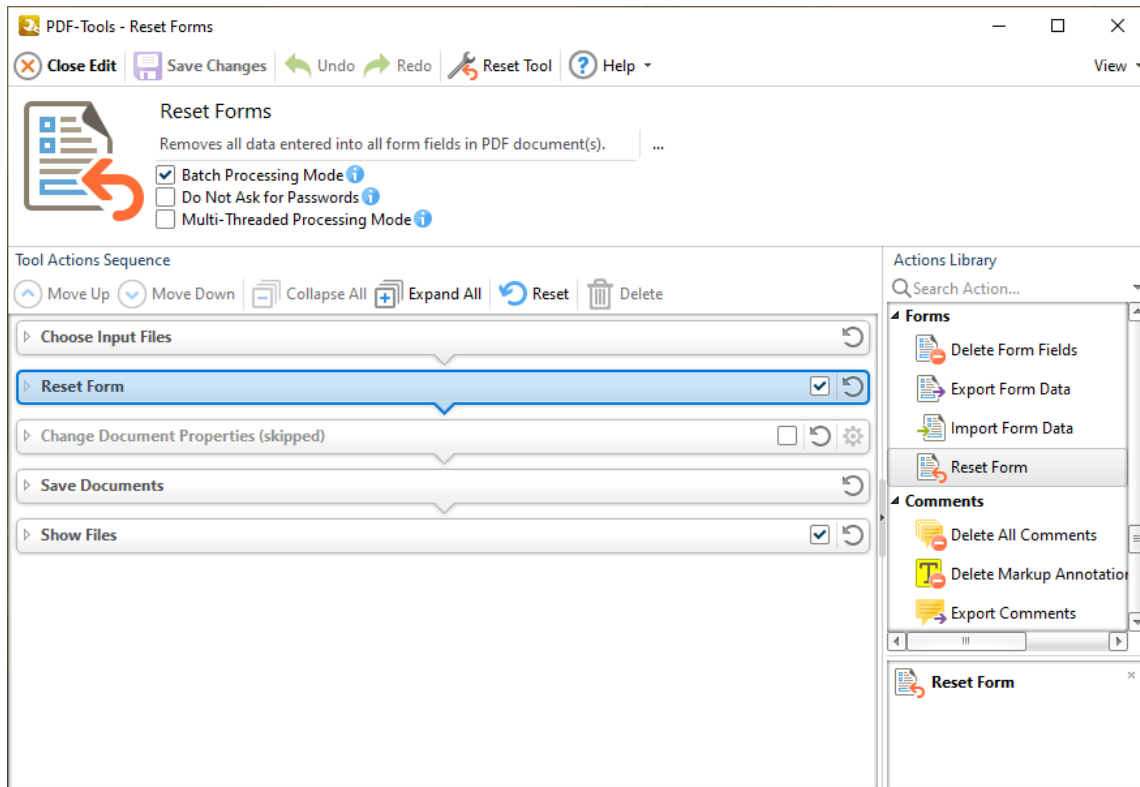

**Figure 1.** Reset Form Action Options

Select/clear the check box to enable/disable this action, then click  **Save Changes** to save changes.



## 7.10 Comments Actions







---



### Comments Actions

---

The **Comments** actions edit and manipulate the comments of input documents:

-  [Delete All Comments](#) <sup>[258]</sup> deletes comments of all formats from input documents.
  -  [Delete Markup Annotations](#) <sup>[260]</sup> deletes markup annotations from input documents.
  -  [Export Comments](#) <sup>[262]</sup> exports comments from input documents to file.
  -  [Flatten Comments and Fields](#) <sup>[264]</sup> flattens comments and fields in input documents.
  -  [Import Comments](#) <sup>[266]</sup> imports comments into input documents.
  -  [Summarize Comments](#) <sup>[268]</sup> creates a summary of the comments in input documents.
-

## 7.10.1 Delete All Comments



The **Delete All Comments** action deletes comments of all formats from input documents. It contains the following customizable parameters:

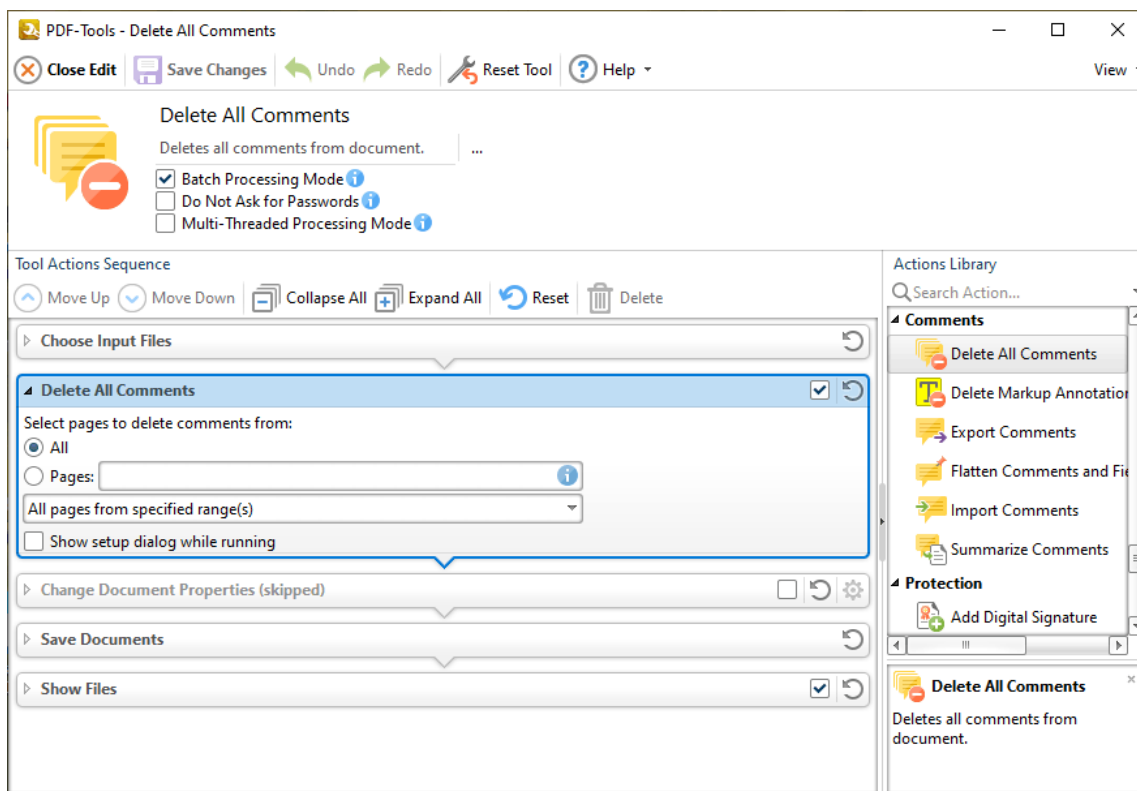

**Figure 1.** Delete All Comments Action Options

- Select **All** to delete comments from all pages of the input document.
- Select **Pages** to specify a custom page range, then enter the desired range in the text box. Further information on the specification of page ranges is available [here](#).<sup>552</sup>
- Use the dropdown menu to select a subset of specified page ranges as desired.
- Select the **Show setup dialog while running** box to launch the **Delete All Comments** dialog box and customize settings each time this action is used. Clear this box to disable the **Delete All Comments** dialog box from opening each time the action is used, which is useful when the same settings are used consistently.

Click  **Save Changes** to save changes.

---

7.10.2 Delete Markup Annotations



## Delete Markup Annotations

The **Delete Markup Annotations** action deletes markup annotations from input documents. It contains the following customizable parameters:

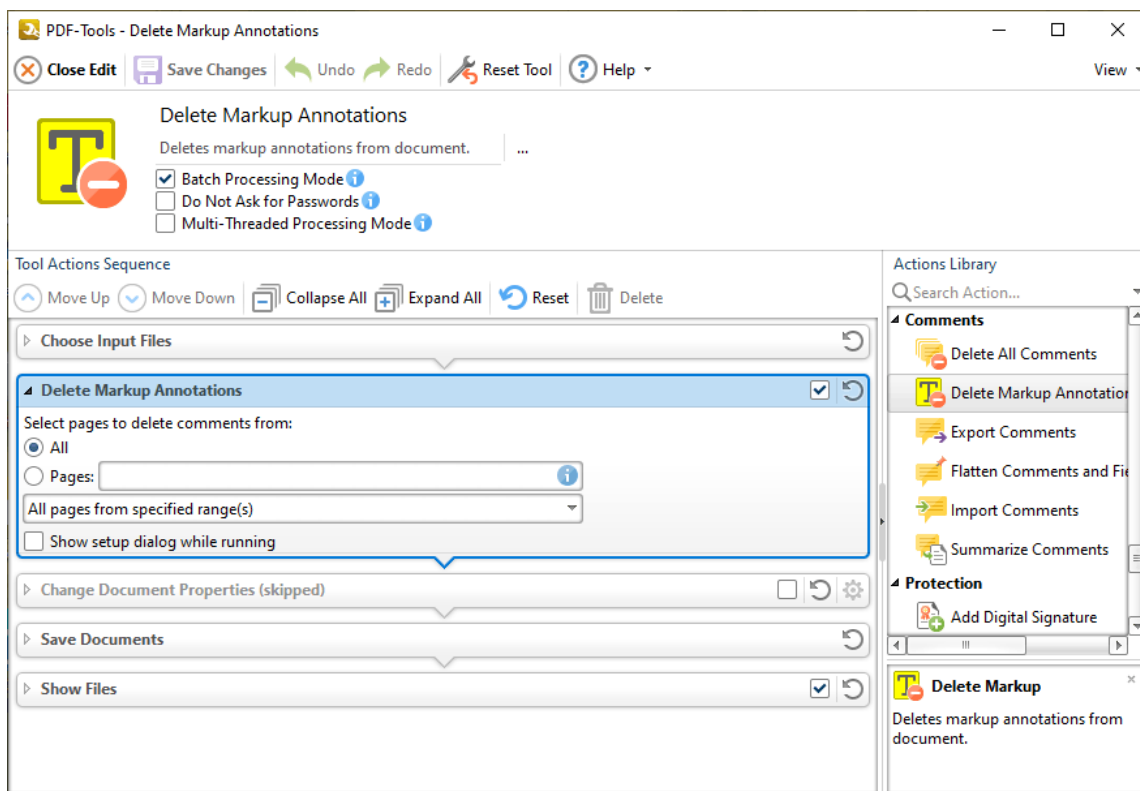

Figure 1. Delete Markup Annotation Action Options

- Select **All** to delete markup annotations from all pages in the input document.
- Select **Pages** to specify a custom page range, then enter the desired range in the text box. Further information on the specification of page ranges is available [here](#).<sup>552</sup>
- Use the dropdown menu to select a subset of specified page ranges as desired.
- Select the **Show setup dialog while running** box to launch the **Delete Markup Annotations** dialog box and customize settings each time this action is used. Clear this box to disable the **Delete Markup Annotations** dialog box from opening each time the action is used, which is useful when the same settings are used consistently.

Click  **Save Changes** to save changes.

---

## 7.10.3 Export Comments



### Export Comments

The **Export Comments** action exports comments from input documents. It contains the following customizable parameters:

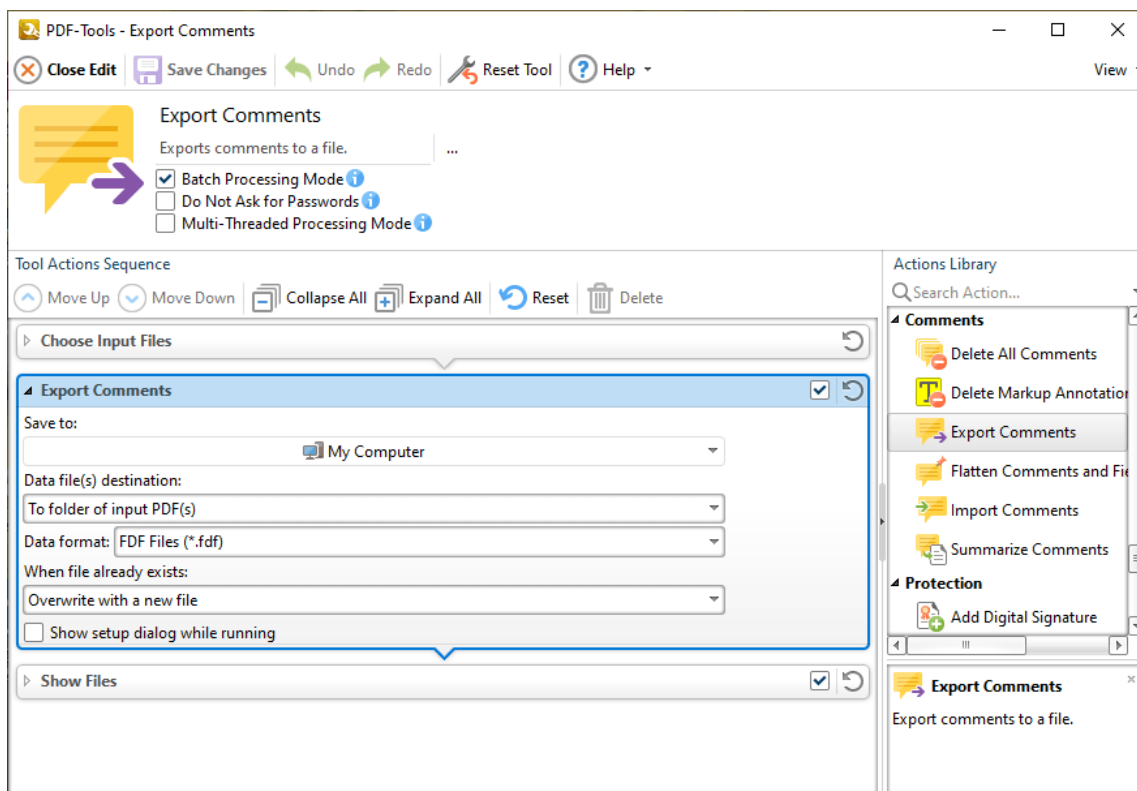

Figure 1. Export Comments Action Options

- Use the **Save to** dropdown menu to determine where output files are saved:
  - Click **My Computer** to save files to the local computer.
  - Hover over **Add Place** to add a new place at which to save files, then click **Box.com, Dropbox, Google Drive, OneDrive** or **Sharepoint** to add accounts from these locations. **PDF-Tools** will prompt for the login information for the selected account. When this information has been entered, the account will be detailed in the list and can be used to save files as desired.
- Use the **Data file(s) destination** dropdown menu to determine the folder of output documents:

- Select **To folder of input PDF(s)** to place output documents in the same folder as the source documents.
- Select **to custom folder** to place output documents in a custom folder, then click the text box or the ellipsis icon to select a folder.
- Select an option in the **Data format** dropdown menu to determine the format of the output document.
- Select an option in the **When file already exists** dropdown menu to determine the action taken when the filenames of output documents are already in use:
  - **Overwrite with a new file** overwrites the existing file with the new file.
  - **Keep existing file unchanged** retains the existing file and does not save the new file.
- Select the **Show setup dialog while running** box to launch the **Export Comments** dialog box and customize settings each time this action is used. Clear this box to disable the **Export Comments** dialog box from opening each time the action is used, which is useful when the same settings are used consistently.

Click  **Save Changes** to save changes.

---

## 7.10.4 Flatten Comments and Fields



### Flatten Comments and Fields

The **Flatten Comments and Fields** action flattens the comments and form fields of input documents into base content. It contains the following customizable parameters:

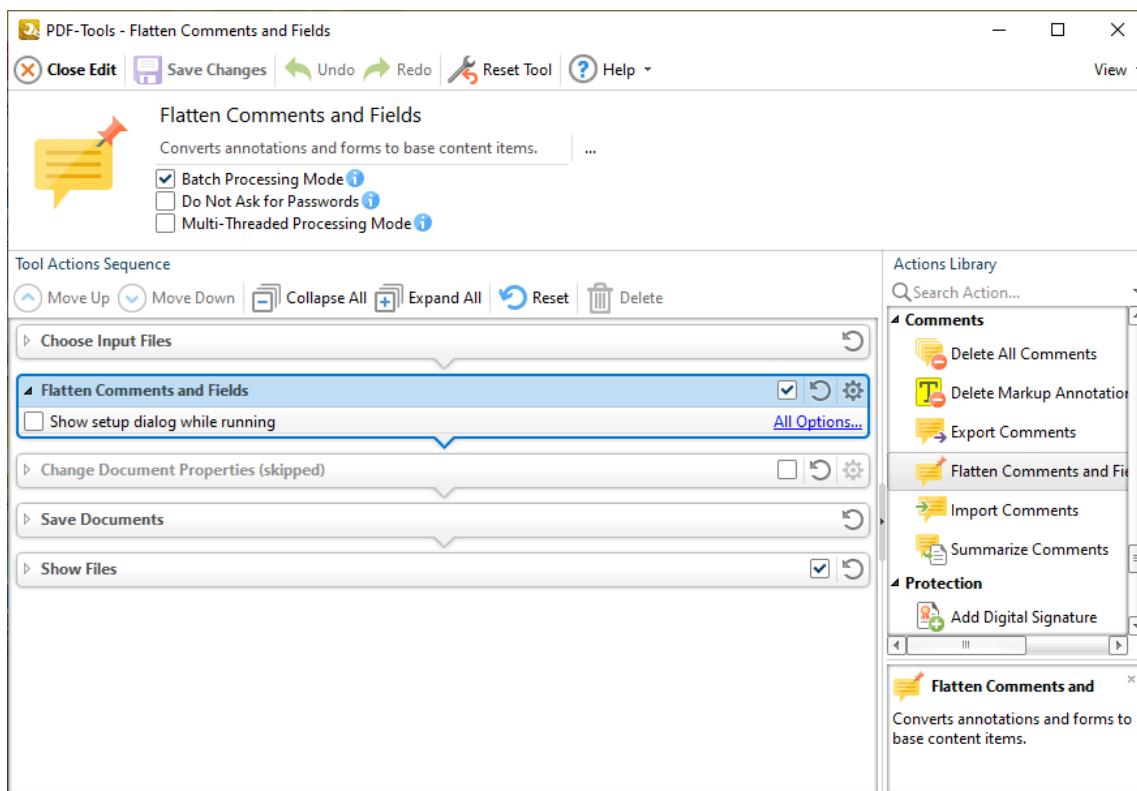

Figure 1. Flatten Comments and Fields Action Options

- Click **All Options** to view/edit all options. The **Flatten Annotations** dialog box will open, as detailed below.
- Select the **Show setup dialog while running** box to launch the **Flatten Annotations** dialog box and customize settings each time this action is used. Clear this box to disable the **Flatten Annotations** dialog box from opening each time the action is used, which is useful when the same settings are used consistently.



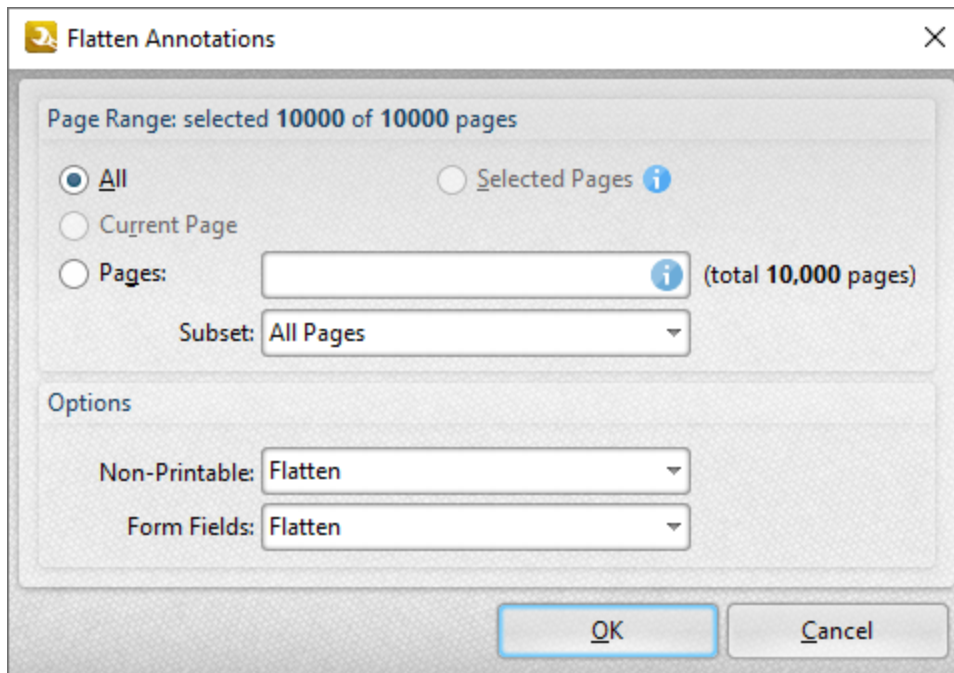

Figure 2. Flatten Annotations Dialog Box

- Use the **Page Range** options to determine the page range in which comments are flattened:
  - Select **All** to flatten comments on all pages.
  - The **Current Page** and **Selected Page** options are not currently available. They will be available in a future build.
  - Use the **Pages** box to specify a custom page range in which to flatten comments. Further information on the specification of page ranges is available [here](#).<sup>552</sup>
  - Use the **Subset** option to specify a subset of pages for custom page ranges as desired.
- Use the **Non-Printable** and **Form Fields** dropdown menus to determine the outcome of the flattening process for non-printable annotations and form fields:
  - Select **Flatten** to flatten content
  - Select **Left as Is** to retain the existing state of content.
  - Select **Remove** to remove the content from the document.

Click **OK** to save changes.

7.10.5 Import Comments



## Import Comments

The **Import Comments** action imports comments into input documents. It contains the following customizable parameters:

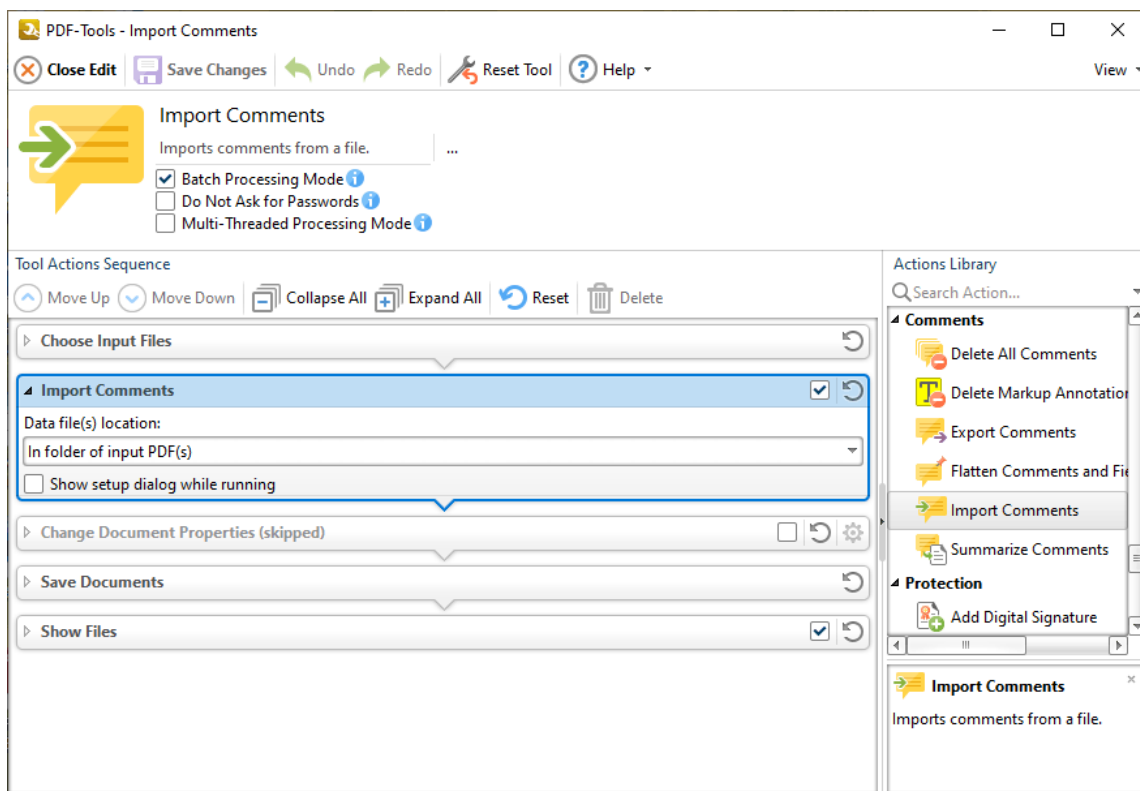

Figure 1. Import Comments Action Options

- Select an option in the **Data file(s) location** dropdown menu to specify the location of the file that contains the comments to be imported:
  - Select **In folder of input PDF(s)** to specify a file that is located in the same folder as the source documents.
  - Select **In custom folder** to specify a custom folder, then click the text box or the ellipsis icon to select a folder.
  - Select **In specific file** to specify a specific file, then click the text box or the ellipsis icon to select a file.
- Select the **Show setup dialog while running** box to launch the **Import Comments** dialog box and customize settings each time this action is used. Clear this box to

disable the **Import Comments** dialog box from opening each time the action is used, which is useful when the same settings are used consistently.

Click  **Save Changes** to save changes.

---

## 7.10.6 Summarize Comments



The **Summarize Comments** action creates a summary of comments in input documents. It contains the following customizable parameters:

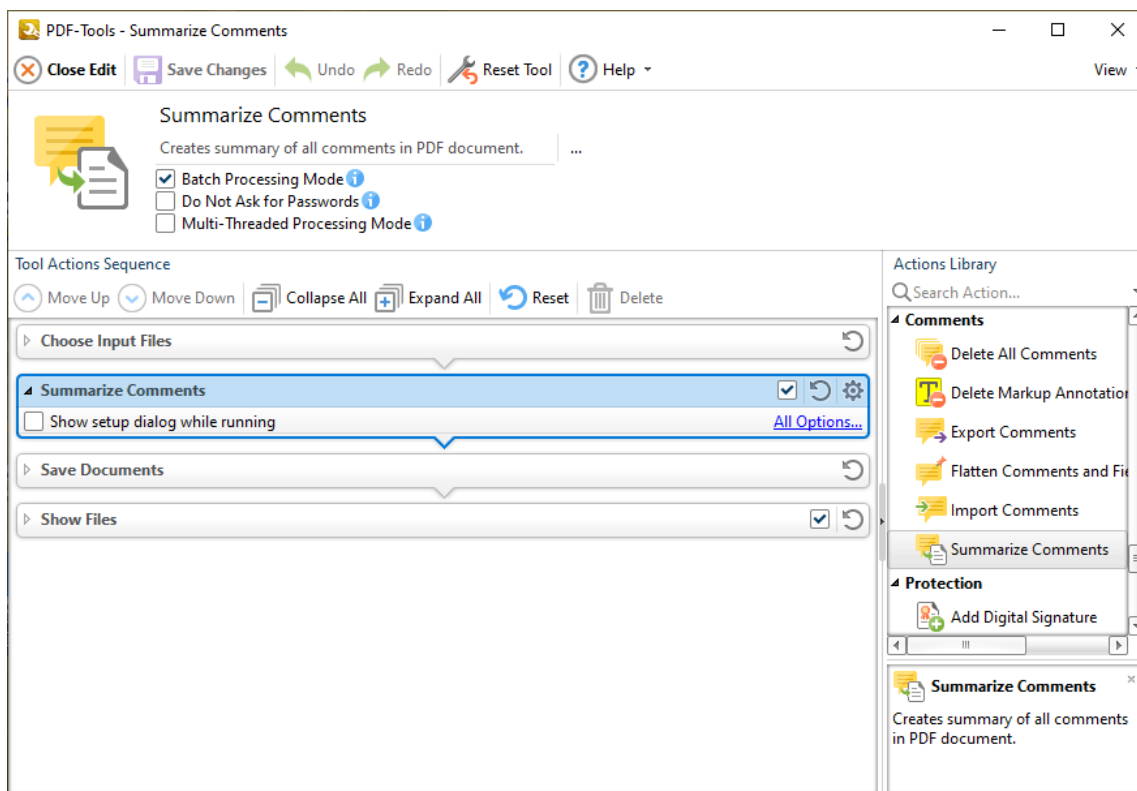

**Figure 1.** Summarize Comments Action Options

- Click **All Options** to view/edit all options. The **Summarize Comments** dialog box will open, as detailed below.
- Select the **Show setup dialog while running** box to launch the **Summarize Comments** dialog box and customize settings each time this action is used. Clear this box to disable the **Summarize Comments** dialog box from opening each time the action is used, which is useful when the same settings are used consistently.

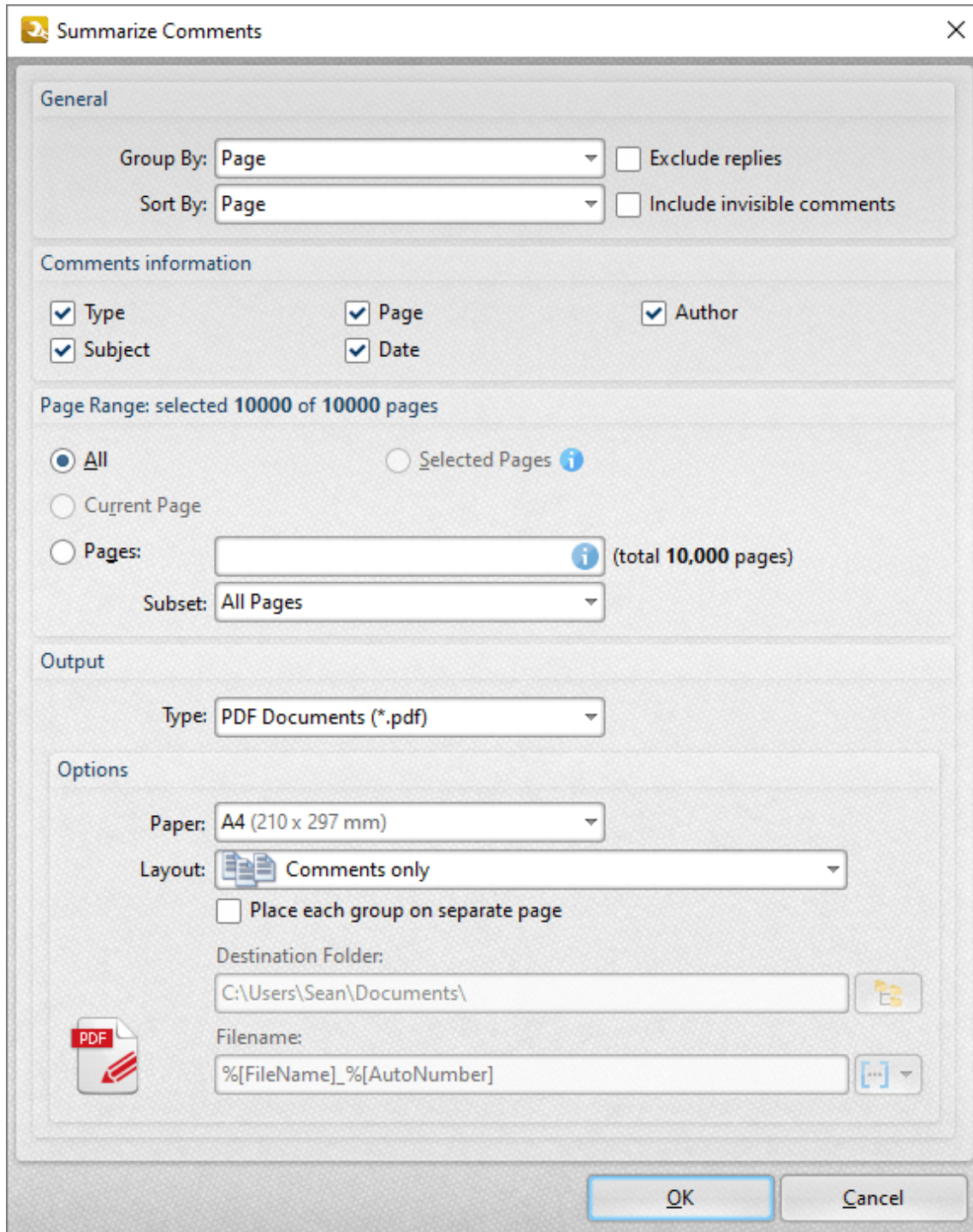

Figure 2. Summarize Comments Dialog Box

- Use the **Group by** and **Sort By** dropdown menus to determine how comments are grouped and summarized:
  - Select **Page** to group/sort comments by page.
  - Select **Type** to group/sort comments by type.
  - Select **Author** to group/sort comments by author.

- Select **Date** to group/sort comments by date.
- Select **Subject** to group/sort comments by subject.
- Select **Visual Order** to sort comments by their visual order.
- Select the **Exclude replies** box to exclude replies to comments from the summary.
- Select the **Include invisible comments** box to include invisible comments in the summary.
- Use the **Page Range** settings to determine the page range from which the comment summary comes:
  - Select **All** to include all pages.
  - The **Current Page** and **Selected Page** options are not currently available. They will be added in a future build.
  - Use the **Pages** box to specify a custom page range. Further information on the specification of page ranges is available [here](#).<sup>[552]</sup>
  - Use the **Subset** option to specify a subset of custom page ranges.
- Use the **Output** dropdown menu to determine the format of the summary.
- Use the **Options** dropdown boxes to determine customizable options for the selected output format.
- Use the **Destination Folder** text box to determine the destination folder for the summary, or click the icon to select a folder on the local computer.
- Use the **Filename** text box to determine the name of the summary. Click the macro dropdown menu to add [macros](#)<sup>[488]</sup> as desired.

Click **OK** to save changes.

---

## 7.11 Protection Actions







---



### Protection Actions

---

The **Protection** actions add/remove digital signatures, certified signature fields, timestamps and passwords to input documents, as well as sanitize/redact their content:

-  [Add Digital Signature](#)<sup>[272]</sup> uses a certificate-based digital ID to add and sign signature fields in input documents.
  -  [Add Timestamp](#)<sup>[276]</sup> adds document-level time stamps to input documents.
  -  [Certify Document](#)<sup>[279]</sup> adds certified signature fields to input documents.
  -  [Clear Digital Signatures](#)<sup>[283]</sup> removes digital signatures from input documents.
  -  [Find and Redact](#)<sup>[284]</sup> searches for specific words or patterns (phone numbers, credit card numbers, social security numbers, emails or dates) in documents and then either marks them for redaction or redacts them immediately.
  -  [Sanitize Document](#)<sup>[287]</sup> removes sensitive information from input documents.
  -  [Secure Document](#)<sup>[289]</sup> adds password security to input documents.
-

## 7.11.1 Add Digital Signature



The **Add Digital Signature** action uses a certificate-based digital ID to add and sign signature fields in input documents. It contains the following customizable parameters:

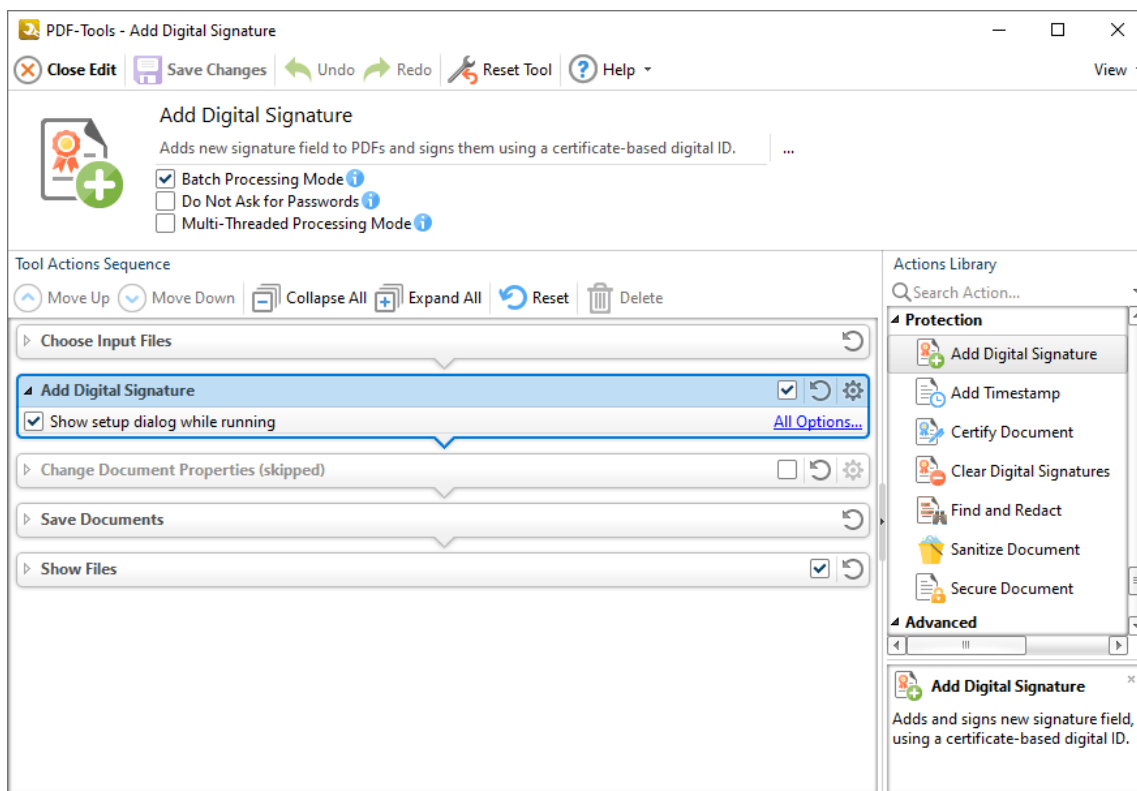

**Figure 1.** Add Digital Signature Action Options

- Click **All Options** to view/edit all options. The **Sign Document** dialog box will open, as detailed below.
- Select the **Show setup dialog while running** box to launch the **Sign Document** dialog box and customize settings each time this action is used. Clear this box to disable the **Sign Document** dialog box from opening each time the action is used, which is useful when the same settings are used consistently.



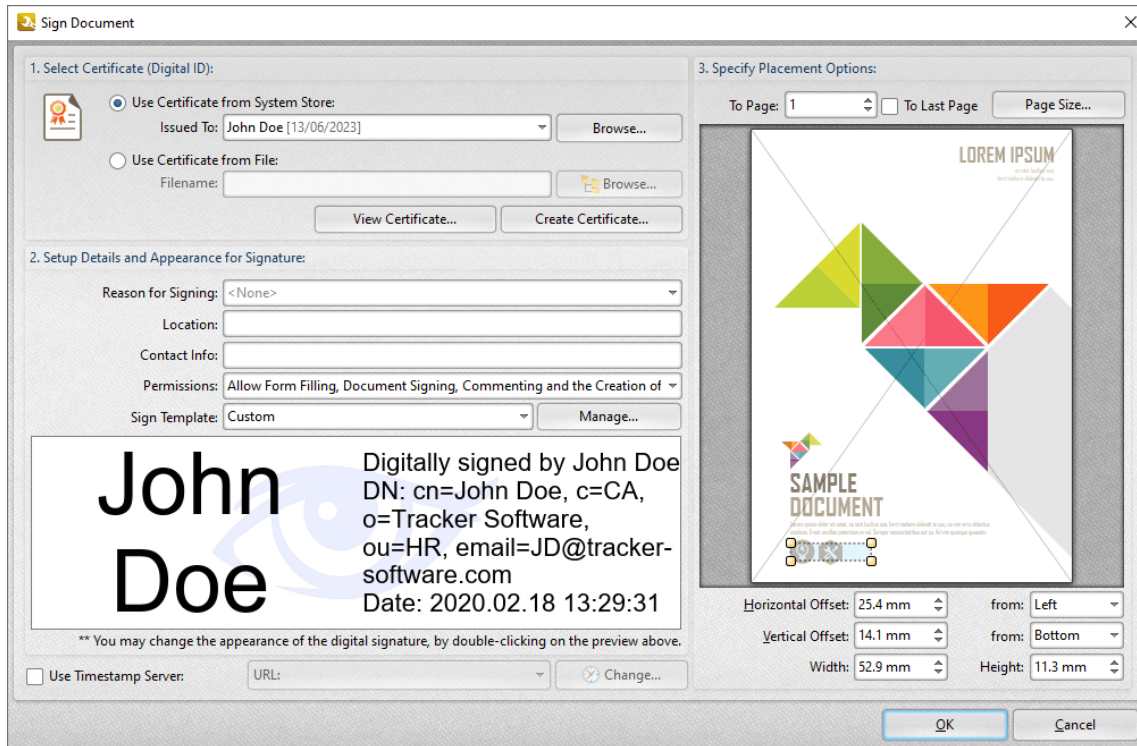

Figure 2. Sign Document Dialog Box

- Select a certificate from the system store or the local computer.
- Click **View Certificate** to view details about the selected certificate.
- Click **Create Certificate** to create a new certificate. The dialog box displayed in (**figure 3**) will open.
- Click the **Reason for Signing** menu, or enter text into the box manually, to add a reason for signing the document.
- Click the **Location** box to enter a location as desired.
- Click the **Contact Info** box to add contact information to the signature.
- Click the **Permissions** box to determine the changes that are permitted after the document has been signed.
- Click the **Sign Template** menu to select layout options for the signature and associated information.
- Click **Manage** to further customize the **Sign Template**.
- Select the **Use Timestamp Server** box to select a timestamp server to add to the signature, then select a timestamp server from the dropdown menu. Click **Change** to view/edit the details of the timestamp server used.
- Use the **Placement Options** to determine the location at which the digital signature is added to input documents:
  - Enter the page number in the **To Page** number box, or select the **To Last Page** box to add the digital signature to the last page.
  - Click and drag the bounding box in the preview pane to position the signature field manually and/or resize its dimensions.

- Alternatively, use the number boxes to determine the location and dimensions of the digital signature.
- Click the **Page Size** button to set the page size/orientation of the page in the preview pane.

Click **OK** to save changes.

## Creating Digital Certificates

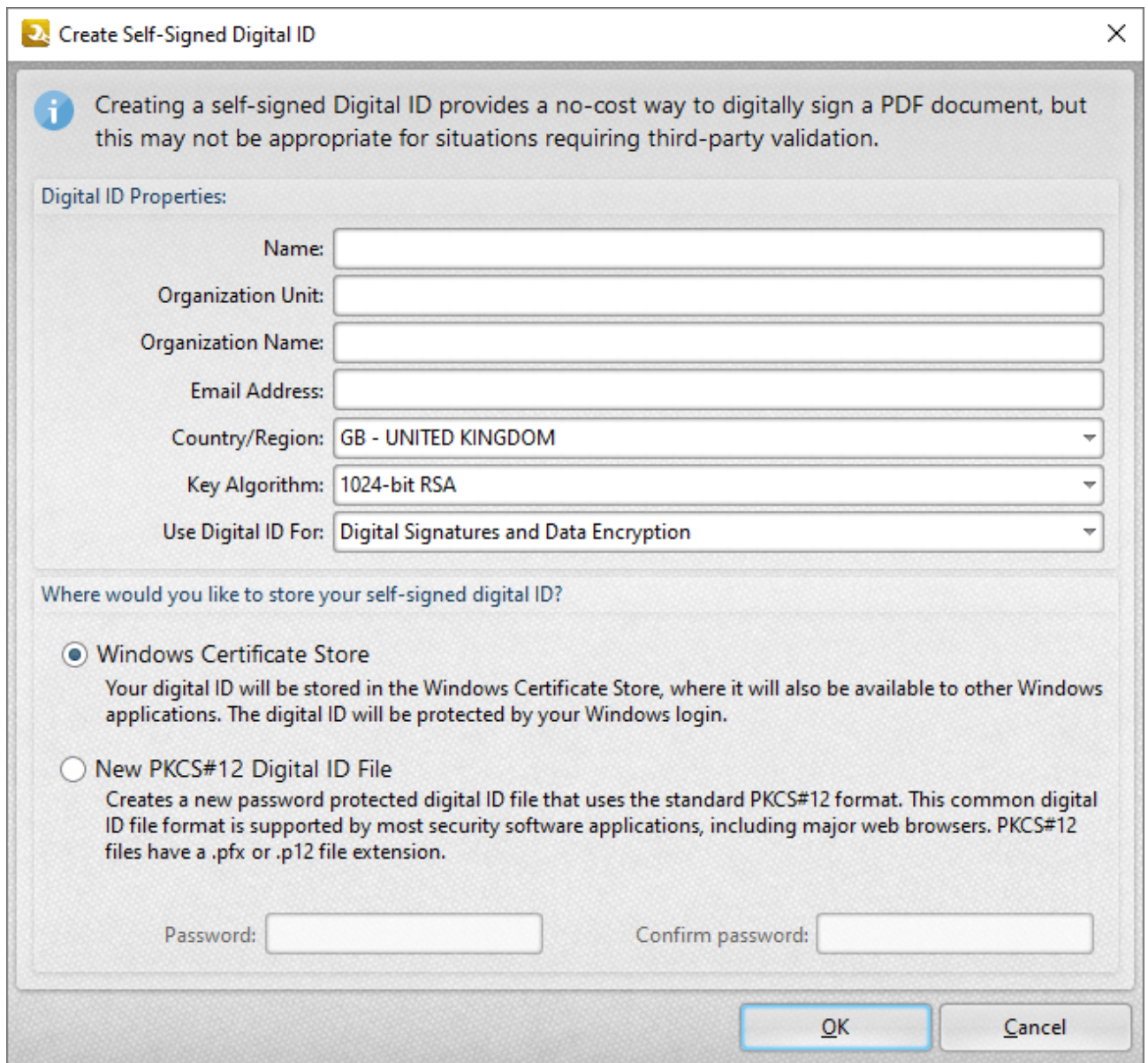

**Figure 3.** Create Self-Signed Digital ID Dialog Box

- Enter the desired user information in **Name**, **Organization** and **Email** text boxes.

- Use the **Country/Region** dropdown menu to enter the nationality of the owner of the digital certificate.
- Select either **1024-bit RSA** or **2048-bit RSA** as the key algorithm. **1024-bit RSA** is more universally compatible than **2048-bit RSA**, but **2048-bit RSA** offers more security.
- Select a storage location for the digital certificate. If the **PKCS#12** option is used then enter and confirm a password in the **Password** text boxes.

Click **OK** to create the digital certificate. It will then be available in the **Use Certificate from System Store** dropdown menu detailed in *(figure 2)*.

---

## 7.11.2 Add Timestamp



The **Add Timestamp** action adds document-level timestamps to input documents. It contains the following customizable parameters:

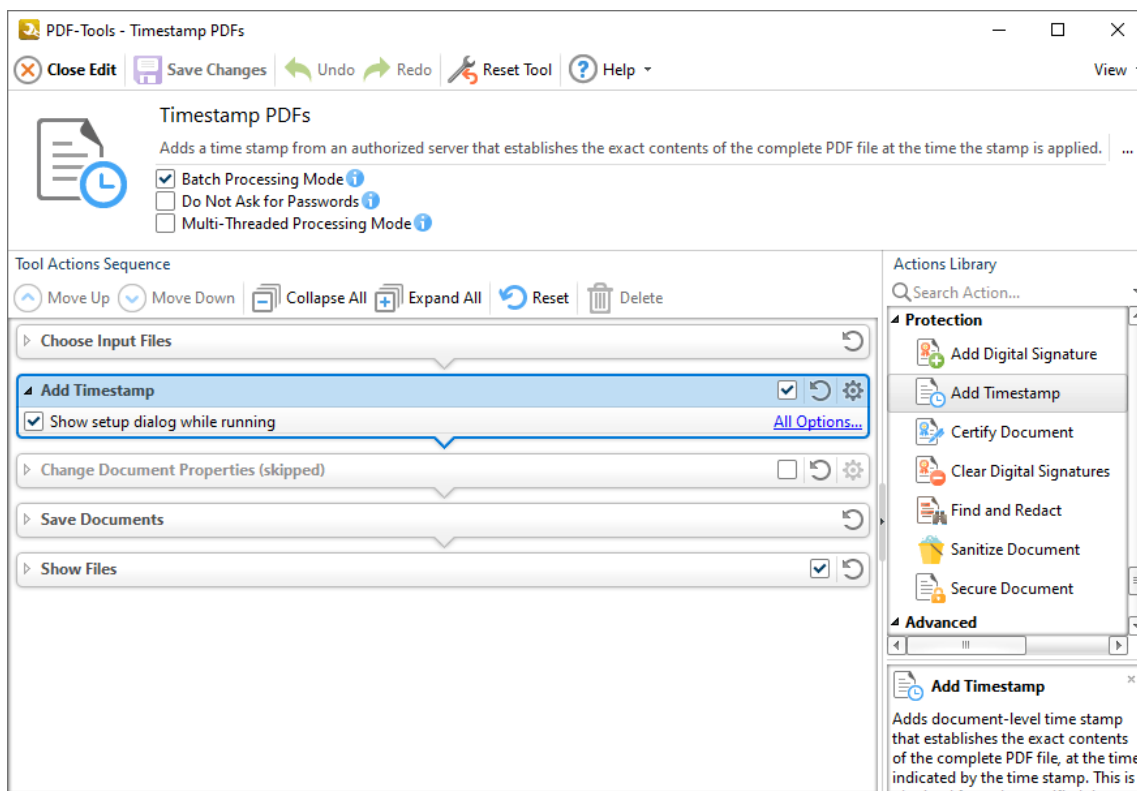

**Figure 1.** Add Timestamp Action Options

- Click **All Options** to view/edit all options. The **Timestamp Server** dialog box will open, as detailed below.
- Select the **Show setup dialog while running** box to launch the **Timestamp Server** dialog box and customize settings each time this action is used. Clear this box to disable the **Timestamp Server** dialog box from opening each time the action is used, which is useful when the same settings are used consistently.

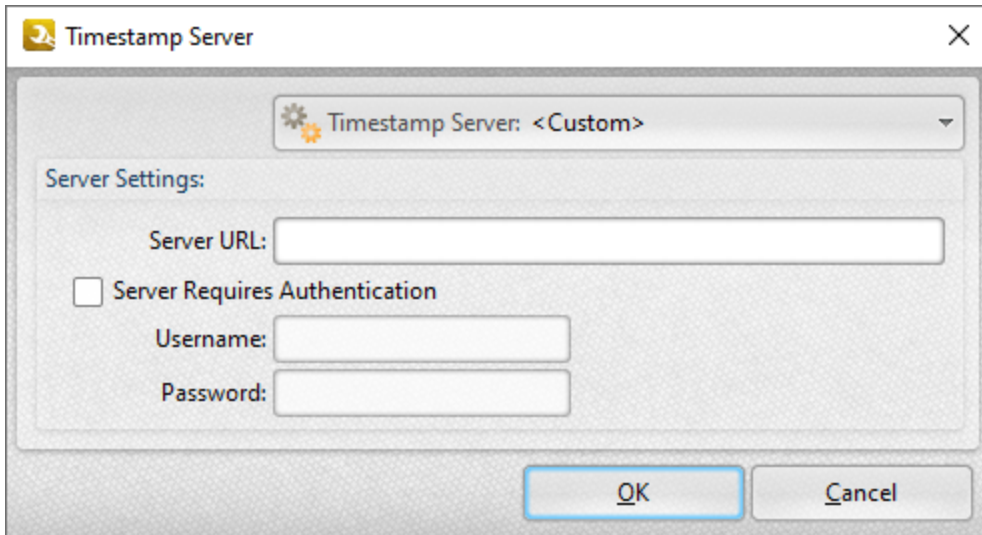

Figure 2. Timestamp Server Dialog Box

- Use the **Timestamp Server** dropdown menu to select a timestamp server.
- If a timestamp server is being used for the first time then enter the website address in the **Server URL** text box.
- If the selected timestamp server requires authentication then select the indicated box and enter the **User Name** and **Password** in the associated text boxes.
- Click **Timestamp Server** dropdown menu to save/delete/manage customized settings, as detailed below.

Click **OK** to save settings.

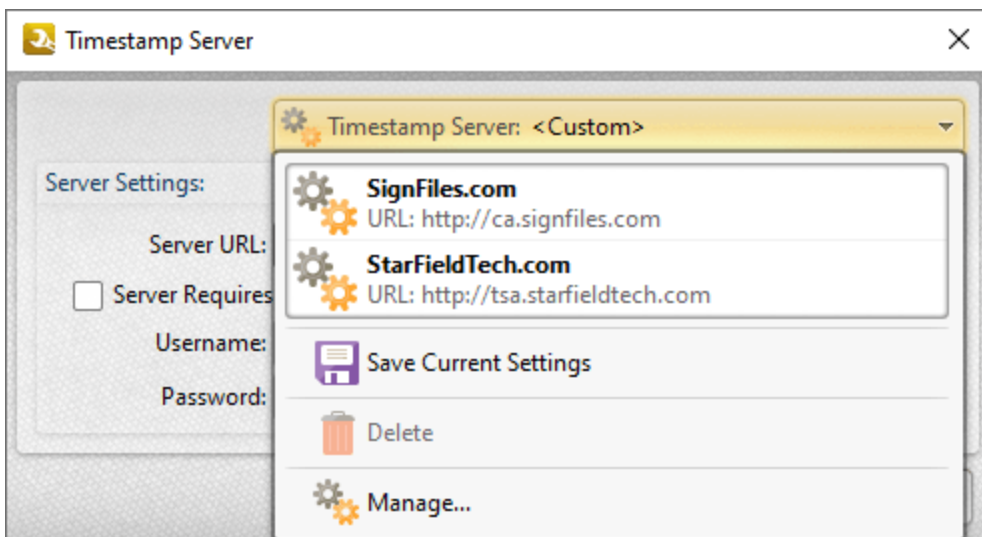





Figure 3. Timestamp Server Dropdown Menu

- Click  **Save** to save the current settings to a profile for subsequent use.
- Click  **Delete** to delete the current profile.

- Click  **Manage** to manage saved profiles. The **Manage Presets** dialog box will open:

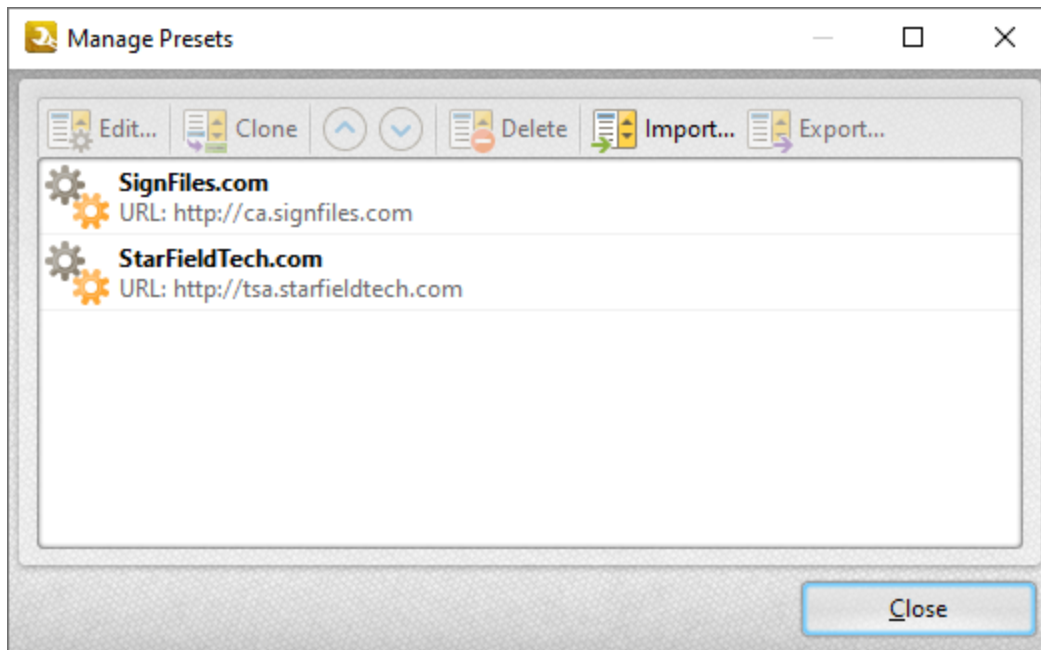

Figure 4. Manage Presets Dialog Box

- Click **Edit** to edit selected profiles.
  - Click **Clone** to clone selected profiles.
  - Use the up and down arrows to move selected profiles up or down in the list.
  - Click **Delete** to delete selected profiles.
  - Click **Import** to import profiles from a saved file.
  - Click **Export** to export profiles to file.
-

## 7.11.3 Certify Document



The **Certify Document** action adds certified signature fields to input documents. It contains the following customizable parameters:

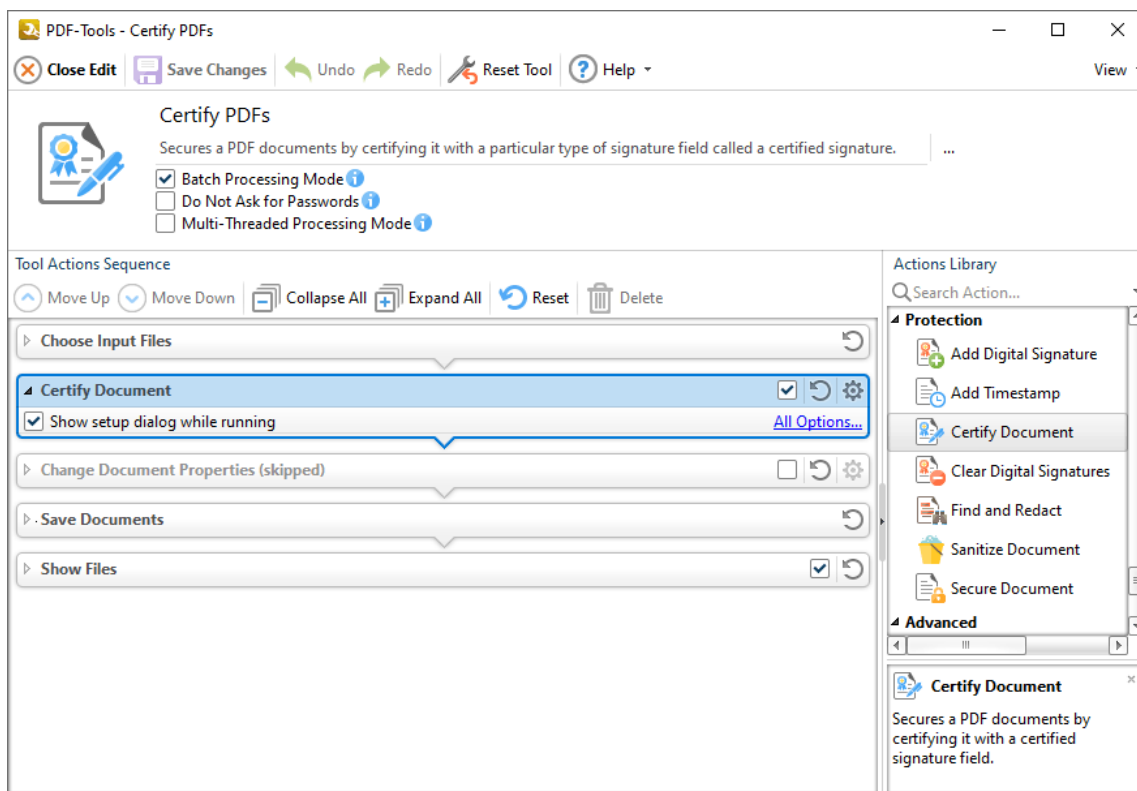

**Figure 1.** Certify Document Action Options

- Click **All Options** to view/edit all options. The **Timestamp Server** dialog box will open, as detailed below.
- Select the **Show setup dialog while running** box to launch the **Timestamp Server** dialog box and customize settings each time this action is used. Clear this box to disable the **Timestamp Server** dialog box from opening each time the action is used, which is useful when the same settings are used consistently.

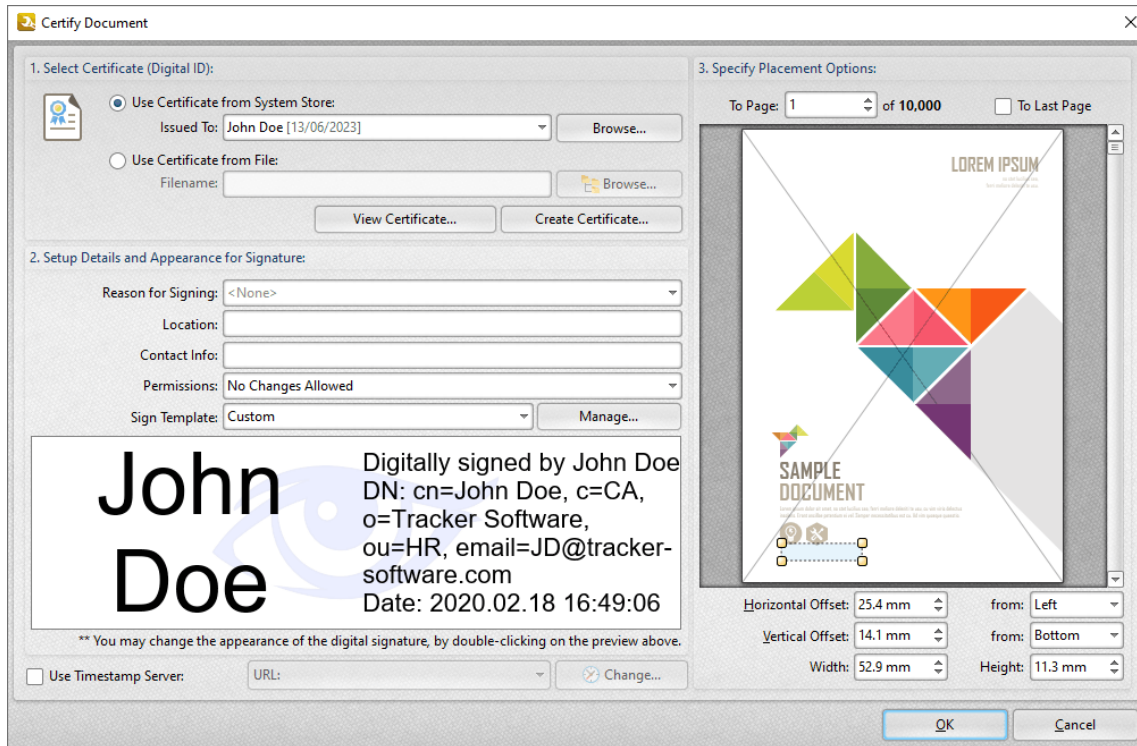

Figure 2. Certify Document Dialog Box

- Select a certificate from the system store or the local computer.
- Click **View Certificate** to view details about the selected certificate.
- Click **Create Certificate** to create a new certificate. The dialog box displayed in (figure 3) will open.
- Click the **Reason for Signing** menu, or enter text into the box manually, to add a reason for signing the document.
- Click the **Location** box to enter a location as desired.
- Click the **Contact Info** box to add contact information to the signature.
- Click the **Permissions** box to determine the changes that are permitted after the document has been signed.
- Click the **Sign Template** menu to select layout options for the signature and associated information.
- Click **Manage** to further customize the **Sign Template**.
- Select the **Use Timestamp Server** box to select a timestamp server to add to the signature, then select a timestamp server from the dropdown menu. Click **Change** to view/edit the details of the timestamp server used.
- Use the **Placement Options** to determine the location at which the digital signature is added to input documents:
  - Enter the page number in the **To Page** number box, or select the **To Last Page** box to add the digital signature to the last page.
  - Click and drag the bounding box in the preview pane to position the signature field manually and/or resize its dimensions.



- Alternatively, use the number boxes to determine the location and dimensions of the digital signature.

Note that it is only possible to certify documents a single time, whereas it is possible to digitally sign documents multiple times. The [Add Digital Signature](#)<sup>272</sup> action is used to digitally sign documents.

Click **OK** to save changes.

### Creating Digital Certificates

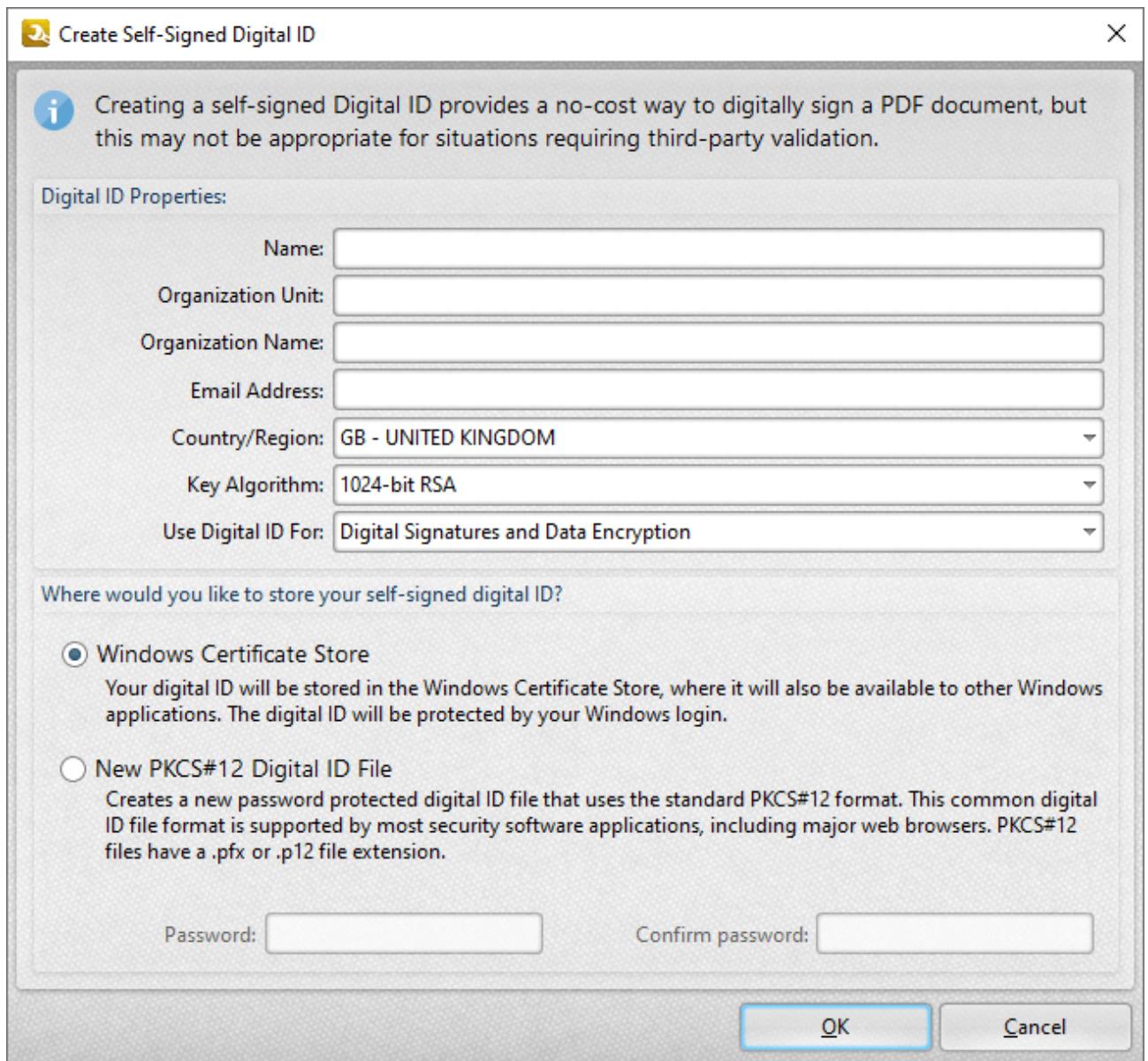

Figure 3. Create Self-Signed Digital ID Dialog Box

- Enter the desired user information in **Name**, **Organization** and **Email** text boxes.

- Use the **Country/Region** dropdown menu to enter the nationality of the owner of the digital certificate.
- Select either **1024-bit RSA** or **2048-bit RSA** as the key algorithm. **1024-bit RSA** is more universally compatible than **2048-bit RSA**, but **2048-bit RSA** offers more security.
- Select a storage location for the digital certificate. If the **PKCS#12** option is used then enter and confirm a password in the **Password** text boxes.

Click **OK** to create the digital certificate. It will then be available in the **Use Certificate from System Store** dropdown menu detailed in *(figure 2)*.

---

## 7.11.4 Clear Digital Signatures



The **Clear Digital Signatures** action clears digital signature fields in documents:

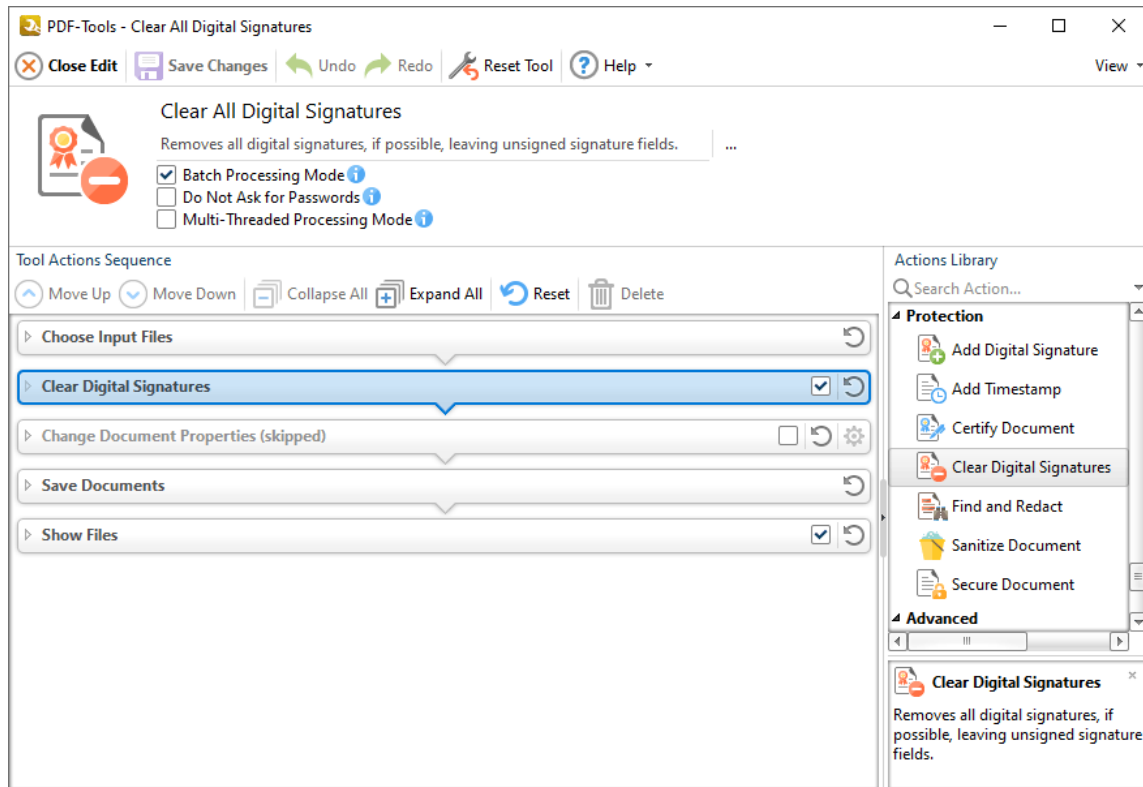

**Figure 1.** Clear Digital Signatures Action Options

Select/clear the check box to enable/disable this action, then click  **Save Changes** to save changes.

## 7.11.5 Find and Redact



### Find and Redact

The **Find and Redact** action searches for specific words or patterns (phone numbers, credit card numbers, social security numbers, emails or dates) in documents and then either marks them for redaction or redacts them immediately. It contains the following customizable parameters:

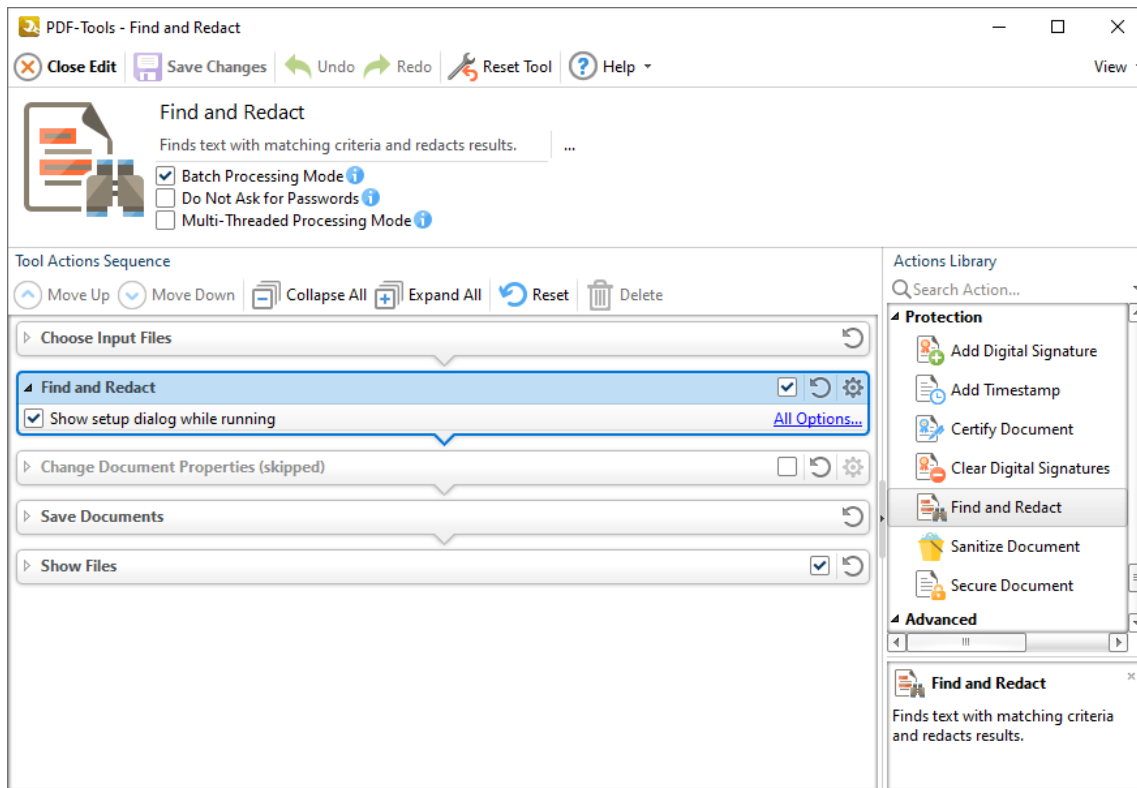

Figure 1. Find and Redact Action Options

- Click **All Options** to view/edit all options. The **Find and Redact Text** dialog box will open, as detailed below.
- Select the **Show setup dialog while running** box to launch the **Find and Redact Text** dialog box and customize settings each time this action is used. Clear this box to disable the **Find and Redact Text** dialog box from opening each time the action is used, which is useful when the same settings are used consistently.

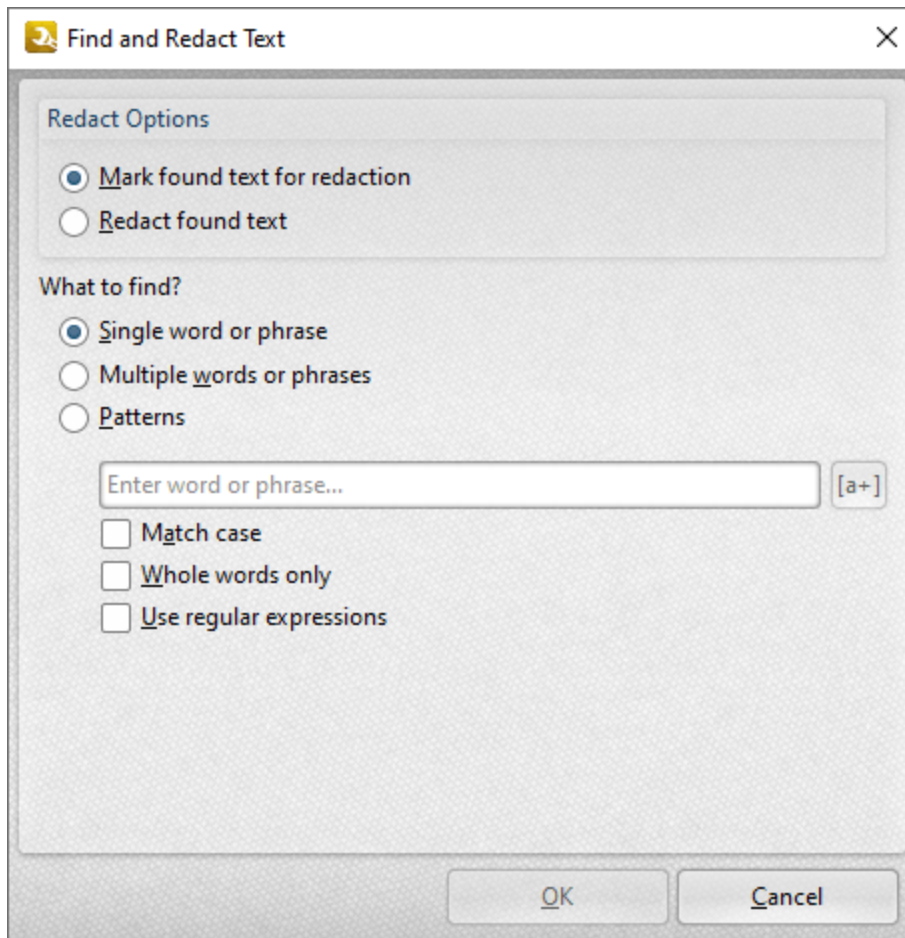

Figure 2. Find and Redact Text Dialog Box

- Select **Mark found text for redaction** to mark search results for redaction.
- Select **Redact found text** to immediately redact search results.
- Select an option in the upper dropdown menu to determine the format of what you want to locate in the document:
  - Select **Single word or phrase** to search for a single word/phrase, then enter the desired word/phrase in the text box.
  - Select **Multiple words or phrases** to search for multiple words/phrases. Click **Add/Remove** to add/remove words/phrases, then enter the desired words/phrases in the text box. Click **Save** to save the current word list to a plain text file. Click **Load** to load a plain text file of words into the text box.
  - Select **Patterns** to search for specific patterns, then select either **Phone numbers, Credit Card Numbers, Social Security Numbers, Emails** or **Dates** in the lower dropdown menu to determine the patterns that you want to find.
    - Select an option in the **Choose pattern locale** dropdown menu to determine the language used in the search.

Click **OK** to find and mark/redact content.



## 7.11.6 Sanitize Document



### Sanitize Document

The **Sanitize Document** action removes sensitive information from input documents:

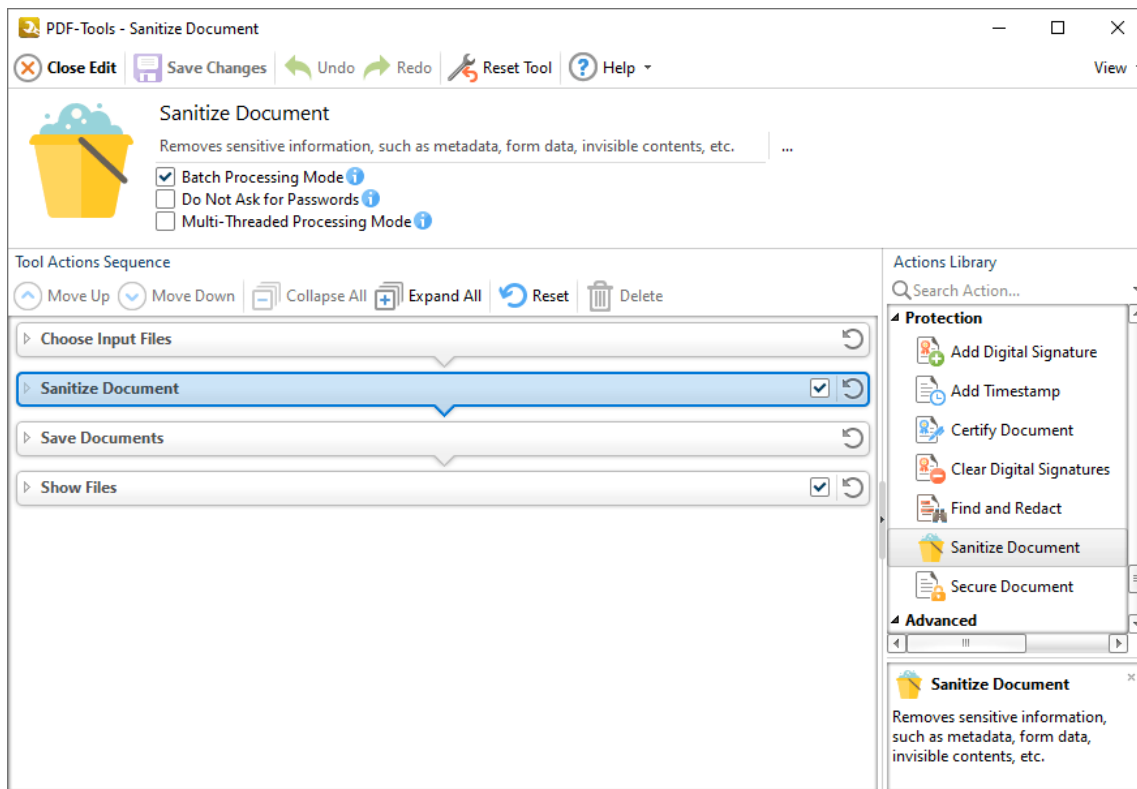

Figure 1. Sanitize Document Action Options

The following hidden data is removed from documents when this action is used:

- Metadata.
- Invisible text and images.
- Overlapping objects.
- Form and comment data.
- Embedded content and files.
- Hidden layers.
- Hidden data and comments.
- Unreferenced data.

Select/clear the check box to enable/disable this action, then click  **Save Changes** to save changes.





## 7.11.7 Secure Document



The **Secure Document** action adds password security to input documents. It contains the following customizable parameters:

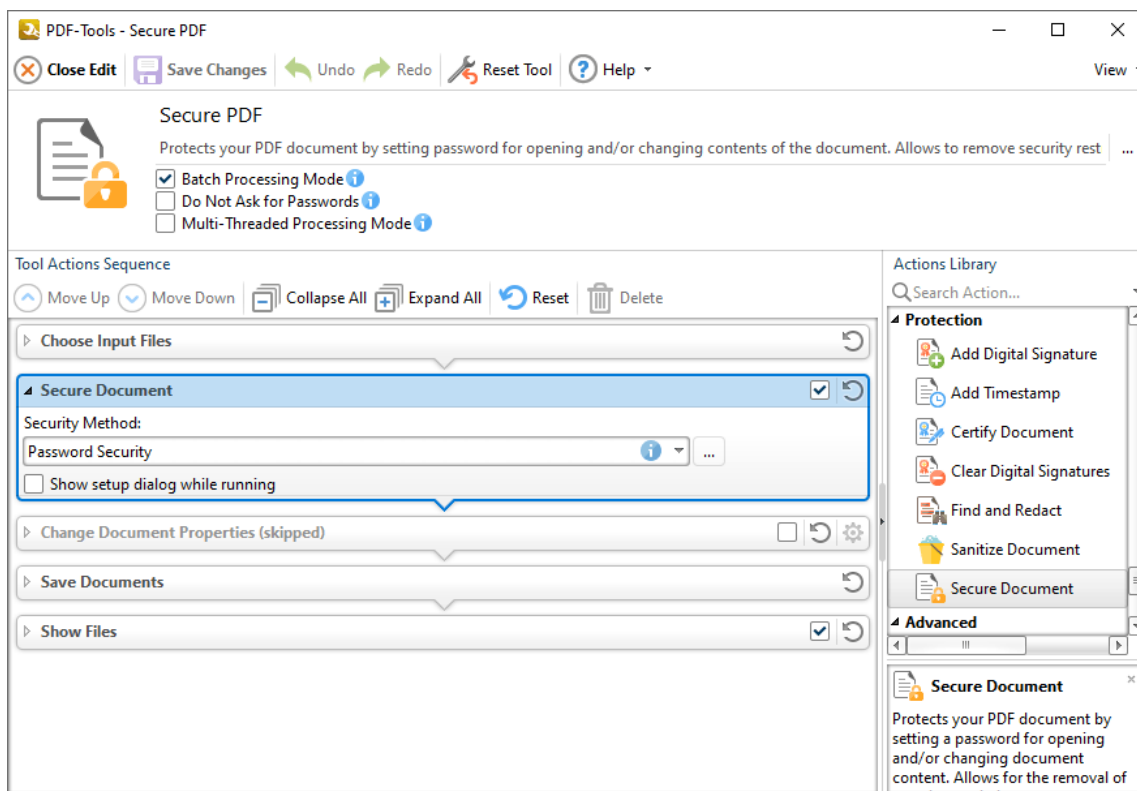
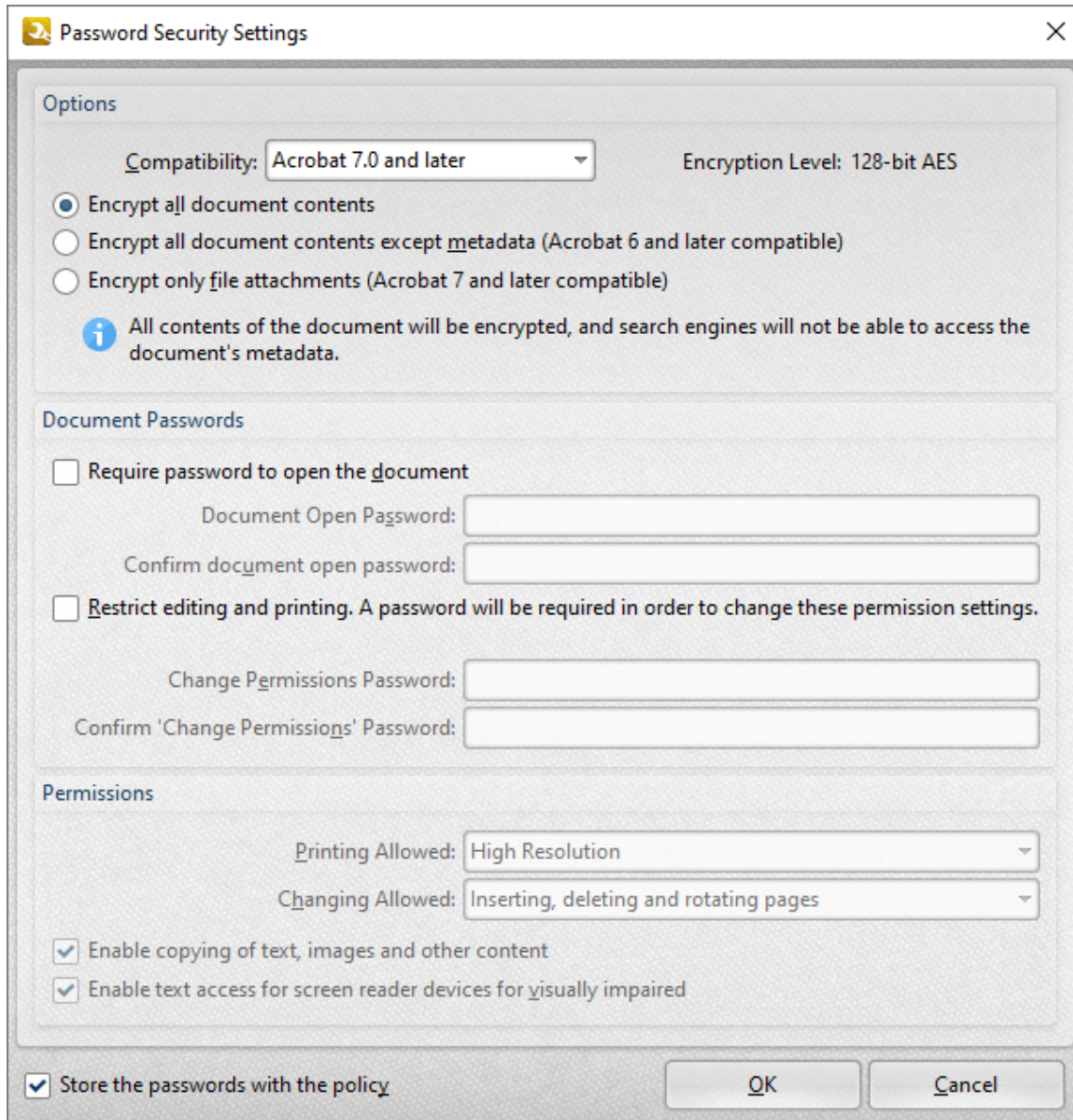

Figure 1. Secure Document Action Options

- Select **Password Security** in the dropdown menu to set a password for input documents. The **Password Security Settings** dialog box will open, as detailed below.
- Select the **Show setup dialog while running** box to launch the **Password Security Settings** dialog box and customize settings each time this action is used. Clear this box to disable the **Password Security Settings** dialog box from opening each time the action is used, which is useful when the same settings are used consistently.



- Use the **Compatibility** menu to select the document security compatibility.
- Select an encryption option button to determine which elements of documents are encrypted.
- Select the **Require password to open the document** box to set a password for opening the document. Enter the password in the **Document Open Password** text box and confirm it in the text box below.
- Select the **Restrict editing and printing of the document** box to set a password for editing and printing the document. Enter the password in the **Change Permissions Password** text box and confirm it in the text box below. Use the dropdown menus and check boxes in the **Permissions** section to select the settings that these passwords will enable.

Click **OK** to save changes.



## 7.12 Advanced Actions







---



### Advanced Actions

---

The **Advanced** actions change document properties or print documents:

-  [Change Document Properties](#) <sup>[293]</sup> edits the properties of input documents.
  -  [Convert Colors](#) <sup>[299]</sup> converts the colors of input documents.
  -  [Filter Documents](#) <sup>[304]</sup> sets criteria for the automatic selection of documents to be processed by subsequent actions in the same tool.
  -  [Filter Files](#) <sup>[306]</sup> sets criteria for the automatic selection of files to be processed by subsequent actions in the same tool.
  -  [Filter Pages](#) <sup>[308]</sup> sets criteria for the automatic selection of pages to be processed by subsequent actions in the same tool.
  -  [Print Document](#) <sup>[310]</sup> prints input documents.
-

## 7.12.1 Change Document Properties



### Change Document Properties

The **Change Document Properties** action is used to edit document properties. It contains the following customizable parameters:

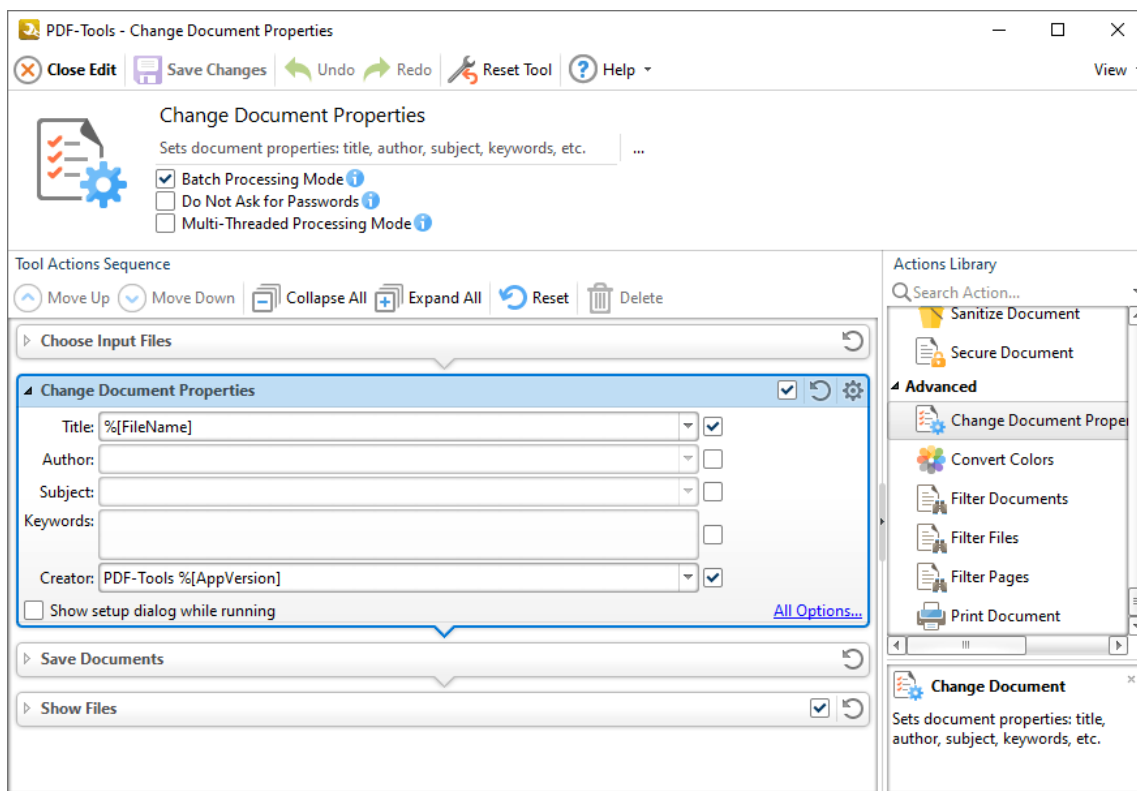

**Figure 1.** Change Document Properties Action Options

- Use the text boxes to create/edit the **Title, Author, Subject, Keywords** and **Creator** properties of the document.
- Click the dropdown arrows to add [macros](#).
- Click **All Options** to view/edit all options. The **Document Properties** dialog box will open, as detailed below.
- Select the **Show setup dialog while running** box to launch the **Document Properties** dialog box and customize settings each time this action is used. Clear this box to disable the **Document Properties** dialog box from opening each time the action is used, which is useful when the same settings are used consistently.

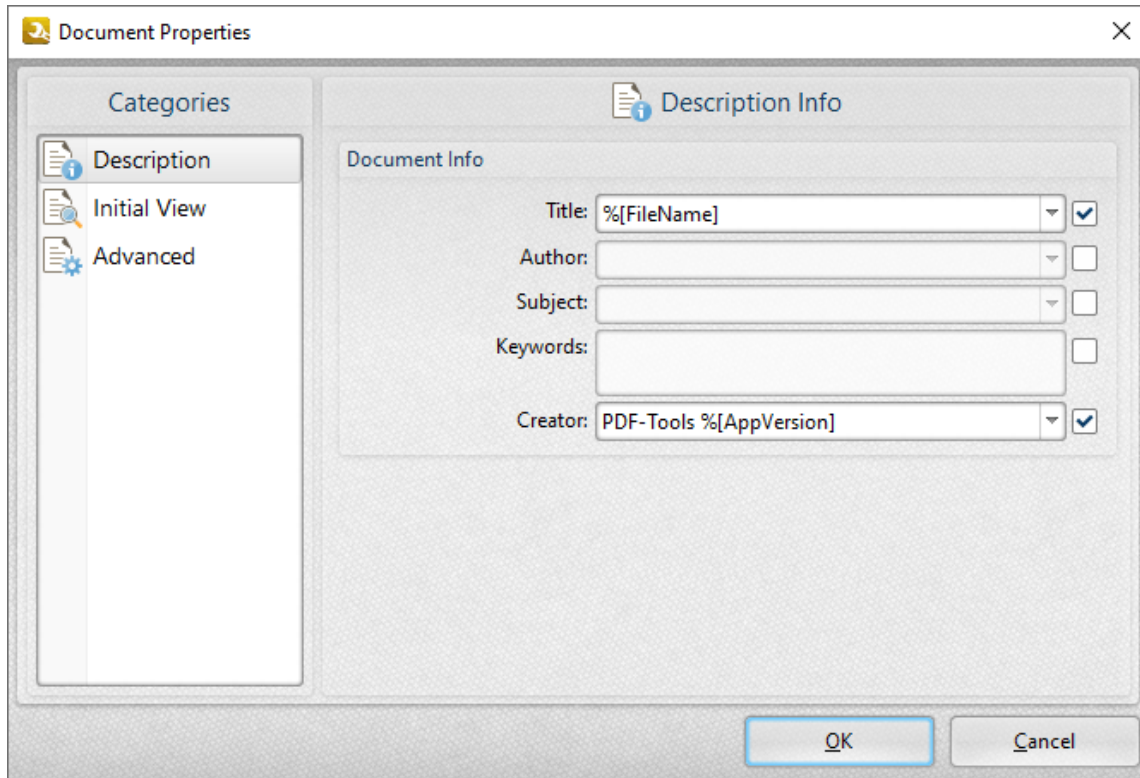

Figure 2. Document Properties Dialog Box, Description Category

Select options in the **Categories** pane to view/edit document properties. The **Description** document properties determine the metadata of input documents. These properties are detailed in **(figure 1)**.

**Initial View**

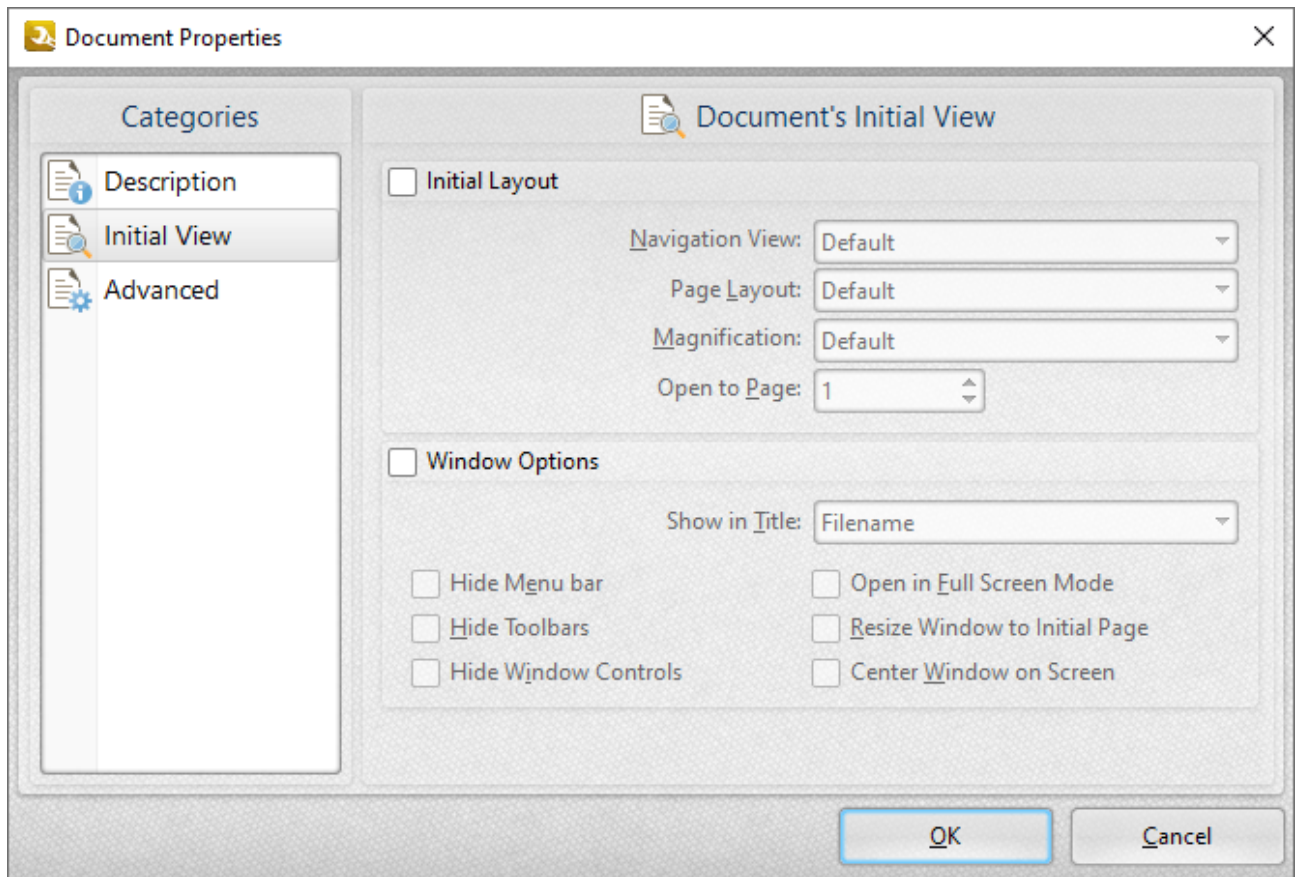

Figure 3. Document Properties Dialog Box, Initial View Category

The **Initial View** document properties determine the initial view of input documents.

The **Layout and Magnification** options are as follows:

- The **Navigation View** menu determines the panes that are visible when documents are opened:
  - Select **Default** to retain the default settings of the application used to open documents.
  - Select **Page Only** to view only the document itself.
  - Select **Bookmarks pane and page** to view the document and the bookmarks pane.
  - Select **Thumbnails pane and page** to view the document and the thumbnails pane.
  - Select **Layers pane and page** to view the document and the layers pane.
  - Select **Attachments pane and page** to view the document and the attachments pane.
- The **Page Layout** menu determines the page layout when documents are opened:
  - Select **Default** to retain the default settings of the application used to open documents.
  - Select **Single Page** to view a single page at a time.
  - Select **Continuous** to view pages in a single, scrolling column.
  - Select **Two Pages Continuous** to view two pages at a time in scrolling columns.
  - Select **Two Pages Continuous, with Cover Page** to view as above, but with a cover page included.

- Select **Two Pages** to view two pages at a time.
- Select **Two Pages with Cover Page** to view as above, but with a cover page included.
- The **Magnification** menu determines the level of zoom when documents are opened:
  - Select **Default** to retain the default settings of the application used to open documents.
  - Select **Actual Size** to view pages at their actual size. The resulting display will include resolution settings.
  - Select **Fit Page** to view the full extent of page content regardless of its size.
  - Select **Fit Width** to fit pages according to their width.
  - Select **Fit Height** to fit pages according to their height.
  - Select **Fit Visible** to view the entire page within the confines of the viewing area.
  - Alternatively, select an option from the list of numerical percentages to determine the magnification level.
- Use the **Open to Page** dropdown menu to determine the page at which documents open.

The **Window Options** are as follows:

- Use the **Show in Title** dropdown menu to determine the name displayed in the document tab when documents are opened.
- Select the **Hide Menu bar** box to hide the menu bar in the application used to open the document.
- Select the **Hide Toolbars** box to hide toolbars in the application used to open the document.
- Select the **Hide Window Controls** box to window controls in the application used to open the document.
- Select the **Open in Full Screen Mode** box to open documents in full screen mode.
- Select the **Resize Window to Initial Page** box to resize the viewing window according to the dimensions of the first page of the document.
- Select the **Center Window on Screen** box to center the viewing window on the monitor screen.

## Advanced



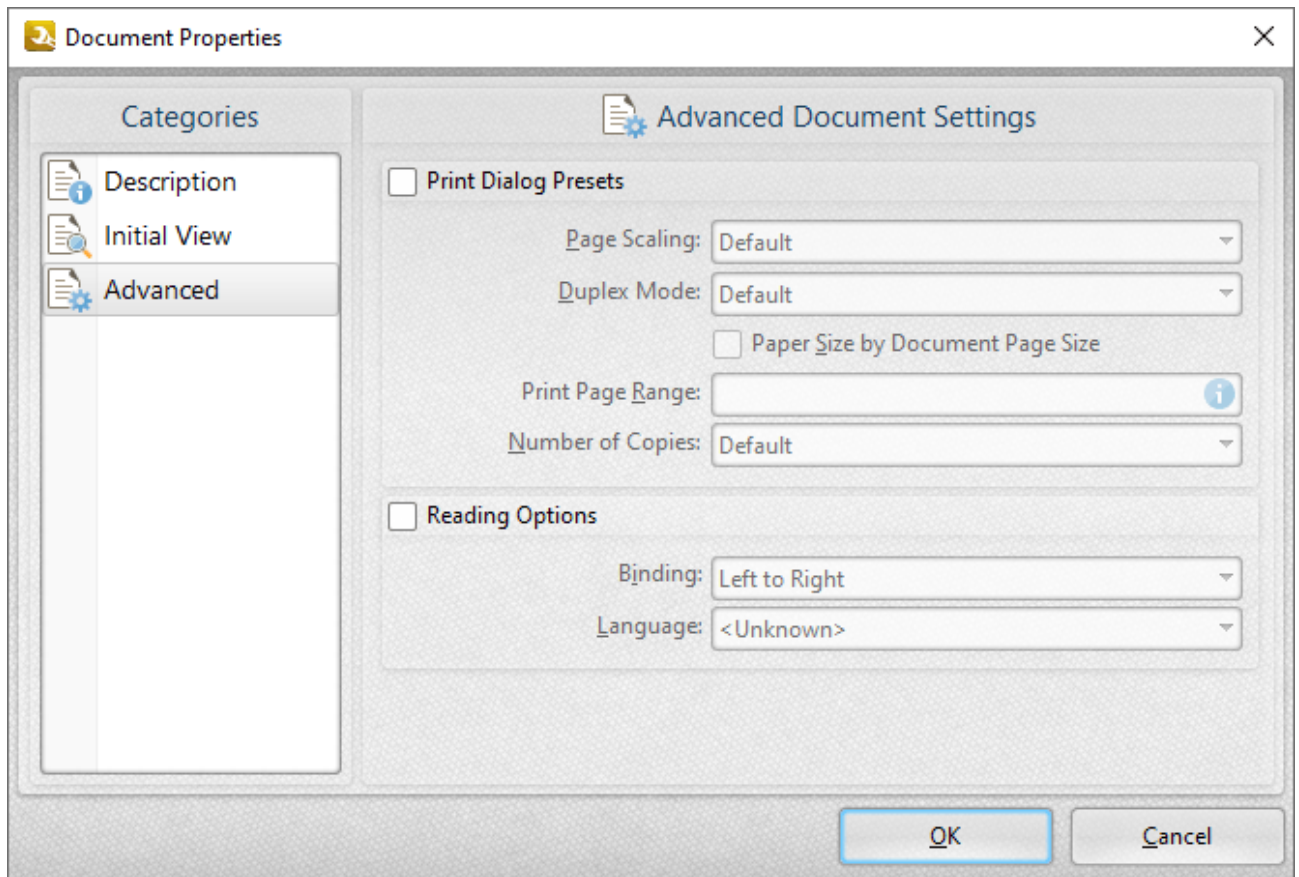

Figure 4. Document Properties Dialog Box, Advanced Category

The **Advanced** document properties determine printing/reading options:

- Select the **Print Dialog Presets** box to override the viewing application's default print settings with those specified within the file itself:
  - Select an option in the **Page Scaling** dropdown menu to determine the page scaling used:
    - **Default** retains the default settings.
    - **None** disables page scaling.
  - Select an option in the **Duplex Mode** dropdown menu to determine the default duplex mode for printing.
  - Select the **Paper Size by document Page Size** box to use the size of the document pages to determine the paper size of the document.
  - Enter the pages to be printed in the **Print Page Range** text box. Further information on the specification of page ranges is available [here](#).<sup>[552]</sup>
  - Use the **Number of Copies** dropdown menu to determine how many copies of the document are printed.
- Select the **Reading Options** box to enable binding and language options:
  - Select either **Left to Right** or **Right to Left** as the document **Binding** option.

- Select an option in the **Language** dropdown menu to determine the language of the document.

Click **OK** to save settings.

---

## 7.12.2 Convert Colors



The **Convert Colors** action is used to convert the colors of documents. It contains the following customizable parameters:

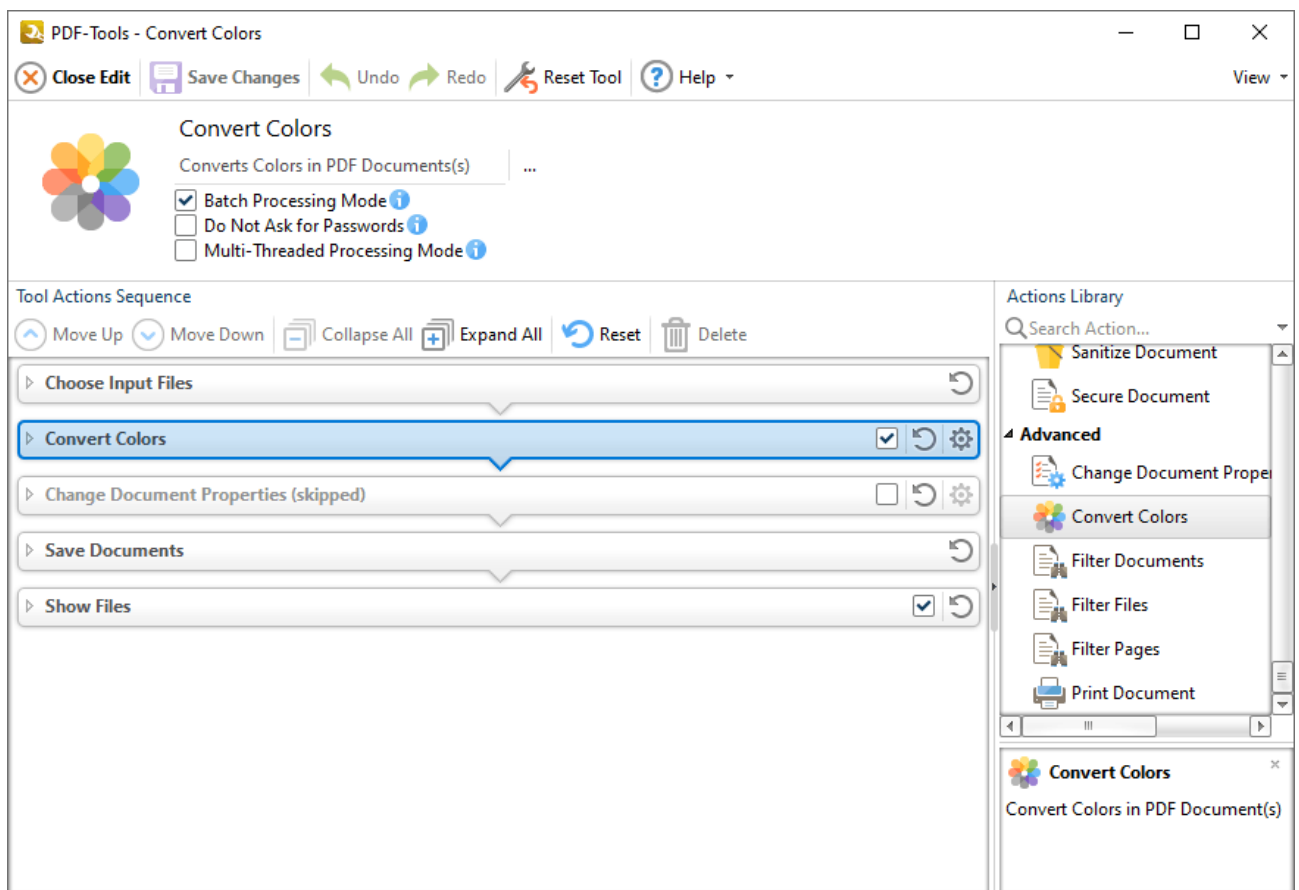

**Figure 1.** Convert Colors Action Options

- Click **All Options** to view/edit all options. The **Convert Colors** dialog box will open, as detailed below.
- Select the **Show setup dialog while running** box to launch the **Convert Colors** dialog box and customize settings each time this action is used. Clear this box to disable the **Convert Colors** dialog box from opening each time the action is used, which is useful when the same settings are used consistently.

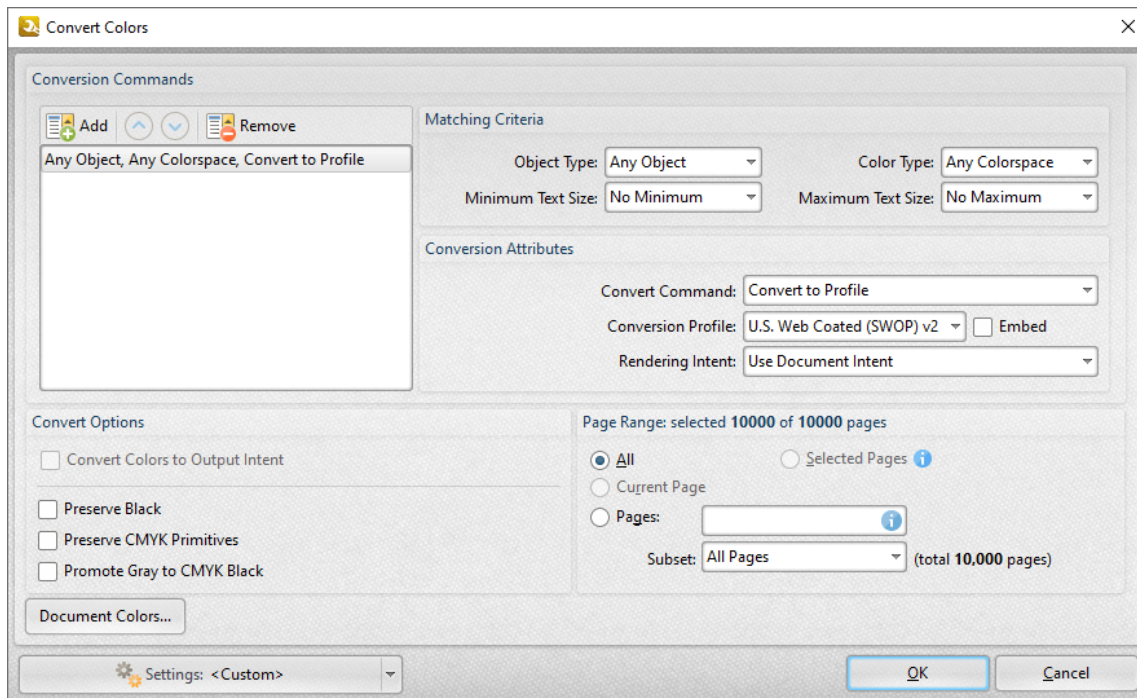

Figure 2. Convert Colors Dialog Box

- The default settings profile for color conversion are available in the pane on the left. If you want to create customized settings for color conversion, then click **Add** and customize the settings as detailed below:
  - Use the **Matching Criteria** section to determine the document content that you want to convert:
    - Use the **Object Type** dropdown menu to specify the type of objects that you want to convert.
    - Use the **Color Type** dropdown menu to specify the color space you want to convert.
    - Use the **Minimum/Maximum Text Size** dropdown menus to specify the minimum/maximum size of text that you want to convert.
  - Use the **Conversion Attributes** to determine how the colors of objects in the document that meet the **Matching Criteria** are converted:
    - Use the **Convert Command** dropdown menu to determine the conversion operation performed:
      - **Preserve** preserves objects from conversion.
      - **Convert to Profile** converts objects to the destination color space using the profile selected in the **Conversion Profile** dropdown menu.
      - **Decalibrate** removes embedded profiles from objects.
    - Use the **Conversion Profile** dropdown menu to determine the profile to which objects are converted. Select the **Embed** box to tag objects with the selected **ICC** profile to calibrate color, which is useful when PDFs are shared between users on different devices.

- Use the **Rendering Intent** dropdown menu to determine the rendering intent used during color conversion.
- Use the **Convert Options** to determine additional options:
  - Select the **Convert Colors to Output Intent** box to convert document colors to the **Output Intent** specified in the **Rendering Intent** dropdown menu. Note that documents must contain the output intent profile in order for their colors to be converted.
  - Select the **Preserve Black** box to preserve black objects in **CMYK, RGB** or **Grayscale** content of converted documents, for example to prevent **RGB** text from converting into rich black **CMYK** when conversion is performed.
  - Select the **Preserve CMYK Primitives** to preserve colors that contain only one colorant.
  - Select the **Promote Gray to CMYK Black** to convert device gray to CMYK black with only a black component.
- Use the **Page Range** options to determine the page range on which color conversion takes place in input documents. Further information on the specification of page ranges is available [here](#).<sup>552</sup>
- Click **Document Colors** to view a breakdown of colors in the current document and determine which colors are converted, as detailed in **(figure 4)** below.
- Click the **Settings** dropdown arrow to save/manage/delete custom settings:
  - Click **Save Current Settings** to save the current settings as a profile for subsequent use.
  - Click **Delete** to delete selected profiles. Note that this option is only available for customized profiles.
  - Click **Manage** to manage preset/customized profiles. The **Manage Presets** dialog box will open:

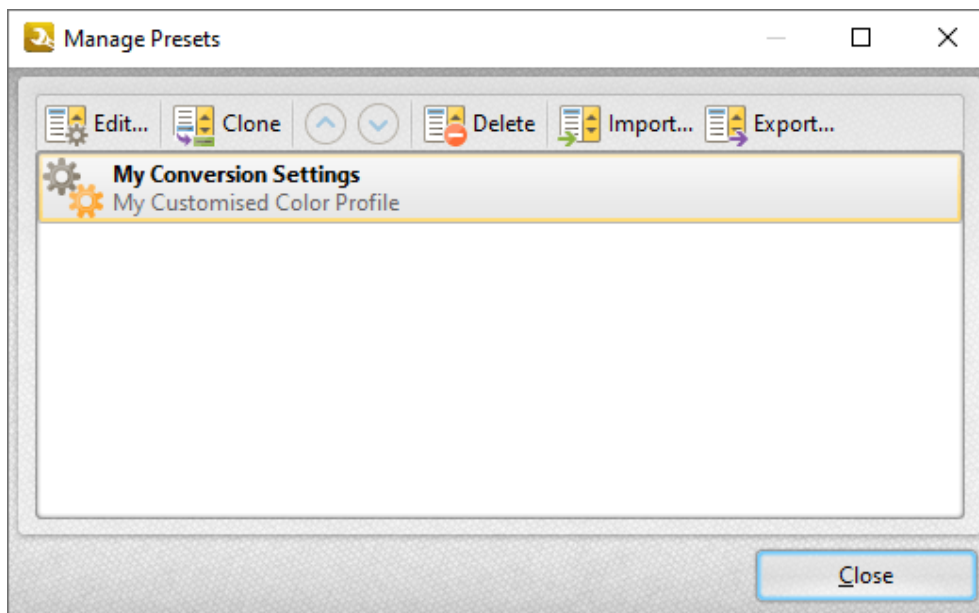

Figure 3. Manage Presets Dialog Box

- Click **Edit** to edit selected profiles. Note that this option is only available for customized profiles.
- Click **Clone** to clone selected profiles. This option can be used to customize the settings of preset profiles, which cannot be customized in the default state.
- Use the up and down arrows to move selected profiles up or down in the list.
- Click **Delete** to delete selected profiles. Note that this option is only available for customized profiles.
- Click **Import** to import profiles from a saved file.
- Click **Export** to export profiles to file.

## Document Colors

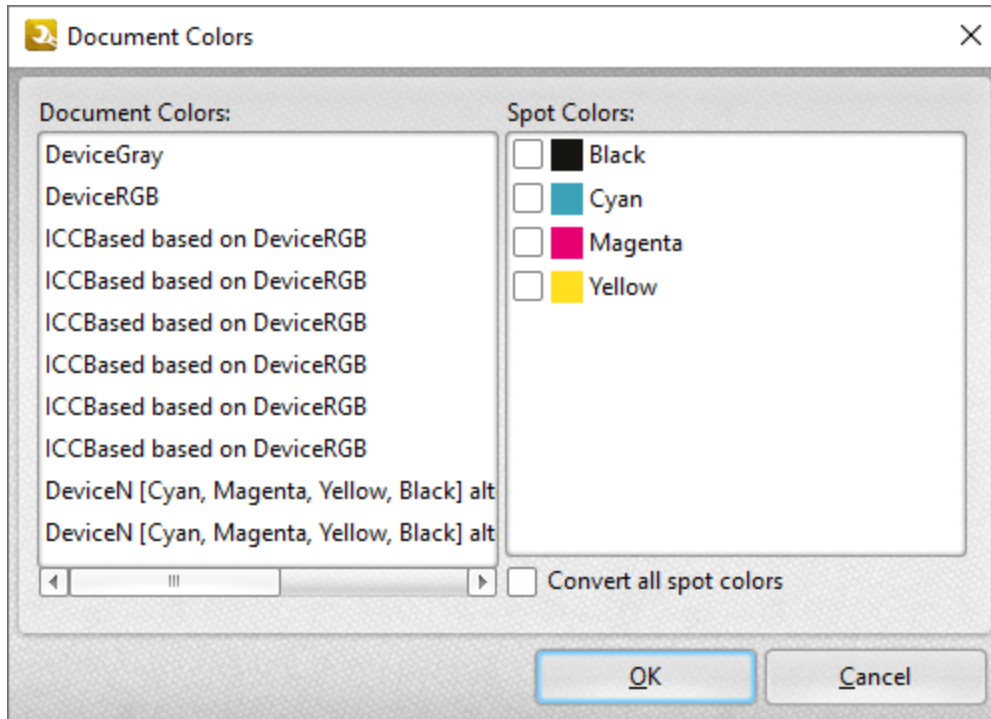

Figure 4. Document Colors Dialog Box

All colors contained in the document are detailed in this dialog box. Select the boxes of spot colors to include them in the conversion, or select the **Convert all spot colors** box to convert all spot colors.

## 7.12.3 Filter Documents



### Filter Documents

The **Filter Documents** action is used to set criteria for the automatic selection of documents to be processed by subsequent actions in the same tool. It contains the following customizable parameters:

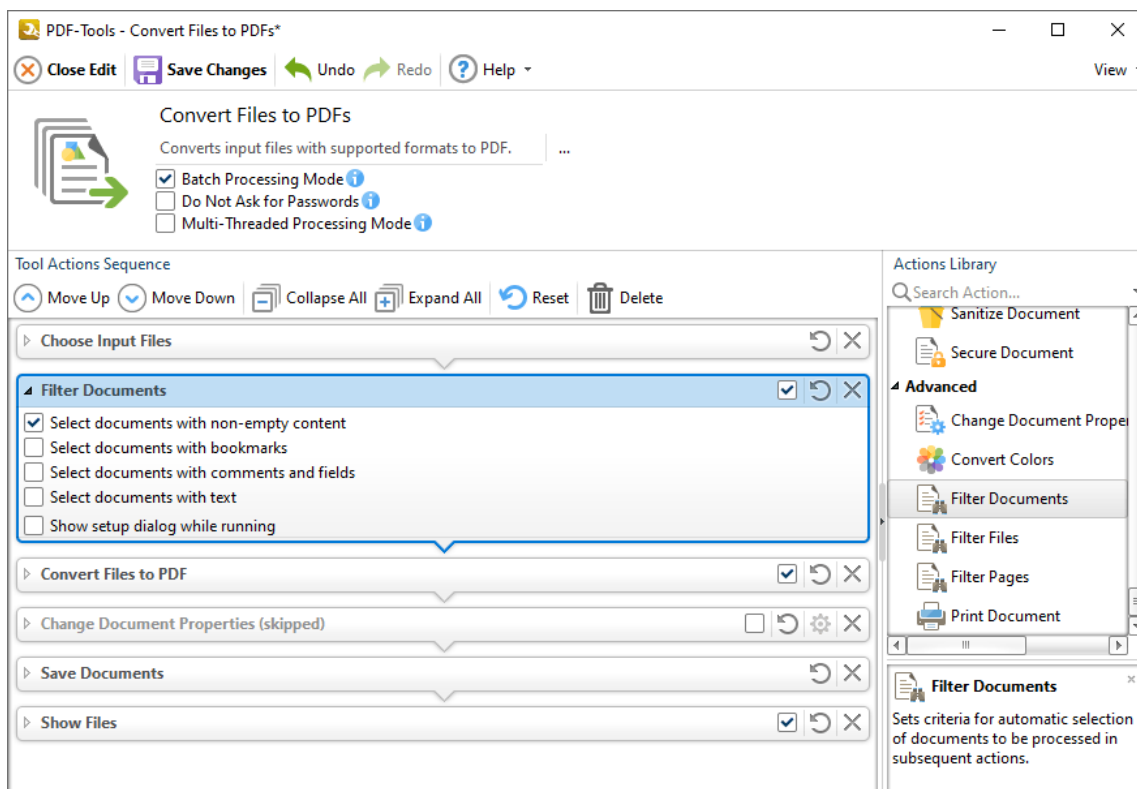

**Figure 1.** Filter Documents Action Options

Use the check boxes to determine which documents are selected:

- Select the **Select documents with non-empty content** box to select only documents that contain content. If this box is not selected then documents that do not contain content will be included when the tool runs.
- Select the **Select documents with bookmarks** box to select documents that contain bookmarks.
- Select the **Select documents with comments and fields** to select documents that contain comments and form fields. When this box is selected, additional check



boxes will appear in the dialog box. Use these check boxes to specify the types of comments and form fields that you want to include.

- Select the **Select documents with text** box to select documents that contain text. When this box is selected, additional check boxes will appear in the dialog box. Use these boxes to specify the criteria through which text-based documents are selected to be included when the tool runs:
    - Select **Any Text** to include documents that contain any text.
    - Select **By custom criteria** to set custom criteria to be used to determine which documents are included when the tool runs, then use the text and check boxes to set the criteria.
  - Select the **Show setup dialog while running** box to launch the **Filter Documents** dialog box and customize settings each time this action is used. Clear this box to disable the **Filter Documents** dialog box from opening each time the action is used, which is useful when the same settings are used consistently.
-

## 7.12.4 Filter Files



### Filter Files

The **Filter Files** action is used to set criteria for the automatic selection of files to be processed by subsequent actions in the same tool. It contains the following customizable parameters:

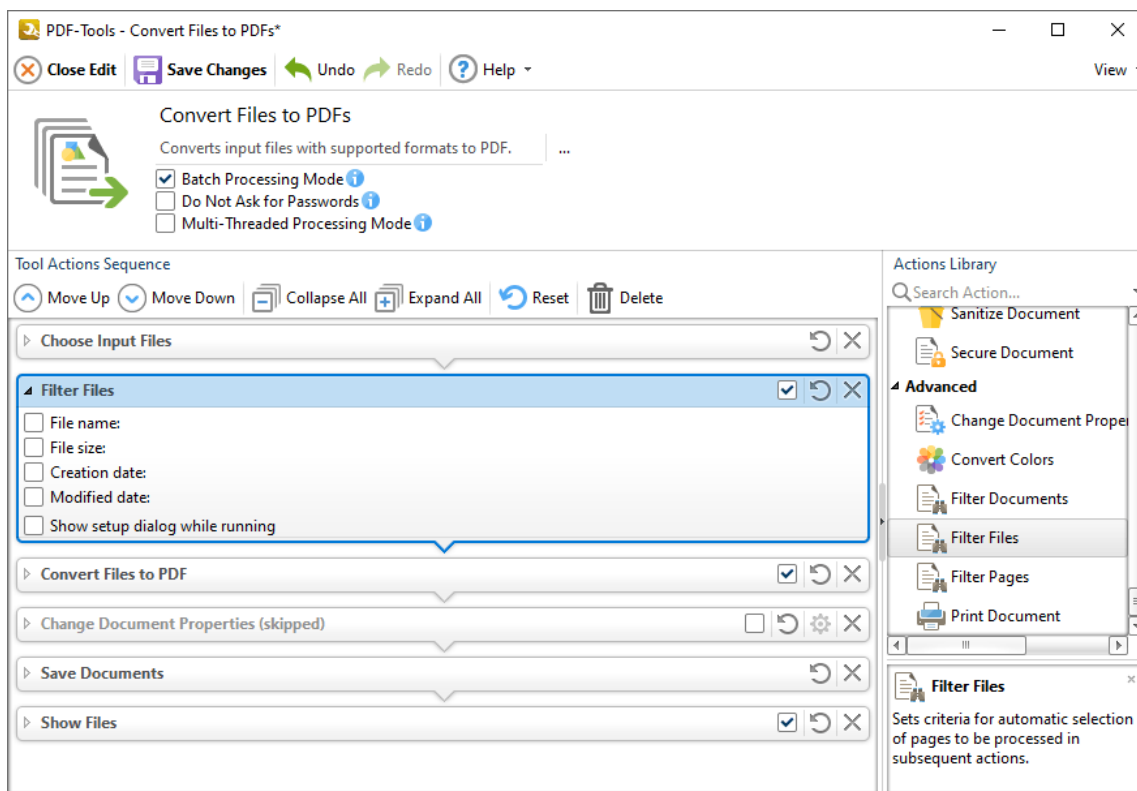

**Figure 1.** Filter Files Action Options

Use the check boxes to determine which documents are selected:

- Select the **File Name** box to filter files according to their file name, then enter the desired name of the file in the text box.
- Select the **File Size** box to filter files according to their size, then use the dropdown menus to specify the desired minimum/maximum/exact size for files.
- Select the **Creation date** box to filter files according to their creation date, then use the dropdown menus and boxes to specify the desired creation date.

- Select the **Modified date** box to filter files according to their modification date, then use the dropdown menus and boxes to specify the desired modification date.
  - Select the **Show setup dialog box while running** box to launch the **Filter Files** dialog box and customize settings each time this action is used. Clear this box to disable the **Filter Files** dialog box from opening each time the action is used, which is useful when the same settings are used consistently.
-

## 7.12.5 Filter Pages



### Filter Pages

The **Filter Pages** action is used to set criteria for the automatic selection of file pages to be processed by subsequent actions in the same tool. It contains the following customizable parameters:

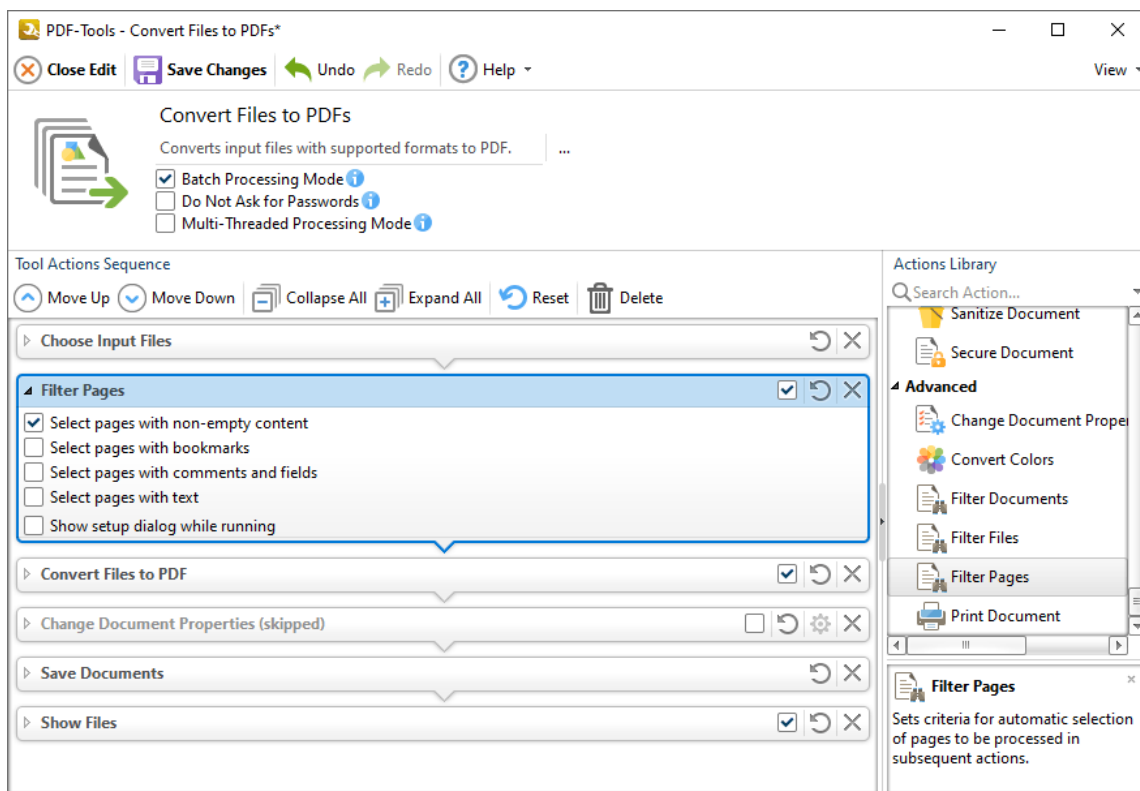

**Figure 1.** Filter Pages Action Options

Use the check boxes to determine which pages are selected:

- Select the **Select pages with non-empty content** box to select only documents that contain content. If this box is not selected then documents that do not contain content will be included when the tool runs.
- Select the **Select pages with bookmarks** box to select documents that contain bookmarks.
- Select the **Select pages with comments and fields** to select documents that contain comments and form fields. When this box is selected, additional check

boxes will appear in the dialog box. Use these check boxes to specify the types of comments and form fields that you want to include.

- Select the **Select pages with text** box to select documents that contain text. When this box is selected, additional check boxes will appear in the dialog box. Use these boxes to specify the criteria through which text-based documents are selected to be included when the tool runs:
    - Select **Any Text** to include documents that contain any text.
    - Select **By custom criteria** to set custom criteria to be used to determine which documents are included when the tool runs, then use the text and check boxes to set the criteria.
  - Select the **Show setup dialog while running** box to launch the **Filter Documents** dialog box and customize settings each time this action is used. Clear this box to disable the **Filter Documents** dialog box from opening each time the action is used, which is useful when the same settings are used consistently.
-

## 7.12.6 Print Document



### Print Document

The **Print Document** action is used to print input documents. It contains the following customizable parameters:

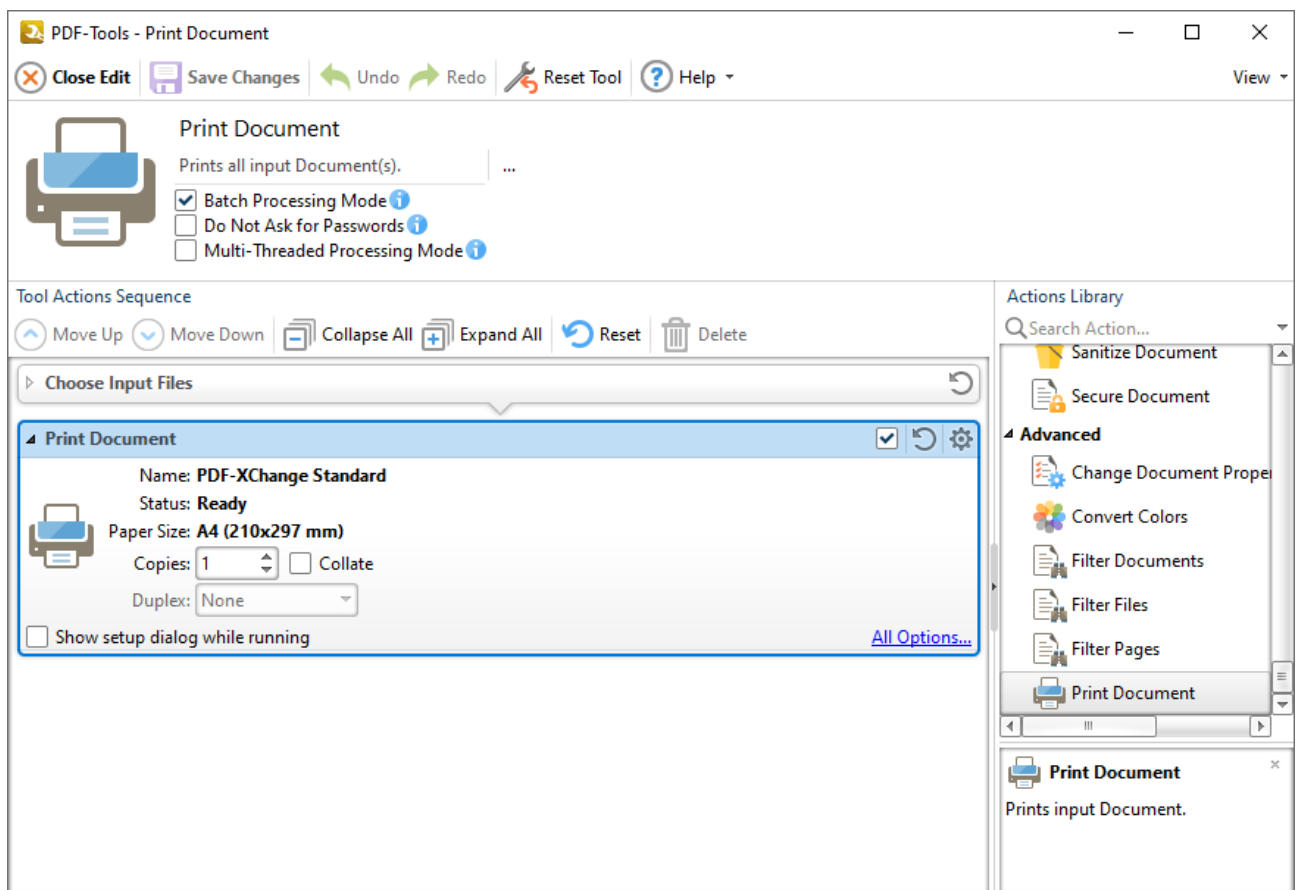

**Figure 1.** Print Document Action Options

- Details about the current printer and paper size are displayed in the upper section of the action.
- Enter the desired number of copies in the **Copies** number box and select the **Collate** box to collate output.
- Select an option in the **Duplex** dropdown menu to specify the type of duplex printing used when using this action in conjunction with printers that support duplex printing.

- Click **All Options** to view/edit all options. The **Print** dialog box will open, as detailed below.
- Select the **Show setup dialog while running** box to launch the **Print** dialog box and customize settings each time this action is used. Clear this box to disable the **Print** dialog box from opening each time the action is used, which is useful when the same settings are used consistently.

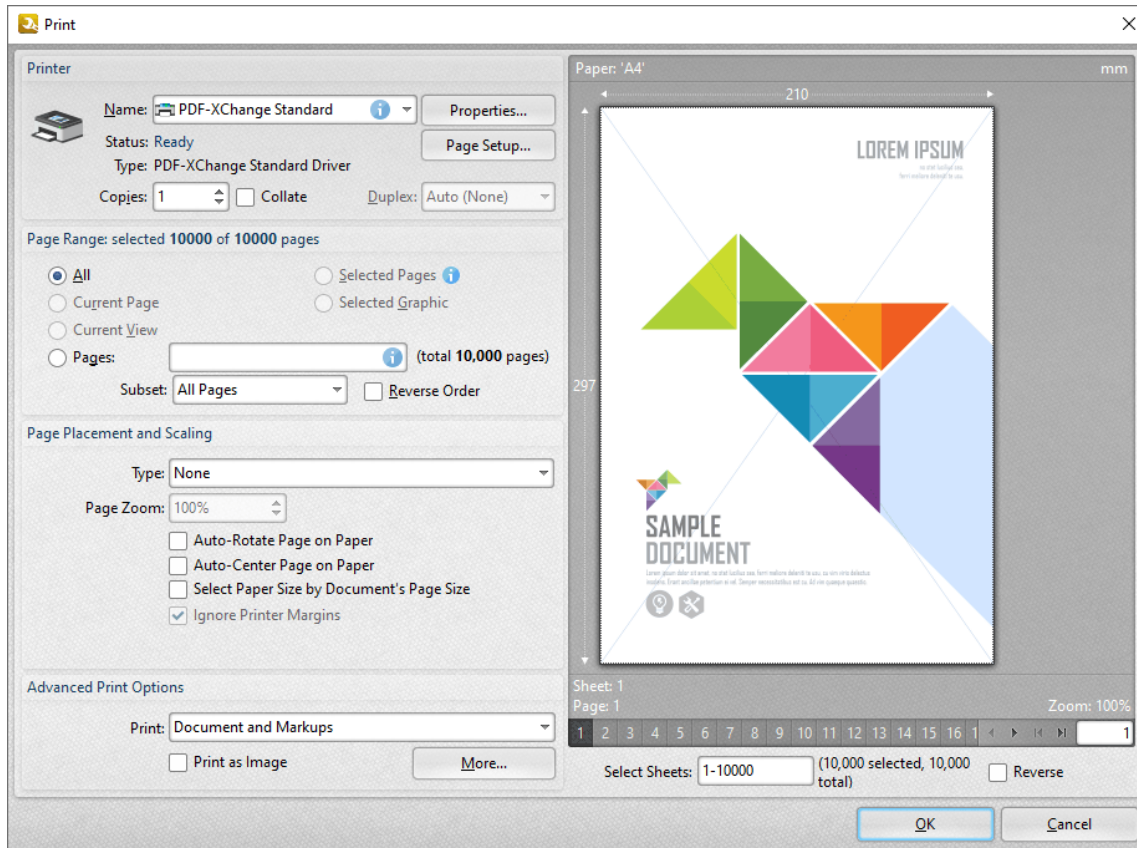

**Figure 2.** Print Dialog Box

- The options in the **Printer** section determine the printer to be used and its associated settings:
  - Use the **Name** text box to select a printer to use.
  - Use the **Copies** text box to determine how many copies of the document are printed.
  - Select the **Collate** box to collate document pages. This is a useful feature when printing multiple copies of multi-page documents. It prints entire copies of the document together, as opposed to multiple copies of each page at a time.
  - Click the **Properties** button to open the **Properties** dialog box for the selected printer.
  - Click the **Page Setup** button to open the **Page Setup** dialog box and determine page setup options, as detailed in **(figure 3)** below.
- The options in the **Page Range** section determine which pages of the document will be printed:
  - Select **All**, **Current Page** or **Current View**.

- Use the **Pages** box to determine which pages of the document are printed. See [here](#)<sup>552</sup> for further information.
- Use the **Subset** option to select **All Pages**, **Odd Pages Only** or **Even Pages Only**.
- Select the **Reverse Order** box to print documents in reverse numerical order.
- The options in the **Pages Placement and Scaling** section determine the placement and scaling of the document:
  - Use the **Type** menu to select a standard placement setting. When a setting is selected its features will be shown in the preview window. Each setting has further options that become available when the setting is selected. The effect that these have will be shown in the preview window when they are adjusted.
  - Use the **Page Zoom** number box to determine the level of zoom on the page. Select the check boxes to enable further settings.
- The options in the **Advanced Print Options** tab determine advanced printing options:
  - Use the **Print** menu to determine which elements of the document are printed. Click **More** for further options, as detailed in **(figure 4)** below.
  - Select the **Print as Image** box to print the selected pages as images.
  - When the desired parameters have been selected, click **Print** to print the document.

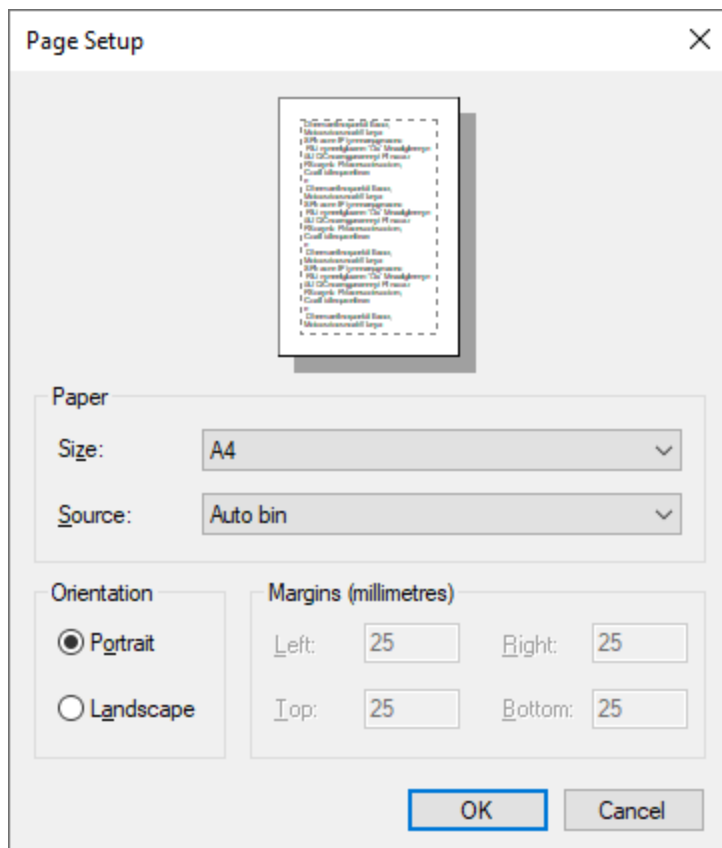
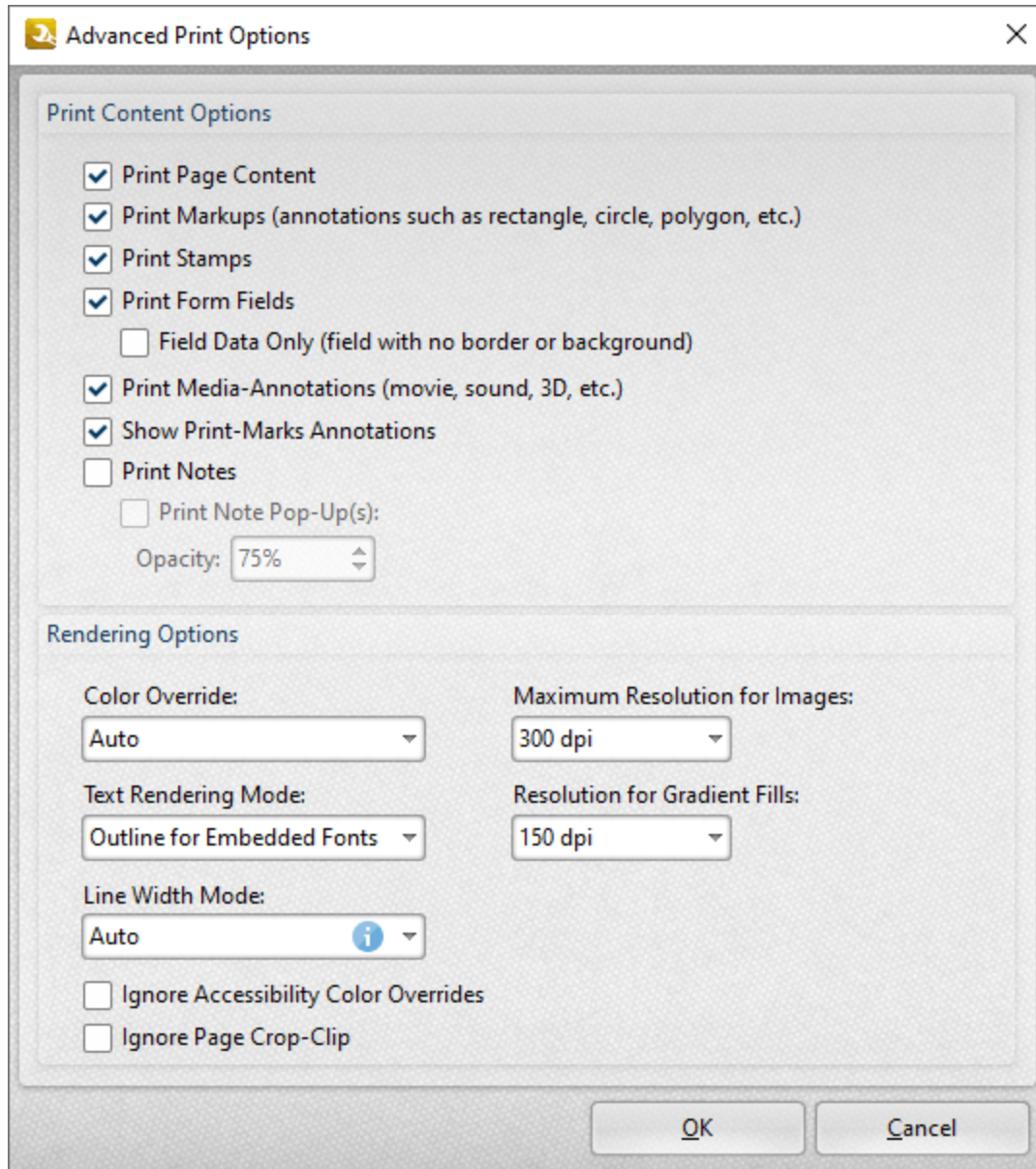

Figure 3. Page Setup Dialog Box

- Select a size for the document from the **Size** menu.
- Select a source for the document from the **Source** menu.



- Use the option buttons to select either **Portrait** or **Landscape** as the orientation for the document.
- Click **OK** to apply changes.



**Figure 4.** Advanced Print Options Dialog Box

- Use the **Print Content Options** to determine printed document content.
- Use the **Rendering Options** to determine how documents are rendered:
  - Use the **Color Override** dropdown menu to determine color override options:
    - **Auto** permits **PDF-XChange Editor** to select the color override setting.
    - **Grayscale** prints documents in grayscale.
    - **Monochrome** prints documents in monochrome.
    - **Color** prints documents in color.

- Use the **Text Rendering Mode** dropdown menu to determine how text is rendered:
  - **Auto** permits **PDF-XChange Editor** to select the text rendering mode. Additionally, it should be noted that this option is required in order to print embedded fonts.
  - **Outline for Embedded Fonts** prints embedded fonts as outlines, which are vector images.
  - **Outline Always** prints all fonts as outlines.
  - **Bitmap for Embedded Fonts** prints embedded fonts as bitmap images.
  - **Bitmap Always** prints all fonts as bitmap images.
- Use the **Maximum Resolution for Images** dropdown menu to set the maximum resolution of images in printed documents.
- Use the **Resolution for Gradient Fills** dropdown menu to determine the resolution used for gradient fills.
- Select the **Ignore** check boxes as desired.

Click **OK** to save changes.

---

## 8 Default Tools











---



### Default Tools

---

There are seventy **Default Tools** in **PDF-Tools**. They are grouped into eleven categories:

-  The **Create PDF** <sup>316</sup> tools are used to create PDF documents.
-  The **Pages** <sup>329</sup> tools are used to edit and enhance document pages.
-  The **Links** <sup>242</sup> tools are used to create/delete links and weblinks.
-  The **Forms** <sup>242</sup> tools are used to import/export or delete forms and form data.
-  The **Comments** <sup>389</sup> tools are used to import/export, remove, summarize and flatten comments.
-  The **Bookmarks** <sup>402</sup> tools are used to create, import, export and build tables of contents from bookmarks.
-  The **Protection** <sup>417</sup> tools are used to add (or clear) digital signature fields, password protection and timestamps to documents.
-  The **Optimize** <sup>432</sup> tools are used to enhance scanned pages and optimize the size of documents.
-  The **PDF Standard** <sup>437</sup> tools convert PDF documents to/from PDF subsets such as **PDF/A** and **PDF/X**.
-  The **Export PDF** <sup>444</sup> tools convert PDF documents to different formats, such as **MS Office** and image formats.
-  The **Advanced** <sup>459</sup> tools are used to change document properties and print or email documents.

Note that the **Clone Tool** <sup>71</sup> or **Create Tool** <sup>65</sup> features can be used to edit and enhance the functionality of tools in order to meet complex requirements.

---

## 8.1 Create PDF Tools







---



### Create PDF Tools

---

The **Create PDF** tools are used to create PDF documents:

-  [Convert Files to PDFs](#)<sup>[317]</sup> converts files to PDF.
-  [Create PDF from Images](#)<sup>[319]</sup> creates PDF files from raster images.
-  [Create PDF from Text](#)<sup>[321]</sup> creates PDF files from text files.
-  [Extract Pages](#)<sup>[323]</sup> extracts specified pages of PDF documents.
-  [Scan to PDF](#)<sup>[325]</sup> uses the local scanner to create PDF files.
-  [Split/Merge PDFs](#)<sup>[327]</sup> splits single PDF documents into multiple files or merges multiple PDF documents into a single file.

Note that the [Clone Tool](#)<sup>[71]</sup> and [Create Tool](#)<sup>[65]</sup> features can be used to enhance the functionality of existing tools/create new tools in order to meet complex requirements.

---

## 8.1.1 Convert Files to PDFs



The **Convert Files to PDFs** tool converts files to PDF:

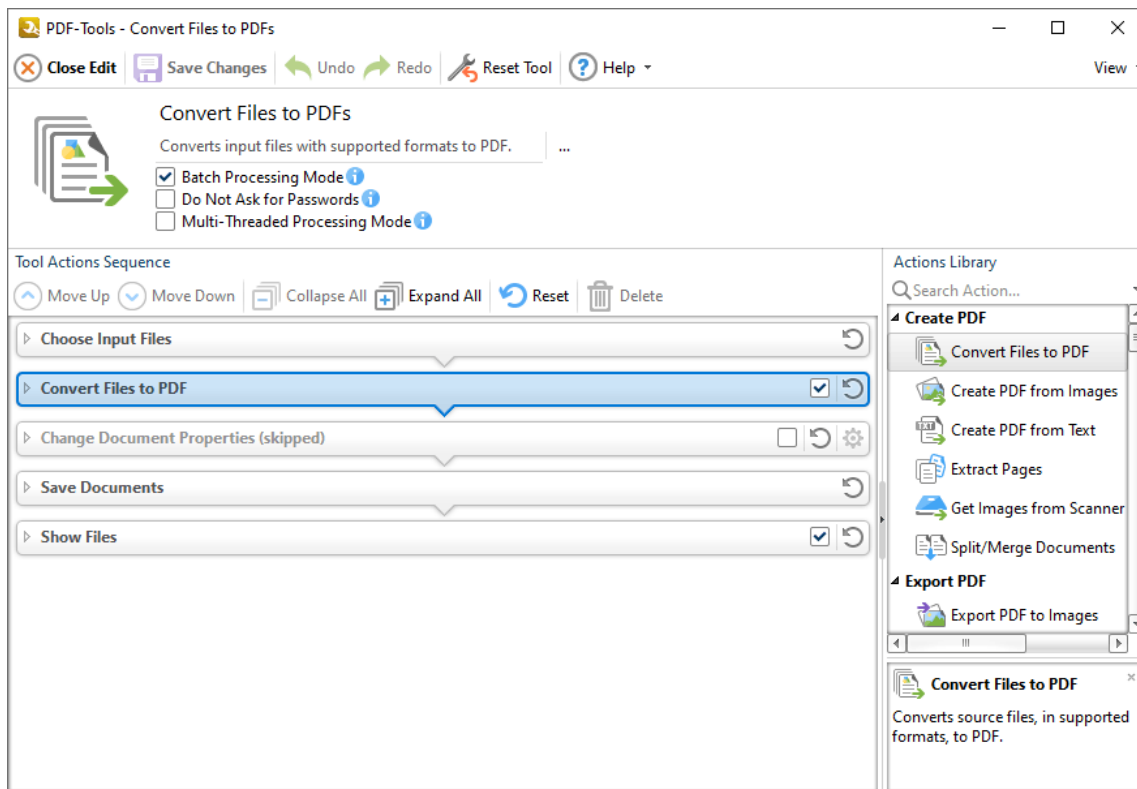

Figure 1. Convert Files to PDFs Tool Actions Sequence

The **Convert Files to PDFs** tool uses five tool actions:

1. **Choose Input Files** <sup>[126]</sup> - the tool prompts for source documents.
2. **Convert Files to PDF** <sup>[79]</sup> - the source documents are converted to PDF.
3. **Change Document Properties** <sup>[292]</sup> (skipped by default) - the document properties are changed.
4. **Save Documents** <sup>[135]</sup> - the updated documents are saved.
5. **Show Files** <sup>[142]</sup> - the new documents are displayed in their destination folder.

Click actions to view customizable parameters. Additionally, please note that the [Clone Tool](#)<sup>[71]</sup> feature can be used to clone this tool and then add/remove actions from the **Tool Actions Sequence**.

Information about the **Batch Processing Mode, Do Not Ask for Passwords** and **Multi-Threaded Processing** check boxes is available [here](#).<sup>[57]</sup>

---

## 8.1.2 Create PDF from Images



The **Create PDF from Images** tool creates PDF files from raster images:

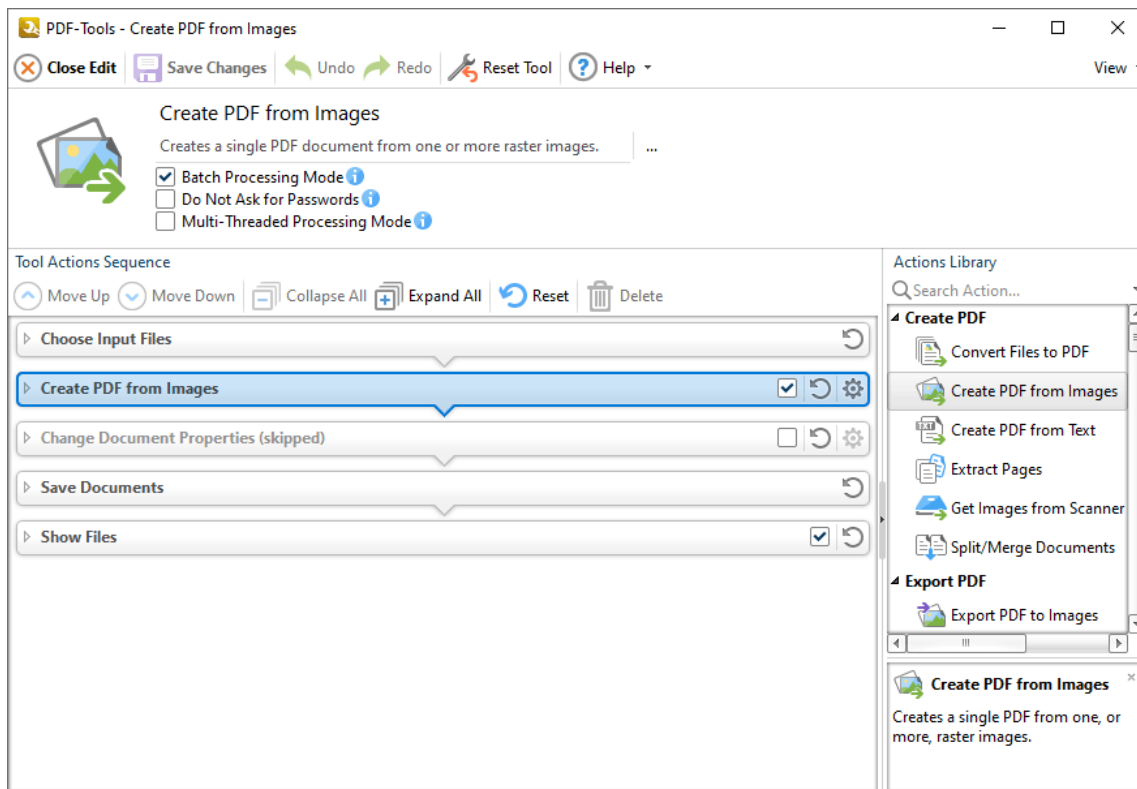

Figure 1. Create PDF from Images Tool Actions Sequence

The **Create PDF from Images** tool uses five tool actions:

1. **Choose Input Files**<sup>[126]</sup> - the tool prompts for source documents.
2. **Create PDF from Images**<sup>[86]</sup> - raster images are identified and saved in a new PDF file.
3. **Change Document Properties**<sup>[292]</sup> (skipped by default) - the document properties are changed.
4. **Save Documents**<sup>[135]</sup> - the updated documents are saved.
5. **Show Files**<sup>[142]</sup> - the new documents are displayed in their destination folder.

Click actions to view customizable parameters. Additionally, please note that the [Clone Tool](#)<sup>[71]</sup> feature can be used to clone this tool and then add/remove actions from the **Tool Actions Sequence**.

Information about the **Batch Processing Mode, Do Not Ask for Passwords** and **Multi-Threaded Processing** check boxes is available [here](#).<sup>[57]</sup>

---



## 8.1.3 Create PDF from Text



## Create PDF from Text

The **Create PDF from Text** tool creates PDF files from text files:

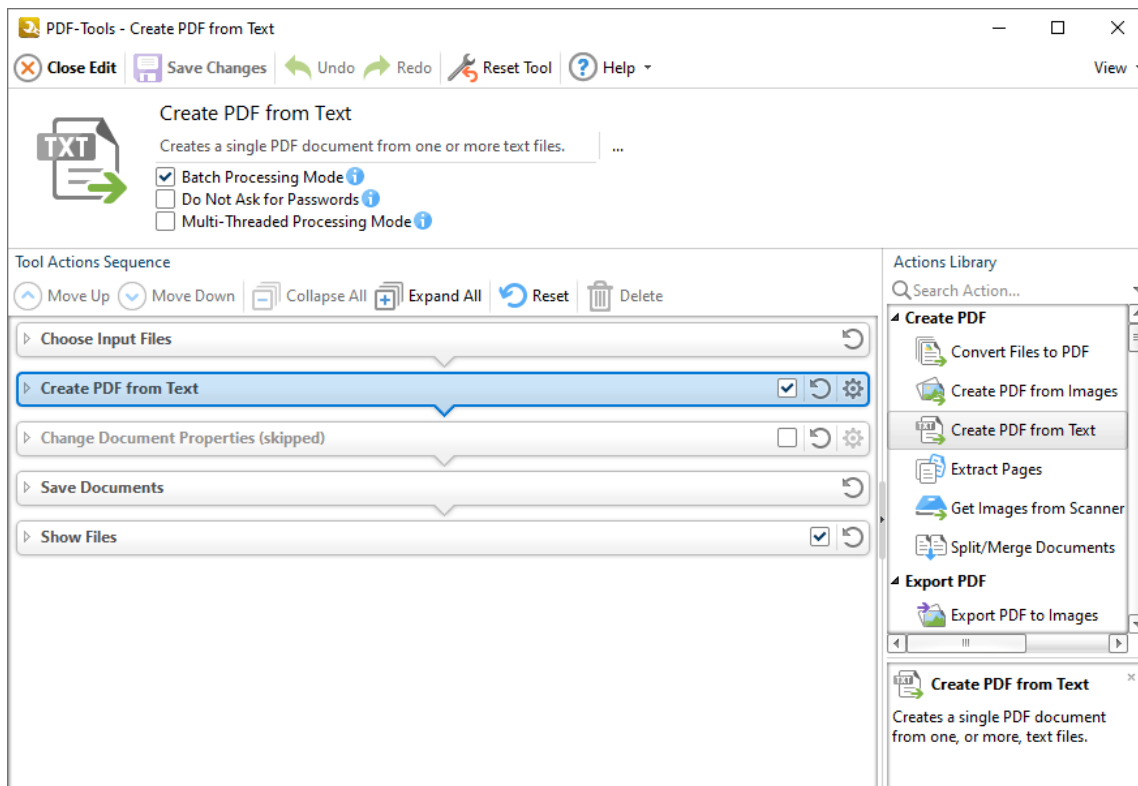







Figure 1. Create PDF from Text Tool Actions Sequence

The **Create PDF from Text** tool uses five tool actions:

1.  **Choose Input Files** <sup>[126]</sup> - the tool prompts for plain text (**\*.txt**) source documents.
2.  **Create PDF from Text** <sup>[93]</sup> - the documents are converted to PDF format.
3.  **Change Document Properties** <sup>[292]</sup> (skipped by default) - the document properties are changed.
4.  **Save Documents** <sup>[135]</sup> - the updated documents are saved.
5.  **Show Files** <sup>[142]</sup> - the new documents are displayed in their destination folder.

Click actions to view customizable parameters. Additionally, please note that the [Clone Tool](#)<sup>[71]</sup> feature can be used to clone this tool and then add/remove actions from the **Tool Actions Sequence**.

Information about the **Batch Processing Mode, Do Not Ask for Passwords** and **Multi-Threaded Processing** check boxes is available [here](#).<sup>[57]</sup>

---

## 8.1.4 Extract Pages



## Extract Pages

The **Extract Pages** tool extracts specified pages from PDF documents and saves them as a new file:

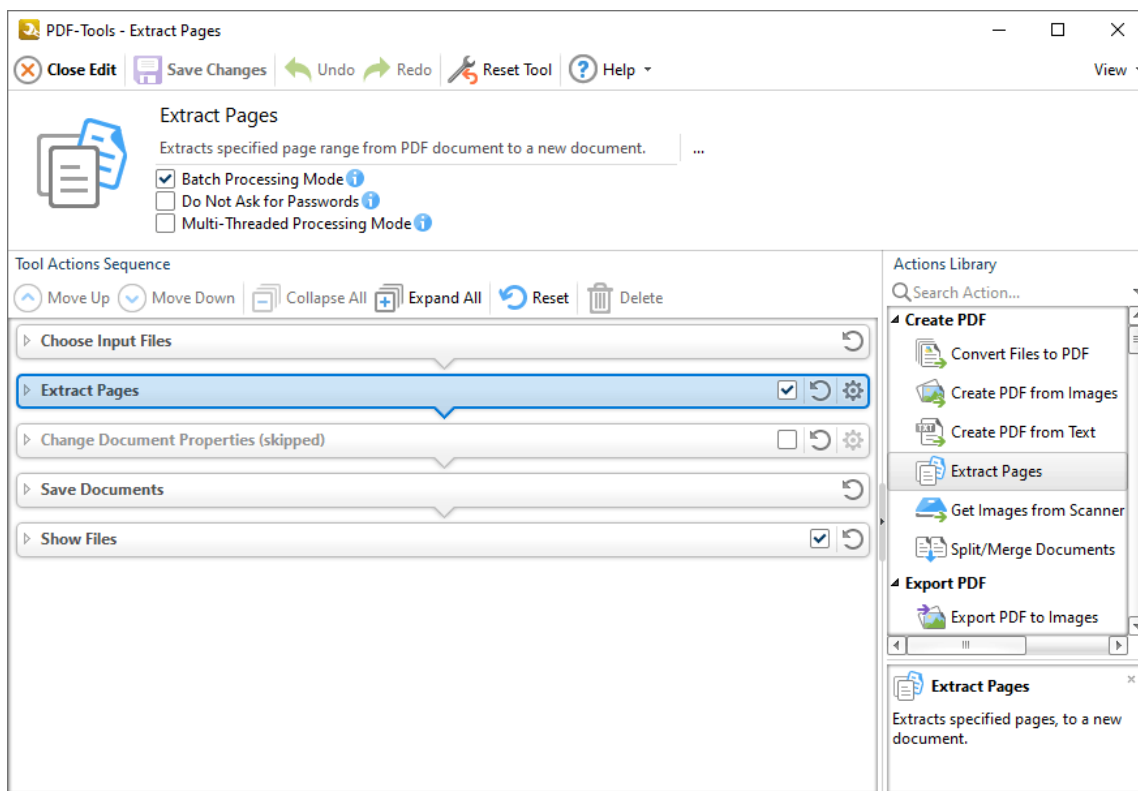







Figure 1. Extract Pages Tool Actions Sequence

The **Extract Pages** tool uses five tool actions:

1.  **Choose Input Files** <sup>[128]</sup> - the tool prompts for source documents.
2.  **Extract Pages** <sup>[97]</sup> - document pages are specified, extracted and converted to PDF.
3.  **Change Document Properties** <sup>[292]</sup> (skipped by default) - the document properties are changed.
4.  **Save Documents** <sup>[135]</sup> - the updated documents are saved.
5.  **Show Files** <sup>[142]</sup> - the new documents are displayed in their destination folder.

Click actions to view customizable parameters. Additionally, please note that the [Clone Tool](#)<sup>[71]</sup> feature can be used to clone this tool and then add/remove actions from the **Tool Actions Sequence**.

Information about the **Batch Processing Mode**, **Do Not Ask for Passwords** and **Multi-Threaded Processing** check boxes is available [here](#).<sup>[57]</sup>

---

## 8.1.5 Scan to PDF



The **Scan to PDF** tool uses the local scanner to create PDF files:

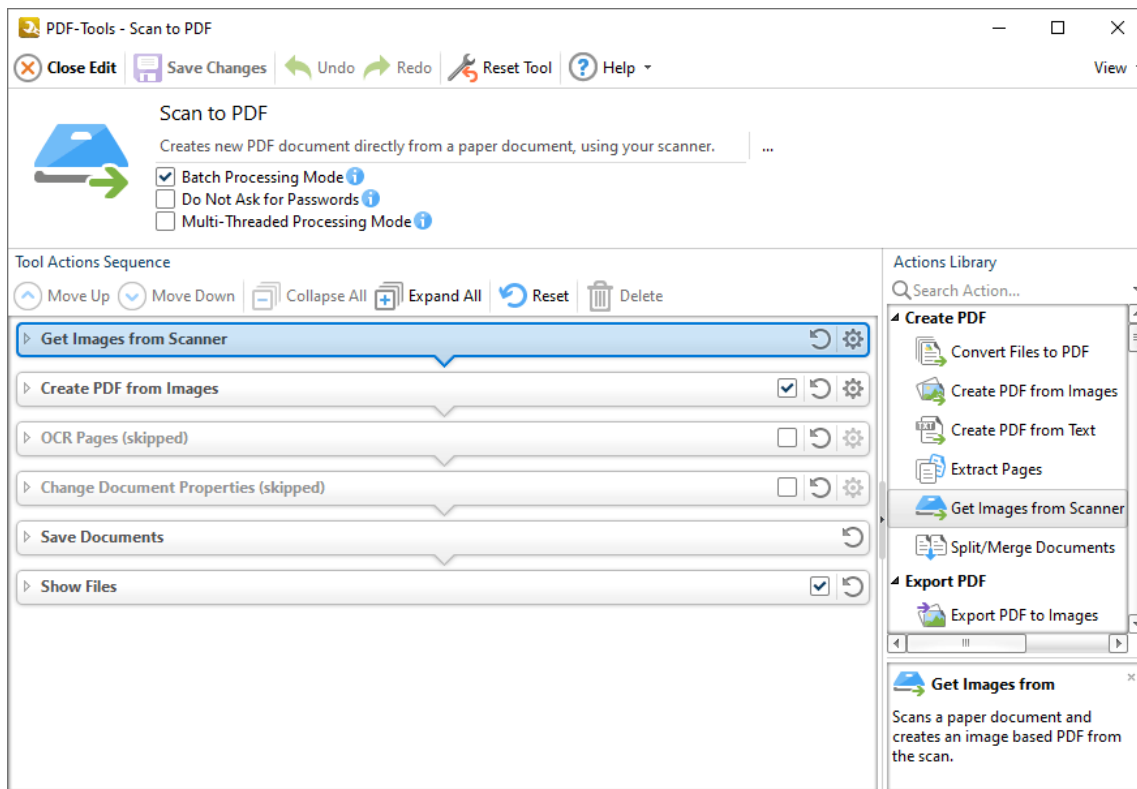



Figure 1. Scan to PDF Tool Actions Sequence

The **Scan to PDF** tool uses six tool actions:

1. [Get Images From Scanner](#)<sup>[99]</sup> - images are sourced from the local scanner.
2. [Create PDF from Images](#)<sup>[86]</sup> - raster images are identified and saved in a new PDF file.
3. [OCR Pages](#)<sup>[219]</sup> (skipped by default) - optical character recognition is performed on the scanned documents.
4. [Change Document Properties](#)<sup>[292]</sup> (skipped by default) - the document properties are changed.

5.  [Save Documents](#)<sup>[135]</sup> - the updated documents are saved.
6.  [Show Files](#)<sup>[142]</sup> - the new documents are displayed in their destination folder.

Click actions to view customizable parameters. Additionally, please note that the [Clone Tool](#)<sup>[71]</sup> feature can be used to clone this tool and then add/remove actions from the **Tool Actions Sequence**.

Information about the **Batch Processing Mode**, **Do Not Ask for Passwords** and **Multi-Threaded Processing** check boxes is available [here](#).<sup>[57]</sup>

---

## 8.1.6 Split/Merge PDFs



## Split/Merge PDFs

The **Split/Merge PDFs** tool splits single PDF documents into multiple files or merges multiple PDF documents into a single file:

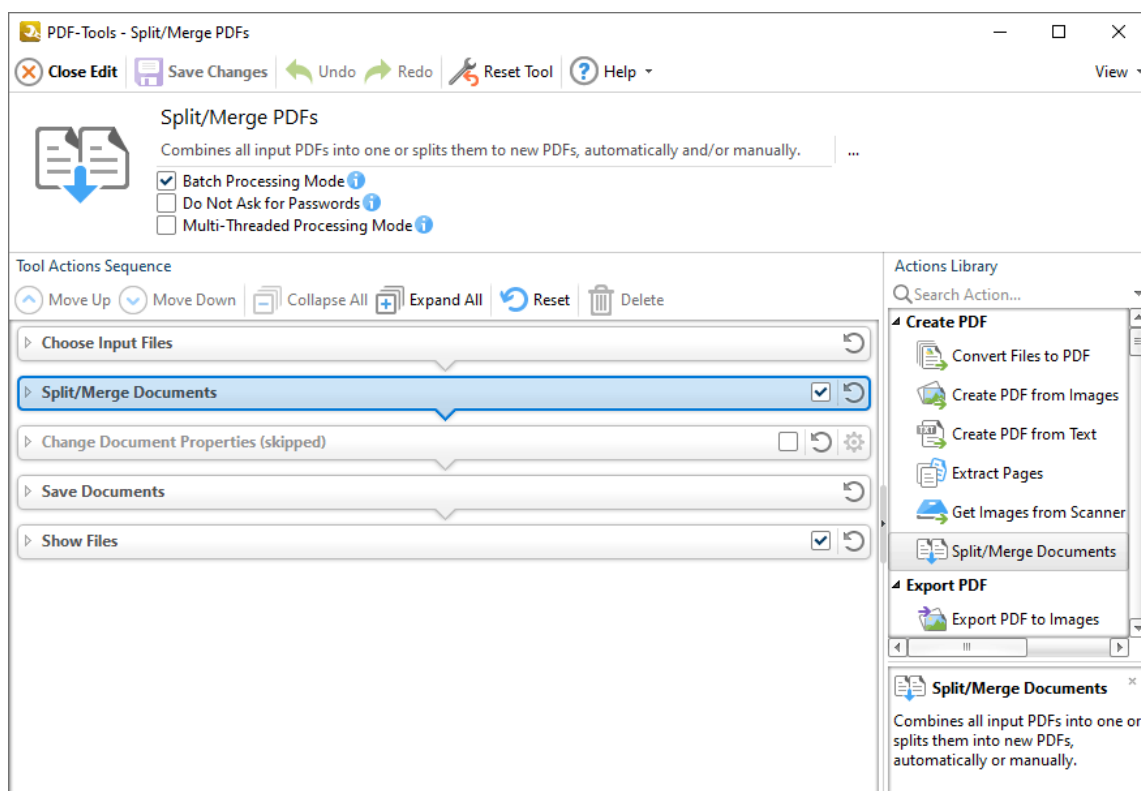







Figure 1. Split/Merge PDFs Tool Actions Sequence

The **Split/Merge PDFs** tool uses five tool actions:

1.  **Choose Input Files**<sup>[128]</sup> - the tool prompts for source documents.
2.  **Split/Merge Documents**<sup>[103]</sup> - a single PDF document is split into multiple documents, or multiple PDF documents are merged into a single document.
3.  **Change Document Properties**<sup>[292]</sup> (skipped by default) - the document properties are changed.
4.  **Save Documents**<sup>[135]</sup> - the updated documents are saved.

5.  [Show Files](#)<sup>[142]</sup> - the new documents are displayed in their destination folder.

Click actions to view customizable parameters. Additionally, please note that the [Clone Tool](#)<sup>[71]</sup> feature can be used to clone this tool and then add/remove actions from the **Tool Actions Sequence**.

Information about the **Batch Processing Mode**, **Do Not Ask for Passwords** and **Multi-Threaded Processing** check boxes is available [here](#).<sup>[57]</sup>

---



## 8.2 Pages Tools



















---





### Pages Tools

---

The **Pages** tools are used to edit and enhance document pages:

-  [Add Bates Numbering](#)<sup>[331]</sup> inserts Bates numbering to input documents.
-  [Add Header and Footer](#)<sup>[333]</sup> inserts headers and footers into input documents.
-  [Add Watermark](#)<sup>[335]</sup> inserts watermarks into input documents.
-  [Crop Pages](#)<sup>[337]</sup> adjusts document dimensions, white margins and page boxes in input documents.
-  [Delete Pages](#)<sup>[339]</sup> deletes pages from input documents.
-  [Duplicate Pages](#)<sup>[341]</sup> duplicates pages of input documents.
-  [Insert Empty Pages](#)<sup>[343]</sup> inserts empty pages into input documents.
-  [Insert Pages](#)<sup>[345]</sup> inserts pages from existing documents into input documents.
-  [Merge Pages](#)<sup>[347]</sup> merges pages into a single page.
-  [OCR Pages](#)<sup>[349]</sup> performs optical character recognition on input documents.
-  [Overlay PDF](#)<sup>[351]</sup> overlays input documents with existing files.
-  [Remove Bates Numbering](#)<sup>[353]</sup> removes Bates numbering from input documents.
-  [Remove Headers and Footers](#)<sup>[355]</sup> removes headers and footers from input documents.
-  [Remove Page Background](#)<sup>[357]</sup> removes backgrounds from input documents.
-  [Remove Watermarks](#)<sup>[359]</sup> removes watermarks from input documents.
-  [Replace Pages](#)<sup>[361]</sup> replaces specified pages of input documents with pages from existing documents.
-  [Resize Pages](#)<sup>[363]</sup> resizes specified pages of input documents.
-  [Rotate Pages](#)<sup>[365]</sup> rotates specified pages of input documents.

 [Set Page Transitions](#)<sup>[367]</sup> determines the animated effect when moving between document pages in fullscreen mode.

 [Set Pages Background](#)<sup>[369]</sup> changes the background of input documents.

 [Split Pages](#)<sup>[371]</sup> splits the pages of input documents into custom sections.

Note that the [Clone Tool](#)<sup>[71]</sup> and [Create Tool](#)<sup>[65]</sup> features can be used to enhance the functionality of existing tools/create new tools in order to meet complex requirements.

---

### 8.2.1 Add Bates Numbering

## Add Bates Numbering

The **Add Bates Numbering** tool inserts Bates numbering into input documents. Bates numbering is a dynamic way to provide identification, protection and automatic consecutive numbering within documents as they are processed/scanned. Further information on Bates numbering is available [here](#).

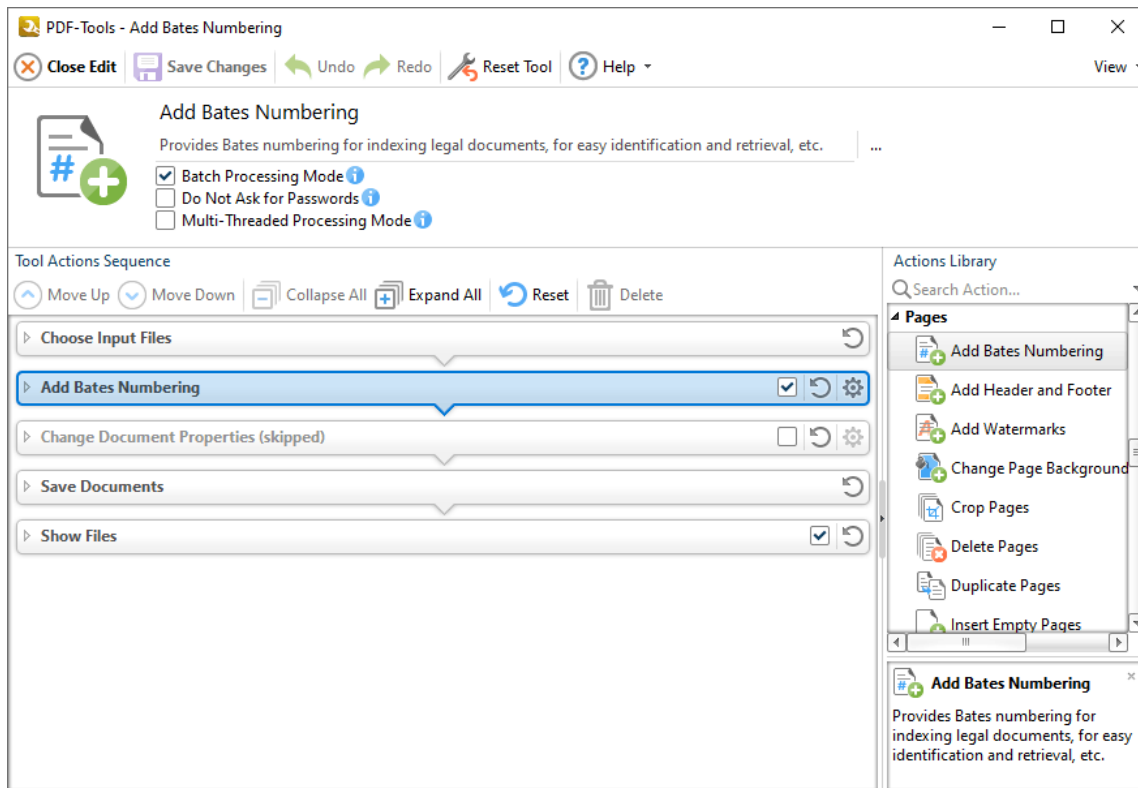







Figure 1. Add Bates Numbering Tool Actions Sequence

The **Add Bates Numbering** tool uses five tool actions:

1.  **Choose Input Files** <sup>[128]</sup> - the tool prompts for source documents.
2.  **Add Bates Numbering** <sup>[188]</sup> - Bates numbering is inserted into the documents.
3.  **Change Document Properties** <sup>[292]</sup> (skipped by default) - the document properties are changed.
4.  **Save Documents** <sup>[135]</sup> - the updated documents are saved.

5.  [Show Files](#)<sup>[142]</sup> - the new documents are displayed in their destination folder.

Click actions to view customizable parameters. Additionally, please note that the [Clone Tool](#)<sup>[71]</sup> feature can be used to clone this tool and then add/remove actions from the **Tool Actions Sequence**.

Information about the **Batch Processing Mode**, **Do Not Ask for Passwords** and **Multi-Threaded Processing** check boxes is available [here](#).<sup>[57]</sup>

---

## 8.2.2 Add Header and Footer



### Add Header and Footer

The **Add Header and Footer** tool adds headers and footers to input documents:

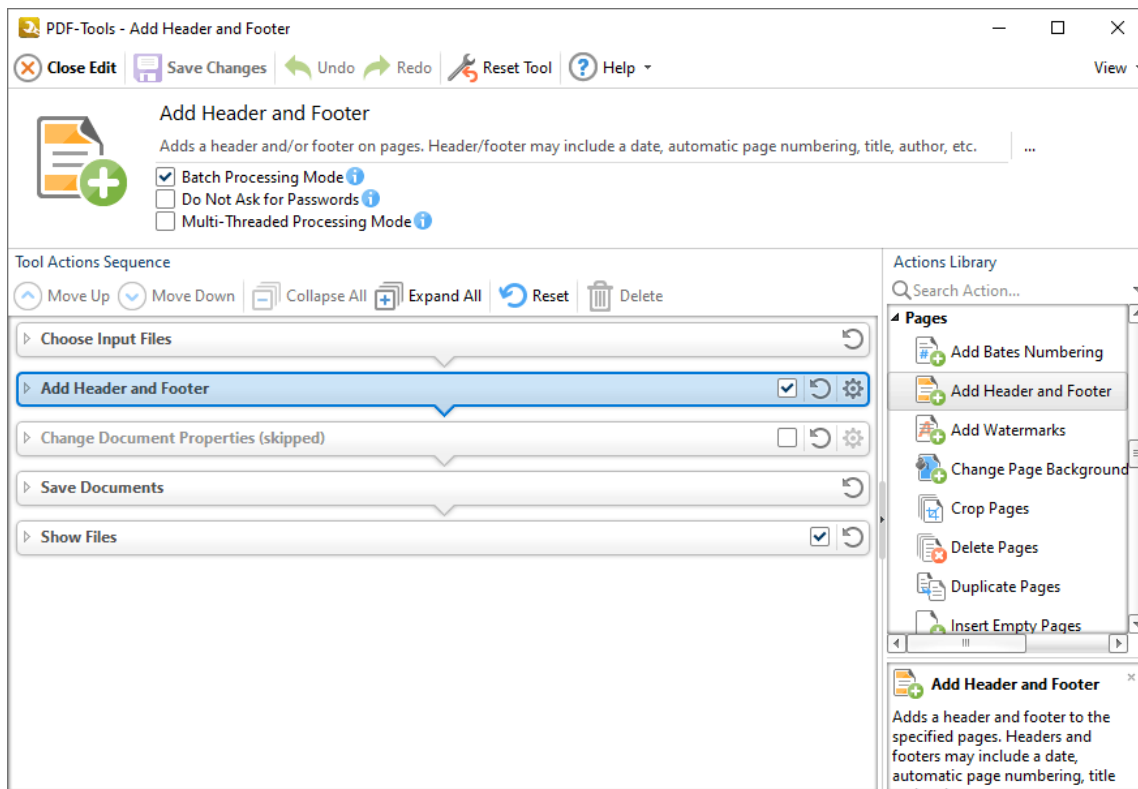







Figure 1. Add Header and Footer Tool Actions Sequence

The **Add Header and Footer** tool uses five tool actions:

1.  **Choose Input Files** <sup>[126]</sup> - the tool prompts for source documents.
2.  **Add Header and Footer** <sup>[192]</sup> - headers and/or footers are added to the documents.
3.  **Change Document Properties** <sup>[292]</sup> (skipped by default) - the document properties are changed.
4.  **Save Documents** <sup>[135]</sup> - the updated documents are saved.
5.  **Show Files** <sup>[142]</sup> - the new documents are displayed in their destination folder.

Click actions to view customizable parameters. Additionally, please note that the [Clone Tool](#)<sup>[71]</sup> feature can be used to clone this tool and then add/remove actions from the **Tool Actions Sequence**.

Information about the **Batch Processing Mode, Do Not Ask for Passwords** and **Multi-Threaded Processing** check boxes is available [here](#).<sup>[57]</sup>

---

## 8.2.3 Add Watermark



## Add Watermark

The **Add Watermark** tool inserts watermarks into input documents:

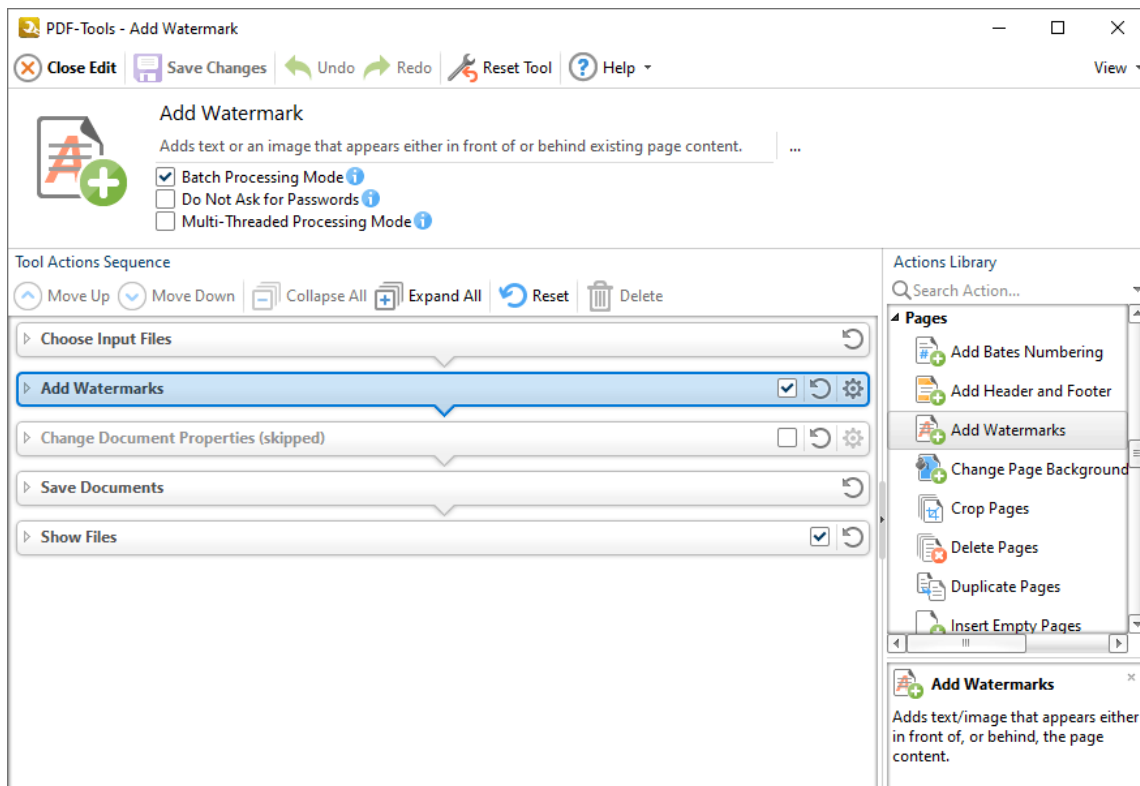







Figure 1. Add Watermark Tool Actions Sequence

The **Add Watermark** tool uses five tool actions:

1.  **Choose Input Files** <sup>[126]</sup> - the tool prompts for source documents.
2.  **Add Watermarks** <sup>[196]</sup> - watermarks are added to the documents.
3.  **Change Document Properties** <sup>[292]</sup> (skipped by default) - the document properties are changed.
4.  **Save Documents** <sup>[135]</sup> - the updated documents are saved.
5.  **Show Files** <sup>[142]</sup> - the new documents are displayed in their destination folder.

Click actions to view customizable parameters. Additionally, please note that the [Clone Tool](#)<sup>[71]</sup> feature can be used to clone this tool and then add/remove actions from the **Tool Actions Sequence**.

Information about the **Batch Processing Mode, Do Not Ask for Passwords** and **Multi-Threaded Processing** check boxes is available [here](#).<sup>[57]</sup>

---



## 8.2.4 Crop Pages



The **Crop Pages** tool adjusts document dimensions, white margins and page boxes in input documents:

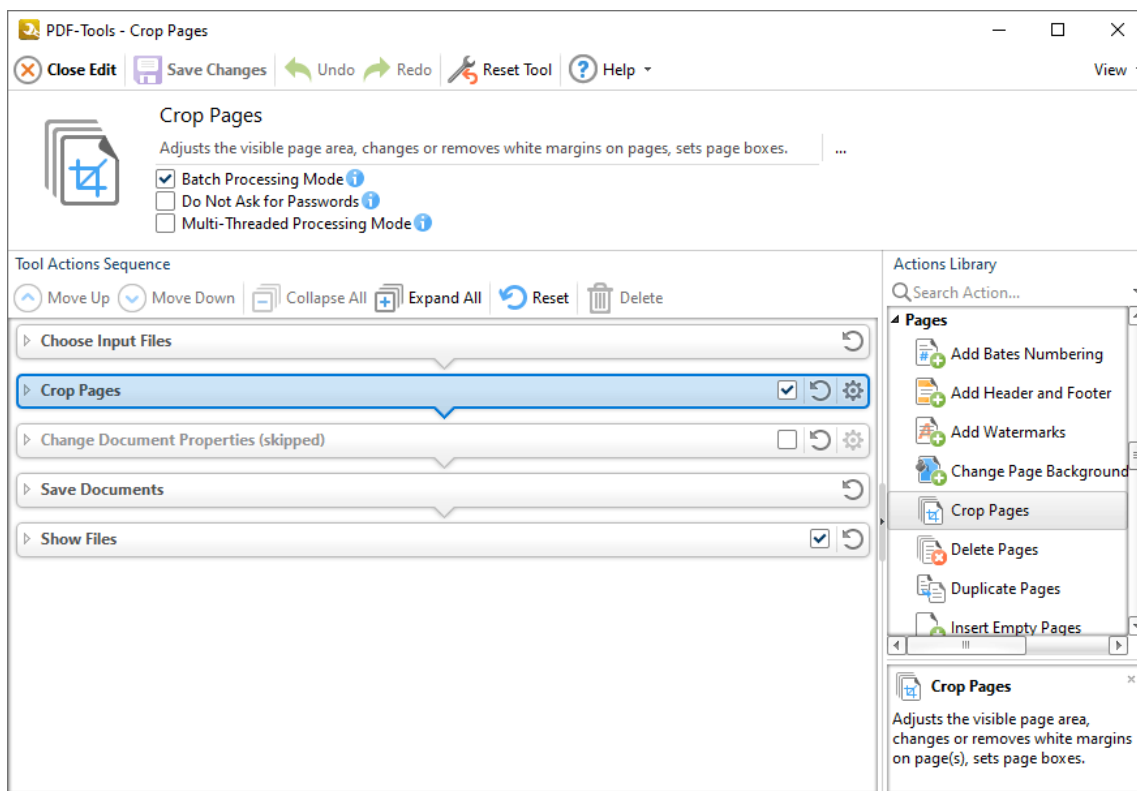



Figure 1. Crop Pages Tool Actions Sequence

The **Crop Pages** tool uses five tool actions:

1. **Choose Input Files**<sup>[128]</sup> - the tool prompts for source documents.
2. **Crop Pages**<sup>[204]</sup> - the document dimensions, white margins and/or page boxes are adjusted.
3. **Change Document Properties**<sup>[292]</sup> (skipped by default) - the document properties are changed.
4. **Save Documents**<sup>[135]</sup> - the updated documents are saved.

5.  [Show Files](#)<sup>[142]</sup> - the new documents are displayed in their destination folder.

Click actions to view customizable parameters. Additionally, please note that the [Clone Tool](#)<sup>[71]</sup> feature can be used to clone this tool and then add/remove actions from the **Tool Actions Sequence**.

Information about the **Batch Processing Mode**, **Do Not Ask for Passwords** and **Multi-Threaded Processing** check boxes is available [here](#).<sup>[57]</sup>

---

## 8.2.5 Delete Pages



## Delete Pages

The **Delete Pages** tool deletes pages from input documents:

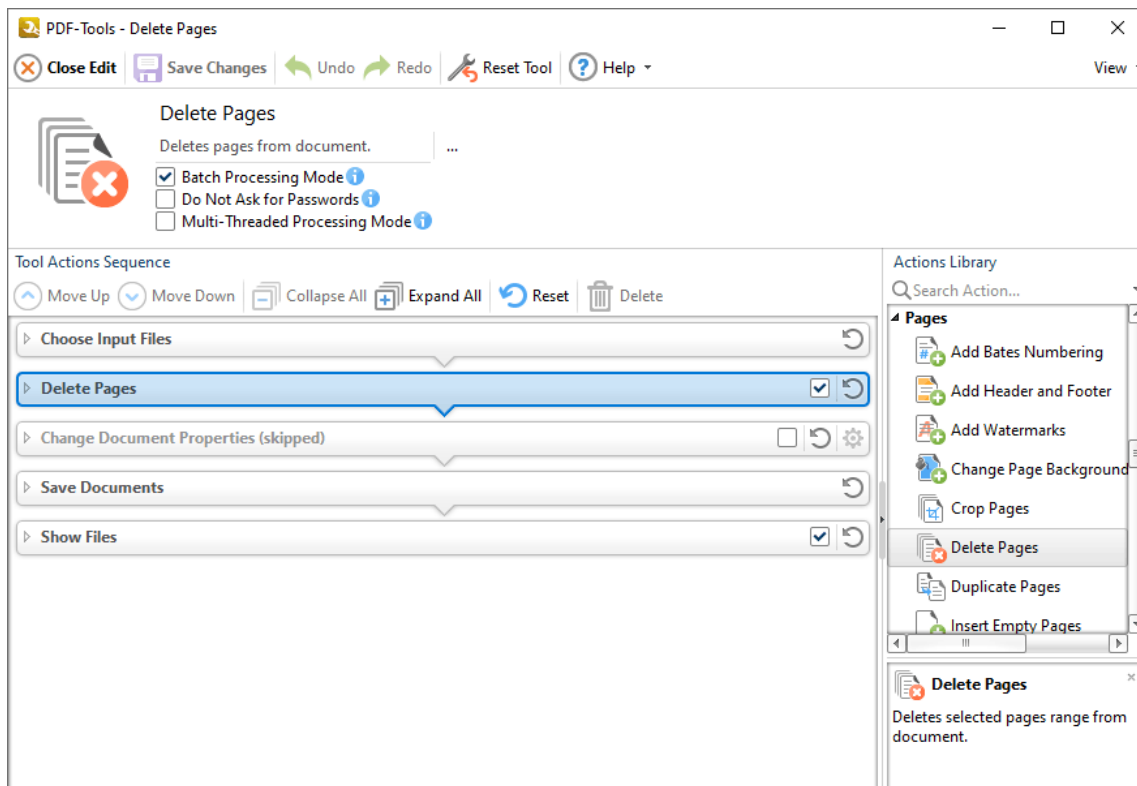







Figure 1. Delete Pages Tool Actions Sequence

The **Delete Pages** tool uses five tool actions:

1.  **Choose Input Files** <sup>[126]</sup> - the tool prompts for source documents.
2.  **Delete Pages** <sup>[207]</sup> - specified pages of the documents are deleted.
3.  **Change Document Properties** <sup>[292]</sup> (skipped by default) - the document properties are changed.
4.  **Save Documents** <sup>[135]</sup> - the updated documents are saved.
5.  **Show Files** <sup>[142]</sup> - the new documents are displayed in their destination folder.

Click actions to view customizable parameters. Additionally, please note that the [Clone Tool](#)<sup>[71]</sup> feature can be used to clone this tool and then add/remove actions from the **Tool Actions Sequence**.

Information about the **Batch Processing Mode, Do Not Ask for Passwords** and **Multi-Threaded Processing** check boxes is available [here](#).<sup>[57]</sup>

---

## 8.2.6 Duplicate Pages



## Duplicate Pages

The **Duplicate Pages** tool duplicates pages of input documents:

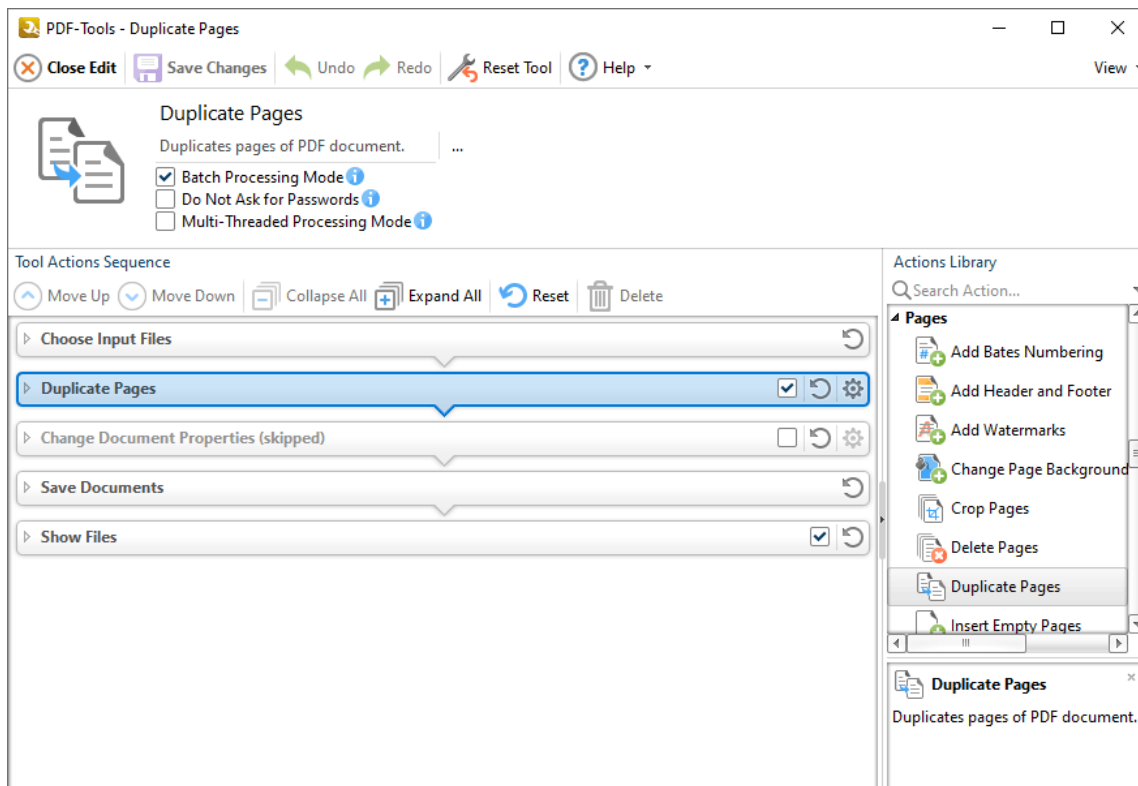







Figure 1. Duplicate Pages Tool Actions Sequence

The **Duplicate Pages** tool uses five tool actions:

1.  **Choose Input Files** <sup>[126]</sup> - the tool prompts for source documents.
2.  **Duplicate Pages** <sup>[209]</sup> - specified document pages are duplicated.
3.  **Change Document Properties** <sup>[292]</sup> (skipped by default) - the document properties are changed.
4.  **Save Documents** <sup>[135]</sup> - the updated documents are saved.
5.  **Show Files** <sup>[142]</sup> - the new documents are displayed in their destination folder.

Click actions to view customizable parameters. Additionally, please note that the [Clone Tool](#)<sup>[71]</sup> feature can be used to clone this tool and then add/remove actions from the **Tool Actions Sequence**.

Information about the **Batch Processing Mode, Do Not Ask for Passwords** and **Multi-Threaded Processing** check boxes is available [here](#).<sup>[57]</sup>

---

## 8.2.7 Insert Empty Pages



## Insert Empty Pages

The **Insert Empty Pages** tool inserts empty pages into input documents:

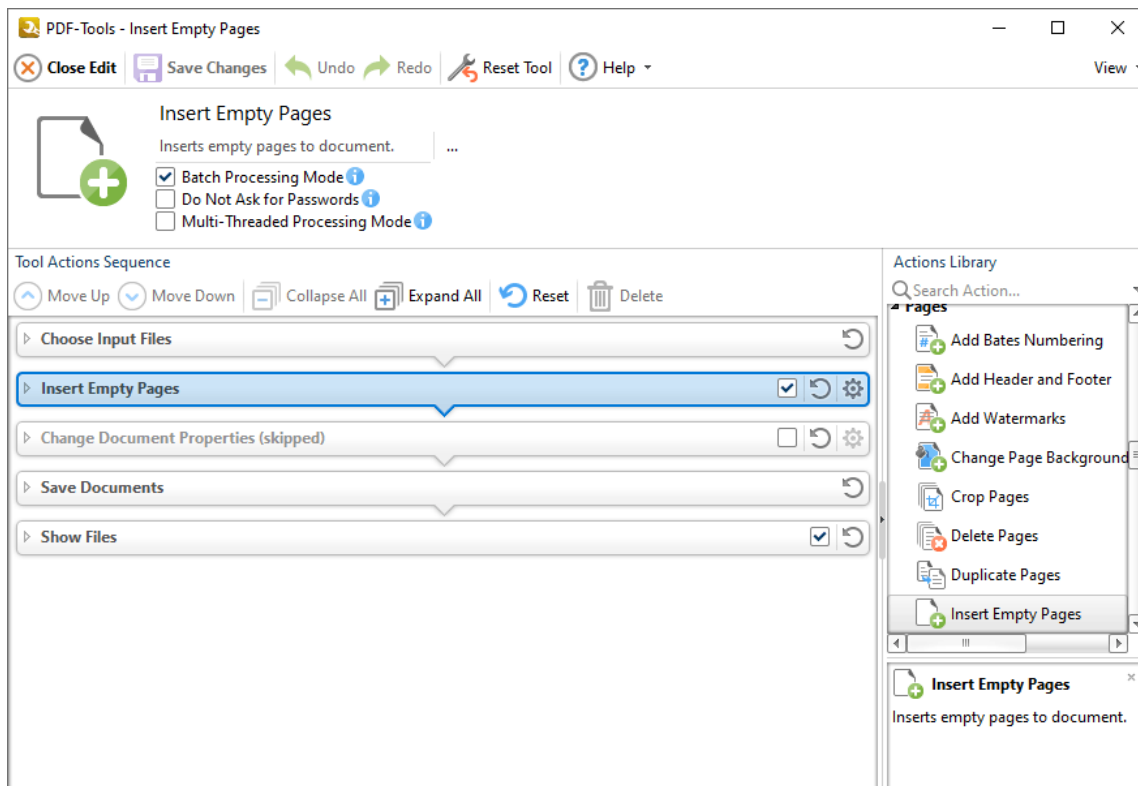







Figure 1. Insert Empty Pages Tool Actions Sequence

The **Insert Empty Pages** tool uses five tool actions:

1.  **Choose Input Files** <sup>[126]</sup> - the tool prompts for source documents.
2.  **Insert Empty Pages** <sup>[211]</sup> - empty pages are inserted into the documents.
3.  **Change Document Properties** <sup>[292]</sup> (skipped by default) - the document properties are changed.
4.  **Save Documents** <sup>[135]</sup> - the updated documents are saved.
5.  **Show Files** <sup>[142]</sup> - the new documents are displayed in their destination folder.

Click actions to view customizable parameters. Additionally, please note that the [Clone Tool](#)<sup>[71]</sup> feature can be used to clone this tool and then add/remove actions from the **Tool Actions Sequence**.

Information about the **Batch Processing Mode, Do Not Ask for Passwords** and **Multi-Threaded Processing** check boxes is available [here](#).<sup>[57]</sup>

---



## 8.2.8 Insert Pages



## Insert Pages

The **Insert Pages** tool inserts pages from existing documents into input documents:

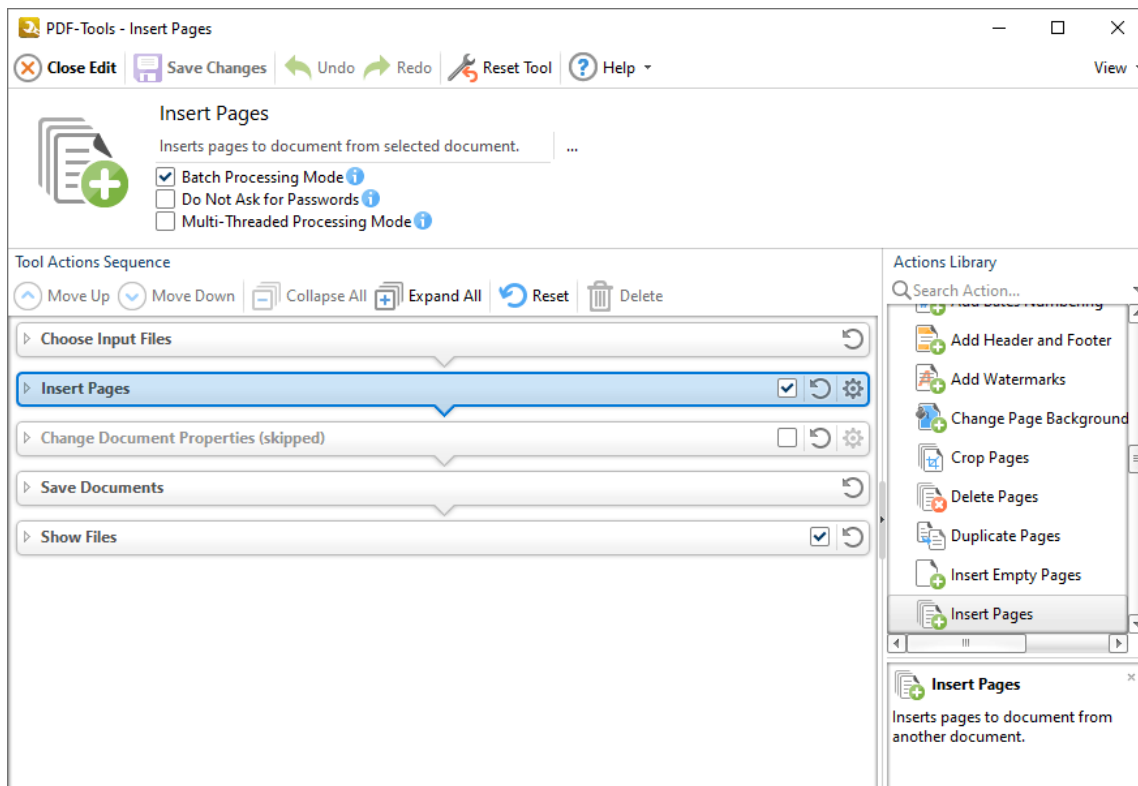







Figure 1. Insert Pages Tool Actions Sequence

The **Insert Pages** tool uses five tool actions:

1.  **Choose Input Files** <sup>[126]</sup> - the tool prompts for source documents.
2.  **Insert Pages** <sup>[213]</sup> - existing document pages are specified and inserted into the source documents.
3.  **Change Document Properties** <sup>[292]</sup> (skipped by default) - the document properties are changed.
4.  **Save Documents** <sup>[135]</sup> - the updated documents are saved.
5.  **Show Files** <sup>[142]</sup> - the new documents are displayed in their destination folder.

Click actions to view customizable parameters. Additionally, please note that the [Clone Tool](#)<sup>[71]</sup> feature can be used to clone this tool and then add/remove actions from the **Tool Actions Sequence**.

Information about the **Batch Processing Mode**, **Do Not Ask for Passwords** and **Multi-Threaded Processing** check boxes is available [here](#).<sup>[57]</sup>

---

## 8.2.9 Merge Pages



## Merge Pages

The **Merge Pages** tool merges pages into a single page:

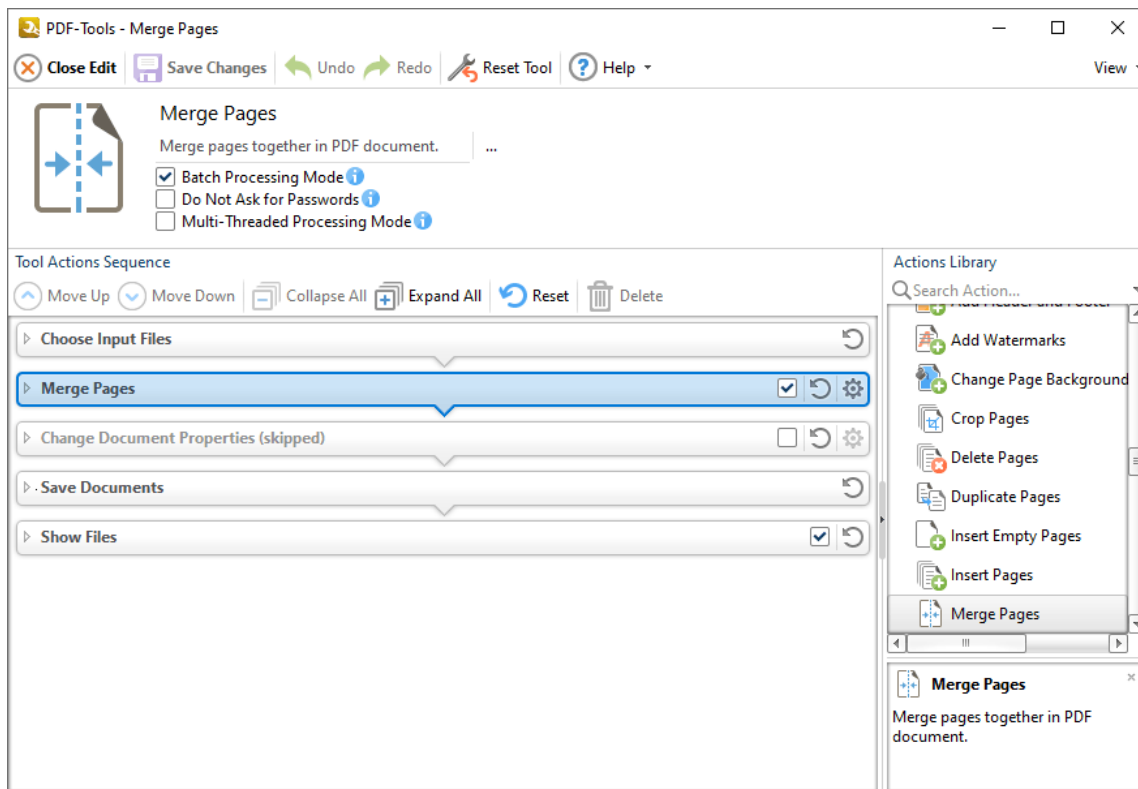







Figure 1. Merge Pages Tool Actions Sequence

The **Merge Pages** tool uses five tool actions:

1.  **Choose Input Files** <sup>[126]</sup> - the tool prompts for source documents.
2.  **Merge Pages** <sup>[216]</sup> - existing document pages are specified and inserted into the source documents.
3.  **Change Document Properties** <sup>[292]</sup> (skipped by default) - the document properties are changed.
4.  **Save Documents** <sup>[135]</sup> - the updated documents are saved.
5.  **Show Files** <sup>[142]</sup> - the new documents are displayed in their destination folder.

Click actions to view customizable parameters. Additionally, please note that the [Clone Tool](#)<sup>[71]</sup> feature can be used to clone this tool and then add/remove actions from the **Tool Actions Sequence**.

Information about the **Batch Processing Mode**, **Do Not Ask for Passwords** and **Multi-Threaded Processing** check boxes is available [here](#).<sup>[57]</sup>

---

## 8.2.10 OCR Pages



## OCR Pages

The **OCR Pages** tool performs optical character recognition on input documents:

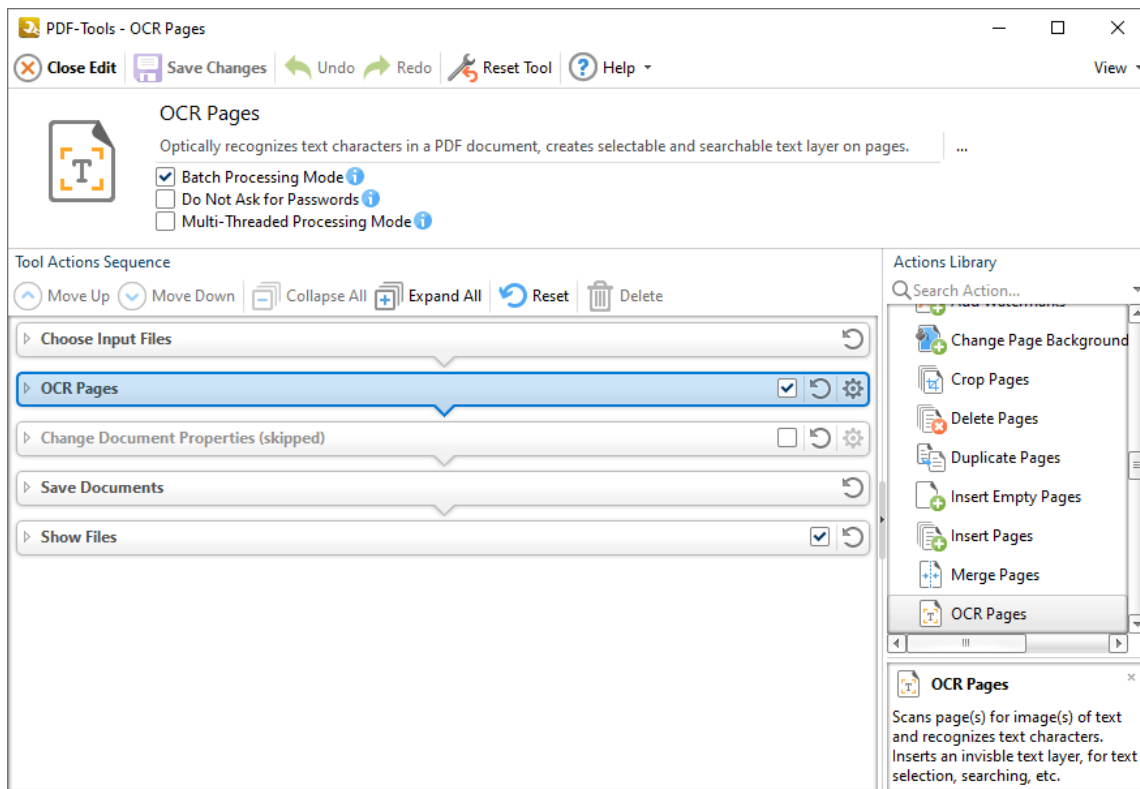







Figure 1. OCR Pages Tool Actions Sequence

The **OCR Pages** tool uses five tool actions:

1.  **Choose Input Files** <sup>[126]</sup> - the tool prompts for source documents.
2.  **OCR Pages** <sup>[219]</sup> - optical character recognition is performed on the documents.
3.  **Change Document Properties** <sup>[292]</sup> (skipped by default) - the document properties are changed.
4.  **Save Documents** <sup>[135]</sup> - the updated documents are saved.
5.  **Show Files** <sup>[142]</sup> - the new documents are displayed in their destination folder.

Click actions to view customizable parameters. Additionally, please note that the [Clone Tool](#)<sup>[71]</sup> feature can be used to clone this tool and then add/remove actions from the **Tool Actions Sequence**.

Information about the **Batch Processing Mode, Do Not Ask for Passwords** and **Multi-Threaded Processing** check boxes is available [here](#).<sup>[57]</sup>

---

## 8.2.11 Overlay PDF



### Overlay PDF

The **Overlay PDF** tool overlays input documents with existing files:

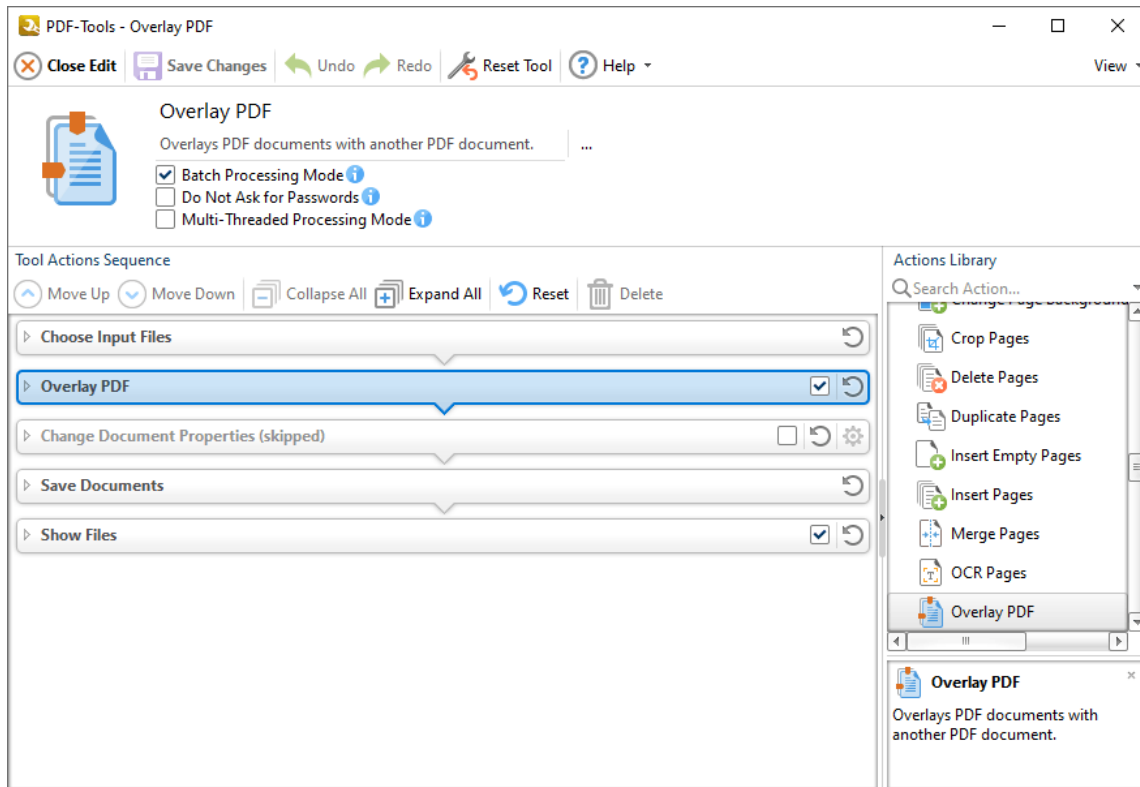







Figure 1. Overlay PDF Tool Actions Sequence

The **OCR Pages** tool uses five tool actions:

1.  **Choose Input Files** <sup>[126]</sup> - the tool prompts for source documents.
2.  **Overlay PDF** <sup>[224]</sup> - existing files are used to overlay the source documents.
3.  **Change Document Properties** <sup>[292]</sup> (skipped by default) - the document properties are changed.
4.  **Save Documents** <sup>[135]</sup> - the updated documents are saved.
5.  **Show Files** <sup>[142]</sup> - the new documents are displayed in their destination folder.

Click actions to view customizable parameters. Additionally, please note that the [Clone Tool](#)<sup>[71]</sup> feature can be used to clone this tool and then add/remove actions from the **Tool Actions Sequence**.

Information about the **Batch Processing Mode, Do Not Ask for Passwords** and **Multi-Threaded Processing** check boxes is available [here](#).<sup>[57]</sup>

---



## 8.2.12 Remove Bates Numbering



The **Remove Bates Numbering** tool removes Bates numbering from input documents:

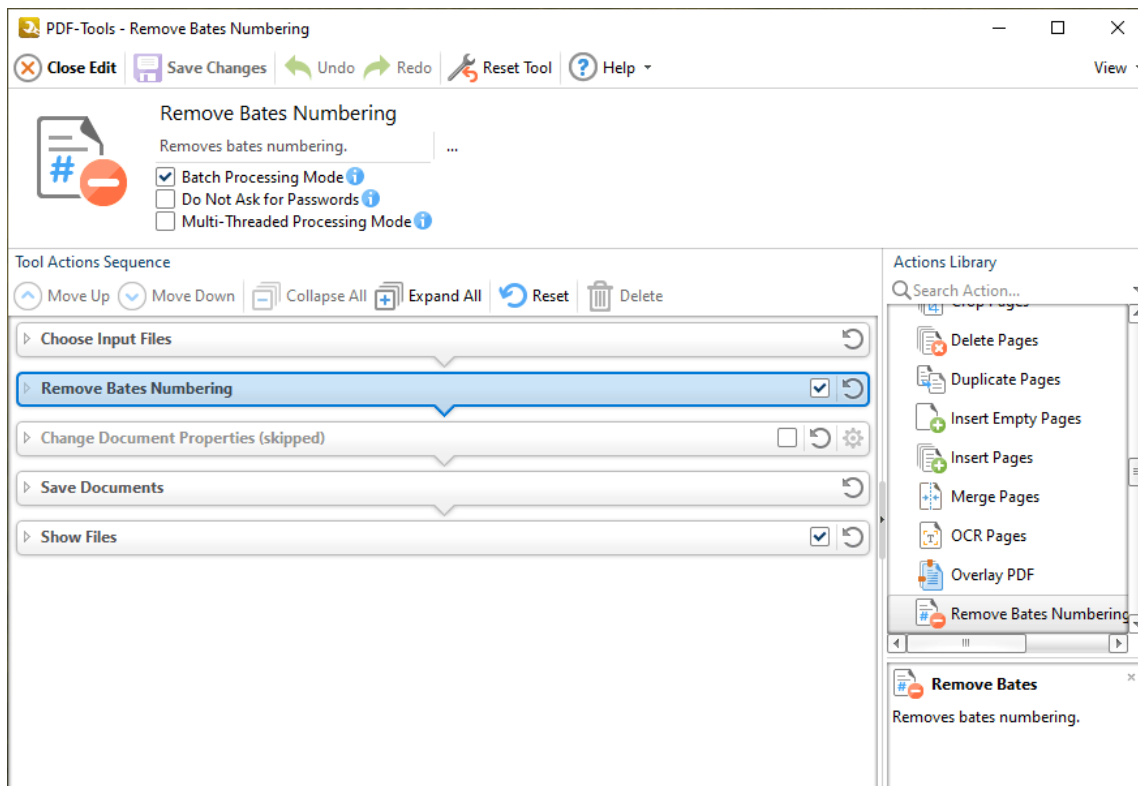

Figure 1. Remove Bates Numbering Tool Actions Sequence

The **Remove Bates Numbering** tool uses five tool actions:

1. **Choose Input Files** <sup>[126]</sup> - the tool prompts for source documents.
2. **Remove Bates Numbering** <sup>[226]</sup> - Bates numbering is removed from the documents.
3. **Change Document Properties** <sup>[292]</sup> (skipped by default) - the document properties are changed.
4. **Save Documents** <sup>[135]</sup> - the updated documents are saved.
5. **Show Files** <sup>[142]</sup> - the new documents are displayed in their destination folder.

Click actions to view customizable parameters. Additionally, please note that the [Clone Tool](#)<sup>[71]</sup> feature can be used to clone this tool and then add/remove actions from the **Tool Actions Sequence**.

Information about the **Batch Processing Mode**, **Do Not Ask for Passwords** and **Multi-Threaded Processing** check boxes is available [here](#).<sup>[57]</sup>

---

## 8.2.13 Remove Headers and Footers



### Remove Headers and Footers

The **Remove Headers and Footers** tool removes headers and footers from input documents:

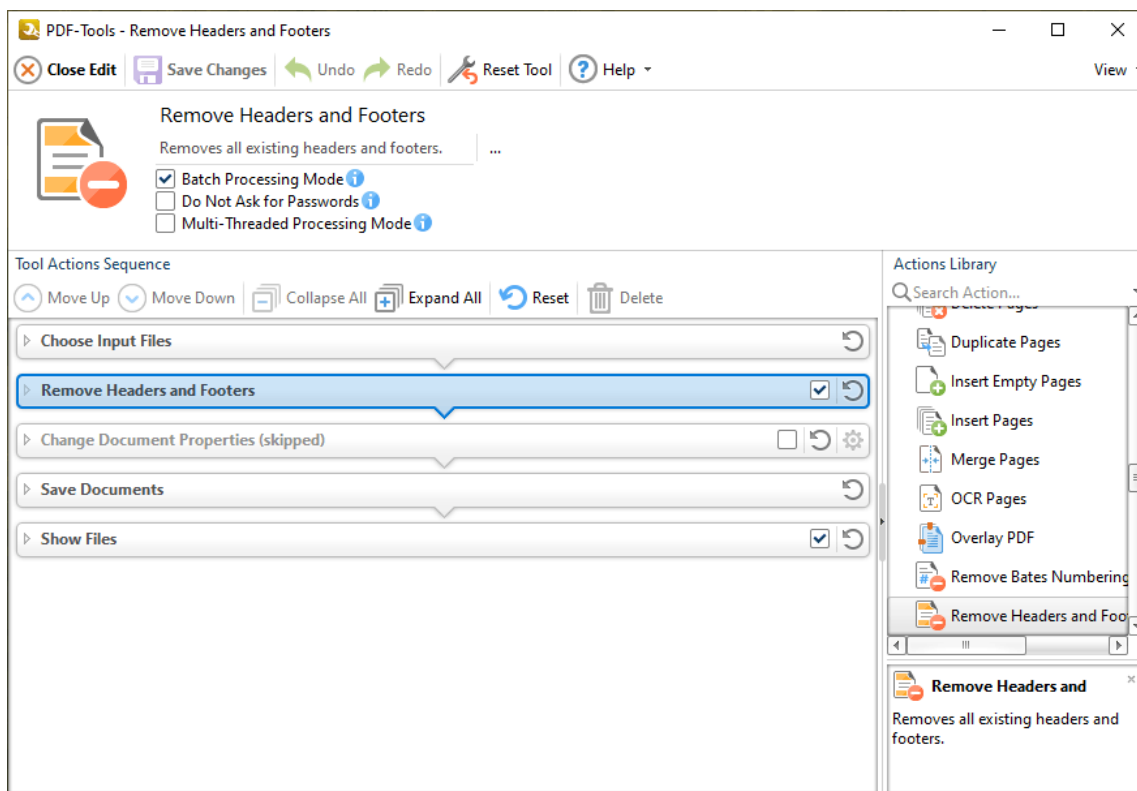







Figure 1. Remove Headers and Footers Tool Actions Sequence

The **Remove Headers and Footers** tool uses five tool actions:

1.  **Choose Input Files** <sup>[128]</sup> - the tool prompts for source documents.
2.  **Remove Headers and Footers** <sup>[227]</sup> - headers and footers are removed from the documents.
3.  **Change Document Properties** <sup>[292]</sup> (skipped by default) - the document properties are changed.
4.  **Save Documents** <sup>[135]</sup> - the updated documents are saved.

5.  [Show Files](#)<sup>[142]</sup> - the new documents are displayed in their destination folder.

Click actions to view customizable parameters. Additionally, please note that the [Clone Tool](#)<sup>[71]</sup> feature can be used to clone this tool and then add/remove actions from the **Tool Actions Sequence**.

Information about the **Batch Processing Mode**, **Do Not Ask for Passwords** and **Multi-Threaded Processing** check boxes is available [here](#).<sup>[57]</sup>

---

## 8.2.14 Remove Pages Background



## Remove Pages Background

The **Remove Pages Background** tool removes backgrounds from input documents:

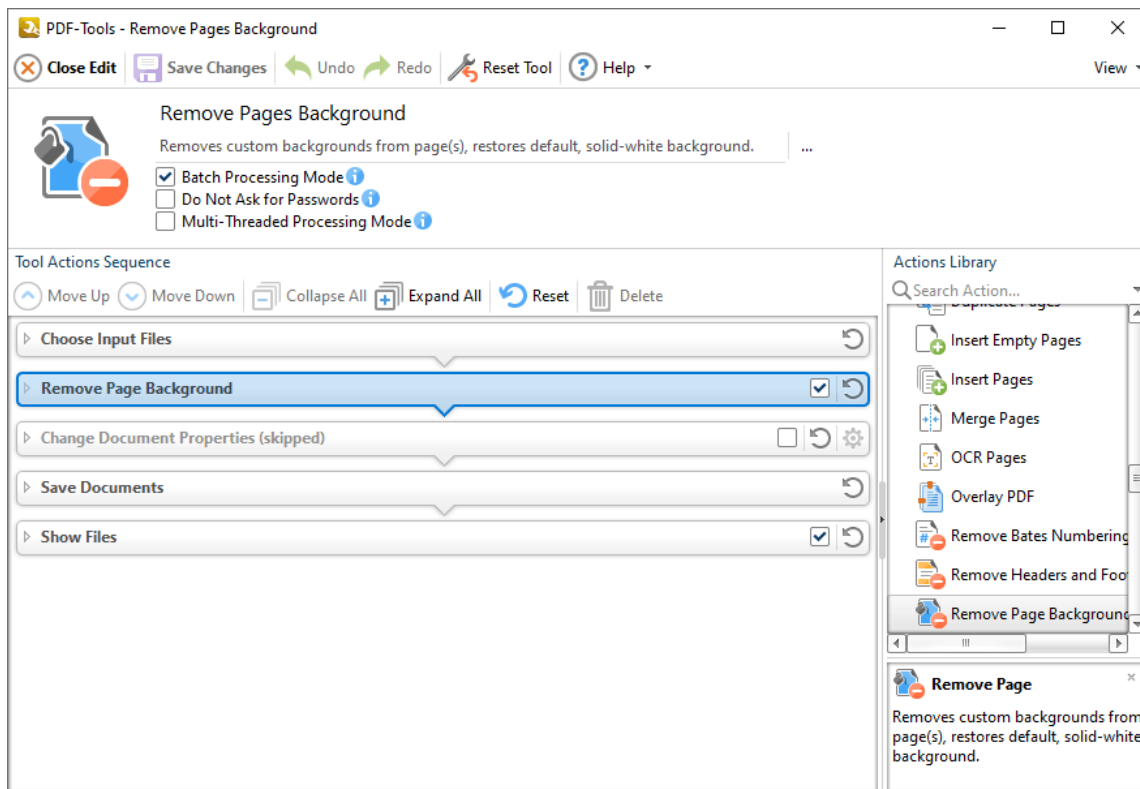







Figure 1. Remove Pages Background Tool Actions Sequence

The **Remove Pages Background** tool uses five tool actions:

1.  **Choose Input Files** <sup>[126]</sup> - the tool prompts for source documents.
2.  **Remove Pages Background** <sup>[228]</sup> - backgrounds are removed from the documents.
3.  **Change Document Properties** <sup>[292]</sup> (skipped by default) - the document properties are changed.
4.  **Save Documents** <sup>[135]</sup> - the updated documents are saved.
5.  **Show Files** <sup>[142]</sup> - the new documents are displayed in their destination folder.

Click actions to view customizable parameters. Additionally, please note that the [Clone Tool](#)<sup>[71]</sup> feature can be used to clone this tool and then add/remove actions from the **Tool Actions Sequence**.

Information about the **Batch Processing Mode**, **Do Not Ask for Passwords** and **Multi-Threaded Processing** check boxes is available [here](#).<sup>[57]</sup>

---

## 8.2.15 Remove Watermarks



## Remove Watermarks

The **Remove Watermarks** tool removes watermarks from input documents:

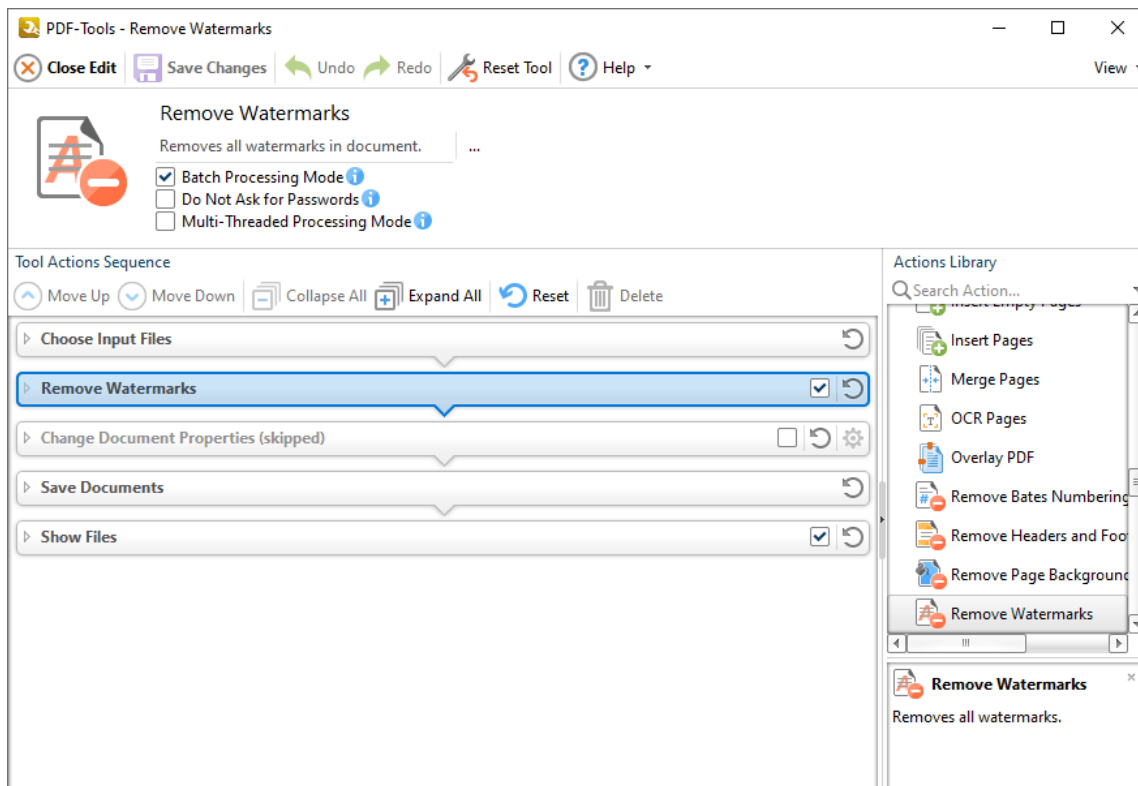







Figure 1. Remove Watermarks Tool Actions Sequence

The **Remove Watermarks** tool uses five tool actions:

1.  **Choose Input Files** <sup>[126]</sup> - the tool prompts for source documents.
2.  **Remove Watermarks** <sup>[229]</sup> - watermarks are removed from the documents.
3.  **Change Document Properties** <sup>[292]</sup> (skipped by default) - the document properties are changed.
4.  **Save Documents** <sup>[135]</sup> - the updated documents are saved.
5.  **Show Files** <sup>[142]</sup> - the new documents are displayed in their destination folder.

Click actions to view customizable parameters. Additionally, please note that the [Clone Tool](#)<sup>[71]</sup> feature can be used to clone this tool and then add/remove actions from the **Tool Actions Sequence**.

Information about the **Batch Processing Mode, Do Not Ask for Passwords** and **Multi-Threaded Processing** check boxes is available [here](#).<sup>[57]</sup>

---



## 8.2.16 Replace Pages



The **Replace Pages** tool replaces specified pages of input documents with pages from existing documents:

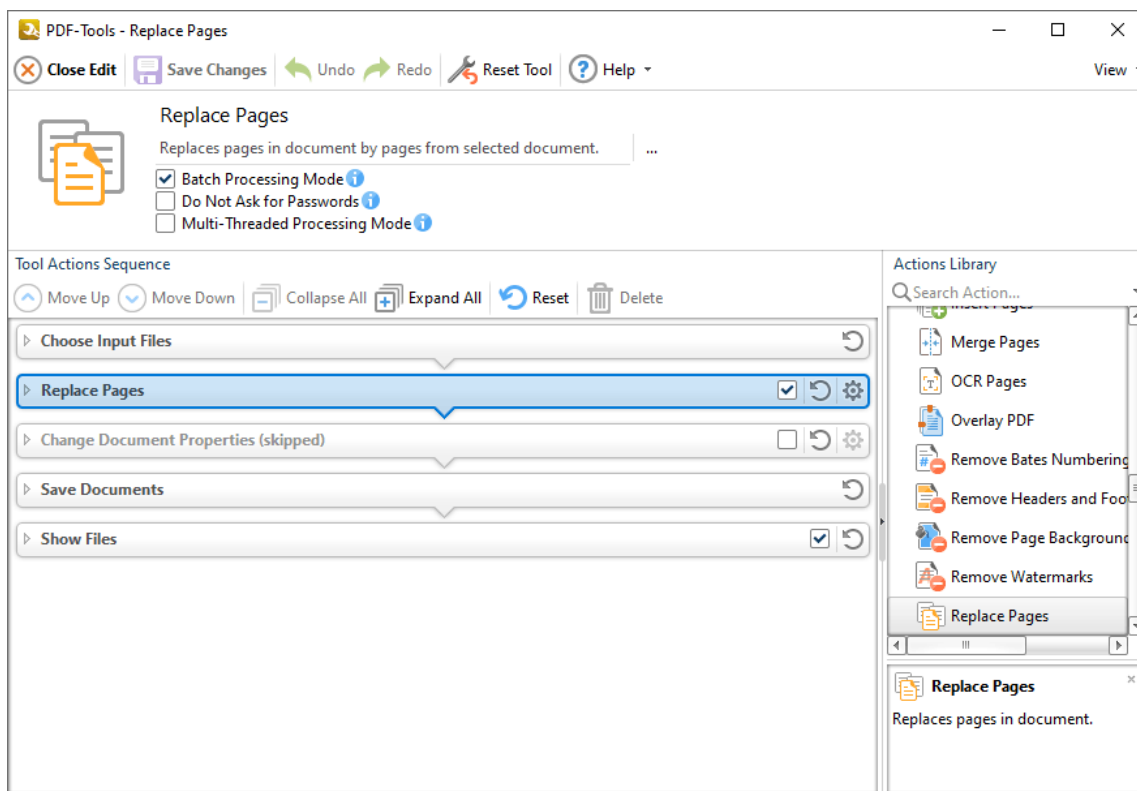







Figure 1. Replace Pages Tool Actions Sequence

The **Replace Pages** tool uses five tool actions:

1.  **Choose Input Files** <sup>[128]</sup> - the tool prompts for source documents.
2.  **Replace Pages** <sup>[230]</sup> - specified document pages are replaced with pages from existing documents.
3.  **Change Document Properties** <sup>[292]</sup> (skipped by default) - the document properties are changed.
4.  **Save Documents** <sup>[135]</sup> - the updated documents are saved.

5.  [Show Files](#)<sup>[142]</sup> - the new documents are displayed in their destination folder.

Click actions to view customizable parameters. Additionally, please note that the [Clone Tool](#)<sup>[71]</sup> feature can be used to clone this tool and then add/remove actions from the **Tool Actions Sequence**.

Information about the **Batch Processing Mode**, **Do Not Ask for Passwords** and **Multi-Threaded Processing** check boxes is available [here](#).<sup>[57]</sup>

---

## 8.2.17 Resize Pages



The **Resize Pages** tool resizes specified pages of input documents:

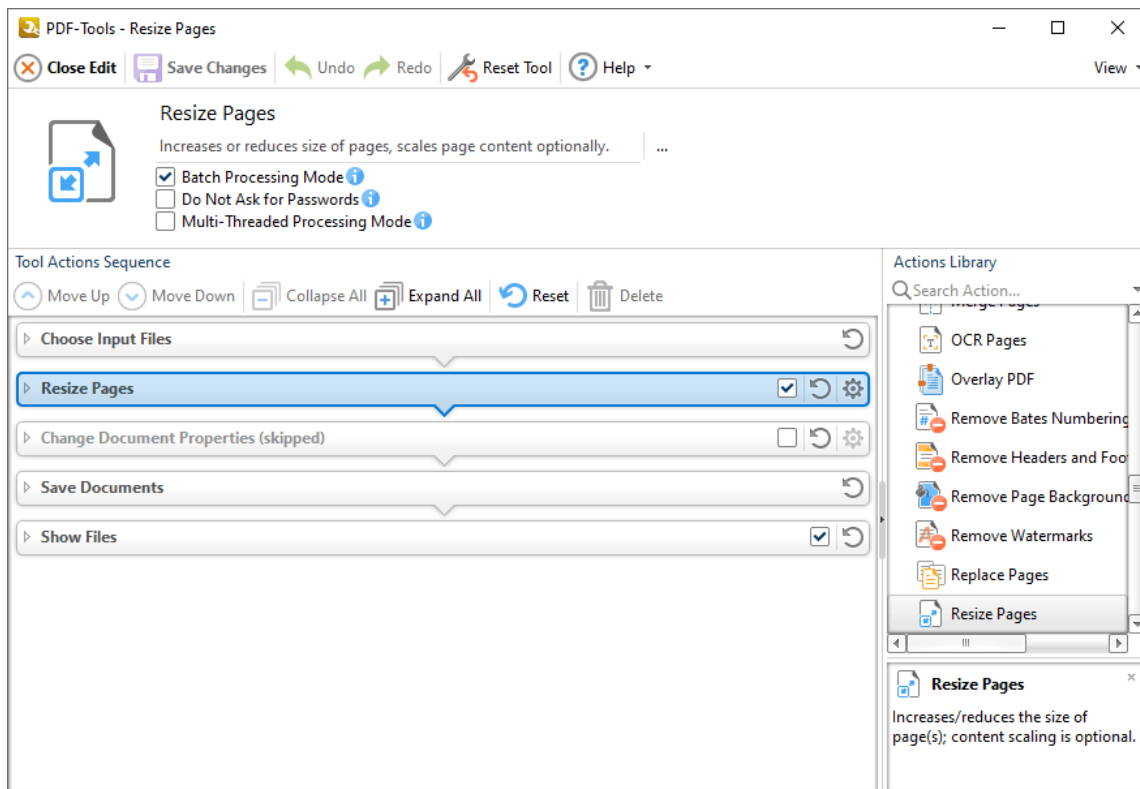







Figure 1. Resize Pages Tool Actions Sequence

The **Resize Pages** tool uses five tool actions:

1.  **Choose Input Files** <sup>[126]</sup> - the tool prompts for source documents.
2.  **Resize Pages** <sup>[232]</sup> - specified document pages are resized.
3.  **Change Document Properties** <sup>[292]</sup> (skipped by default) - the document properties are changed.
4.  **Save Documents** <sup>[135]</sup> - the updated documents are saved.
5.  **Show Files** <sup>[142]</sup> - the new documents are displayed in their destination folder.

Click actions to view customizable parameters. Additionally, please note that the [Clone Tool](#)<sup>[71]</sup> feature can be used to clone this tool and then add/remove actions from the **Tool Actions Sequence**.

Information about the **Batch Processing Mode, Do Not Ask for Passwords** and **Multi-Threaded Processing** check boxes is available [here](#).<sup>[57]</sup>

---

## 8.2.18 Rotate Pages



## Rotate Pages

The **Rotate Pages** tool rotates specified pages of input documents:

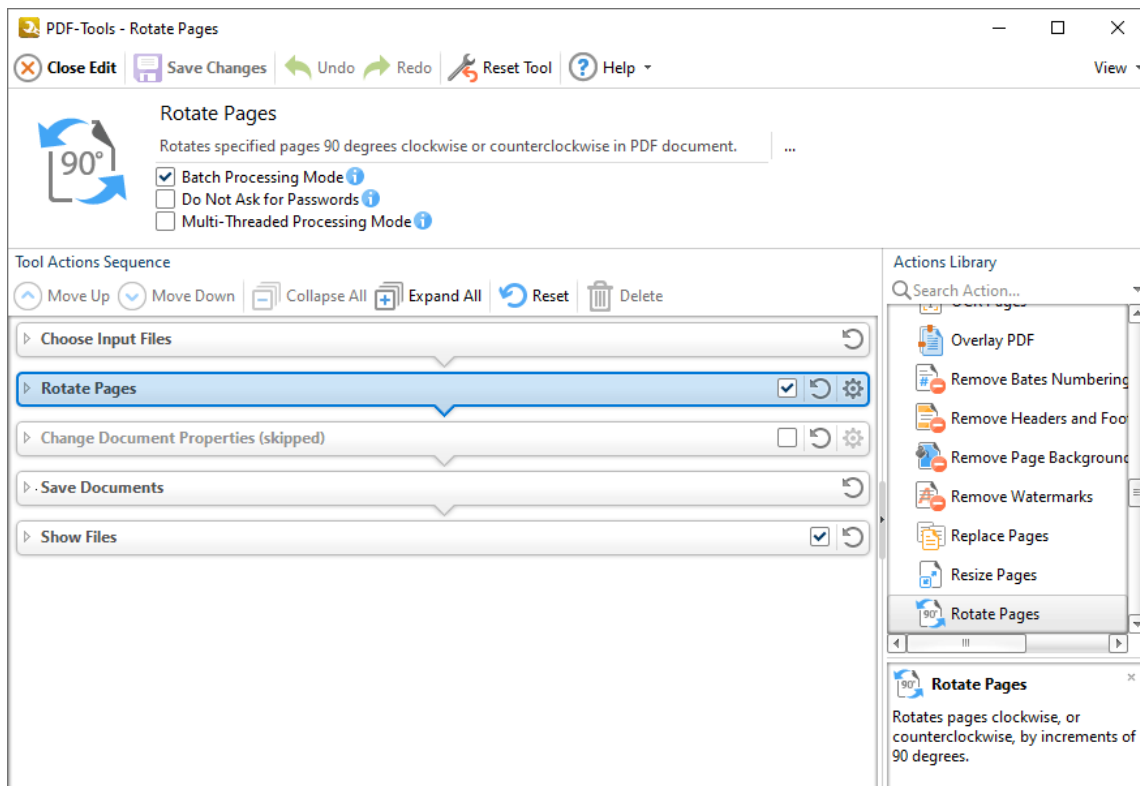







Figure 1. Rotate Pages Tool Actions Sequence

The **Rotate Pages** tool uses five tool actions:

1.  **Choose Input Files** <sup>[126]</sup> - the tool prompts for source documents.
2.  **Rotate Pages** <sup>[235]</sup> - specified document pages are rotated.
3.  **Change Document Properties** <sup>[292]</sup> (skipped by default) - the document properties are changed.
4.  **Save Documents** <sup>[135]</sup> - the updated documents are saved.
5.  **Show Files** <sup>[142]</sup> - the new documents are displayed in their destination folder.

Click actions to view customizable parameters. Additionally, please note that the [Clone Tool](#)<sup>[71]</sup> feature can be used to clone this tool and then add/remove actions from the **Tool Actions Sequence**.

Information about the **Batch Processing Mode, Do Not Ask for Passwords** and **Multi-Threaded Processing** check boxes is available [here](#).<sup>[57]</sup>

---

## 8.2.19 Set Page Transitions



The **Set Page Transitions** tool determines the animated effect when moving between document pages in fullscreen mode:

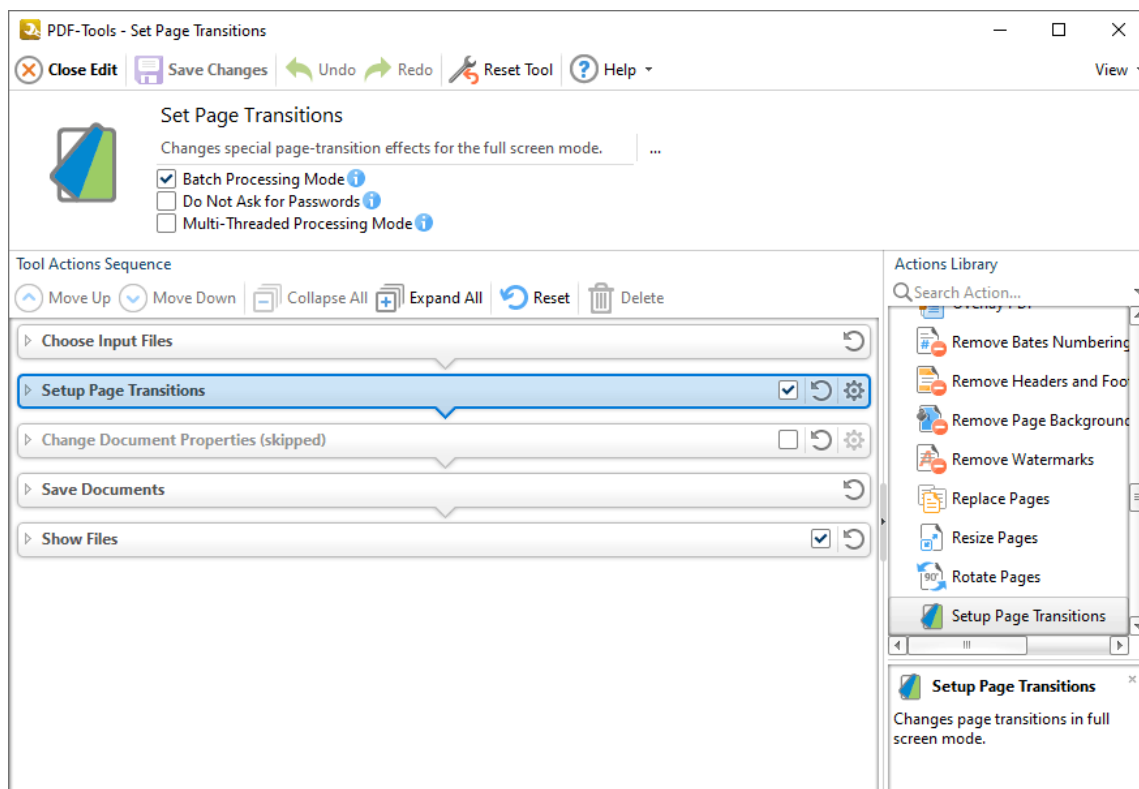







Figure 1. Set Page Transitions Tool Actions Sequence

The **Set Page Transitions** tool uses five tool actions:

1.  **Choose Input Files** <sup>[128]</sup> - the tool prompts for source documents.
2.  **Setup Page Transitions** <sup>[237]</sup> - page transitions are determined for the documents.
3.  **Change Document Properties** <sup>[292]</sup> (skipped by default) - the document properties are changed.
4.  **Save Documents** <sup>[135]</sup> - the updated documents are saved.

5.  [Show Files](#)<sup>[142]</sup> - the new documents are displayed in their destination folder.

Click actions to view customizable parameters. Additionally, please note that the [Clone Tool](#)<sup>[71]</sup> feature can be used to clone this tool and then add/remove actions from the **Tool Actions Sequence**.

Information about the **Batch Processing Mode**, **Do Not Ask for Passwords** and **Multi-Threaded Processing** check boxes is available [here](#).<sup>[57]</sup>

---



8.2.20 Set Pages Background

 **Set Pages Background**

The **Set Pages Background** tool changes the background of input documents:

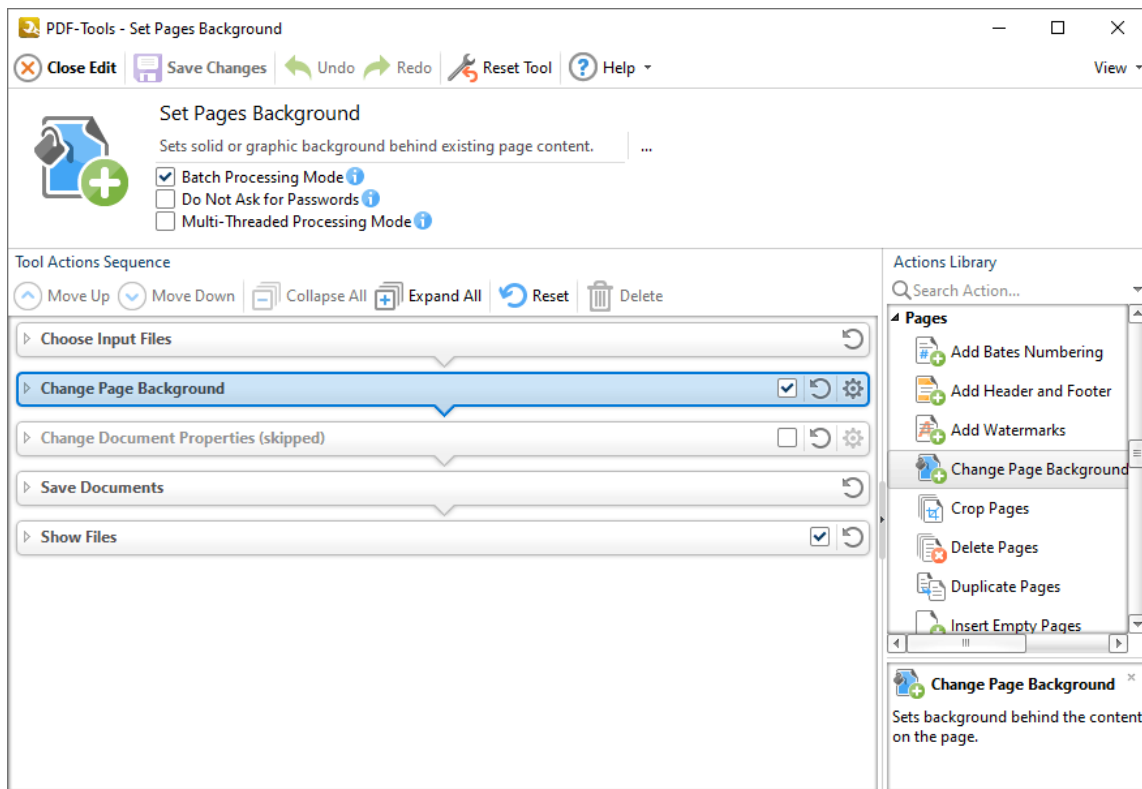







Figure 1. Set Pages Background Tool Actions Sequence

The **Set Pages Background** tool uses five tool actions:

1.  **Choose Input Files** <sup>[126]</sup> - the tool prompts for source documents.
2.  **Change Page Background** <sup>[200]</sup> - backgrounds are added/edited for the documents.
3.  **Change Document Properties** <sup>[292]</sup> (skipped by default) - the document properties are changed.
4.  **Save Documents** <sup>[135]</sup> - the updated documents are saved.
5.  **Show Files** <sup>[142]</sup> - the new documents are displayed in their destination folder.

Click actions to view customizable parameters. Additionally, please note that the [Clone Tool](#)<sup>[71]</sup> feature can be used to clone this tool and then add/remove actions from the **Tool Actions Sequence**.

Information about the **Batch Processing Mode**, **Do Not Ask for Passwords** and **Multi-Threaded Processing** check boxes is available [here](#).<sup>[57]</sup>

---

## 8.2.21 Split Pages



## Split Pages

The **Split Pages** tool splits the pages of input documents into custom sections:

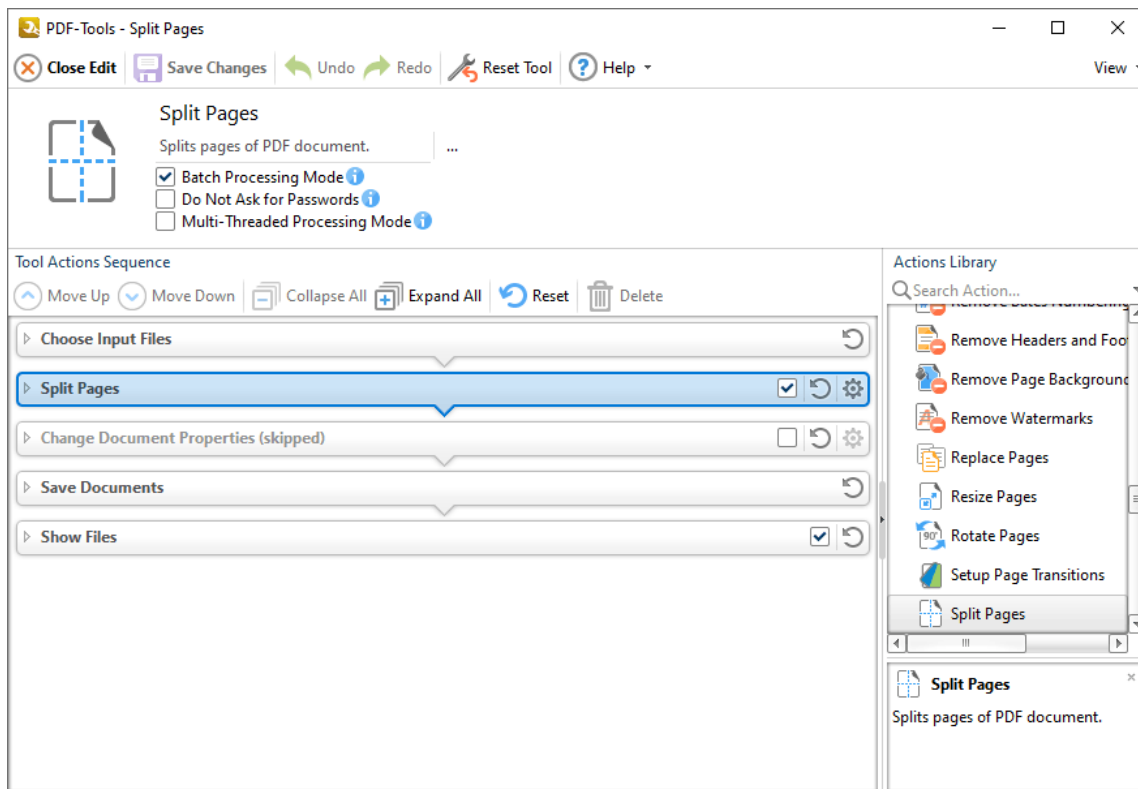







Figure 1. Split Pages Tool Actions Sequence

The **Split Pages** tool uses five tool actions:

1.  **Choose Input Files** <sup>[126]</sup> - the tool prompts for source documents.
2.  **Split Pages** <sup>[239]</sup> - the documents are split into custom sections.
3.  **Change Document Properties** <sup>[292]</sup> (skipped by default) - the document properties are changed.
4.  **Save Documents** <sup>[135]</sup> - the updated documents are saved.
5.  **Show Files** <sup>[142]</sup> - the new documents are displayed in their destination folder.

Click actions to view customizable parameters. Additionally, please note that the [Clone Tool](#)<sup>[71]</sup> feature can be used to clone this tool and then add/remove actions from the **Tool Actions Sequence**.

Information about the **Batch Processing Mode, Do Not Ask for Passwords** and **Multi-Threaded Processing** check boxes is available [here](#).<sup>[57]</sup>

---

### 8.3 Links Tools

---



#### Links Tools

---

The **Links** tools are used to create/delete links and weblinks:

 **Create Weblinks** <sup>[374]</sup> creates weblinks from the text of input documents:

 **Delete Links** <sup>[376]</sup> deletes weblinks from input documents:

 **Delete Weblinks** <sup>[378]</sup> deletes weblinks from input documents:

Note that the **Clone Tool** <sup>[71]</sup> and **Create Tool** <sup>[65]</sup> features can be used to enhance the functionality of existing tools/create new tools in order to meet complex requirements.

---

## 8.3.1 Create Weblinks



## Create Weblinks

The **Create Weblinks** tool creates weblinks from the text of input documents:

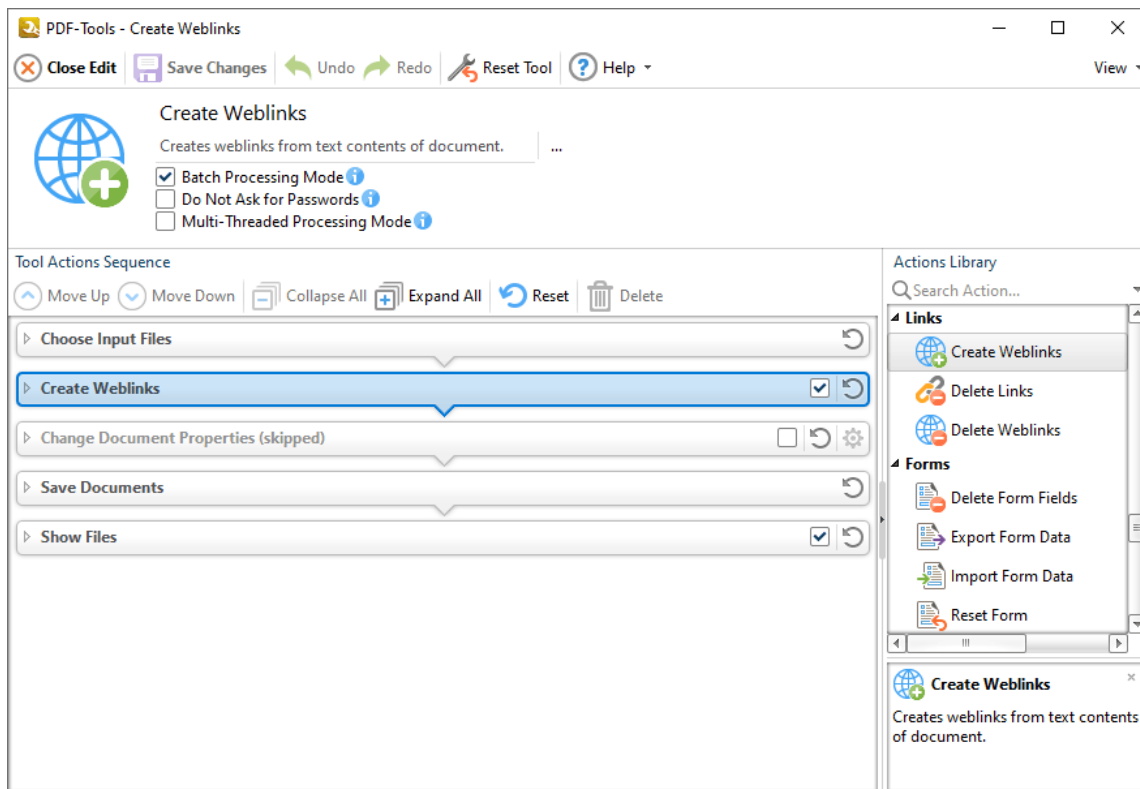







Figure 1. Create Weblinks Tool Actions Sequence

The **Create Weblinks** tool uses five tool actions:

1.  **Choose Input Files** <sup>[126]</sup> - the tool prompts for source documents.
2.  **Create Weblinks** <sup>[243]</sup> - weblinks are created from specified text in the documents.
3.  **Change Document Properties** <sup>[292]</sup> (skipped by default) - the document properties are changed.
4.  **Save Documents** <sup>[135]</sup> - the updated documents are saved.
5.  **Show Files** <sup>[142]</sup> - the new documents are displayed in their destination folder.

Click actions to view customizable parameters. Additionally, please note that the [Clone Tool](#)<sup>[71]</sup> feature can be used to clone this tool and then add/remove actions from the **Tool Actions Sequence**.

Information about the **Batch Processing Mode**, **Do Not Ask for Passwords** and **Multi-Threaded Processing** check boxes is available [here](#).<sup>[57]</sup>

---

## 8.3.2 Delete Links



## Delete Links

The **Delete Links** tool deletes links from input documents:

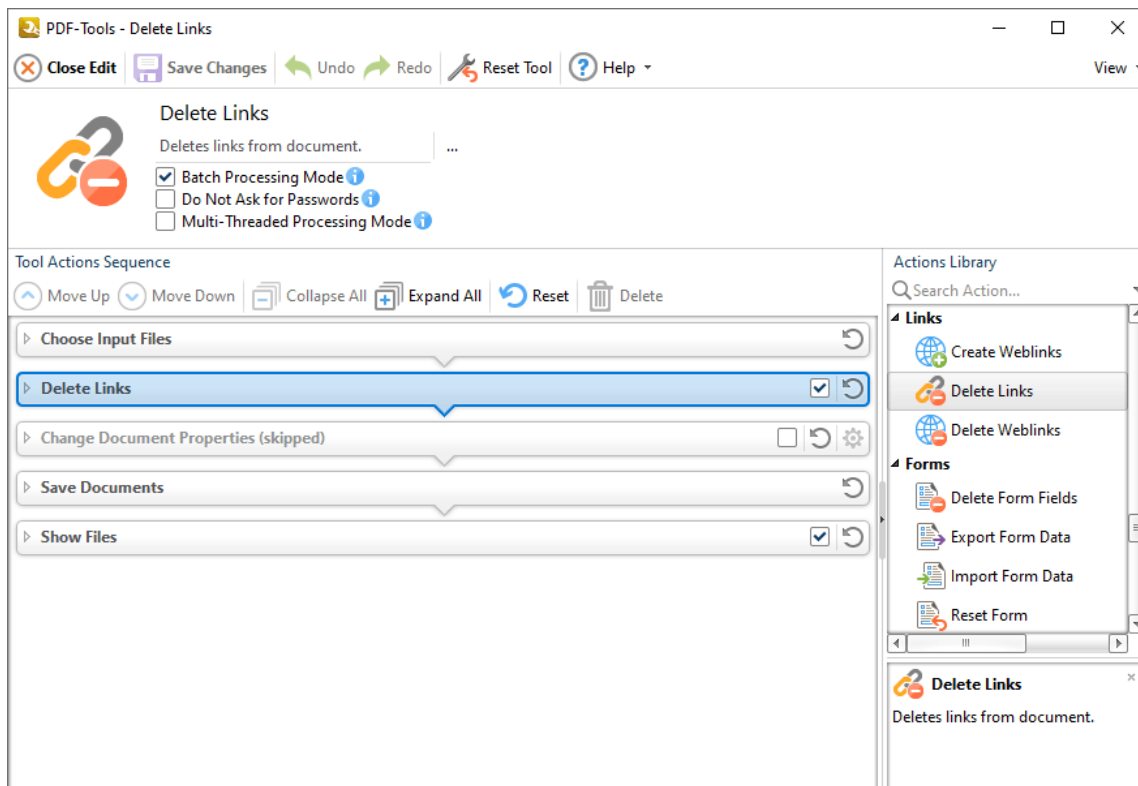

Figure 1. Delete Links Tool Actions Sequence

The **Delete Links** tool uses five tool actions:

1. **Choose Input Files** <sup>[126]</sup> - the tool prompts for source documents.
2. **Delete Links** <sup>[245]</sup> - all links are deleted from specified pages in the documents.
3. **Change Document Properties** <sup>[292]</sup> (skipped by default) - the document properties are changed.
4. **Save Documents** <sup>[135]</sup> - the updated documents are saved.
5. **Show Files** <sup>[142]</sup> - the new documents are displayed in their destination folder.



Click actions to view customizable parameters. Additionally, please note that the [Clone Tool](#)<sup>[71]</sup> feature can be used to clone this tool and then add/remove actions from the **Tool Actions Sequence**.

Information about the **Batch Processing Mode, Do Not Ask for Passwords** and **Multi-Threaded Processing** check boxes is available [here](#).<sup>[57]</sup>

---

## 8.3.3 Delete Weblinks



## Delete Weblinks

The **Delete Weblinks** tool deletes weblinks from input documents:

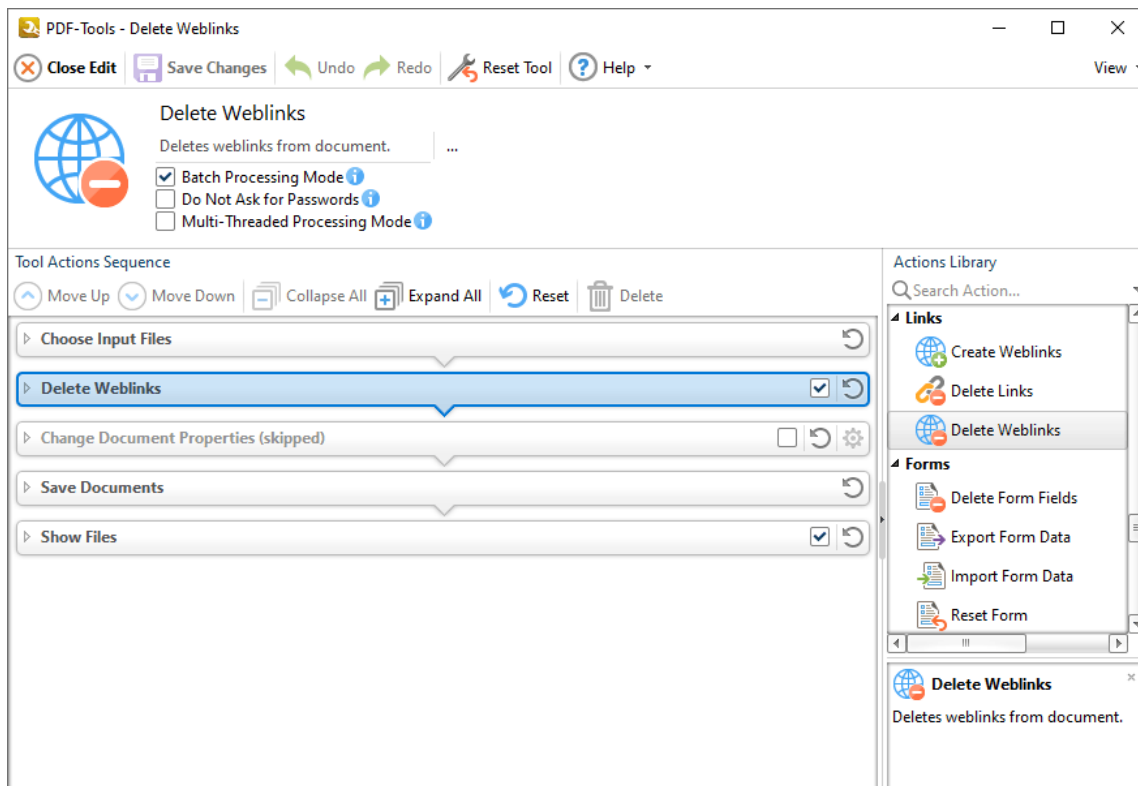







Figure 1. Delete Weblinks Tool Actions Sequence

The **Delete Weblinks** tool uses five tool actions:

1.  **Choose Input Files** <sup>[126]</sup> - the tool prompts for source documents.
2.  **Delete Weblinks** <sup>[247]</sup> - all weblinks are deleted from specified pages in the documents.
3.  **Change Document Properties** <sup>[292]</sup> (skipped by default) - the document properties are changed.
4.  **Save Documents** <sup>[135]</sup> - the updated documents are saved.
5.  **Show Files** <sup>[142]</sup> - the new documents are displayed in their destination folder.

Click actions to view customizable parameters. Additionally, please note that the [Clone Tool](#)<sup>[71]</sup> feature can be used to clone this tool and then add/remove actions from the **Tool Actions Sequence**.

Information about the **Batch Processing Mode**, **Do Not Ask for Passwords** and **Multi-Threaded Processing** check boxes is available [here](#).<sup>[57]</sup>

---

## 8.4 Forms Tools





---



### Forms Tools

---

The **Forms** tools are used to import/export or delete forms and form data:

-  [Delete Form Fields](#)<sup>[387]</sup> deletes form fields from input documents:
-  [Export Form Data](#)<sup>[252]</sup> exports form data from documents to a file.
-  [Import Form Data](#)<sup>[254]</sup> imports form data from a file.
-  [Reset Forms](#)<sup>[387]</sup> removes all form data from input documents.

Note that the [Clone Tool](#)<sup>[71]</sup> and [Create Tool](#)<sup>[65]</sup> features can be used to enhance the functionality of existing tools/create new tools in order to meet complex requirements.

---

### 8.4.1 Delete Form Fields



The **Delete Form Fields** tool deletes form fields from input documents:

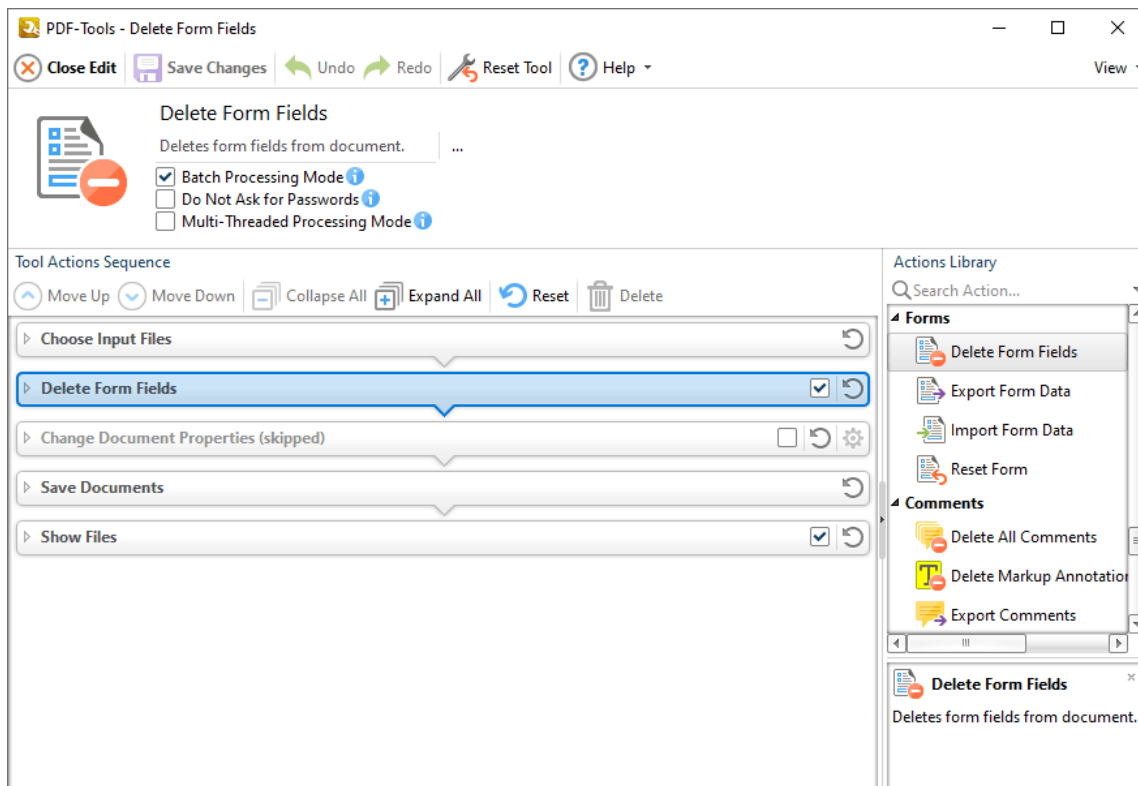

Figure 1. Delete Form Fields Tool Actions Sequence

The **Delete Form Fields** tool uses five tool actions:

1. **Choose Input Files** <sup>[126]</sup> - the tool prompts for source documents.
2. **Delete Form Fields** <sup>[250]</sup> - all form fields are deleted from specified pages in the documents.
3. **Change Document Properties** <sup>[292]</sup> (skipped by default) - the document properties are changed.
4. **Save Documents** <sup>[135]</sup> - the updated documents are saved.
5. **Show Files** <sup>[142]</sup> - the new documents are displayed in their destination folder.

Click actions to view customizable parameters. Additionally, please note that the [Clone Tool](#)<sup>[71]</sup> feature can be used to clone this tool and then add/remove actions from the **Tool Actions Sequence**.

Information about the **Batch Processing Mode**, **Do Not Ask for Passwords** and **Multi-Threaded Processing** check boxes is available [here](#).<sup>[57]</sup>

---

## 8.4.2 Export Form Data



The **Export Form Data** tool exports form data from documents to file:

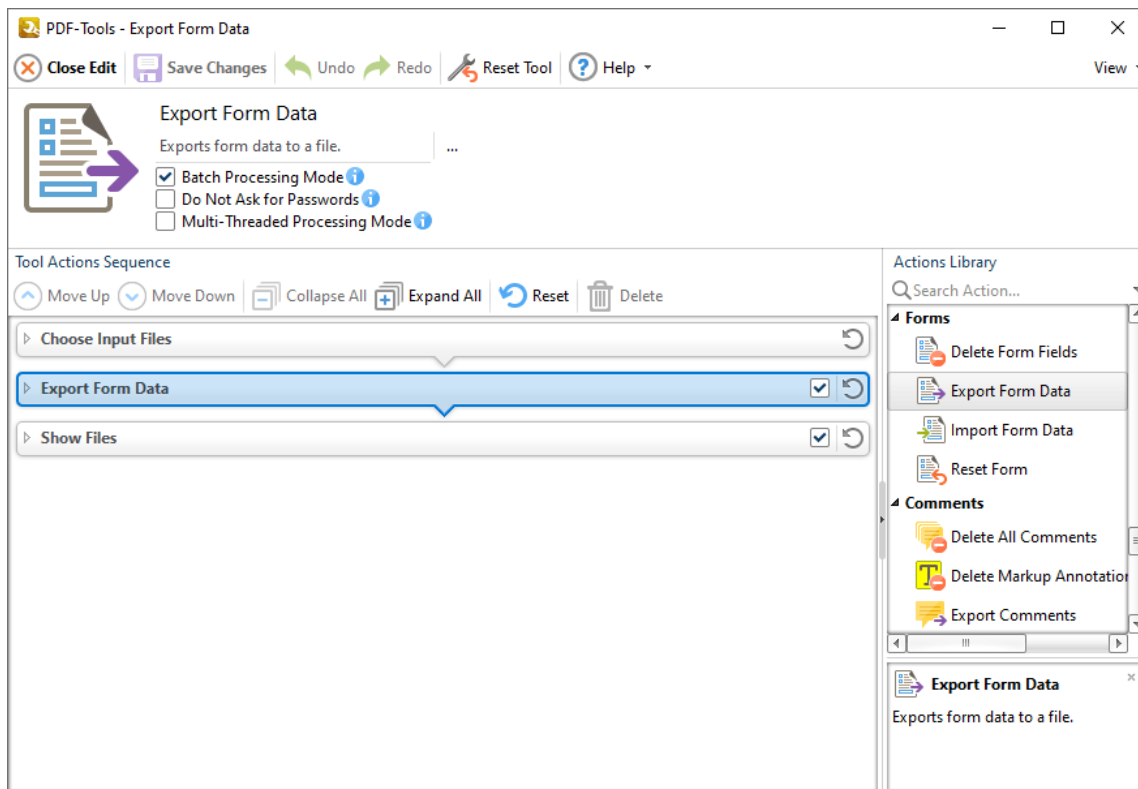





Figure 1. Export Form Data Tool Actions Sequence

The **Export Form Data** tool uses three tool actions:

1.  **Choose Input Files** <sup>[126]</sup> - the tool prompts for source documents.
2.  **Export Form Data** <sup>[252]</sup> - form data from the documents is exported.
3.  **Show Files** <sup>[142]</sup> - the file that contains the exported form data is highlighted in its folder.

Click actions to view customizable parameters. Additionally, please note that the **Clone Tool** <sup>[71]</sup> feature can be used to clone this tool and then add/remove actions from the **Tool Actions Sequence**.

Information about the **Batch Processing Mode, Do Not Ask for Passwords** and **Multi-Threaded Processing** check boxes is available [here](#).<sup>[57]</sup>

---



## 8.4.3 Import Form Data



The **Import Form Data** tool imports form data into documents:

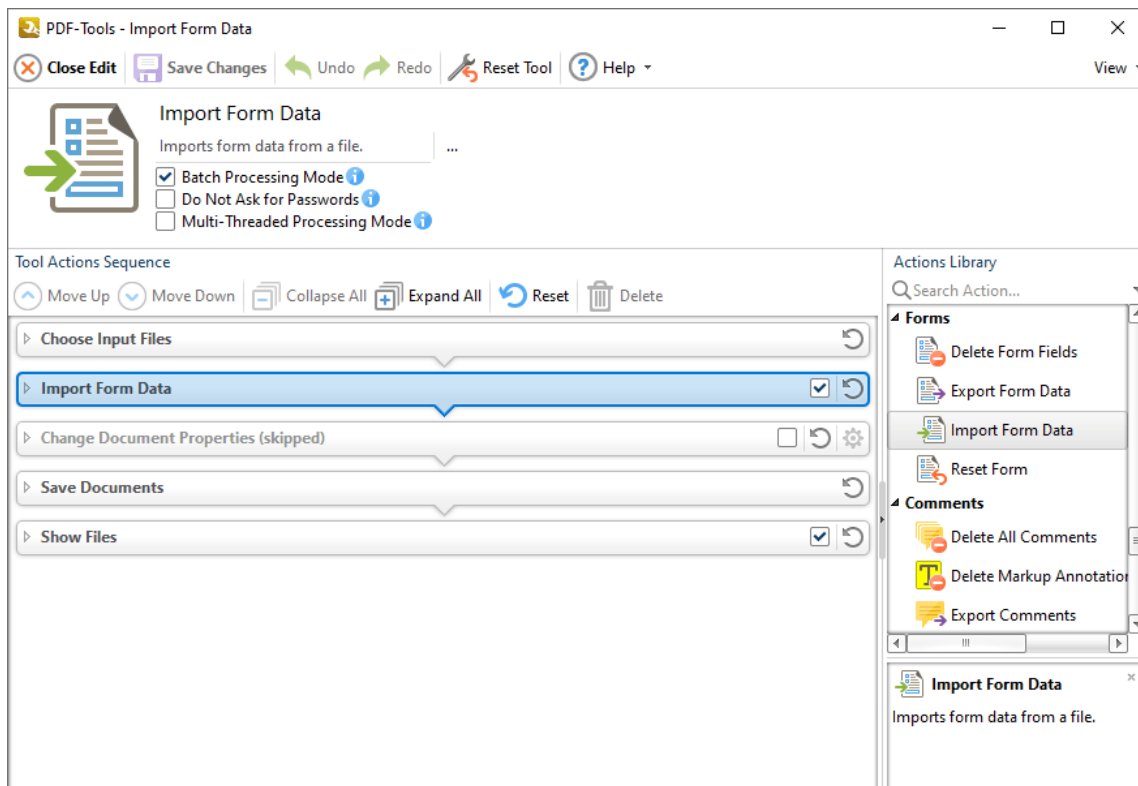







Figure 1. Import Form Tool Actions Sequence

The **Import Form** tool uses five tool actions:

1.  **Choose Input Files** <sup>[128]</sup> - the tool prompts for source documents.
2.  **Import Form Data** <sup>[254]</sup> - form data is imported into the documents.
3.  **Change Document Properties** <sup>[292]</sup> (skipped by default) - the document properties are changed.
4.  **Save Documents** <sup>[135]</sup> - the updated documents are saved.
5.  **Show Files** <sup>[142]</sup> - the new documents are displayed in their destination folder.

Click actions to view customizable parameters. Additionally, please note that the [Clone Tool](#)<sup>[71]</sup> feature can be used to clone this tool and then add/remove actions from the **Tool Actions Sequence**.

Information about the **Batch Processing Mode, Do Not Ask for Passwords** and **Multi-Threaded Processing** check boxes is available [here](#).<sup>[57]</sup>

---

## 8.4.4 Reset Forms



The **Reset Forms** tool resets form data in documents:

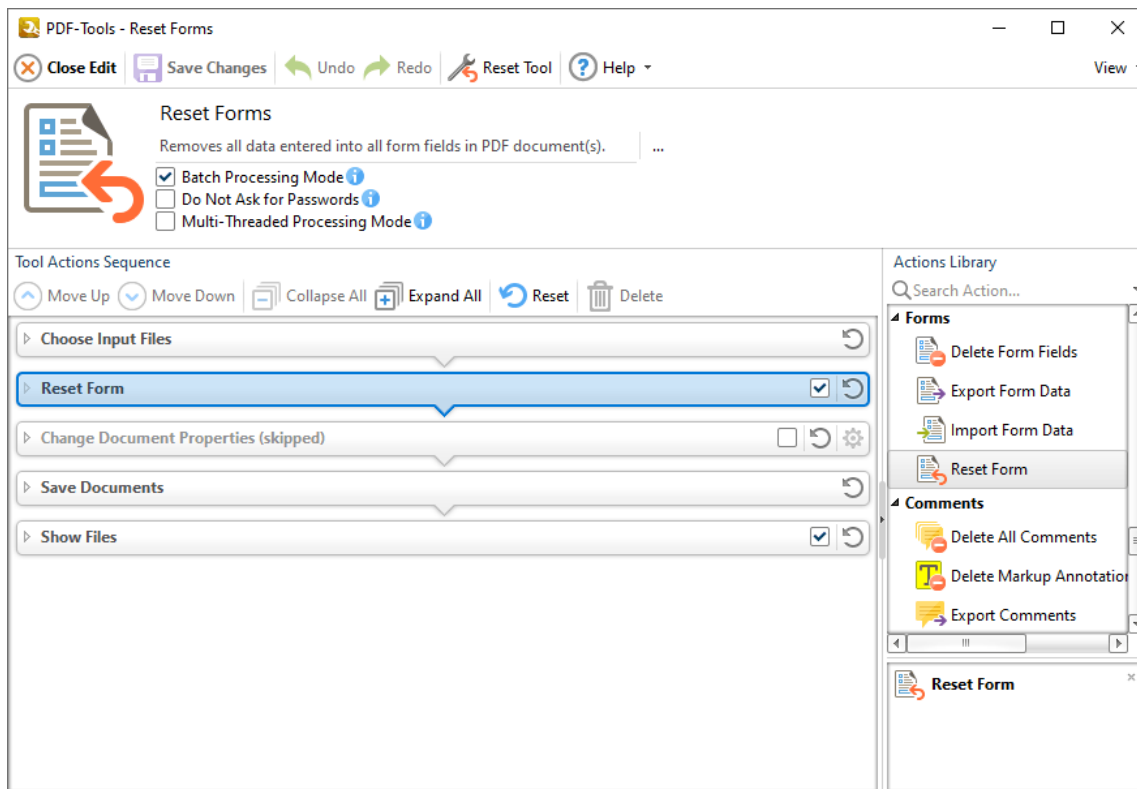







Figure 1. Reset Forms Tool Actions Sequence

The **Reset Forms** tool uses five tool actions:

1.  **Choose Input Files** <sup>[126]</sup> - the tool prompts for source documents.
2.  **Reset Form** <sup>[256]</sup> - form data in the documents is reset.
3.  **Change Document Properties** <sup>[292]</sup> (skipped by default) - the document properties are changed.
4.  **Save Documents** <sup>[135]</sup> - the updated documents are saved.
5.  **Show Files** <sup>[142]</sup> - the new documents are displayed in their destination folder.

Click actions to view customizable parameters. Additionally, please note that the [Clone Tool](#)<sup>[71]</sup> feature can be used to clone this tool and then add/remove actions from the **Tool Actions Sequence**.

Information about the **Batch Processing Mode, Do Not Ask for Passwords** and **Multi-Threaded Processing** check boxes is available [here](#).<sup>[57]</sup>

---

## 8.5 Comments Tools







---



### Comments Tools

---

The **Comments** tools are used to edit and manipulate the comments of input documents:

-  [Delete All Comments](#)<sup>[390]</sup> deletes comments of all formats from input documents.
-  [Delete Markup Annotations](#)<sup>[392]</sup> deletes markup annotations from input documents.
-  [Export Comments](#)<sup>[394]</sup> exports comments from input documents.
-  [Flatten Comments and Fields](#)<sup>[396]</sup> flattens comments and form fields in input documents.
-  [Import Comments](#)<sup>[398]</sup> imports comments into input documents.
-  [Summarize Comments](#)<sup>[400]</sup> creates a summary of the comments in input documents.

Note that the [Clone Tool](#)<sup>[71]</sup> and [Create Tool](#)<sup>[65]</sup> features can be used to enhance the functionality of existing tools/create new tools in order to meet complex requirements.

---

## 8.5.1 Delete All Comments



## Delete All Comments

The **Delete All Comments** tool deletes comments from input documents:

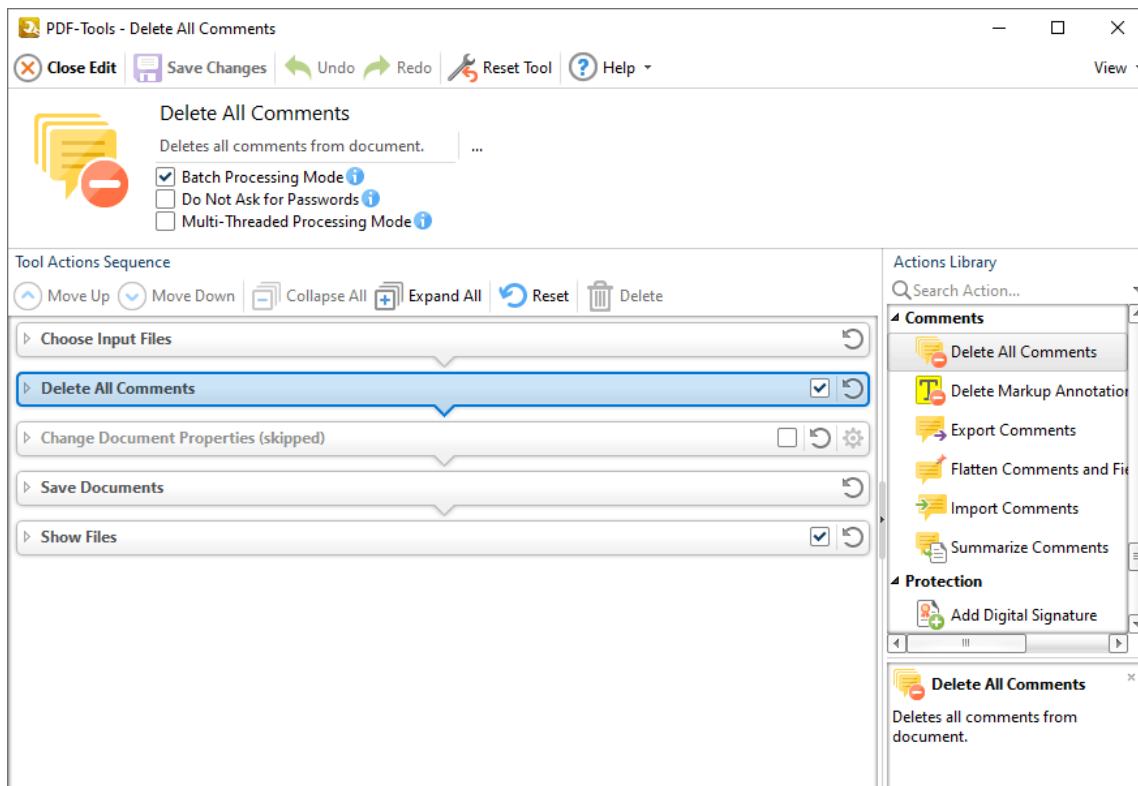







Figure 1. Delete All Comments Tool Actions Sequence

The **Delete All Comments** tool uses five tool actions:

1.  **Choose Input Files** <sup>[126]</sup> - the tool prompts for source documents.
2.  **Delete All Comments** <sup>[258]</sup> - all comments are deleted from specified pages in the documents.
3.  **Change Document Properties** <sup>[292]</sup> (skipped by default) - the document properties are changed.
4.  **Save Documents** <sup>[135]</sup> - the updated documents are saved.
5.  **Show Files** <sup>[142]</sup> - the new documents are displayed in their destination folder.

Click actions to view customizable parameters. Additionally, please note that the [Clone Tool](#)<sup>[71]</sup> feature can be used to clone this tool and then add/remove actions from the **Tool Actions Sequence**.

Information about the **Batch Processing Mode**, **Do Not Ask for Passwords** and **Multi-Threaded Processing** check boxes is available [here](#).<sup>[57]</sup>

---

## 8.5.2 Delete Markup Annotations



## Delete Markup Annotations

The **Delete Markup Annotations** tool deletes markup annotations from input documents:

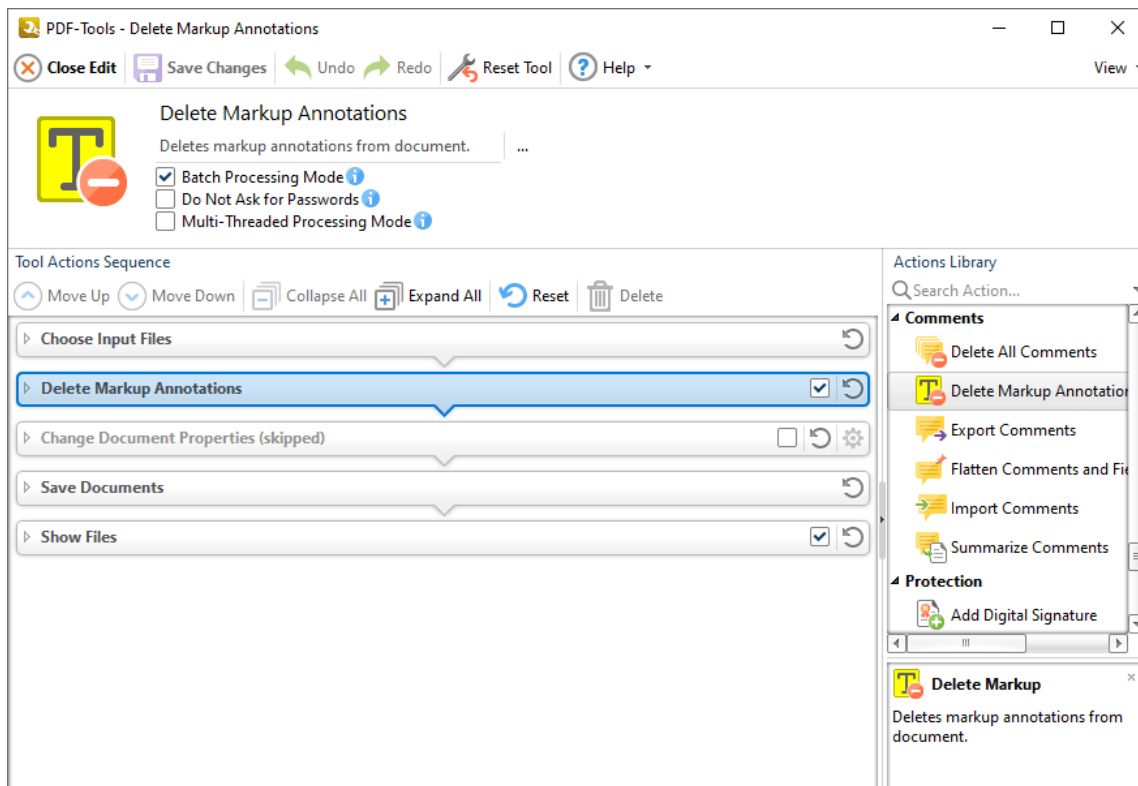







Figure 1. Delete Markup Annotations Tool Actions Sequence

The **Delete Markup Annotations** tool uses five tool actions:

1.  **Choose Input Files** <sup>[126]</sup> - the tool prompts for source documents.
2.  **Delete Markup Annotations** <sup>[260]</sup> - all markup annotations are deleted from specified pages in the documents.
3.  **Change Document Properties** <sup>[292]</sup> (skipped by default) - the document properties are changed.
4.  **Save Documents** <sup>[135]</sup> - the updated documents are saved.
5.  **Show Files** <sup>[142]</sup> - the new documents are displayed in their destination folder.



Click actions to view customizable parameters. Additionally, please note that the [Clone Tool](#)<sup>[71]</sup> feature can be used to clone this tool and then add/remove actions from the **Tool Actions Sequence**.

Information about the **Batch Processing Mode**, **Do Not Ask for Passwords** and **Multi-Threaded Processing** check boxes is available [here](#).<sup>[57]</sup>

---

## 8.5.3 Export Comments



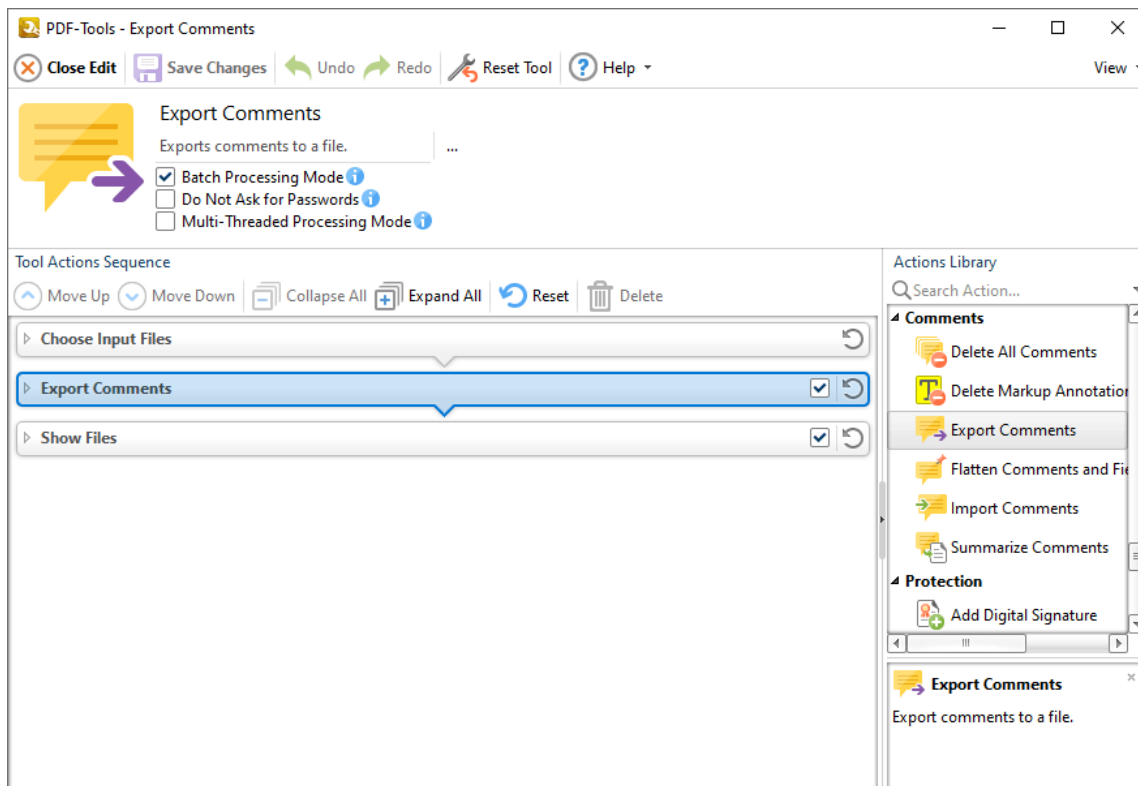

The **Export Comments** tool exports comments from input documents:



**Figure 1.** Export Comments Tool Actions Sequence

The **Export Comments** tool uses three tool actions:

1.  **Choose Input Files**<sup>[126]</sup> - the tool prompts for source documents.
2.  **Export Comments**<sup>[262]</sup> - comments are exported from the documents.
3.  **Show Files**<sup>[142]</sup> - the document that contains the exported comments is displayed in its destination folder.

Click actions to view customizable parameters. Additionally, please note that the **Clone Tool**<sup>[71]</sup> feature can be used to clone this tool and then add/remove actions from the **Tool Actions Sequence**.

Information about the **Batch Processing Mode, Do Not Ask for Passwords** and **Multi-Threaded Processing** check boxes is available [here](#).<sup>[57]</sup>

---

## 8.5.4 Flatten Comments and Fields



## Flatten Comments and Fields

The **Flatten Comments and Fields** tool flattens the comments and form fields of input documents into base content:

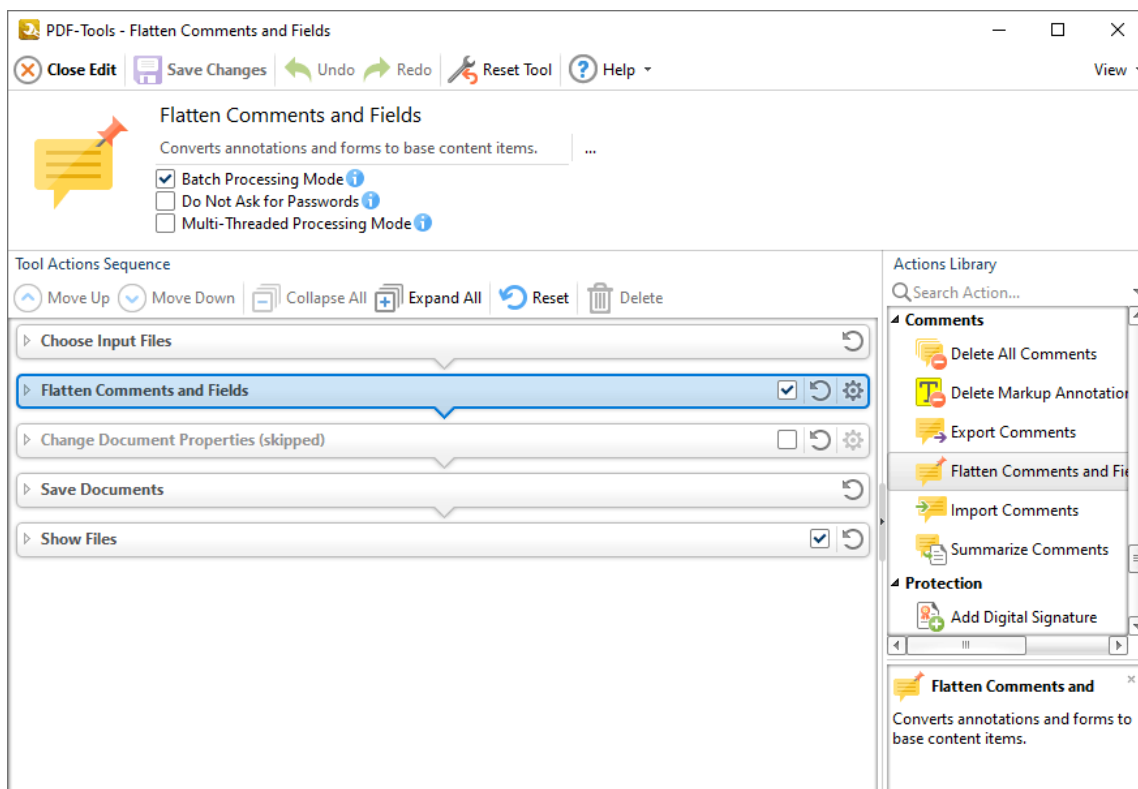







Figure 1. Flatten Comments and Fields Tool Actions Sequence

The **Flatten Comments** tool uses five tool actions:

1.  **Choose Input Files** <sup>[128]</sup> - the tool prompts for source documents.
2.  **Flatten Comments and Fields** <sup>[264]</sup> - the comments and form fields of input documents are flattened into base content.
3.  **Change Document Properties** <sup>[292]</sup> (skipped by default) - the document properties are changed.
4.  **Save Documents** <sup>[135]</sup> - the updated documents are saved.

5.  [Show Files](#)<sup>[142]</sup> - the new documents are displayed in their destination folder.

Click actions to view customizable parameters. Additionally, please note that the [Clone Tool](#)<sup>[71]</sup> feature can be used to clone this tool and then add/remove actions from the **Tool Actions Sequence**.

Information about the **Batch Processing Mode**, **Do Not Ask for Passwords** and **Multi-Threaded Processing** check boxes is available [here](#).<sup>[57]</sup>

---

## 8.5.5 Import Comments



## Import Comments

The **Import Comments** tool imports comments into input documents.:

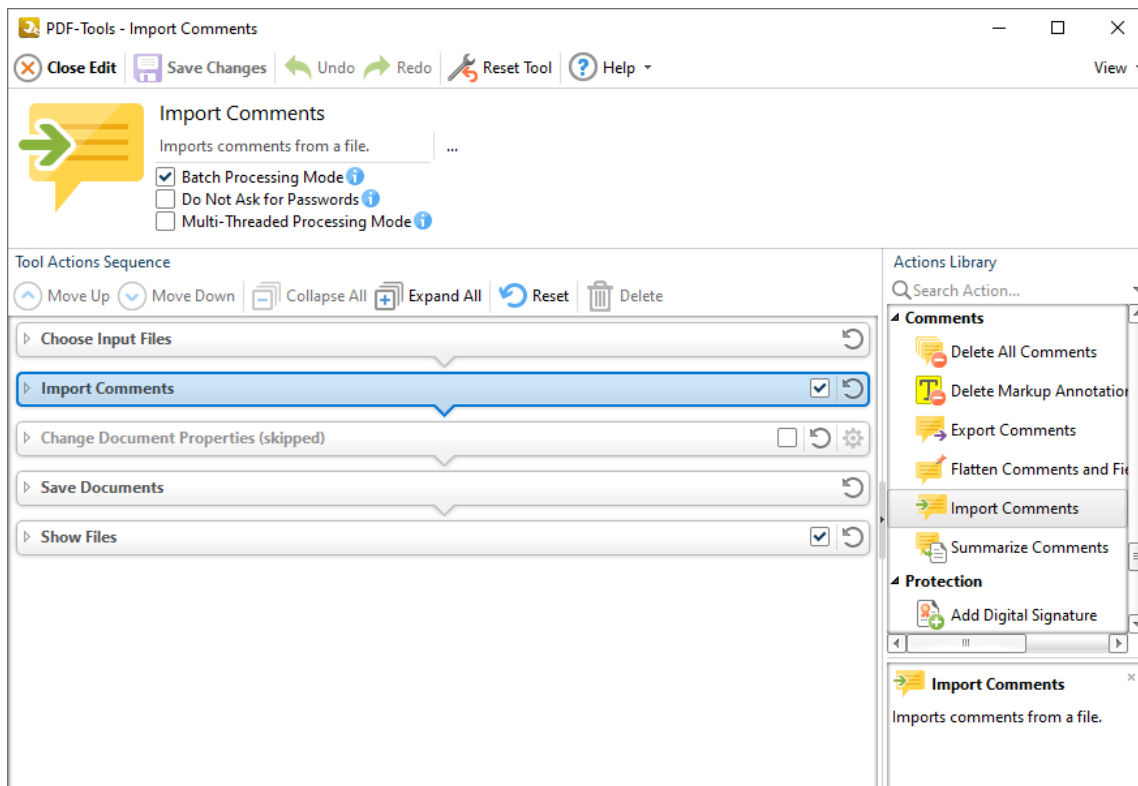







Figure 1. Import Comments Tool Actions Sequence

The **Import Comments** tool uses five tool actions:

1.  **Choose Input Files** <sup>[126]</sup> - the tool prompts for source documents.
2.  **Import Comments** <sup>[266]</sup> - comments are imported into the documents.
3.  **Change Document Properties** <sup>[292]</sup> (skipped by default) - the document properties are changed.
4.  **Save Documents** <sup>[135]</sup> - the updated documents are saved.
5.  **Show Files** <sup>[142]</sup> - the new documents are displayed in their destination folder.

Click actions to view customizable parameters. Additionally, please note that the [Clone Tool](#)<sup>[71]</sup> feature can be used to clone this tool and then add/remove actions from the **Tool Actions Sequence**.

Information about the **Batch Processing Mode, Do Not Ask for Passwords** and **Multi-Threaded Processing** check boxes is available [here](#).<sup>[57]</sup>

---

## 8.5.6 Summarize Comments



The **Summarize Comments** tool creates a summary of comments in input documents:

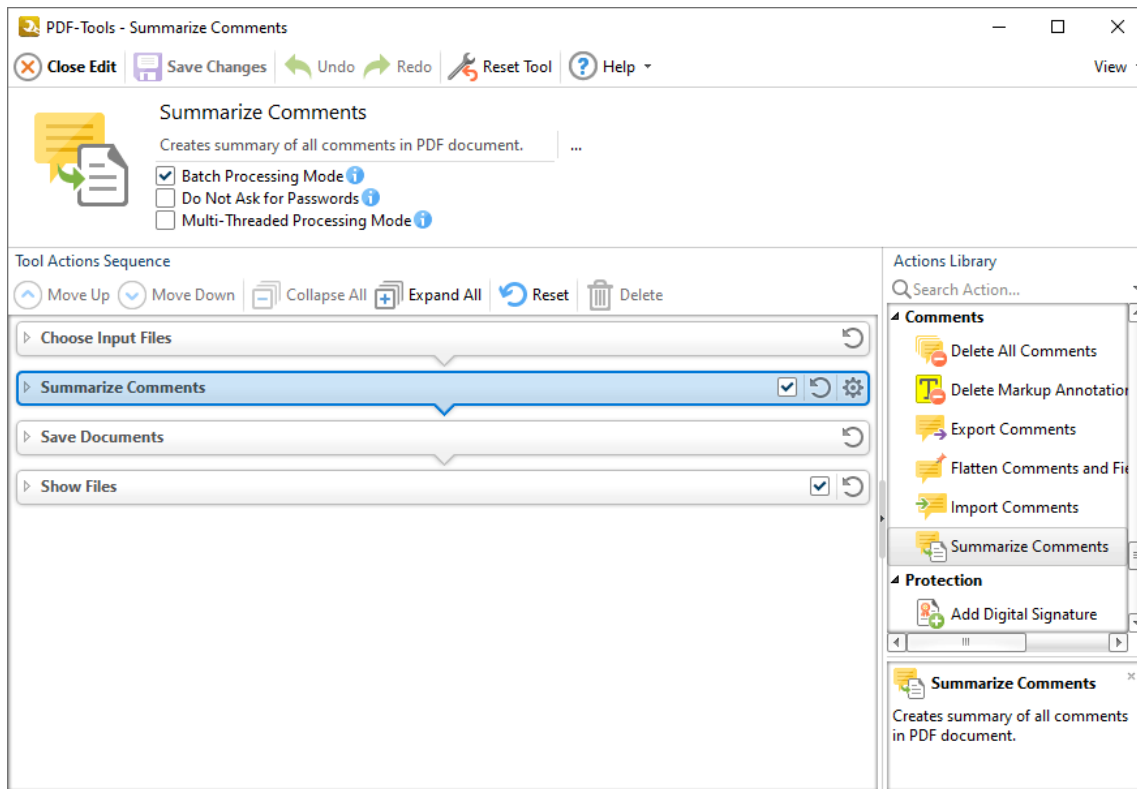





Figure 1. Summarize Comments Tool Actions Sequence

The **Flatten Comments** tool uses four tool actions:

1.  **Choose Input Files** <sup>[128]</sup> - the tool prompts for source documents.
2.  **Summarize Comments** <sup>[268]</sup> - a summary is created from document comments.
3.  **Save Documents** <sup>[135]</sup> - the updated documents are saved.
4.  **Show Files** <sup>[142]</sup> - the new documents are displayed in their destination folder.

Click actions to view customizable parameters. Additionally, please note that the **Clone Tool** <sup>[71]</sup> feature can be used to clone this tool and then add/remove actions from the **Tool Actions Sequence**.



Information about the **Batch Processing Mode**, **Do Not Ask for Passwords** and **Multi-Threaded Processing** check boxes is available [here](#).<sup>[57]</sup>

---

## 8.6 Bookmarks Tools







---



### Bookmarks Tools

---

The **Bookmarks** tools are used to create, import, export and manipulate bookmarks:

-  [Build Table of Contents](#)<sup>[403]</sup> uses bookmarks to create a table of contents for input documents.
-  [Export Bookmarks](#)<sup>[405]</sup> creates a copy of the bookmarks in input documents and then saves them to file.
-  [Export Bookmarks to Text File](#)<sup>[149]</sup> creates a copy of the bookmarks in input documents and then saves them to a plain text (\*.txt) file.
-  [Find and Replace Bookmark Text](#)<sup>[409]</sup> finds and replaces text in bookmark titles.
-  [Generate Bookmarks from Page Text](#)<sup>[411]</sup> creates bookmarks from the text of input documents.
-  [Import Bookmarks](#)<sup>[413]</sup> imports bookmarks into documents.
-  [Import Bookmarks from Text File](#)<sup>[415]</sup> imports bookmarks from a text file into documents.

Note that the [Clone Tool](#)<sup>[71]</sup> and [Create Tool](#)<sup>[65]</sup> features can be used to enhance the functionality of existing tools/create new tools in order to meet complex requirements.

---

## 8.6.1 Build Table of Contents



## Build Table of Contents

The **Build Table of Contents** tool uses bookmarks to create a table of contents for input documents:

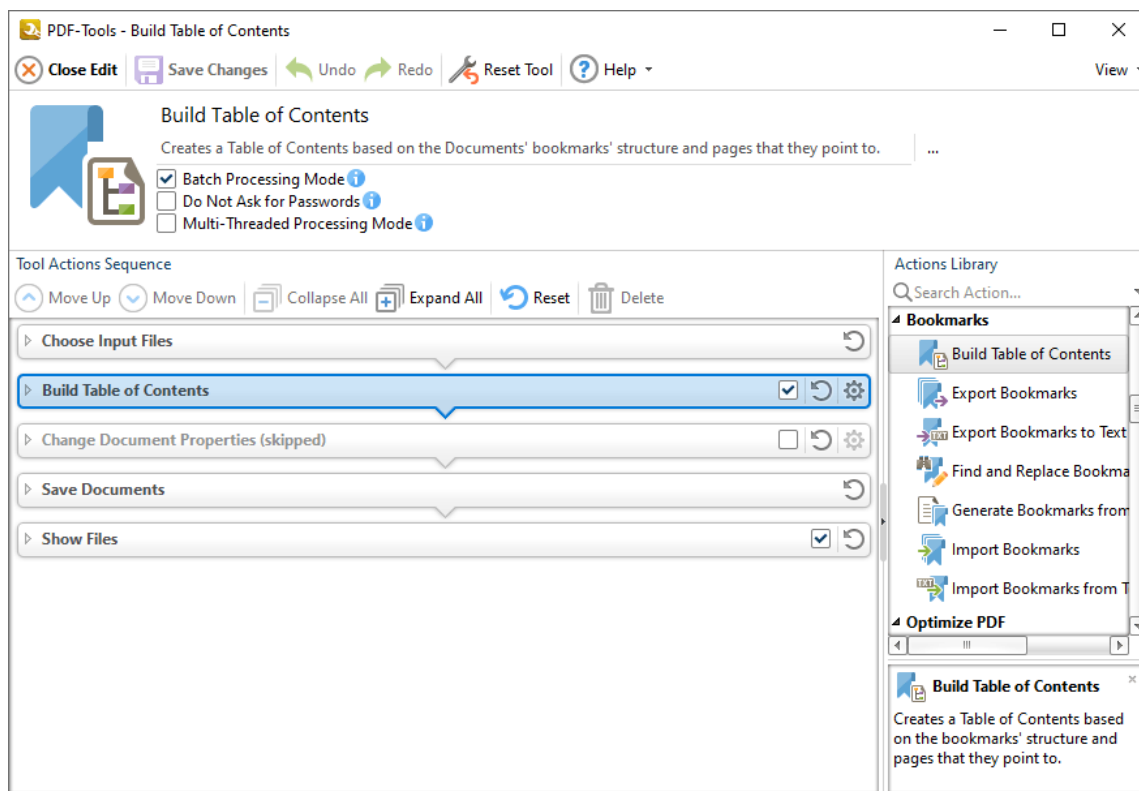







Figure 1. Build Table of Contents Tool Actions Sequence

The **Build Table of Contents** tool uses five tool actions:

1.  **Choose Input Files**<sup>[128]</sup> - the tool prompts for source documents.
2.  **Build Table of Contents**<sup>[145]</sup> - a table of contents is created from document bookmarks.
3.  **Change Document Properties**<sup>[292]</sup> (skipped by default) - the document properties are changed.
4.  **Save Documents**<sup>[135]</sup> - the updated documents are saved.
5.  **Show Files**<sup>[142]</sup> - the new documents are displayed in their destination folder.

Click actions to view customizable parameters. Additionally, please note that the [Clone Tool](#)<sup>[71]</sup> feature can be used to clone this tool and then add/remove actions from the **Tool Actions Sequence**.

Information about the **Batch Processing Mode**, **Do Not Ask for Passwords** and **Multi-Threaded Processing** check boxes is available [here](#).<sup>[57]</sup>

---

## 8.6.2 Export Bookmarks



The **Export Bookmarks** tool creates a copy of bookmarks in input documents and saves them to a new file:

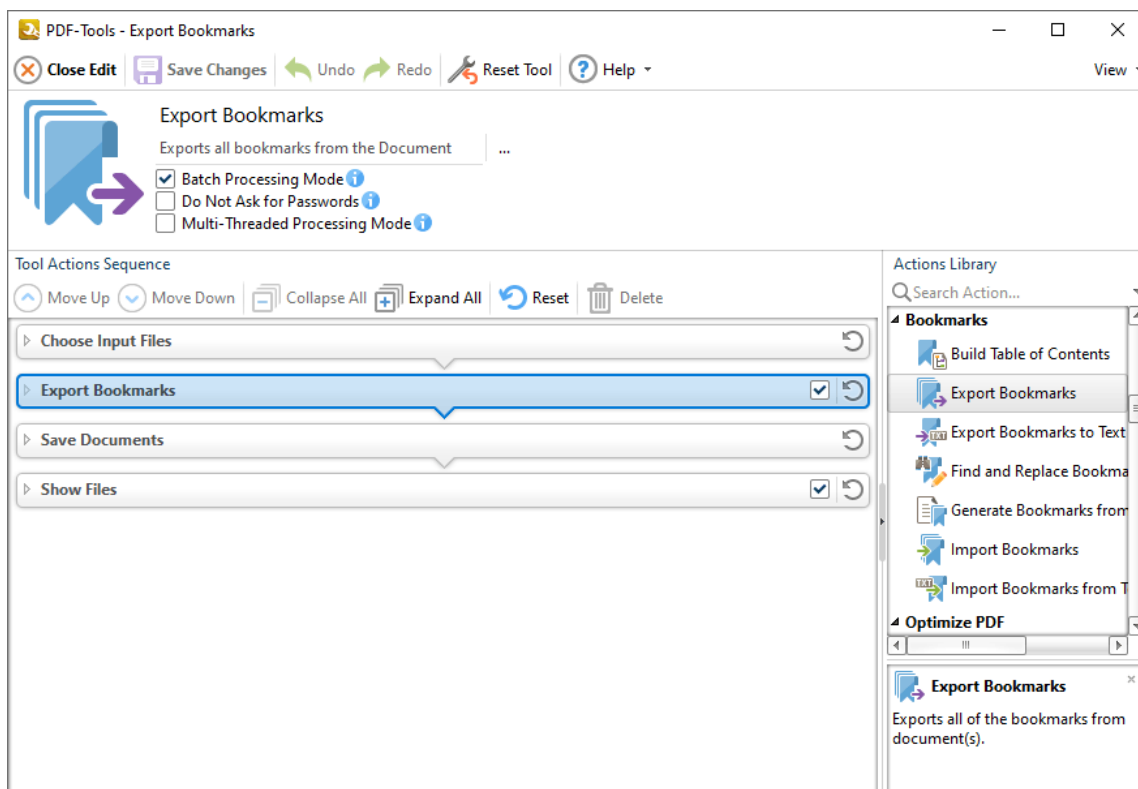





Figure 1. Export Bookmarks Tool Actions Sequence

The **Export Bookmarks** tool uses four tool actions:

1.  **Choose Input Files** <sup>[128]</sup> - the tool prompts for source documents.
2.  **Export Bookmarks** <sup>[148]</sup> - a copy of document bookmarks is created.
3.  **Save Documents** <sup>[135]</sup> - the new documents are saved.
4.  **Show Files** <sup>[142]</sup> - the new documents are displayed in their destination folder.

Click actions to view customizable parameters. Additionally, please note that the **Clone Tool** <sup>[71]</sup> feature can be used to clone this tool and then add/remove actions from the **Tool Actions Sequence**.

Information about the **Batch Processing Mode**, **Do Not Ask for Passwords** and **Multi-Threaded Processing** check boxes is available [here](#).<sup>[57]</sup>

---

## 8.6.3 Export Bookmarks to Text File



## Export Bookmarks to Text File

The **Export Bookmarks to Text File** tool creates a copy of bookmarks in input documents and saves them to a new text file:

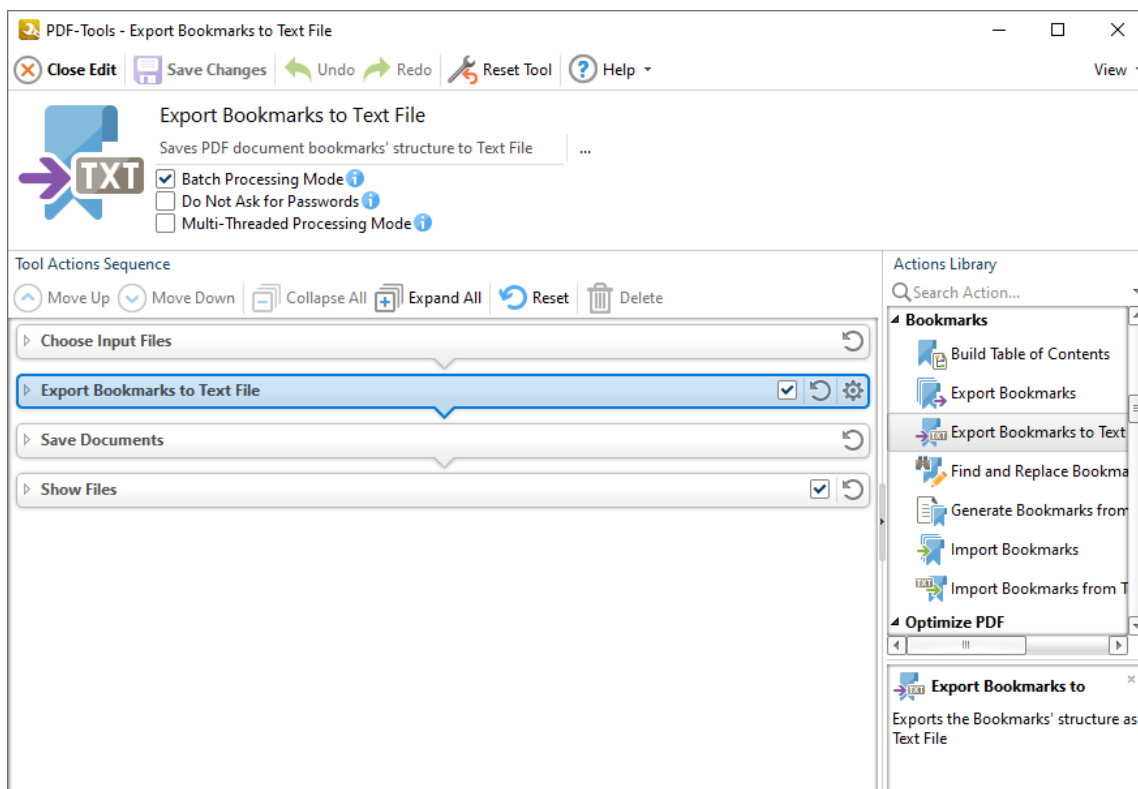





Figure 1. Export Bookmarks to Text File Tool Actions Sequence

The **Export Bookmarks to Text File** tool uses four tool actions:

1.  **Choose Input Files** <sup>[128]</sup> - the tool prompts for source documents.
2.  **Export Bookmarks to Text File** <sup>[149]</sup> - a copy of document bookmarks is created.
3.  **Save Documents** <sup>[135]</sup> - the new documents are saved to a text file.
4.  **Show Files** <sup>[142]</sup> - the new documents are displayed in their destination folder.

Click actions to view customizable parameters. Additionally, please note that the **Clone Tool** <sup>[71]</sup> feature can be used to clone this tool and then add/remove actions from the **Tool Actions Sequence**.

Information about the **Batch Processing Mode**, **Do Not Ask for Passwords** and **Multi-Threaded Processing** check boxes is available [here](#).<sup>[57]</sup>

---



### 8.6.4 Find and Replace Bookmark Text

## Find and Replace Bookmark Text

The **Find and Replace Bookmark Text** tool finds and replaces text in bookmark titles:

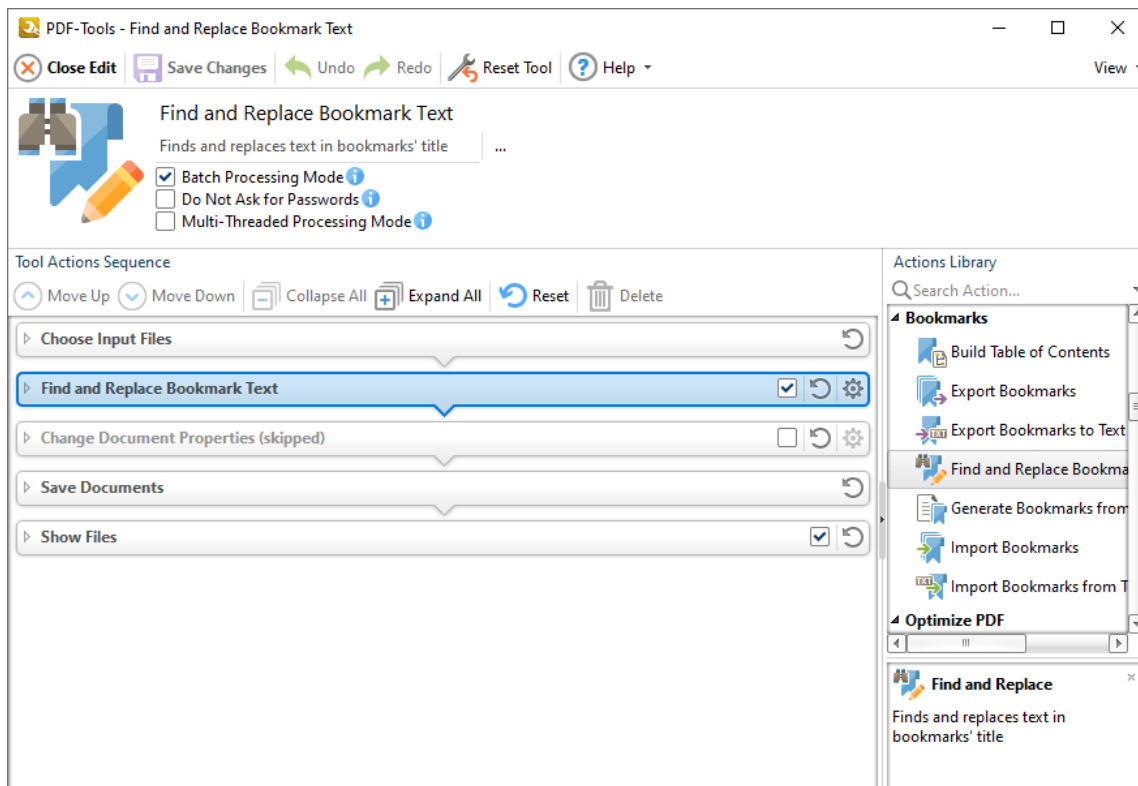







Figure 1. Find and Replace Bookmark Text Tool Actions Sequence

The **Find and Replace Bookmark Text** tool uses five tool actions:

1.  **Choose Input Files** <sup>[126]</sup> - the tool prompts for source documents.
2.  **Find and Replace Bookmark Text** <sup>[152]</sup> - the specified terms are searched for and replaced.
3.  **Change Document Properties** <sup>[292]</sup> (skipped by default) - the document properties are changed.
4.  **Save Documents** <sup>[135]</sup> - the new documents are saved.
5.  **Show Files** <sup>[142]</sup> - the new documents are displayed in their destination folder.

Click actions to view customizable parameters. Additionally, please note that the [Clone Tool](#)<sup>[71]</sup> feature can be used to clone this tool and then add/remove actions from the **Tool Actions Sequence**.

Information about the **Batch Processing Mode, Do Not Ask for Passwords** and **Multi-Threaded Processing** check boxes is available [here](#).<sup>[57]</sup>

---

### 8.6.5 Generate Bookmarks from Page Text



## Generate Bookmarks from Page Text

The **Generate Bookmarks from Page Text** tool creates bookmarks from the text of input documents:

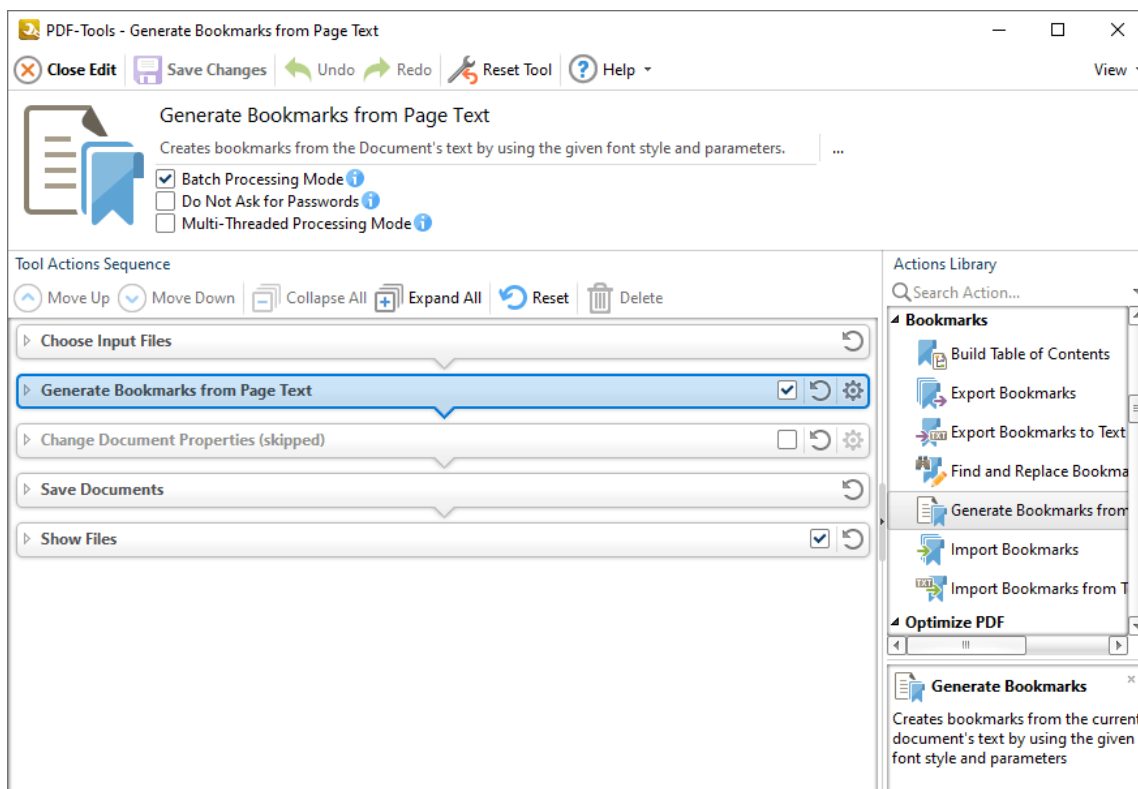







Figure 1. Generate Bookmarks from Page Text Tool Actions Sequence

The **Generate Bookmarks from Page Text** tool uses five tool actions:

1.  **Choose Input Files**<sup>[128]</sup> - the tool prompts for source documents.
2.  **Generate Bookmarks from Page Text**<sup>[154]</sup> - bookmarks are generated from specified document text.
3.  **Change Document Properties**<sup>[292]</sup> (skipped by default) - the document properties are changed.
4.  **Save Documents**<sup>[135]</sup> - the updated documents are saved.

5.  [Show Files](#)<sup>[142]</sup> - the new documents are displayed in their destination folder.

Click actions to view customizable parameters. Additionally, please note that the [Clone Tool](#)<sup>[71]</sup> feature can be used to clone this tool and then add/remove actions from the **Tool Actions Sequence**.

Information about the **Batch Processing Mode**, **Do Not Ask for Passwords** and **Multi-Threaded Processing** check boxes is available [here](#).<sup>[57]</sup>

---

## 8.6.6 Import Bookmarks



## Import Bookmarks

The **Import Bookmarks** tool imports bookmarks into documents:

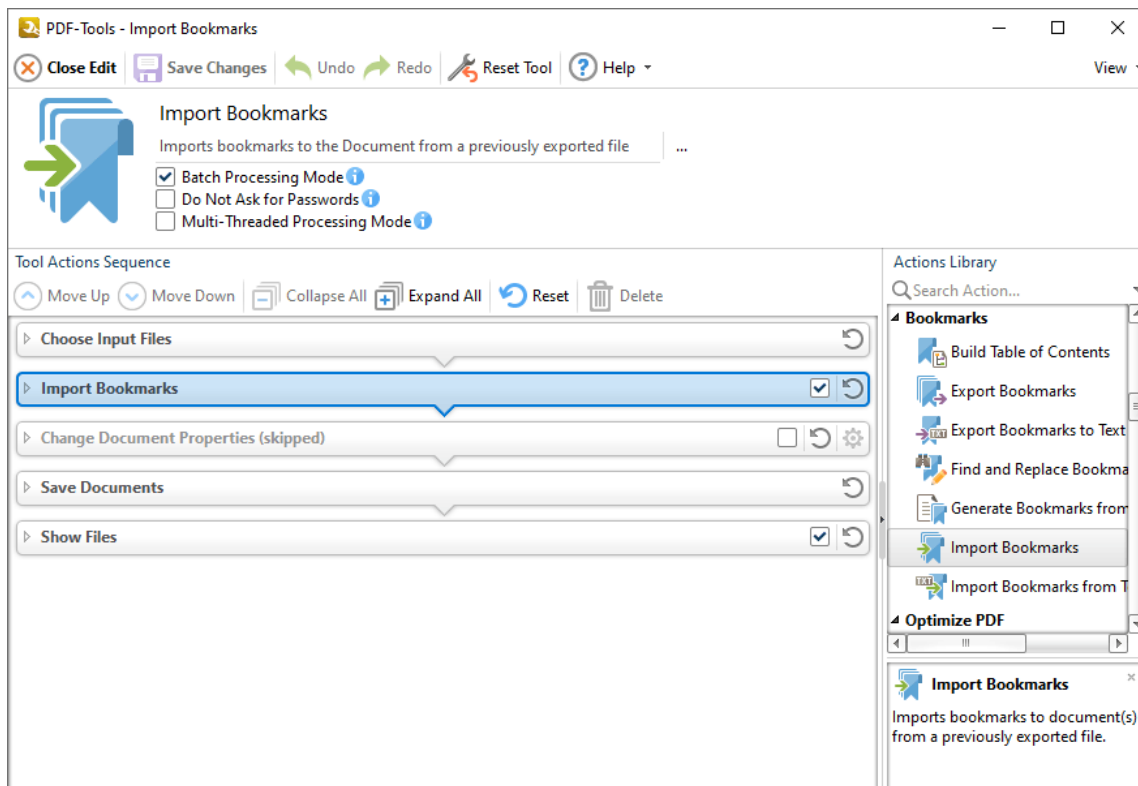







Figure 1. Import Bookmarks Tool Actions Sequence

The **Import Bookmarks** tool uses five tool actions:

1.  **Choose Input Files** <sup>[126]</sup> - the tool prompts for source documents.
2.  **Import Bookmarks** <sup>[162]</sup> - bookmarks are imported into the documents.
3.  **Change Document Properties** <sup>[292]</sup> (skipped by default) - the document properties are changed.
4.  **Save Documents** <sup>[135]</sup> - the updated documents are saved.
5.  **Show Files** <sup>[142]</sup> - the new documents are displayed in their destination folder.

Click actions to view customizable parameters. Note that the [Export Bookmarks](#)<sup>[405]</sup> tool can be used to export bookmarks to use in conjunction with this tool.

Additionally, please note that the [Clone Tool](#)<sup>[71]</sup> feature can be used to clone this tool and then add/remove actions from the **Tool Actions Sequence**.

Information about the **Batch Processing Mode**, **Do Not Ask for Passwords** and **Multi-Threaded Processing** check boxes is available [here](#).<sup>[57]</sup>

---

### 8.6.7 Import Bookmarks from Text File

## Import Bookmarks from Text File

The **Import Bookmarks from Text File** tool imports bookmarks from text files into documents:

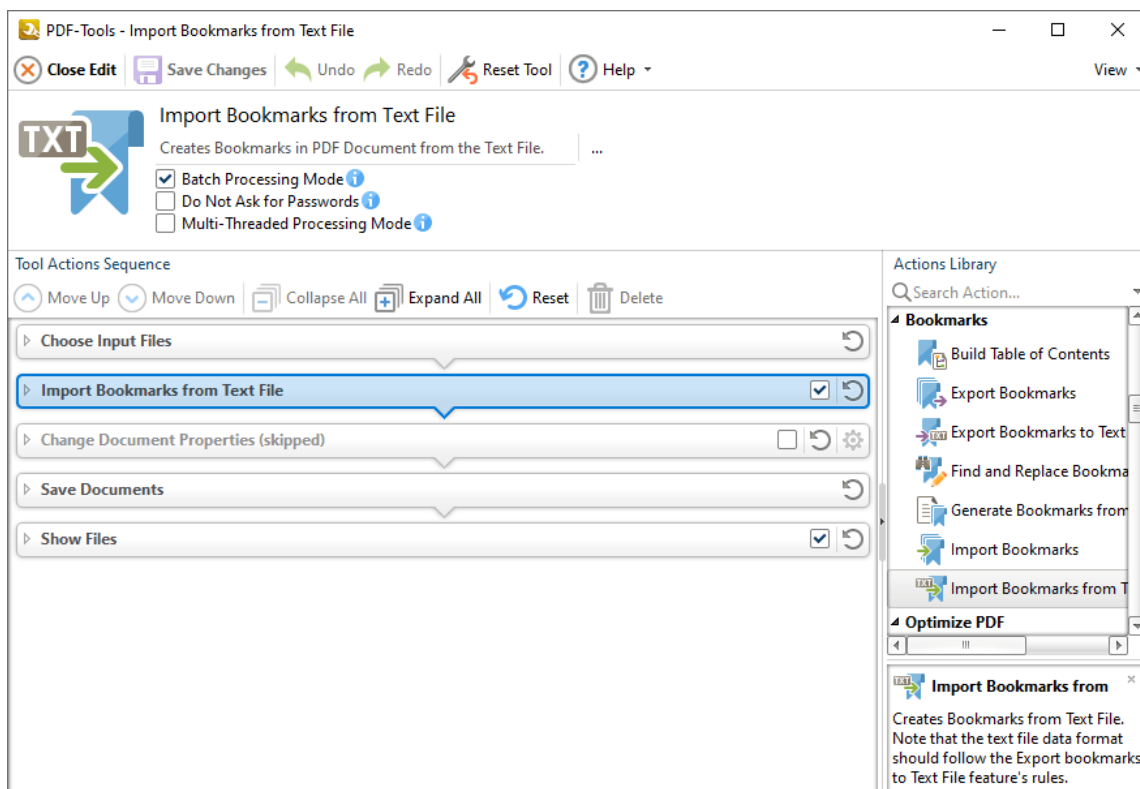







Figure 1. Import Bookmarks from Text File Tool Actions Sequence

The **Import Bookmarks from Text File** tool uses five tool actions:

1.  **Choose Input Files**<sup>[128]</sup> - the tool prompts for source documents.
2.  **Import Bookmarks from Text File**<sup>[164]</sup> - bookmarks are imported from text files into the documents.
3.  **Change Document Properties**<sup>[292]</sup> (skipped by default) - the document properties are changed.
4.  **Save Documents**<sup>[135]</sup> - the updated documents are saved.

5.  [Show Files](#)<sup>[142]</sup> - the new documents are displayed in their destination folder.

Click actions to view customizable parameters. Additionally, please note that the [Clone Tool](#)<sup>[71]</sup> feature can be used to clone this tool and then add/remove actions from the **Tool Actions Sequence**.

Information about the **Batch Processing Mode**, **Do Not Ask for Passwords** and **Multi-Threaded Processing** check boxes is available [here](#).<sup>[57]</sup>

---



## 8.7 Protection Tools







---



### Protection Tools

---

The **Protection** tools are used to add/remove digital signatures, certified signature fields, timestamps and passwords to input documents, as well as to sanitize/redact their content:

-  [Add Digital Signature](#)<sup>[418]</sup> uses a certificate-based digital ID to add and sign signature fields in input documents.
-  [Certify PDFs](#)<sup>[420]</sup> adds certified signature fields to input documents.
-  [Clear All Digital Signatures](#)<sup>[422]</sup> removes digital signatures from input documents.
-  [Find and Redact](#)<sup>[424]</sup> searches for specific words or patterns (phone numbers, credit card numbers, social security numbers, emails or dates) in documents and then either marks them for redaction or redacts them immediately.
-  [Sanitize Document](#)<sup>[426]</sup> removes sensitive information from input documents.
-  [Secure PDF](#)<sup>[428]</sup> adds password security to input documents.
-  [Timestamp PDFs](#)<sup>[430]</sup> adds document-level time stamps to input documents.

Note that the [Clone Tool](#)<sup>[71]</sup> and [Create Tool](#)<sup>[65]</sup> features can be used to enhance the functionality of existing tools/create new tools in order to meet complex requirements.

---

### 8.7.1 Add Digital Signature

## Add Digital Signature

The **Add Digital Signature** tool uses a certificate-based digital ID to add and sign signature fields in input documents:

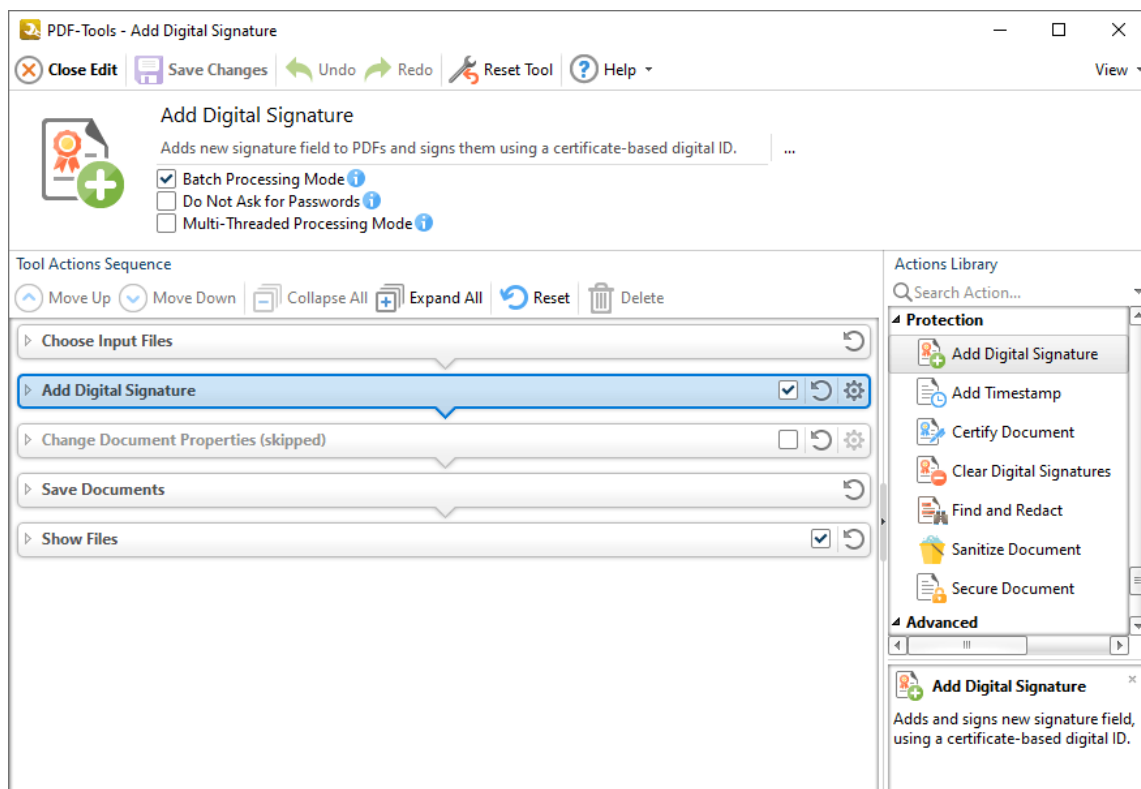







Figure 1. Add Digital Signature Tool Actions Sequence

The **Add Digital Signature** tool uses five tool actions:

1.  **Choose Input Files** <sup>[128]</sup> - the tool prompts for source documents.
2.  **Add Digital Signature** <sup>[272]</sup> - digital signatures are added to the documents.
3.  **Change Document Properties** <sup>[292]</sup> (skipped by default) - the document properties are changed.
4.  **Save Documents** <sup>[135]</sup> - the updated documents are saved.
5.  **Show Files** <sup>[142]</sup> - the new documents are displayed in their destination folder.

Click actions to view customizable parameters. Additionally, please note that the [Clone Tool](#)<sup>[71]</sup> feature can be used to clone this tool and then add/remove actions from the **Tool Actions Sequence**.

Information about the **Batch Processing Mode**, **Do Not Ask for Passwords** and **Multi-Threaded Processing** check boxes is available [here](#).<sup>[57]</sup>

---

## 8.7.2 Certify PDFs



The **Certify PDFs** tool adds certified signature fields to input documents:

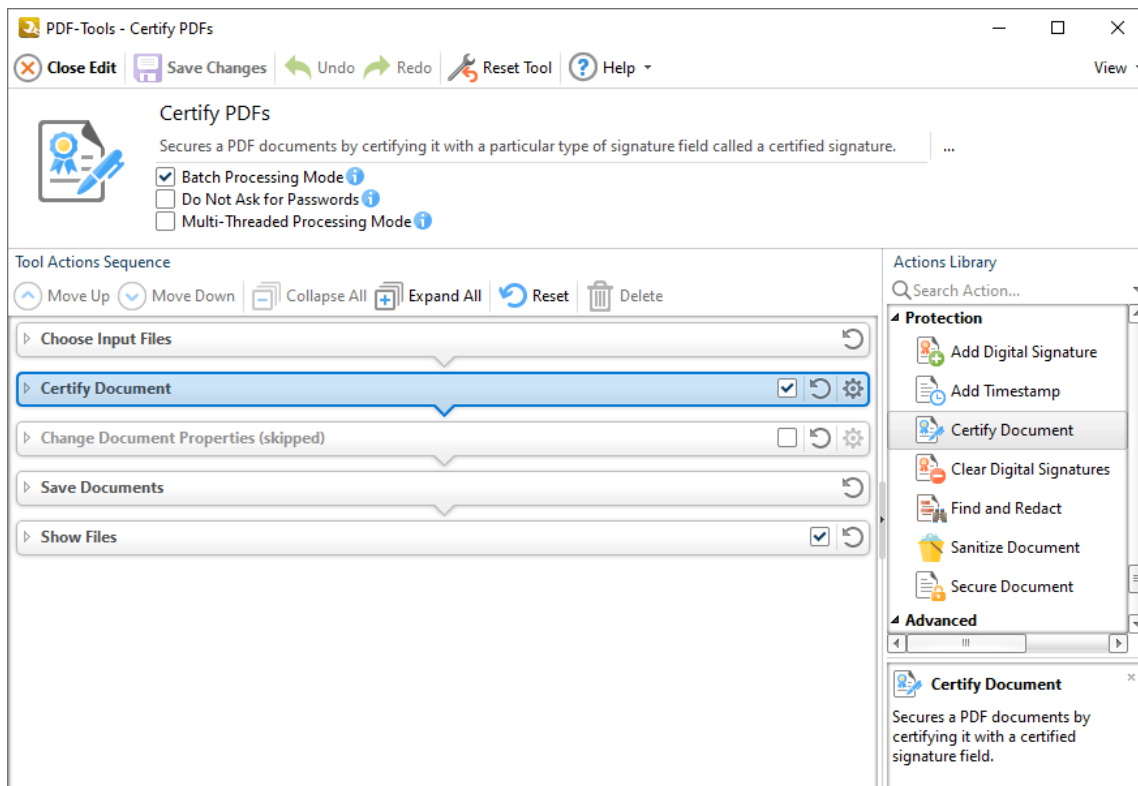







Figure 1. Certify PDFs Tool Actions Sequence

The **Certify PDFs** tool uses five tool actions:

1.  **Choose Input Files** <sup>[126]</sup> - the tool prompts for source documents.
2.  **Certify Document** <sup>[279]</sup> - certified signature fields are added to the documents.
3.  **Change Document Properties** <sup>[292]</sup> (skipped by default) - the document properties are changed.
4.  **Save Documents** <sup>[135]</sup> - the updated documents are saved.
5.  **Show Files** <sup>[142]</sup> - the new documents are displayed in their destination folder.

Click actions to view customizable parameters. Additionally, please note that the [Clone Tool](#)<sup>[71]</sup> feature can be used to clone this tool and then add/remove actions from the **Tool Actions Sequence**.

Information about the **Batch Processing Mode, Do Not Ask for Passwords** and **Multi-Threaded Processing** check boxes is available [here](#).<sup>[57]</sup>

---

### 8.7.3 Clear All Digital Signatures



The **Clear All Digital Signatures** tool removes digital signatures from input documents:

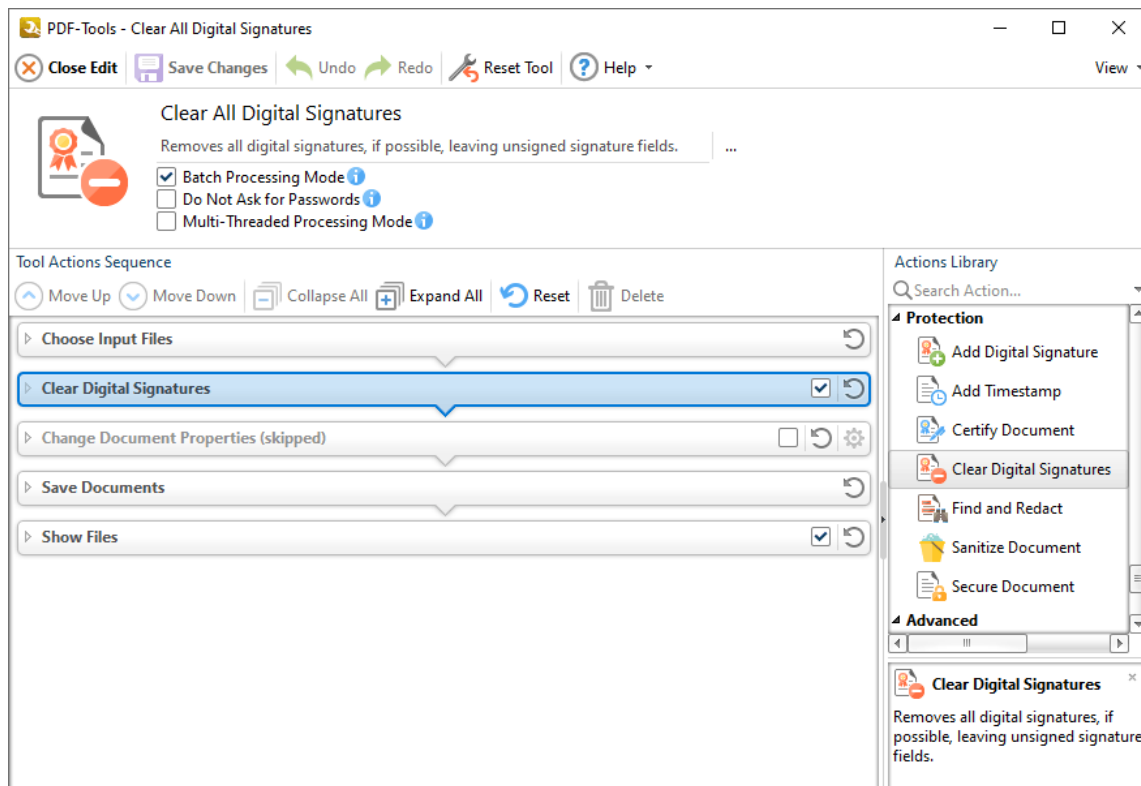







Figure 1. Clear All Digital Signatures Tool Actions Sequence

The **Clear All Digital Signatures** tool uses five tool actions:

1.  **Choose Input Files** <sup>[126]</sup> - the tool prompts for source documents.
2.  **Clear Digital Signatures** <sup>[283]</sup> - digital signatures are removed from the documents.
3.  **Change Document Properties** <sup>[292]</sup> (skipped by default) - the document properties are changed.
4.  **Save Documents** <sup>[135]</sup> - the updated documents are saved.
5.  **Show Files** <sup>[142]</sup> - the new documents are displayed in their destination folder.

Click actions to view customizable parameters. Additionally, please note that the [Clone Tool](#)<sup>[71]</sup> feature can be used to clone this tool and then add/remove actions from the **Tool Actions Sequence**.

Information about the **Batch Processing Mode, Do Not Ask for Passwords** and **Multi-Threaded Processing** check boxes is available [here](#).<sup>[57]</sup>

---

## 8.7.4 Find and Redact



## Find and Redact

The **Find and Redact** tool searches for specific words or patterns (phone numbers, credit card numbers, social security numbers, emails or dates) in documents and then either marks them for redaction or redacts them immediately:

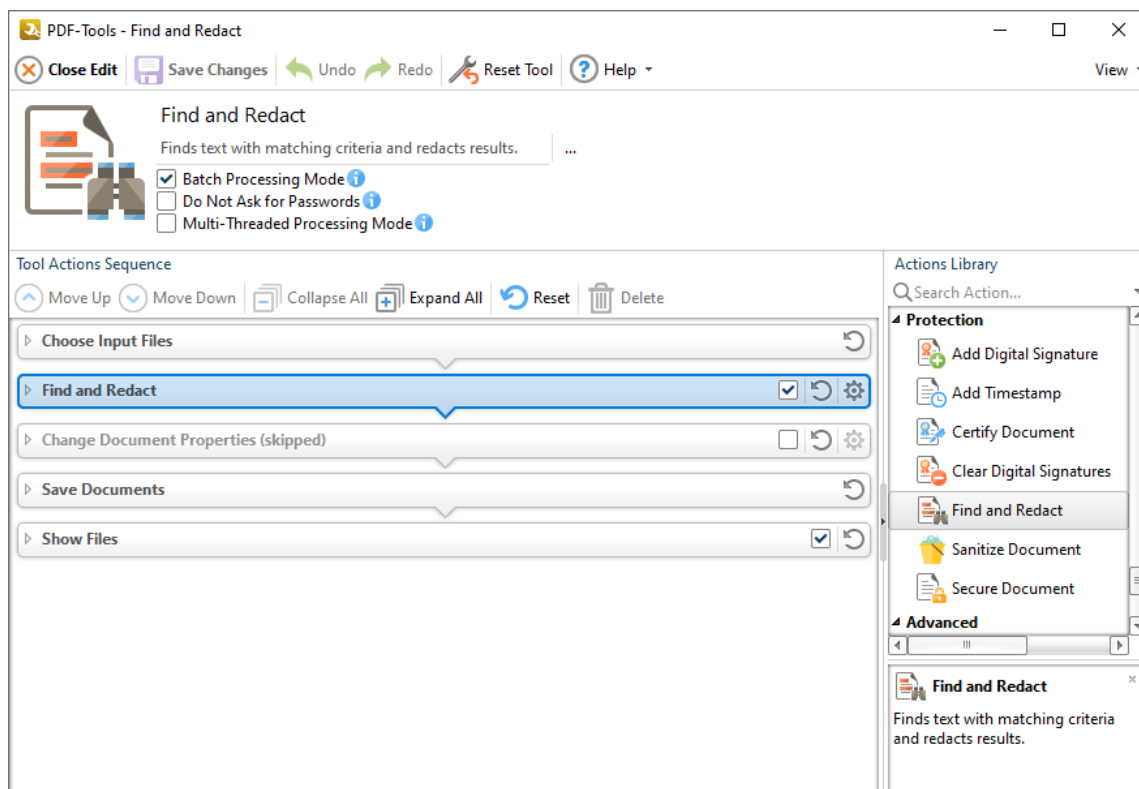







Figure 1. Find and Redact Tool Actions Sequence

The **Find and Redact** tool uses five tool actions:

1.  **Choose Input Files** <sup>[128]</sup> - the tool prompts for source documents.
2.  **Find and Redact** <sup>[284]</sup> - the specified words/patterns are located and marked for redaction (or redacted immediately).
3.  **Change Document Properties** <sup>[292]</sup> (skipped by default) - the document properties are changed.
4.  **Save Documents** <sup>[135]</sup> - the updated documents are saved.



5.  [Show Files](#)<sup>[142]</sup> - the new documents are displayed in their destination folder.

Click actions to view customizable parameters. Additionally, please note that the [Clone Tool](#)<sup>[71]</sup> feature can be used to clone this tool and then add/remove actions from the **Tool Actions Sequence**.

Information about the **Batch Processing Mode**, **Do Not Ask for Passwords** and **Multi-Threaded Processing** check boxes is available [here](#).<sup>[57]</sup>

---

8.7.5 Sanitize Document



Sanitize Document

The **Sanitize Document** tool removes sensitive information from input documents:

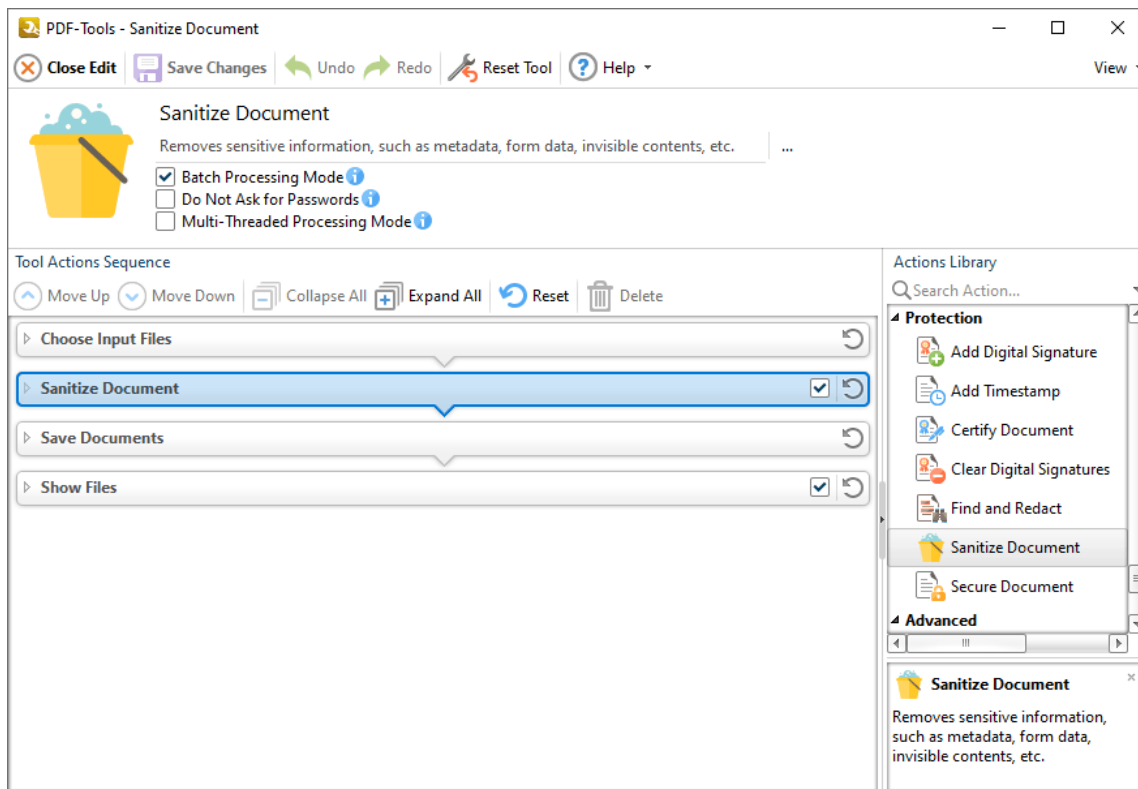





Figure 1. Sanitize Document Tool Actions Sequence

The **Sanitize Document** tool uses four tool actions:

1.  **Choose Input Files**<sup>[126]</sup> - the tool prompts for source documents.
2.  **Sanitize Document**<sup>[287]</sup> - the input documents are sanitized.
3.  **Save Documents**<sup>[135]</sup> - the updated documents are saved.
4.  **Show Files**<sup>[142]</sup> - the new documents are displayed in their destination folder.

Click actions to view customizable parameters. Additionally, please note that the **Clone Tool**<sup>[71]</sup> feature can be used to clone this tool and then add/remove actions from the **Tool Actions Sequence**.

Information about the **Batch Processing Mode, Do Not Ask for Passwords** and **Multi-Threaded Processing** check boxes is available [here](#).<sup>[57]</sup>

---

## 8.7.6 Secure PDF



The **Secure PDF** tool adds password security to input documents:

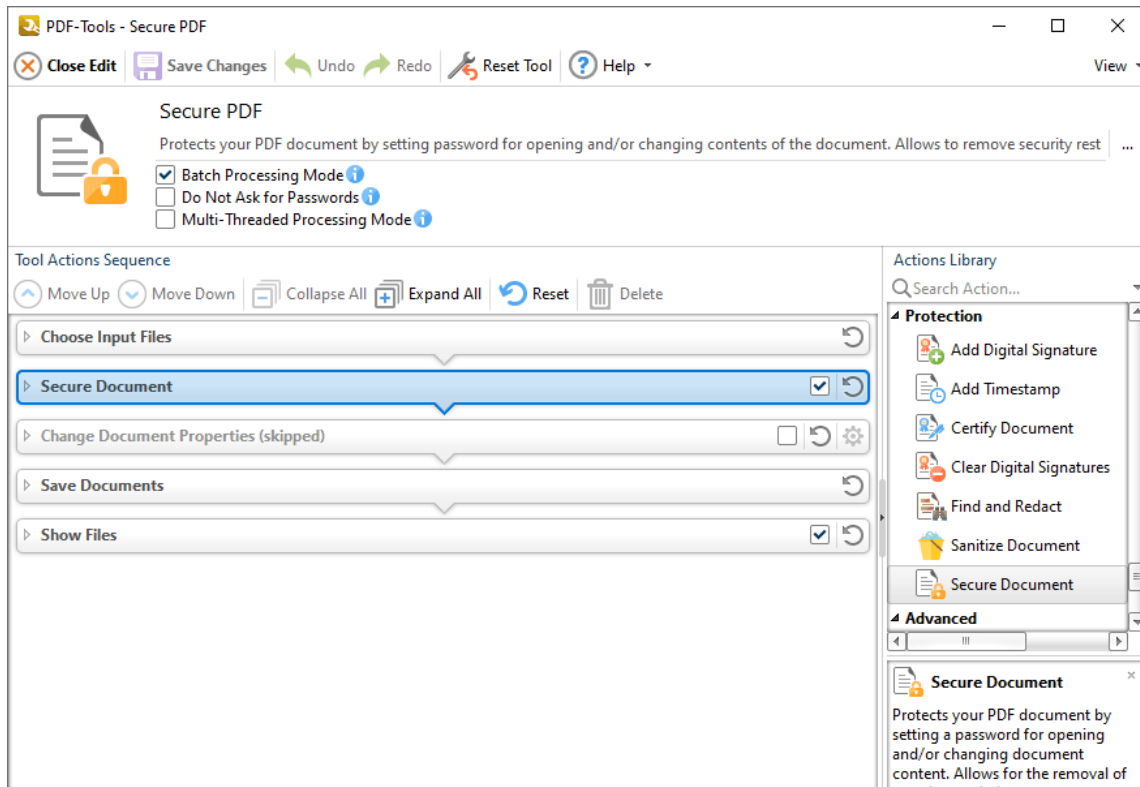

Figure 1. Secure PDF Tool Actions Sequence

The **Secure PDF** tool uses five tool actions:

1. **Choose Input Files** <sup>[126]</sup> - the tool prompts for source documents.
2. **Secure Document** <sup>[289]</sup> - password security is added to the documents.
3. **Change Document Properties** <sup>[292]</sup> (skipped by default) - the document properties are changed.
4. **Save Documents** <sup>[135]</sup> - the updated documents are saved.
5. **Show Files** <sup>[142]</sup> - the new documents are displayed in their destination folder.

Click actions to view customizable parameters. Additionally, please note that the [Clone Tool](#)<sup>[71]</sup> feature can be used to clone this tool and then add/remove actions from the **Tool Actions Sequence**.

Information about the **Batch Processing Mode, Do Not Ask for Passwords** and **Multi-Threaded Processing** check boxes is available [here](#).<sup>[57]</sup>

---

## 8.7.7 Timestamp PDFs



## Timestamp PDFs

The **Timestamp PDFs** tool adds document-level time stamps to input documents and saves them as a new file:

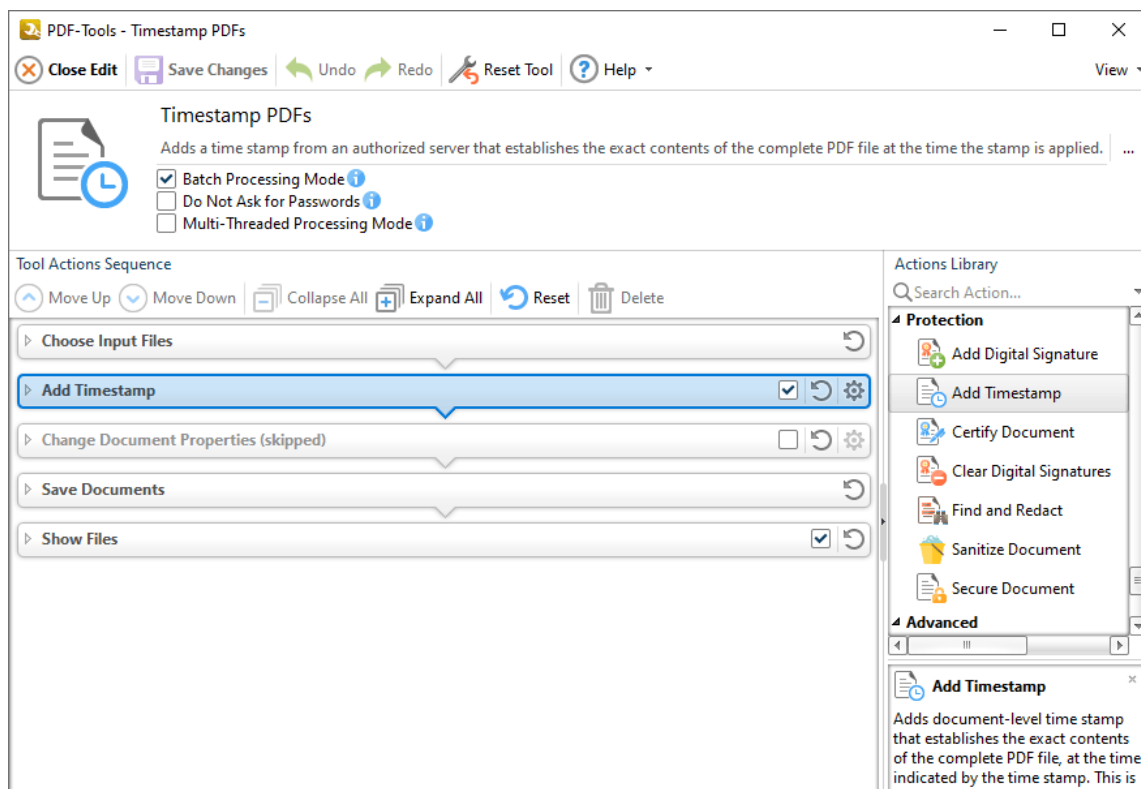

Figure 1. Timestamp PDFs Tool Actions Sequence

The **Timestamp PDFs** tool uses five tool actions:

1. **Choose Input Files** <sup>[128]</sup> - the tool prompts for source documents.
2. **Add Timestamp** <sup>[276]</sup> - document-level timestamps are added to the documents.
3. **Change Document Properties** <sup>[292]</sup> (skipped by default) - the document properties are changed.
4. **Save Documents** <sup>[135]</sup> - the updated documents are saved.
5. **Show Files** <sup>[142]</sup> - the new documents are displayed in their destination folder.

Click actions to view customizable parameters. Additionally, please note that the [Clone Tool](#)<sup>[71]</sup> feature can be used to clone this tool and then add/remove actions from the **Tool Actions Sequence**.

Information about the **Batch Processing Mode**, **Do Not Ask for Passwords** and **Multi-Threaded Processing** check boxes is available [here](#).<sup>[57]</sup>

---

## 8.8 Optimize PDF Tools

---



### Optimize PDF Tools

---

The **Optimize PDF** tools are used to enhance and optimize input files:

 [Enhance Scanned Pages](#)<sup>[433]</sup> enhances scanned images in input documents to improve quality and reduce the file size.

 [Optimize PDF](#)<sup>[435]</sup> optimizes the content of input documents in order to reduce the file size.

Note that the [Clone Tool](#)<sup>[71]</sup> and [Create Tool](#)<sup>[65]</sup> features can be used to enhance the functionality of existing tools/create new tools in order to meet complex requirements.

---



## 8.8.1 Enhance Scanned Pages



### Enhance Scanned Pages

The **Enhance Scanned Pages** tool enhances scanned images in input documents to improve their quality and reduce the file size:

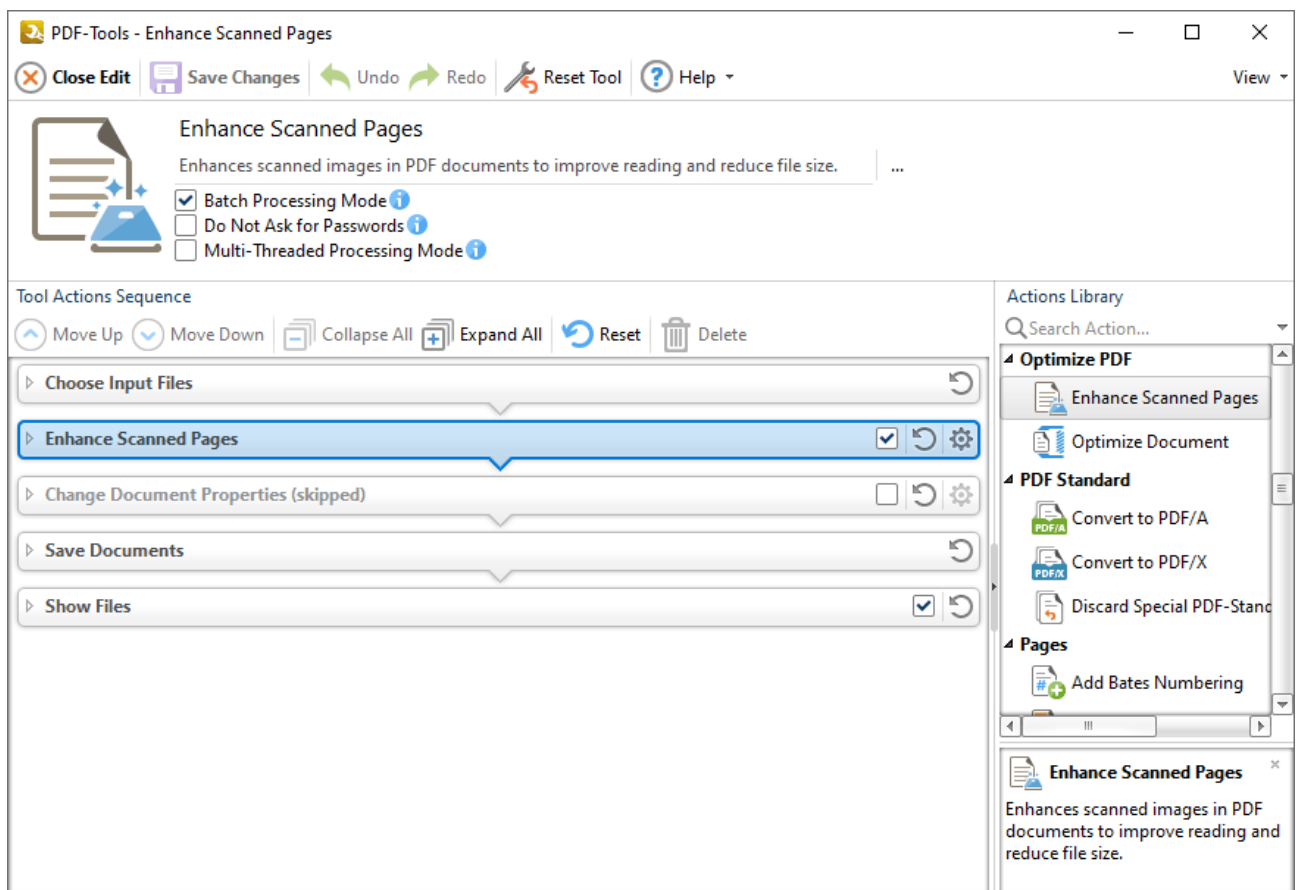







Figure 1. Enhance Scanner Pages Tool Actions Sequence

The **Enhance Scanned Pages** tool uses five tool actions:

1.  **Choose Input Files**<sup>[128]</sup> - the tool prompts for source documents.
2.  **Enhance Scanned Pages**<sup>[167]</sup> - the document images are enhanced and the file size is reduced.
3.  **Change Document Properties**<sup>[292]</sup> (skipped by default) - the document properties are changed.

4.  [Save Documents](#)<sup>[135]</sup> - the updated documents are saved.
5.  [Show Files](#)<sup>[142]</sup> - the new documents are displayed in their destination folder.

Click actions to view customizable parameters. Additionally, please note that the [Clone Tool](#)<sup>[71]</sup> feature can be used to clone this tool and then add/remove actions from the **Tool Actions Sequence**.

Information about the **Batch Processing Mode**, **Do Not Ask for Passwords** and **Multi-Threaded Processing** check boxes is available [here](#).<sup>[57]</sup>

---

## 8.8.2 Optimize PDF



## Optimize PDF

The **Optimize PDF** tool optimizes the content of input documents in order to reduce the file size:

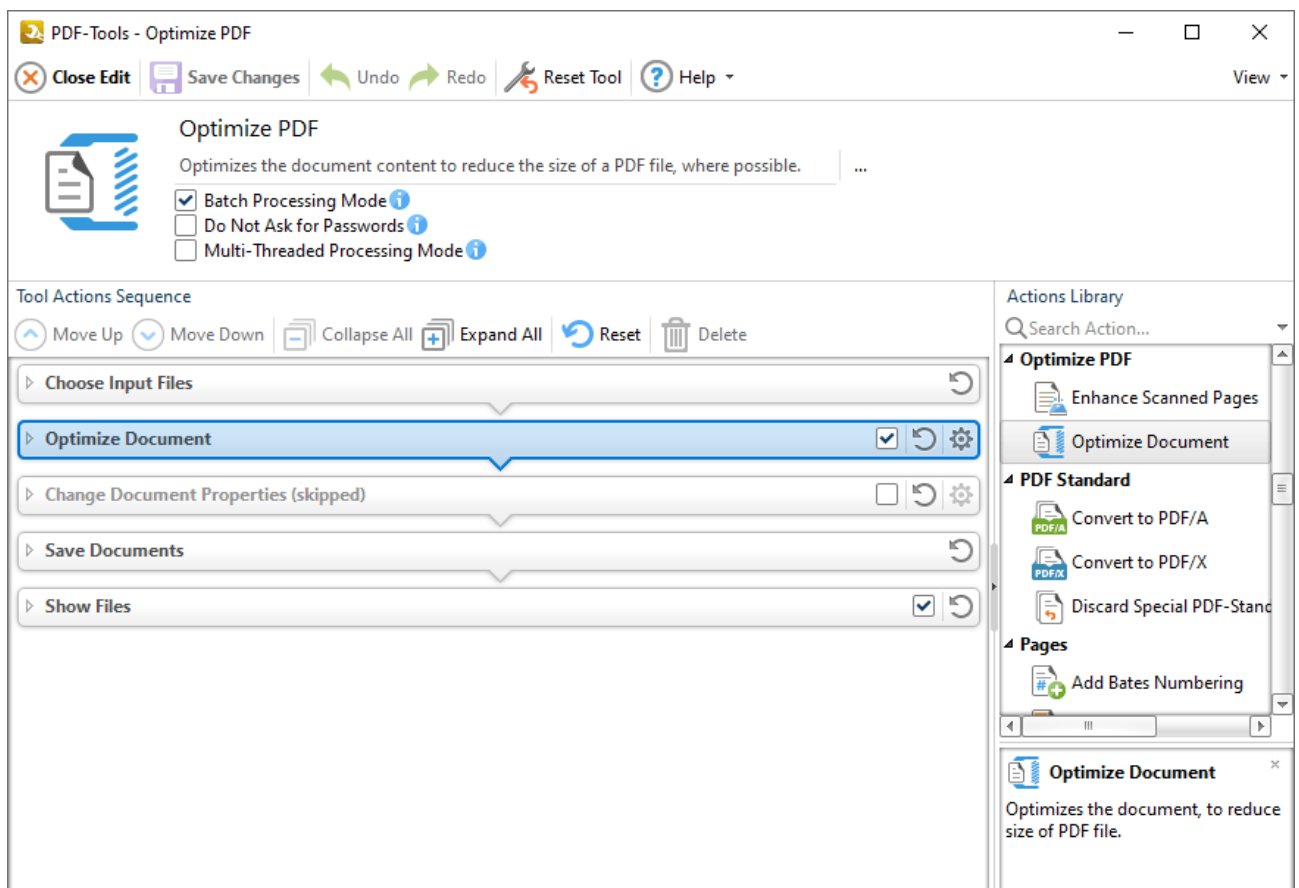



Figure 1. Optimize PDF Tool Actions Sequence

The **Optimize PDF** tool uses five tool actions:

1. **Choose Input Files**<sup>[128]</sup> - the tool prompts for source documents.
2. **Optimize Document**<sup>[170]</sup> - the documents are optimized.
3. **Change Document Properties**<sup>[292]</sup> (skipped by default) - the document properties are changed.

4.  [Save Documents](#)<sup>[135]</sup> - the updated documents are saved.
5.  [Show Files](#)<sup>[142]</sup> - the new documents are displayed in their destination folder.

Click actions to view customizable parameters. Additionally, please note that the [Clone Tool](#)<sup>[71]</sup> feature can be used to clone this tool and then add/remove actions from the **Tool Actions Sequence**.

Information about the **Batch Processing Mode**, **Do Not Ask for Passwords** and **Multi-Threaded Processing** check boxes is available [here](#).<sup>[57]</sup>

---

## 8.9 PDF Standard Tools

---





### PDF Standard Tools

---

The **PDF Standard** tools make input documents compliant with alternative PDF standards:

 **Convert to PDF/A**<sup>[180]</sup> makes documents compliant with the PDF/A standard, which is used for long-term archiving.

 **Convert to PDF/X**<sup>[182]</sup> makes documents compliant with the PDF/X standard, which is used to exchange printing data.

 **Discard Special PDF-Standard**<sup>[184]</sup> discards special PDF standard information from documents such as PDF/X, PDF/A and PDF/E information.

Note that the **Clone Tool**<sup>[71]</sup> and **Create Tool**<sup>[65]</sup> features can be used to enhance the functionality of existing tools/create new tools in order to meet complex requirements.

---

### 8.9.1 Convert to PDF/A



The **Convert to PDF/A** tool makes documents compliant with the PDF/A format, which is used for long-term archiving:

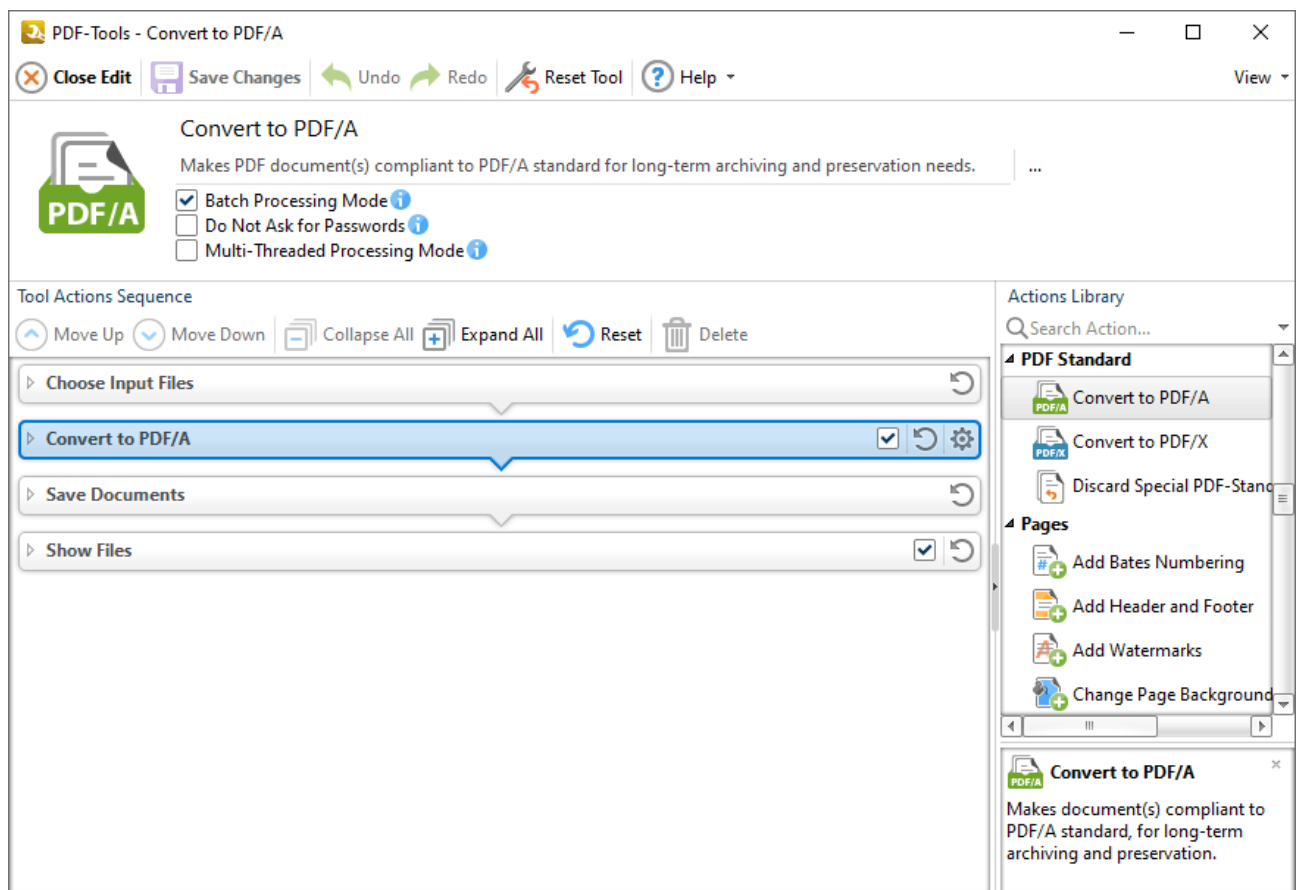





Figure 1. Convert to PDF/A Tool Actions Sequence

The **Convert to PDF/A** tool uses four tool actions:

1.  **Choose Input Files** <sup>[128]</sup> - the tool prompts for source documents.
2.  **Convert to PDF/A** <sup>[180]</sup> - the documents are made compliant with the PDF/A format.
3.  **Save Documents** <sup>[135]</sup> - the updated documents are saved.
4.  **Show Files** <sup>[142]</sup> - the new documents are displayed in their destination folder.

Click actions to view customizable parameters. Additionally, please note that the [Clone Tool](#)<sup>[71]</sup> feature can be used to clone this tool and then add/remove actions from the **Tool Actions Sequence**.

Information about the **Batch Processing Mode**, **Do Not Ask for Passwords** and **Multi-Threaded Processing** check boxes is available [here](#).<sup>[57]</sup>

---

## 8.9.2 Convert to PDF/X



The **Convert to PDF/X** tool makes documents compliant with the PDF/X format, which is used to exchange printing data:

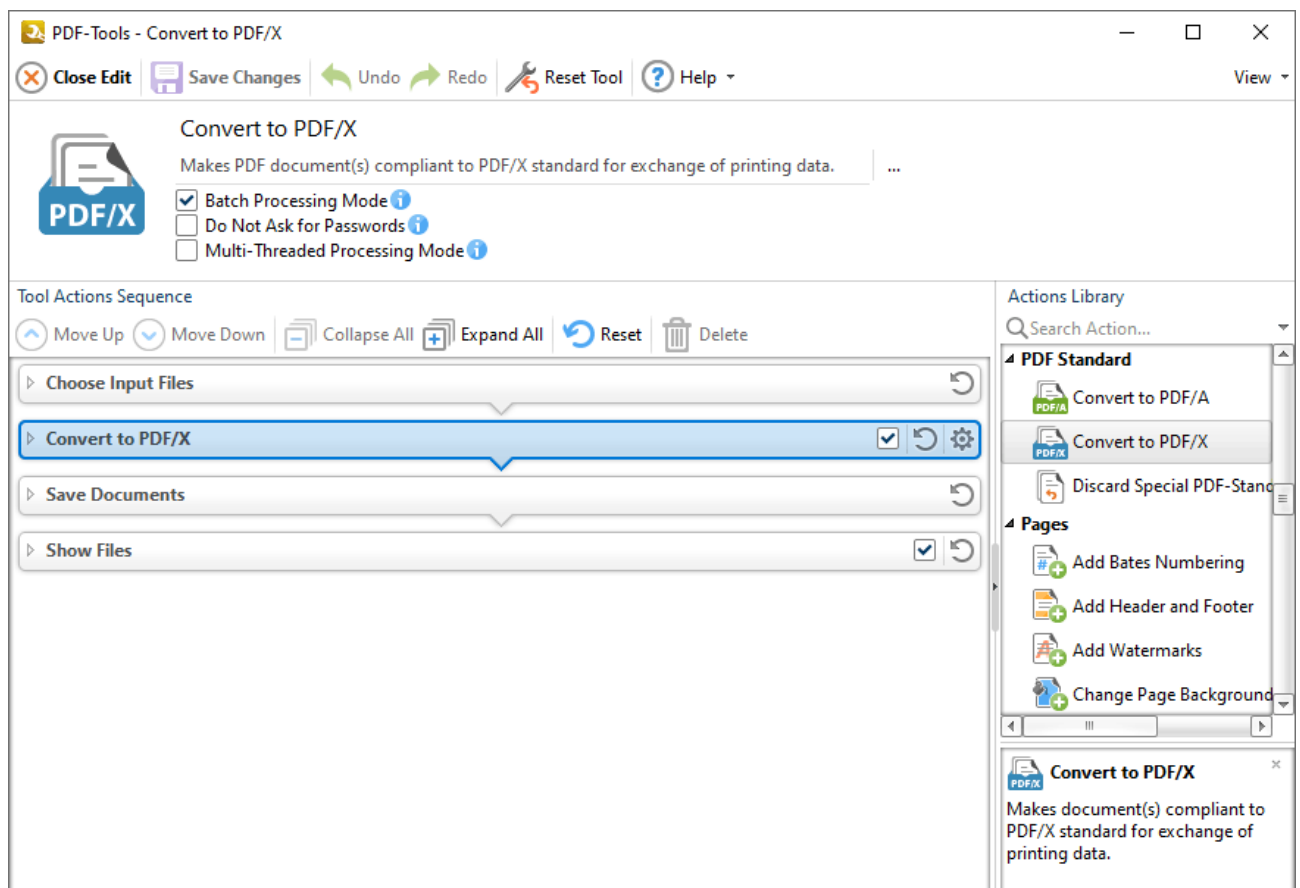





Figure 1. Convert to PDF/X Tool Actions Sequence

The **Convert to PDF/X** tool uses four tool actions:

1.  **Choose Input Files** <sup>[128]</sup> - the tool prompts for source documents.
2.  **Convert to PDF/X** <sup>[182]</sup> - the documents are made compliant with the PDF/A format.
3.  **Save Documents** <sup>[135]</sup> - the updated documents are saved.
4.  **Show Files** <sup>[142]</sup> - the new documents are displayed in their destination folder.



Click actions to view customizable parameters. Additionally, please note that the [Clone Tool](#)<sup>[71]</sup> feature can be used to clone this tool and then add/remove actions from the **Tool Actions Sequence**.

Information about the **Batch Processing Mode**, **Do Not Ask for Passwords** and **Multi-Threaded Processing** check boxes is available [here](#).<sup>[57]</sup>

---

## 8.9.3 Discard Special PDF-Standard



## Discard Special PDF-Standard

The **Discard Special PDF-Standard** tool discards special PDF-standard information from documents such as PDF/X, PDF/A and PDF/E information:

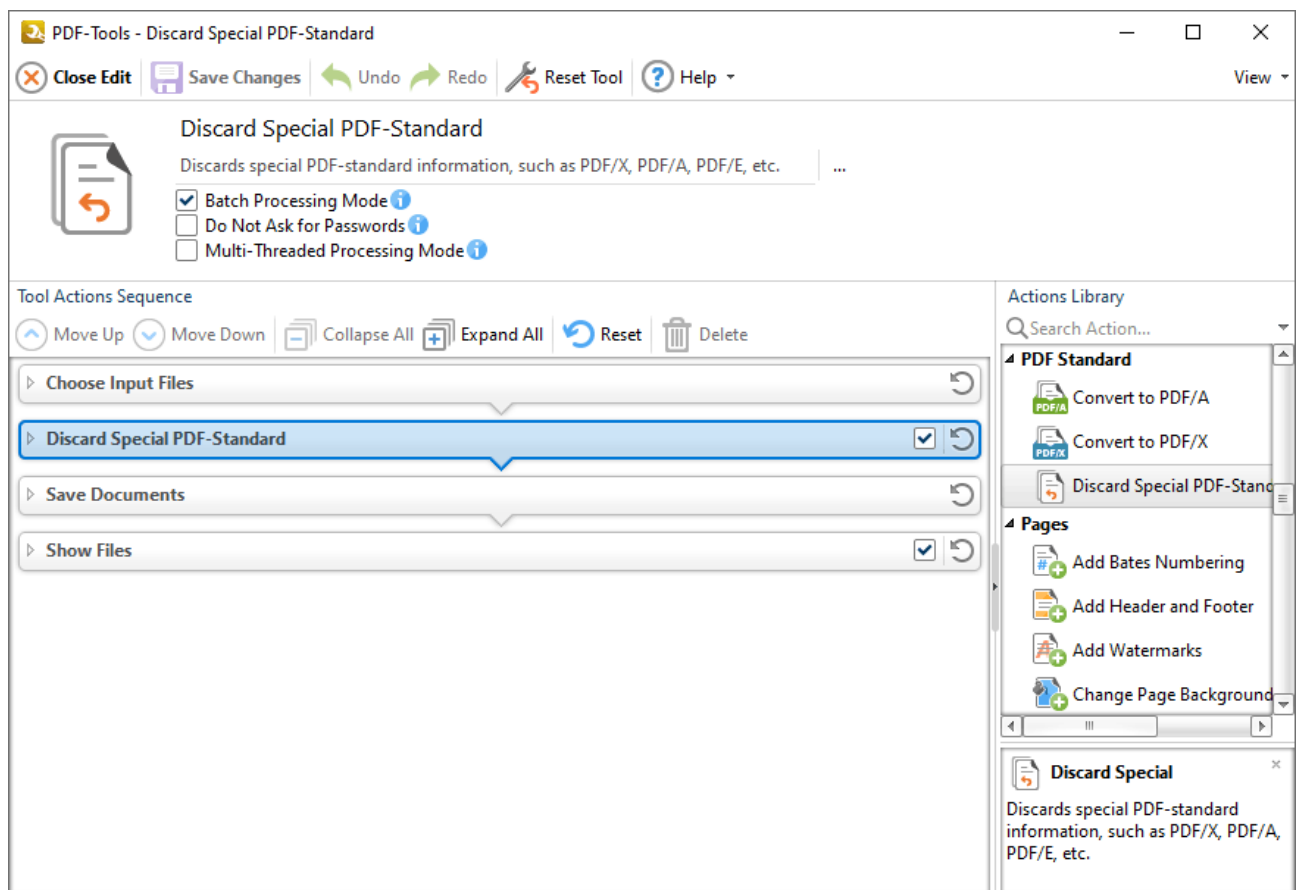





Figure 1. Discard Special PDF-Standard Tool Actions Sequence

The **Discard Special PDF-Standard** tool uses four tool actions:

1.  **Choose Input Files** <sup>128</sup> - the tool prompts for source documents.
2.  **Discard Special PDF-Standard** <sup>184</sup> - special PDF-standard information is discarded from the documents.
3.  **Save Documents** <sup>135</sup> - the updated documents are saved.

4.  [Show Files](#)<sup>[142]</sup> - the new documents are displayed in their destination folder.

Click actions to view customizable parameters. Additionally, please note that the [Clone Tool](#)<sup>[71]</sup> feature can be used to clone this tool and then add/remove actions from the **Tool Actions Sequence**.

Information about the **Batch Processing Mode**, **Do Not Ask for Passwords** and **Multi-Threaded Processing** check boxes is available [here](#).<sup>[57]</sup>

---

## 8.10 Export PDF Tools

---



### Export PDF Tools

---

The **Export PDF** tools copy and convert PDF documents/images to alternative formats:

 [Export PDF to Audio](#)<sup>[445]</sup> copies text in PDF documents and exports them to audio file format.

 [Export PDF to Images](#)<sup>[106]</sup> copies PDF documents and converts them to raster images.

 [Export PDF to Microsoft Excel Spreadsheet](#)<sup>[110]</sup> copies PDF documents and converts them to **Microsoft Excel (.xlsx)** format.

 [Export PDF to Microsoft Powerpoint Presentation](#)<sup>[113]</sup> copies PDF documents and converts them to **Microsoft Powerpoint Presentation (\*.pptx)** format.

 [Export PDF to Microsoft Word Document](#)<sup>[117]</sup> copies PDF documents and converts them to **Microsoft Word (.docx)** format.

 [Export PDF to Plain Text](#)<sup>[120]</sup> copies PDF documents and converts them to plain text (\*.txt) format.

 [Extract Images from PDF](#)<sup>[122]</sup> copies images in PDF documents and saves them to a new file.

Note that the [Clone Tool](#)<sup>[71]</sup> and [Create Tool](#)<sup>[65]</sup> features can be used to enhance the functionality of existing tools/create new tools in order to meet complex requirements.

---

8.10.1 Export PDF to Audio

 **Export PDF to Audio**

The **Export PDF to Audio** tool exports a copy text in PDF documents to audio file format:

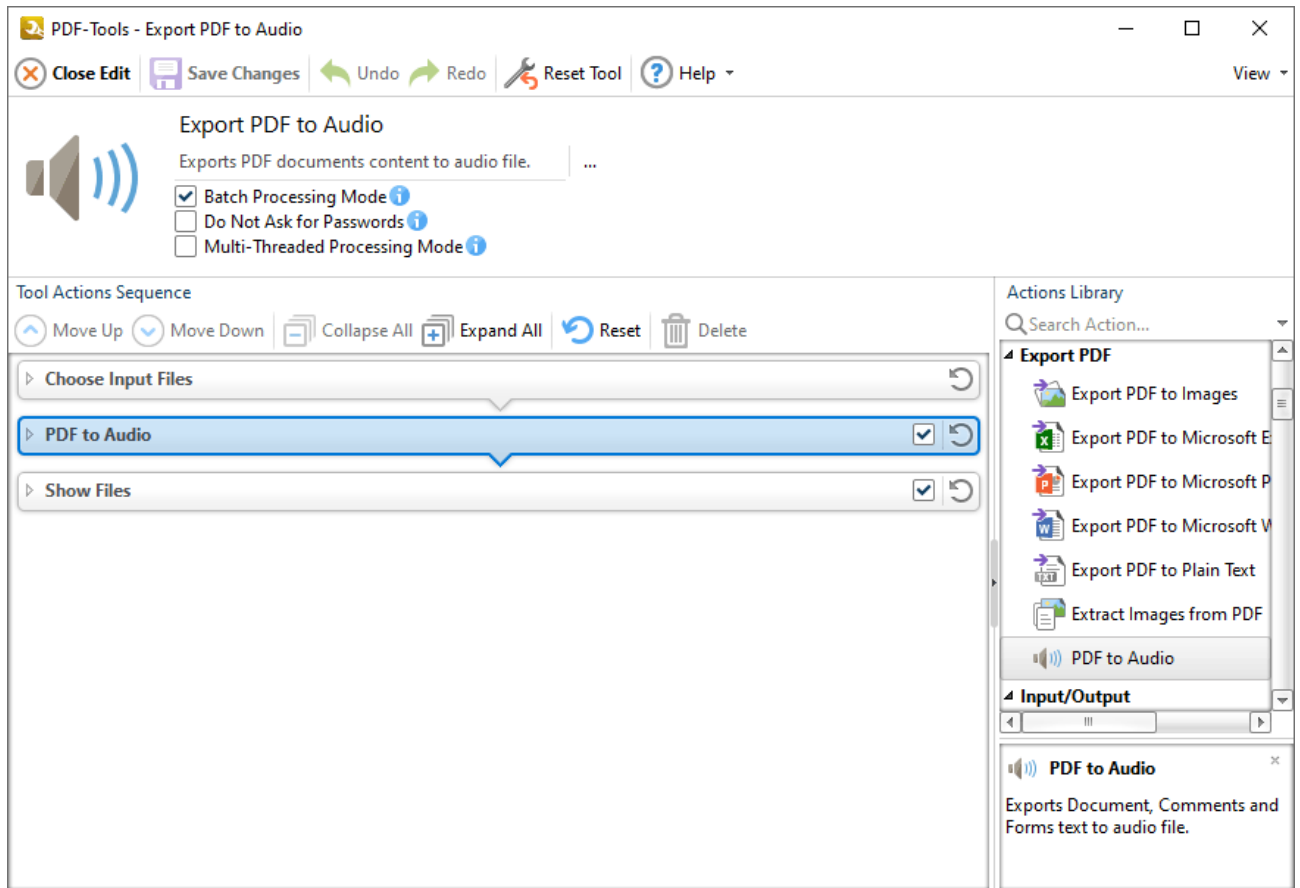





Figure 1. Export PDF to Audio Tool Actions Sequence

The **Export PDF to Images** tool uses three tool actions:

1.  **Choose Input Files**<sup>[128]</sup> - the tool prompts for source documents.
2.  **PDF to Audio**<sup>[124]</sup> - the text in source documents is copied and exported to audio format.
3.  **Show Files**<sup>[142]</sup> - the new documents are displayed in their destination folder.

Click actions to view customizable parameters. Additionally, please note that the **Clone Tool**<sup>[71]</sup> feature can be used to clone this tool and then add/remove actions from the **Tool Actions Sequence**.

Note that it is necessary to have **Media Foundation** installed on the local machine for this tool to operate, as detailed [here](#).<sup>[550]</sup>

Information about the **Batch Processing Mode**, **Do Not Ask for Passwords** and **Multi-Threaded Processing** check boxes is available [here](#).<sup>[57]</sup>

---

## 8.10.2 Export PDF to Images



### Export PDF to Images

The **Export PDF to Images** tool copies PDF documents and converts them to raster images:

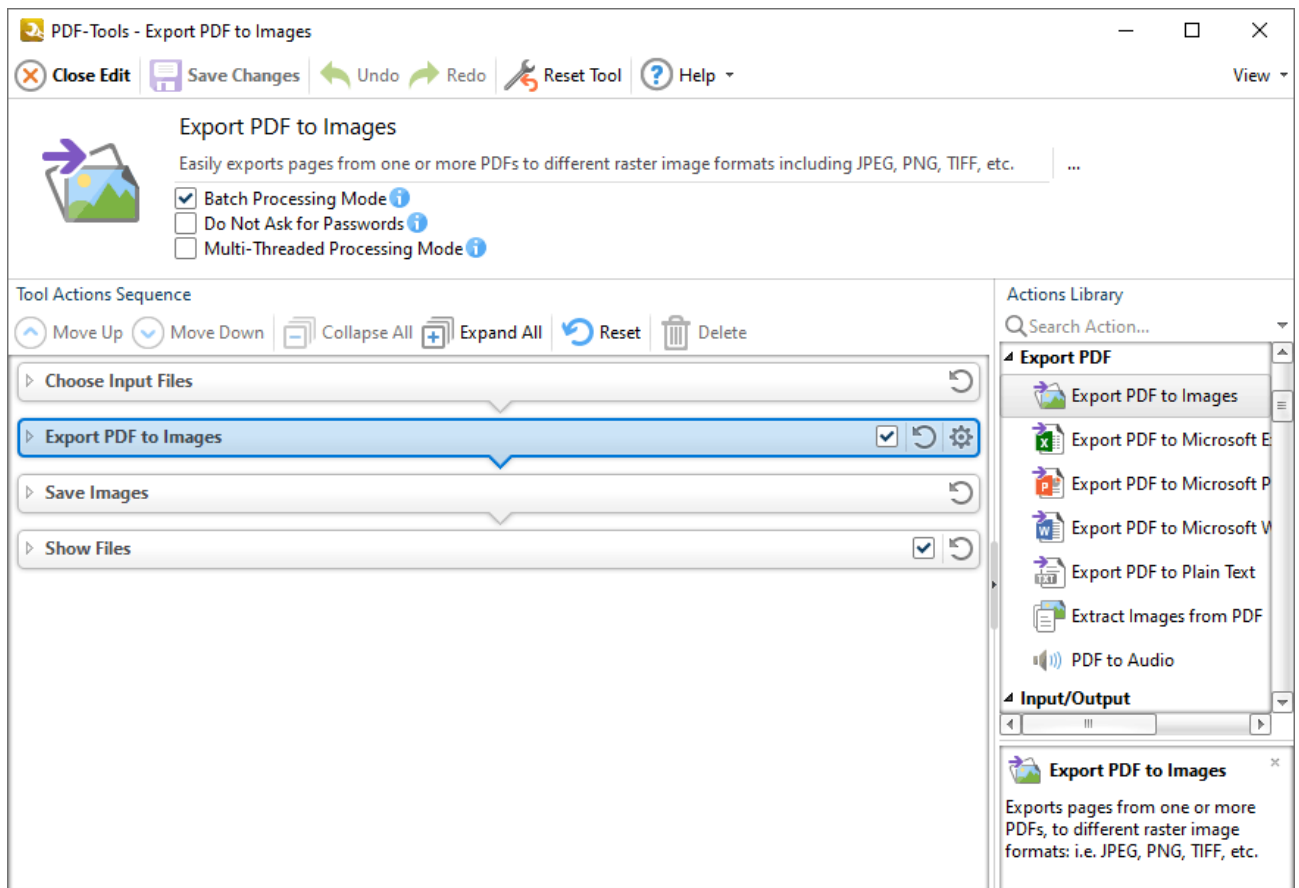





Figure 1. Export PDF to Images Tool Actions Sequence

The **Export PDF to Images** tool uses four tool actions:

1.  **Choose Input Files** <sup>[128]</sup> - the tool prompts for source documents.
2.  **Export PDF to Images** <sup>[106]</sup> - the documents are copied to image format.
3.  **Save Documents** <sup>[135]</sup> - the new documents are saved.
4.  **Show Files** <sup>[142]</sup> - the new documents are displayed in their destination folder.

Click actions to view customizable parameters. Additionally, please note that the [Clone Tool](#)<sup>[71]</sup> feature can be used to clone this tool and then add/remove actions from the **Tool Actions Sequence**.

Information about the **Batch Processing Mode, Do Not Ask for Passwords** and **Multi-Threaded Processing** check boxes is available [here](#).<sup>[57]</sup>

---



### 8.10.3 Export PDF to Microsoft Excel Spreadsheet



## Export PDF to Microsoft Excel Spreadsheet

The **Export PDF to Microsoft Excel Spreadsheet** tool copies PDF documents and converts them to **Microsoft Excel (.xlsx)** format:

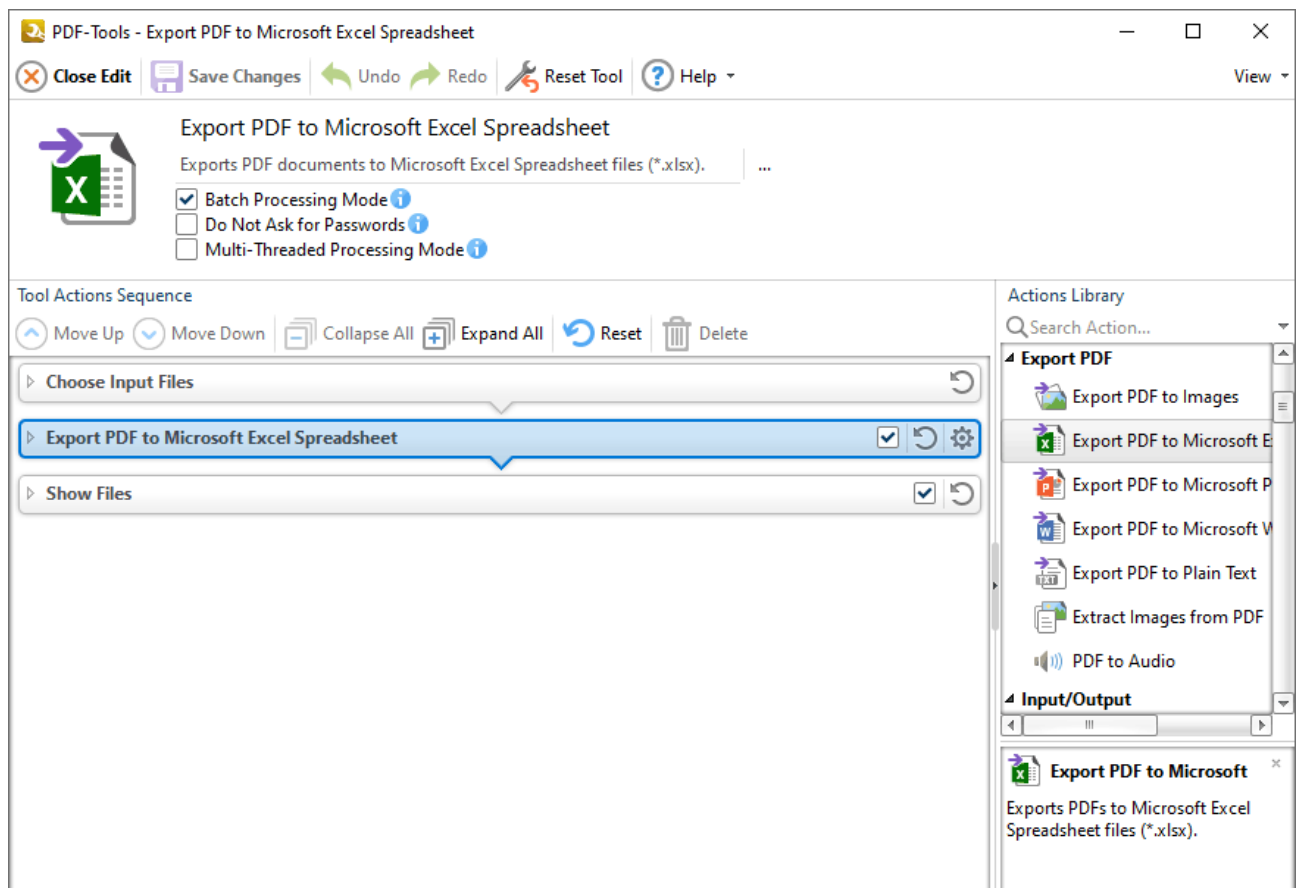





Figure 1. Export PDF to Microsoft Excel Spreadsheet Tool Actions Sequence

The **Export PDF to Microsoft Excel Spreadsheet** tool uses three tool actions:

1.  **Choose Input Files** <sup>[126]</sup> - the tool prompts for source documents.
2.  **Export PDF to Microsoft Excel Spreadsheet** <sup>[106]</sup> - the documents are copied to **Microsoft Excel (.xlsx)** format and saved.
3.  **Show Files** <sup>[142]</sup> - the new documents are displayed in their destination folder.

Click actions to view customizable parameters. Additionally, please note that the [Clone Tool](#)<sup>[71]</sup> feature can be used to clone this tool and then add/remove actions from the **Tool Actions Sequence**.

Information about the **Batch Processing Mode**, **Do Not Ask for Passwords** and **Multi-Threaded Processing** check boxes is available [here](#).<sup>[57]</sup>

---

### 8.10.4 Export PDF to Microsoft Powerpoint Presentation



## Export PDF to Microsoft Powerpoint Presentation

The **Export PDF to Microsoft Powerpoint Presentation** tool copies PDF documents and converts them to **Microsoft Powerpoint Presentation (\*.pptx)** format:

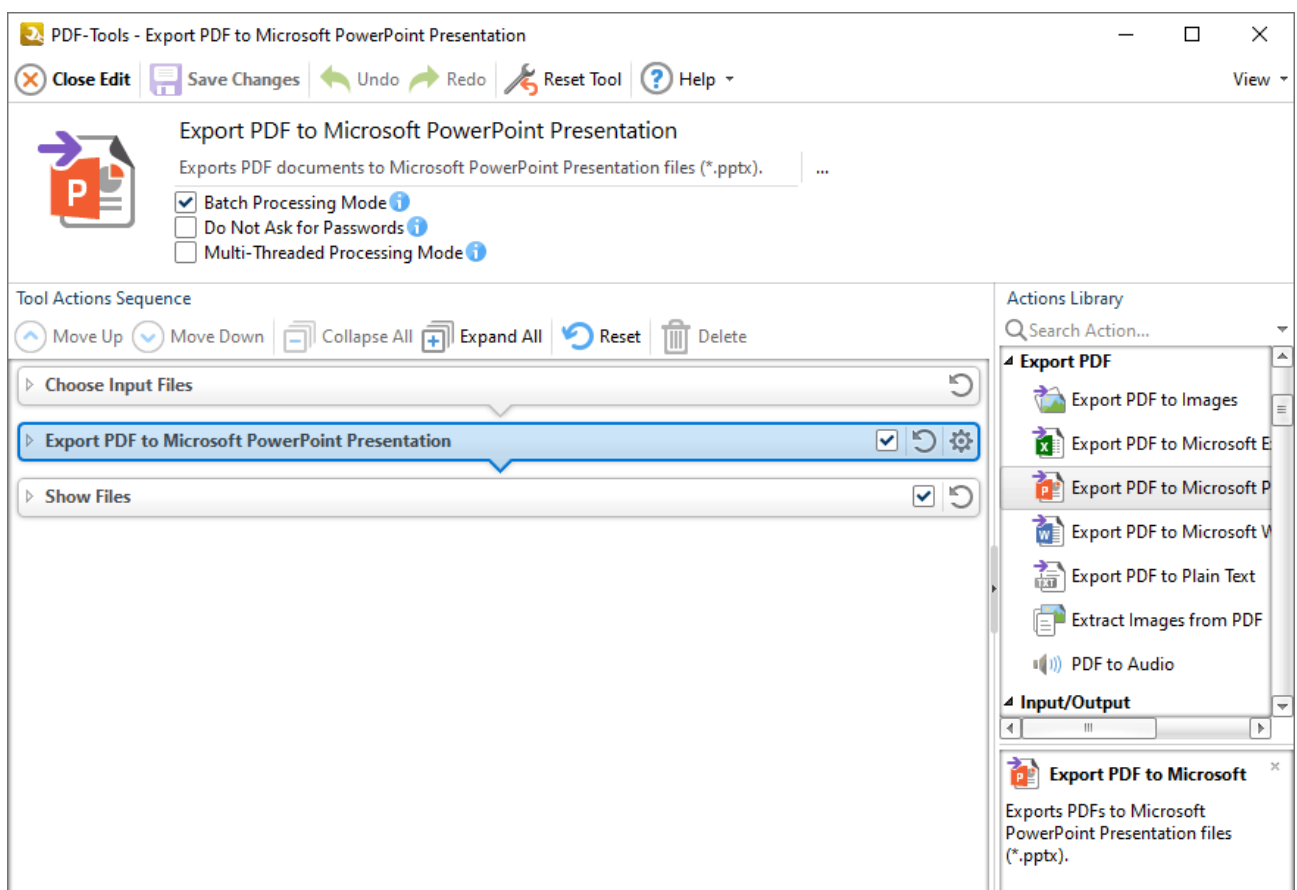





Figure 1. Export PDF to Microsoft Powerpoint Presentation Tool Actions Sequence

The **Export PDF to Microsoft Powerpoint Presentation** tool uses three tool actions:

1.  **Choose Input Files** <sup>[128]</sup> - the tool prompts for source documents.
2.  **Export PDF to Microsoft Powerpoint Presentation** <sup>[113]</sup> - the documents are copied to **Microsoft Powerpoint Presentation (\*.pptx)** format and saved.
3.  **Show Files** <sup>[142]</sup> - the new documents are displayed in their destination folder.

Click actions to view customizable parameters. Additionally, please note that the [Clone Tool](#)<sup>[71]</sup> feature can be used to clone this tool and then add/remove actions from the **Tool Actions Sequence**.

Information about the **Batch Processing Mode, Do Not Ask for Passwords** and **Multi-Threaded Processing** check boxes is available [here](#).<sup>[57]</sup>

---

### 8.10.5 Export PDF to Microsoft Word Document



## Export PDF to Microsoft Word Document

The **Export PDF to Microsoft Word Document** tool copies PDF documents and converts them to **Microsoft Word (.docx)** format:

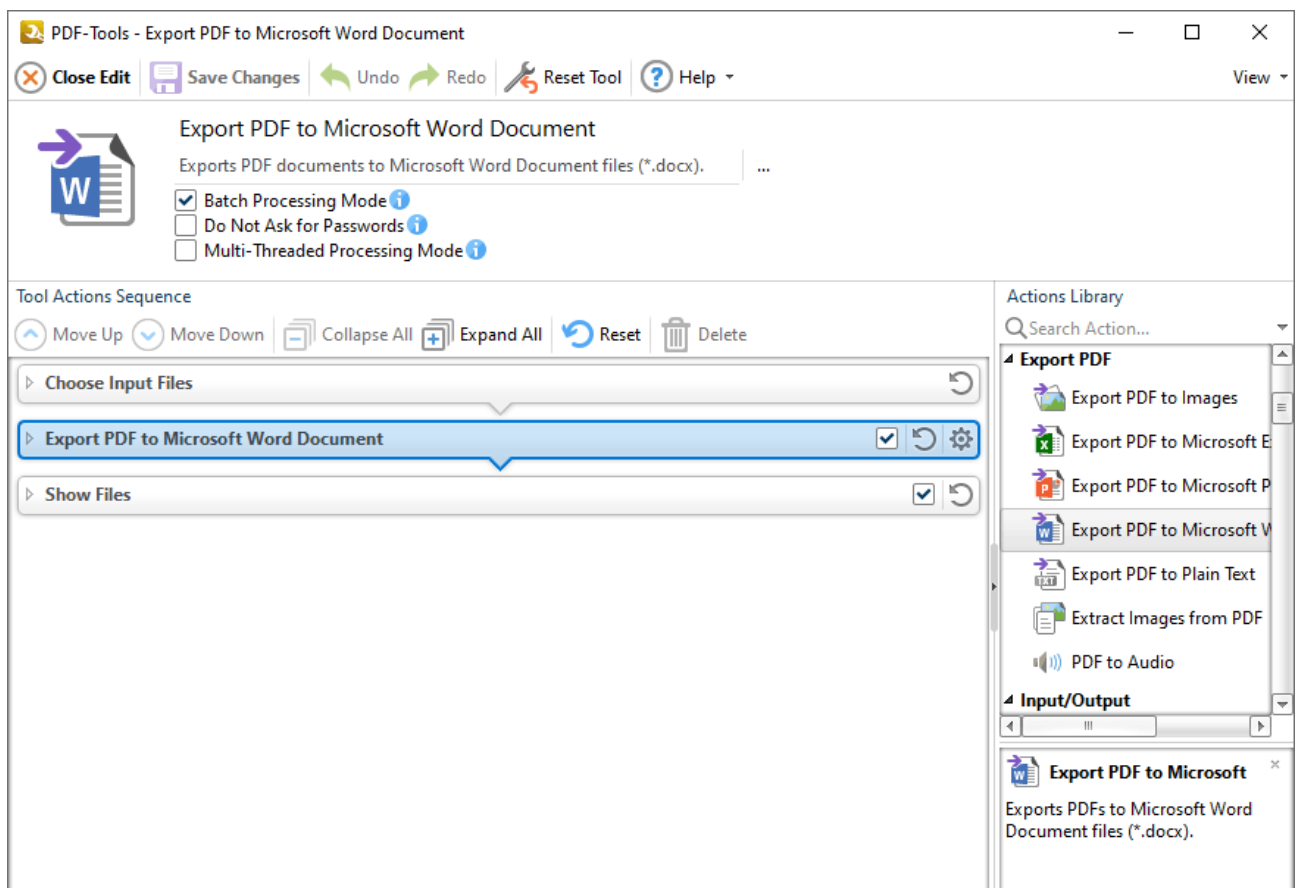





Figure 1. Export PDF to Microsoft Word Document Tool Actions Sequence

The **Export PDF to Microsoft Word Document** tool uses three tool actions:

1.  **Choose Input Files** <sup>[128]</sup> - the tool prompts for source documents.
2.  **Export PDF to Microsoft Word Document** <sup>[117]</sup> - the documents are copied to **Microsoft Word (.docx)** format and saved.
3.  **Show Files** <sup>[142]</sup> - the new documents are displayed in their destination folder.

Click actions to view customizable parameters. Additionally, please note that the [Clone Tool](#)<sup>[71]</sup> feature can be used to clone this tool and then add/remove actions from the **Tool Actions Sequence**.

Note that files exported to **(\* .docx)** format are compatible with **MS Word 2010** and later.

Information about the **Batch Processing Mode, Do Not Ask for Passwords** and **Multi-Threaded Processing** check boxes is available [here](#).<sup>[57]</sup>

---

## 8.10.6 Export PDF to Plain Text



## Export PDF to Plain Text

The **Export PDF to Plain Text** tool copies PDF documents and converts them to plain text (\*.txt) format:

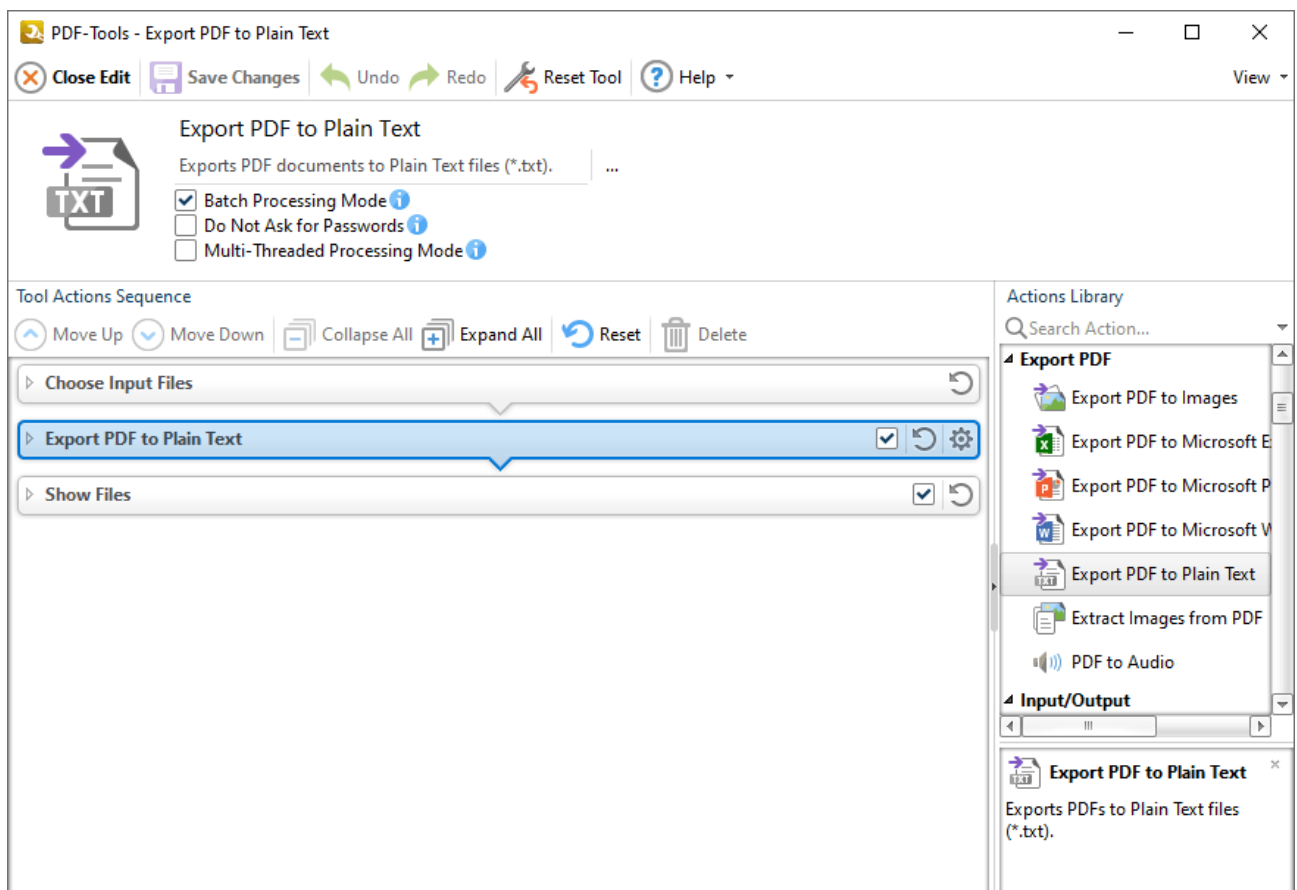





Figure 1. Export PDF to Plain Text Tool Actions Sequence

The **Export PDF to Plain Text** tool uses three tool actions:

1.  **Choose Input Files**<sup>[128]</sup> - the tool prompts for source documents.
2.  **Export PDF to Plain Text**<sup>[117]</sup> - the documents are copied to plain text (\*.txt) format and saved.
3.  **Show Files**<sup>[142]</sup> - the new documents are displayed in their destination folder.

Click actions to view customizable parameters. Additionally, please note that the [Clone Tool](#)<sup>[71]</sup> feature can be used to clone this tool and then add/remove actions from the **Tool Actions Sequence**.

Information about the **Batch Processing Mode, Do Not Ask for Passwords** and **Multi-Threaded Processing** check boxes is available [here](#).<sup>[57]</sup>

---



### 8.10.7 Extract Images from PDF



## Extract Images from PDF

The **Extract Images from PDF** tool copies images in PDF documents and saves them to a new file:

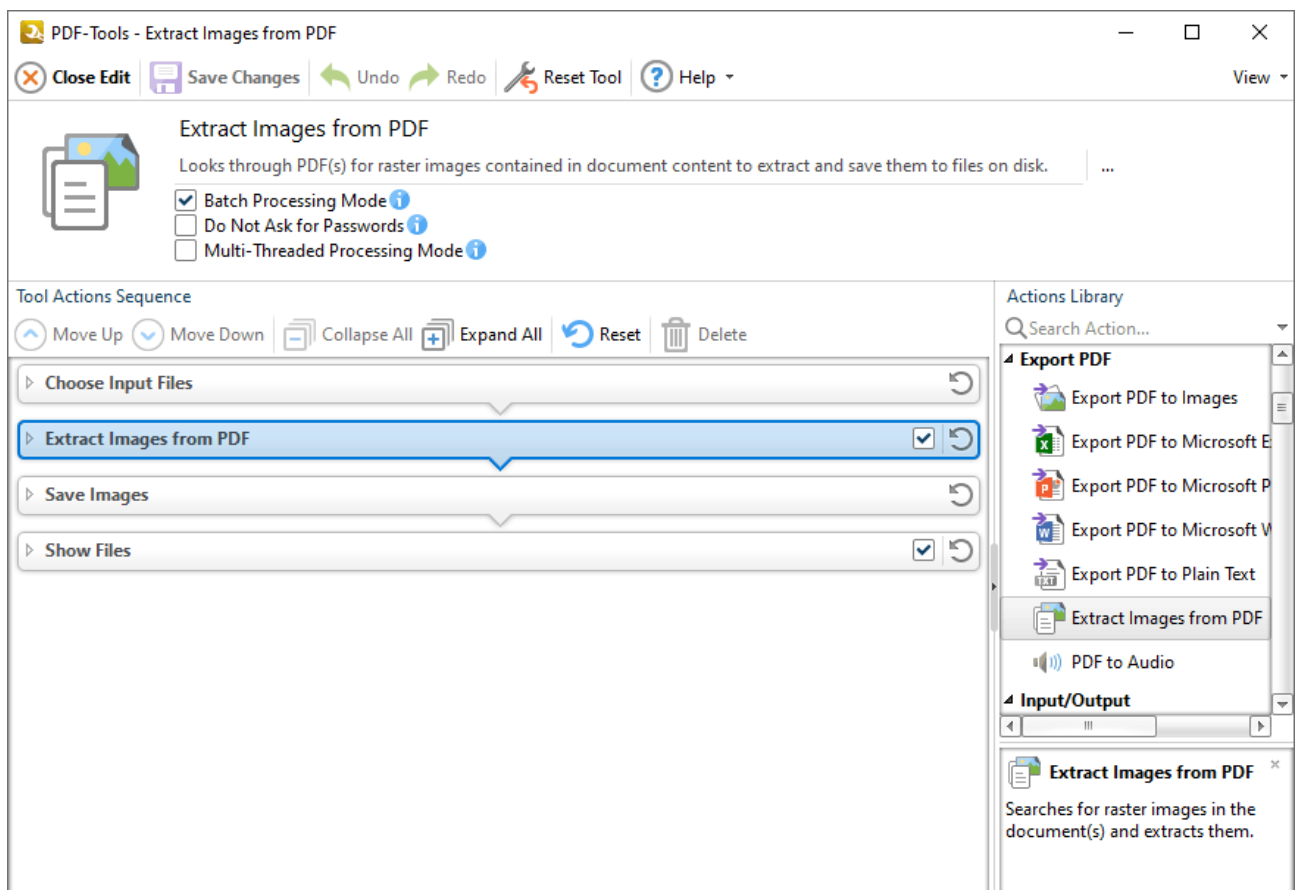





Figure 1. Extract Images from PDF Tool Actions Sequence

The **Extract Images from PDF** tool uses four tool actions:

1.  **Choose Input Files** <sup>[128]</sup> - the tool prompts for source documents.
2.  **Extract Images from PDF** <sup>[122]</sup> - all images are extracted from the documents.
3.  **Save Images** <sup>[137]</sup> - the images are saved to file.
4.  **Show Files** <sup>[142]</sup> - the new documents are displayed in their destination folder.

Click actions to view customizable parameters. Additionally, please note that the [Clone Tool](#)<sup>[71]</sup> feature can be used to clone this tool and then add/remove actions from the **Tool Actions Sequence**.

Information about the **Batch Processing Mode**, **Do Not Ask for Passwords** and **Multi-Threaded Processing** check boxes is available [here](#).<sup>[57]</sup>

---

## 8.11 Advanced Tools





---



### Advanced Tools

---

The **Advanced Tools** tools are used to email or change the properties of input documents:

-  [Change Document Properties](#)<sup>[292]</sup> is used to edit document properties.
-  [Convert Colors](#)<sup>[462]</sup> converts colors in input documents.
-  [Print Document](#)<sup>[464]</sup> is used to print input documents.
-  [Send E-Mail](#)<sup>[140]</sup> sends output documents/images via the user's desktop email client.

Note that the [Clone Tool](#)<sup>[71]</sup> and [Create Tool](#)<sup>[65]</sup> features can be used to enhance the functionality of existing tools/create new tools in order to meet complex requirements.

---

## 8.11.1 Change Document Properties



### Change Document Properties

The **Change Document Properties** tool is used to edit the properties of input documents:

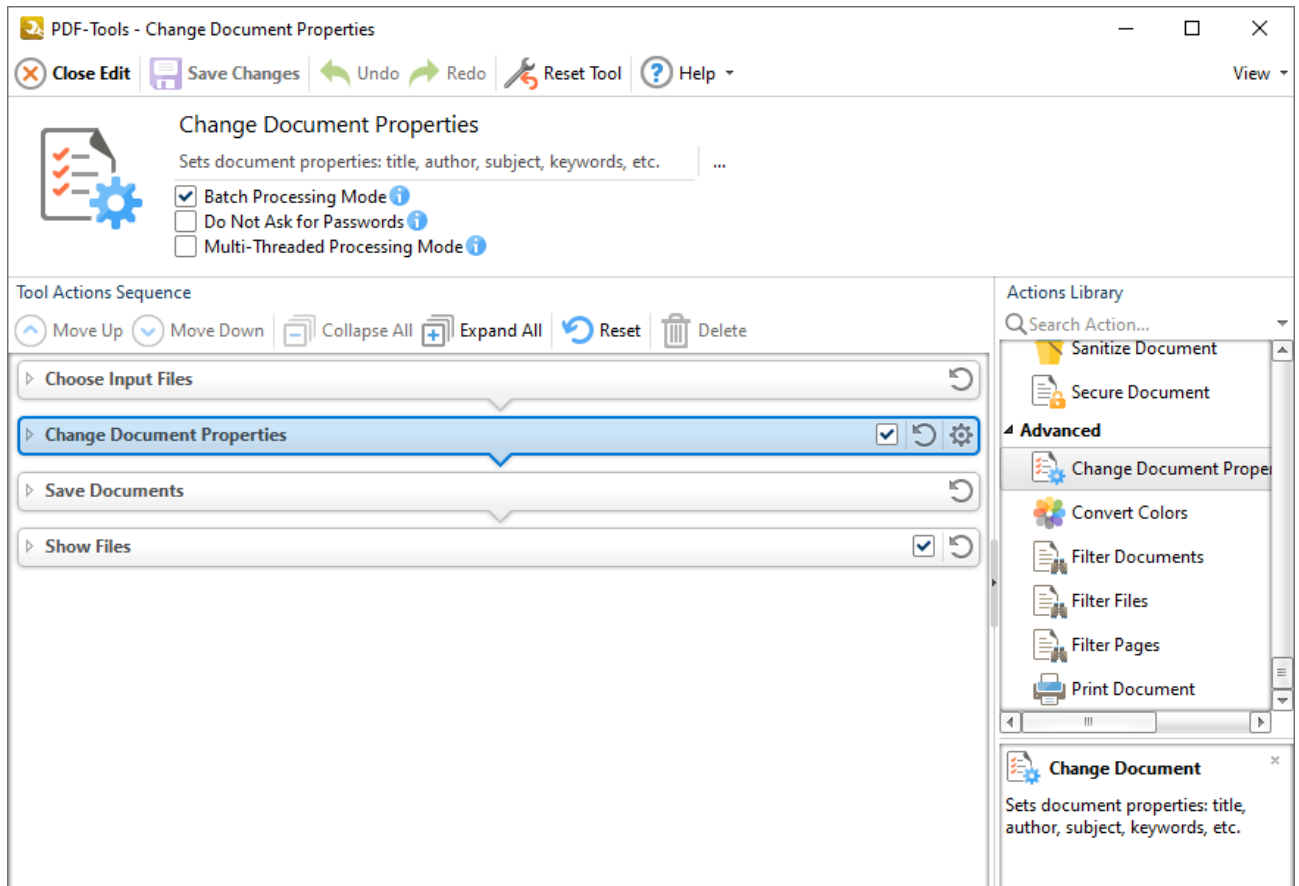





Figure 1. Change Document Properties Tool Actions Sequence

The **Change Document Properties** tool uses four tool actions:

1.  **Choose Input Files** <sup>[128]</sup> - the tool prompts for source documents.
2.  **Change Document Properties** <sup>[292]</sup> - the document properties are changed.
3.  **Save Documents** <sup>[135]</sup> - the updated documents are saved.
4.  **Show Files** <sup>[142]</sup> - the new documents are displayed in their destination folder.

Click actions to view customizable parameters. Additionally, please note that the [Clone Tool](#)<sup>[71]</sup> feature can be used to clone this tool and then add/remove actions from the **Tool Actions Sequence**.

Information about the **Batch Processing Mode, Do Not Ask for Passwords** and **Multi-Threaded Processing** check boxes is available [here](#).<sup>[57]</sup>

---

## 8.11.2 Convert Colors



## Convert Colors

The **Convert Colors** tool is used to convert colors in input documents:

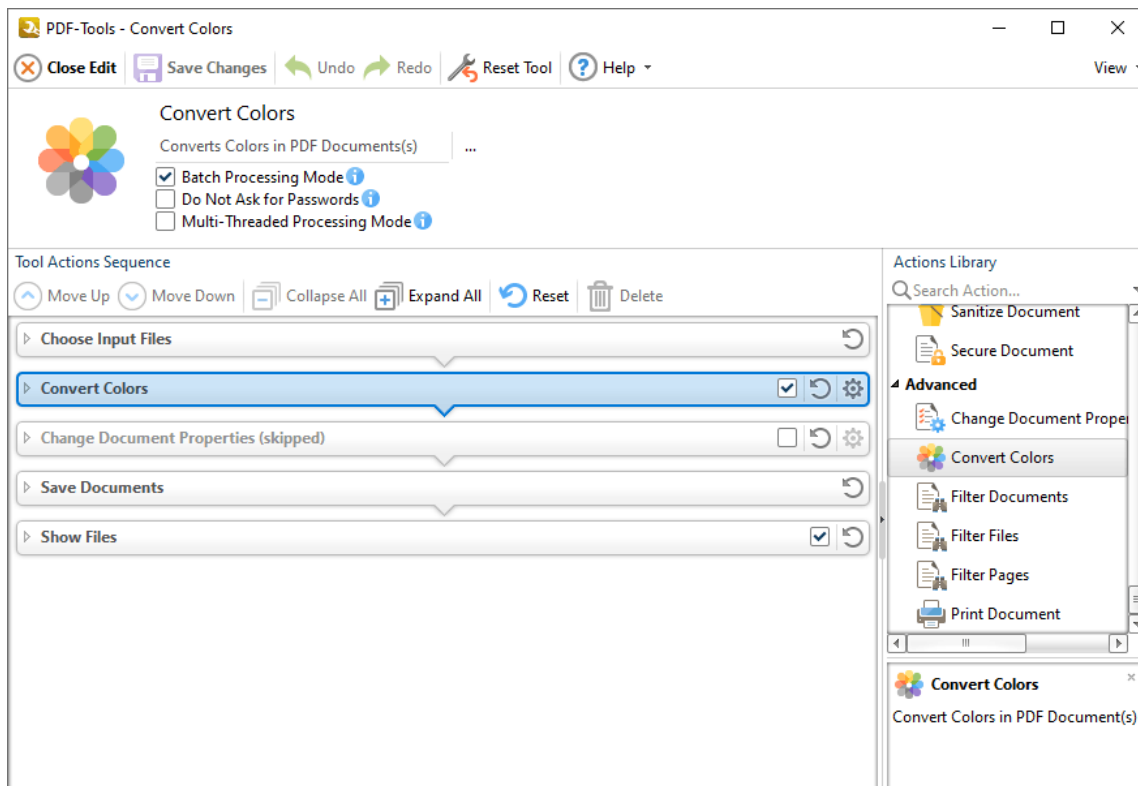







Figure 1. Convert Colors Tool Actions Sequence

The **Convert Colors** tool uses five tool actions:

1.  **Choose Input Files** <sup>[126]</sup> - the tool prompts for source documents.
2.  **Convert Colors** <sup>[299]</sup> - the colors in the document are converted.
3.  **Change Document Properties** <sup>[292]</sup> (skipped by default) - the document properties are changed.
4.  **Save Documents** <sup>[135]</sup> - the updated documents are saved.
5.  **Show Files** <sup>[142]</sup> - the new documents are displayed in their destination folder.

Click actions to view customizable parameters. Additionally, please note that the [Clone Tool](#)<sup>[71]</sup> feature can be used to clone this tool and then add/remove actions from the **Tool Actions Sequence**.

Information about the **Batch Processing Mode, Do Not Ask for Passwords** and **Multi-Threaded Processing** check boxes is available [here](#).<sup>[57]</sup>

---

## 8.11.3 Print Document



### Print Document

The **Print Document** tool is used to print input documents:

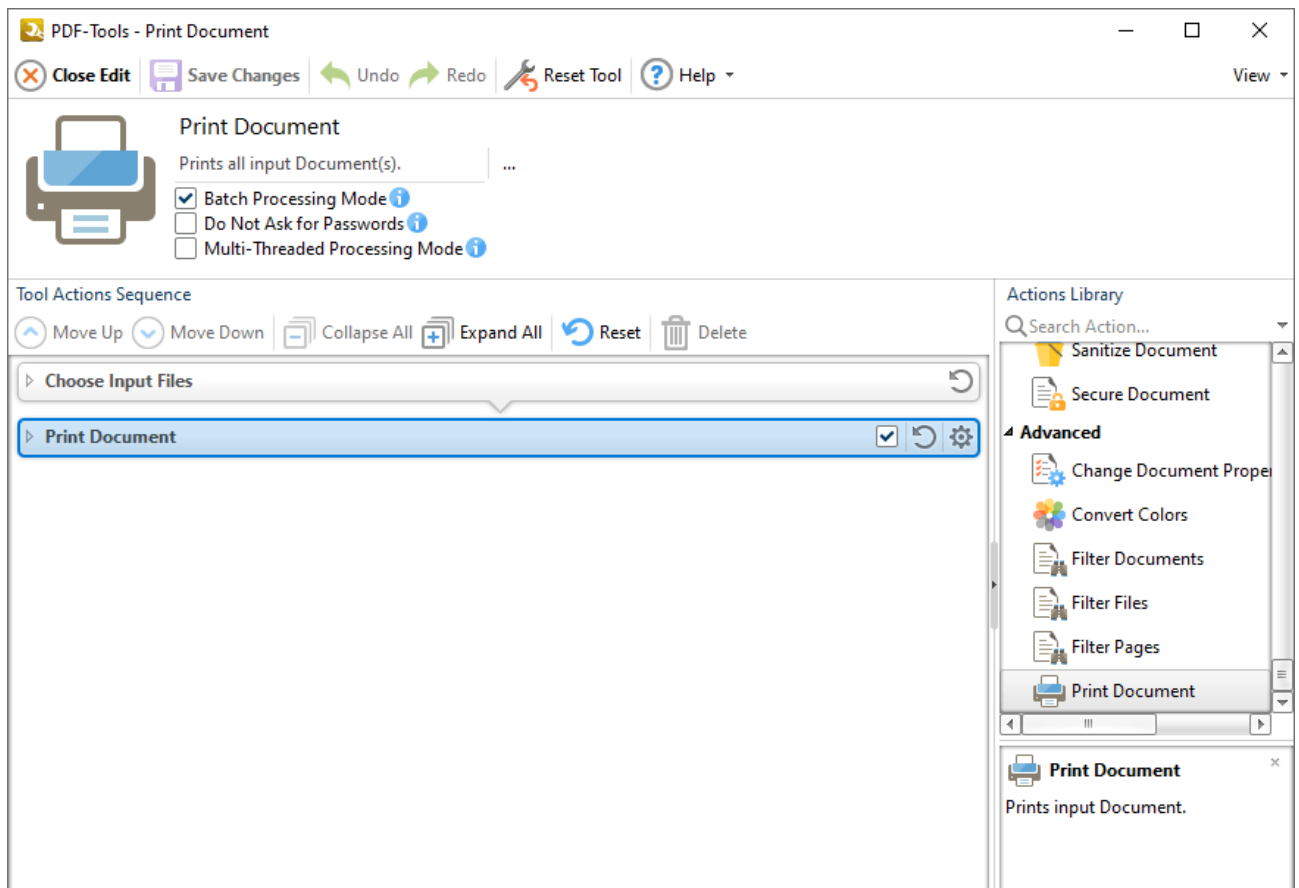



Figure 1. Print Document Tool Actions Sequence

The **Print Document** tool uses two tool actions:

1.  [Choose Input Files](#)<sup>[128]</sup> - the tool prompts for source documents.
2.  [Print Document](#)<sup>[310]</sup> - the documents are printed.

Click actions to view customizable parameters. Additionally, please note that the [Clone Tool](#)<sup>[71]</sup> feature can be used to clone this tool and then add/remove actions from the **Tool Actions Sequence**.



Information about the **Batch Processing Mode, Do Not Ask for Passwords** and **Multi-Threaded Processing** check boxes is available [here](#).<sup>[57]</sup>

---

8.11.4 Send E-Mail



The **Send E-Mail** tool is used to email documents:

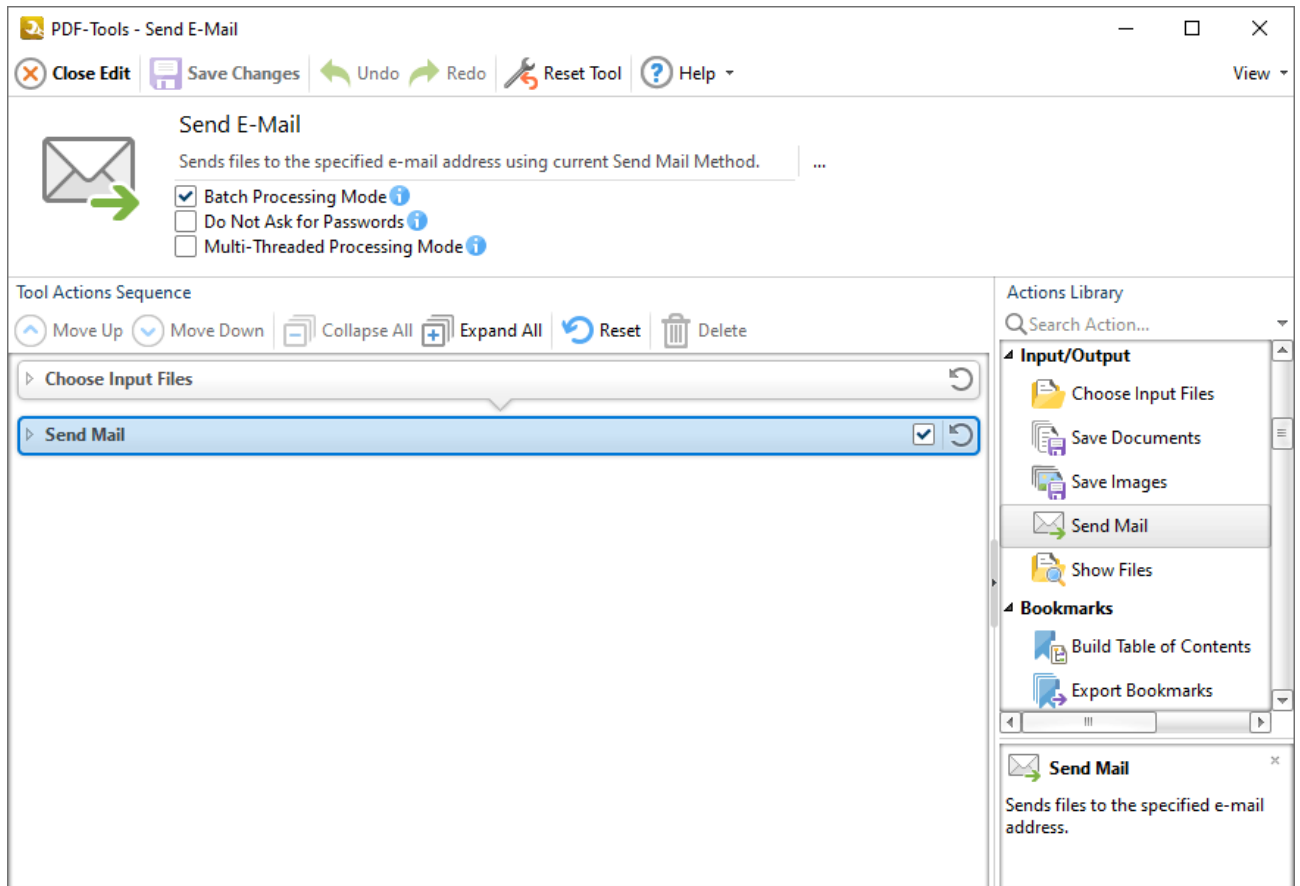



Figure 1. Send E-Mail Tool Actions Sequence

The **Send E-Mail** tool uses two tool actions:

1.  [Choose Input Files](#)<sup>[128]</sup> - the tool prompts for source documents.
2.  [Send Mail](#)<sup>[140]</sup> - the documents are emailed.

Click actions to view customizable parameters. Additionally, please note that the [Clone Tool](#)<sup>[71]</sup> feature can be used to clone this tool and then add/remove actions from the **Tool Actions Sequence**.

Information about the **Batch Processing Mode**, **Do Not Ask for Passwords** and **Multi-Threaded Processing** check boxes is available [here](#).<sup>[57]</sup>

---

## 9 Appendix

---



### Appendix

---

The following chapters detail additional information relating to the settings and functions within **PDF-Tools**. They are outlined below:

- [Available File Filters](#)<sup>[469]</sup> - further information about file filters and what they mean.
  - [Command Line Options](#)<sup>[472]</sup> - a list of the available command line options that can be used in conjunction with **PDF-Tools**.
  - [Crop Margins](#)<sup>[482]</sup> - a detailed explanation relating to the cropping of margins, including definitions of the various box features involved.
  - [Features added in Version 8](#)<sup>[484]</sup> - details all features added in version 8 of **PDF-Tools**.
  - [Font and Paragraph Options](#)<sup>[486]</sup> - further information about font and paragraph parameters.
  - [Macros](#)<sup>[488]</sup> - an explanation of what macros are and how they are used.
  - [Page Range Options](#)<sup>[552]</sup> - further details and options that relate to page ranges.
  - [Preferences](#)<sup>[554]</sup> - customizable options available in **PDF-Tools**.
  - [Scanner Settings](#)<sup>[574]</sup> - options that relate to scanner settings.
-

## 9.1 Available File Filters



### Available File Filters

The **Available File Filters** dialog box is used to determine permitted file formats in **PDF-Tools**:

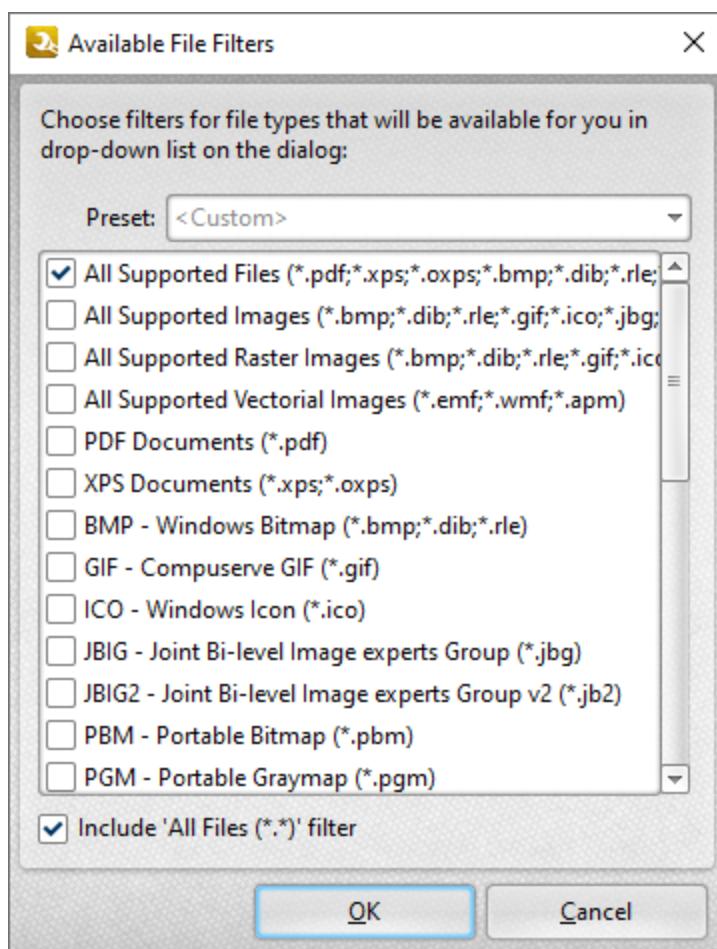

**Figure 1.** Available File Filters Dialog Box

Click the **Preset** dropdown menu to select a preset mode, or select boxes in the dialog box to specify permitted formats. The following options are available:

- **All Supported Files** supports all file formats.
- **All Supported Images** supports raster and vector images.
- **All Supported Raster Images** supports only raster images.
- **All Supported Vectorial Images** supports only vector images.
- **PDF Documents** are documents saved in portable document format.
- **XPS Documents** are documents saved in the **(\*xps)** and **(\*oxps)** paper specification formats.
- **BMP** files are bitmap digital images.
- **GIF** files are raster graphic files that are usually animated.
- **ICO** files are image files formatted for use as icons in **Microsoft Windows**.
- **JBIG** is a lossless image-compression standard that fax machines use.
- **JBIG2** is an image-compression standard for bi-level images. It supports both lossless and lossy compression.
- **PBM** is a portable bitmap image format used and defined by the **Netbpm Project**.
- **PPM** is the pixmap images version of **PBM**.
- **PGM** is the grayscale version of **PBM**.
- **TGA** is a raster graphics file format.
- **PCX** is an image file format and the native file format of **PC Paintbrush**.
- **DCX** is a file extension for a bitmap/raster graphics file format that **Multipage PCX** uses.
- **PNG** is a raster graphics file format that supports lossless data compression.
- **JPEG** is used for photographs and other image files where the file size is necessarily small.
- **JPEG 2000** is an image compression standard and coding system with several improvements from the original JPEG format.
- **TIFF** is a common format for exchanging raster graphics between application programs.
- **XDP** is an **XML** format that allows PDF content and **XFA** resources to be packaged within an **XML** container.
- **Metafiles (\*.emf;\*.wmf;\*.apm)** are portable image formats that can contain both vector graphics and bitmap components.
- **MS Word Document** is the standard document format of **Microsoft Word**.
- **MS Excel Spreadsheet** is the standard document format of **Microsoft Excel**.
- **MS Power Point Presentation** is the standard document format of **Microsoft Power Point**.
- **MS Visio Drawing** is the standard document format of **Microsoft Visio**.
- **Rich Text Format (\*.rtf)** is a proprietary document file format developed by the **Microsoft Corporation** and used for cross-platform document interchange with **Microsoft** products.
- **Plain Text** displays data in files that represent only readable characters.

Click **OK** to save settings.

Note that permitted file formats can be customized for each tool. Open the **Tool Actions Sequence** for the tool, then click the **Choose Input Files** dropdown menu and click the ellipsis icon to customize permitted file formats:

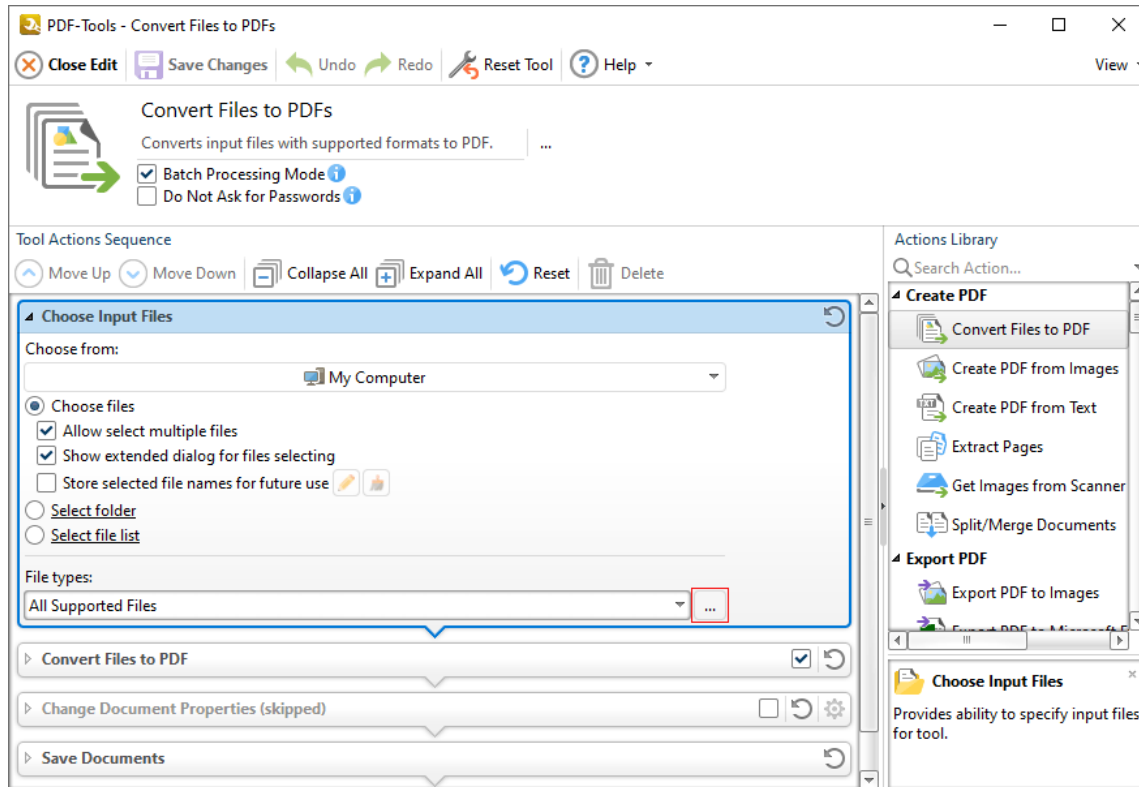

**Figure 1.** Convert Files to PDFs Tool Actions Sequence, Edit Permitted File Formats Ellipsis Highlighted

## 9.2 Command Line Options

---



### Command Line Options

---

The command line options listed below are available for **PDF-Tools**. Please note:

- If any values have spaces, backslashes or forwardslashes then the entire options list should be enclosed in quotation marks.
- If the **optionslistfile** contain spaces then it must be enclosed in quotation marks.
- If a profile is specified, changes will be made to that profile. If not then the changes will apply to the current printer's settings.
- These options are for the **PDFXTools.exe** executable, the default location of which is:

```
"C:\Program Files\Tracker Software\PDF Tools\PDFXTools.exe"
```

- Unless the path to **PDFXTools.exe** is added to the system %path% variable, the full path to **PDFXTools.exe** must be specified.
  - Use semicolons to delimiter options when more than one option is being used.
- 

### Formal Syntax

---

**<anytext>** means any text string.

**<a>|<b>** means <a> **or** <b>.

**<filename>** means full or relative path to file. When the path contains white spaces it should be enclosed in quotation marks. For example: c:\MyDocuments\MyTestDocument.pdf should be "c:\My Documents\My Test Document.pdf".

**[expression]** is the optional part of the command line. For example if the syntax is: **/RunTool[:showui=yes|no][;showprog=yes|no][;showrep=yes|no] <ToolID> [<filename1> [<filename2> ... <filenameN>]]** then the following examples are correct:



```
/RunTool imagesToPDF  
/RunTool imagesToPDF "c:\picture1.png" "c:\picture2.png"  
/RunTool:showprog=no imagesToPDF "c:\picture1.png" "c:\picture2.png"
```

---

## Command Line Options

---

### **/DumpCategories**

This command line saves identifiers of all existing tool categories to a plain text file.

#### **Syntax**

```
/DumpCategories <filename>
```

#### **Parameters**

- **<filename>** - is the path to the text file where identifiers of all existing tool categories will be saved.

#### **Example**

```
PDFXTools.exe /DumpCategories "c:\PDF-Tools.txt"
```

---

### **/DumpTools**

This command line saves identifiers of all existing tools to a plain text file.

#### **Syntax**

```
/DumpTools <filename>
```

#### **Parameters**

- **<filename>** - is the path to the text file where identifiers of all existing tools will be saved.

#### **Example**

```
PDFXTools.exe /DumpTools "c:\PDF-Tools.txt"
```

---

## **/ExportSettings**

This command line exports all program settings to a specified file.

### **Syntax**

**/ExportSettings <filename>**

### **Parameters**

- **<filename>** - is the path to the file where program settings will be saved.

### **Example**

**PDFXTools.exe /ExportSettings "c:\PDF-Tools\_AppSettings.pdts"**

---

## **/ExportTools**

This command line exports tools and their settings to a specified file.

### **Syntax**

**/ExportTools[:showui=no|yes|full] <filename>**

### **Parameters**

- **showui** - if 'yes' is specified then the **Choose Tools for Export** dialog box will be displayed. This allows users to select manually the tools to be exported. If 'full' is specified then the main window of the user interface will also be displayed. The default value is 'yes'.
- **<filename>** - is the path to the file where exported tools will be saved.

### **Example**

**PDFXTools.exe /ExportTools:showui=full "c:\PDF-Tools\_Exchange.pdtx"** - to export tools via the **Choose Tools for Export** dialog box and display the main window of the user interface.

---

## **/ImportSettings**

This command line imports program settings/tools from a specified file.

### **Syntax**

```
/ImportSettings[:showui=no|yes|full] <filename>
```

### **Parameters**

- **showui** – if 'yes' is specified and the **<filename>** is a path to a **PDF-Tools** export file then the **Choose Tools for Import** dialog box will be displayed. This allows users to select manually the tools to be imported. (If settings are being imported then the import will take place without a dialog box). If 'full' is specified then the main window of the user interface will be displayed, and if the **<filename>** is a path to a **PDF-Tools** tools export file then the **Choose Tools for Import** dialog box will also be displayed. The default value is 'yes'.
- **<filename>** - is the path to the file that contains program settings/tools. These can be created using the **/ExportSettings** or **/ExportTools** commands (or the corresponding features in the user interface).

### **Examples**

**PDFXTools.exe /ImportSettings "c:\PDF-Tools\_AppSettings.pdts"** - to import all settings from the file **"c:\PDF-Tools\_AppSettings.pdts"**.

**PDFXTools.exe /ImportSettings:showui=full "c:\PDF-Tools\_Exchange.pdtx"** - to display the main window of the user interface and import tools from the file **"c:\PDF-Tools\_Exchange.pdtx"** via the **Choose Tools for Import** dialog box.

---

## **/ImportTools**

This command line imports tools to **PDF-Tools**.

Please note that this tool is identical to the **/Open** and **/ImportSettings** command line options in cases where the **<filename>** contains a path to a file that contains exported tools.

### **Syntax**

```
/ImportTools[:showui[=no|yes|full]] <filename>
```

### **Parameters**

- **showui** – if 'yes' is specified then the **Choose Tools for Import** dialog box will be displayed. This allows users to select manually the tools to be imported. If 'full' is specified then the main window of the user interface will also be displayed. The default value is 'yes'.
- **<filename>** - is the path to the file that contains previously exported tools. The **/ExportTools** command (or the corresponding feature in the user interface) can be used to export tools to file.

### Examples

**PDFXTools.exe /ImportTools "c:\my-custom-tools.pdtx" -** to import all tools from the file "c:\my-custom-tools.pdtx".

**PDFXTools.exe /ImportTools:showui "c:\pdf-tools.pdtx" -** to import tools from the file "c:\pdf-tools.pdtx" via the **Choose Tools for Import** dialog box.

**PDFXTools.exe /ImportTools:showui=full "c:\pdf-tools.pdtx" -** to import tools from the file "c:\pdf-tools.pdtx" via the **Choose Tools for Import** dialog box and display the main window of the user interface.

---

### /Open

This command line imports tools/program settings for **PDF-Tools** that have been exported to file.

### Syntax

**/Open[:showui=no|yes|full] <filename>**

### Parameters

- **showui** - if 'yes' is specified and the **<filename>** is a path to a **PDF-Tools** export file then the **Choose Tools for Import** dialog box will be displayed. This allows users to select manually the tools to be imported. If 'full' is specified then the main window of the user interface will be displayed, and if the **<filename>** is a path to a **PDF-Tools** tools export file then the **Choose Tools for Import** dialog box will also be displayed. The default value is 'yes'.
- **<filename>** - is the path to the file that contains exported tools/program settings. The **/ExportSettings** or **/ExportTools** commands (or the corresponding features in user interface) can be used to create these files.

### Examples

**PDFXTools.exe /Open "c:\my-custom-tools.pdtx" -** to import all tools from the file "c:\my-custom-tools.pdtx".

**PDFXTools.exe /Open "c:\pdf-tools-settings.pdts"** - to import all program settings from the file "c:\pdf-tools-settings.pdts".

**PDFXTools.exe /Open:showui "c:\pdf-tools.pdtx"** - to import tools from the file "c:\pdf-tools.pdtx" via the **Choose Tools for Import** dialog box.

**PDFXTools.exe /Open:showui=full "c:\pdf-tools.pdtx"** - to import tools from the file "c:\pdf-tools.pdtx" via the **Choose Tools for Import** dialog box and display the main window of the user interface.

---

## /Output

This command line specifies parameters for the output action of the tool when it runs.

### Syntax

```
/Output[:folder=ask|source|path][;filename][;overwrite=yes|makeunique|ask|no]  
[:showfiles=yes|openfolder|no]
```

### Parameters

- **folder** - determines the output path. If 'ask' is specified then the **Choose Folder** dialog box will be displayed when the tool runs. If 'source' is specified then the source folder path will be used as the output path. If "\"<path>" is specified then <path> will be used as the output path. If no value is specified then the output action will take the output path from the tool settings. If the **folder** parameter is not specified then the tool settings that determine the output folder will be used.
- **filename** - determines the name template for generating the names of the output files. Users must provide the name template for this parameter as it does not have a default value. If the **filename** parameter is not specified then tool settings that determine the output filename will be used.
- **overwrite** - determines the action taken in cases where the output filename is already in use. If 'yes' (or no value) is specified then existing files will be overwritten with the new files. If 'makeuniq' is specified then a unique file name will be generated. If 'ask' is specified then a dialog box for selecting an overwrite action will be displayed. If 'no' is specified then the file will be skipped. If the **overwrite** parameter is not specified then the tool settings that determine the overwrite action will be used.
- **showfiles** - determines whether or not the output files are displayed in their destination folder. If 'yes' (or no value) is specified then the tool settings will be used. If 'openfolder' is specified then the output folder will be opened and the output files will be selected. If 'no' is specified then the output files will not be displayed. If the **showfiles** parameter is not specified then the tool settings that determine the show files action will be used.

## Examples

**PDFXTools.exe /RunTool imagesToPDF /Output:folder=\ "D:\PDFs from images\";filename=\ "%[Date].pdf\";overwrite=makeuniq;showfiles=no** - to run the **Create PDF from Images** tool, save the result to the **"D:\PDFs from images"** path, name the output files using the **"%[Date].pdf"** name template, automatically generate unique filenames and not display the output files.

**PDFXTools.exe /RunTool pdfToDOCX /Output:folder=ask;overwrite=yes;showfiles=yes** - to run the **Export PDF to Microsoft Word Document** tool, ask for the folder in which to save files, overwrite existing files in cases where filenames are already in use and use tool settings to determine the show file action.

---

## **/ResetSettings**

This command line restores all program settings to their default state.

### Syntax

**/ResetSettings**

### Parameters

There are no available parameters for this command line option.

### Example

**PDFXTools.exe /ResetSettings**

---

## **/RunFldMon**

This command line launches a folder monitor. The GUID of the folder must be used to specify it.

### Syntax

**/RunFldMon <FolderMonID>**

### Parameters

<**FolderMonID**> must be the GUID of the the folder monitor to be launched. The GUID of folder monitors can be retrieved from the context menu of the **Folder Monitors** dialog box. Right-click the dialog box to select this option.

### Example

```
PDFXTools.exe /RunFldMon {23954F34-C10B-4819-B15B-D35631D3CD94}
```

---

### /RunTool

This command line runs the specified tool. If custom tools are used then it is necessary to specify the GUID of the tool. (The **/DumpTools** command line, detailed above, can be used to create a breakdown of all existing tools and their identifiers).

### Syntax

```
/RunTool[:showui=yes|no][;showprog=yes|no][;showrep=always|yes|no][;sort=name|size|
mdate|cdate[,dsc]][;subfolder=yes|no] <ToolID> [<foldername> |<filename1> >
[<filename2> ... <filenameN>]] [/Log[:full=yes|no][;shared] <logfile>]
[/Output[:folder[=ask|source\"<path>\"];filename=\"<name_template>\"]
;overwrite[=ask|yes|no|makeuniq]][;showfiles=[no|yes|openfolder]]]
```

### Parameters

- **showui** - if 'yes' is specified then the main window of the user interface will be displayed. The default value is 'no'.
- **showprog** - if 'yes' is specified then the progress bar will be displayed. The default value is 'yes'. Please note that when **showui=yes** is specified then **showprog=no** will be ignored.
- **showrep** - if 'yes' is specified then the **Tool Report** pane will be displayed when errors/warnings occur during the operation of tools. If 'always' is specified then the **Tool Report** pane will always be displayed. The default value is 'yes'.
- **sort** - sorts input files by **name**, creation date (**cdate**), modification date (**mdate**) and **size**. See below for examples.
- **<ToolID>** - specifies the tool to run. The string that contains the GUID of the tool must be used to identify the tool. (The **/DumpTools** command line, detailed above, can be used to create a breakdown of all existing tools and their identifiers).
- **<filename1> ... <filenameN>** - is an optional list of input files that the specified tool will process. It is also possible to specify folders, in which case the tool will process all corresponding files recursively.
- **[<foldername> |<filename1> [<filename2> ... <filenameN>]]** - is an optional parameter that can be used to specify the full or relative path to a folder, or to list full or relative file

names. If the path used contains white spaces then it must be enclosed in quotation marks. For example **C:\My Documents\My Test Document.pdf** must be entered as "**C:\My Documents\My Test Document.pdf**".

- **subfolder** - if 'yes' (or an empty value) is specified then the '**Choose Input Files**' action of tools will also search for input files in the subfolders of the folder specified in the command. If 'no' is specified then the '**Choose Input Files**' action of tools will look for files only in the specified folder and will skip all nested folders. If the '**subfolder**' option is not specified then the parameters of the '**Choose Input Files**' action will be used to determine which folders/subfolders are searched.

### Examples

**PDFXTools.exe /RunTool imagesToPDF**

**PDFXTools.exe /RunTool imagesToPDF "c:\picture1.png" "c:\picture2.png"**

**PDFXTools.exe /RunTool:showprog=no;showrep=no imagesToPDF "c:\picture1.png" "c:\picture2.png"**

**PDFXTools.exe /RunTool:showprog=no;showrep=no imagesToPDF "c:\FolderWithPictures"**

**PDFXTools.exe "/RunTool:sort=size" imagesToPDF "c:\FolderWithPictures"** - to run the **Create PDF from Images** tool and order files from the smallest to the largest.

**PDFXTools.exe "/RunTool:sort=mdate,dsc" imagesToPDF "c:\FolderWithPictures"** - to run the **Create PDF from Images** tool and order files and from the most recently modified file.

**/Log** - creates a log when the tool runs and then writes it to file. This option has the parameter **full**, which determines the messages included in the log. If 'yes' is specified then all application messages will be written to the log. If 'no' is specified then the only default messages (errors, warnings and summary information) will be written to the log. The **/Log** option has the parameter **shared**. If this parameter is specified then the file specified by **<logfile name>** can be shared between different instances of **PDF-Tools** running in command line mode at the same time.

The **Tool Report** settings determine the default messages included in the log.

### Examples

**PDFXTools.exe /RunTool imagesToPDF /Log:full "c:\pdf-tools.log"** - to run the **Create PDF from Images** tool and create a full log when the tool runs.

**PDFXTools.exe /RunTool imagesToPDF "c:\MyPhotos\" /Log:full=no "c:\pdf-tools.log"** - to run the **Create PDF from Images** tool, process all files in the folder "**MyPhotos**" and create a full log when the tool runs.

**PDFXTools.exe /RunTool imagesToPDF /Log:full;shared "c:\pdf-tools.log"** - to run the **Create PDF from Images** tool, create a full log when the runs and make the **pdf-tools.log** file available to other instances of **PDF-Tools** running in command line mode.





### 9.3 Crop Margins

---



#### Crop Margins

---

PDF documents feature up to five boxes that determine their content and appearance. They are the **Media Box**, **Crop Box**, **Bleed Box**, **Trim Box** and **Art Box**:

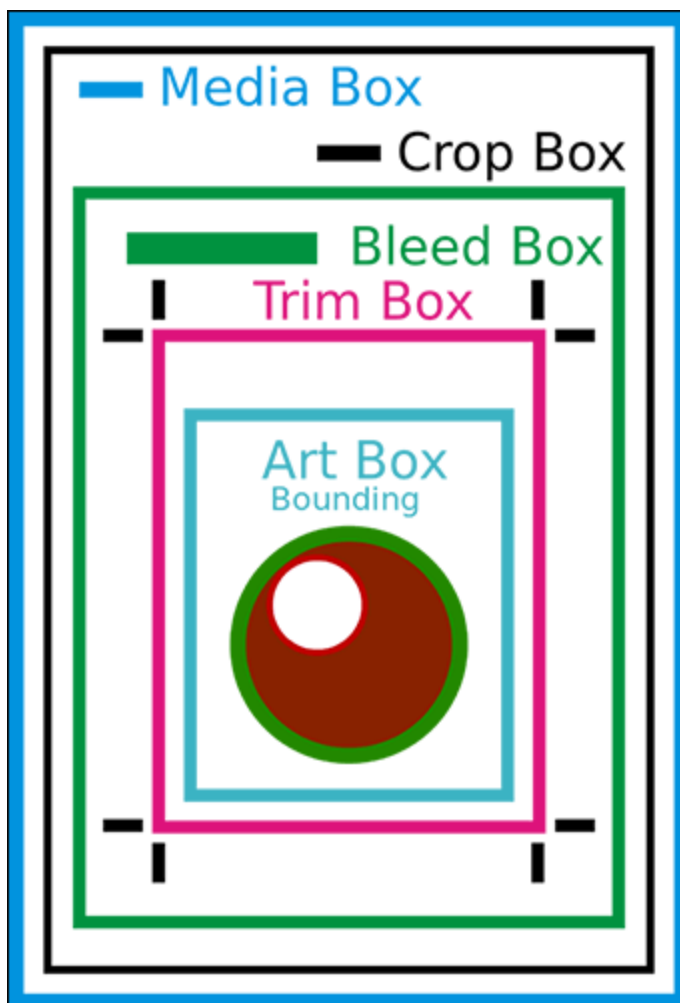

Figure 1. Document Boxes

**PDF-Tools** uses four of these boxes to determine customizable settings:

## Crop Box

The **Crop Box** defines the region to which page contents are clipped when displayed or printed. Programs use the dimensions of this box for screen display and printing. Unlike the other boxes, the **Crop Box** has no defined meaning in terms of physical page geometry or intended use - it merely imposes clipping on page contents. However, in the absence of additional information, the **Crop Box** determines how the page contents will be positioned on the output medium.

## Bleed Box

The **Bleed Box** defines the region to which the contents of the page are clipped when output in a production environment. This may include the "bleed area" needed to accommodate the physical limitations of cutting, folding and trimming equipment. Usually the **Bleed Box** is three to five millimeters larger than the **Trim Box**. When a page is printed it may include printing marks that fall outside the **Bleed Box**. The default value of the **Bleed Box** is the value of the **Crop Box**.

## Trim Box

The **Trim Box** defines the intended dimensions of the finished page after trimming has taken place. As opposed to the **Crop Box**, the **Trim Box** is very important because it defines the actual page size. Programs use the **Trim Box** as the basis for positioning pages on a press sheet. The default value of the **Trim Box** is the value of the **Crop Box**.

## Art Box

The **Art Box** defines the extent of the page's meaningful content (including potential white space) as intended by the page's creator. The default value for the **Art Box** is the value of the **Crop Box**.

See [here](#) for further information on document boxes.

---

## 9.4 Features Added in Version 8

---



### Features Added in Version 8

---

The following features were added in **Version 8** of **PDF-Tools**:

#### Version 8.0.330.0

- The **Enhanced OCR** module - an optional extra in **PDF-XChange Editor** that is much faster, provides better quality, recognizes text styles and tables, supports creating PDF files with editable text and images, and more. This feature is detailed [here](#)<sup>[219]</sup> and you can read more about it [here](#).
- The **Convert Colors** tool/action, as detailed [here](#)<sup>[462]</sup> and [here](#)<sup>[299]</sup> respectively.
- The **Filter Pages** action, as detailed [here](#)<sup>[308]</sup>
- The **Filter Documents** action, as detailed [here](#)<sup>[304]</sup>
- The **Filter Files** action, as detailed [here](#)<sup>[306]</sup>

#### Version 8.0.332.0

- Functionality added that enables the creation and usage of **File Lists** in the **Choose Input Files** dialog box, as detailed [here](#)<sup>[128]</sup>
- Functionality added that enables the use of **Files Lists** located in **Places** such as **Box.com**, **Dropbox**, **Google Drive**, **OneDrive** or **Sharepoint**.
- The **'PDF to Audio'** tool/action, which reads text from documents and saves it as a WAV or MP3 audio file, as detailed [here](#)<sup>[445]</sup> and [here](#)<sup>[124]</sup> respectively.
- The **Sanitize Document** tool/action, which removes hidden data from documents, as detailed [here](#)<sup>[426]</sup> and [here](#)<sup>[267]</sup> respectively.
- Functionality added that enables additional actions to be added to the **Tool Actions Sequence** after the **Print Documents** and **Send Mail** actions.

#### Version 8.0.334.0

- The **'Find and Redact'** tool/action, which finds text that matches user-specified criteria and then either marks it for redaction or redacts it immediately, as detailed [here](#)<sup>[424]</sup> and [here](#)<sup>[284]</sup> respectively.

- The **'Find and Replace Bookmark Text'** tool/action, which finds and replaces text in bookmark titles, as detailed [here](#)<sup>[409]</sup> and [here](#)<sup>[152]</sup> respectively.

#### Version 8.0.335.0

- New feature added to the administrative template: an option to hide the hint about license expiration.

#### Version 8.0.337.0

- The **'Multi-Threaded Processing Mode'** option for tools, which enables multi-core processing of input documents.

#### Version 8.0.340.0

- **'Copy with Rename'** action added for form fields in the **'Split/Merge Documents'** action, as detailed [here](#)<sup>[103]</sup>

#### Version 8.0.342.0

- **'Insert Blank Page'** option added for the **'Split/Merge Documents'** action. This feature enables the insertion of a blank page at the end of documents with even/odd page counts when documents are merged, as detailed [here](#)<sup>[103]</sup>
-

## 9.5 Font and Paragraph Parameters



### Font and Paragraph Options

Font and paragraph options are available in many of the actions/tools in **PDF-Tools**:

#### Font Options

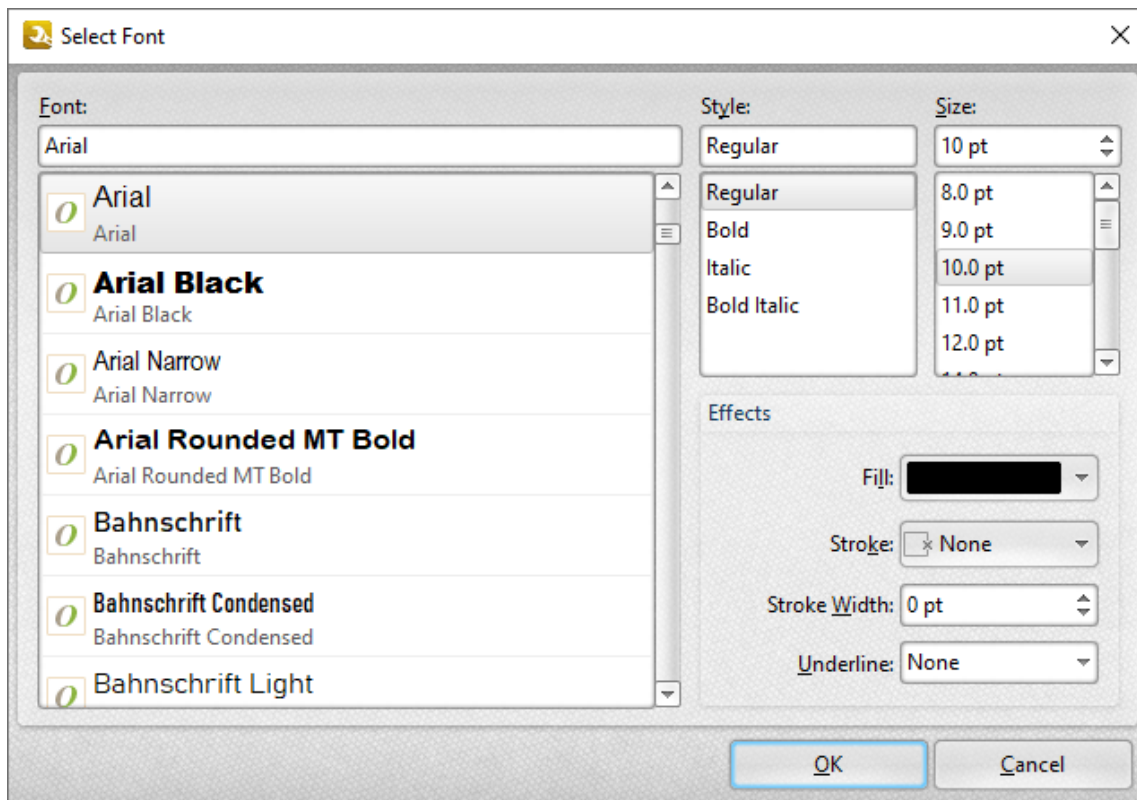

Figure 1. Select Font Dialog Box

- Available fonts are displayed in the pane. Click to select fonts, or enter font names in the **Font** text box to search for and select fonts.
- Use the **Style** dropdown menu to select the font style.
- Use the **Size** dropdown menu to select the font size.
- Use the **Fill** dropdown menu to select a font color.

- Use the **Stroke** dropdown menu to select the font outline color. (Please note that the stroke color may obscure the font color at smaller sizes).
- Use the **Stroke Width** dropdown menu to determine the width of the stroke.
- Use the **Underline** dropdown menu to enable/disable an underline for the current font.

Click **OK** to save settings.

## Paragraph Options

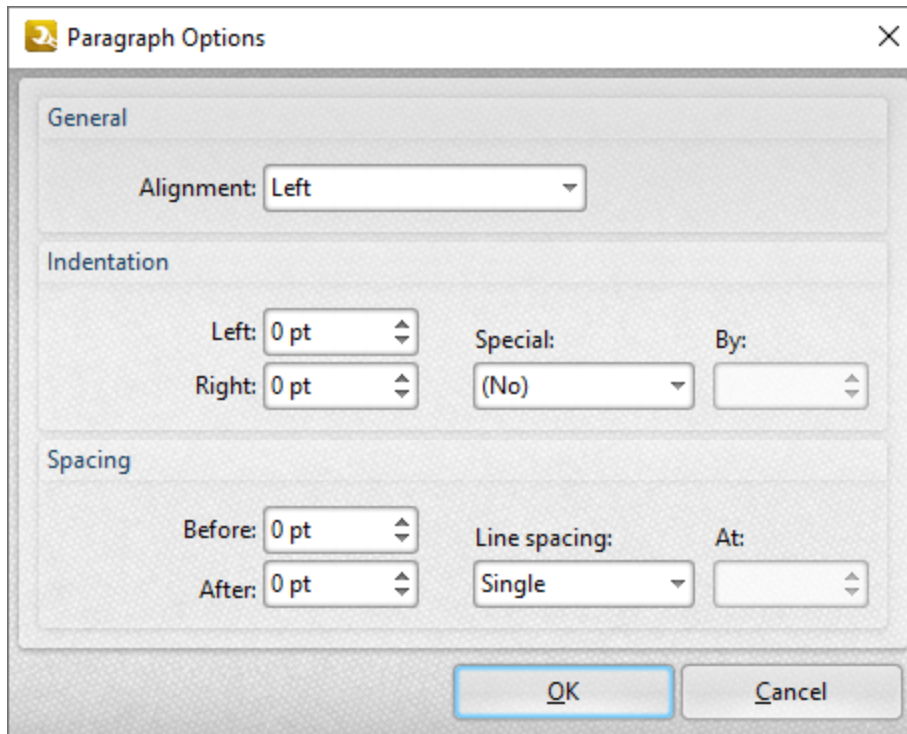

Figure 2. Paragraph Options Dialog Box

- Use the **Alignment** dropdown menu to determine the paragraph alignment.
- Use the **Indentation** number boxes to determine the indentation of paragraphs from the left and right side of the page.
- Use the **Special** dropdown menu to enable **First Line** or **Hanging** indentation as desired. If either option is used then use the **By** number box to specify the size of the indentation.
- Use the **Spacing** options to determine spacing options for paragraphs as desired.

Click **OK** to save settings.

---

## 9.6 Macros

---



### Macros

---

Macros are used throughout **PDF-Tools**. 'Macro' is an abbreviation of 'macroinstruction' - a term in computer science for a rule that specifies how input characters should be entered to create corresponding output. This means that components of the output process can be simplified during the input process, which makes the work involved less intensive and more dynamic. Multiple macros can be used simultaneously as desired. The format for macros is:

**%[<Macro Name>]** or, when it is customizable: **%[<Macro Name>:<Parameter>]**. The **<Parameter>** step is optional.

For example, the **Page Number** macro can be used to specify the page numbering format. The syntax for the **Page Number** macro is **%[Page:<Parameter>]** and the following parameters are available:

- '**r**' specifies the use of lower-case roman numerals - **%[Page:r]**.
- '**R**' specifies the use of upper-case roman numerals - **%[Page:R]**.
- '**L**' specifies page labels as the page numbering format in cases where page labels have been specified. If page labels have not been specified then standard page numbers are used - **%[Page:L]**.
- '**<integer>**' specifies the minimum number of digits used. This value can be any positive integer from 1 to 12 - for example **%[Page:4]** starts the page numbering as "**0001, 0002, 0003...**".

Macros are available when determining the filename of output documents, and also when the macro icon is displayed:



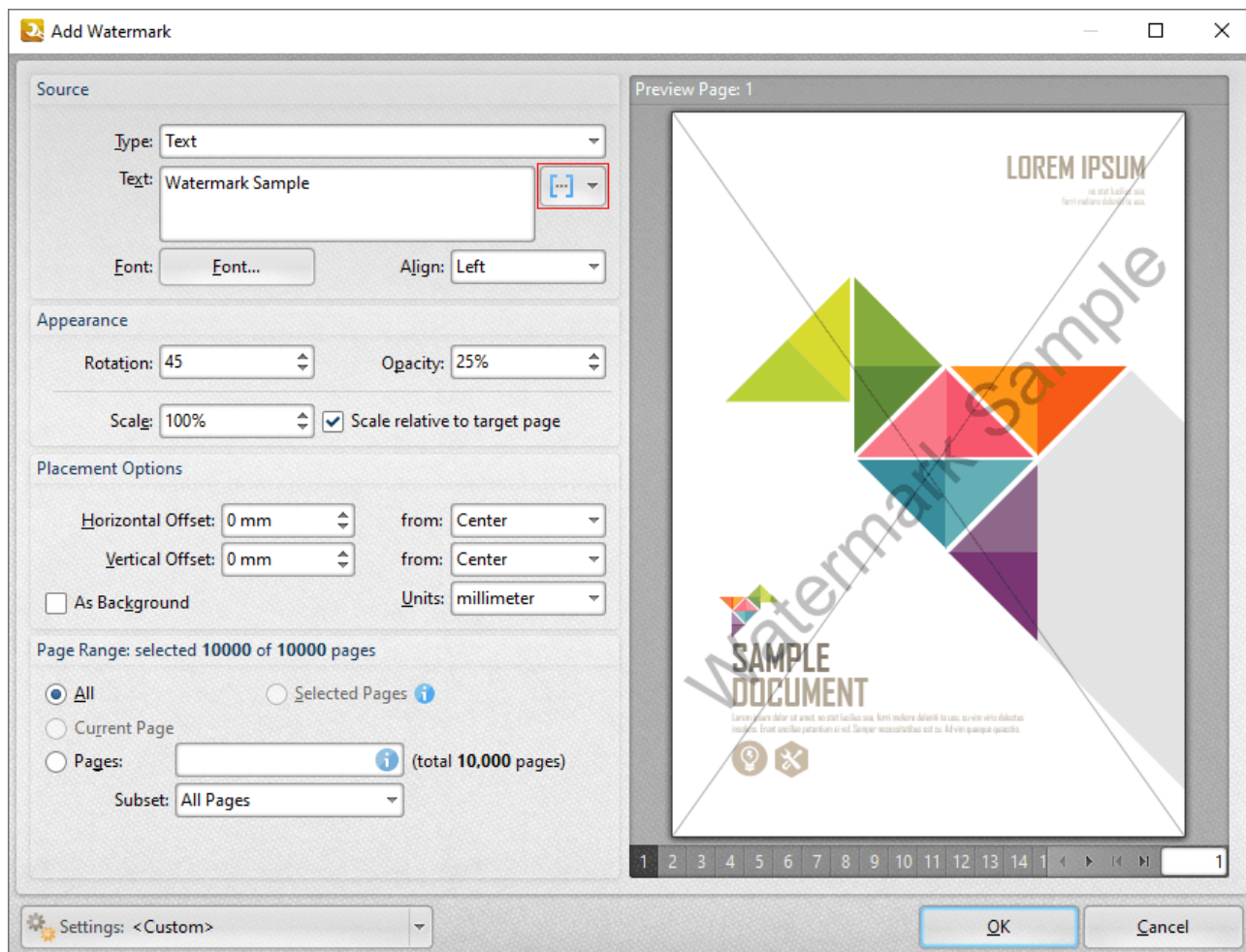

Figure 1. Add Watermark Dialog Box, Macro Icon Highlighted

Click the macro icon to view a list of available options, then click macros to add them to the text box. All available macros are detailed below:

- [Document Title](#) <sup>491</sup>
- [Document Index](#) <sup>497</sup>
- [Document Info](#) <sup>493</sup>
- [Page Number](#) <sup>501</sup>
- [Number of Pages](#) <sup>506</sup>
- [FileName](#) <sup>509</sup>
- [Folder Name](#) <sup>511</sup>
- [Date](#) <sup>513</sup>
- [Year](#) <sup>516</sup>
- [Month](#) <sup>519</sup>
- [Day](#) <sup>522</sup>
- [Time](#) <sup>525</sup>
- [Hour](#) <sup>528</sup>
- [Minute](#) <sup>531</sup>

- [Seconds](#)<sup>534</sup>
  - [Computer Name](#)<sup>537</sup>
  - [User Name](#)<sup>539</sup>
  - [Environment Variable](#)<sup>541</sup> which has multiple options relating to the [environment variables](#) of the file.
  - [Auto Number](#)<sup>545</sup>
  - [Application Version](#)<sup>548</sup>
-

### 9.6.1 Document Title

---



#### Document Title

---

The **Document Title** macro inserts the document title.

The syntax for the this macro is **%[DocTitle]**

#### Example

If the **%[DocTitle]** macro is used to specify watermark text, then the document title is inserted as a watermark:

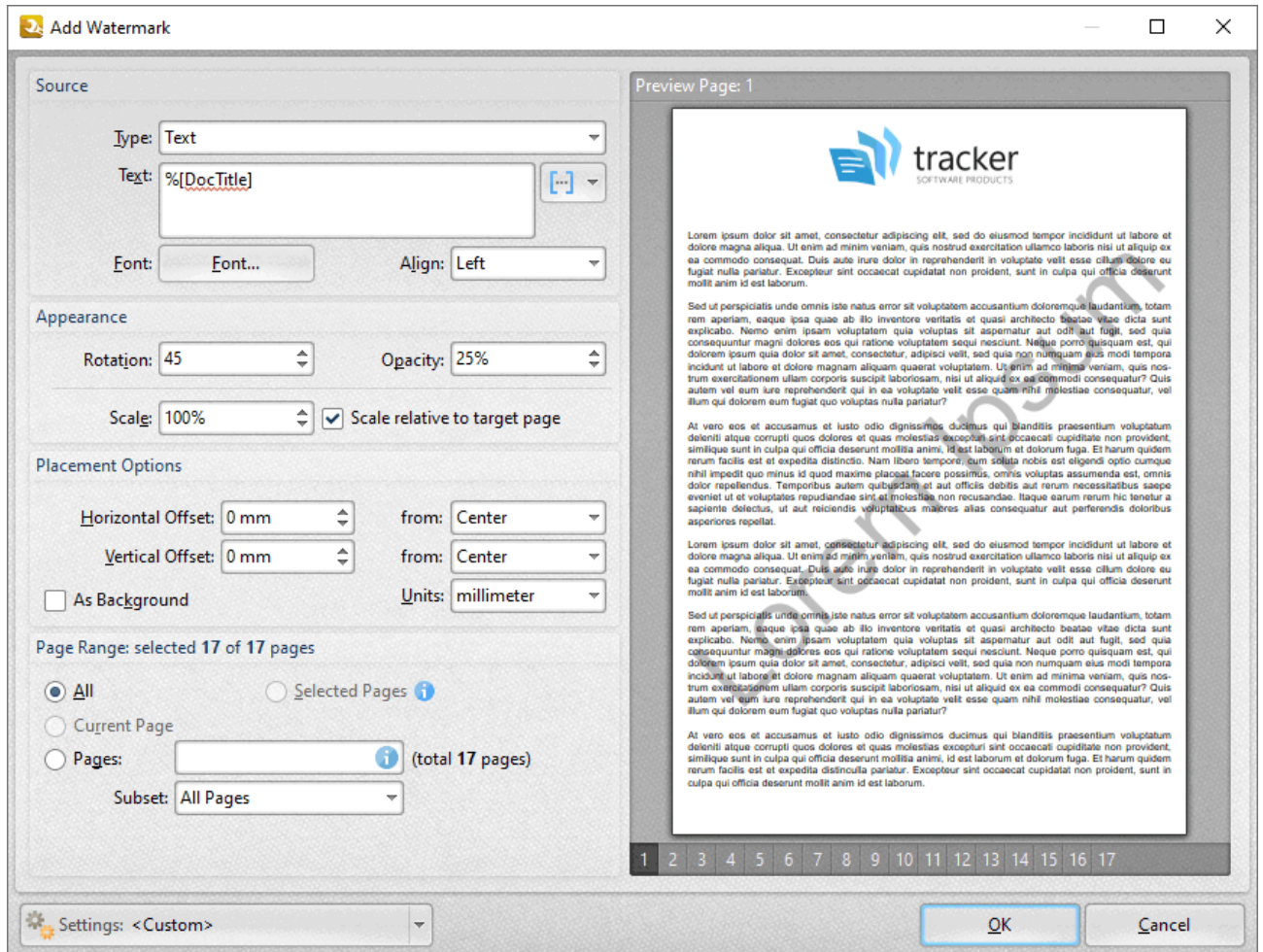

Figure 1. Add Watermark Dialog Box, %[DocTitle] Macro Example

## 9.6.2 Document Info

---



### Document Info

---

The **Document Info** macro inserts document metadata information.

The syntax for this macro is **%[DocInfo]** and the following parameters are available:

- **Title** inserts the data in the **Document Title** field.
- **Author** inserts the data in the **Author** field.
- **Subject** inserts the data in the **Subject** field.
- **Keywords** inserts the data in the **Keywords** field.
- **Creator** inserts the name of the application used to create the document.
- **Producer** inserts the **PDF Producer** of the document.
- **CreationDate** inserts the date and time when the document was created, followed by the [UTC offset](#).
- **ModDate** inserts the date and time when the document was last modified, followed by the [UTC offset](#).

The syntax for this macro when parameters are used is **%[DocInfo:<Parameter>]** - see below for examples.

Note that the names of any standard fields from document properties can be used as parameters for this macro. Additionally, if parameters have been specified using the JavaScript console and custom names have been used to replace the standard names, then the custom names can be used.

### Examples

If the **%[DocInfo:ModDate]** macro is used to create Bates Numbering, then the output specifies the date and time that the document was last modified:

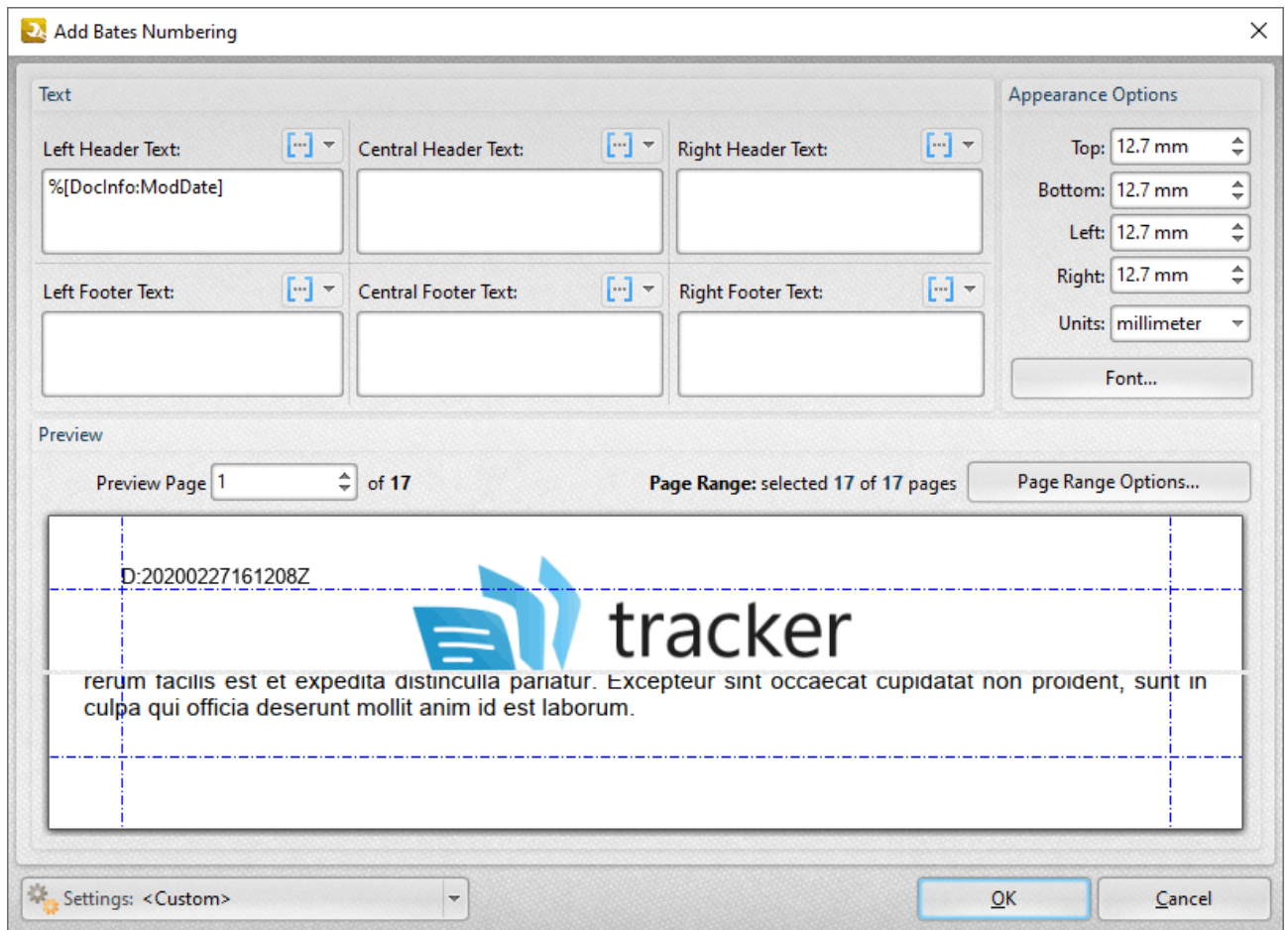

Figure 1. Add Bates Numbering Dialog Box, %[DocInfo] Macro Example

Alternatively, enter **%[DocInfo:Title]** to insert the document title:

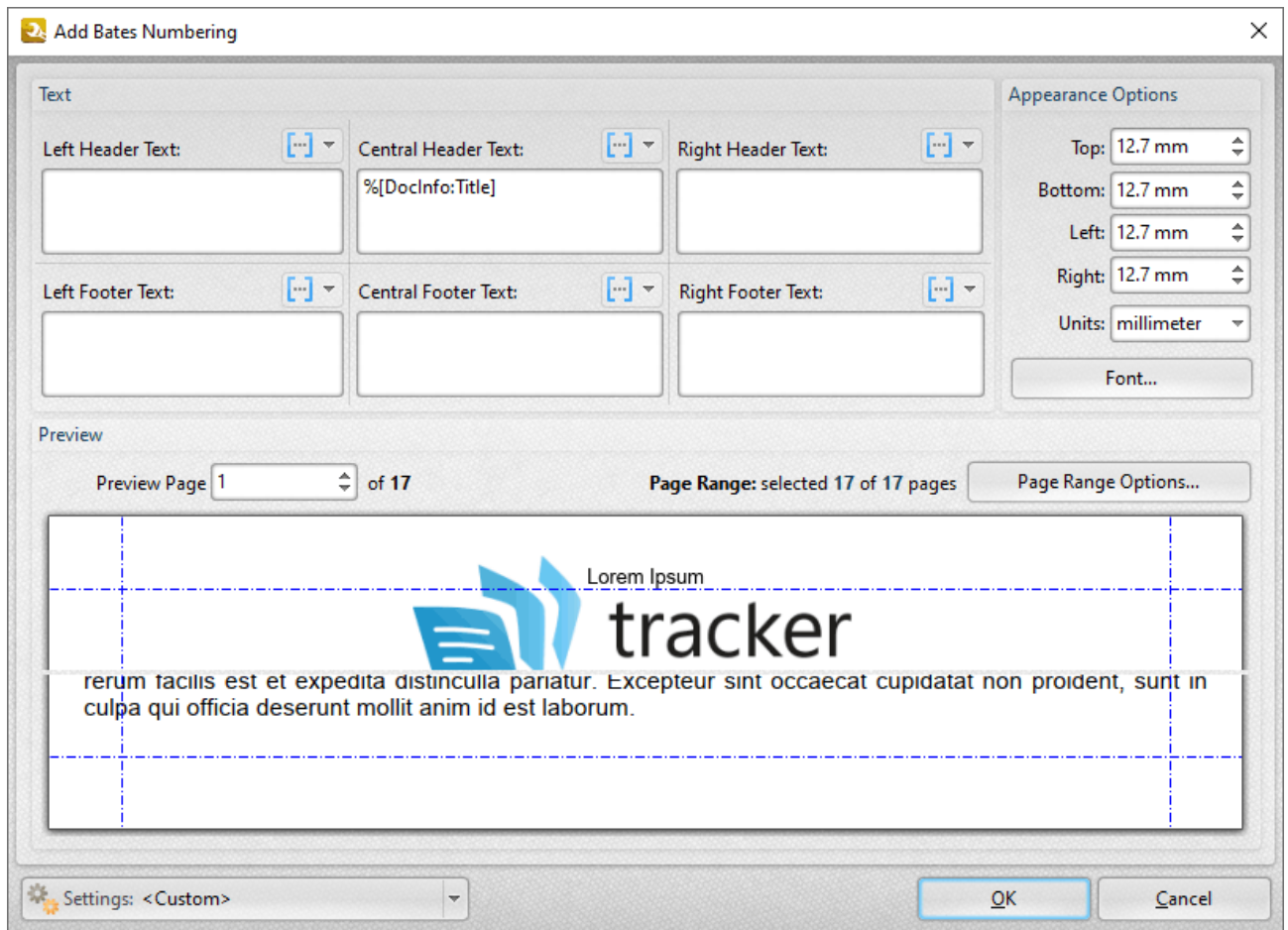

Figure 2. Add Bates Numbering Dialog Box, %[DocInfo] Macro Example Two

Note that it is possible to use more than one macro at a time. For example the text **%[DocInfo:Title]**, **%[DocInfo:Author]** returns both the document name and the author name:

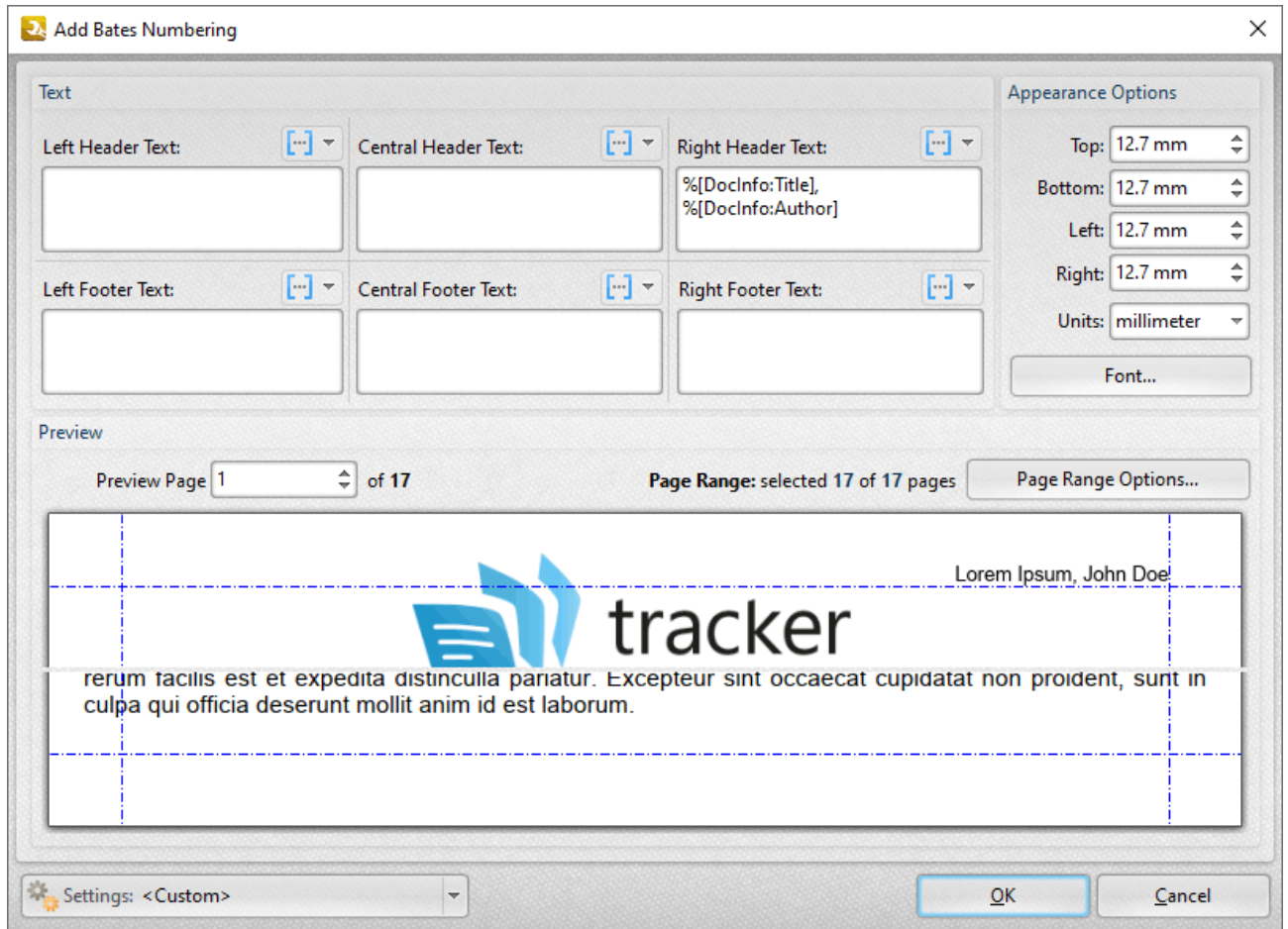

Figure 3. Add Bates Numbering Dialog Box, %[DocInfo] Macro Example Three



### 9.6.3 Document Index

---



#### Document Index

---

The **Document Index** macro inserts the index value of pages, which is the input/output order of the content in the context of a group of input/output content items.

The syntax for this macro is **%[DocNumber]** and a parameter is available for the specification of the minimum amount of digits used for numbering output. This value can be any positive integer from 1 to 12. If the parameter is not used then the output is numbered with the default settings, which uses the page number of source files as the output number.

The syntax for this macro when parameters are used is **%[DocNumber:<Parameter>]** - for example **%[DocNumber:4]** starts the numbering as "0001, 0002, 0003...".

#### Example

If the **%[DocNumber:4]** macro is used in the **Filename** text box when the **Export PDF to Microsoft Excel Spreadsheet** tool is used to convert multiple documents to **MS Excel** format, then the name of each output file will be its order (index value) in the input sequence, and each file name will contain four digits:

The first step is to specify the macro in the **Filename** text box of the **Tool Actions Sequence**:

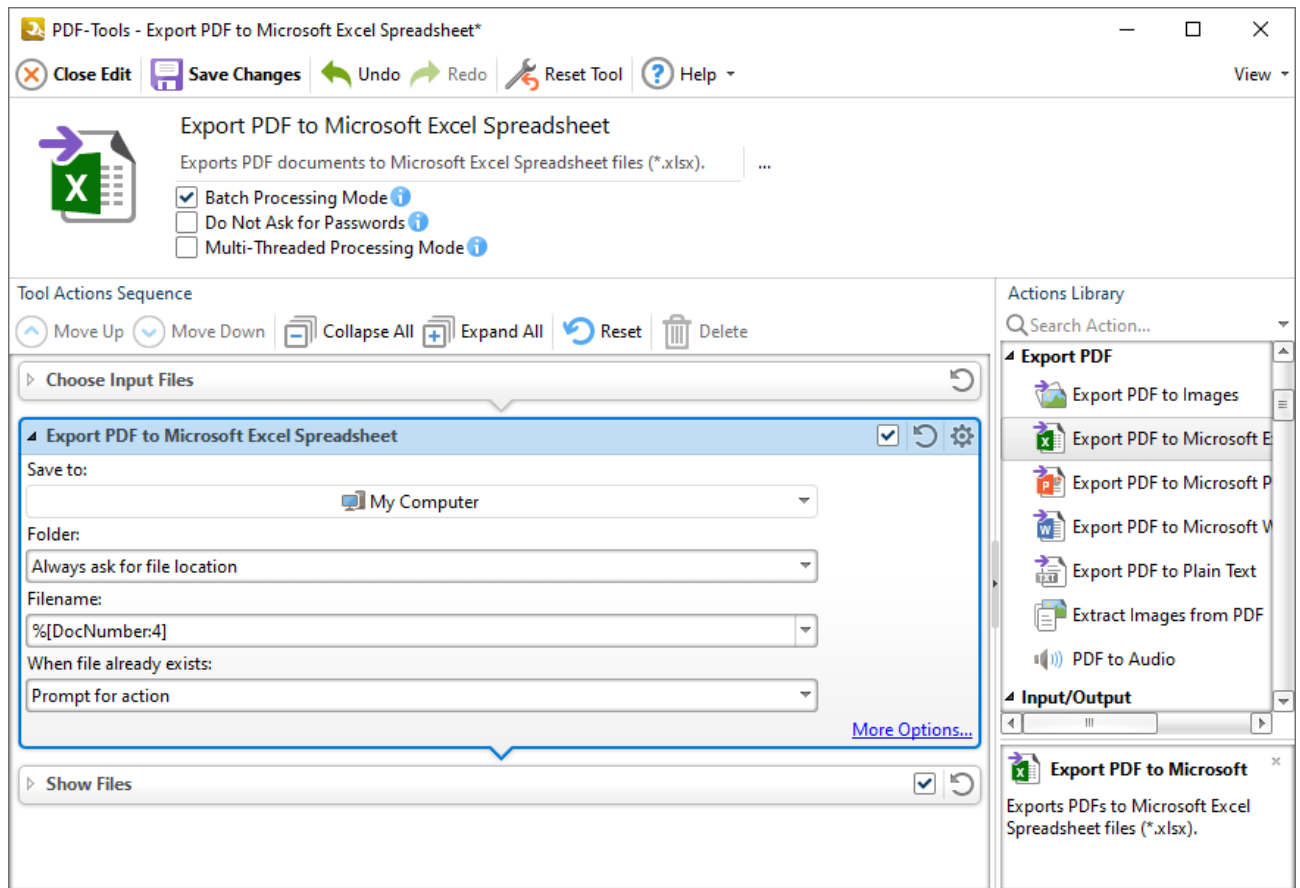

**Figure 1.** Export PDF to Microsoft Excel Spreadsheet Tool Actions Sequence, %[DocNumber:4] Macro Specified

The second step is to run the tool and add the desired files for conversion:

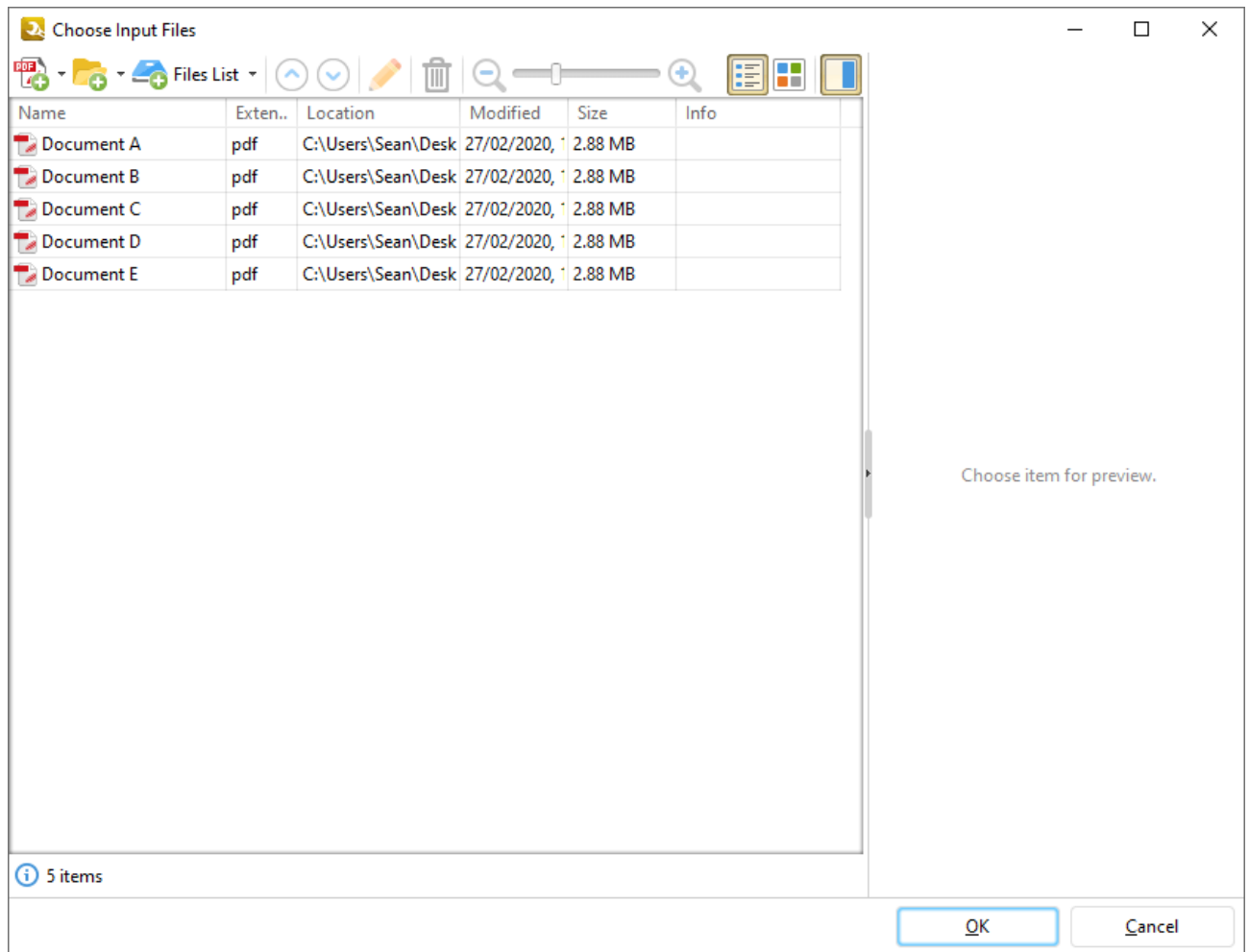

**Figure 2.** Choose Input Files Dialog Box, Files Added For Conversion

After the files are converted, the name of each output file is its order (index value) in the input sequence, and each file name will contain four digits, as specified in the macro entered during the first step of the process:

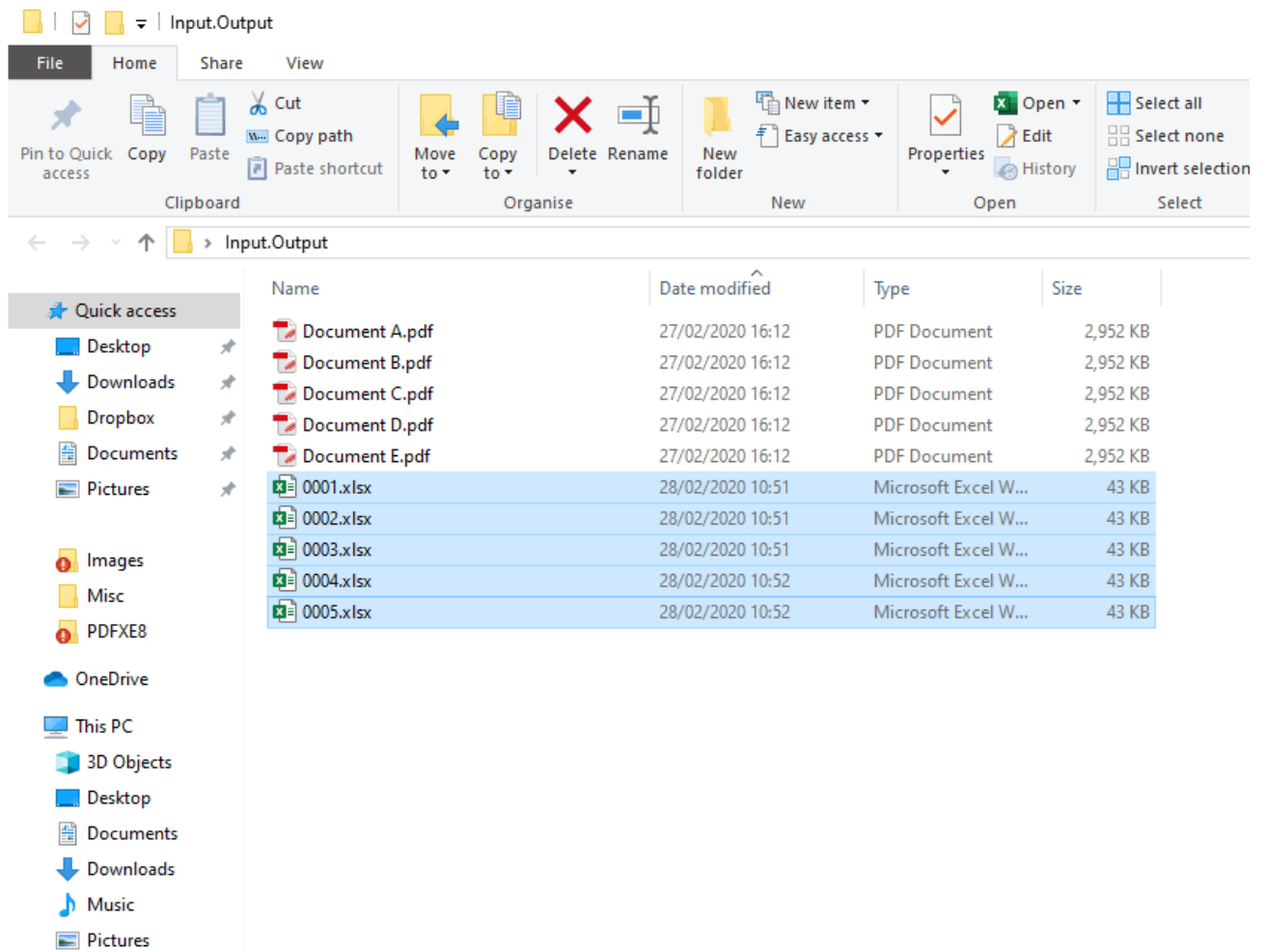

**Figure 3.** Output Files

## 9.6.4 Page Number

---



### Page Number

---

The **Page Number** macro inserts the page number of source pages.

The syntax for this macro is **%[Page]** and two sections of parameters are available:

The first section determines the format of page numbers:

- 'r' specifies the use of lower-case roman numerals.
- 'R' specifies the use of upper-case roman numerals.
- 'L' specifies page labels as the page numbering format in cases where page labels have been specified. If page labels have not been specified then standard page numbers are used.
- '<integer>' specifies the minimum number of digits used. This value can be any positive integer from 1 to 12 - for example **%[Page:4]** starts the numbering as "0001, 0002, 0003...".

The second section determines the starting value for page numbers, and must therefore be an integer.

Please note that a semicolon must be used to delimit the sections of parameters. If the second section is not used then the semicolon can be omitted. However, if the first section is not used and the second section is used, then it is necessary to use the semicolon.

The syntax for this macro when both parameters are used is **%[Page:<Parameter 1>;<Parameter 2>]**

The syntax for this macro when only the second parameter is used is **%[Page;;<Parameter 2>]**

### Examples

If the **%[Page]** macro is used to specify a document header, then the page number of the source page is inserted as a header:

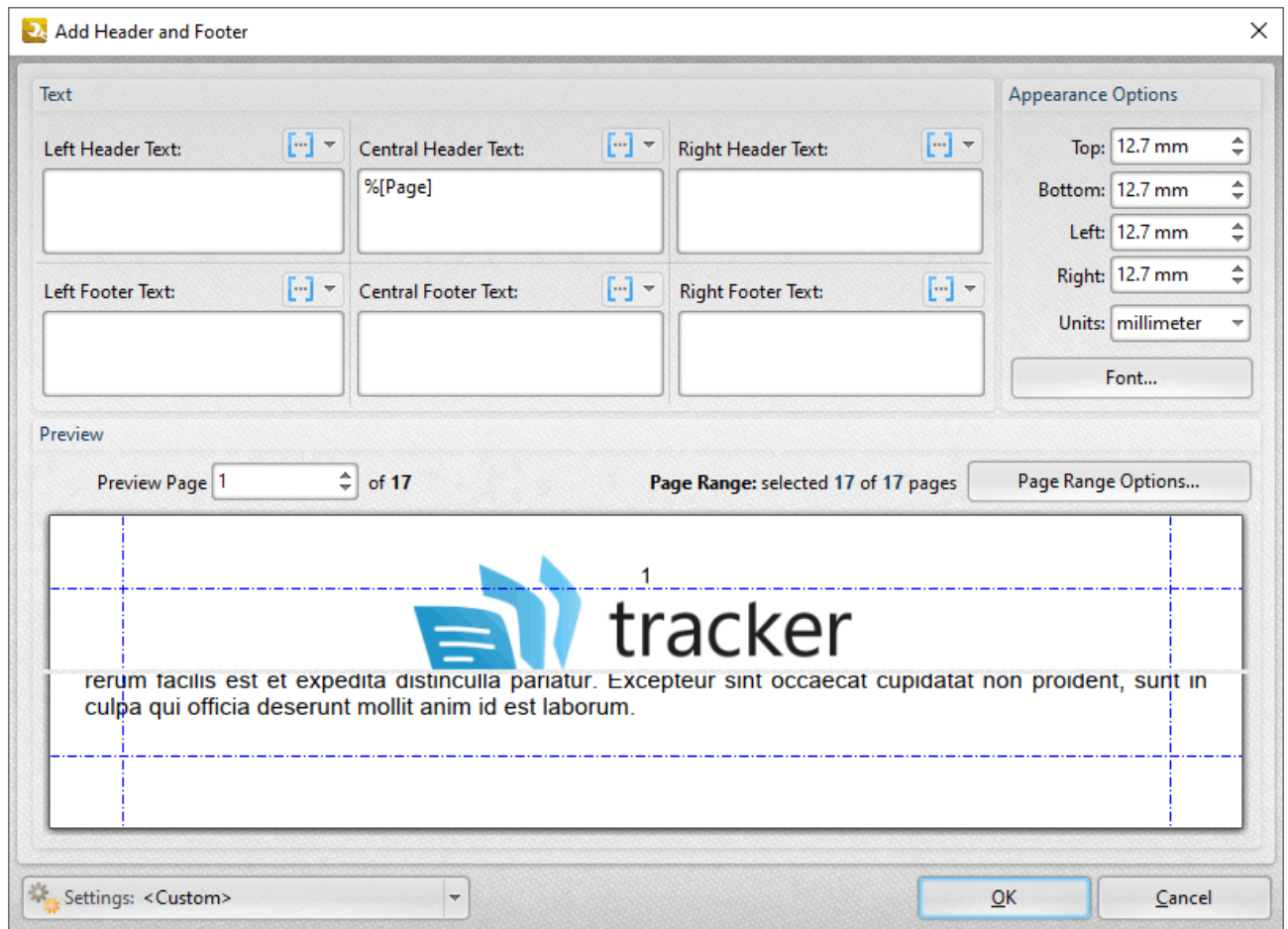

Figure 1. Add Header and Footer Dialog Box, %[Page] Macro Example

Alternatively, enter **%[Page:R]** to specify the use of upper-case roman numerals:

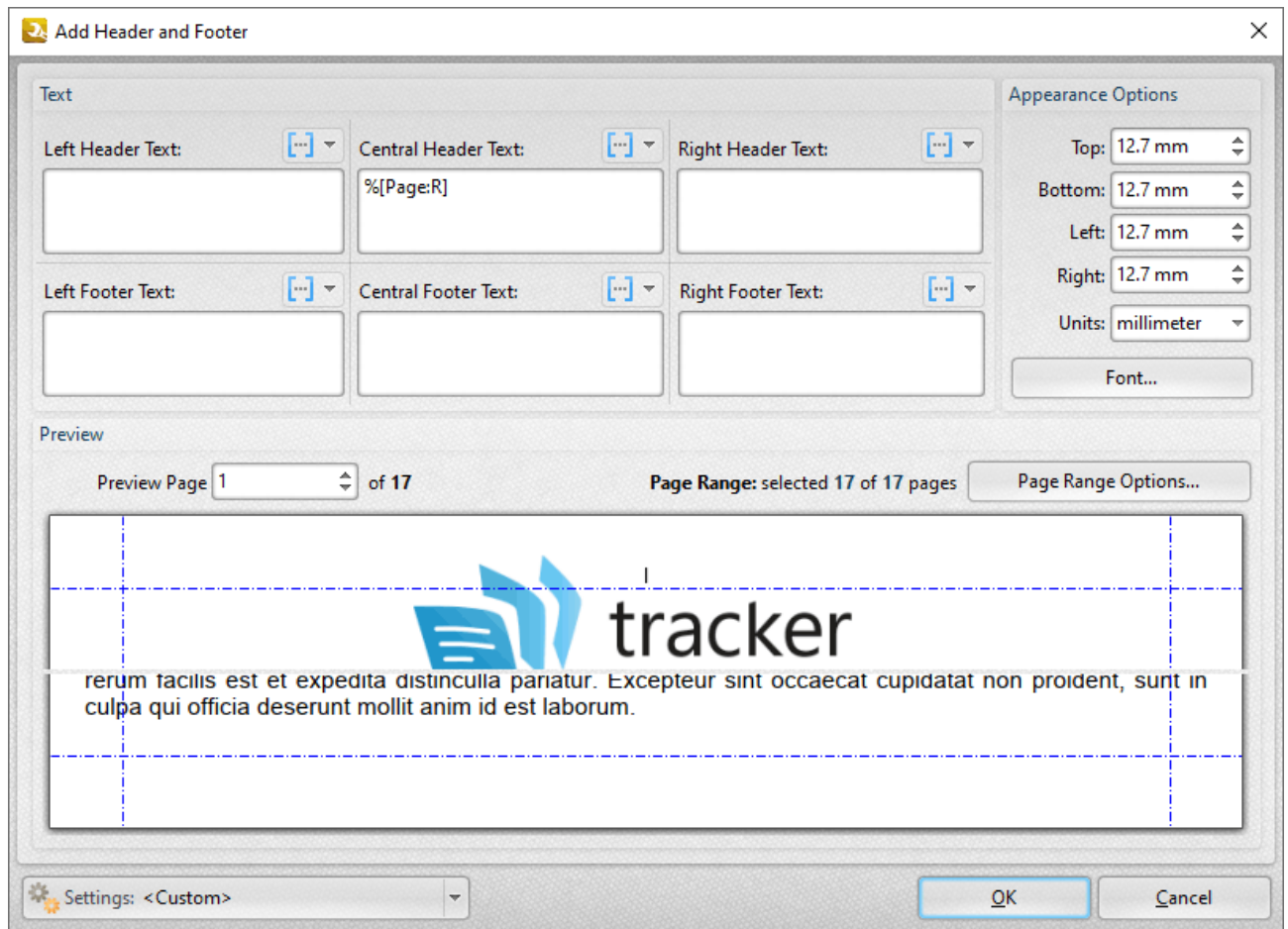

Figure 2. Add Header and Footer Dialog Box, %[Page] Macro Example Two

Alternatively, enter **%[Page:4;10]** to specify a minimum of four digits for output values and a starting value of ten:

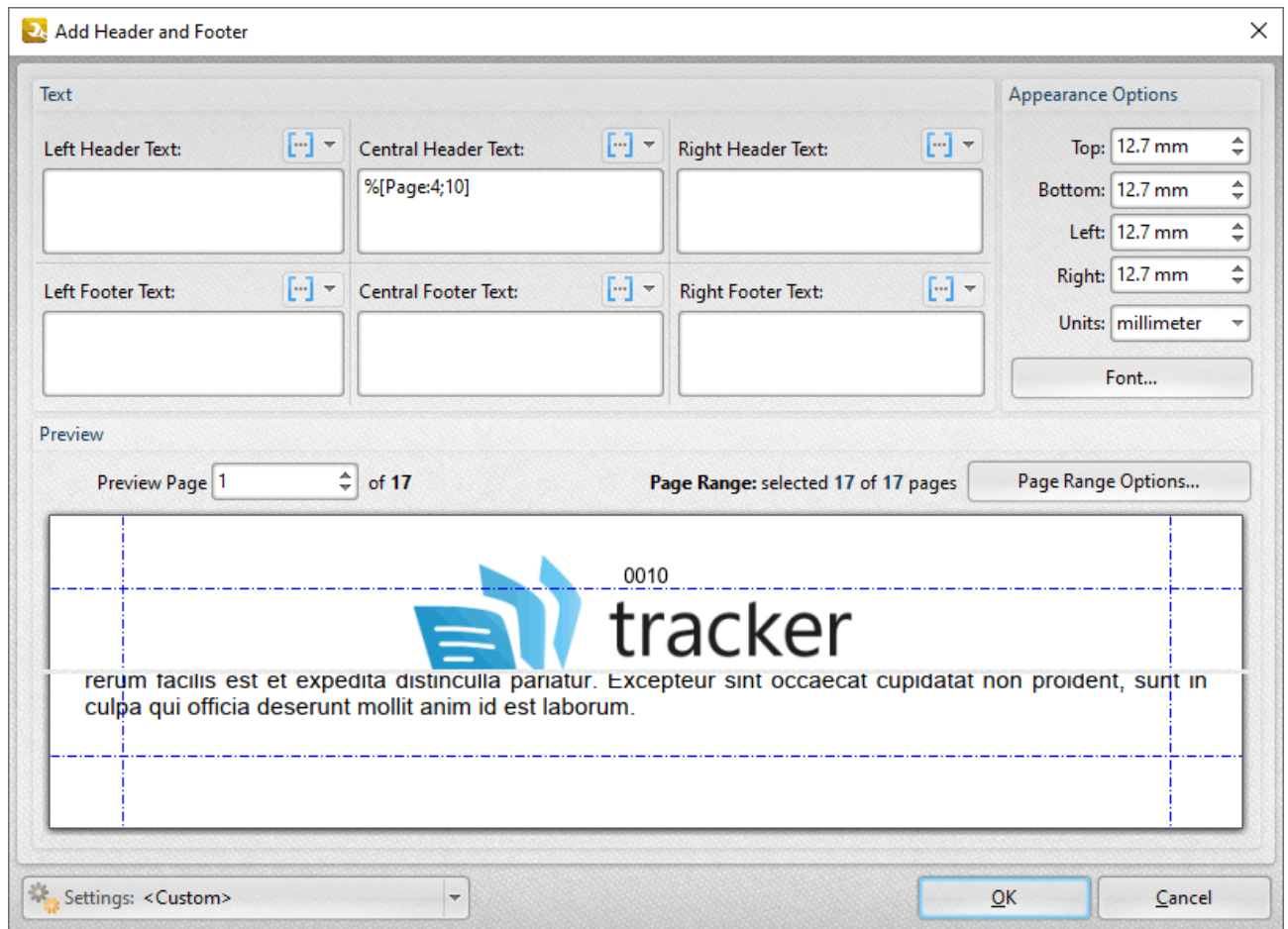

Figure 3. Add Header and Footer Dialog Box, %[Page] Macro Example Three

Alternatively, enter **%[Page::5]** to omit the first parameter and specify a starting value of five:



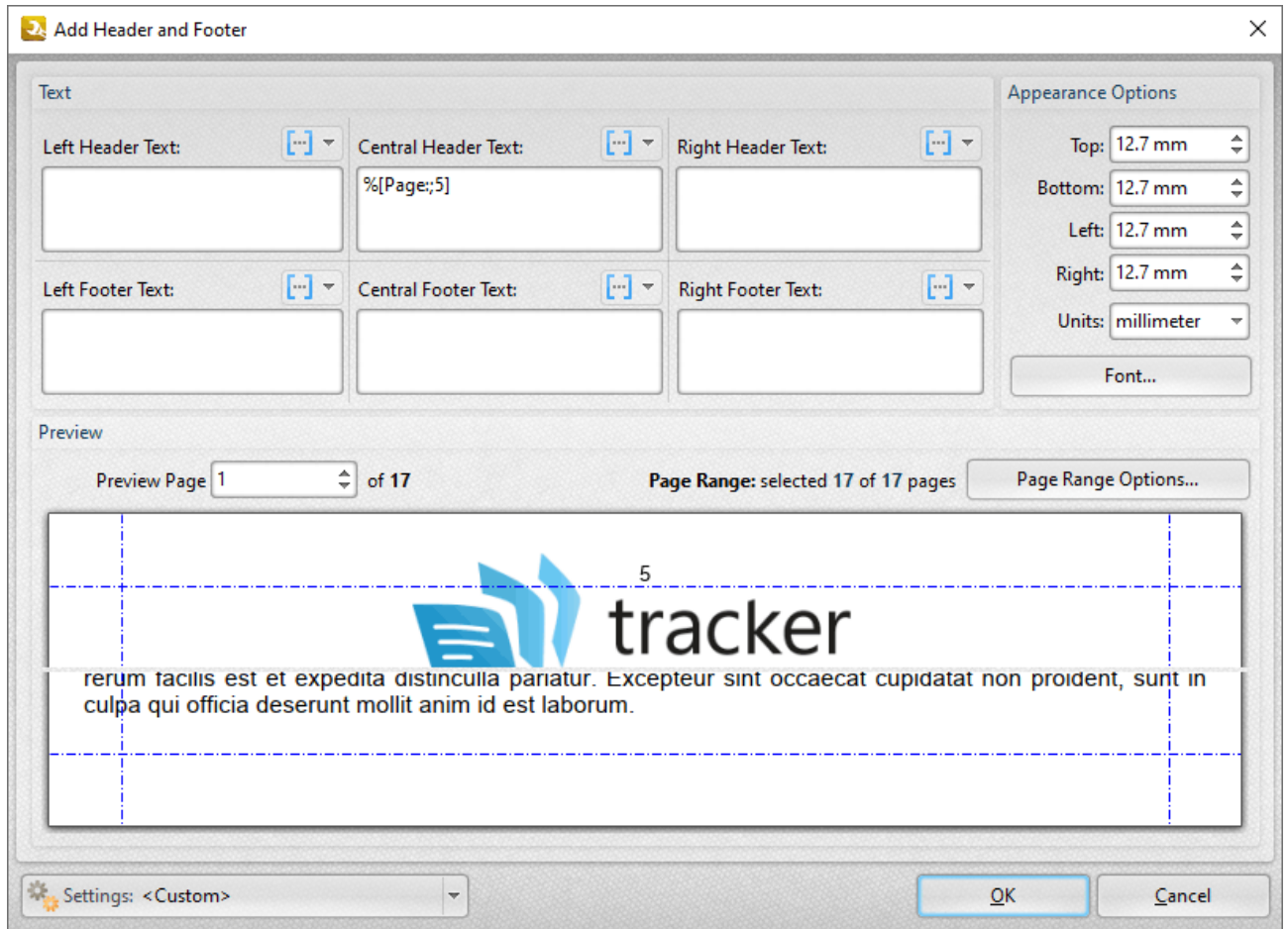

Figure 4. Add Header and Footer Dialog Box, %[Page] Macro Example Four

### 9.6.5 Number of Pages

---



### Number of Pages

---

The **Number of Pages** macro inserts the total number of document pages.

The syntax for this macro is **%[Pages]** and the following parameters are available

- '**r**' specifies the use of lower-case roman numerals.
- '**R**' specifies the use of upper-case roman numerals.
- '**L**' specifies page labels as the page numbering format in cases where page labels have been specified. If page labels have not been specified then standard page numbers are used.
- '**<integer>**' specifies the minimum number of digits used. This value can be any positive integer from 1 to 12 - for example **%[Pages:4]** starts the numbering as "**0001, 0002, 0003...**".

The syntax for this macro when parameters are used is **%[Pages:<Parameter>]**

### Examples

If the **%[Pages]** macro is used to specify watermark text, then the total number of document pages is inserted as a watermark:

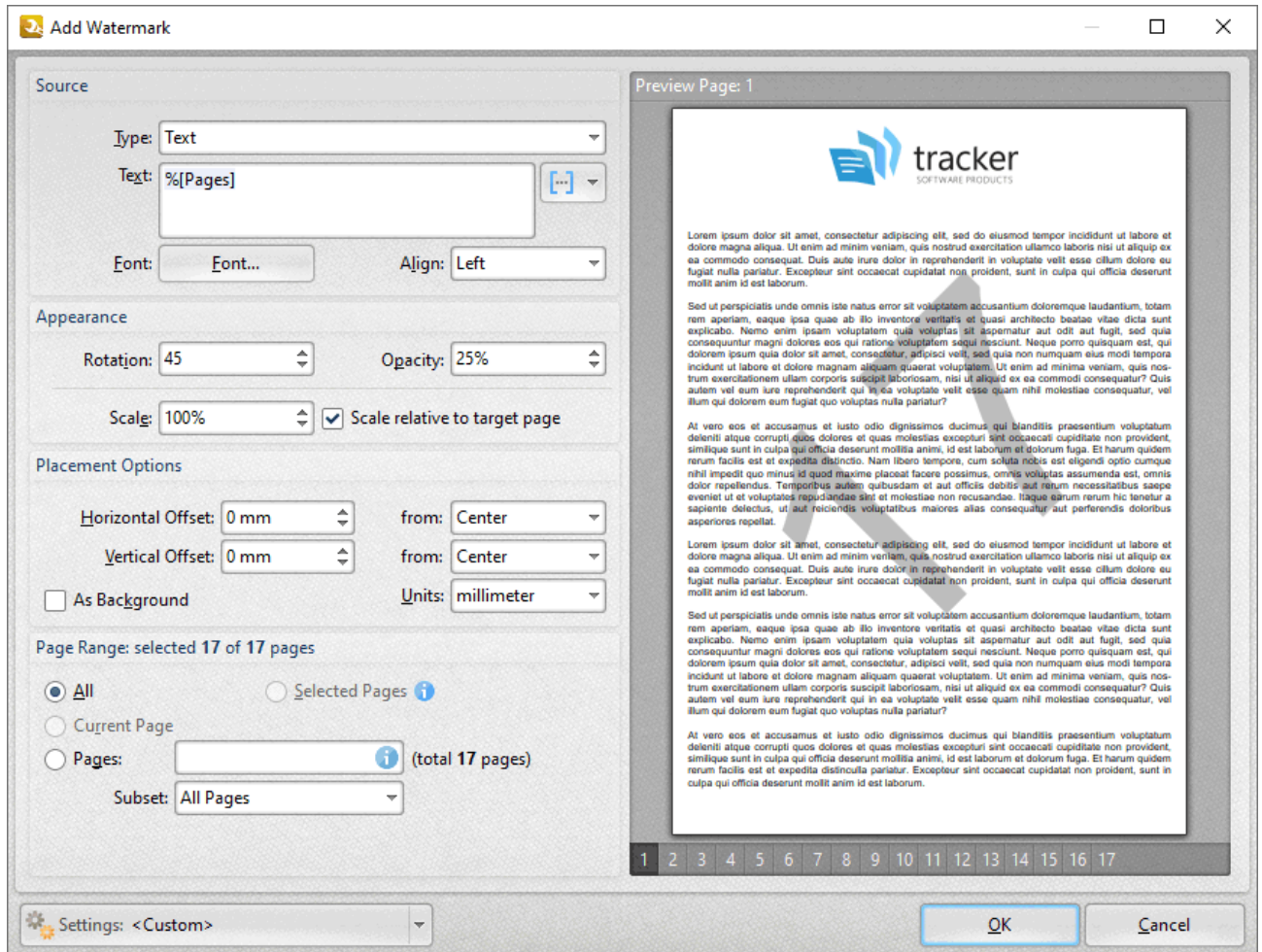

Figure 1. Add Watermark Dialog Box, %[Pages] Macro Example

Alternatively, enter **%[Pages:R]** to insert the total number of document pages as a watermark and specify the use of upper-case roman numerals:

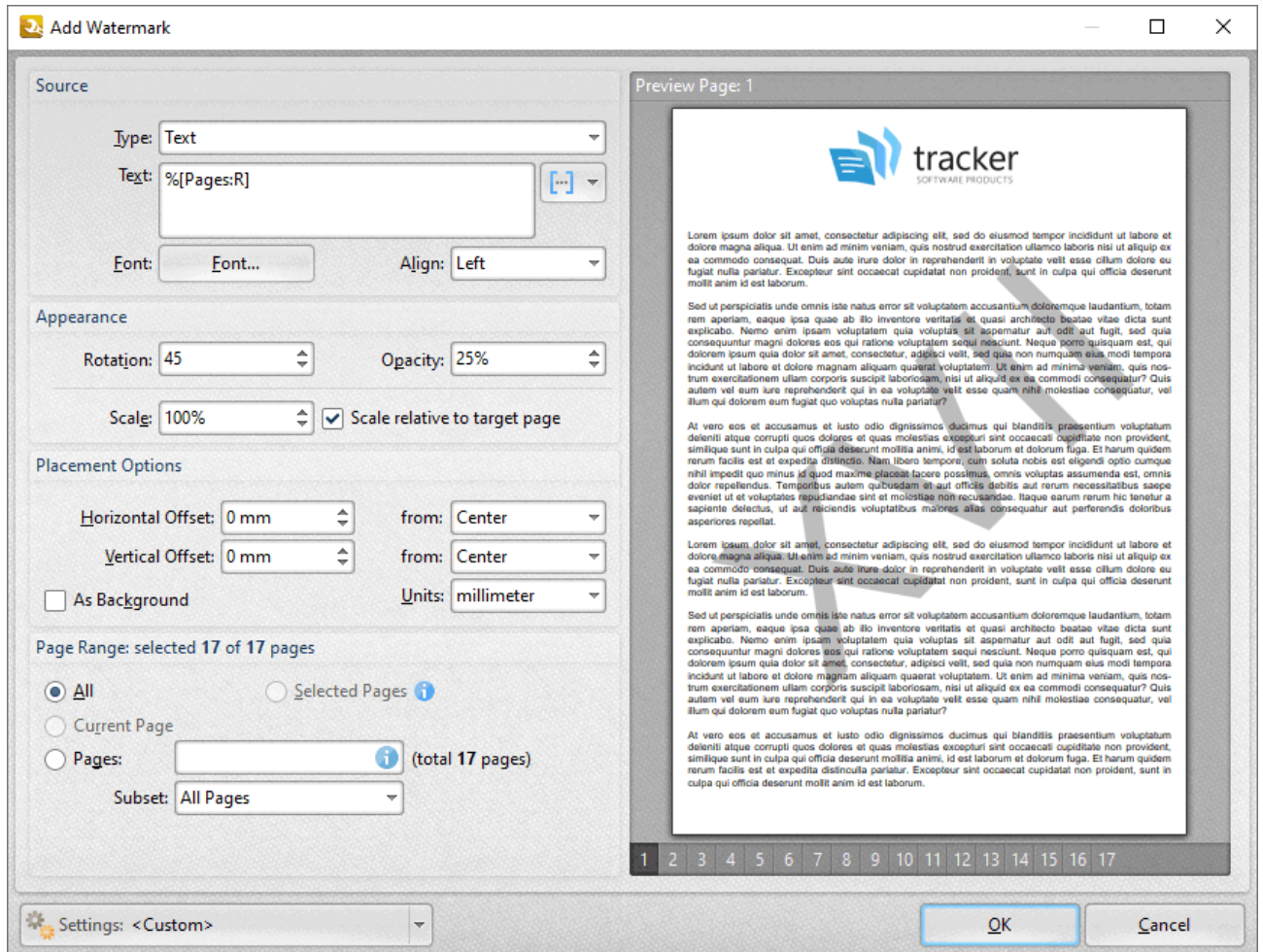

Figure 2. Add Watermark Dialog Box, %[Pages] Macro Example Two

### 9.6.6 FileName

---



#### **FileName**

---

The **FileName** macro inserts the name of the source file.

The syntax for this macro is **%[FileName]**

#### **Example**

If the **%[FileName]** macro is used to specify watermark text, then the name of the file is inserted as a watermark:

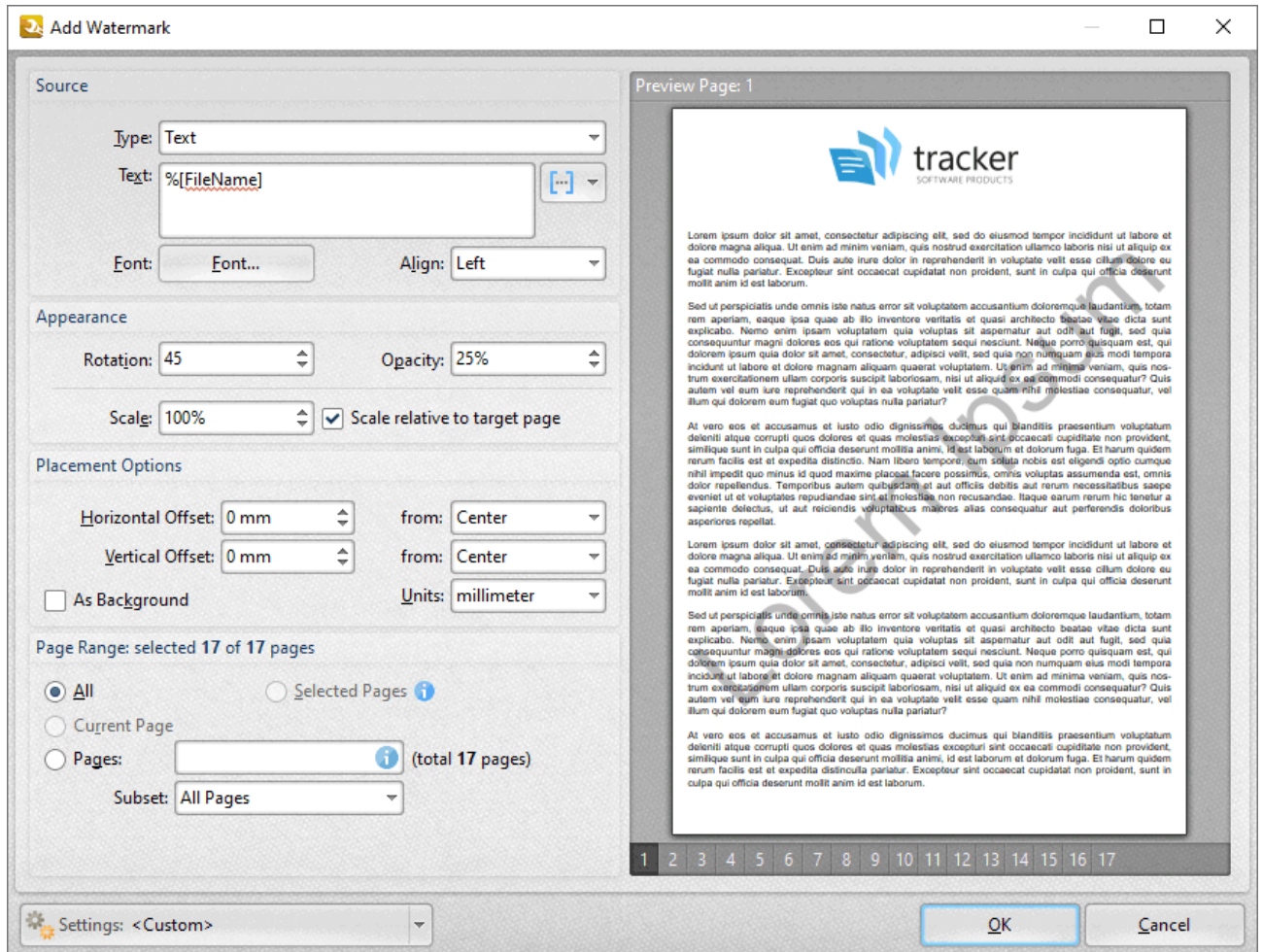

Figure 1. Add Watermark Dialog Box, %[FileName] Macro Example

### 9.6.7 Folder Name

---



#### Folder Name

---

The **Folder Name** macro inserts the path of the folder that contains the source file. Note that folder names end with a backslash when local files are used.

The syntax for this macro is **%[FolderName]**

#### Example

If the **%[FolderName]** macro is used to specify watermark text, then the name of the folder that contains the source file is inserted as a watermark:

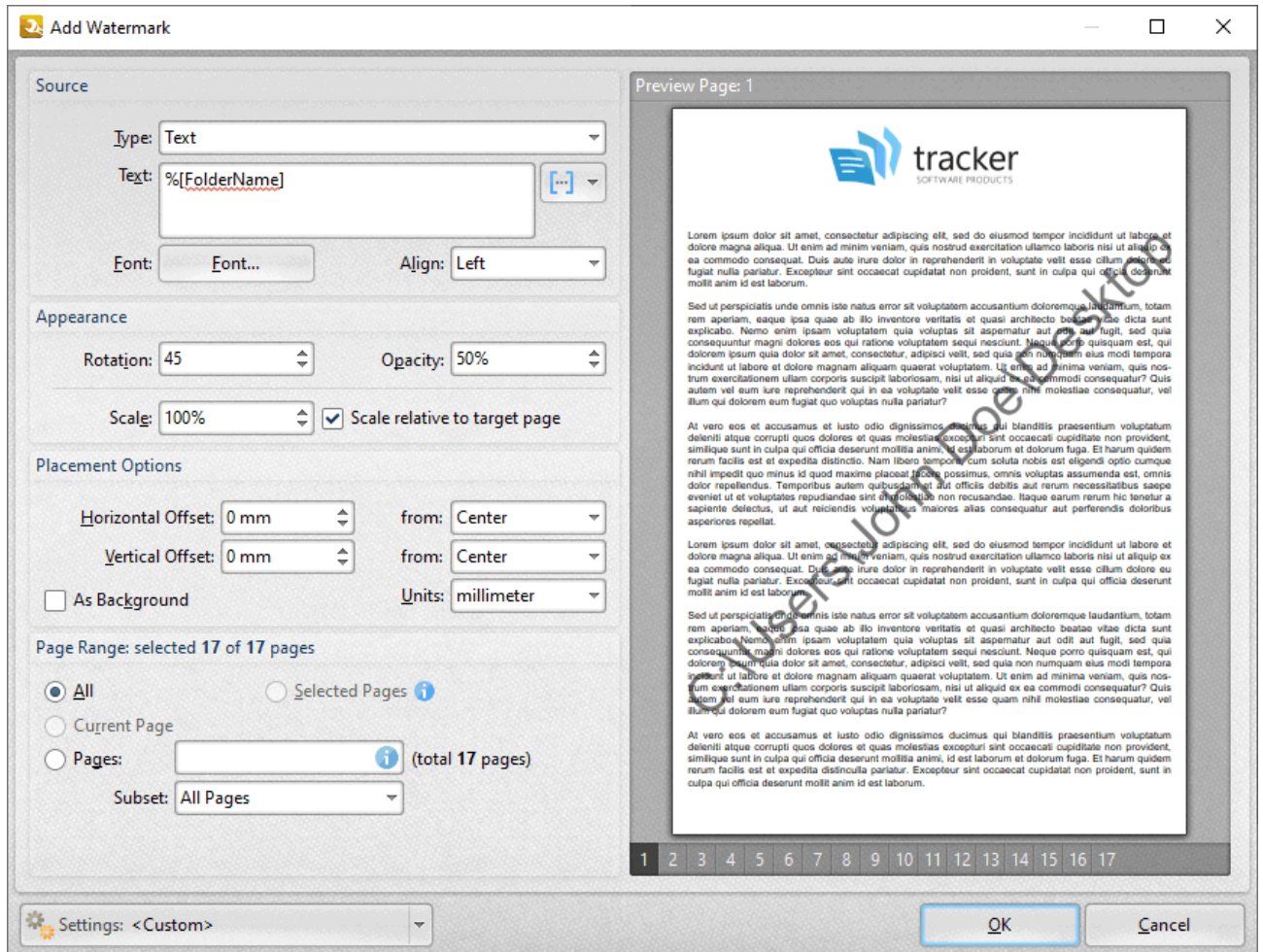

Figure 1. Add Watermark Dialog Box, %[FolderName] Macro Example



## 9.6.8 Date

---



### Date

---

The **Date** macro inserts the current date. Multiple date formats are available, as detailed below.

The syntax for this macro is **%[Date]** and the following parameters are available:

- **d** inserts the day of the month and omits the zero in cases of single-digit values.
- **dd** inserts the day of the month and includes a zero in cases of single-digit values.
- **ddd** inserts the day of the week as a three-letter abbreviation.
- **dddd** inserts the day of the week.
- **M** inserts the month and omits the zero in cases of single-digit values.
- **MM** inserts the month and includes a zero in cases of single-digit values.
- **MMM** inserts the month as a three-letter abbreviation.
- **MMMM** inserts the month.
- **yy** inserts the year as two digits and adds a zero in cases of values lower than 10.
- **yyyy** inserts the year.

The syntax for this macro when parameters are used is **%[Date:<Parameter>]**

Note that several parameters can be used in sequence in order to insert a customized date. For example, **%[Date:dddd, dd MMMM yyyy]** inserts the day of the week followed by the day of the month, the month name in full and the year as four digits (as detailed below). If parameters are not specified then output values revert to default, which is the date on the local machine in the format **dd/MM/yyyy**.

### Example

If the macro **%[Date:dddd, dd MMMM yyyy]** is added as a header to documents, then the output will be the day of the week followed by the day of the month, the month name in full and the year as four digits:

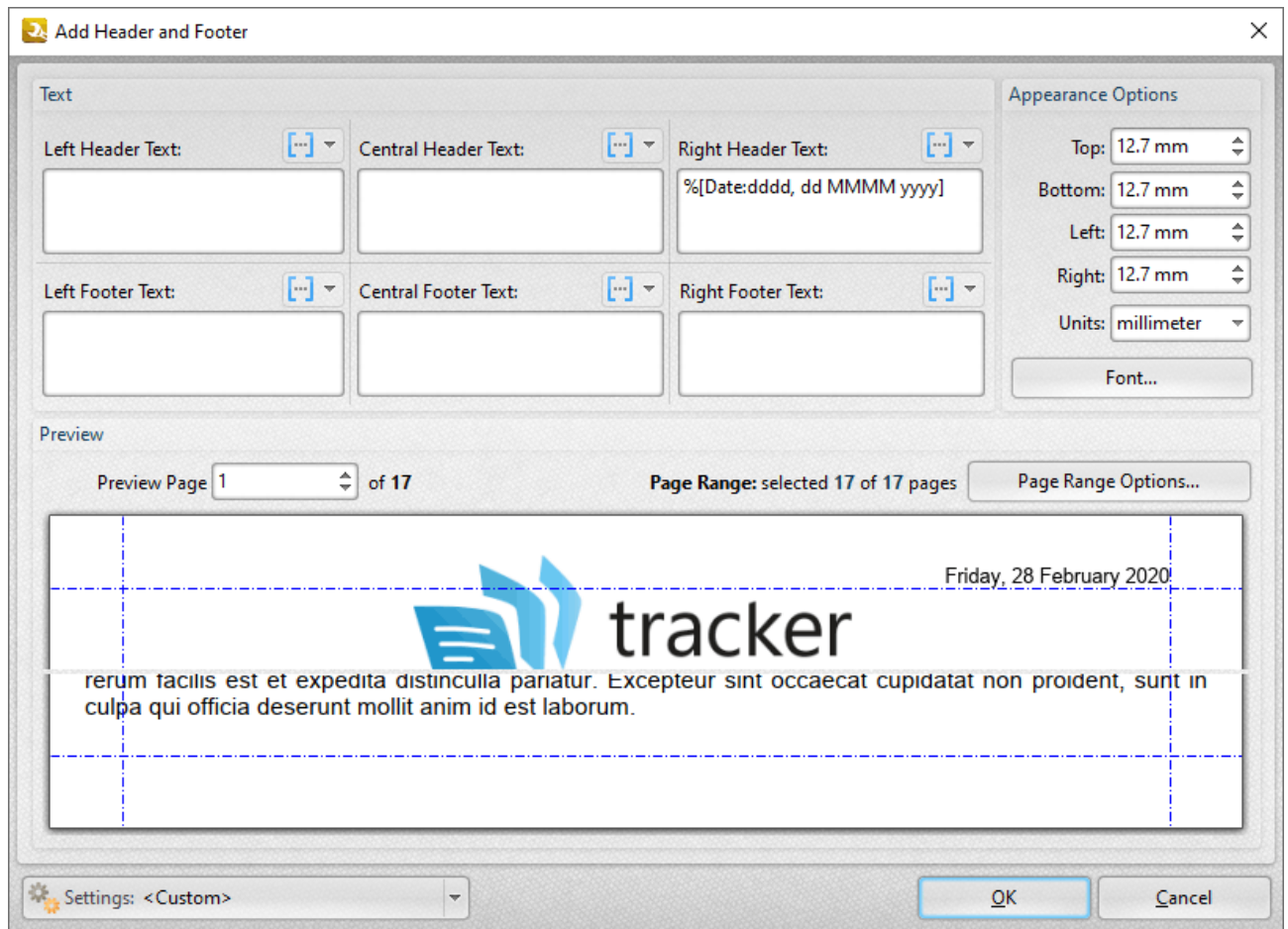

Figure 1. Add Header and Footer Dialog Box, %[Date] Macro Example

Note that a range of preset date formats are provided in **PDF-Tools**:

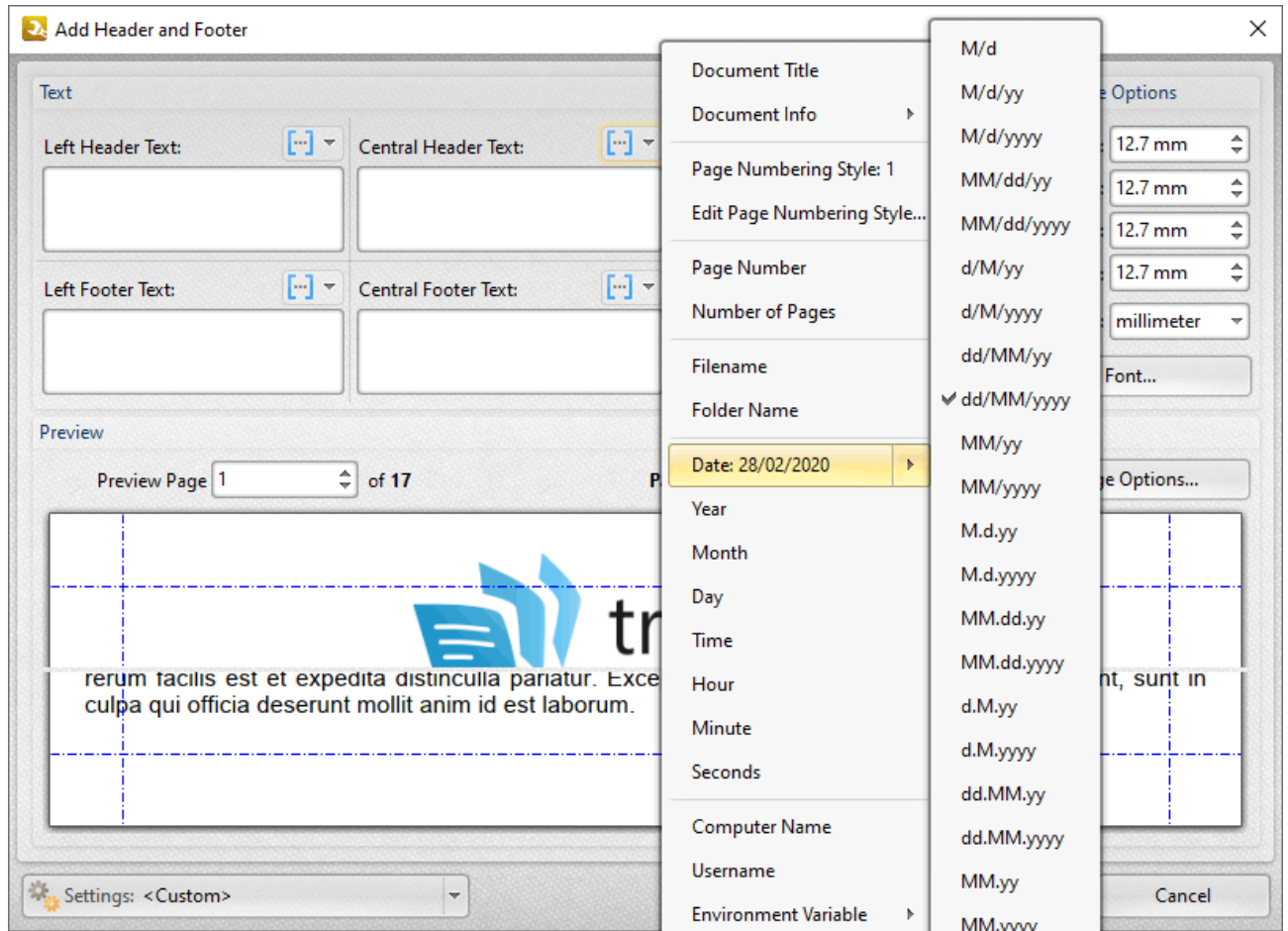

Figure 2. Date Macro Preset Options

### 9.6.9 Year

---



#### Year

---

The **Year** macro inserts the current year as a four-digit value.

The syntax for this macro is **%[Year]**

#### Example

If the **%[Year]** macro is used to specify watermark text, then the current year is inserted as a watermark:

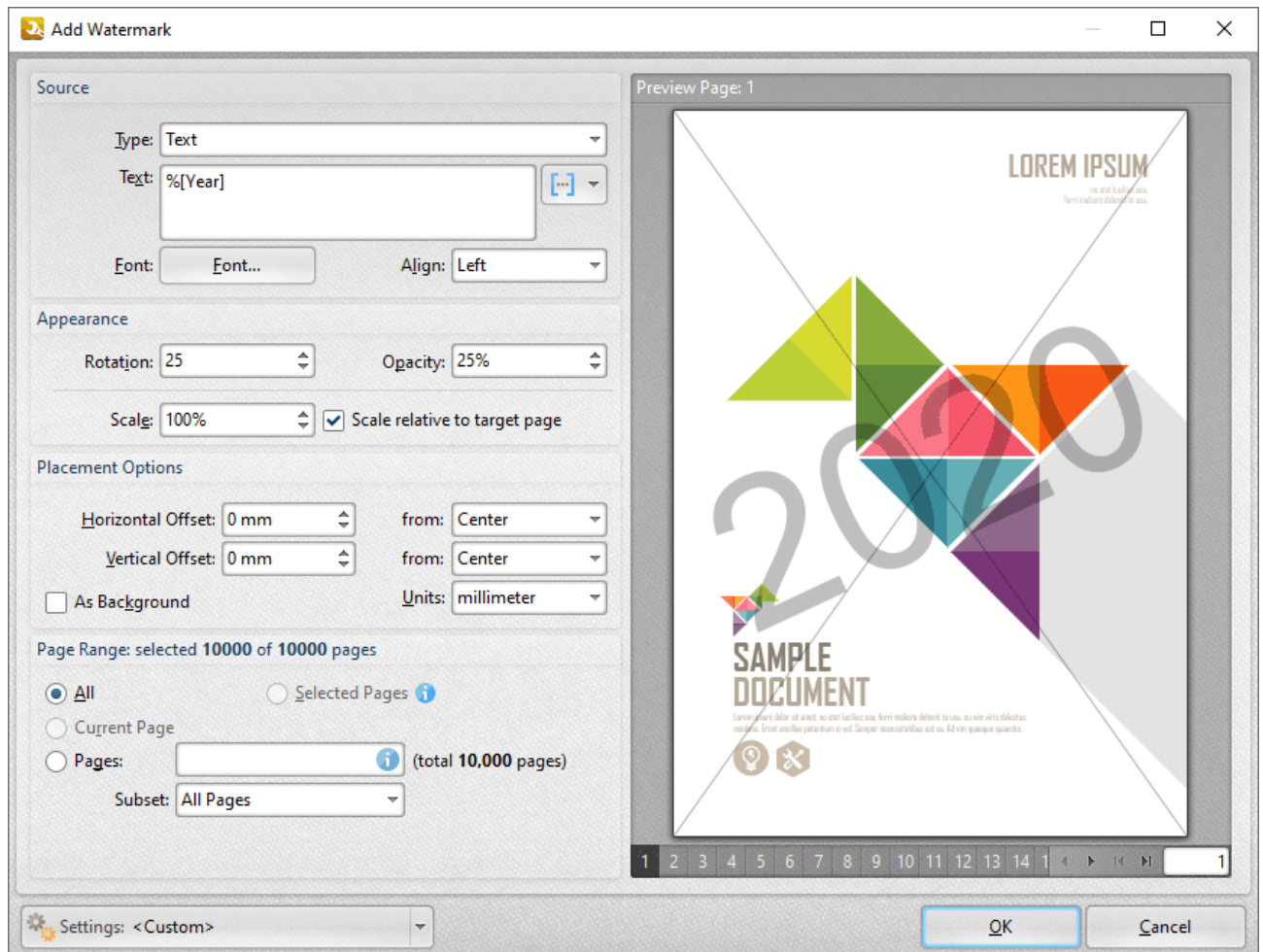

Figure 1. Add Watermark Dialog Box, %[Year] Macro Example

Note that this macro is often used in conjunction with other macros in order to create combined output. For example the combined macros **%[Time:H:mm] %[Date:dd MMMM] %[Year]** output the current time, date and year:

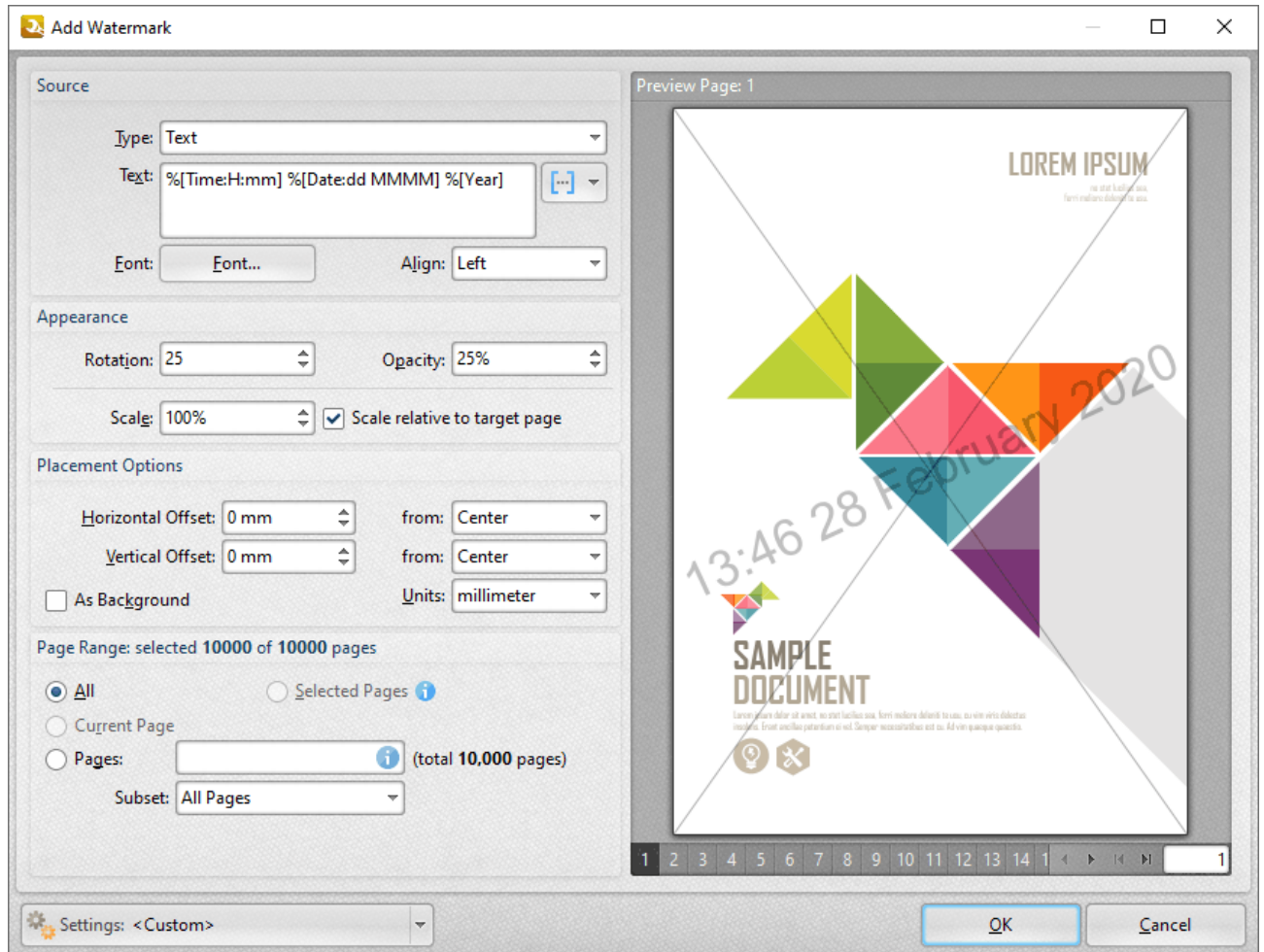

Figure 2. Add Watermark Dialog Box, Combined Macro Example

### 9.6.10 Month

---



### Month

---

The **Month** macro inserts the current month as a numerical value from 1-12.

The syntax for this macro is **%[Month]**

#### Example

If the **%[Month]** macro is used to specify watermark text and the current month is February then the number "2" is inserted as a watermark:

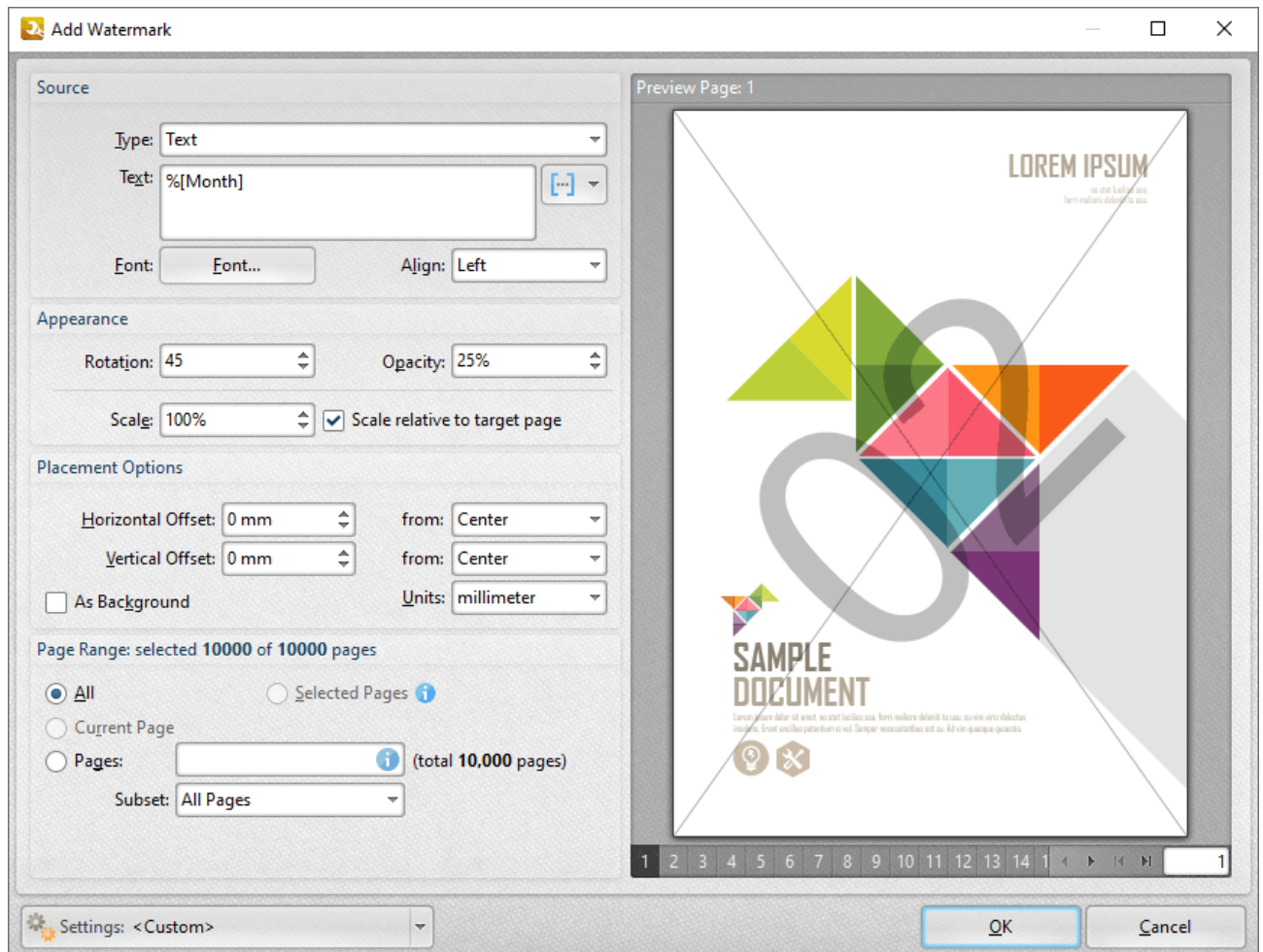

Figure 1. Add Watermark Dialog Box, %[Month] Macro Example

Note that this macro is often used in conjunction with other macros in order to create combined output. For example the combined macros **%[Time:H:mm] %[Month]/%[Day]** output the current time followed by the month and the day of the month:



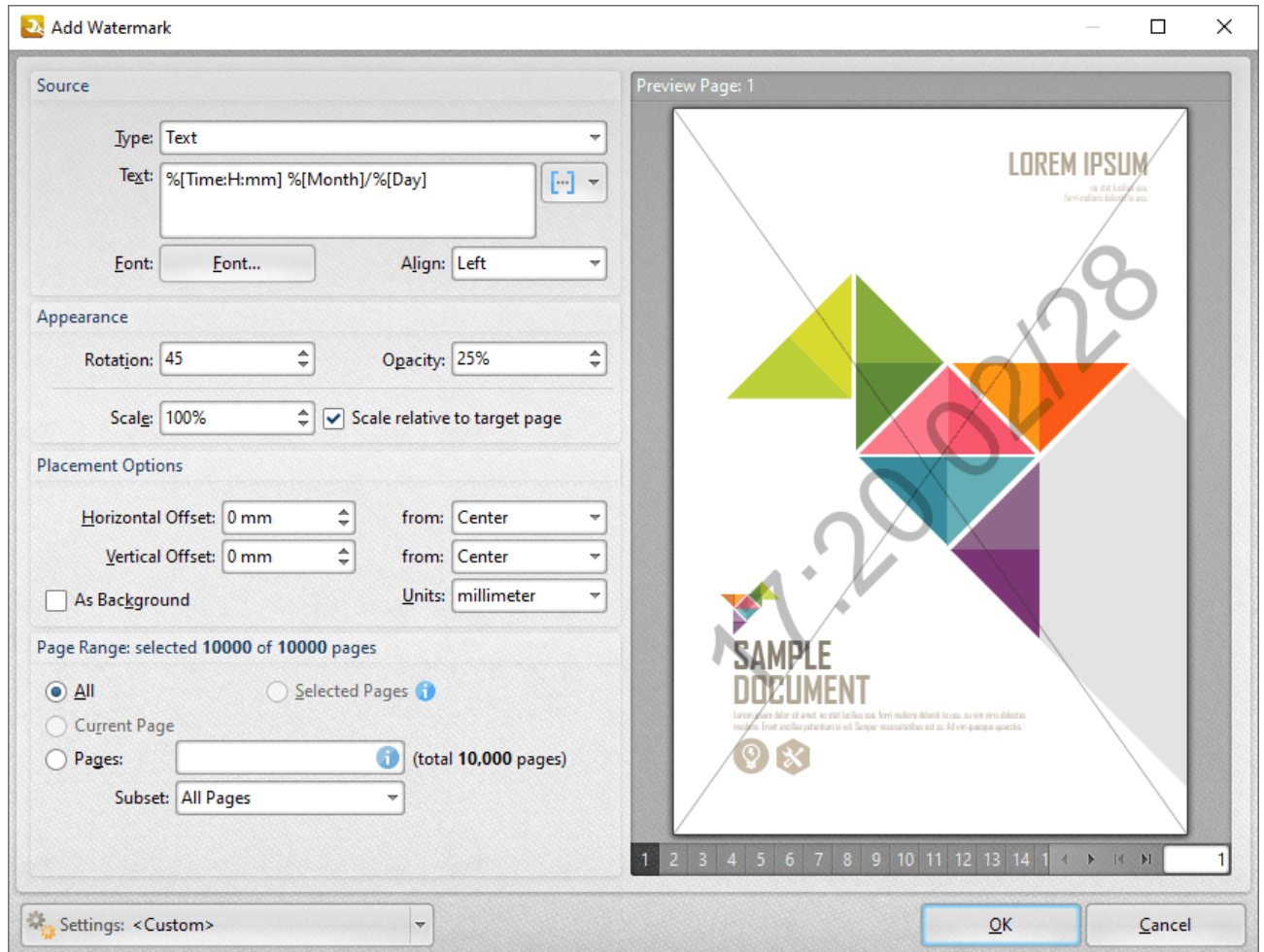

Figure 2. Add Watermark Dialog Box, Combined Macro Example

### 9.6.11 Day

---



**Day**

---

The **Day** macro inserts the current day of the month.

The syntax for this macro is **%[Day]**

#### **Example**

If the **%[Day]** macro is used to specify watermark text and the date is 28th February May then the number "28" is inserted as a watermark:

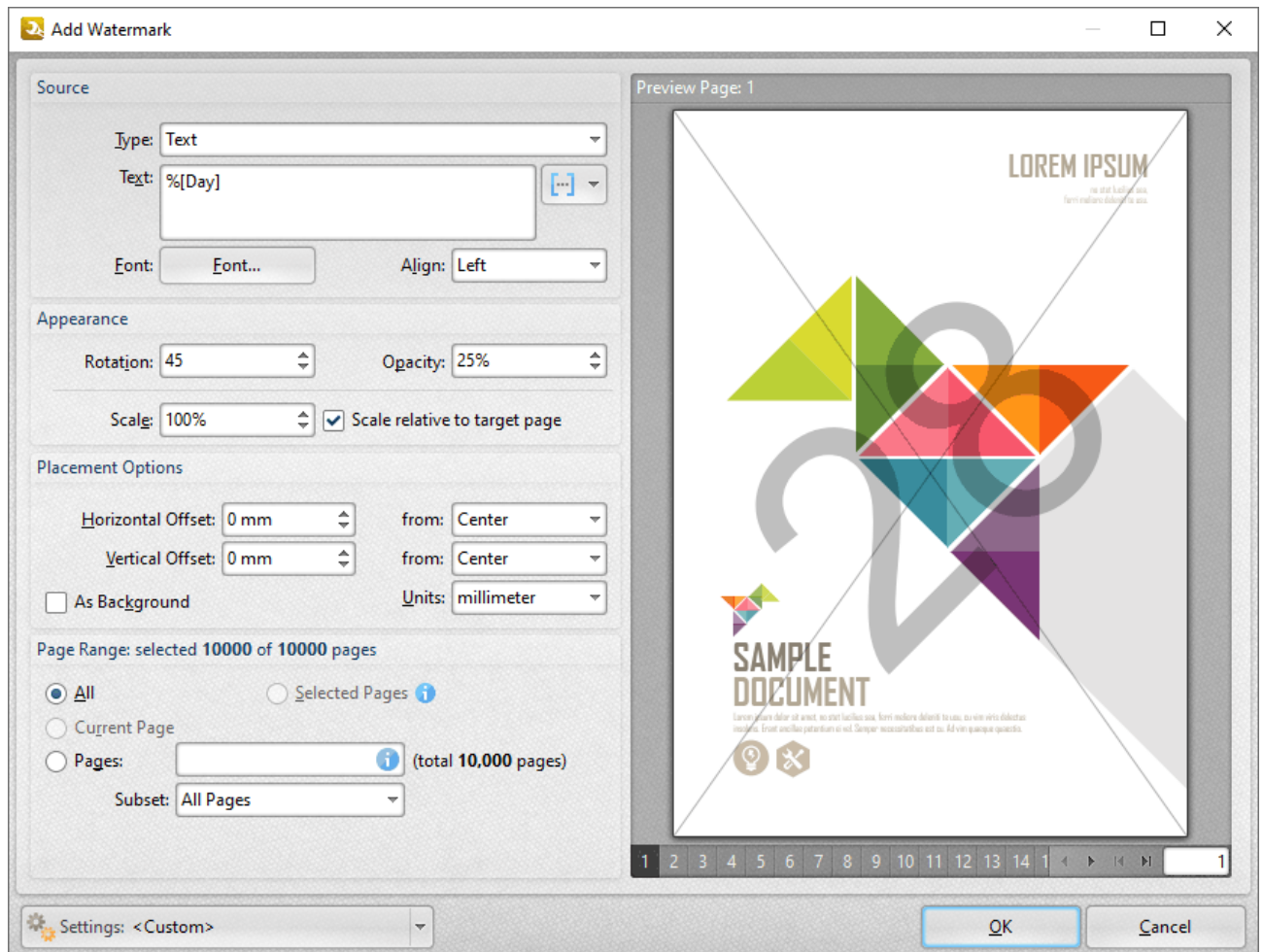

Figure 1. Add Watermark Dialog Box, %[Day] Macro Example

Note that this macro is often used in conjunction with other macros in order to create combined output. For example the combined macros **%[Time:H:mm] %[Month]/%[Day]** output the current time followed by the month and the day of the month:

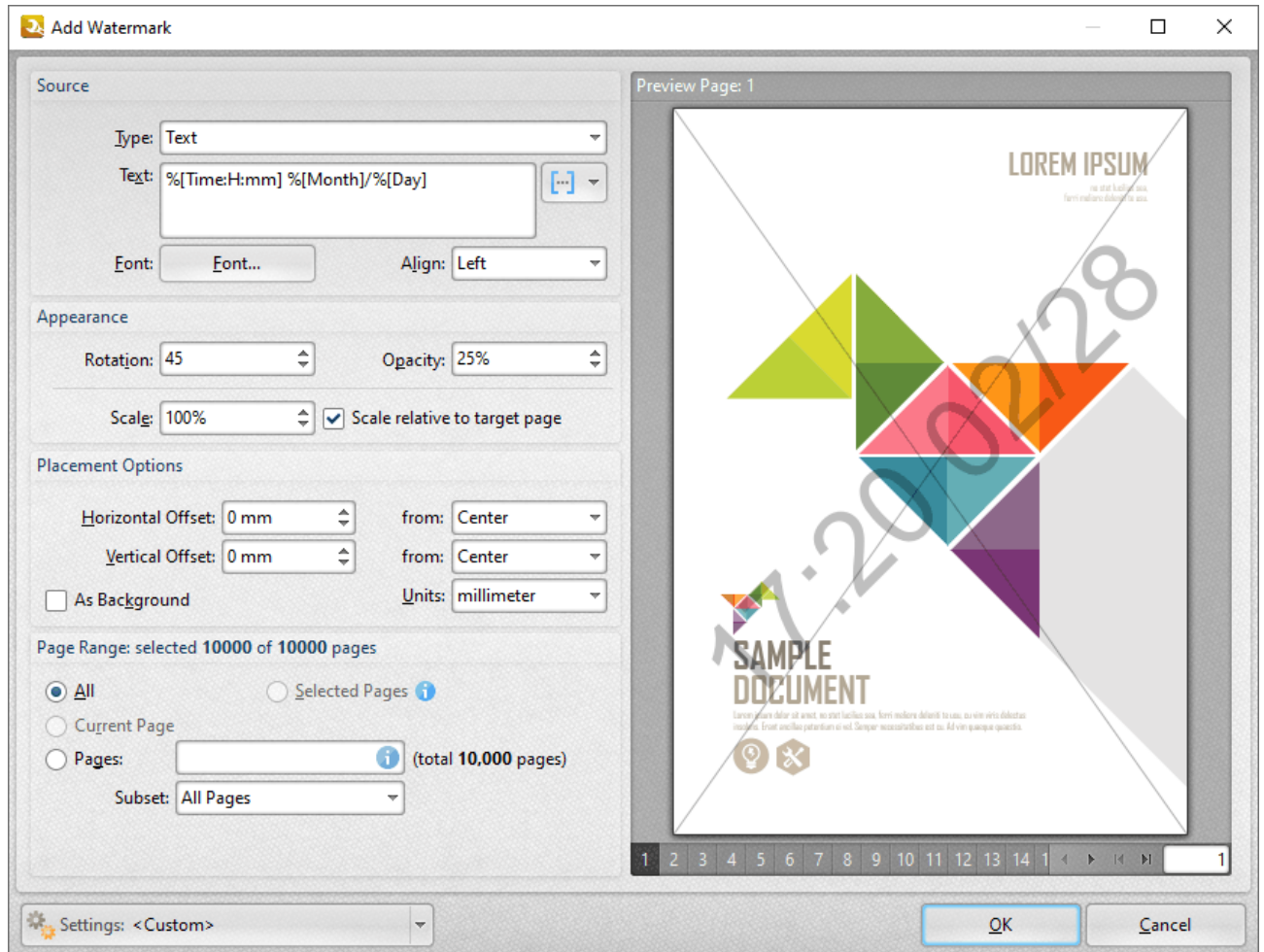

Figure 2. %[Day] Combined Macro Example

## 9.6.12 Time

---



### Time

---

The **Time** macro inserts the current time. Multiple time formats are available, as detailed below.

The syntax for this macro is **%[Time]** and the following parameters are available:

- **h** inserts the hour and omits the zero in cases of single-digit values.
- **hh** inserts the hour and includes a zero in cases of single-digit values.
- **H** inserts the hour, includes a zero in cases of single-digit values and uses a 24 hour-clock.
- **m** inserts the minutes and omits the zero in cases of single-digit values.
- **mm** inserts the minutes and includes a zero in cases of single-digit values.
- **s** inserts the seconds and omits the zero in cases of single-digit values.
- **ss** inserts the seconds and includes a zero in cases single-digit values.
- **t** inserts a single character to reference the a.m./p.m. variable: **a** or **p**.
- **tt** inserts two characters to reference the a.m/p.m. variable: **am** or **pm**.

The syntax for this macro when parameters are used is **%[Time:<Parameter>]**

Note that several parameters can be used in sequence in order to insert a customized time. For example, **%[Time:H:mm tt]** inserts the current hour and minutes, and inserts two characters to reference the a.m./p.m. variable, as detailed below.

### Example

If the macro **%[Time:H:mm tt]** is used to specify watermark text, then the current hour and minutes, and two characters to reference the a.m./p.m. variable, are inserted as a watermark:

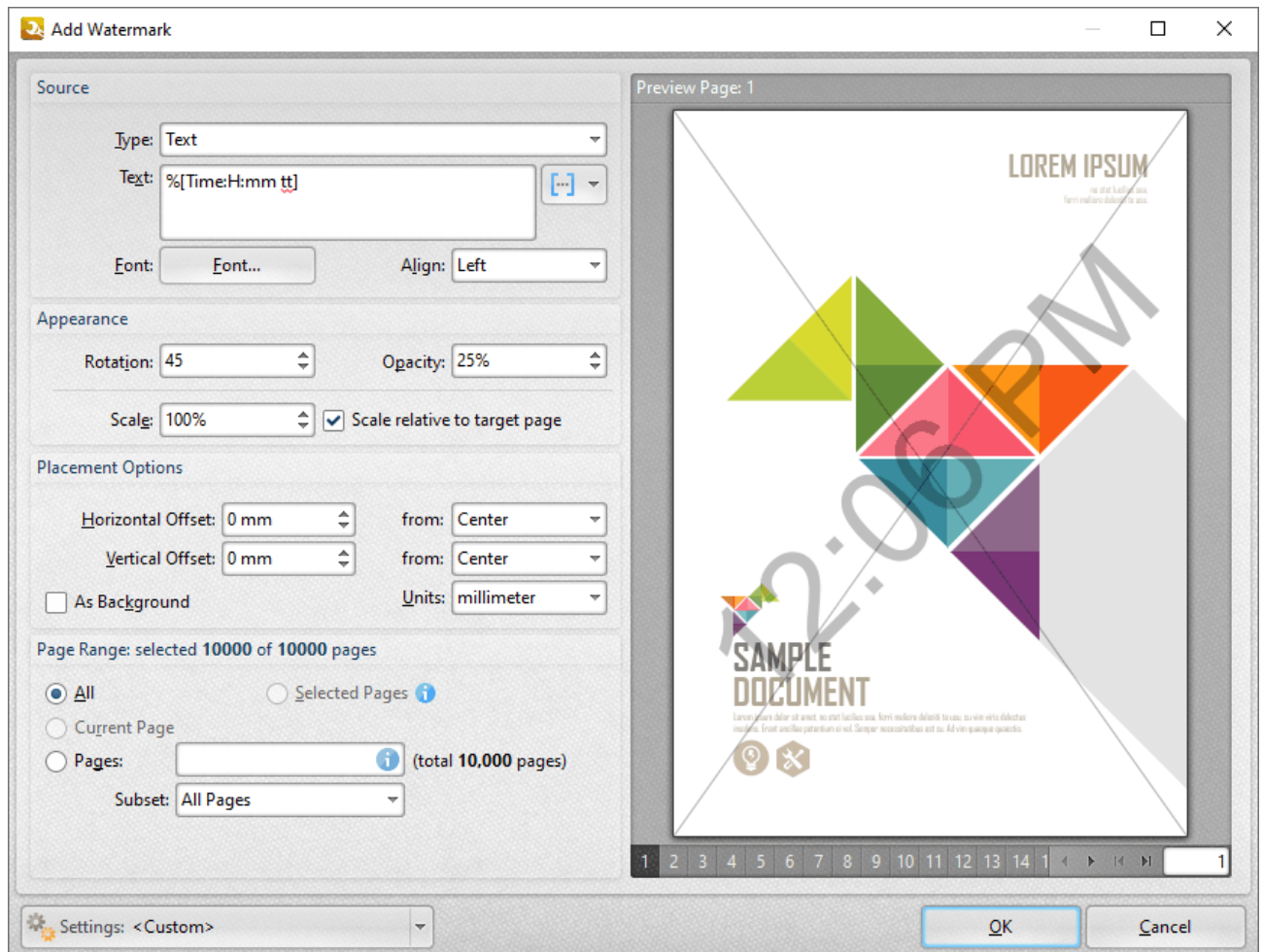

Figure 1. Add Watermark Dialog Box, %[Time] Macro Example

Note that this macro is often used in conjunction with other macros in order to create combined output. For example the combined macros **%[Time:H:mm] %[Month]/%[Day]** output the current time followed by the month and the day of the month:

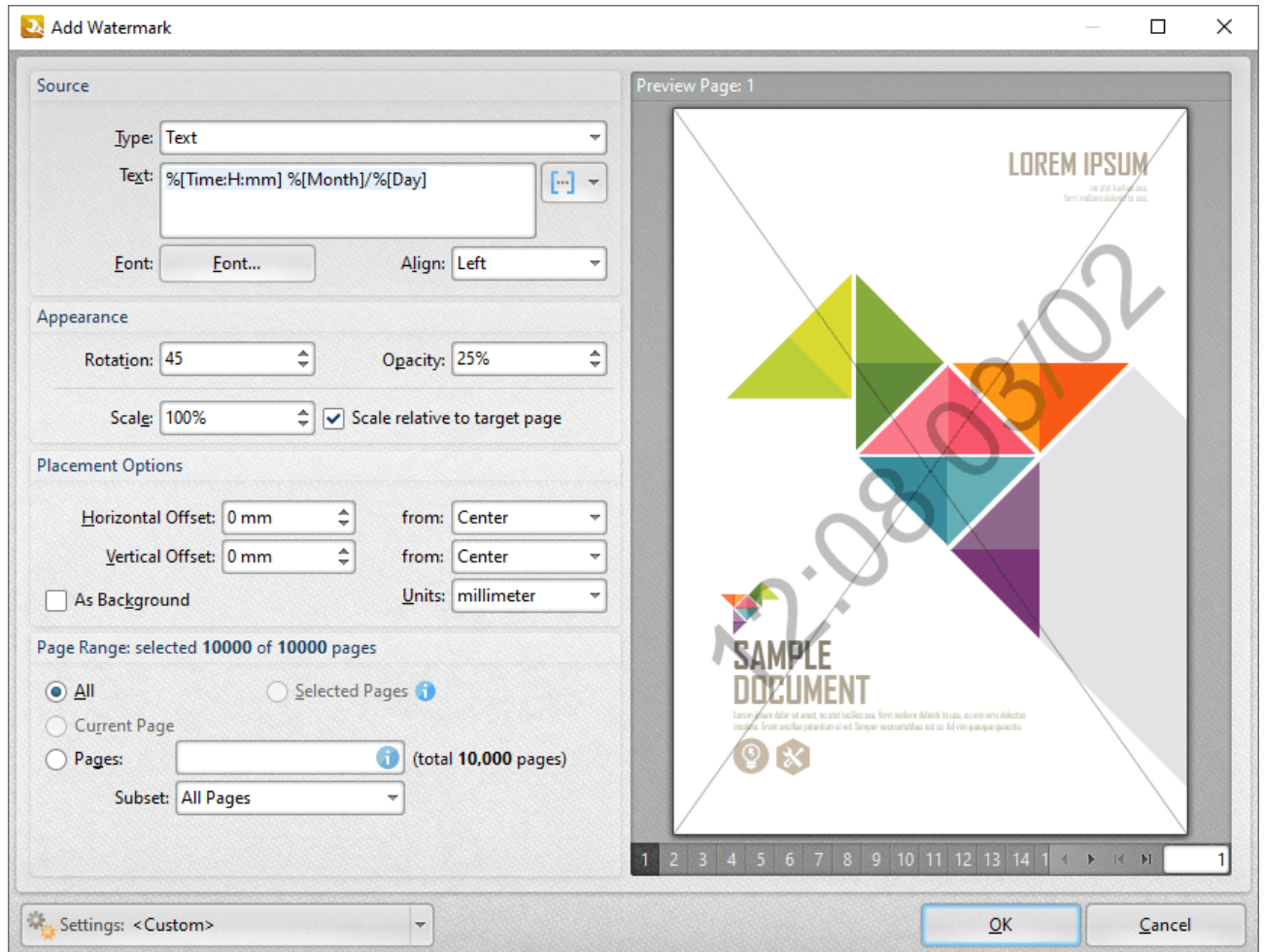

Figure 2. %[Time] Combined Macro Example

### 9.6.13 Hour

---



### Hour

---

The **Hour** macro inserts the hour value from the current time.

The syntax for this macro is **%[Hour]**

#### Example

If the **%[Hour]** macro is used to specify watermark text and the current time is 12:50 then '12' is inserted:



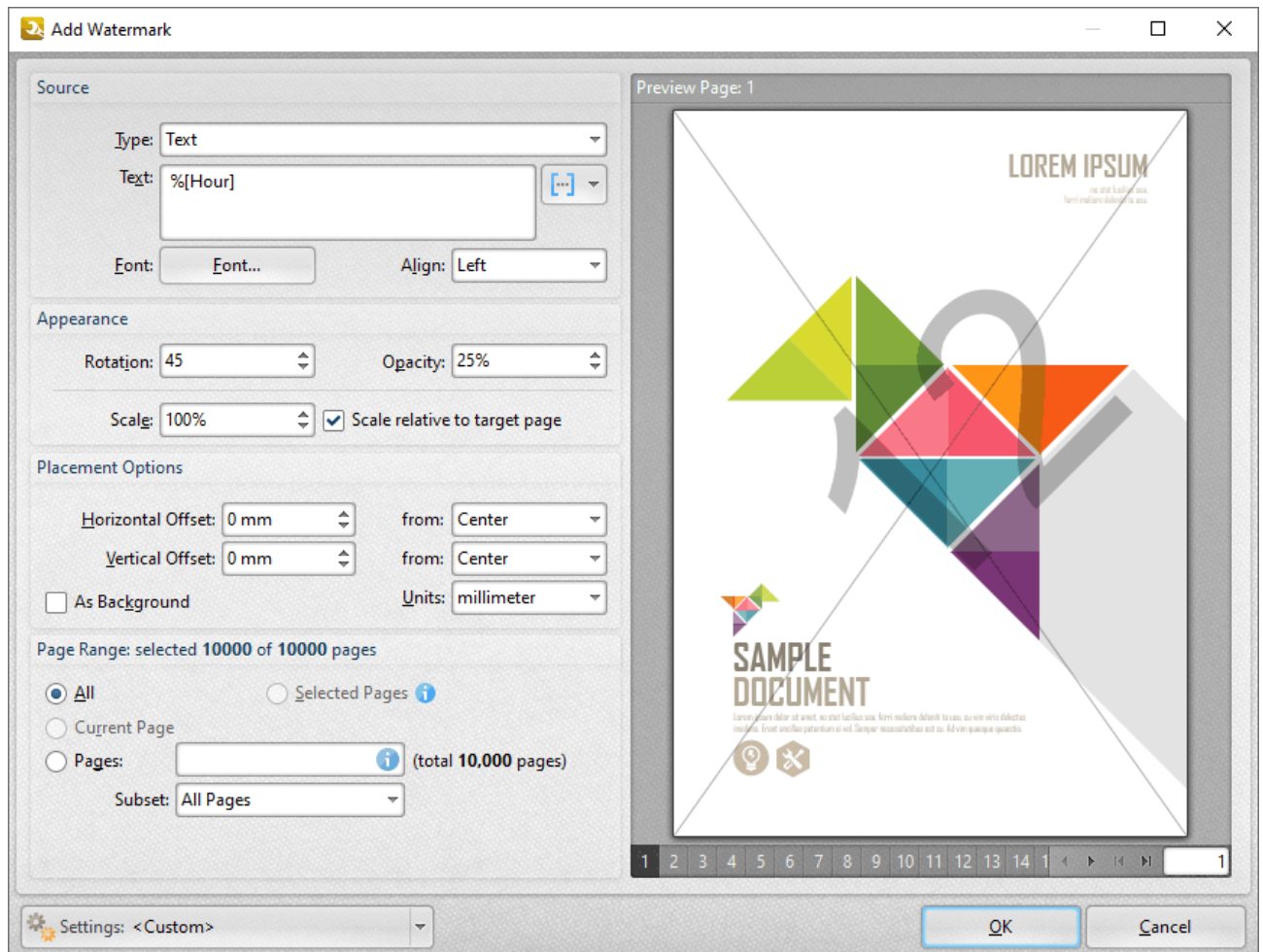

Figure 1. Add Watermark Dialog Box, %[Hour] Macro Example

Note that this macro is often used in conjunction with other macros in order to create combined output. For example the combined macros **%[Hour]:%[Minute]** output the hour followed by the minutes of the hour:

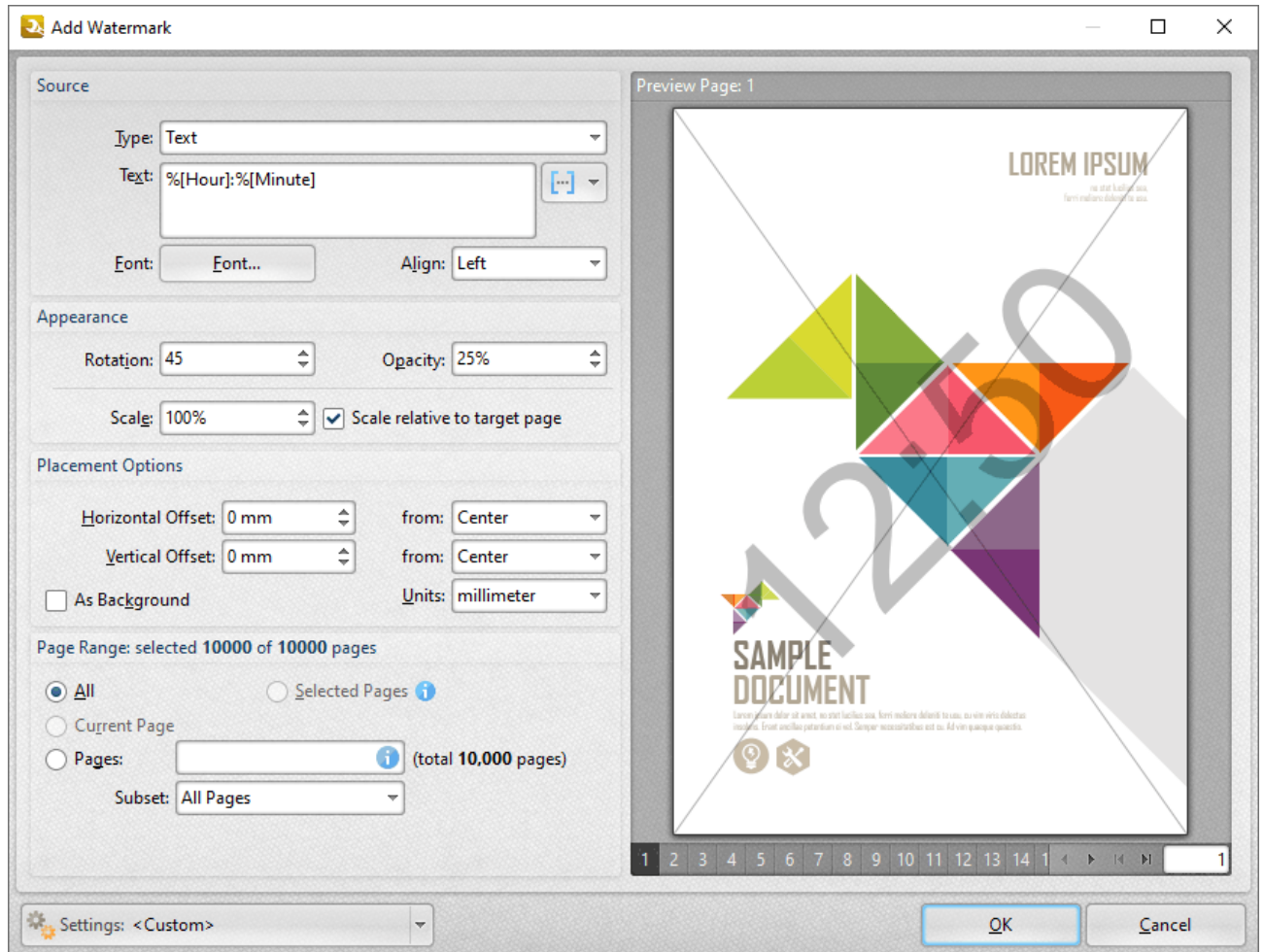

Figure 2. %[Hour] Combined Macro Example

#### 9.6.14 Minute

---



#### Minute

---

The **Minute** macro inserts the minute value from the current time.

The syntax for this macro is **%[Minute]**

#### Example

If the **%[Minute]** macro is used to specify watermark text and the current time is 12:20 then '20' is inserted:

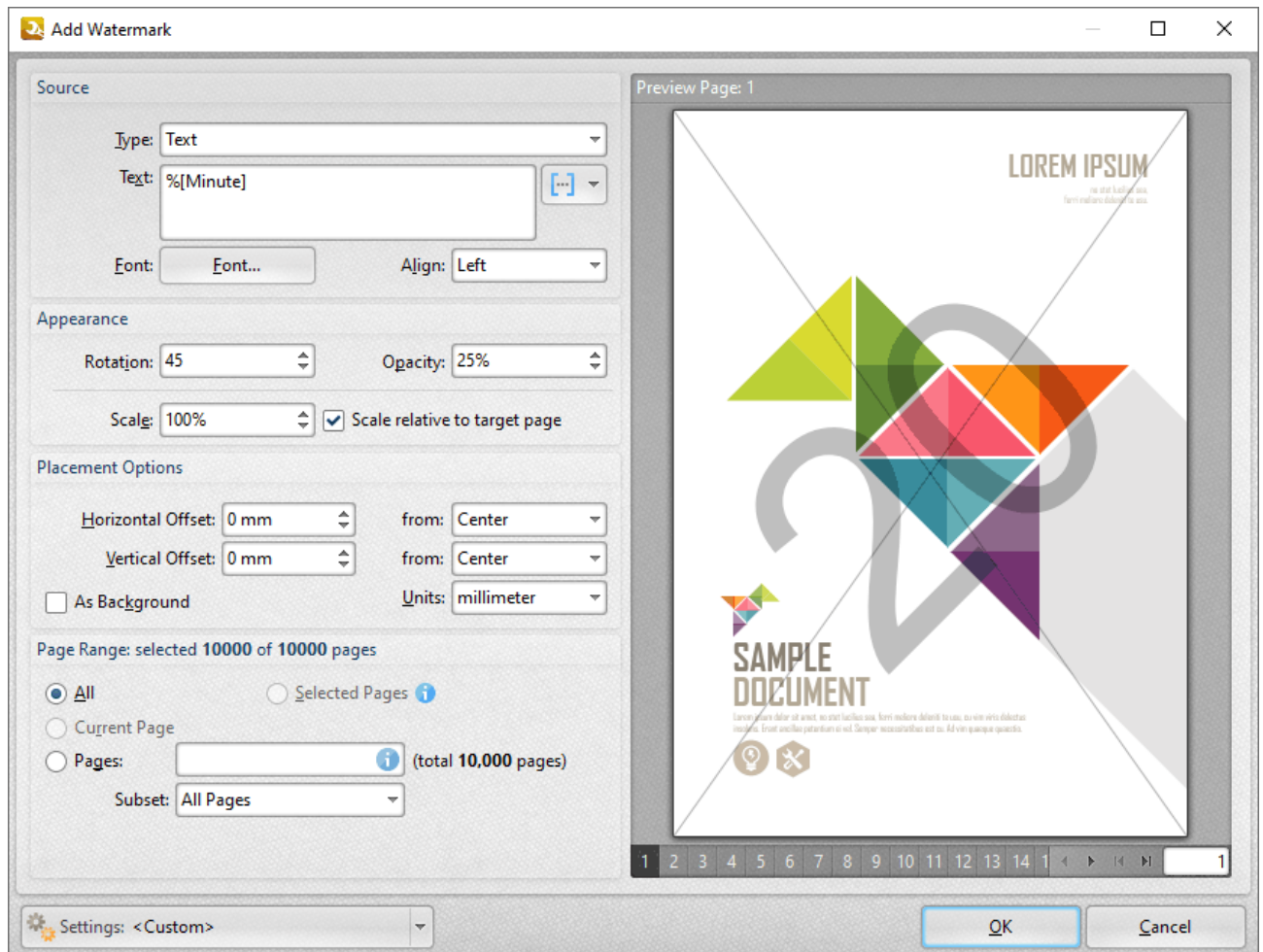

Figure 1. Add Watermark Dialog Box, %[Minute] Macro Example

Note that this macro is often used in conjunction with other macros in order to create combined output. For example the combined macros **%[Hour]:%[Minute]** output the hour followed by the minutes of the hour:

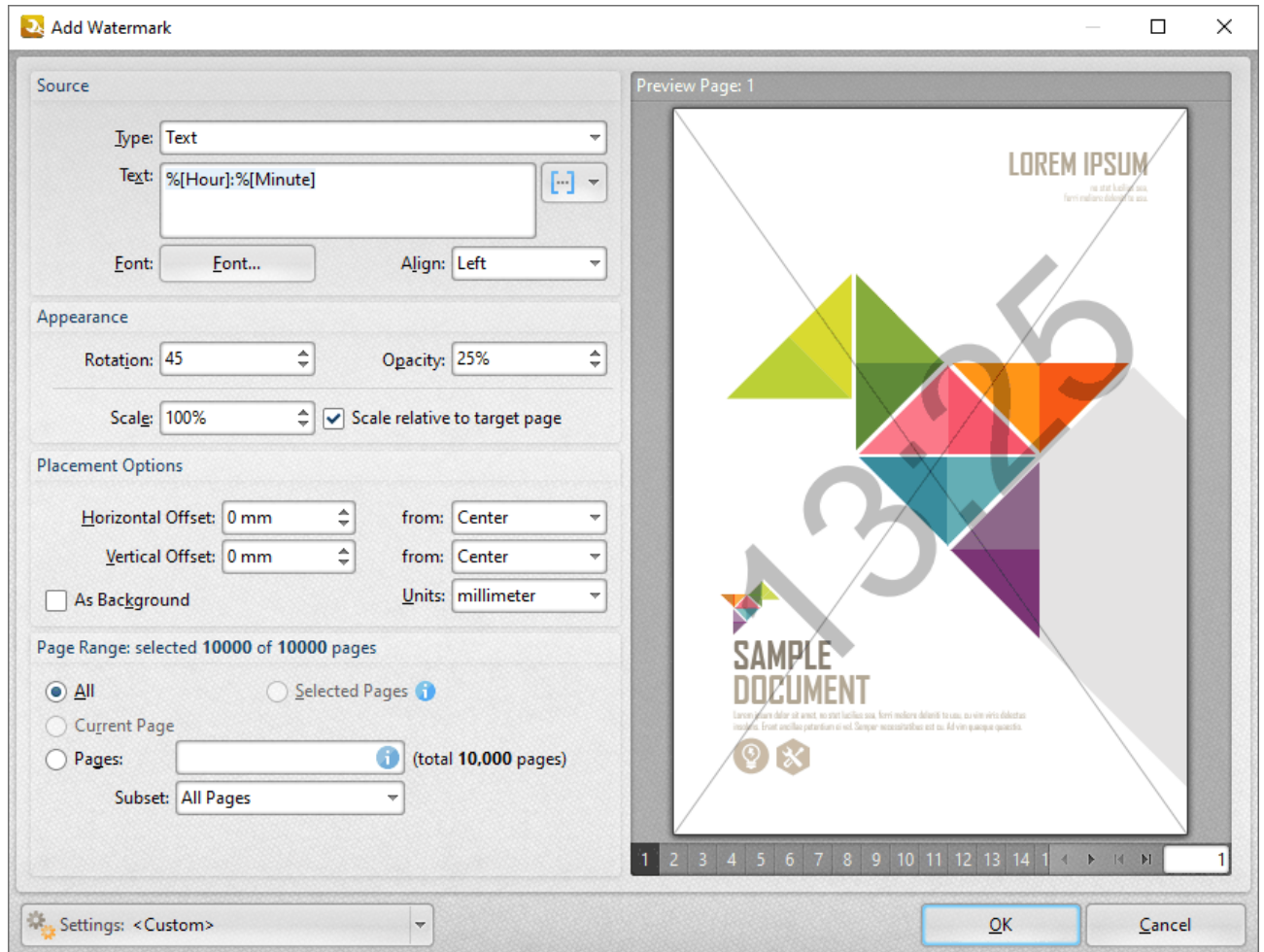

Figure 2. %[Minute] Combined Macro Example

### 9.6.15 Seconds

---



### Seconds

---

The **Seconds** macro inserts the seconds value from the current time.

The syntax for this macro is **%[Seconds]**

#### Example

If the **%[Seconds]** macro is used to specify watermark text and current time is 12:33 and 28 seconds then '28' is inserted:

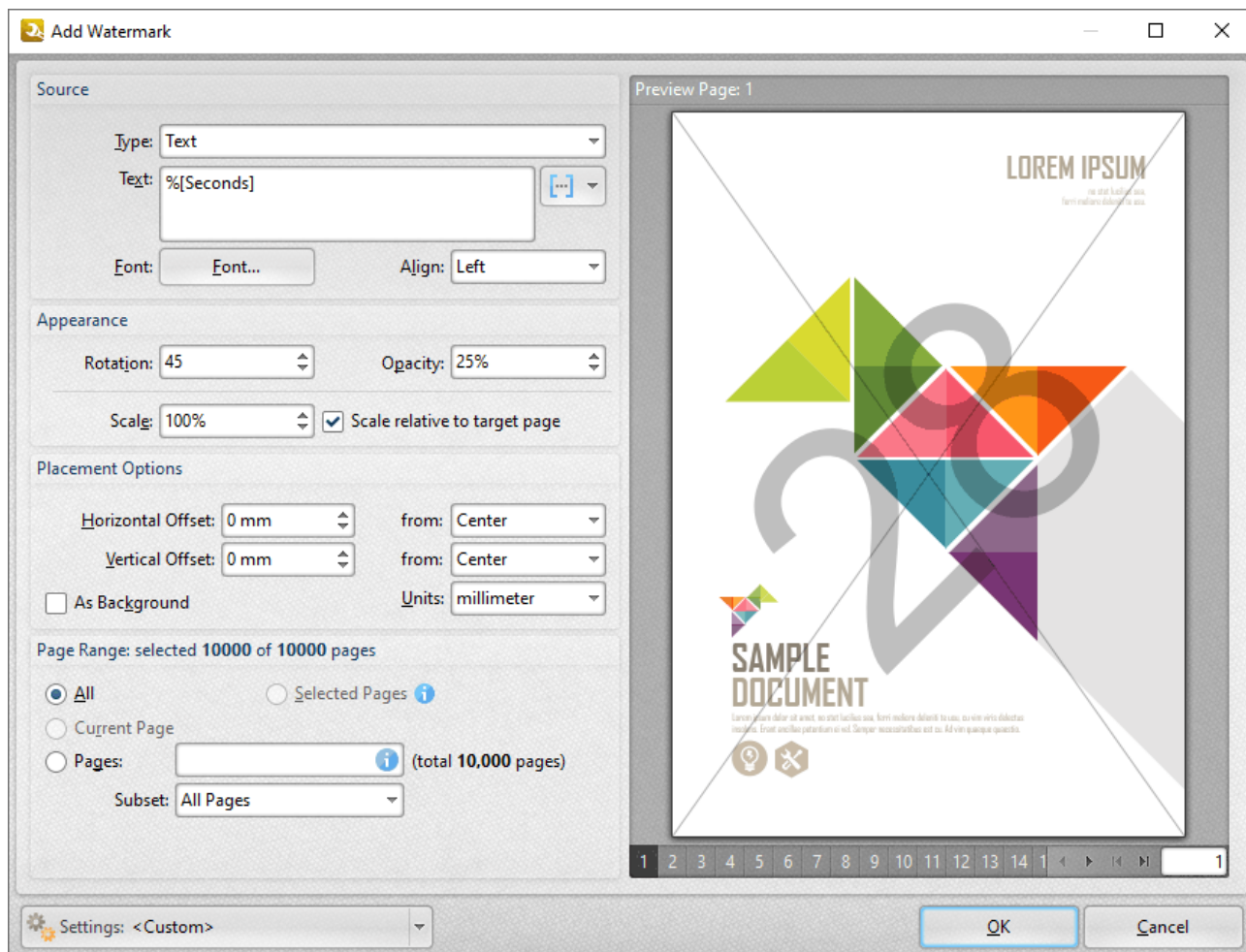

Figure 1. Add Watermark Dialog Box, %[Seconds] Macro Example

Note that this macro is often used in conjunction with other macros in order to create combined output. For example the combined macros **%[Hour]:%[Minute],%[Seconds]** output the hour followed by the minutes of the hour and the seconds of the minute:

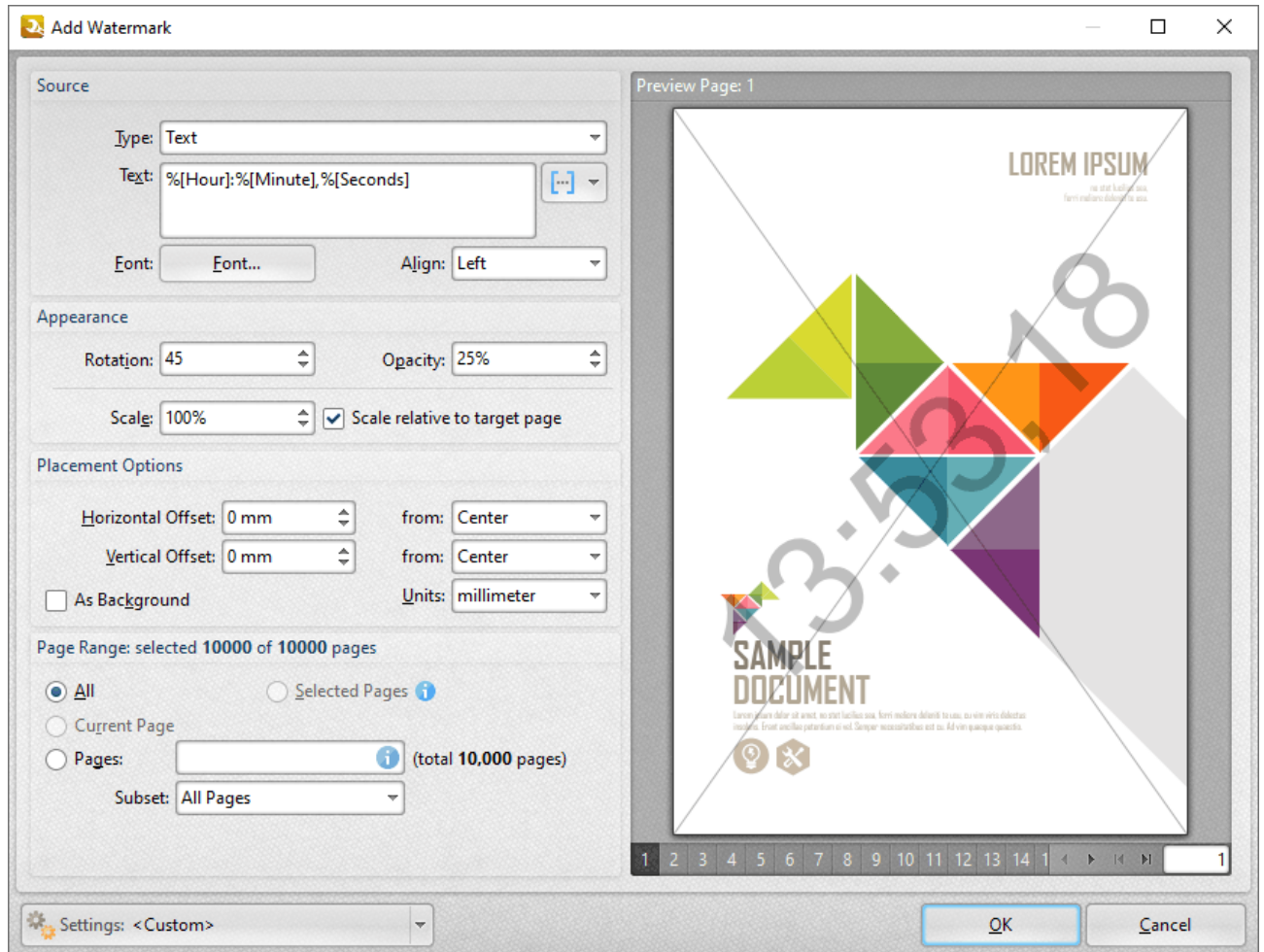

Figure 2. %[Seconds] Combined Macro Example



### 9.6.16 Computer Name

---



#### Computer Name

---

The **Computer Name** inserts the name of the local computer as defined by the **Windows Computer Name**.

The syntax for this macro is **%[Computer]**

#### Example

If the **%[Computer]** macro is used to specify watermark text then the name of the computer is inserted:

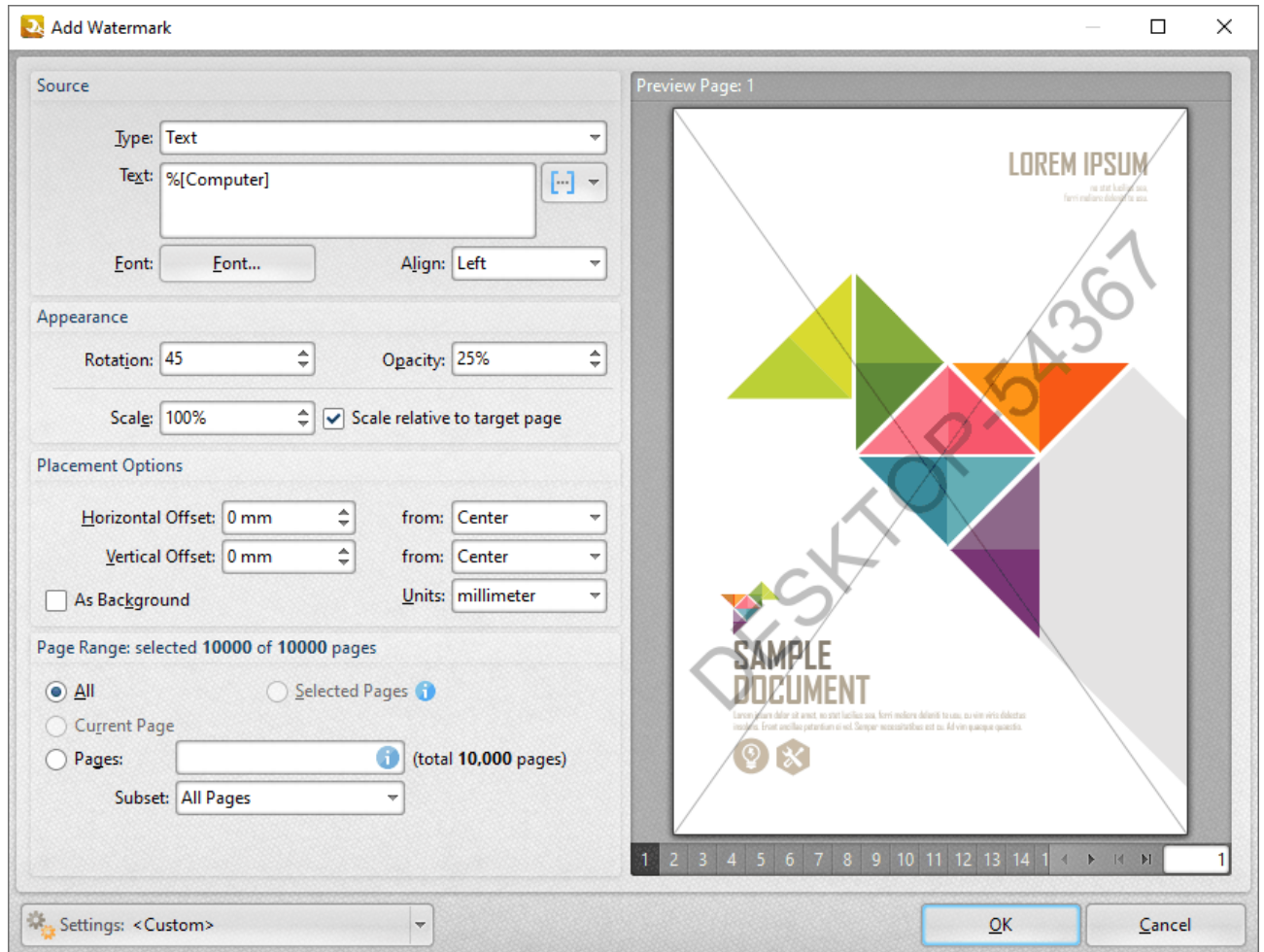

Figure 1. Add Watermark Dialog Box, %[Computer] Macro Example

### 9.6.17 Username

---



#### **Username**

---

The **Username** macro inserts the name of the current user.

The syntax for this macro is **%[User]**

#### **Example**

If the **%[User]** macro is used to specify watermark text then the name of the current user is inserted:

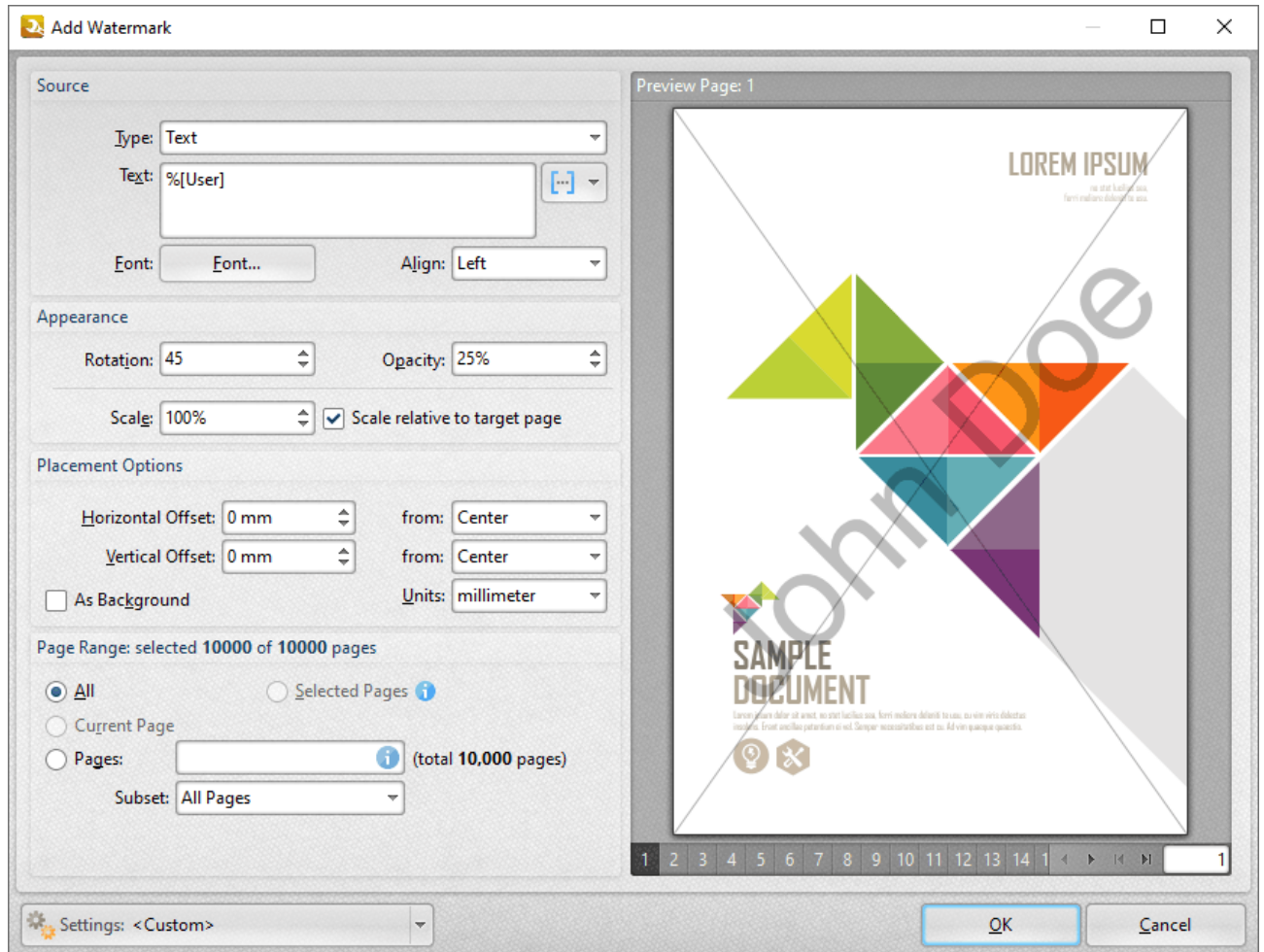

Figure 1. Add Watermark Dialog Box, %[User] Macro Example

### 9.6.18 Environment Variable

---



## Environment Variable

---

The **Environment Variable** macro inserts information taken from user-specified environment variables.

The syntax for this macro is **%[Env:<Parameter>]**

Note that a parameter must be used in order for this macro to return information. The following parameters are available:

#### **ALLUSERSPROFILE**

Inserts the full path to the *All Users* profile directory.

#### **APPDATA**

Inserts the full path to the *Application Data* directory of the current user.

#### **CommonProgramFiles**

Inserts the full path to the *Common Files* directory.

#### **CommonProgramFiles(x86)**

Inserts the full path to the *(x86) Common Files* directory in 64-bit versions of **Windows**.

#### **CommonProgramFilesW6432**

Inserts the full path to the *Common Files* directory in 64-bit versions of **Windows**.

#### **COMPUTERNAME**

Inserts the computer name.

#### **HOMEDRIVE**

Inserts the drive letter on the local computer that is connected to the user's home directory.

### **HOMEPATH**

Inserts the complete path of the current user's *Home* directory, as defined by the user's account properties.

### **LOCALAPPDATA**

Inserts the complete path to the current user's *Application Data* directory.

### **LOGONSERVER**

Inserts the name of the domain controller that authenticated the client's logon request.

### **OS**

Inserts the name of the operating system.

### **PROCESSOR\_ARCHITECTURE**

Inserts the chip architecture of the CPU.

### **ProgramData**

Inserts the full path to the *All Users* profile directory.

### **ProgramFiles**

Inserts the full path to the *Program Files* directory.

### **ProgramFiles(x86)**

Inserts the full path to the *(x86) Program Files* directory in 64-bit versions of **Windows**.

### **ProgramFilesW6432**

Inserts the full path to the *Program Files* directory in 64-bit versions of **Windows**.

### **PUBLIC**

Inserts the full path to the *Public* directory.

**SESSIONNAME**

Inserts the session name and number when a client is connected via a terminal server.

**SystemDrive**

Inserts the name of the drive on which the system folder was placed.

**SystemRoot**

Inserts the name of the system folder.

**TEMP**

Inserts the name of the default temporary folder used by the operating system and applications available to the current user.

**TMP**

Inserts the name of the default temporary folder used by the operating system and applications available to the current user. (Note that some applications require the **TEMP** environment variable, whilst others require **TMP**. The values for both should be identical).

**USERDOMAIN**

Inserts the name of the user domain that contains the account of the current user.

**USERDOMAIN\_ROAMINGPROFILE**

Inserts the name of the user domain for RDS or standard roaming profile paths.

**USERNAME**

Inserts the name of the current user.

**USERPROFILE**

Inserts the location of the current user's profile directory.

**windir**

Inserts the full path to the *Windows* directory.

### Example

If the macro **%[Env:CommonProgramFiles]** is used to specify watermark text, then the full path to the *Common Files* directory is inserted:

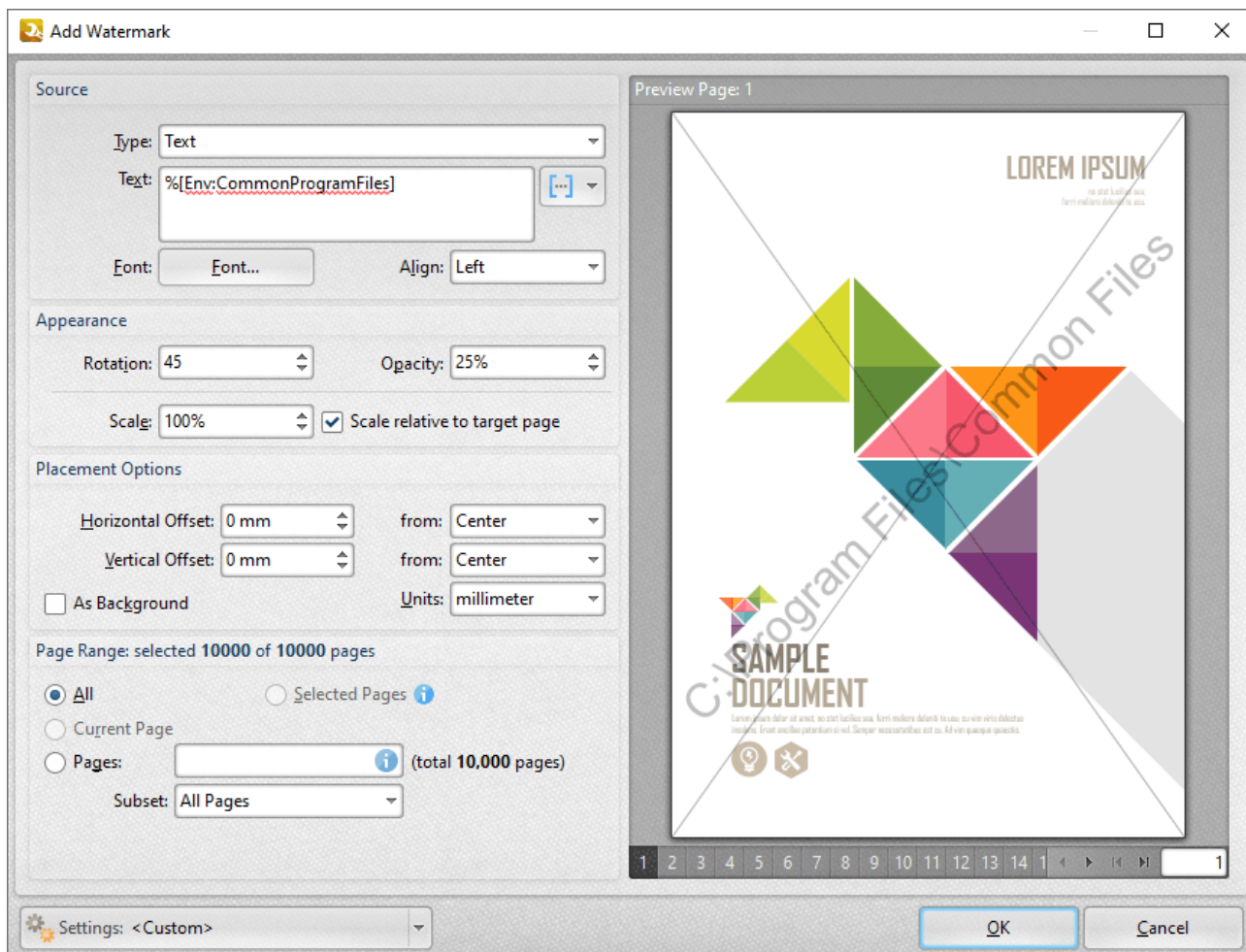

Figure 1. Add Watermark Dialog Box, %[Env:CommonProgramFiles] Macro Example

Further information on environment variables is available [here](#).



### 9.6.19 Auto Number

---



### Auto Number

---

The **Auto Number** macro inserts a numerical value as the name for output files.

The syntax for this macro is **%[AutoNumber]** and two sections of parameters are available.

The first section determines the format of page numbers:

- 'r' specifies the use of lower-case roman numerals.
- 'R' specifies the use of upper-case roman numerals.
- 'L' specifies page labels as the page numbering format in cases where page labels have been specified. If page labels have not been specified then standard page numbers are used.
- '<integer>' specifies the minimum number of digits displayed for page numbers. This value can be any positive integer from 1 to 12 - for example **%[Autonumber:4]** starts the numbering as "0001, 0002, 0003...".

The second section determines the offset for the start value. Note that the default offset is zero and the default starting value is 1. This means that if, for example, you want to start from 5, then you must specify '4'.

Please note that a semicolon must be used to delimit the sections of parameters. If the second section is not used then the semicolon can be omitted. However, if the first section is not used and the second section is used then it is necessary to use the semicolon.

The syntax for this macro when both parameters are used is **%[Autonumber:<Parameter 1>;<Parameter 2>]**

The syntax for this macro when only the second parameter is used is **%[Autonumber;;<Parameter 2>]**. For example, **'%[AutoNumber;;3]'** sets the start value as four.

Note that the starting value for output files depends on the files contained in the destination folder. If the folder is empty, or does not contain files with names that match the output parameters detailed above, then the default values are used. If the folder does contain files that match the output parameters detailed above, then the starting value will be the lowest possible integer.

## Example

The **Filename** text box of **Save Images**<sup>[137]</sup> action in the **Extract Images from PDF**<sup>[457]</sup> tool is set to **%[AutoNumber]**:

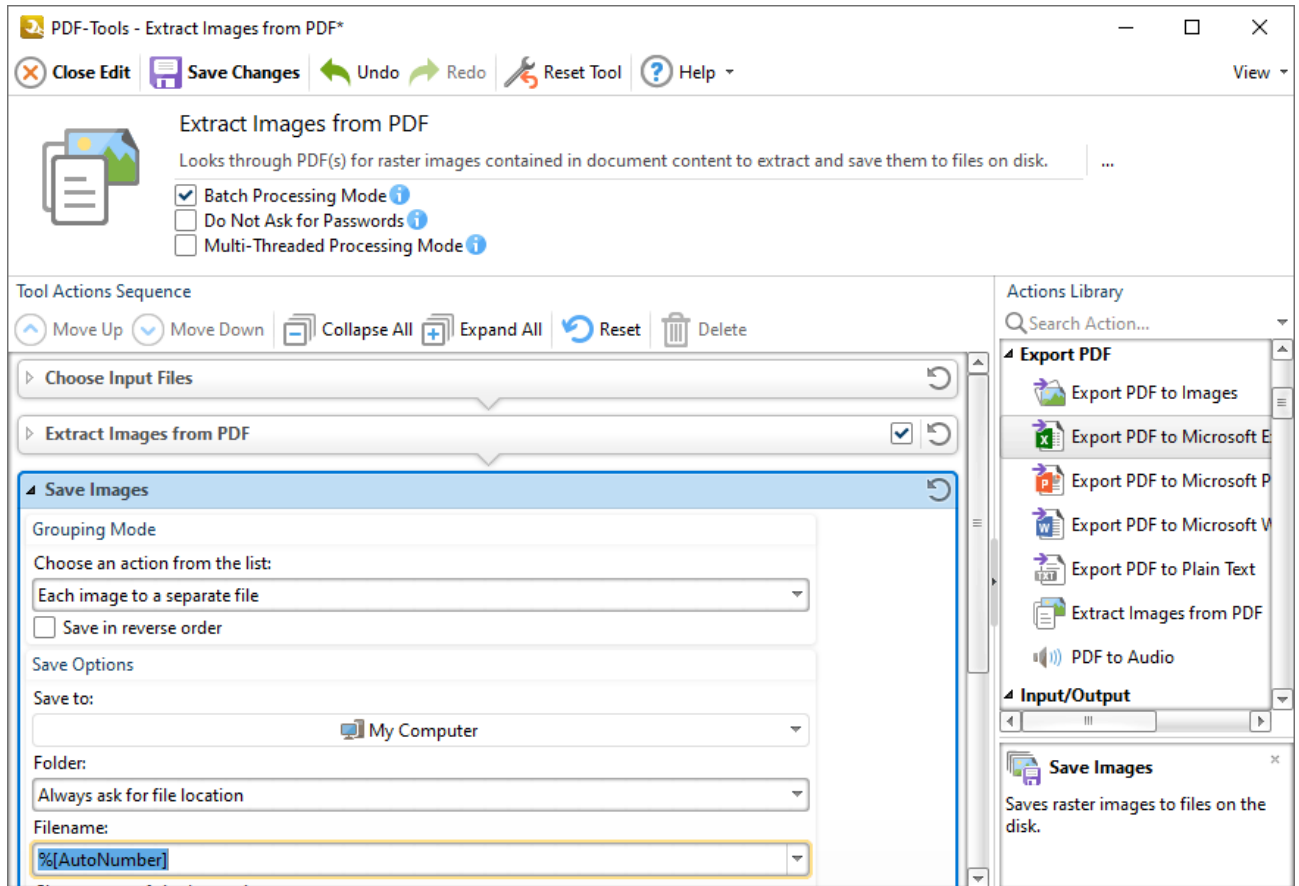

**Figure 1.** Extract Images from PDF Tool Actions Sequence, Save Images Action, %[AutoNumber] Macro Added as Filename

Therefore the output is autonumbered when the tool is used:

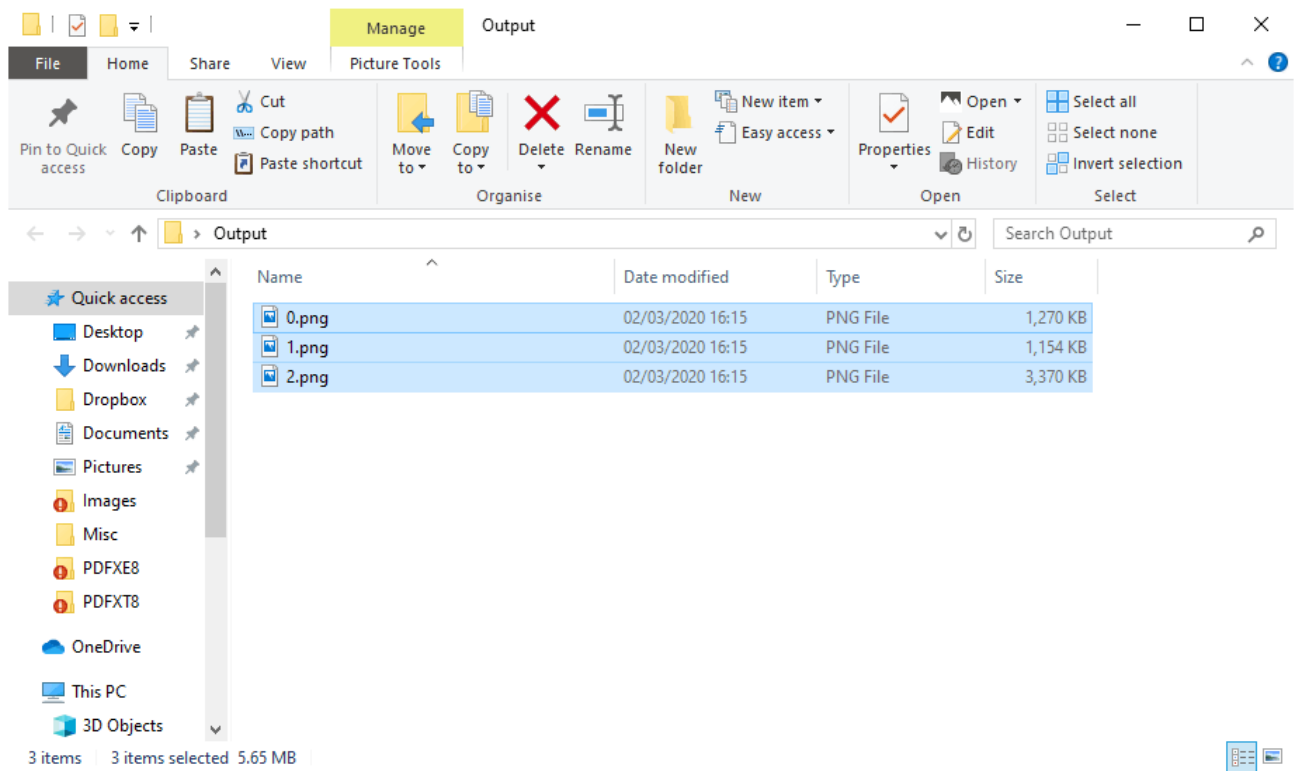

**Figure 2.** Output Folder

### 9.6.20 Application Version

---



### Application Version

---

The **Application Version** macro inserts the build and version of **PDF-Tools** on the local computer.

The syntax for this macro is **%[AppVersion]**

#### Example

If the macro **%[AppVersion]** is used to specify watermark text then the build and version of **PDF-Tools** on the local computer are inserted as a watermark:

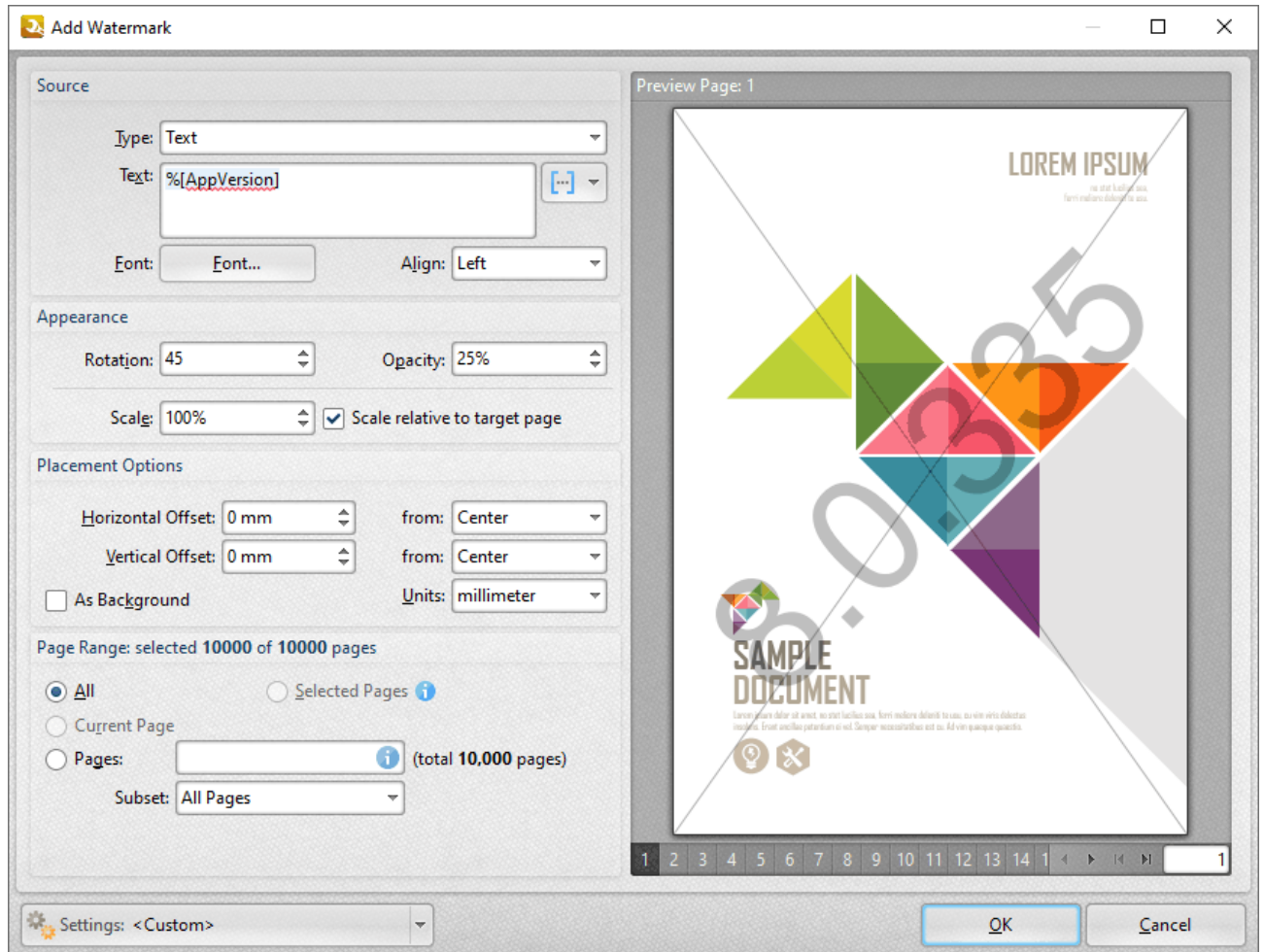

Figure 1. Add Watermark Dialog Box, %[AppVersion] Macro Example

## 9.7 Media Foundation Installation

---



### Media Foundation Installation

---

The **PDF to Audio** tool/action in **PDF-Tools** requires the installation of **Windows Media Foundation** on the local machine in order to export PDF files to **(\*mp3)** format. If you want to use this feature then it is necessary to install the **Media Feature Pack** that corresponds to the version of your system:

- The **Media Pack Installation** for **Windows 8/8.1/10** (intended for use by end users) is available at the **Microsoft** website [here](#).
- The **Media Pack Installation** for **Windows Server** (intended for use by system administrators) can be installed using the following command in **PowerShell**:

```
Install-WindowsFeature Server-Media-Foundation
```

- The **Media Pack Installation** for **Server Manager** (intended for use by system administrators) can be installed as follows:
  1. Run **Server Manager**, then click the **Manage** tab and click **Add Roles and Features**. The **Add Roles and Features Wizard** will open at the '**Before you begin**' page.
  2. Click **Next**. The **Select Installation type** page will open. Click **Next**.
  3. The **Select destination server** page will open. Select the desired server and click **Next**. The **Select server roles** page will open.
  4. Click **Features** in the list on the left, then select the **Media Foundation** box:

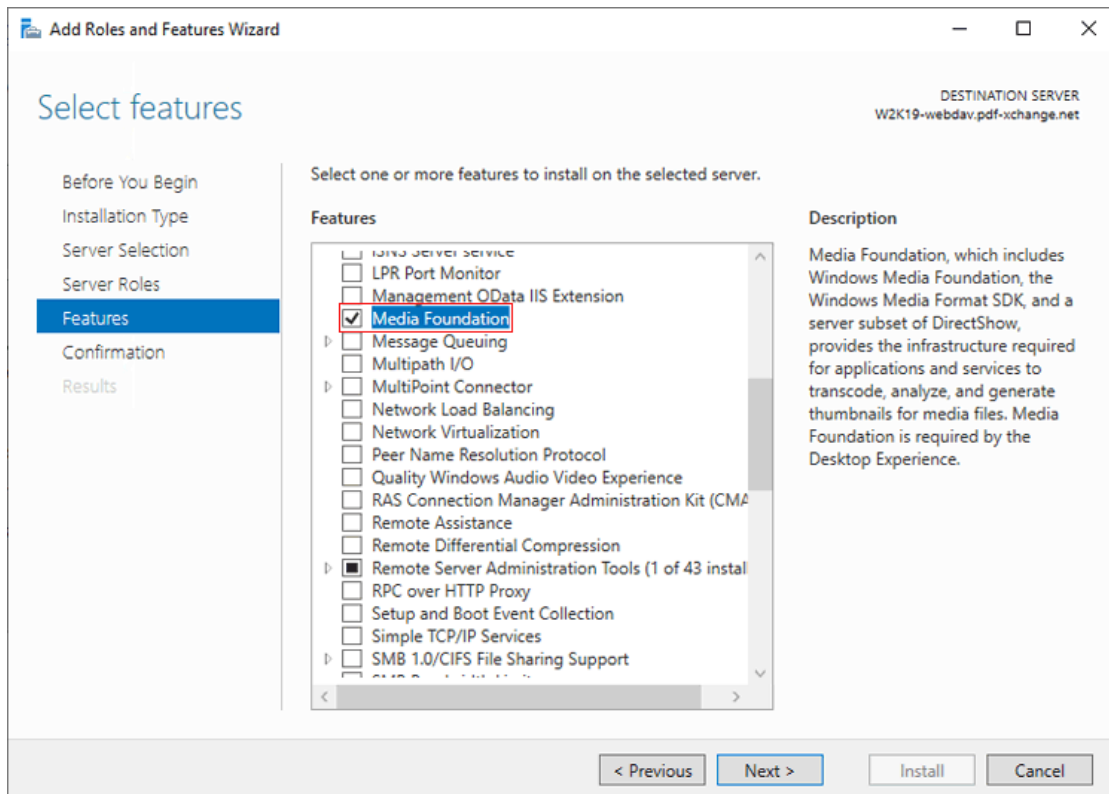

Figure 1. Add Roles and Features Wizard, Media Foundation Highlighted

5. Click **Next**. The **Confirm installation selections** page will open. Click **Install** to complete the process.

## 9.8 Page Range Options



### Page Range Options

There are multiple settings in **PDF-Tools** that feature **Page Range** specification:

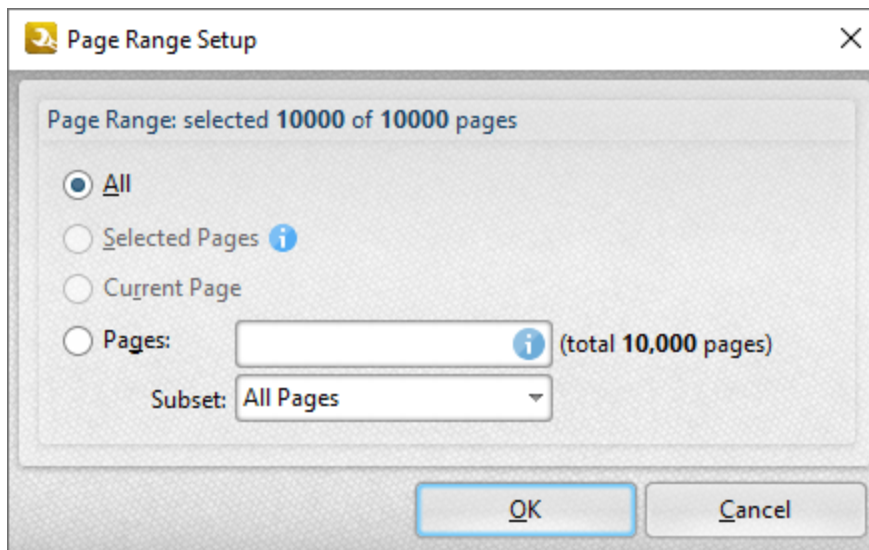

Figure 1. Page Range Setup Dialog Box

- Select **All** to include all document pages.
- The **Current Page** and **Selected Pages** options are not currently available. They will be available in a future build of **PDF-Tools**.
- Select **Pages** to determine custom page ranges. Please note:
  - Use commas to separate individual pages.
  - Use hyphens to determine page ranges.
  - Use commas to separate page ranges if multiple page ranges are defined.
  - Use a dash before a page number to determine all pages from the beginning of the document to the specified page. For example **-7** defines all pages from the beginning of the document to page seven.
  - Use a dash after a page number to determine all pages from the specified page to the end of the document. For example **7-** defines all pages from page seven to the end of the document.



- Use the **Subset** menu to specify a subset of custom page ranges as desired. The options are **All Pages**, **Odd Pages Only** and **Even Pages Only**.

Click **OK** to save changes.

---

## 9.9 Preferences



### Preferences

Click **Preferences** in the **Options** tab to launch the **Preferences** dialog box:

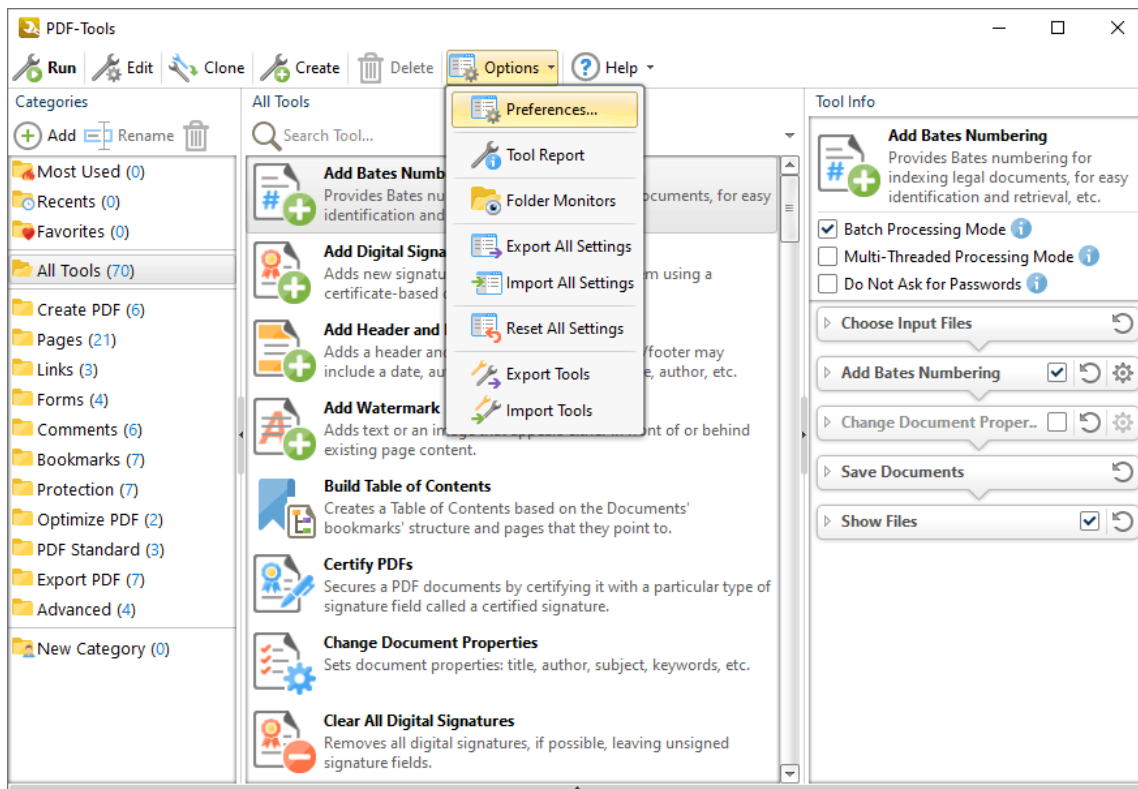

Figure 1. PDF-Tools Main Window, Options Tab, Preferences Highlighted

The **Preferences** dialog box will open:

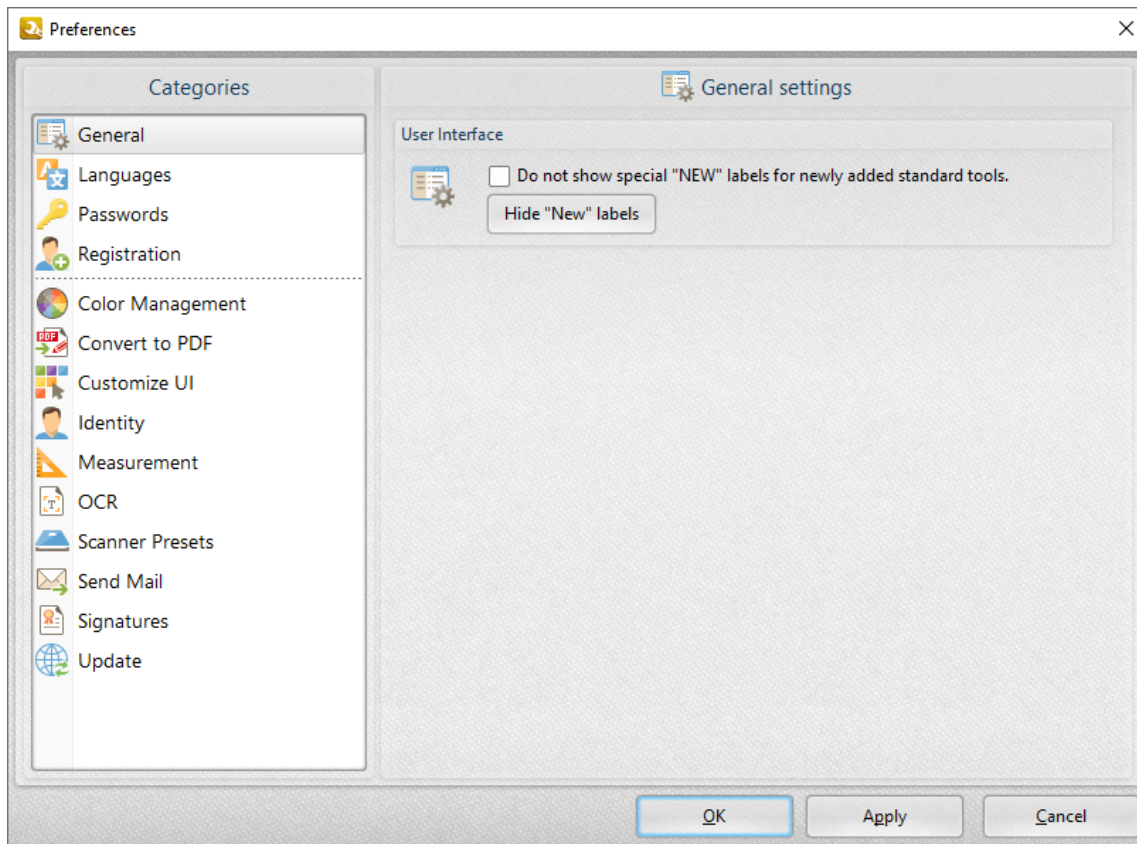

Figure 2. Preferences Dialog Box

These options are used to customize general settings in **PDF-Tools**. Click categories for further information:

- [General](#) <sup>556</sup>
- [Languages](#) <sup>558</sup>
- [Passwords](#) <sup>560</sup>
- [Registration](#) <sup>562</sup>
- [Color Management](#) <sup>564</sup>
- [Convert to PDF](#) <sup>566</sup>
- [Customize UI](#) <sup>568</sup>
- [Identity](#) <sup>570</sup>
- [Measurement](#) <sup>571</sup>
- [OCR](#) <sup>572</sup>
- [Scanner Presets](#) <sup>574</sup>
- [Send Mail](#) <sup>578</sup>
- [Signatures](#) <sup>580</sup>
- [Update](#) <sup>584</sup>

## 9.9.1 General

**General**

The **General** preferences determine general preferences in **PDF-Tools**:

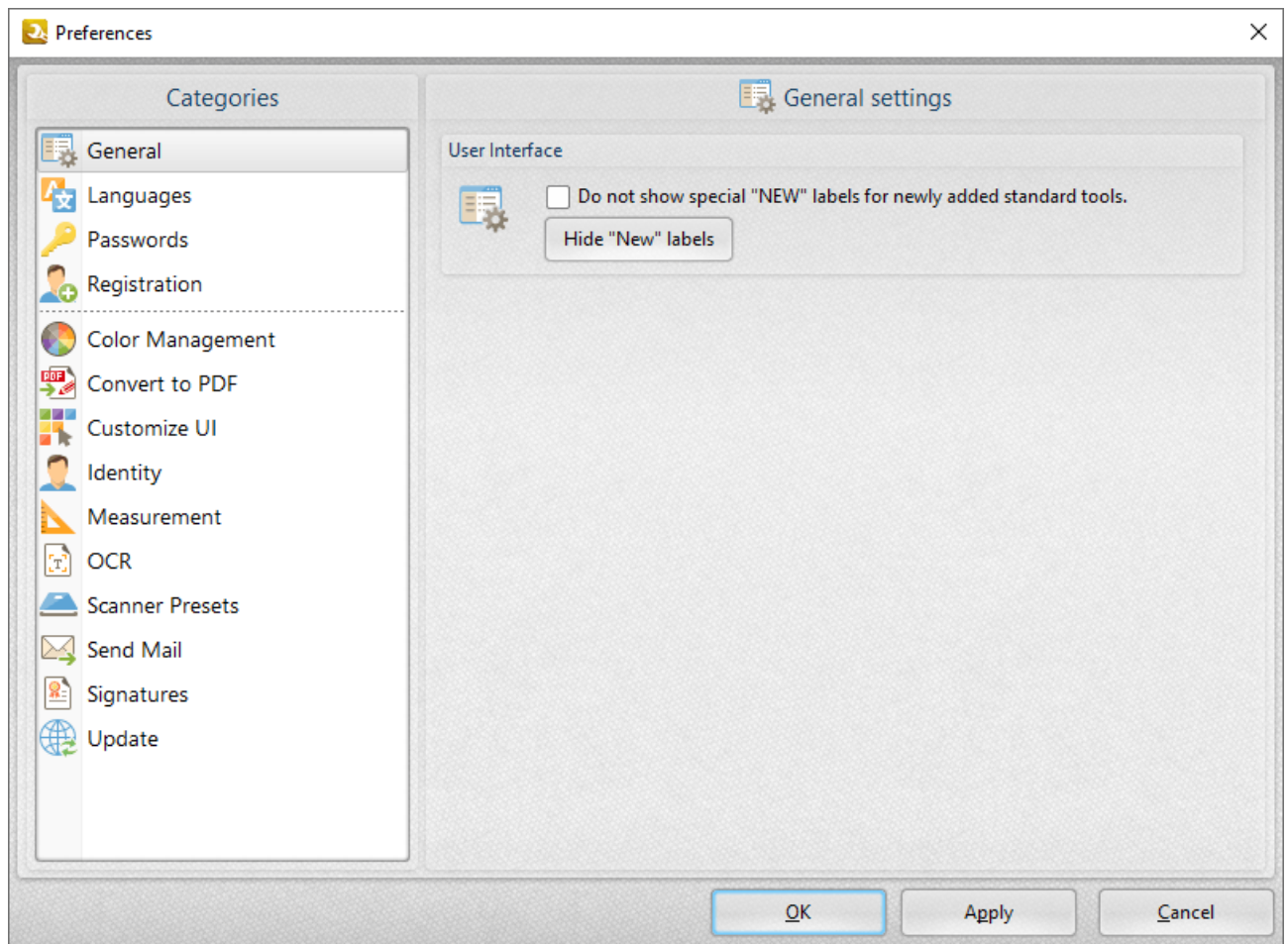

**Figure 1.** Preferences Dialog Box, General Tab

Select/clear the check box to disable/enable the "new" label that appears next to new tools in the user interface.

Click **OK** to save changes.



## 9.9.2 Languages



## Languages

The **Languages** preferences determine the language of the user interface in **PDF-Tools**:

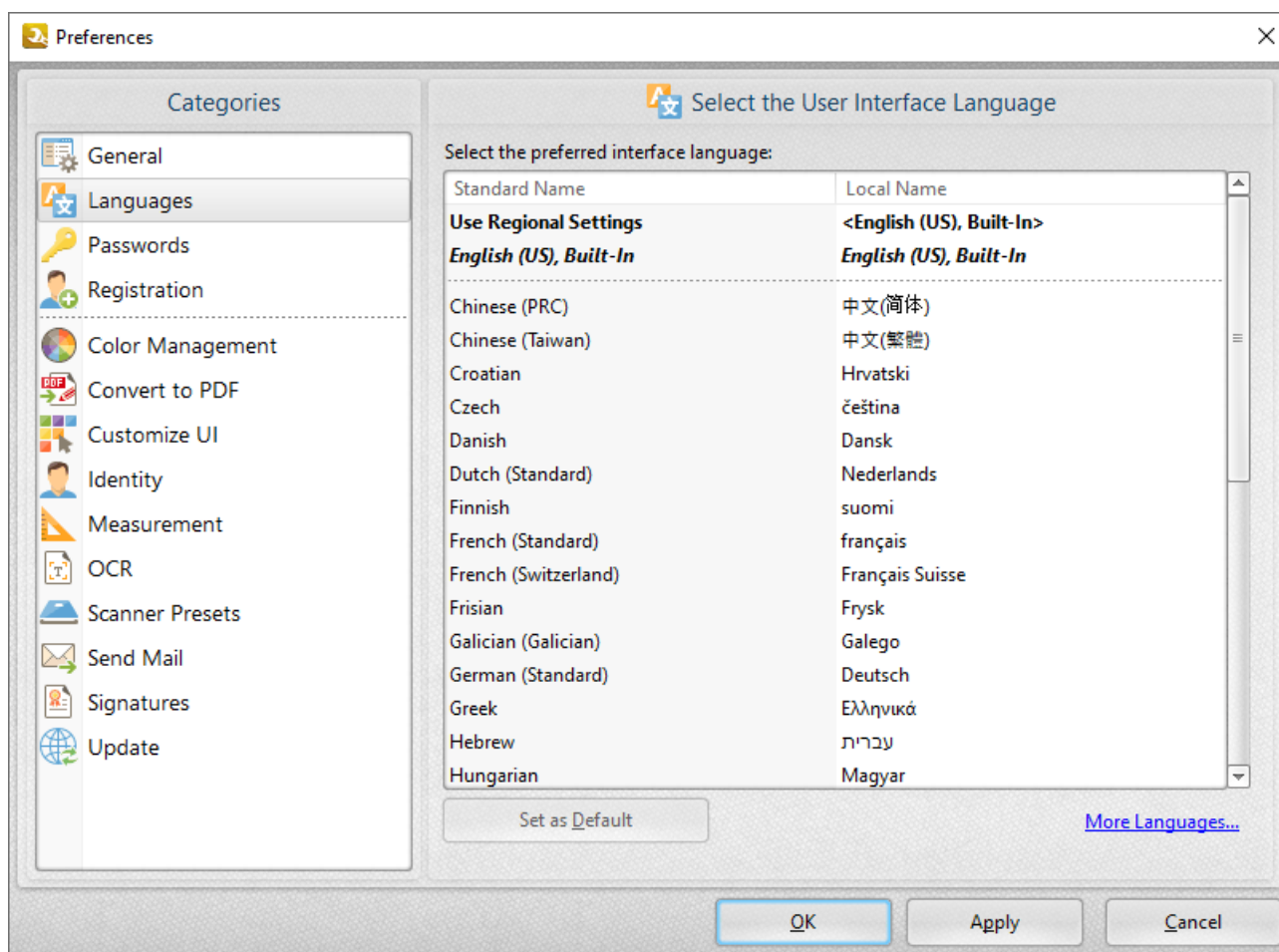

Figure 1. Preferences Dialog Box, Language Tab

- Double-click languages to change the UI language.
- Click **Set as Default** to set the current language as the default language.
- Click **More Languages** to view additional language options.

Click **OK** to save changes.



## 9.9.3 Passwords

**Passwords**

The **Passwords** preferences are used to create a database of stored passwords that is used when **PDF-Tools** is processing files:

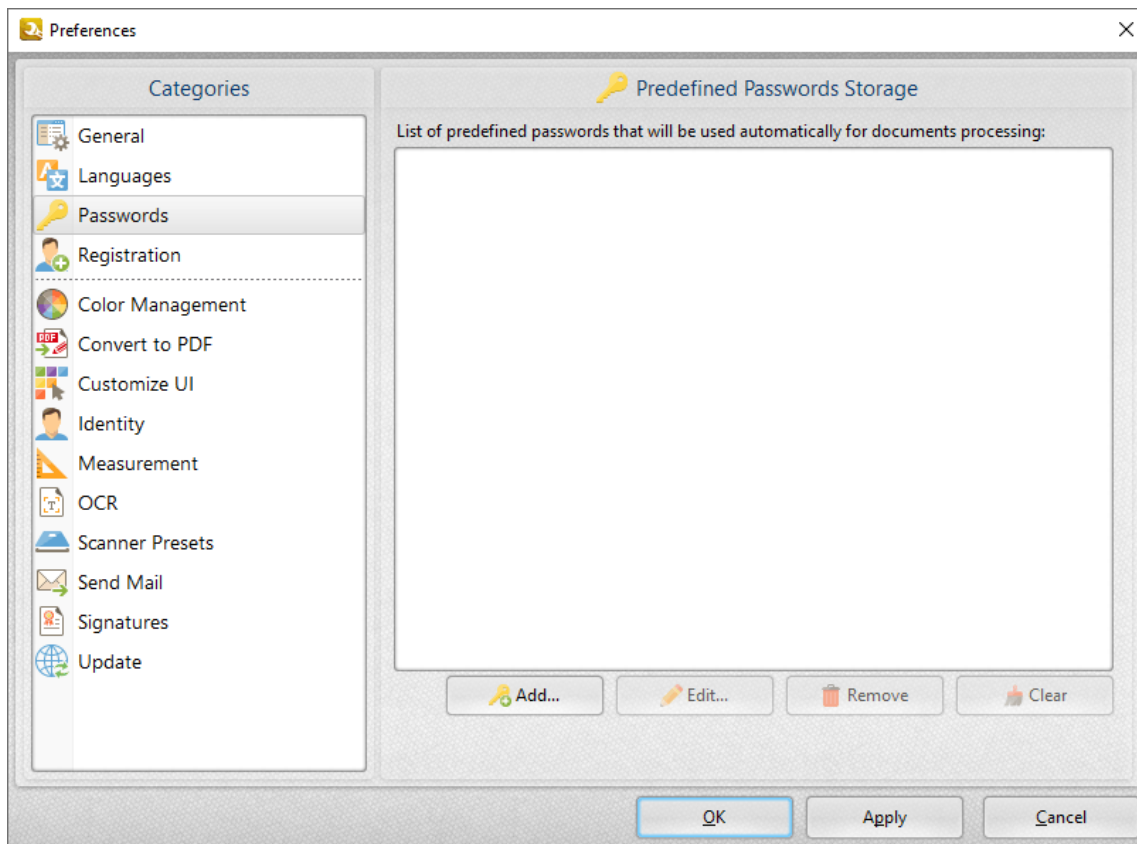

**Figure 1.** Preferences Dialog Box, Passwords Tab

If processed files are password-protected and the relevant password is included in this list then **PDF-Tools** will not prompt for a password.

- Click **Add** to add new passwords to the list.
- Click **Edit** to edit the name of existing passwords.
- Click **Remove** to remove selected passwords.



- Click **Clear** to remove all passwords from the list.

Click **OK** to save changes.

---

## 9.9.4 Registration

**Registration**

The **Registration** preferences are used to view/add/remove license keys:

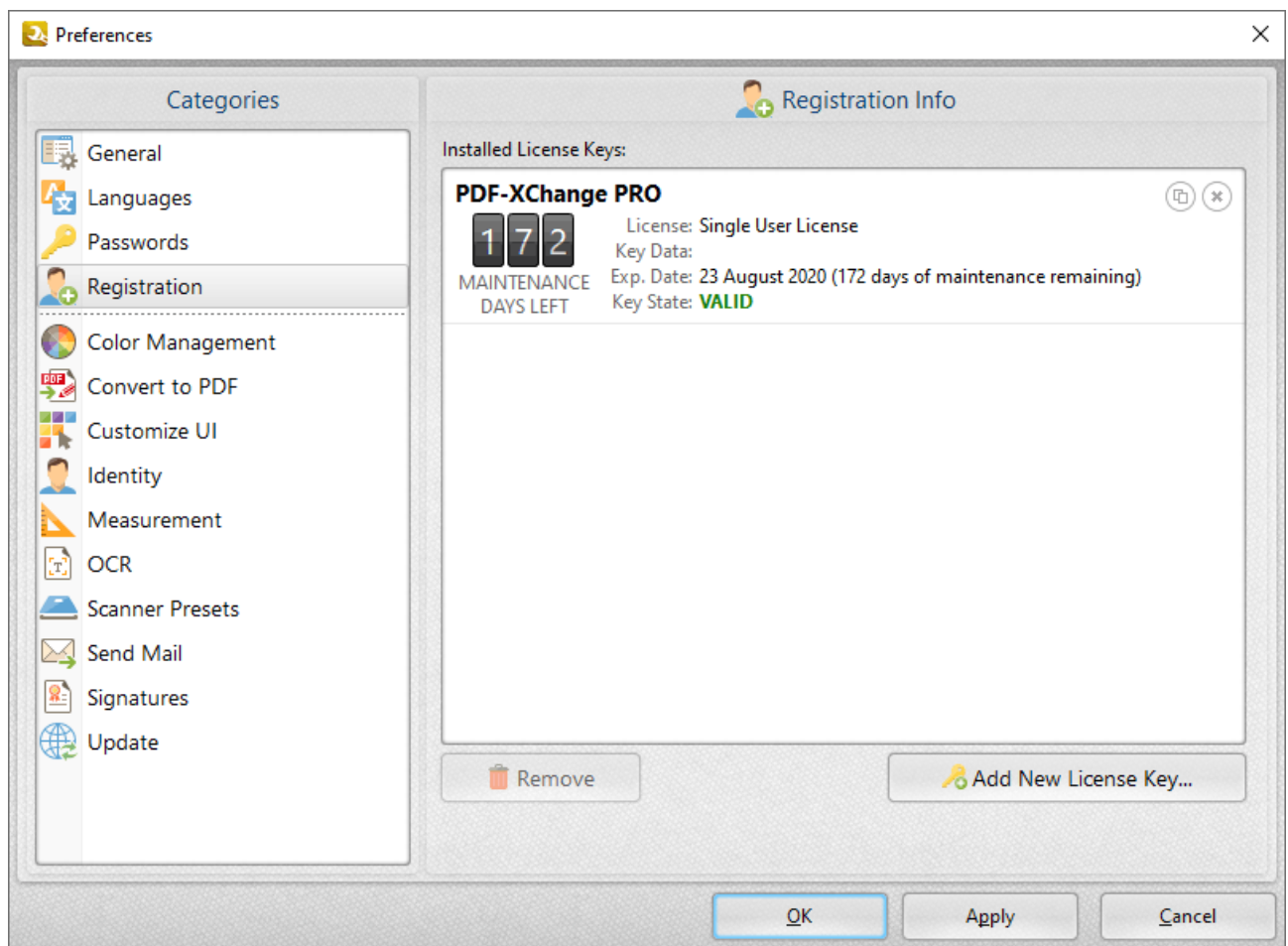

**Figure 1.** Preferences Dialog Box, Registration Tab

- Click **Add New License Key** to add new license keys.
- Click **Remove** to remove selected license keys from the list.

Click **OK** to save changes.



## 9.9.5 Color Management



## Color Management

The **Color Management** preferences are used to determine color management options:

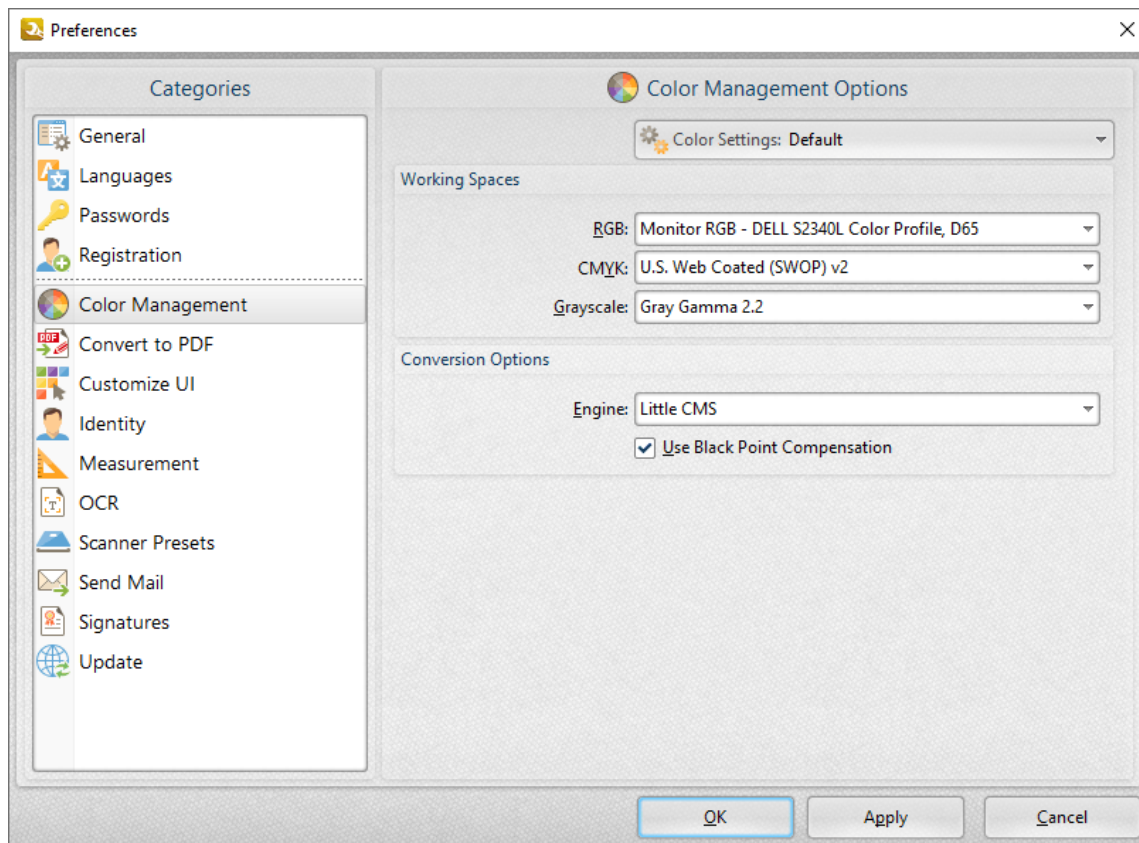

Figure 1. Preferences Dialog Box, Color Management Tab Selected

- The **Color Settings** dropdown menu is used to store and manage customized color profiles. Use this menu to save settings when they have been adjusted using the options detailed below.
- Use the **RGB**, **CMYK** and **Grayscale** dropdown menus to determine the settings for these color modes.
- Use the **Engine** dropdown menu to determine the engine used for color management.

- Select the **Use Black Point Compensation** box to enable black point compensation, which is a technique used in digital photography printing for the creation of adjustments between the maximum black levels of digital files and the black capabilities of digital devices.

Click **OK** to save changes.

---

## 9.9.6 Convert to PDF

**Convert to PDF**

The **Convert to PDF** preferences are used to determine settings when customizable formats are converted to PDF:

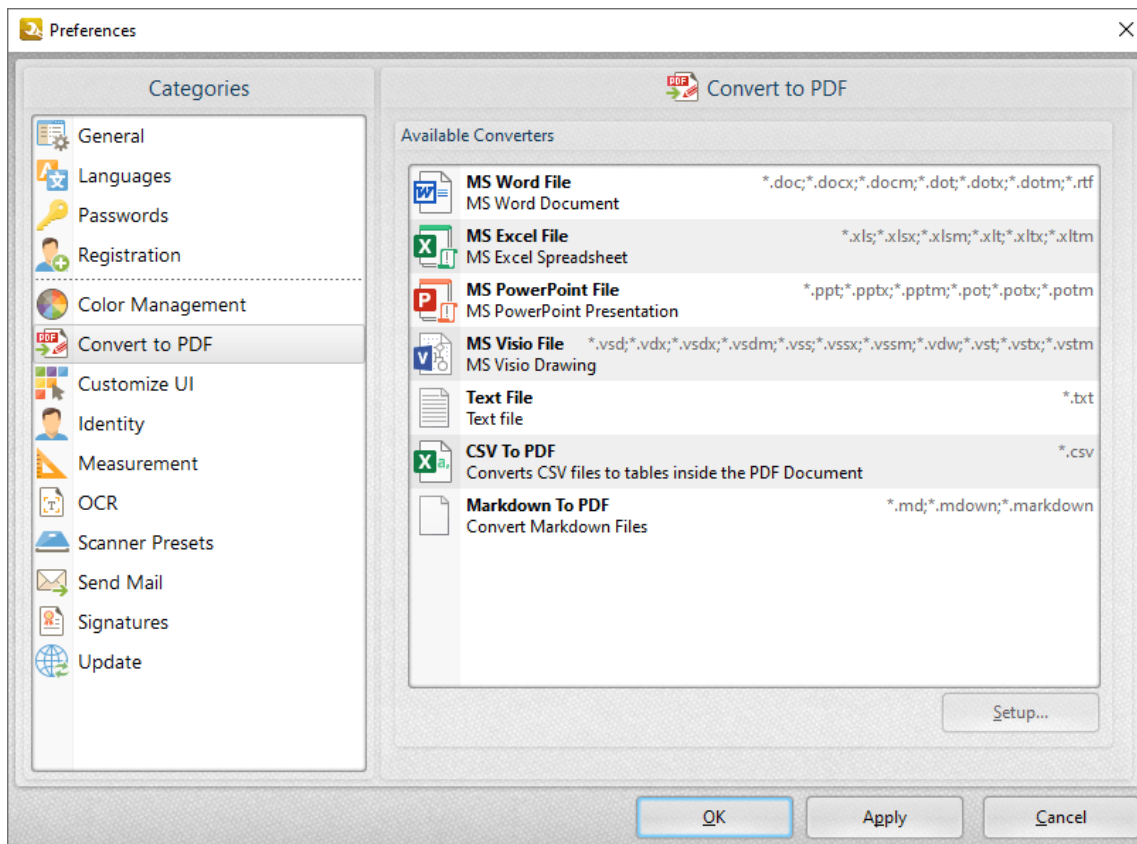

**Figure 1.** Preferences Dialog Box, Convert to PDF Tab

Double-click formats in the **Available Converters** pane to customize settings. Please note that only formats that can be customized are listed. A complete list of file formats that **PDF-Tools** can convert to PDF is detailed [here](#).<sup>[469]</sup>

Click **OK** to save changes.



## 9.9.7 Customize UI



## Customize UI

The **Customize UI** preferences are used to customize the user interface:

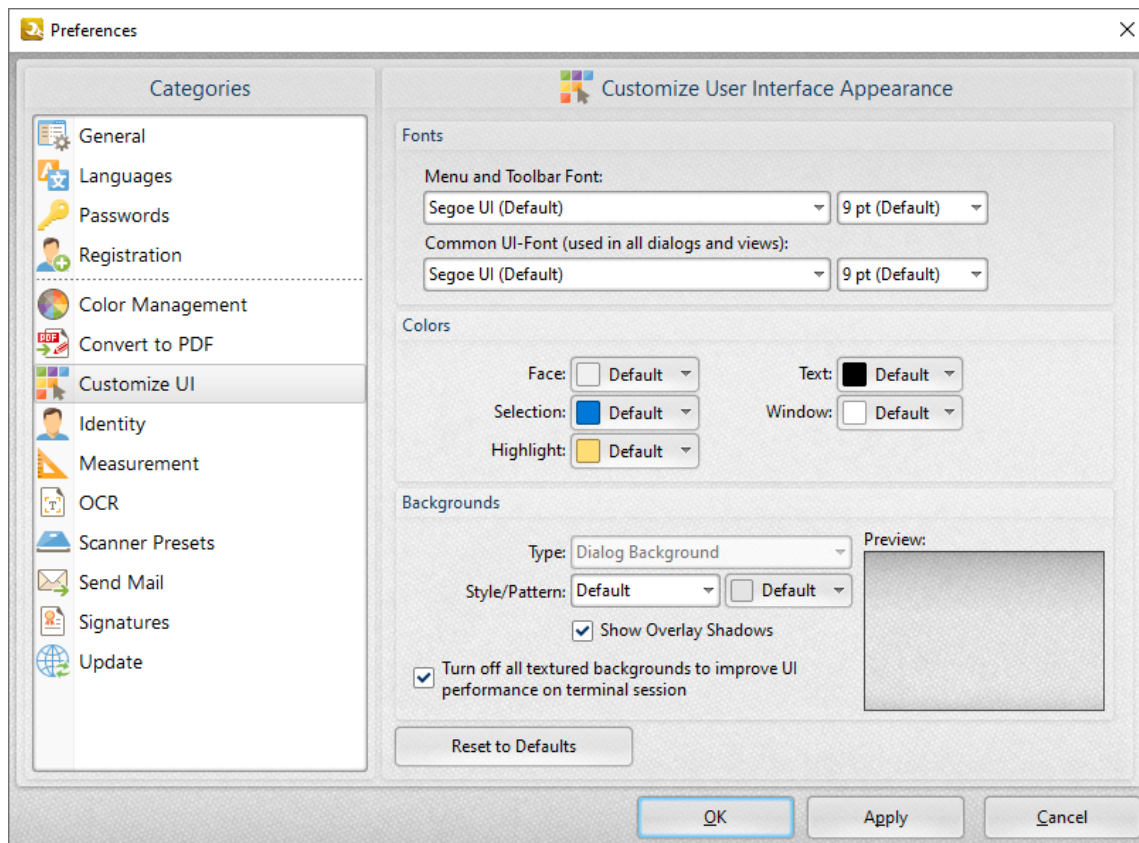

**Figure 1.** Preferences Dialog Box, Customize UI Tab

- Use the menus in the **Fonts** section to determine the font style and size for menus, toolbars and dialog boxes.
- Use the menus in the **Colors** section to determine the colors of the UI.
- Use the menus in the **Backgrounds** section to determine the UI display for backgrounds:
  - Use the **Type** menu to select the background to customize.
  - Use the **Style/Pattern** menus to select the style and color of the selected background.
  - Select the **Show Overlay Shadows** box as desired.



- Select the **Turn off all textured backgrounds to improve UI performance on terminal session** box as desired.
- Click **Reset to Defaults** to reset all UI customization.

Click **OK** to save changes.

---

## 9.9.8 Identity



## Identity

The **Identity** preferences determine the information used in comments, comment reviews and digital signatures:

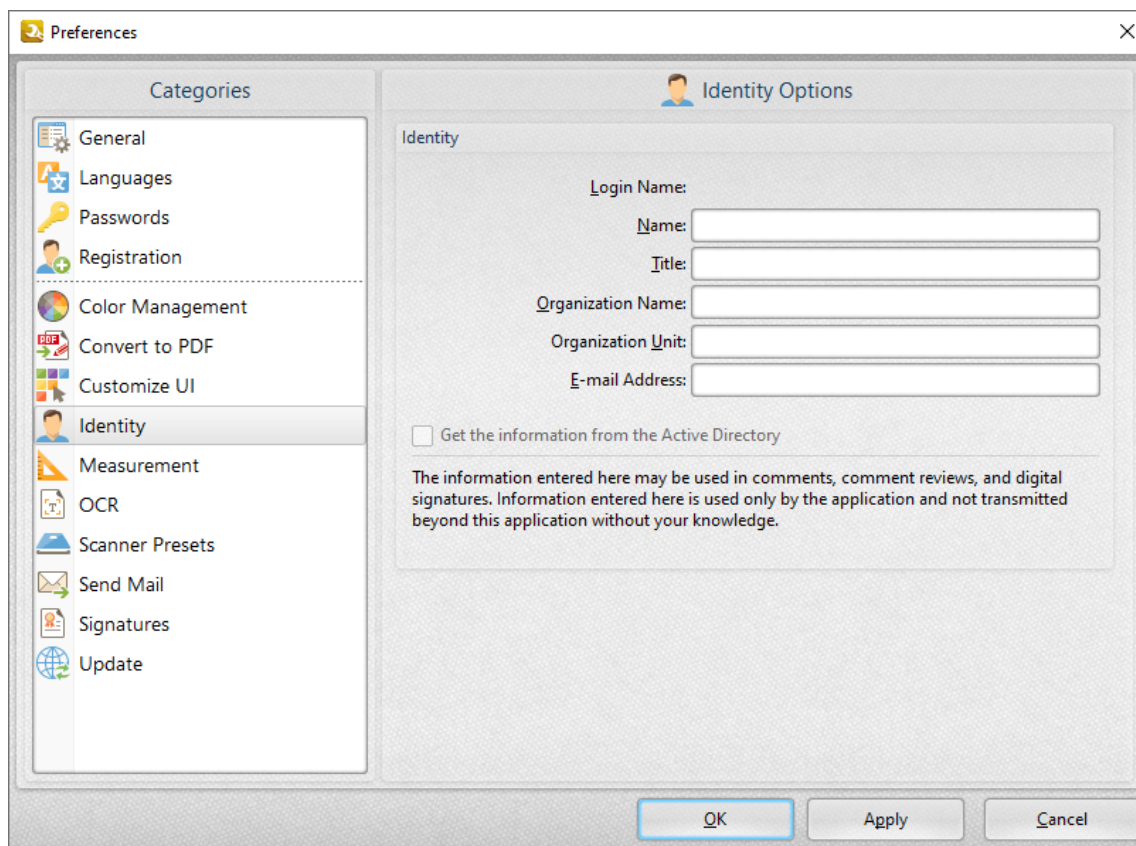

Figure 1. Preferences Dialog Box, Identity Tab

Enter the desired information in the text boxes or select the check box to use the information in your **Active Directory**.

Click **OK** to save changes.

## 9.9.9 Measurement

**Measurement**

The **Measurement** preferences determine the units of measurement used in **PDF-Tools**:

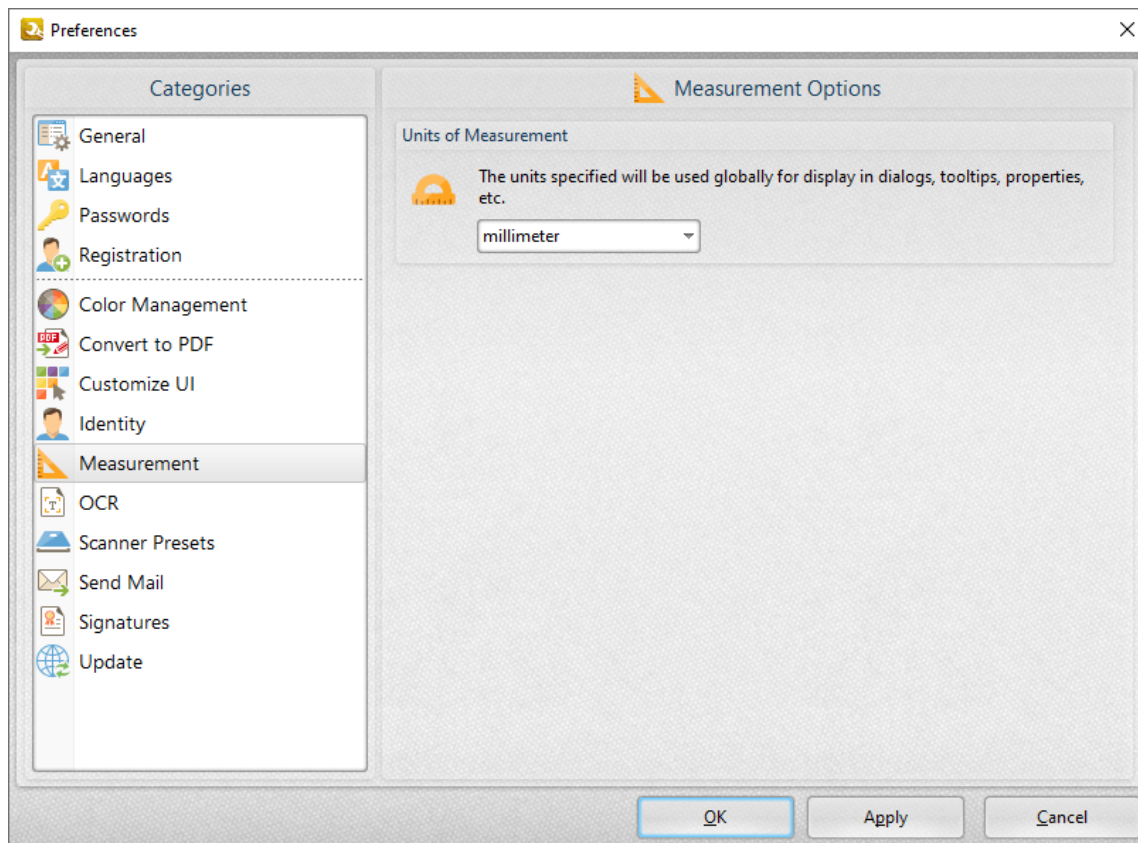

**Figure 1.** Preferences Dialog Box, Measurement Tab

Use the dropdown menu to select a unit of measurement.

Click **OK** to save changes.

## 9.9.10 OCR



The **OCR** preferences determine the optical character recognition engine used in **PDF-Tools**:

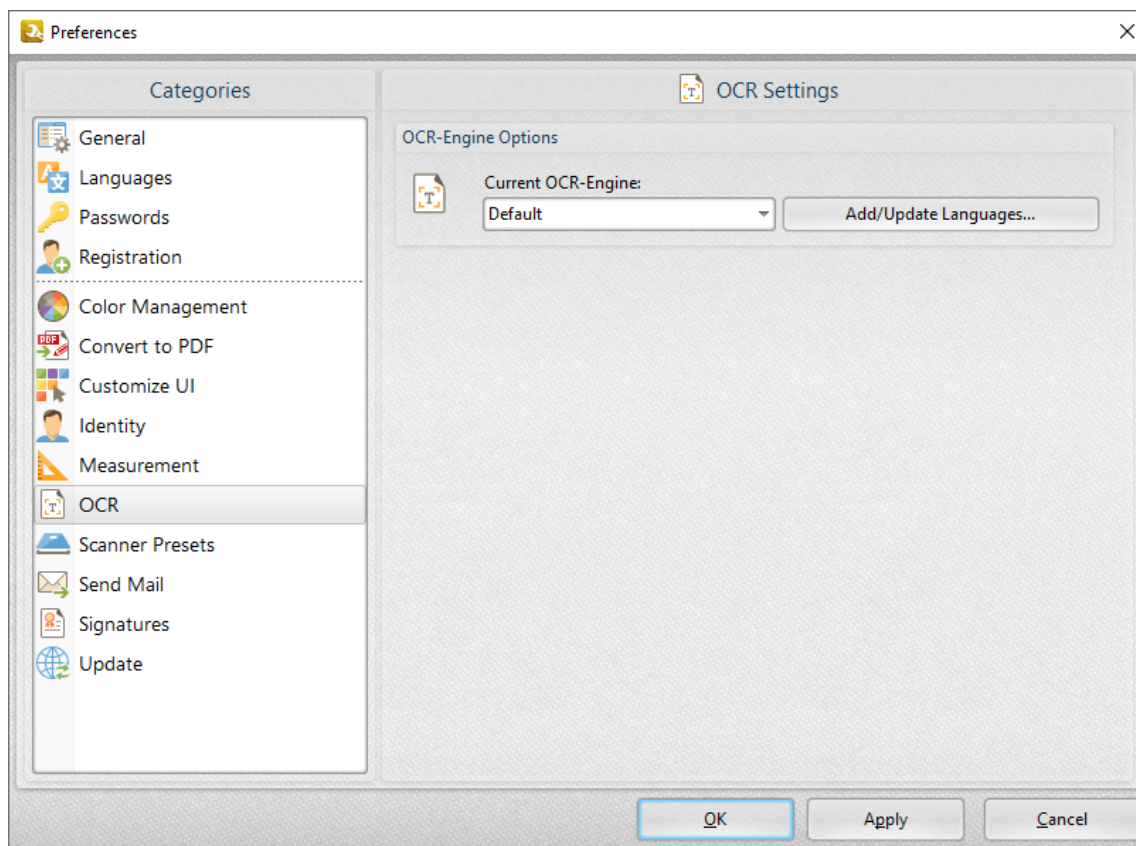

Figure 1. Preferences Dialog Box, OCR Tab

- Use the dropdown menu to switch between the **Default** OCR engine and the **Enhanced** OCR engine. Note that the **Enhanced** OCR engine is an optional extra in **PDF-Tools** that was added in version 8. The **Enhanced** OCR engine is faster, more accurate and more dynamic than the default OCR engine, and it also contains some extra features. Further information about the **Enhanced** OCR engine is available [here](#).

- Click **Add/Update Languages** to add/update languages to be used in the process of optical character recognition.

Click **OK** to save changes.

---

## 9.9.11 Scanner Presets



## Scanner Presets

The **Scanner Presets** preferences determine the presets for tools that use scanners:

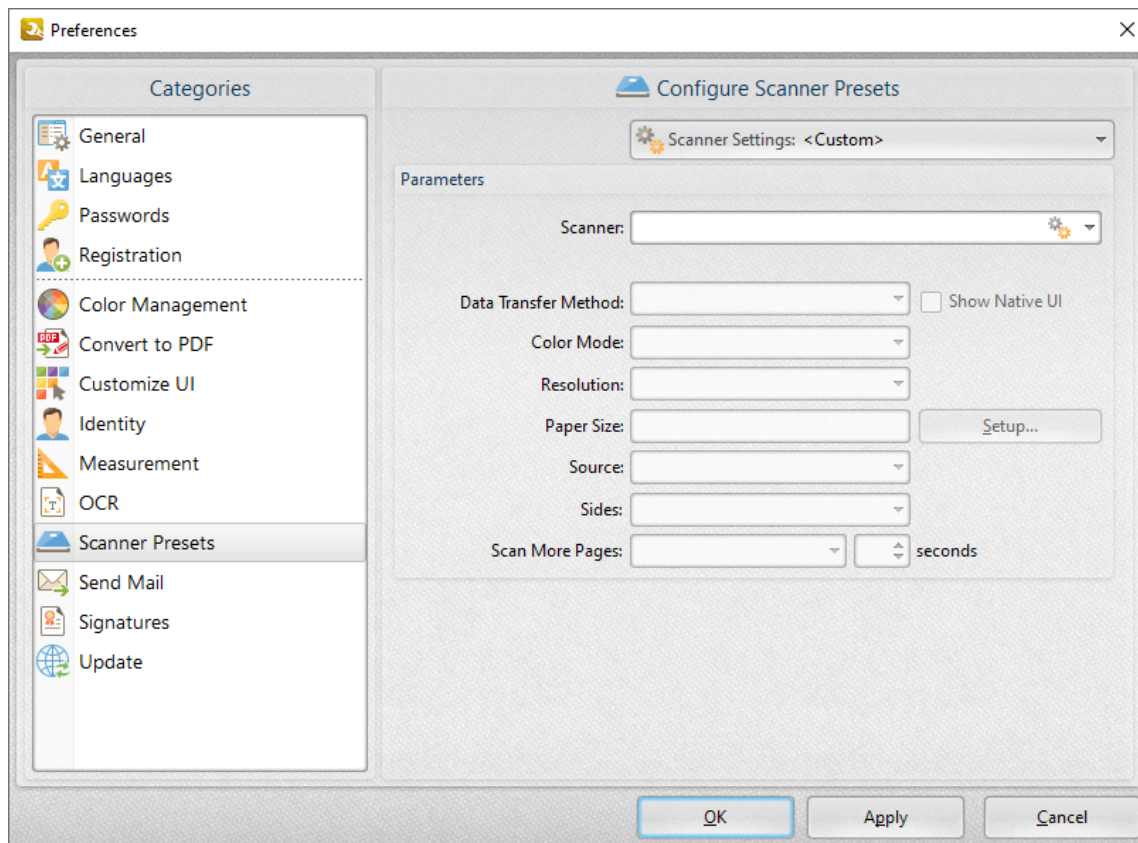

Figure 1. Preferences Dialog Box, Scanner Presets Tab

These options determine scanner presets for tools that use scanners:

- Click the **Scanner Settings** menu to select a preset scanning mode or a saved profile.
- Click the **Scanner** menu to select a scanner to use.
- Click the **Data Transfer Method** menu to select either **Native Mode** or **Memory Mode**:
  - **Native Mode** uses a single memory buffer. This is the default and fastest mode, and is compatible with the broadest range of scanners.

- **Memory Mode** enables the use of multiple memory buffers. This is a useful function in cases where memory is low and/or when large images are being scanned.
- The **Show Native UI** box is selected by default, which means the user interface of the device driver is used. This is the most reliable option, and the scanner will select certain parameters of the scan itself: **Color Mode, Resolution, Paper Size** and **Source**. Clear the **Show Native UI** box to customize these options:
  - **Color Mode** has four options: **Auto detect, Color, Grayscale** and **Black & White**.
  - Click the **Resolution** menu to select the **dpi** (dots per inch) of scanned documents.
  - **Paper Size** refers to the size of the paper used when scanning. Click **Setup** for further options:
    - **Automatic** determines the paper size automatically.
    - **Standard** contains standard sizes such as those used by the **ISO** and **ANSI**.
    - **Custom** can be used to enter custom dimensions.
  - **Source** has three options **Auto, Flatbed and Feeder**. These refer to the type of scanner used for scanning.
- Click the **Sides** menu to determine which sides of documents are scanned. There are three options: **Simple Scan, Manual Duplex** and **Manual Duplex Reversed**. Click the dropdown arrow for an explanation of these options.
- Click the **Scan More Pages** menu to select the setting for when additional pages are scanned.

Click the **Scanner Settings** dropdown menu to save/manage/delete custom profiles:

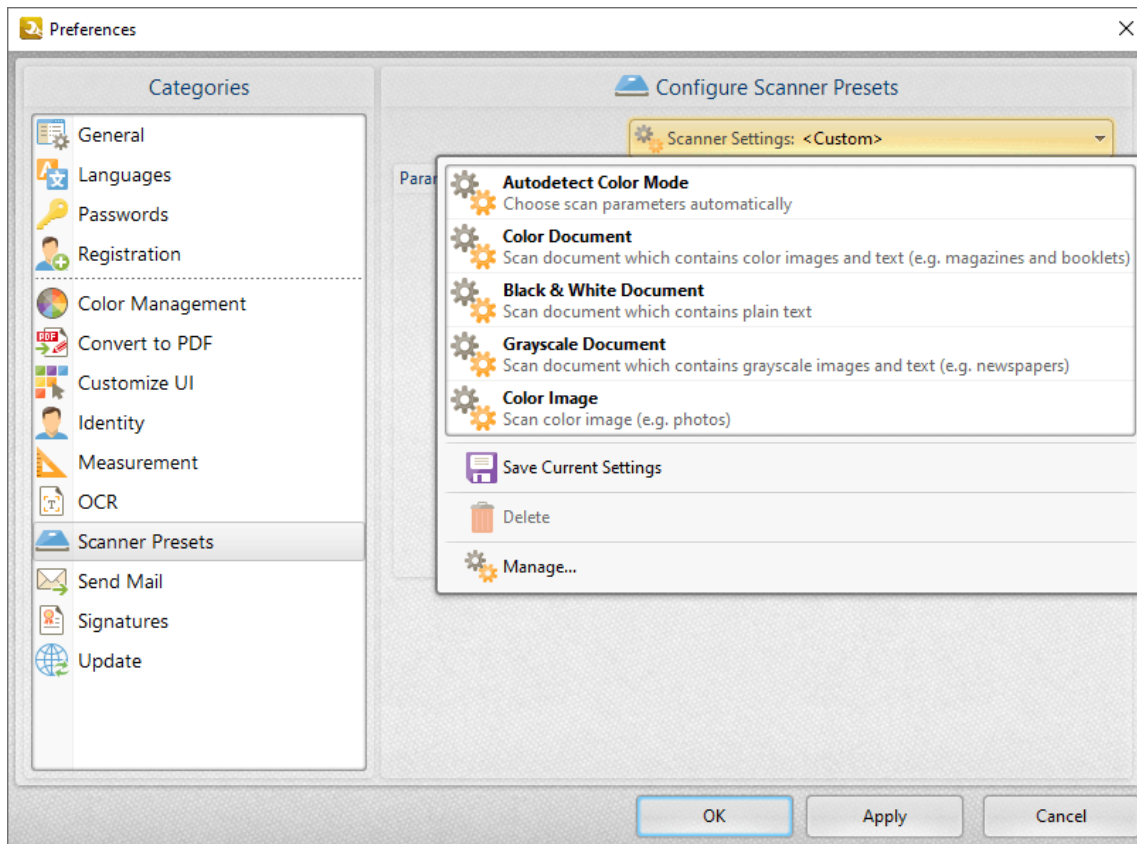

Figure 3. Export to Images Dialog Box, Custom Profiles

- Click **Save Current Settings** to save custom settings for subsequent use. Saved profiles are detailed in the **Scanner Settings** dropdown menu.
- Click **Delete** to delete selected profiles.
- Click **Manage** to manage saved custom settings. The **Manage Presets** dialog box will open, as detailed below.

Click **OK** to save changes.



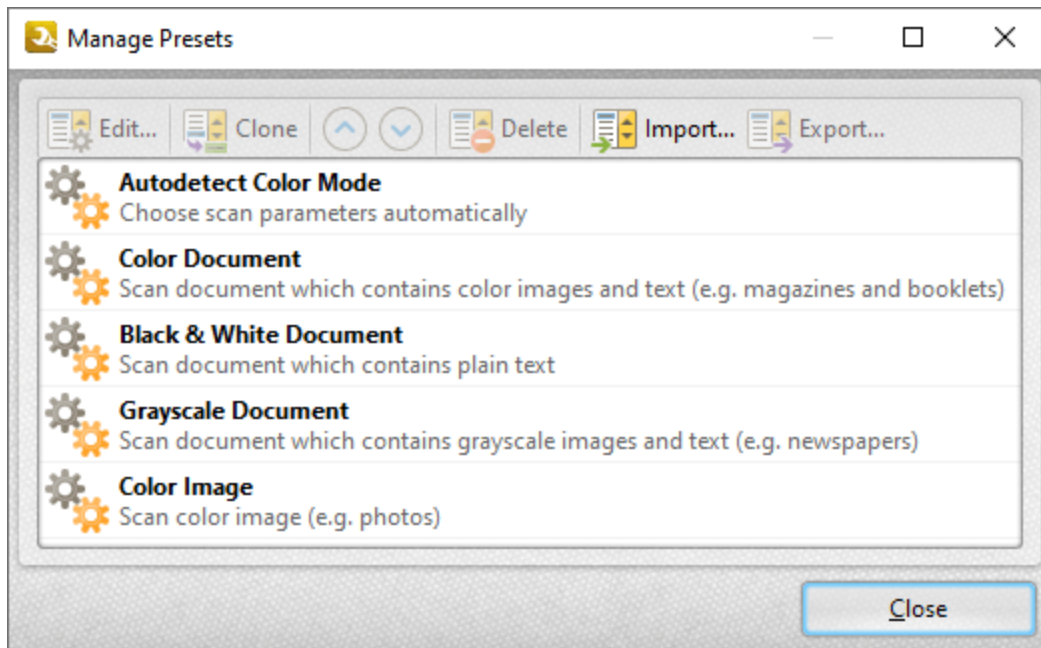

Figure 4. Manage Presets Dialog Box

- Click **Edit** to edit selected profiles.
  - Click **Clone** to clone selected profiles. This makes it possible to duplicate profiles and then customize their settings whilst retaining the existing profile and its parameters.
  - Use the up and down arrow to move selected profiles up or down in the list.
  - Click **Delete** to delete selected profiles.
  - Click **Import** to import profiles from a saved file.
  - Click **Export** to export profiles to file.
-

## 9.9.12 Send Mail

**Send Mail**

The **Send Mail** preferences determine the desktop client used to email documents via the [Send E-mail](#)<sup>466</sup> tool/action in **PDF-Tools**:

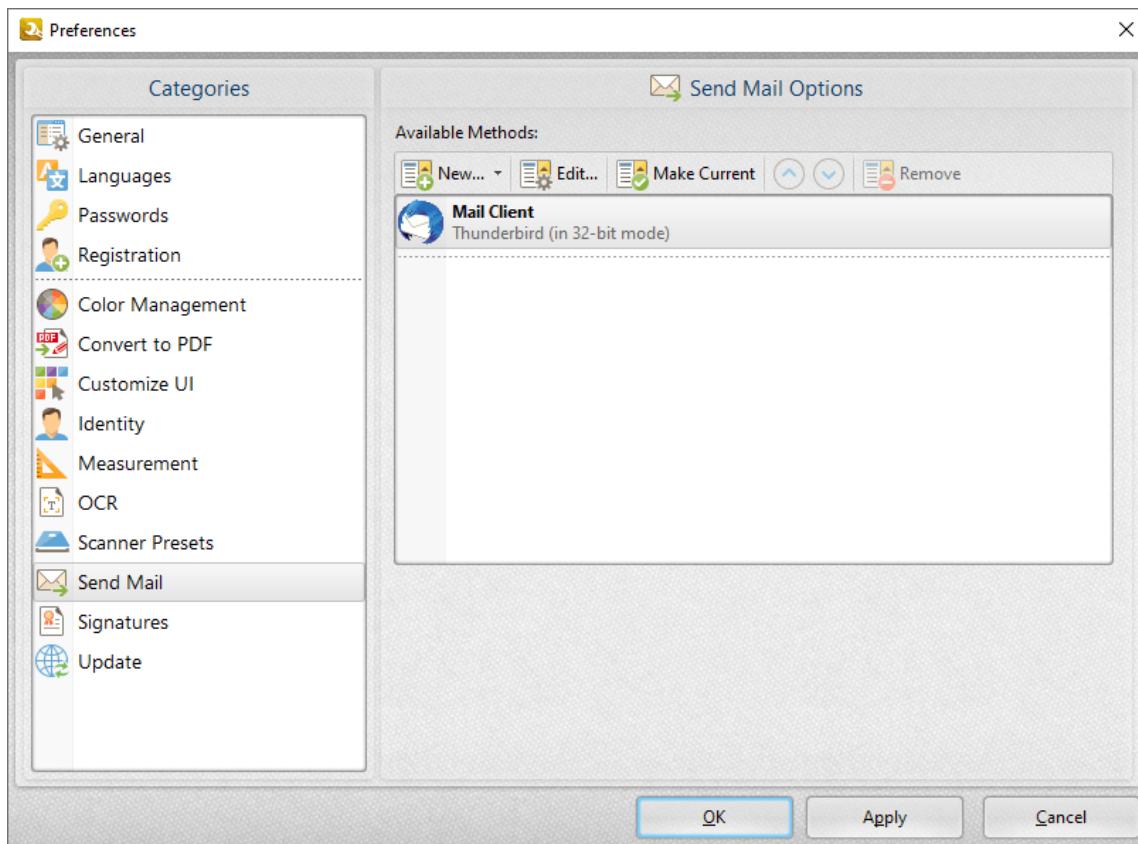

**Figure 1.** Preferences Dialog Box, Send Mail Tab

Existing email methods are displayed in the **Available Methods** pane.

- Click **New** to add new email methods. Select **SMTP**, **Gmail**, **Yahoo**, **Hotmail**, **Outlook** or **Mail.ru** as desired.
- Click **Edit** to edit selected email methods.
- Click **Make Current** to enable the selected email method.

- Click **Remove** to remove the selected email method.

Click **OK** to save changes.

---

## 9.9.13 Signatures



## Signatures

The **Signatures** preferences determine settings for the creation, appearance and verification of digital signatures in **PDF-Tools**:

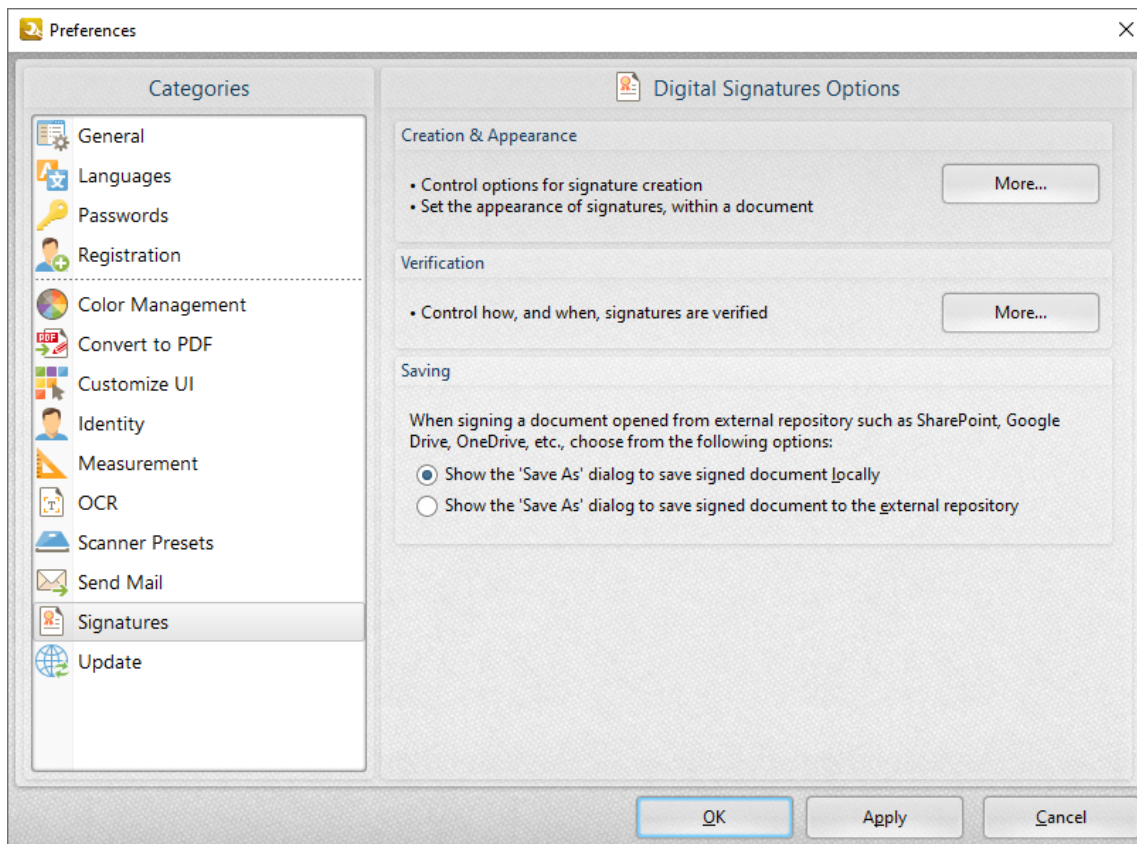

Figure 1. Preferences Dialog Box, Signatures Tab

These options determine the settings for digital signatures:

- The **Creation & Appearance** settings determine the options detailed in **(figure 2)** below. Click **More** to access these settings.
- The **Verification** settings determine how and when signatures are verified. Click **More** to access these settings, then select the check boxes as desired.

- Select either of the radio buttons in the **Saving** section to determine how documents opened from external repositories are saved.

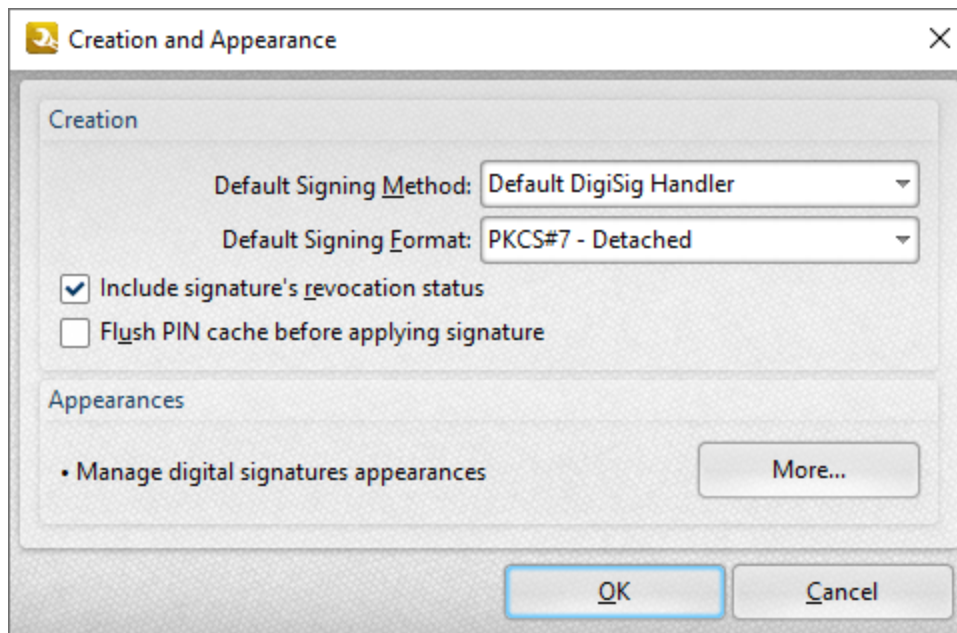

Figure 2. Creation and Appearance Dialog Box

The **Creation** settings are as follows:

- Select an option from the **Default Signing Method** menu to determine the default signing method settings.
- Select an option from the **Default Signing Format** menu to determine the signing format.
  - **PKCS#7 - Detached** encodes certificates in **Abstract Syntax Notation One (ASN.1)** format.
  - **CADES** is an electronic signature created in compliance with **eIDAS** and has the same legal value as a handwritten signature.
- Select the **Include signature's revocation status** box as desired. The revocation status of the signature will be shown in the main window when this option is enabled.
- Select the **Flush PIN cache before applying signature** box as desired.
- Click the **More** button to set the **Digital Sign Appearance Templates**:

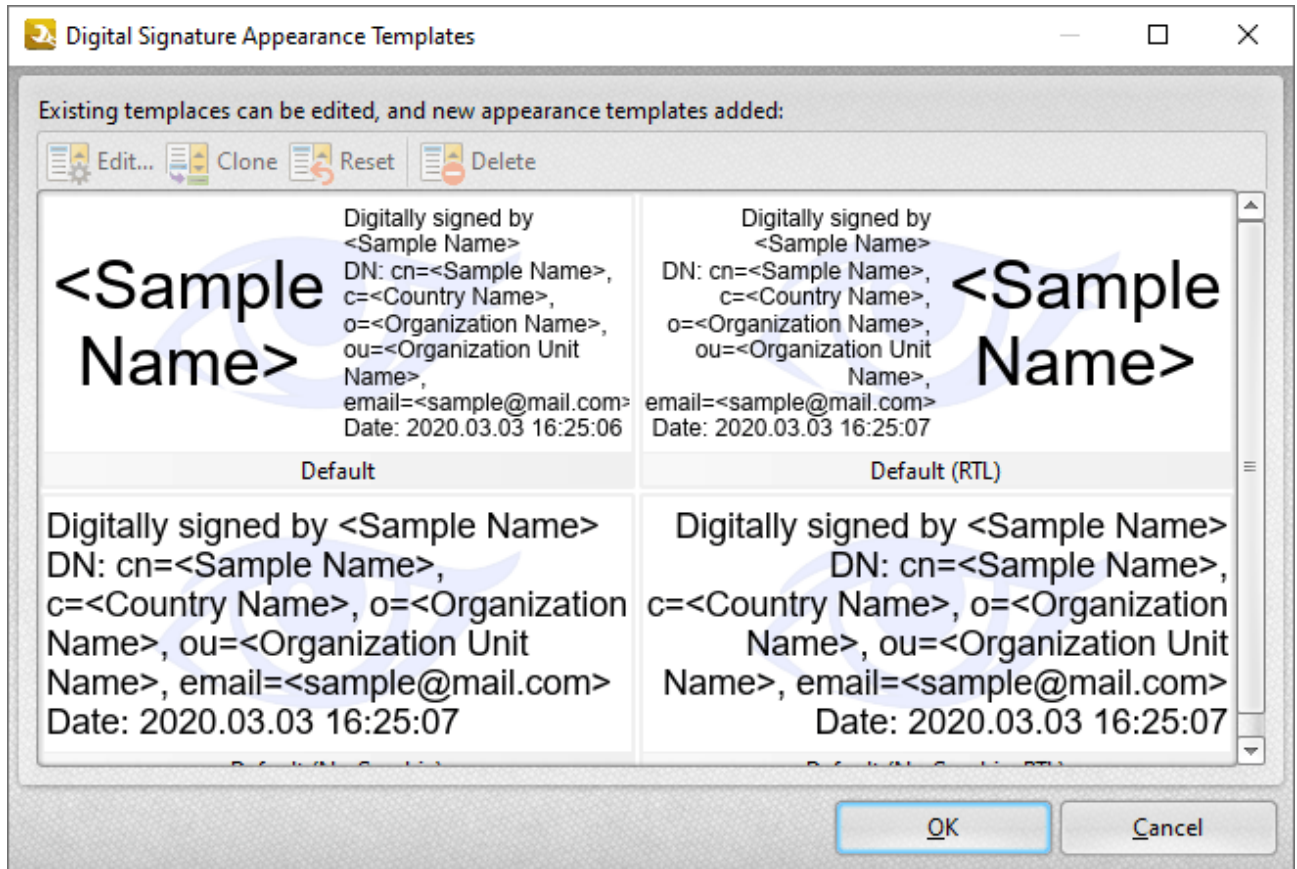

Figure 3. Digital Signature Appearance Templates Dialog Box

- Select signature templates, then select **Clone/Reset/Edit** as desired:
- Click **Clone** to clone the selected signature template. This is a useful feature if parameters of existing signature templates need to be changed and saved without editing the original template.
- Click **Reset** to revert the values of the the selected signature template to its default state.
- Click **Edit** to adjust the values of the selected signature template:

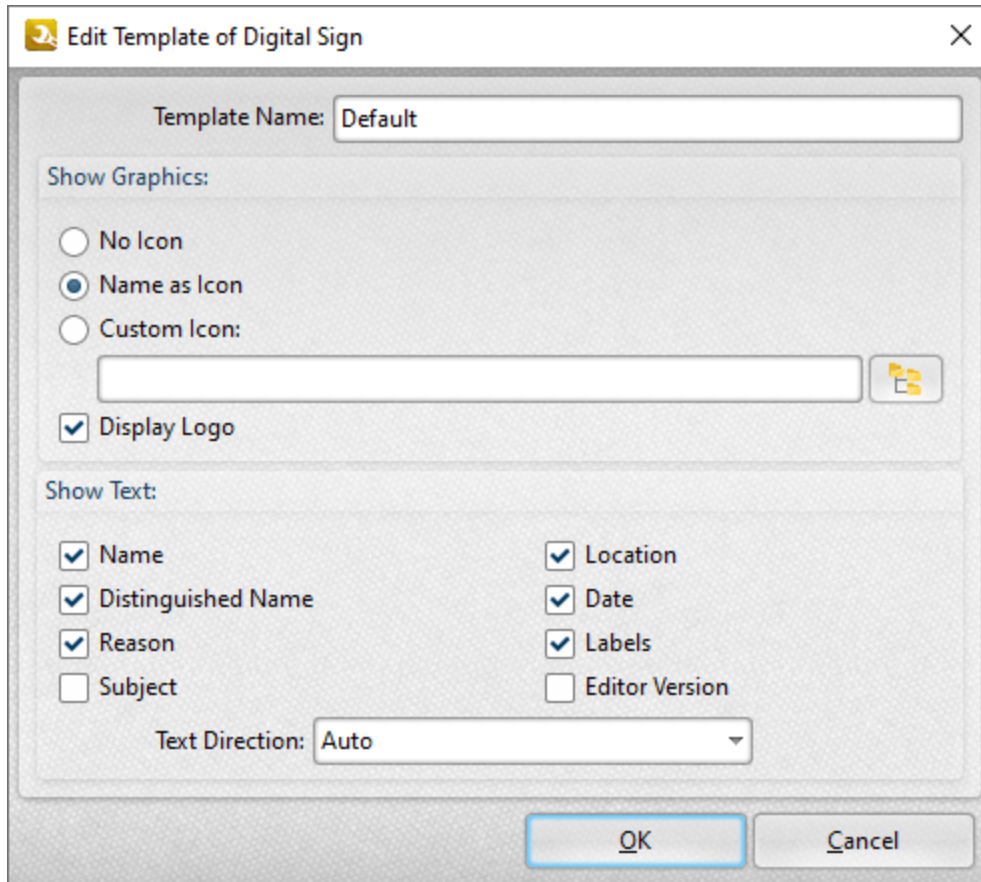

Figure 4. Edit Template of Digital Sign Dialog Box

- Use the **Template Name** text box to edit the name of the signature template.
- Use the **Show Graphics** option buttons to determine the graphics displayed with the template:
  - Select **Name as Icon** to use the name of the current user as the icon.
  - Select **Custom Icon** to use a custom icon. Enter the name of the file to be used in the text box, or click the icon to select a file from the local computer.
- Select the **Display Logo** box to display the logo in the background of signature templates.
- Select the boxes in the **Show Text** section to determine the information that is shown with templates.
- Use the **Text Direction** dropdown menu to determine the text direction.

Click **OK** to save changes.

---

## 9.9.14 Update



The **Update** option is used to check for updates to **PDF-XChange** applications:

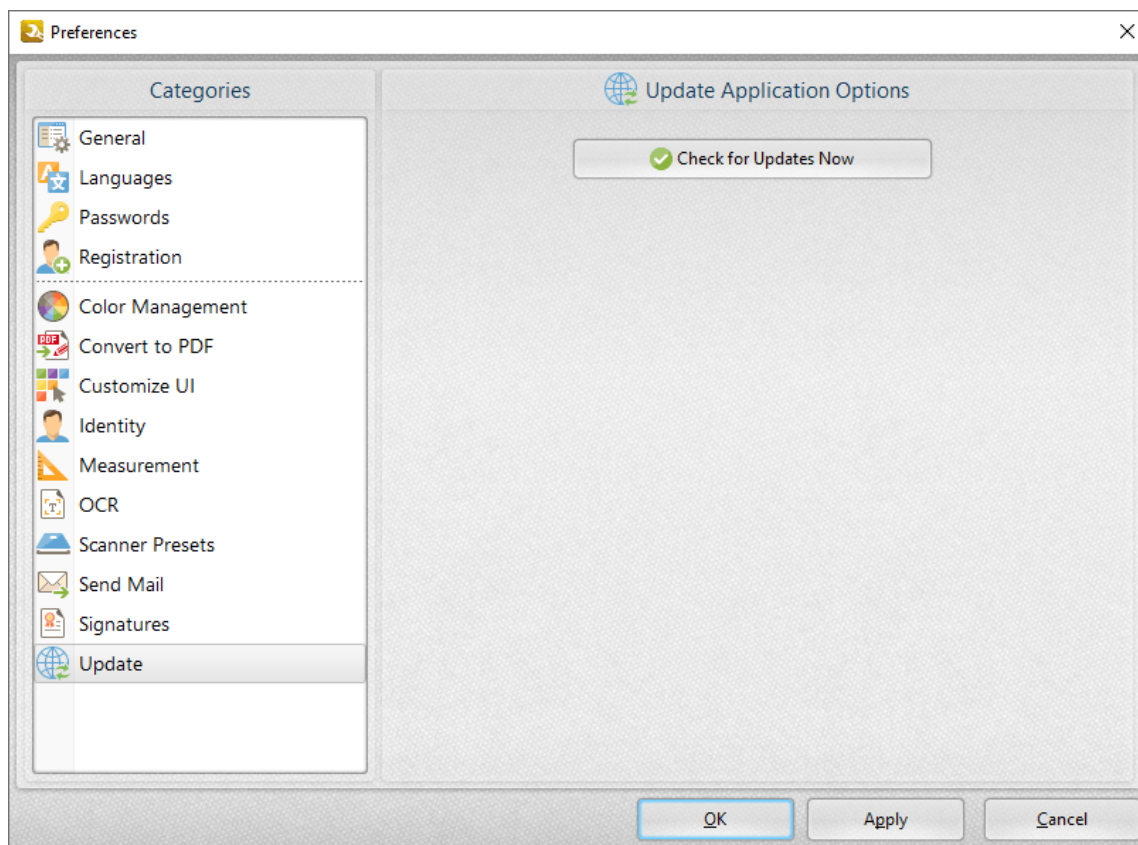

**Figure 1.** Preferences Dialog Box, Update Option

Click the **Check for Updates Now** button to check for updates to **PDF-Tools**.



## 9.10 Folder Monitors



### Folder Monitors

The **Folder Monitors** feature of **PDF-Tools** is used to watch user-specified folders and automatically perform tool operations when new files are moved into them or when files that they contain are edited. Note that **PDF-Tools** must be running in order for folder monitors to operate. Click **Folder Monitors** to create/edit/delete folder monitors:

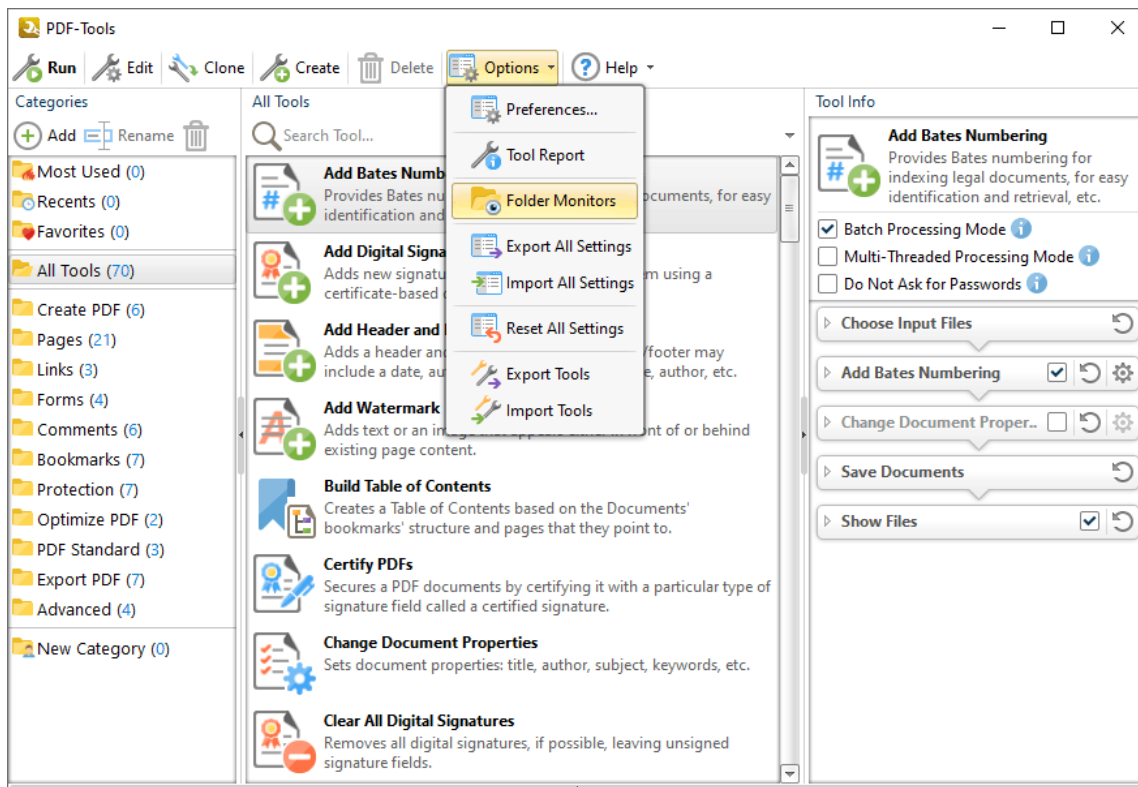

Figure 1. PDF-Tools Main Window, Options Tab, Folder Monitors

The **Folder Monitors** dialog box will open:

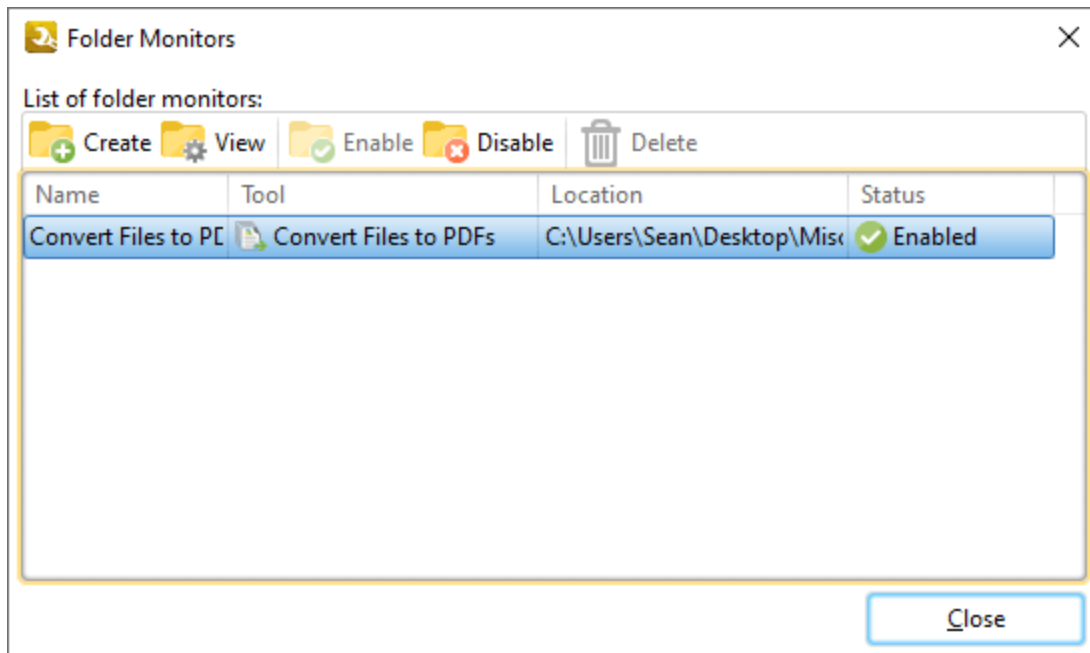

Figure 2. Folder Monitors Dialog Box

- Click **Create** to create a new folder monitor. The **Setup Folder Monitor** dialog box will open, as detailed below.
- Click **Edit** to edit selected folder monitors. Note that monitors must be disabled before they can be edited.
- Click **Enable/Disable/Delete** to enable/disable/delete selected folder monitors.
- Right-click the dialog box for additional options:
  - Click **Copy Monitor Identifier** to copy the identifier of the folder monitor to the clipboard. Identifiers can be used in conjunction with the folder monitor command line detailed [here](#).<sup>[472]</sup>
  - Click **Create Shortcut on Desktop** to create a desktop shortcut to the folder monitor.

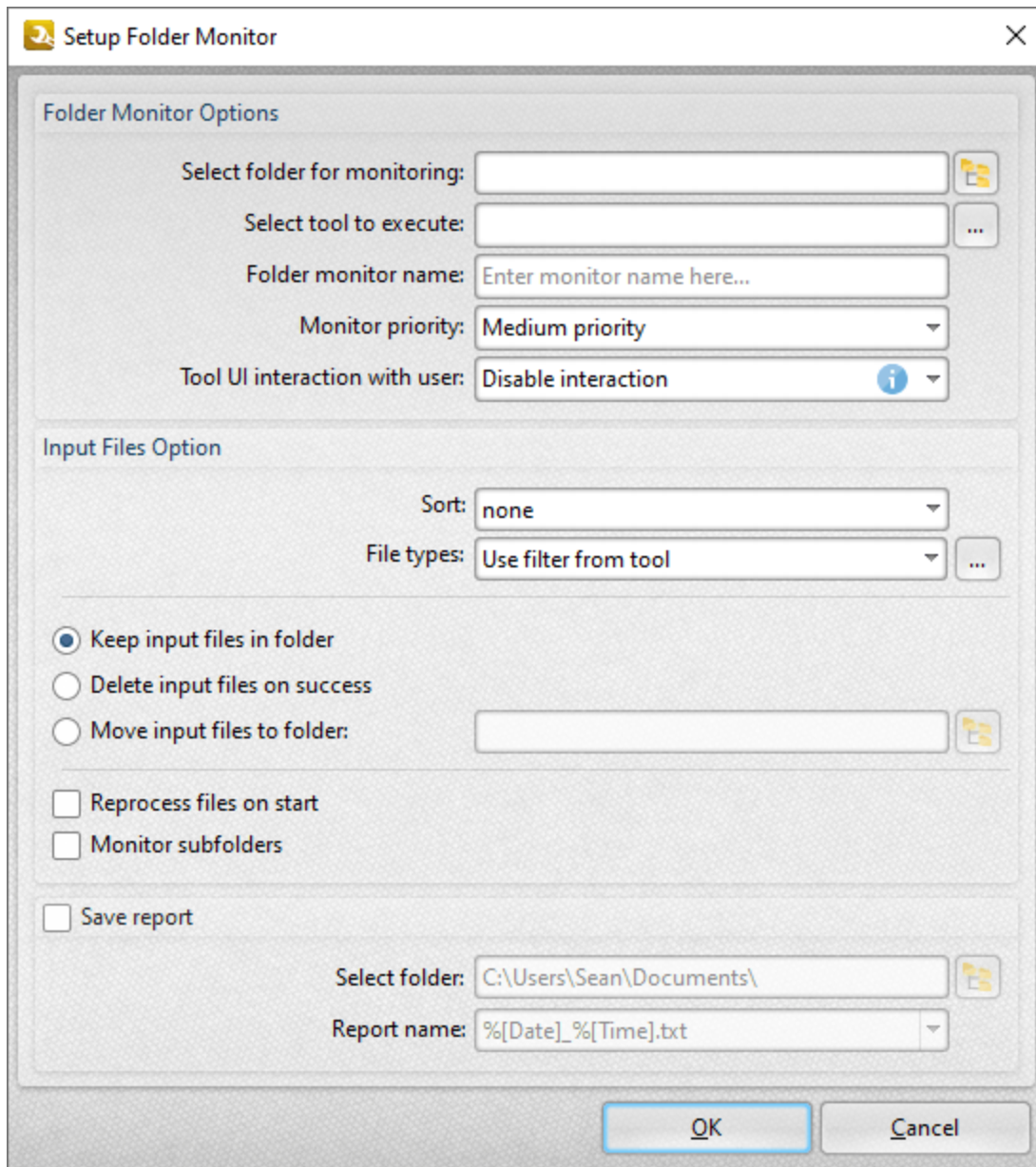

Figure 3. Setup Folder Monitor Dialog Box

- Enter the name of the folder to be monitored in the **Select folder for monitoring** text box, or click the icon to select a file manually.
- Enter the name of the tool to be executed in the **Select tool to execute** text box, or click the ellipsis icon to select a tool manually.
- Enter a name for the folder monitor in the **Folder Monitor Name** text box.
- Use the **Monitor Priority** dropdown menu to determine the priority of the folder monitor. If the priority is set to **High** then the process will be faster but will also use more memory, and vice versa.
- Use the **Tool UI interaction with user** dropdown menu to determine tool interaction when new files are copied into monitored folders:

- Select **Disable interaction** to disable the launching of the tool UI. Note that some tools, such as the **Secure Document** tool, require some settings to be determined before they can run. The setup UI will be displayed the first time that these tools run and subsequently disabled from opening.
- Select **Use tool settings** to launch the tool UI and customize settings each time a new file is copied into the monitored folder.
- Use the **Input Files Options** to determine options for input files:
  - Select an option in the **Sort** dropdown menu to determine how input files are sorted.
  - Select an option in the **File types** dropdown menu to determine permitted file formats for the tool associated with the monitored folder, or click the ellipsis icon to determine permitted file formats manually.
  - Select an option to determine the action taken for input files after the tool runs:
    - Select **Keep input files in folder** to retain the input files in the monitored folder.
    - Select **Delete input files on success** to delete input files.
    - Select **Move input files to folder** to move input files to a different folder, then enter the name of the folder in the text box, or click the icon to select a folder manually.
    - Select **Reprocess files on start** to reprocess files when the folder monitor is enabled.
    - Select **Monitor subfolders** to include subfolders of monitored folders.
  - Select the **Save report** box to save the tool output report, then use the **Select Folder** and **Report name** options to specify the destination folder and the filename of the report.

Click **OK** to save changes.

Note that it is necessary to re-enable folder monitors after a system restart. If you want to ensure that folder monitors are always running, then follow the steps below:

1. Click the **Options** tab in the **PDF-Tools** UI, then click **Folder Monitors**. The **Folder Monitors** dialog box will open.
2. Right-click the desired folder monitor and then click **Create Shortcut on Desktop**:

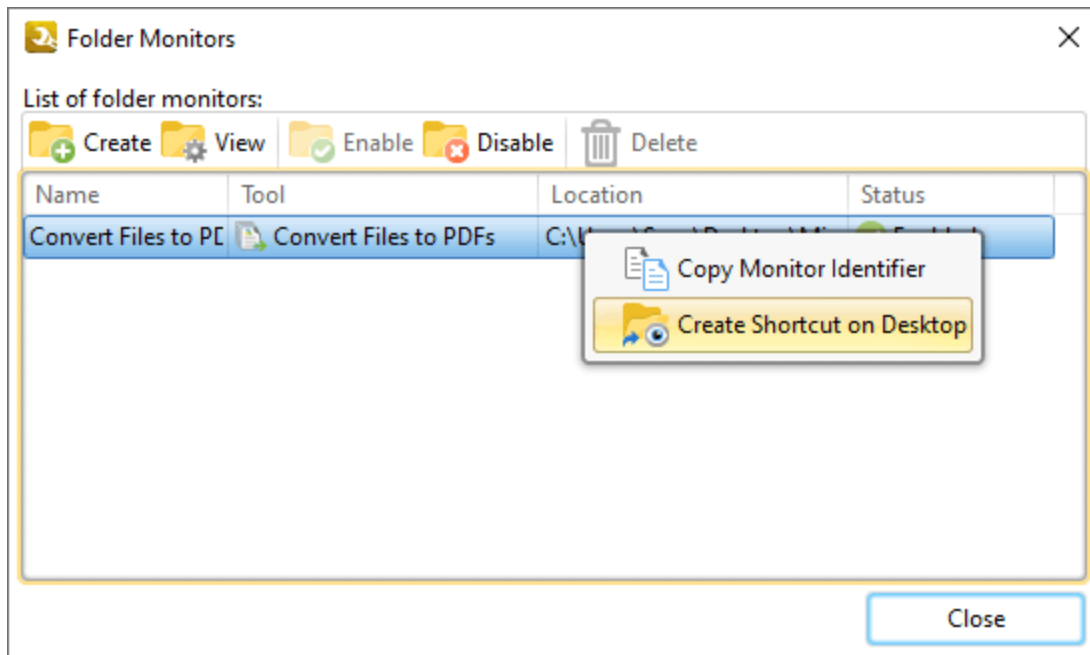

Figure 4. Folder Monitors Dialog Box, Right-Click Shortcut Menu

A shortcut to the folder monitor will then be created and an icon will appear on your desktop.

3. Open your **Windows Startup Folder**, which is located by default at:

```
%appdata%\Microsoft\Windows\Start Menu\Programs\Startup
```

4. Click and drag the shortcut from your desktop into your **Windows Startup Folder**.

The folder monitor will then be enabled each time you log in to your **Windows** account.

---

## 10 PDF-XChange Editor V8 User Manual

---



### PDF-XChange Editor V8 User Manual

---

Welcome to **PDF-XChange Editor V8** - one of the fastest and most feature-rich options available worldwide to create, view, edit and annotate PDF files. Please note that this manual details **PDF-XChange Editor** when it is viewed in the **Ribbon UI**, which was introduced in version seven. The **Classic UI** version of the manual is available [here](#).

This manual is composed of the following sections:

- **Features Overview** details the main features of **PDF-XChange Editor**.
- **Explore the User Interface** details the software as it appears via the ribbon user interface.
- **Operations Guide** details the operations that **PDF-XChange Editor** performs, and is composed of the following subsections:
  - The **Annotations Guide** details all operations that relate to annotations, such as how to add annotations and comments to documents, attach files and set comment styles.
  - The **Bookmarks Guide** details all operations that relate to the creation and manipulation of document bookmarks.
  - The **Document Operations Guide** details all operations that relate to the creation and manipulation of PDF documents.
  - The **Editing Panes Guide** details all operations that relate to the usage of the nine editing panes featured in **PDF-XChange Editor**.
  - The **Forms Guide** details all operations that relate to the creation and manipulation of fillable forms in PDF documents.
  - The **Workspace Guide** details all operations that relate to the customization and navigation of the **PDF-XChange Editor** workspace.
- The **Tabs Guide** is structured to match the UI of the software and details comprehensive operational instructions for its features and functionality. The ribbon tabs each have a corresponding section in the manual, where their submenu options and associated settings are explained. The ribbon tabs are highlighted in the image below.
- **Appendix** details additional information that relates to the software.

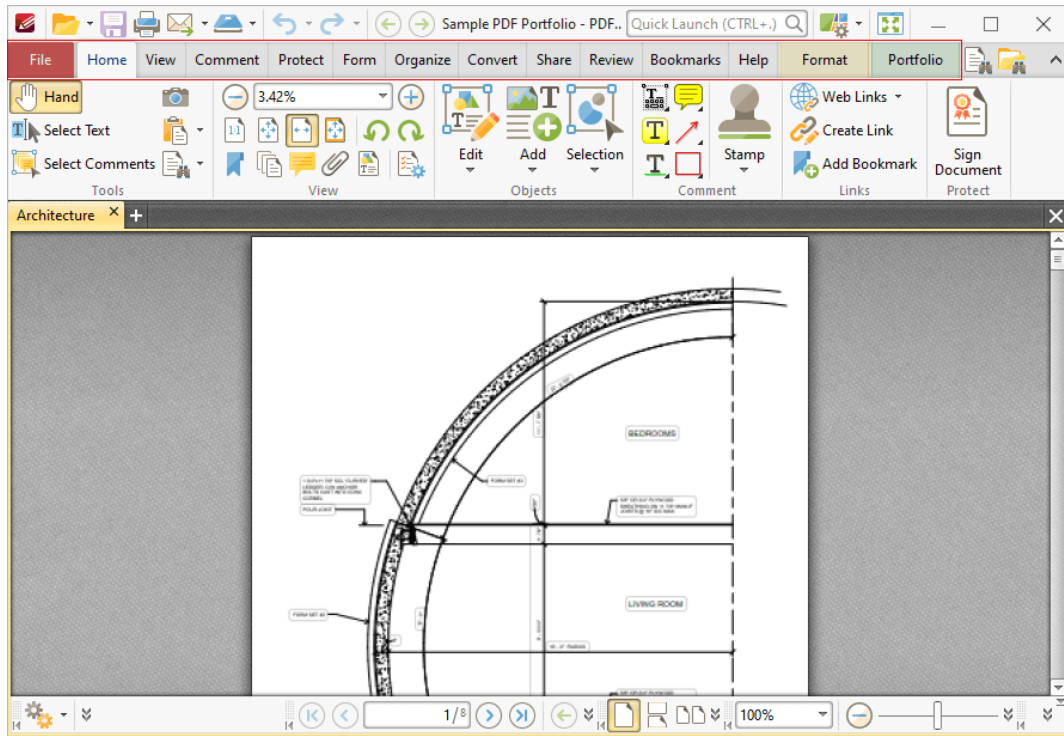

Figure 1. Ribbon Tabs

Note that the icons in the upper left of the screen can be used to browse/search the manual:



Click the **Table of Contents** to view/move to chapters of the manual.



Click the **Keyword Index** to view keywords, and click keywords to move to their location in the manual.



Click **Search Topics** to enter custom search terms.





## 10.1 Features Overview

---



### Features Overview

---

The main features of **PDF-XChange Editor** are detailed below:

#### Create and Manipulate Documents

- Create PDF documents from image files, markdown files, text files, RTF files or the local scanner. See [here](#)<sup>[633]</sup> for further information.
- Print documents. See [here](#)<sup>[833]</sup> for further information.
- Email documents. See [here](#)<sup>[919]</sup> for further information.
- Combine multiple input documents into a single file. See [here](#)<sup>[799]</sup> for further information.
- Convert documents to/from PDF and a range of other formats.
- Secure documents. See [here](#)<sup>[845]</sup> for further information.
- Use **Digital Signatures** to sign documents and demonstrate authenticity. See [here](#)<sup>[1248]</sup> for further information.
- Integrate **Sharepoint, Dropbox, Google Drive** and **MSOffice 365**. See [here](#)<sup>[782]</sup> for further information.
- Use the OCR engine to avail of advanced optical character recognition. See [here](#)<sup>[1519]</sup> for further information.

#### Edit Documents

- Add [Watermarks](#)<sup>[1491]</sup>, [Barcodes](#)<sup>[1656]</sup>, [Images](#)<sup>[1653]</sup> and [Backgrounds](#)<sup>[1494]</sup> to documents.
- Edit document pages, with options to [Number](#)<sup>[1504]</sup>, [Rotate](#)<sup>[1482]</sup>, [Split](#)<sup>[1473]</sup>, [Resize](#)<sup>[1486]</sup>, [Replace](#)<sup>[1470]</sup>, [Delete](#)<sup>[1459]</sup>, [Export](#)<sup>[838]</sup>, [Insert](#)<sup>[1451]</sup>, [Extract](#)<sup>[1462]</sup> and [Crop](#)<sup>[1484]</sup> pages.
- Use editing aids to assist in document editing:
  - [Rulers, Grids and Guides](#)<sup>[1075]</sup> enable precise placement/measurement of document content.
  - [Snapping](#)<sup>[898]</sup> ensures that content is aligned flawlessly.
- Use [Macros](#)<sup>[1707]</sup> to determine complicated components of the output process in simple terms.
- Use the [Preferences](#)<sup>[854]</sup> options to customize the workspace and application settings.
- Use the [JavaScript Console](#)<sup>[1429]</sup> to add JavaScript to documents.
- Use the [Launch Applications](#)<sup>[895]</sup> toolbar to open third party software from **PDF-XChange Editor**.

- Customize toolbars in order to group specified functions and save space on the user interface. See [here](#) <sup>[1599]</sup> for further information.
- Use the [Form](#) <sup>[1265]</sup> tab to create and edit fillable forms.
- View/edit/create PDF portfolio files, as detailed [here](#). <sup>[1630]</sup>

## Utilize Tools and Features to Enhance Documents

- The [File Attachment](#) <sup>[1110]</sup> and [Sound Tool](#) <sup>[1115]</sup> add links to external files and sound effects to documents.
- The [Highlight](#) <sup>[1120]</sup>, [Strikeout](#) <sup>[1130]</sup> and [Underline Text](#) <sup>[1125]</sup> tools can be used to edit and enhance document text.
- The [Link Tool](#) <sup>[956]</sup> creates links to external sources.
- The [Loupe Tool](#) <sup>[1068]</sup> and [Pan and Zoom](#) <sup>[1070]</sup> pane provide dynamic methods to view and edit documents at increased/decreased levels of zoom.
- The [Measuring Tools](#) <sup>[1206]</sup> can be used to measure the distance between document locations and the perimeter/area of customized shapes. The [Calibrate Measurement](#) <sup>[1224]</sup> feature can be used to create scales for these tools.
- The [Read Out Loud Feature](#) <sup>[1774]</sup> can be used to read selected text out loud.
- The [Shape Tools](#) <sup>[1082]</sup> can be used to add adjustable shape annotations to documents. Multiple default shapes are available, such as circles and rectangles, as well as the option to add freehand annotations.
- The [Snapshot Tool](#) <sup>[926]</sup> takes screenshots of pages/selected page content and pastes a bitmap copy to the clipboard.
- The [Stamp Tool](#) <sup>[1188]</sup> can be used to add standard stamps to documents or create custom stamps from input material.
- There are four ways to add comments to documents:
  - The [Sticky Note Tool](#) <sup>[1105]</sup> adds sticky-note annotations to documents.
  - The [Typewriter Tool](#) <sup>[1089]</sup> adds typewriter-style comments to documents.
  - The [Text Box Tool](#) <sup>[1094]</sup> adds comments contained in text boxes to documents.
  - The [Callout Tool](#) <sup>[1099]</sup> is similar to the **Text Box Tool**, but has the additional option to add an adjustable arm to the comment in order to highlight specific document locations.
- The [Select Comments Tool](#) <sup>[1087]</sup> provides an efficient way to edit multiple comments simultaneously.
- The [Edit Content Tool](#) <sup>[1638]</sup> is used to edit existing document content.
- The [Redaction](#) <sup>[1257]</sup> feature is used to redact documents and permanently delete document content.
- The [Spell Check](#) <sup>[1545]</sup> feature is used to check document spelling.
- The [Comment Styles Palette](#) <sup>[1242]</sup> can be used to save customized comment and annotation styles for subsequent use.

## Use Editing Panes to Assist in Document Editing

- The [Comments](#) <sup>[1007]</sup> pane is used to view/edit comments, annotations and markups.

- The [Attachments](#) <sup>1014</sup> pane is used to view/edit attachments.
- The [Fields](#) <sup>1016</sup> pane is used to view/edit form fields such as radio buttons and dropdown menus.
- The [Signatures](#) <sup>1021</sup> pane is used to view/edit digital signatures.
- The [Layers](#) <sup>1024</sup> pane is used to view/edit document layers, such as those used by **InDesign**, **AutoCAD** and **Visio**.
- The [Content](#) <sup>1032</sup> pane is used to view/edit base content.
- The [Destinations](#) <sup>1036</sup> pane is used to view/edit named destinations.
- The [3D Model Tree](#) <sup>1039</sup> pane is used to view/edit the hierarchy of selected 3D content in documents.
- The [Links](#) <sup>1043</sup> pane is used to view/edit the links in documents.
- The [Pan and Zoom](#) <sup>1047</sup> pane is used to assist in document editing.
- The [Stamps Palette](#) <sup>1050</sup> pane is used to view/edit stamps.
- The [Comment Styles Palette](#) <sup>1242</sup> is used to view/edit comment styles.
- The [Spell Check](#) <sup>1057</sup> pane is used to check document spelling.
- The [Document Recovery](#) <sup>1059</sup> pane is used to view/edit information recovered through the autosave/autorecovery features.
- The [History](#) <sup>1061</sup> pane is used to view the history of documents opened in **PDF-XChange Editor** and can be used to browse/open those documents.
- The [Properties](#) <sup>1065</sup> pane is used to view/edit the properties of selected document content.

Additionally, see the [Operations Guide](#) <sup>603</sup> for step-by-step instructions on all available operations in **PDF-XChange Editor**.

The **User Interface** is detailed [here](#). <sup>596</sup>

---

## 10.2 Explore the User Interface



### Explore the User Interface

The **PDF-XChange Editor** user interface appears as below:

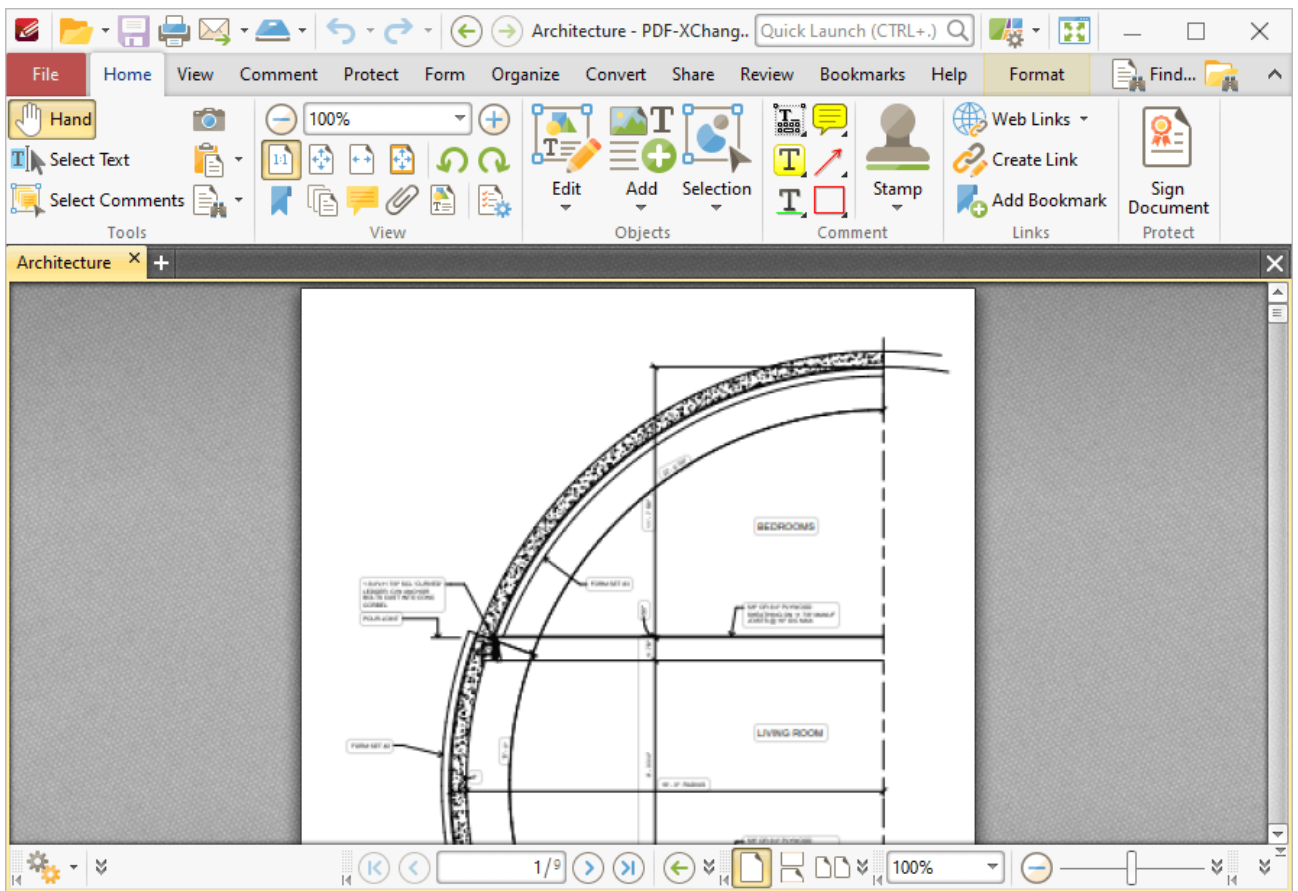

**Figure 1.** PDF X-Change Editor User Interface

The ribbon tabs are located at the top of the window:

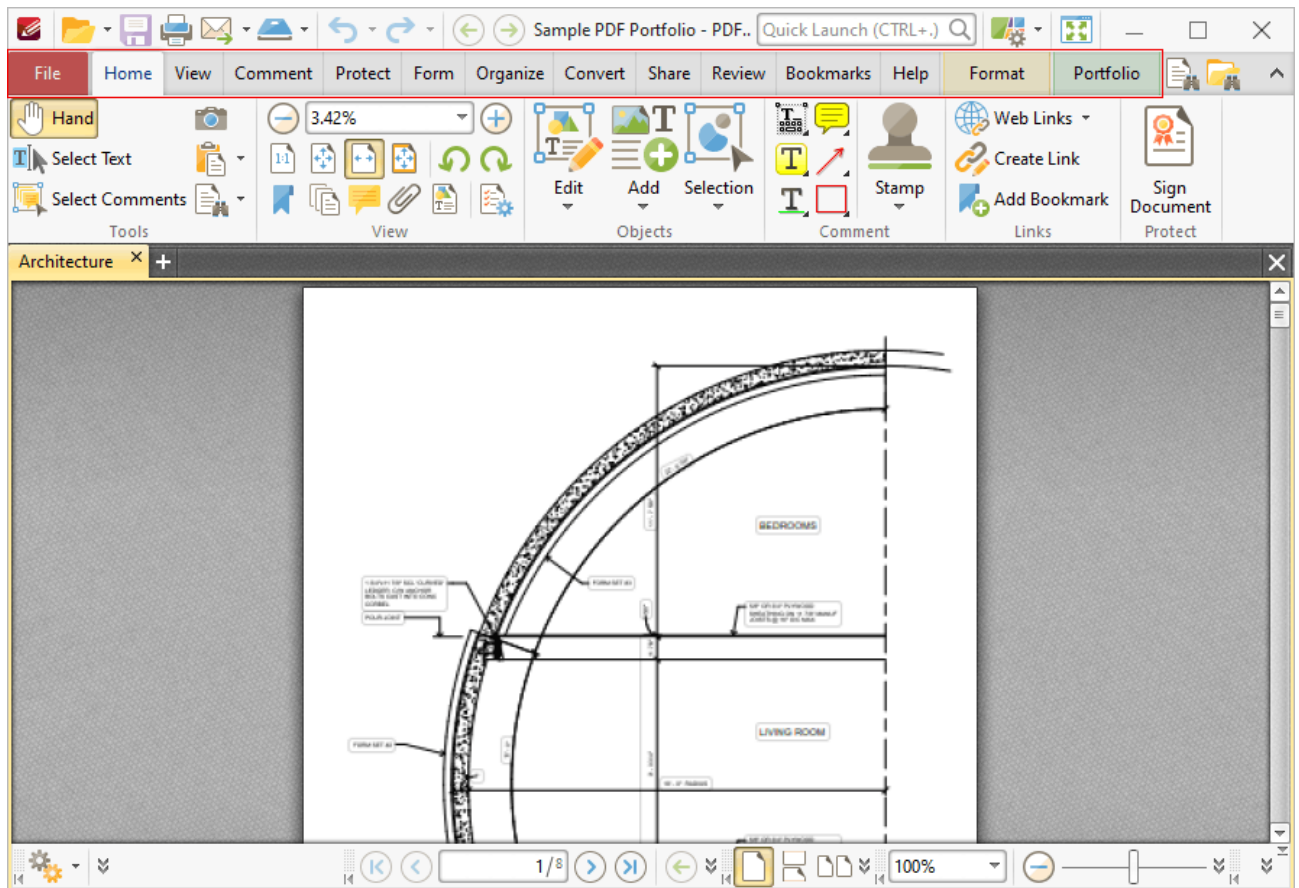

Figure 2. PDF X-Change Editor User Interface, Ribbon Tabs Highlighted

Click the links below to view the options and functionality of each tab:

- [File](#)<sup>772</sup> contains file-level operations such as open, close, save and print.
- [Home](#)<sup>938</sup> contains the most commonly-used commands, such as the basic tools, links to editing panes, view and rotation options, content-editing features, annotation tools and document signing options.
- [View](#)<sup>986</sup> contains options that determine what is displayed in the main window such as toolbar shortcuts and editing panes. Document layout options are also available in this tab.
- [Comment](#)<sup>1082</sup> contains options for editing document comments, such as converting comments to base content, importing/exporting comments and creating a comment summary.
- [Protect](#)<sup>1244</sup> contains options for signing and certifying documents, creating/editing security policies and redacting documents.
- [Form](#)<sup>1268</sup> contains options for managing, highlighting and creating document form fields such as radio buttons, dropdown menus and barcodes.
- [Organize](#)<sup>1447</sup> contains options for editing documents, such as add/remove watermarks, insert/delete/crop/resize pages, edit backgrounds, add headers and footers/Bates numbering.

- **Convert**<sup>1515</sup> contains options for creating documents from the local scanner, combining existing files into a new file, creating blank documents, performing OCR on documents and converting PDF files to other formats such as **MS Word, Excel** and **Powerpoint** formats. Note that files exported to **(\* .docx)** format are compatible with **MS Word 2010** and later.
- **Share**<sup>1537</sup> contains options that relate to files associated with the **Microsoft Office SharePoint Server**, such as checking documents in/out or discarding documents from **Sharepoint**, and also contains an option for emailing documents from **PDF-XChange Editor**.
- **Review**<sup>1541</sup> contains options for reviewing documents, such as the spell check and word count features, as well as options to create/delete and manipulate document comments.
- **Bookmarks**<sup>1549</sup> contains options that relate the creation and management of document bookmarks.
- **Help**<sup>1596</sup> contains links to software assistance, such as the **PDF-XChange** main website and user forum, and customizable options for the UI theme and toolbars.

Note that the layout and content of the ribbon tabs can be fully customized, as detailed [here](#).<sup>1599</sup>

The **Quick Access Toolbar** is located in the upper left of the user interface:

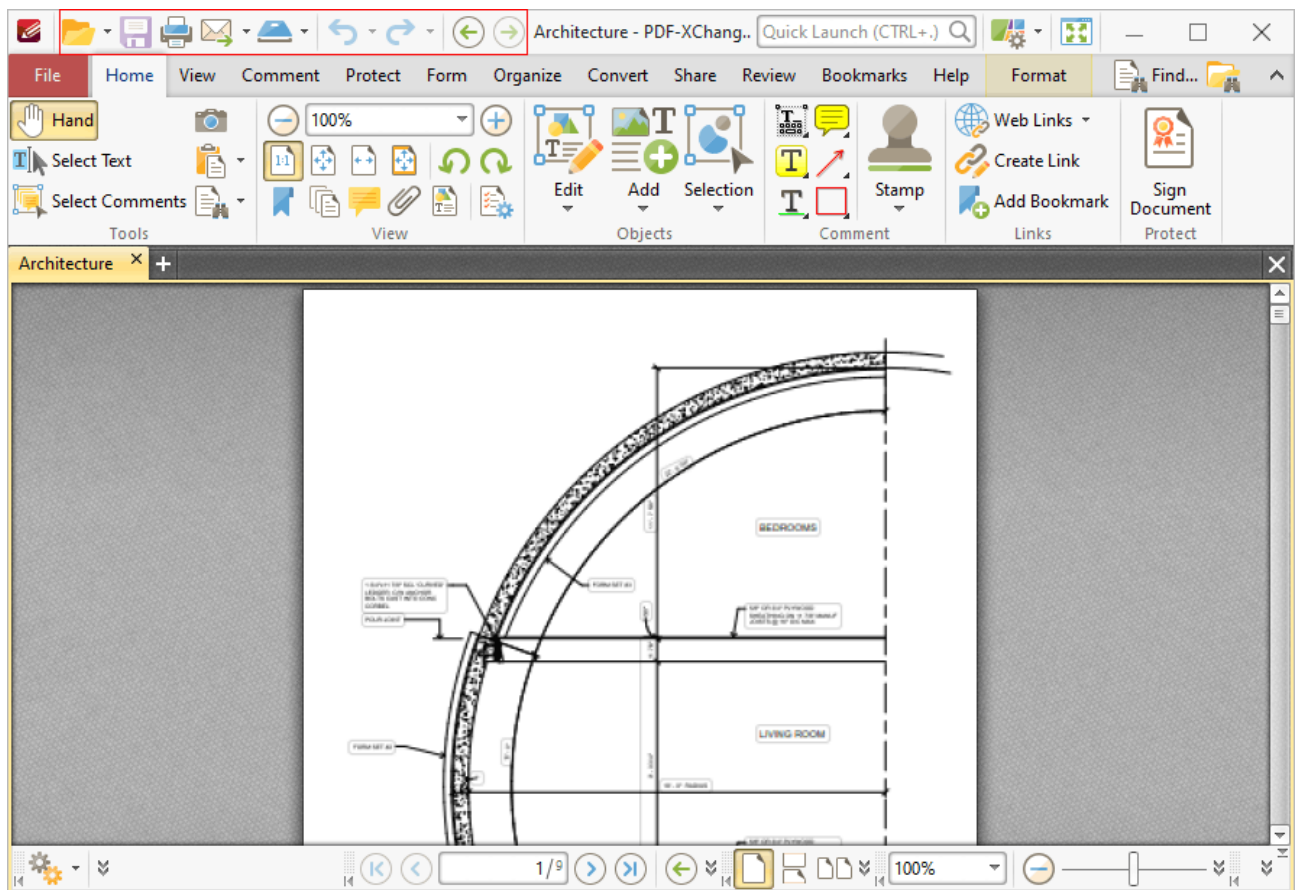



**Figure 3.** PDF X-Change Editor User Interface, Quick Access Toolbar Highlighted

Use the icons in this toolbar to perform the following operations:

Click  **Open** to open files, or click the dropdown arrow to view/select recent files, including pinned recents, as detailed [here](#).<sup>[775]</sup>

Click  **Save** to save files. Note that additional save options, such as **Save As** and **Save as Optimized**, are available in the [File](#).<sup>[772]</sup> tab.

Click  **Print** to print files. The **Print** dialog box will open and can be used to customize print settings, as detailed [here](#).<sup>[833]</sup>

Click  **Email** to email files, or click the dropdown arrow to view/manage available mail clients, as determined in the [Send Mail](#).<sup>[919]</sup> preferences.

Click  **Scan** to scan documents into **PDF-XChange Editor**, or click the dropdown arrow to select a preset scanning mode. The **Scan Properties** dialog box will open and can be used to customize scan settings, as detailed [here](#).<sup>[829]</sup> Scanned documents will be converted to PDF and displayed in the main window.

Click  **Undo** to undo the most recent action.

Click  **Redo** to reverse the most recent undo action.

Click  **Previous View** to navigate to the previous document view.

Click  **Next View** to navigate to the next view. Note that this option is only available when the **Previous View** option has been used.

If you would prefer the **Quick Access Toolbar** to be located beneath the ribbon UI, then right-click the **Quick Access Toolbar** and click **Show Below the Ribbon** in the shortcut menu.

The **Quick Launch** and **Quick Find** toolbars are used to determine the format of the user interface, enable fullscreen mode and find/search document text:

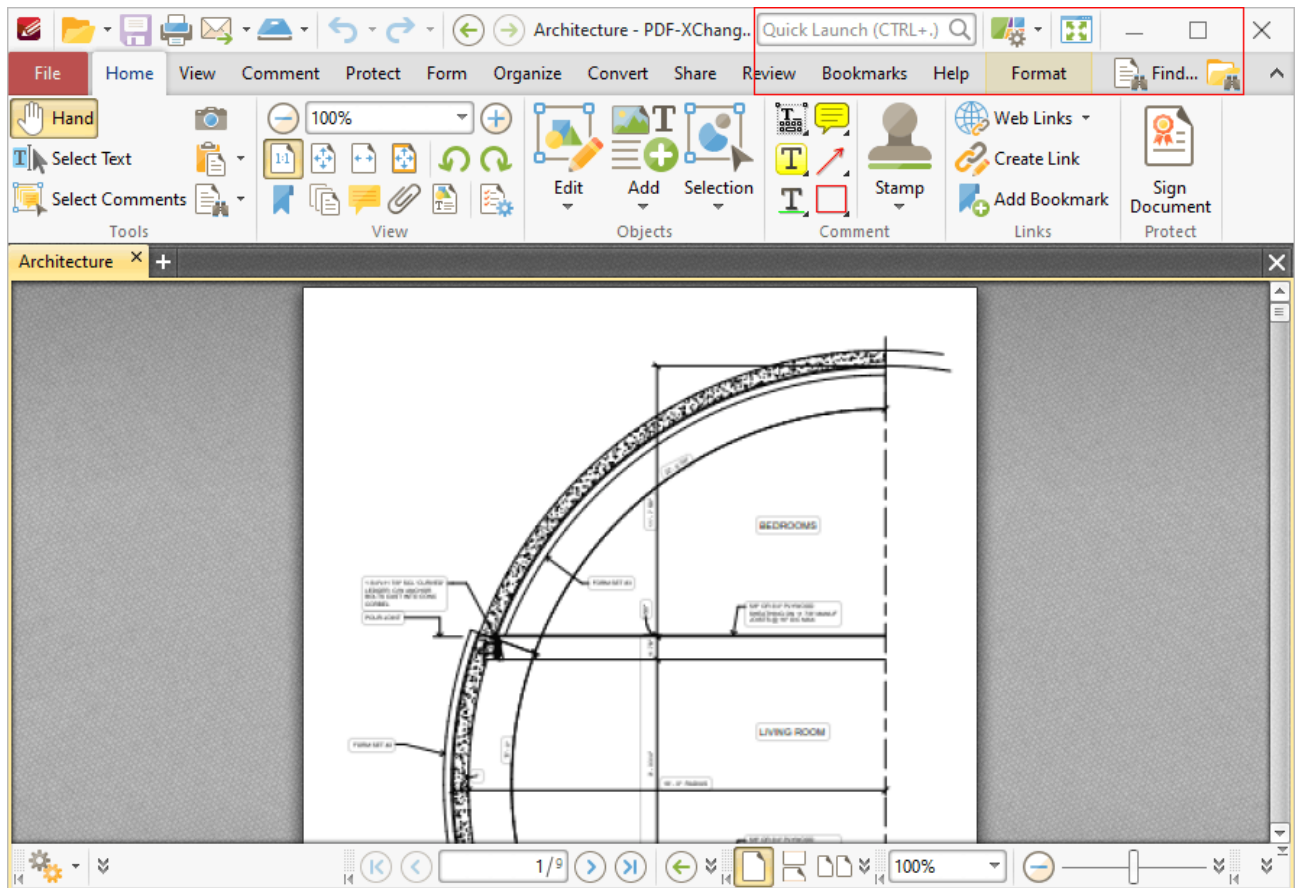





Figure 4. PDF X-Change Editor User Interface, Quick Launch and Quick Find Toolbars Highlighted

Click  **UI Options** to view/select UI options for **PDF-XChange Editor**:

- Click **Switch to Classic Toolbars** to switch to the classic UI layout that **PDF-XChange Editor** used before version seven. The classic UI version of this manual is available [here](#).
- Click **Switch to Touch-optimized UI** to switch from **Mouse-optimized UI** to **Touch-Optimized UI** and vice versa. The **Touch-optimized UI** features larger icons and is intended for use in conjunction with tablets, smartphones and similar devices.
- Click **Customize Toolbars** to customize toolbars, as detailed [here](#).<sup>1599</sup>

Click  **Full Screen Mode** to enable fullscreen mode. Note that fullscreen mode has many customizable features, as detailed [here](#).<sup>887</sup>

Click  **Find** to enable the **Find** feature. This feature locates specified document text, as detailed [here](#).<sup>1688</sup>

Click  **Search** to open the **Search** pane and search for text in documents open in **PDF-XChange Editor** or folders on the local computer, as detailed [here](#).<sup>1776</sup>

Click the  icon on the right of the **Search** icon to toggle the document toolbar and/or ribbon tab view.

Click the  **Quick Launch** text box to find and launch commands in **PDF-XChange Editor** - enter search terms in the text box and then click search results to activate them.



There are four toolbars in the lower section of the user interface:

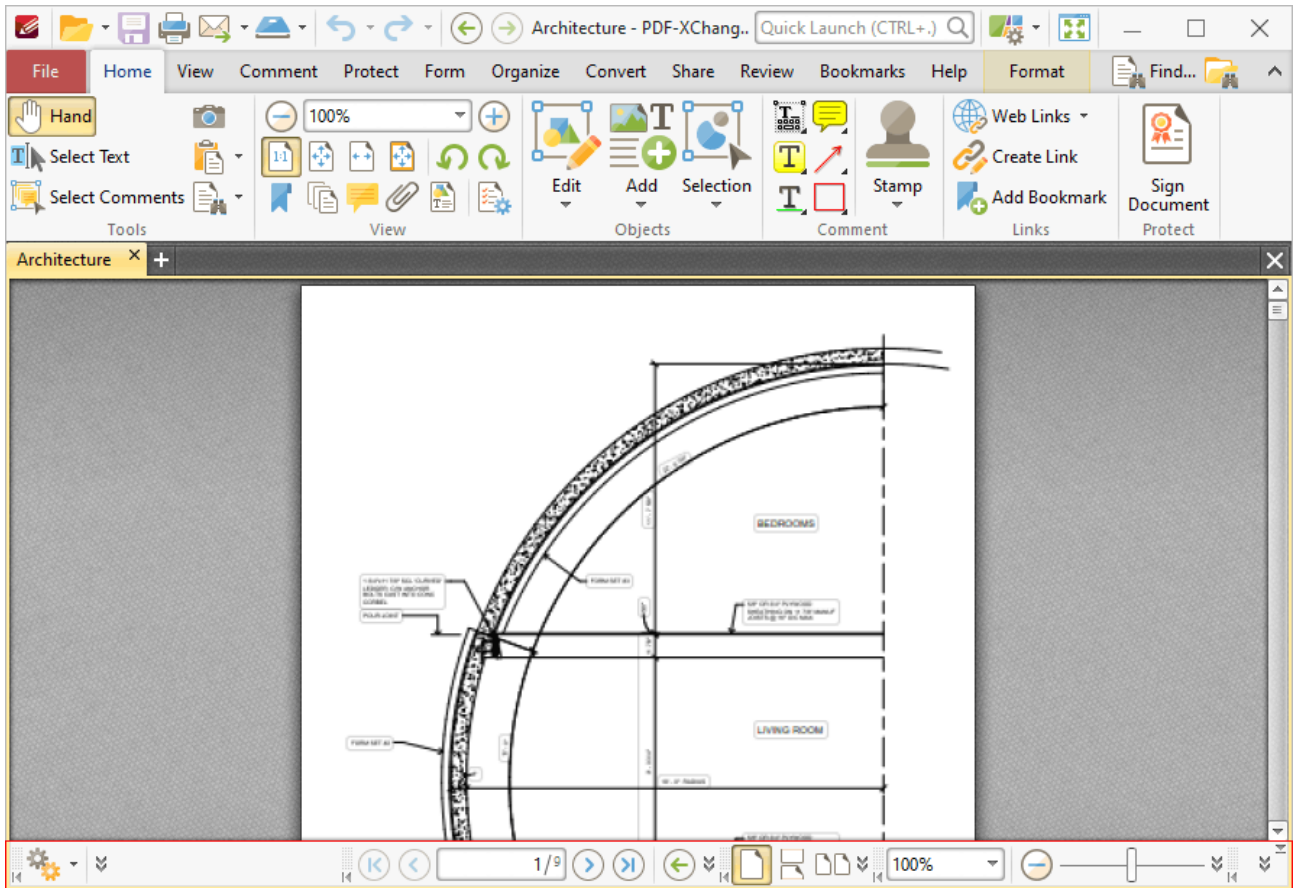

Figure 5. Lower UI Toolbars

When the UI is maximized, the **Document Options Toolbar** displays the dimensions of the document and the current pointer location:

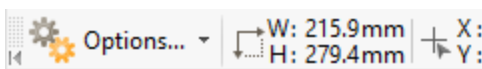

Figure 6. Document Options Toolbar

Click **Options** to open/close the document editing panes and view/select editing tools, as detailed [here](#).

The **Page Navigation Toolbar** is used to navigate between document pages and views:

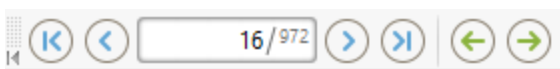

Figure 7. Page Navigation Toolbar

- Click the blue arrow icons to move to the first page, previous page, next page or last page of documents.

- Click the green arrow icons to move between the most recent views within documents.
- The number box at the center shows the current page and the total number of pages in the active document. Enter a page number and press **Enter** to move to it.

The **Page Layout Toolbar** is used to determine how pages are displayed in the main window:



Figure 8. Page Layout Toolbar

- **Single Page** displays one page at a time.
- **Continuous** displays single pages continuously.
- **Two Pages** displays two pages at a time.
- **Two Pages Continuous** displays two pages continuously.

The **Page Zoom** toolbar is used to determine the zoom level:



Figure 9. Page Zoom Toolbar

Enter the desired zoom level and press **Enter** to move to it, or select an option in the dropdown menu. Alternatively, use the slider to adjust the zoom level manually.

The **Launch Application Toolbar** is used to open current documents in different applications:



Figure 10. Launch Application Toolbar

Use the [Launch Applications](#) preferences to add applications to the toolbar, then click applications in the toolbar to launch them with the current document open inside.

Note that the arrow icons on the left of toolbars can be used to expand/collapse toolbars, and the grid of dots above the arrow icon can be used to click and drag toolbars to a different location in the user interface.

Additionally, please note that several of the keyboard shortcuts relate to the commands displayed on the user interface. See [here](#) for a comprehensive list of available keyboard shortcuts.

## 10.3 Operations Guide







---



### Operations Guide

---

This section of the manual details the most important operations and functions in **PDF-XChange Editor**:

-  [Annotations Guide](#) <sup>[604]</sup> - a breakdown of operations that relate to annotations, including how to add shapes and comments to documents, attach files, create/edit/clone comment styles, group-edit comments and several further operations associated with comments and annotations.
  -  [Bookmarks Guide](#) <sup>[624]</sup> - a breakdown of bookmark operations, including the multiple ways in which bookmarks can be created, edited and utilized.
  -  [Document Operations Guide](#) <sup>[632]</sup> - a breakdown of document-level operations, including how to create, edit, open, measure and save documents.
  -  [Editing Panes Guide](#) <sup>[738]</sup> - a breakdown of how to open and utilize the PDF-XChange Editor editing panes.
  -  [Forms Guide](#) <sup>[744]</sup> - a breakdown of operations that relate to the creation and utilization of fillable forms, including how to add/edit barcodes, buttons, check boxes, digital signatures, dropdown menus, list boxes, radio boxes and text fields to documents.
  -  [Workspace Guide](#) <sup>[750]</sup> - a breakdown of operations that relate to the customization and navigation of the workspace.
-

### 10.3.1 Annotations Guide



## Annotations Guide

**PDF-XChange Editor** can be used to create and edit document comments and annotations in multiple ways. Comments and annotations can be used to enhance documents and assist in the editing process. Click the links below for instructions on how to:

#### ▼ Add Arrow Annotations to Documents

1. Click the **Comment** tab.
2. Click the **Arrow Tool**:

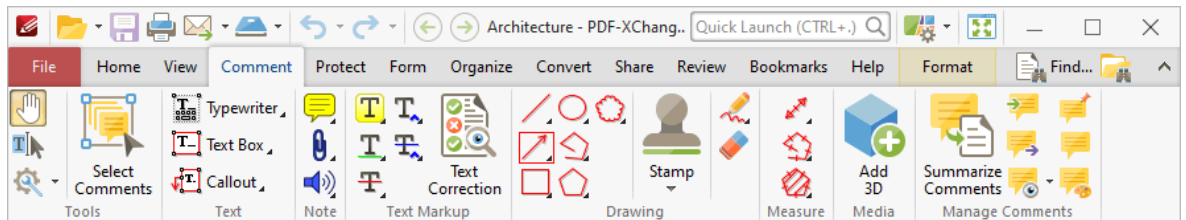

3. Follow the instructions detailed [here](#).

#### ▼ Add Callout Annotations to Documents

1. Click the **Comment** tab.
2. Click the **Callout Tool**:

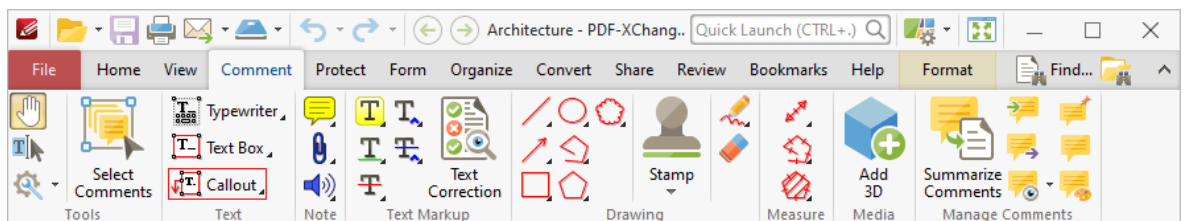

The pointer will become a crosshairs icon when this tool is selected.

3. Move the crosshairs to the desired location and click to create the callout annotation. See [here](#)<sup>1099</sup> for further information.

### ▼ Add Cloud Annotations to Documents

1. Click the **Comment** tab.

2. Click the **Cloud Tool**:

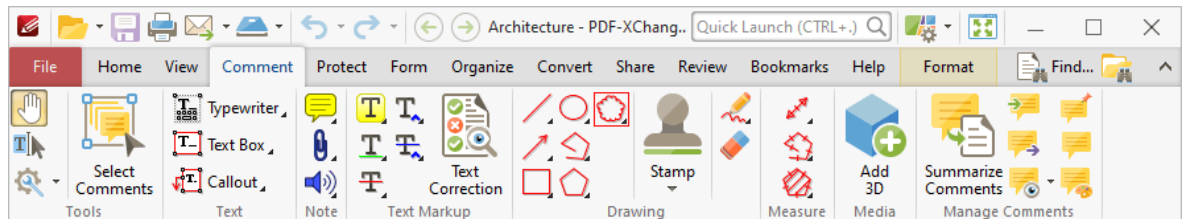

3. Follow the instructions detailed [here](#)<sup>1183</sup>

### ▼ Add Freehand Annotations to Documents

1. Click the **Comment** tab.

2. Click the **Pencil Tool**:

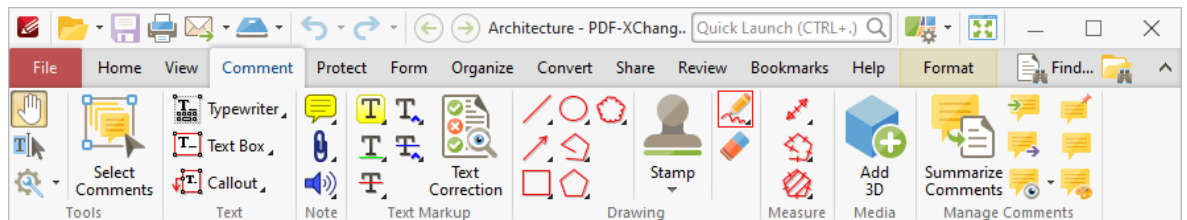

3. Follow the instructions detailed [here](#)<sup>1201</sup>

### ▼ Add Line Annotations to Documents

1. Click the **Comment** tab.

2. Click the **Line Tool**:

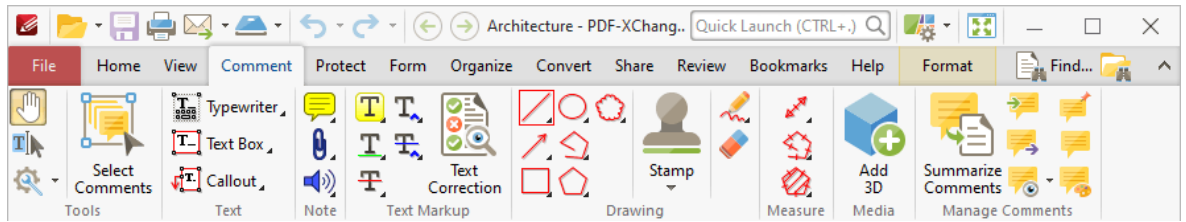

3. Follow the instructions detailed [here](#).<sup>1149</sup>

▼ **Add Oval Annotations to Documents**

1. Click the **Comment** tab.
2. Click the **Oval Tool**:

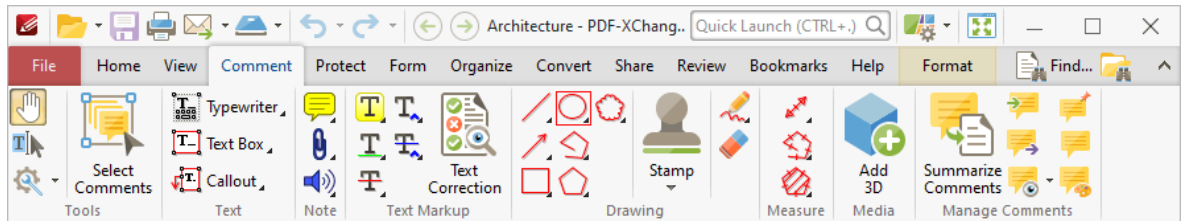

3. Follow the instructions detailed [here](#).<sup>1167</sup>

▼ **Add Polygon Annotations to Documents**

1. Click the **Comment** tab.
2. Click the **Polygon Tool**:

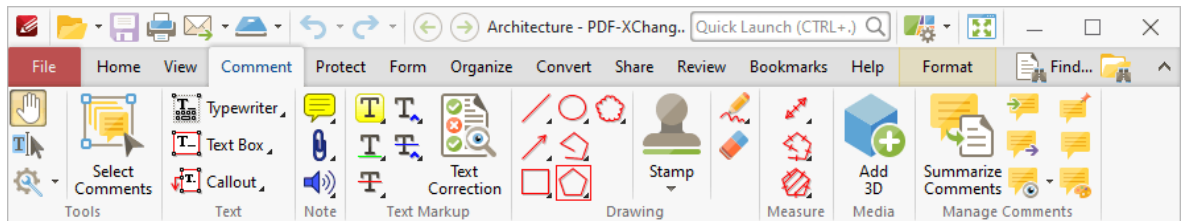

3. Follow the instructions detailed [here](#).<sup>1178</sup>

▼ **Add Polygon Line Annotations to Documents**

1. Click the **Comment** tab.
2. Click the **Polygon Line Tool**:

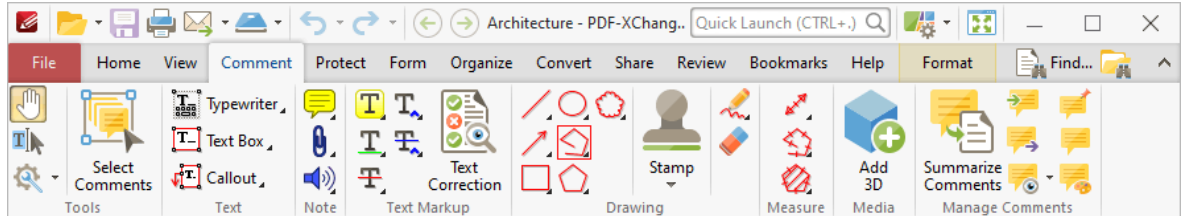

3. Follow the instructions detailed [here](#).<sup>1172</sup>

### ▼ Add Rectangle Annotations to Documents

1. Click the **Comment** tab.
2. Click the **Rectangle Tool**:

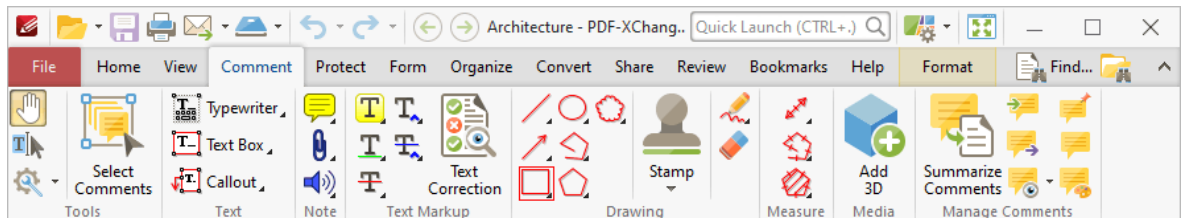

3. Follow the instructions detailed [here](#).<sup>1162</sup>

### ▼ Add Stamps to Documents

Stamps can be used to display the status of documents. The **Stamps Palette** contains several preloaded stamps, and custom stamps can be created for specific purposes.



Follow the steps below to open and utilize the **Stamp Tool**:

1. Click the **Comment** tab.
2. Click the **Stamp Tool**:

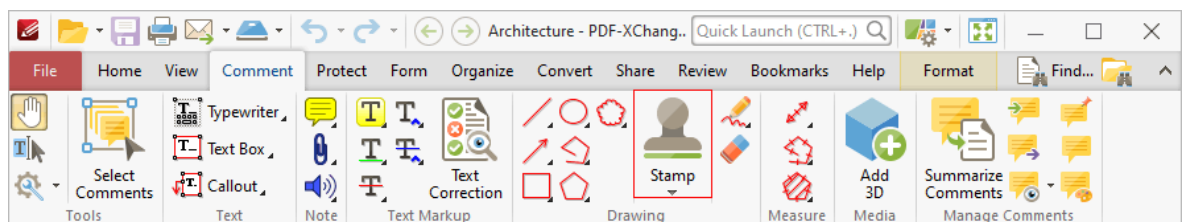

3. Follow the instructions detailed [here](#).



## ▼ Add Sticky Note Annotations to Documents

Sticky notes provide a convenient method for annotating documents. Completed sticky notes display as an icon that users can click in order to view/reply to content:

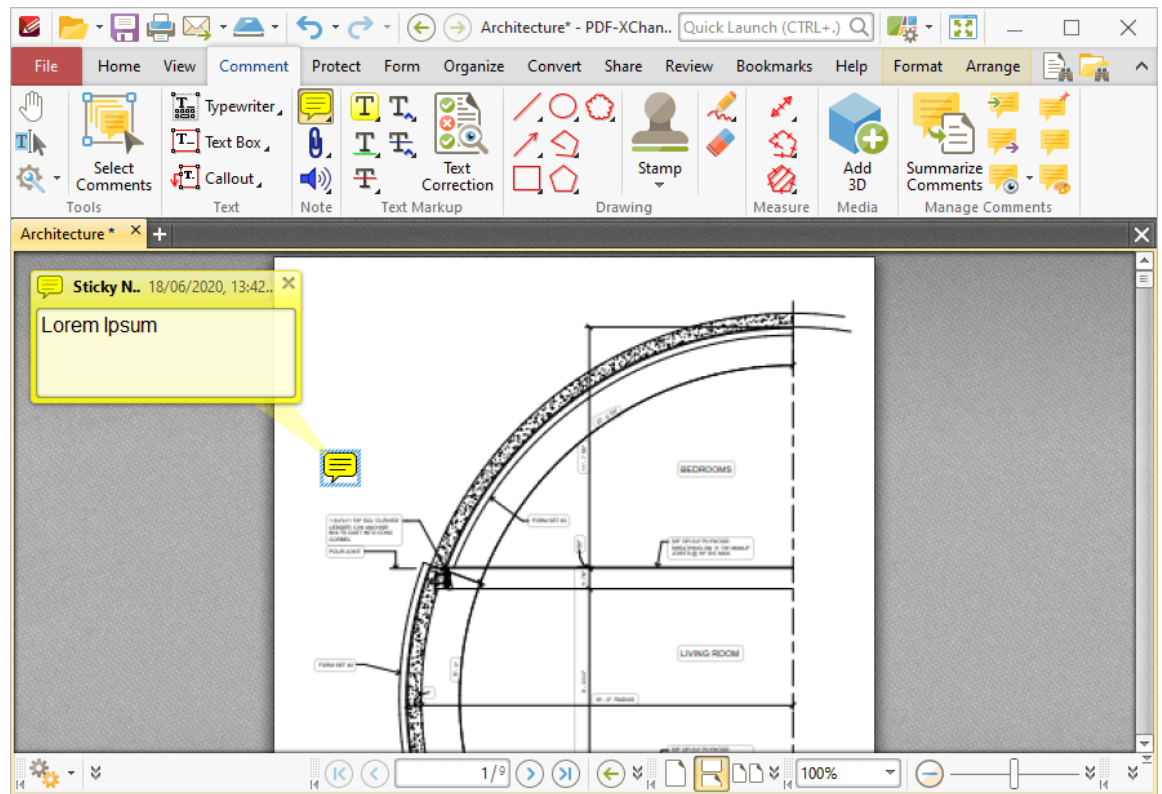

Follow the steps below to open and utilize the **Sticky Note Tool**:

1. Click the **Comment** tab.
2. Click the **Sticky Note Tool**:

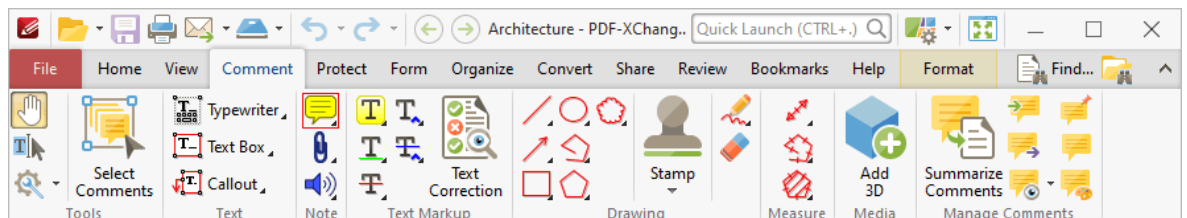

The pointer will become a crosshairs icon.

3. Move the crosshairs to the desired location and click to create the sticky note annotation. See [here](#) <sup>1105</sup> for further information.

### ▼ Add Text Box Annotations to Documents

1. Click the **Comment** tab.
2. Click the **Text Box Tool**:

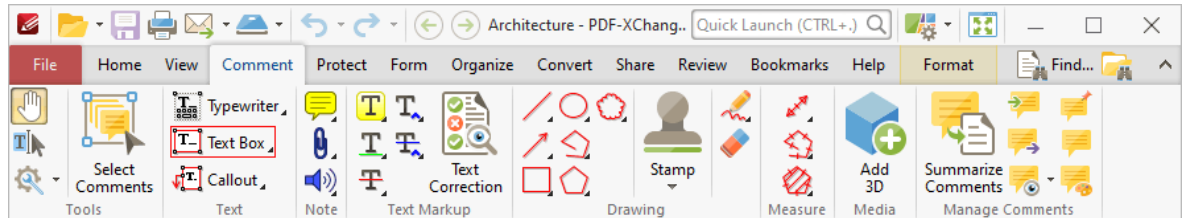

The pointer will become a crosshairs icon.

3. Move the crosshairs to the desired location and click to create the text box annotation. See [here](#) <sup>1004</sup> for further information.

### ▼ Add Text To Documents

1. Click the **Home** tab.
2. Click the **Add** dropdown menu and then click **Add Text**:

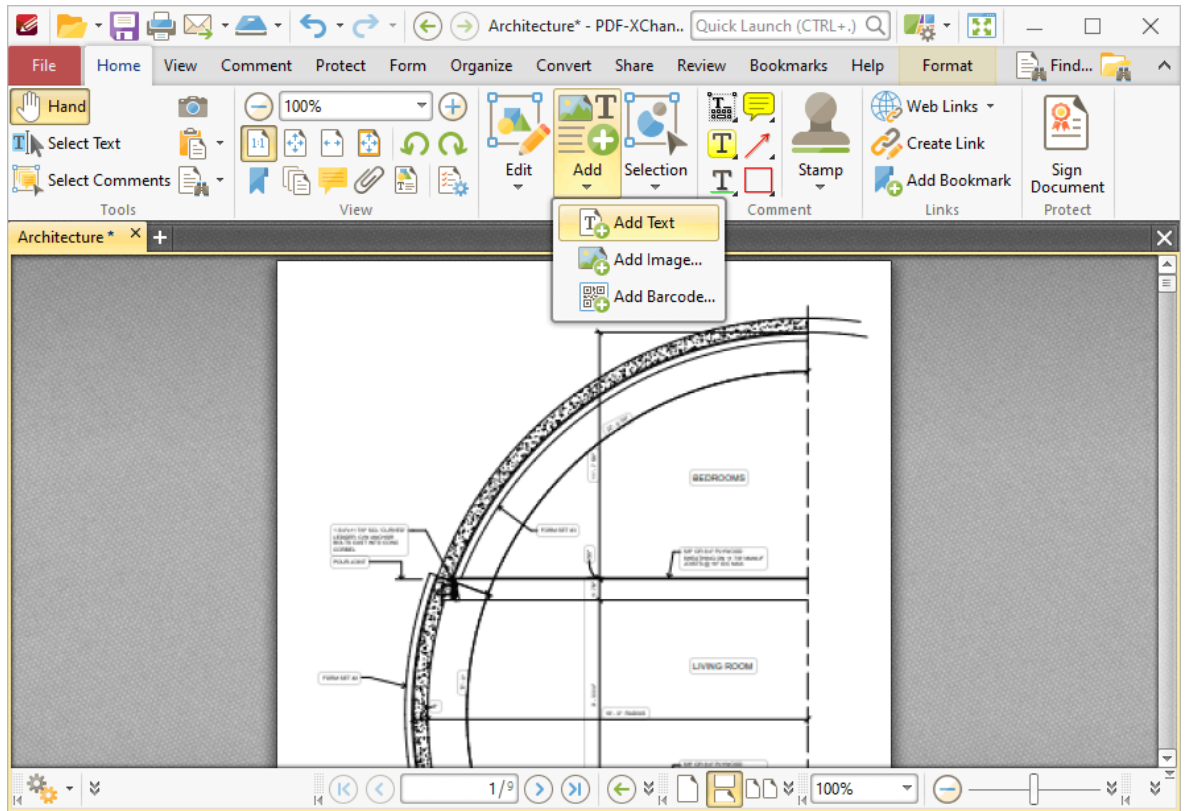

3. Follow the instructions detailed [here](#).<sup>1649</sup>

### ▼ Add Typewriter-Style Annotations to Documents

1. Click the **Comment** tab.
2. Click the **Typewriter Tool**:

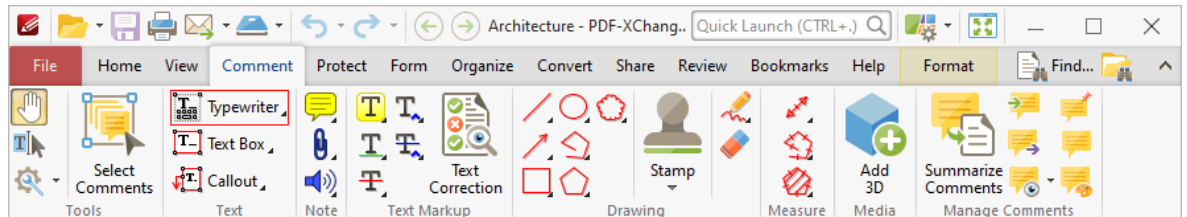

The pointer will become a crosshairs icon.

3. Move the crosshairs to the desired location and click to create the typewriter-style annotation. A blue rectangle will appear. Enter the desired text in the rectangle. See [here](#) <sup>1089</sup> for further information.

### ▼ Attach Files to Documents

1. Click the **Comment** tab.
2. Click the **Attach File Tool**:

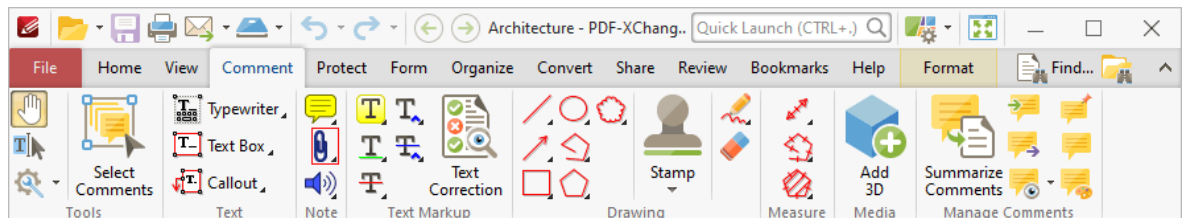

The pointer will become a crosshairs icon.

3. Move the crosshairs to the desired location and click to create the link. The **Open Files** dialog box will open.
4. Select the desired file and click **Open**.

### ▼ Clone and Edit Comment Styles

All comments and annotations can be customized to meet specific needs and aesthetic tastes with regard to style, color and related properties. Follow the steps below to saved customized styles for comments:

1. Click the **Comment** tab.
2. Click **Comment Styles Palette**:

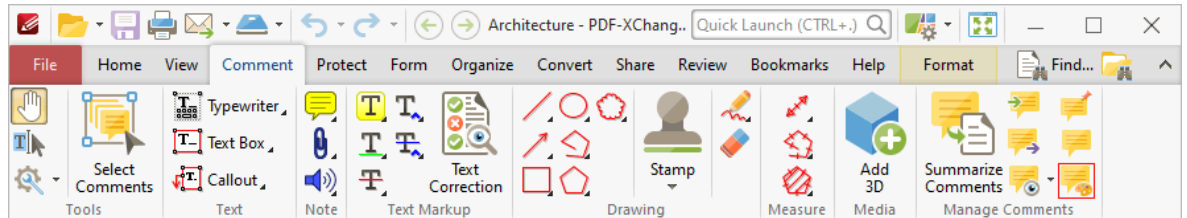

The **Comment Styles Palette** pane will open:

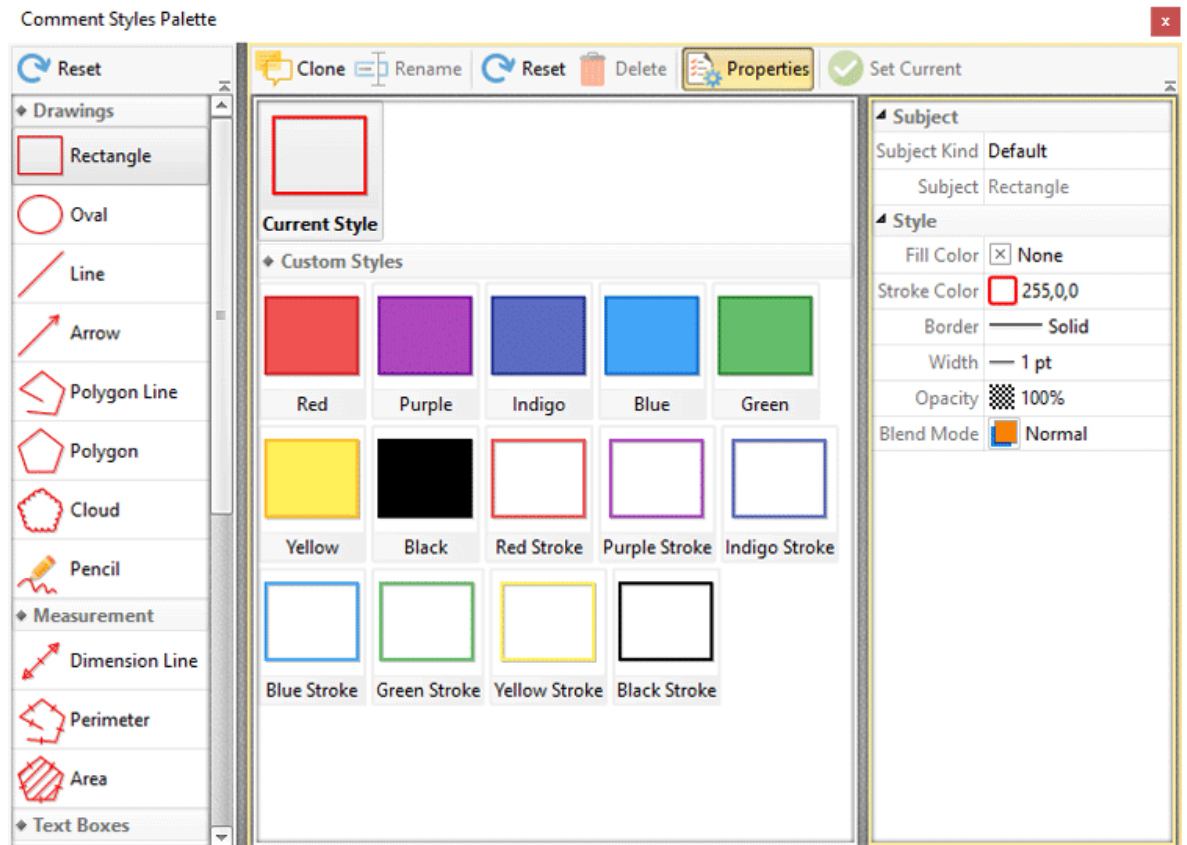

3. Select the desired comment style and click **Clone**. The style can then be edited and saved for subsequent use. See [here](#) <sup>1242</sup> for further information and operational instructions on the **Comment Styles Palette**.

Right-click annotation icons on the ribbon for quick access to customized styles:

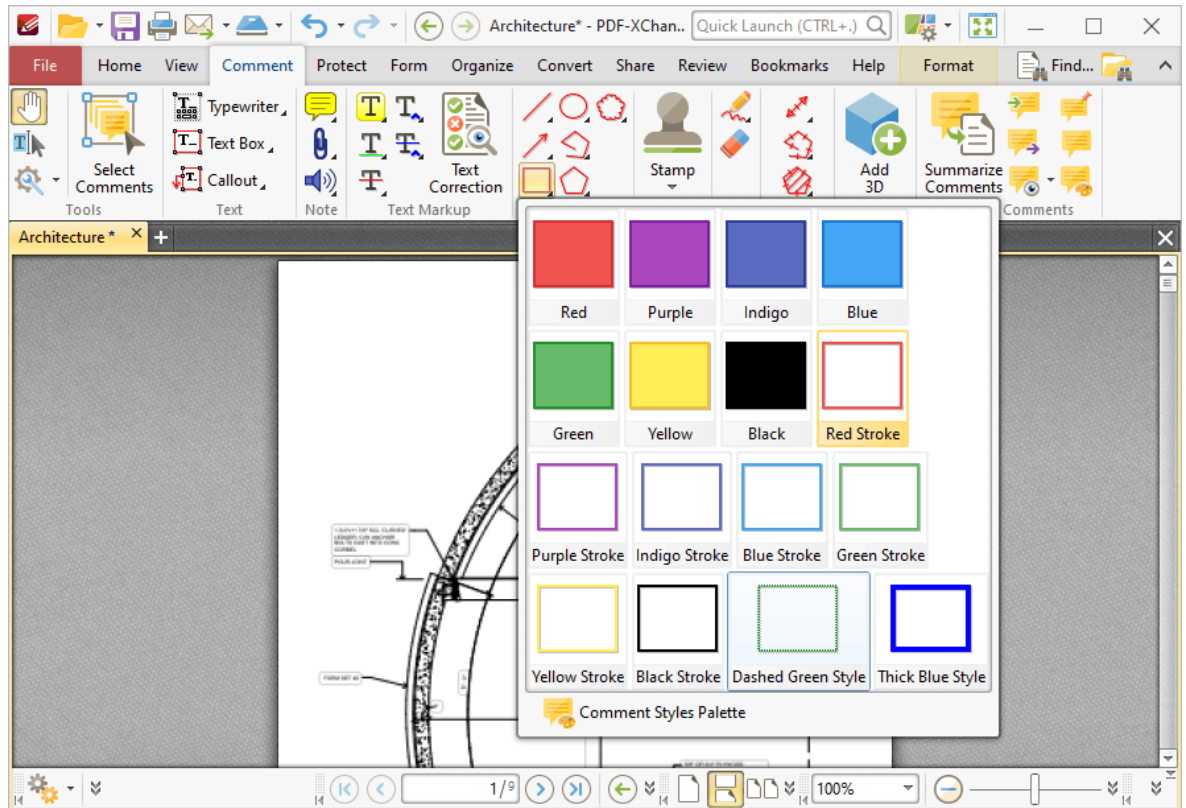

### ▼ Convert Annotations into Base Content

PDF documents are composed of two layers. The first layer consists of the original PDF content, such as text and/or images. The second layer, which is placed over the first, consists of comments and/or markups added to the document using the software. These layers exist and operate independently of each other. This means that editing commands applied to original PDF content/comments and markups will apply only in relation to the layer in which selected items are located. When comments and markups are flattened they are moved to the same layer as original PDF content and can then be edited simultaneously. Follow the steps below to convert annotations into base content:

1. Click the **Comment** tab.
2. Click **Flatten Comments**:

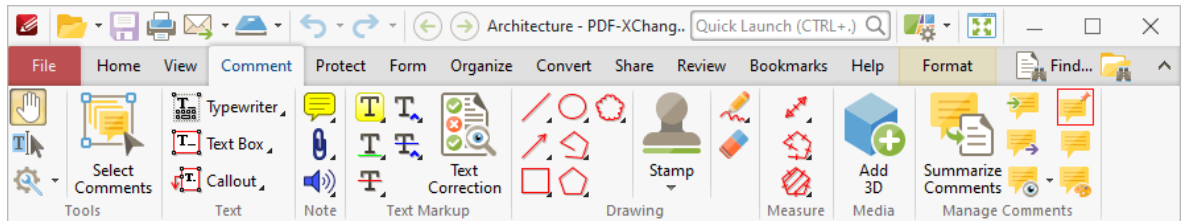

The **Flatten Annotations** dialog box will open:

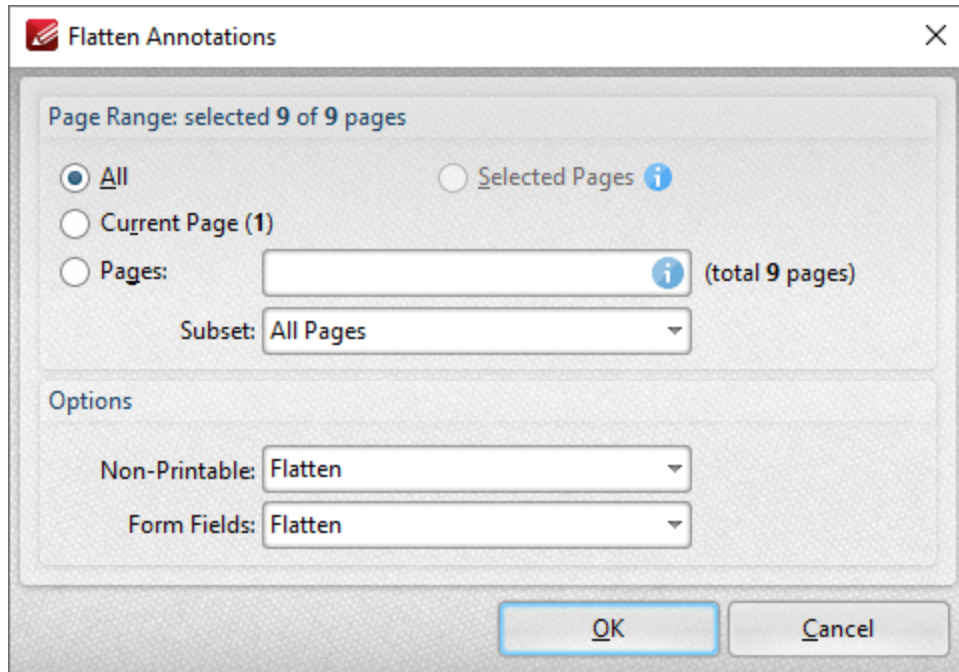

3. Determine parameters as detailed [here](#).

4. Click **OK**.

▼ **Create Links in Documents**

1. Click the **Home** tab.

2. Click **Create Link**:

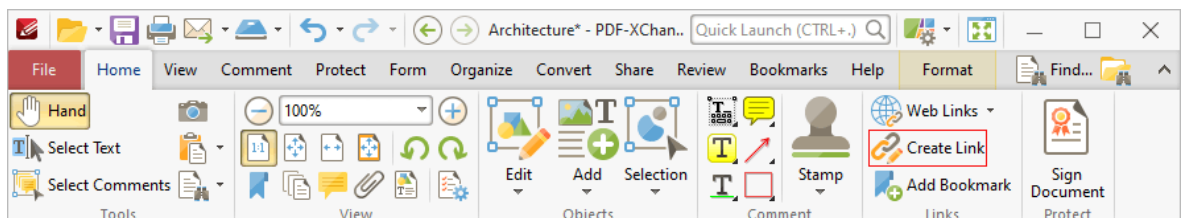

The pointer will become a crosshairs icon.

3. Click and drag the crosshairs icon to create links, then customize their parameters as detailed [here](#).<sup>1956</sup>

#### ▼ Determine which Comments are Shown/Hidden

1. Click the **Comment** tab.

2. Click **Show Comments**:

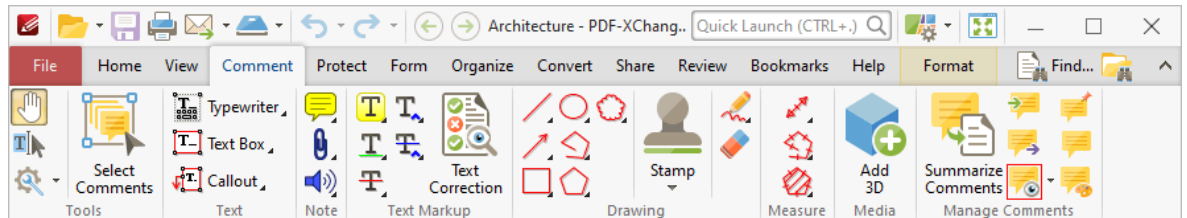

3. Determine parameters as detailed [here](#).<sup>1237</sup>

#### ▼ Duplicate Comments

1. Click the **Home** tab.

2. Click **Select Comments**, then group-select the comments for duplication.

3. Click **Selection** on the ribbon, then click **Duplicate**:



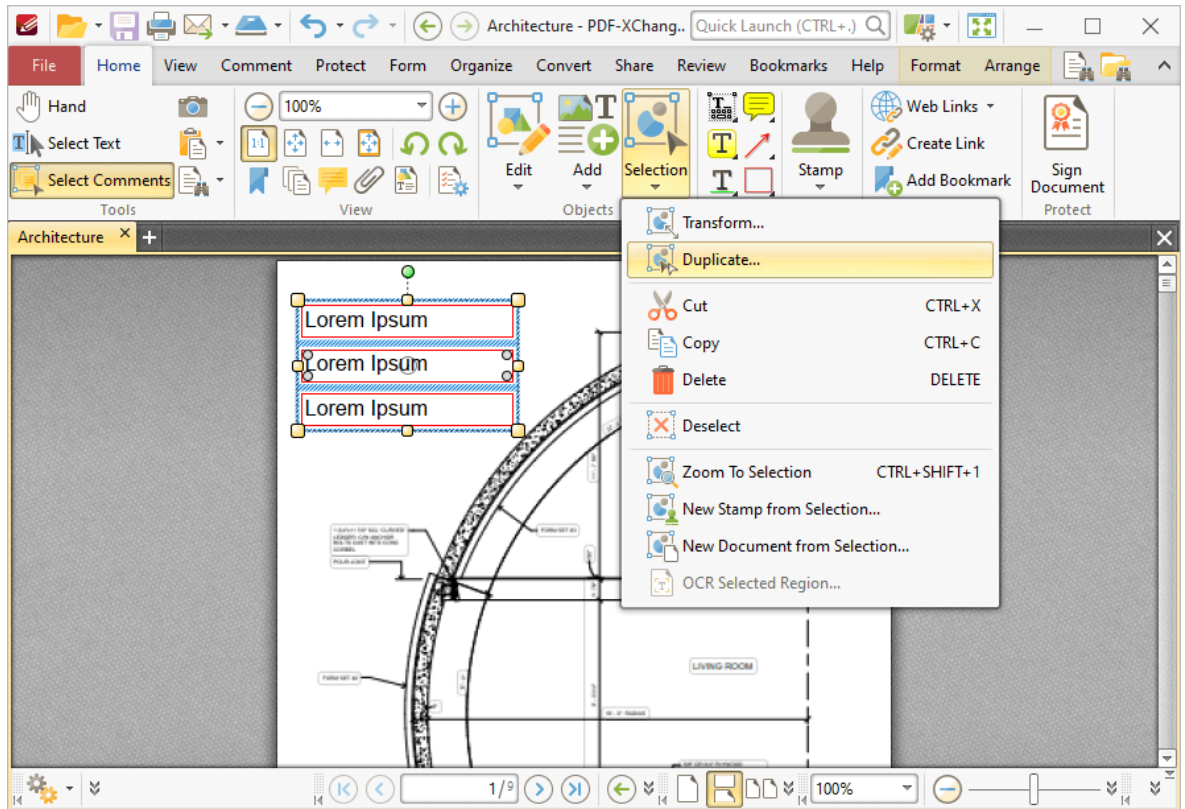



4. Follow the instructions detailed [here](#).<sup>950</sup>

#### ▼ Edit Text in Comments

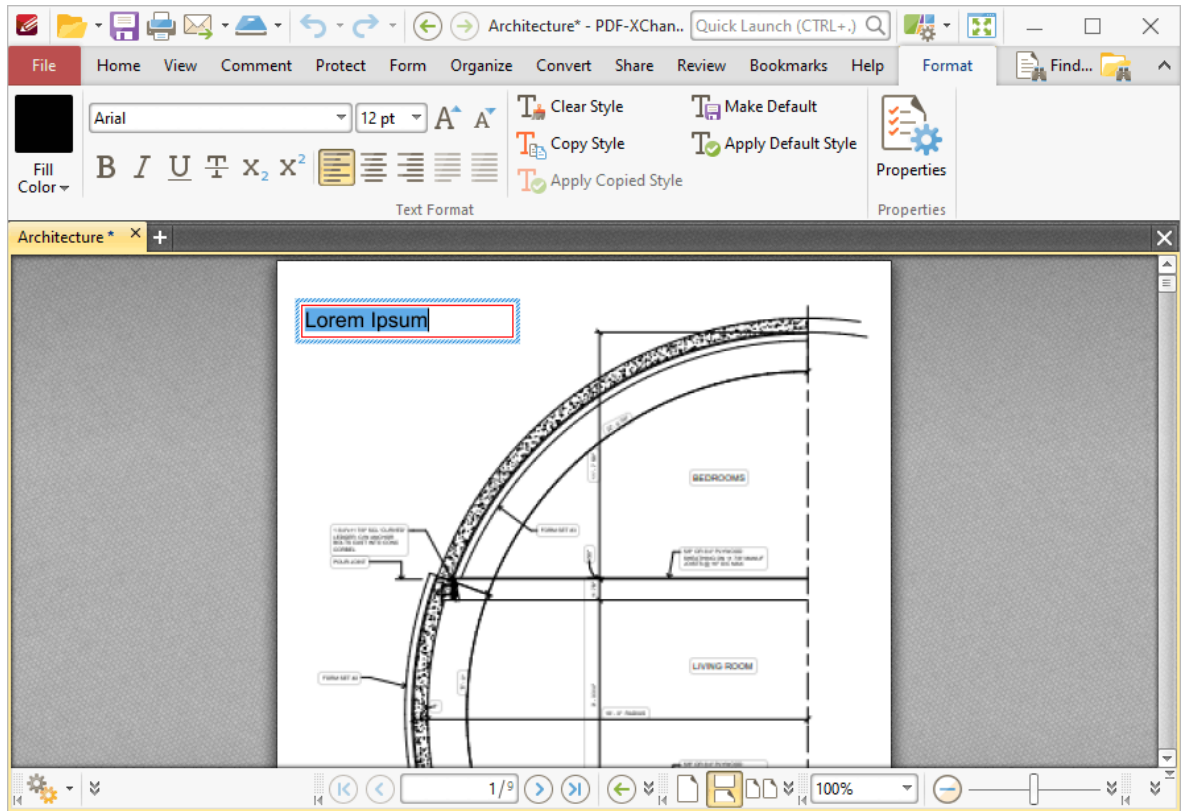
1. Select the comment text. Note that the **Format** tab will then be enabled.
2. Click the **Format** tab:



3. Edit text as detailed [here](#). 

### ▼ Export Comments to a Data File

1. Click the **Comment** tab.
2. Click **Export Comments to Data File**:

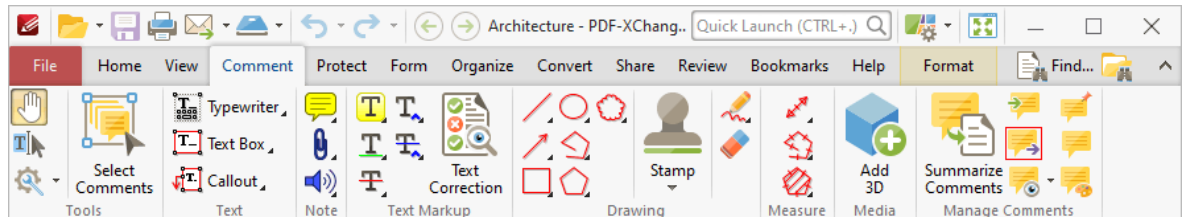

The **Save File** dialog box will open.

3. Enter a name for the file in the **File name** text box.
4. Click **Save**.

### ▼ Import Comments from a Data File

1. Click the **Comment** tab.
2. Click **Import**:

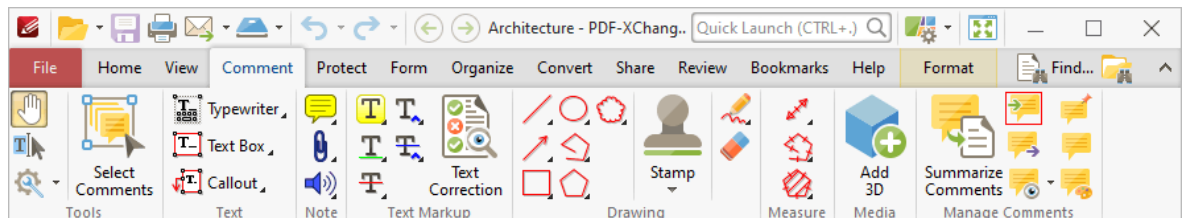

The **Open Files** dialog box will open.

3. Enter a name for the file in the **File name** text box.
4. Click **Open**.

### ▼ Reposition Comments

1. Click the **Home** tab.

2. Click **Select Comments** and select the desired comments:
3. Click **Selection**, then click **Transform**:

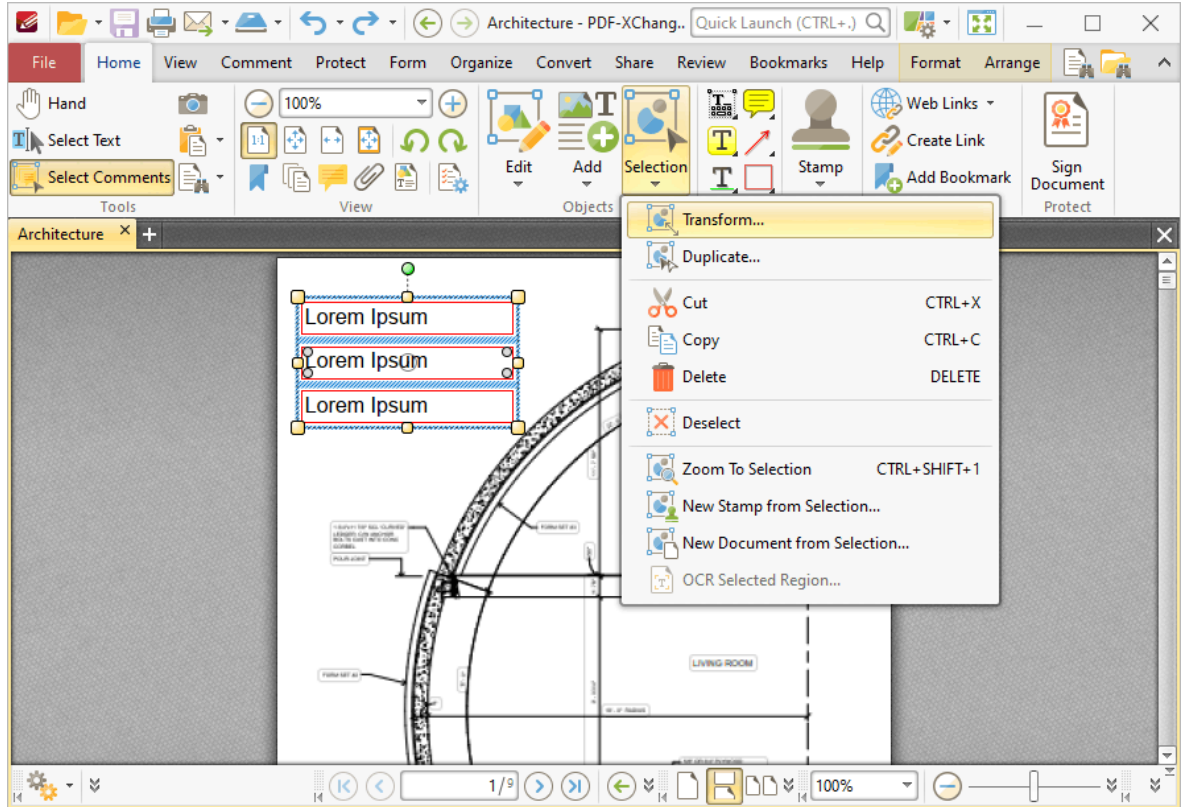

4. Follow the instructions detailed [here](#).<sup>[948]</sup>

Alternatively, enable the [Select Comments](#)<sup>[1087]</sup> tool and then click and drag comments to reposition them manually.

▼ **Reset Comment Styles**

1. Click the **Comment** tab.
2. Click **Comment Styles**:

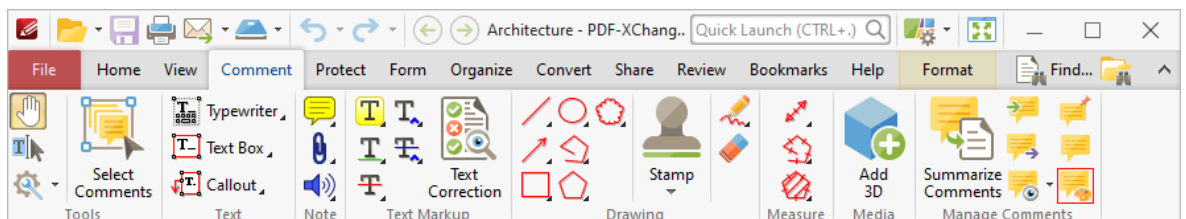

The **Comment Styles Palette** will open:

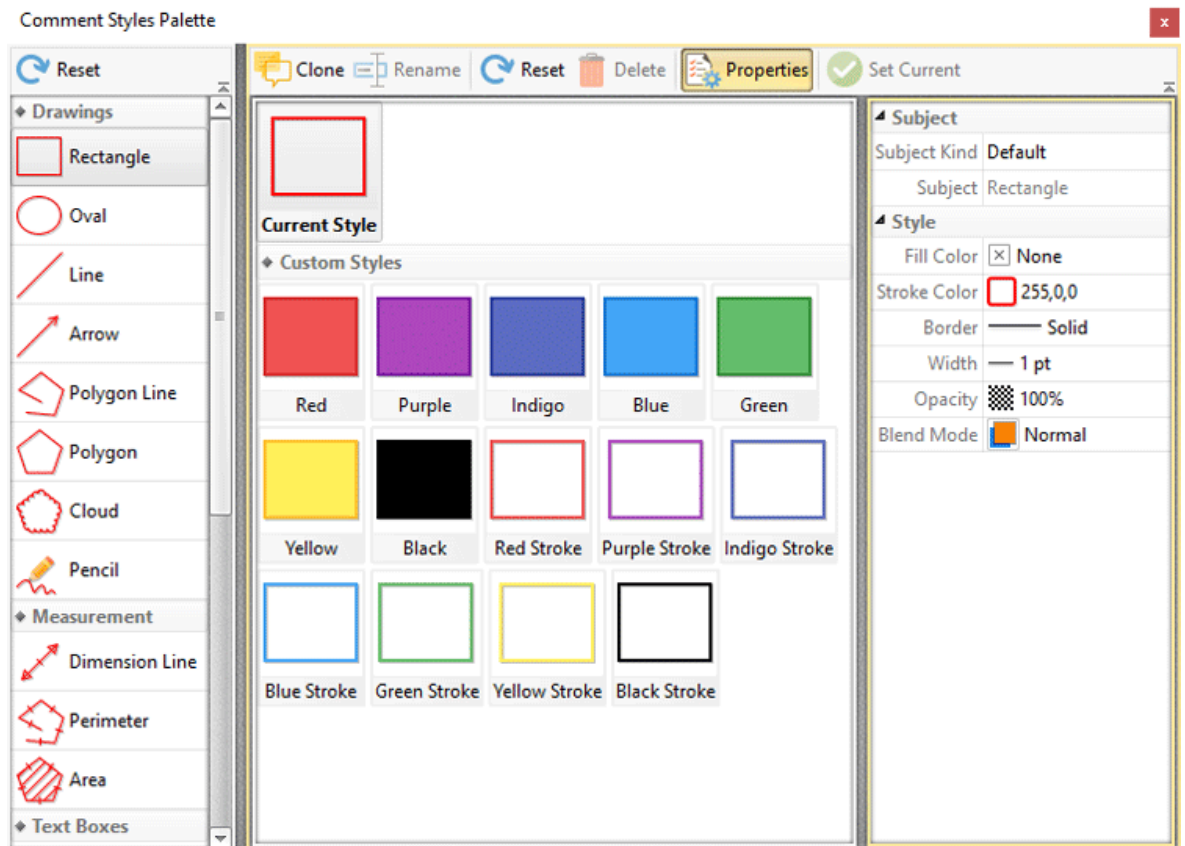

3. Select the desired style.

4. Click **Reset**.

### ▼ **Resize Comments**

1. Select the **Home** tab.

2. Click **Select Comments** and select the desired comments.

3. Click **Selection**, then click **Transform**:

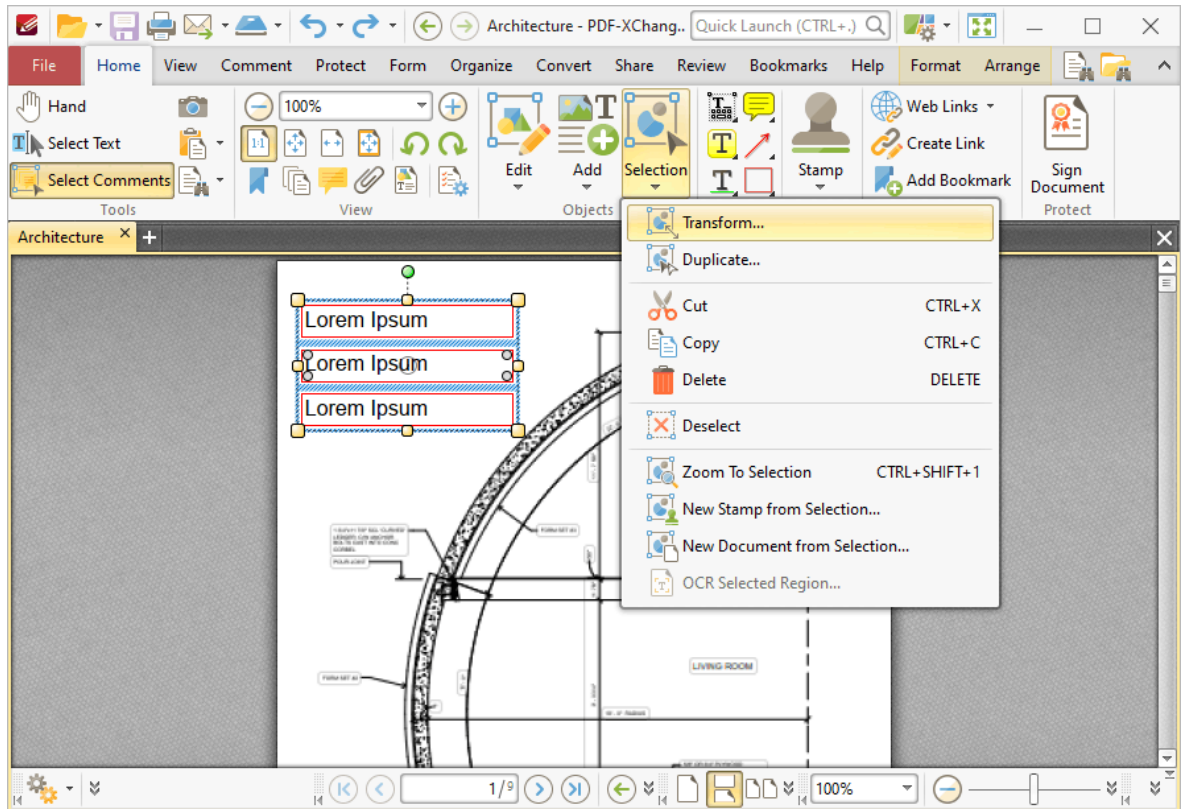

4. Follow the instructions detailed [here](#).<sup>[948]</sup>

Alternatively, enable the **Select Comments Tool**, then click and drag comments to resize them manually.

#### ▼ Set Customized Style as Default

**PDF-XChange Editor** displays the current comment style for annotation tools in the **Comment**<sup>[1062]</sup> tab. This style is selected automatically when the associated tool is selected. The default comment/annotation style is selected by default. Follow the steps below to set a customized style as the default setting for tools:

1. Click the **Comment** tab.
2. Click **Comment Styles**:

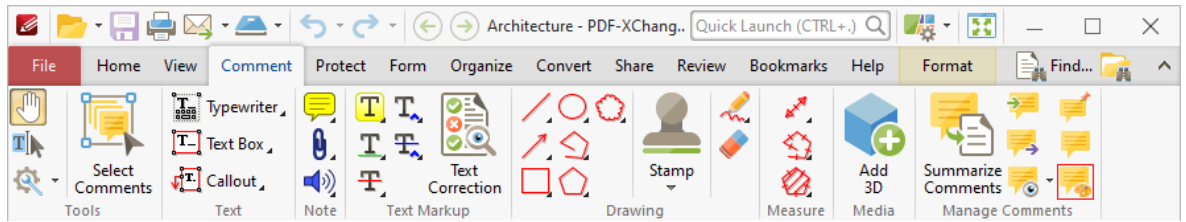

The **Comment Styles Palette** will open:

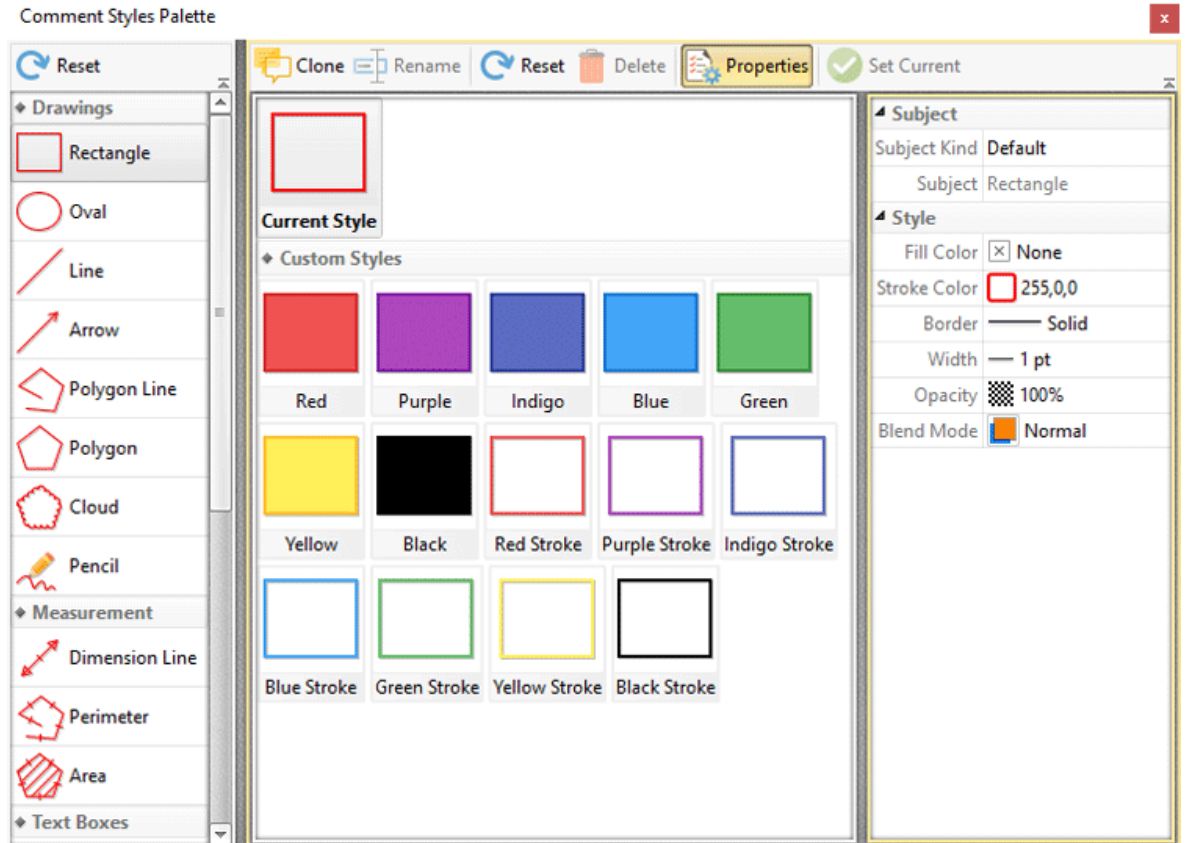

3. Select the desired style and click **Set Current**.

Editing options are available after tools have been used to create content. See [here](#)<sup>1783</sup> for further information.

Additionally, several of the [Keyboard Shortcuts](#)<sup>1691</sup> relate to annotations.

### 10.3.2 Bookmarks Guide

---



## Bookmarks Guide

---

**PDF-XChange Editor** features several operations that assist in the creation and manipulation of bookmarks. Bookmarks provide a useful method of designating and navigating to important document locations. Click the links below for instructions on how to:

#### ▼ Add Text to Bookmark Titles

1. Click the **Bookmarks** tab.
2. Click **Add Text**:

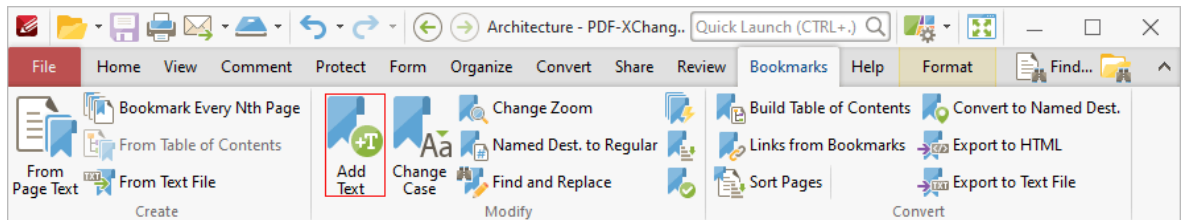

3. Follow the instructions detailed [here](#).

#### ▼ Create Bookmarks

1. Move to the desired new bookmark location.
2. Click the **Home** tab.
3. Click **Add Bookmark**:



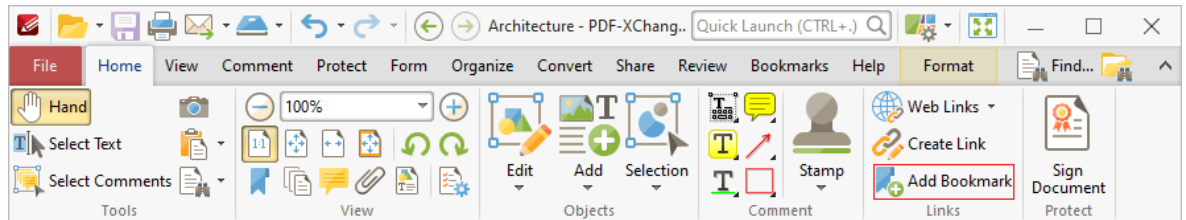

The **Bookmarks** pane will open and a new bookmark will be displayed. Further information on bookmarks and their customization is available [here](#).<sup>994</sup>

The keyboard shortcut for this operation is Ctrl+Shift+B.

### ▼ Create Bookmarks by Page Number

1. Click the **Bookmarks** tab.
2. Click **Bookmark Every Nth Page**:

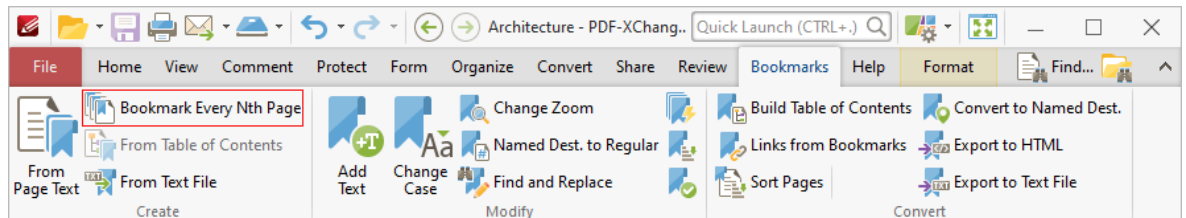

3. Follow the instructions detailed [here](#).<sup>1560</sup>

### ▼ Create Bookmarks From a Table of Contents

1. Click the **Home** tab.
2. Click the **Select Text Tool**, then select the table of contents:

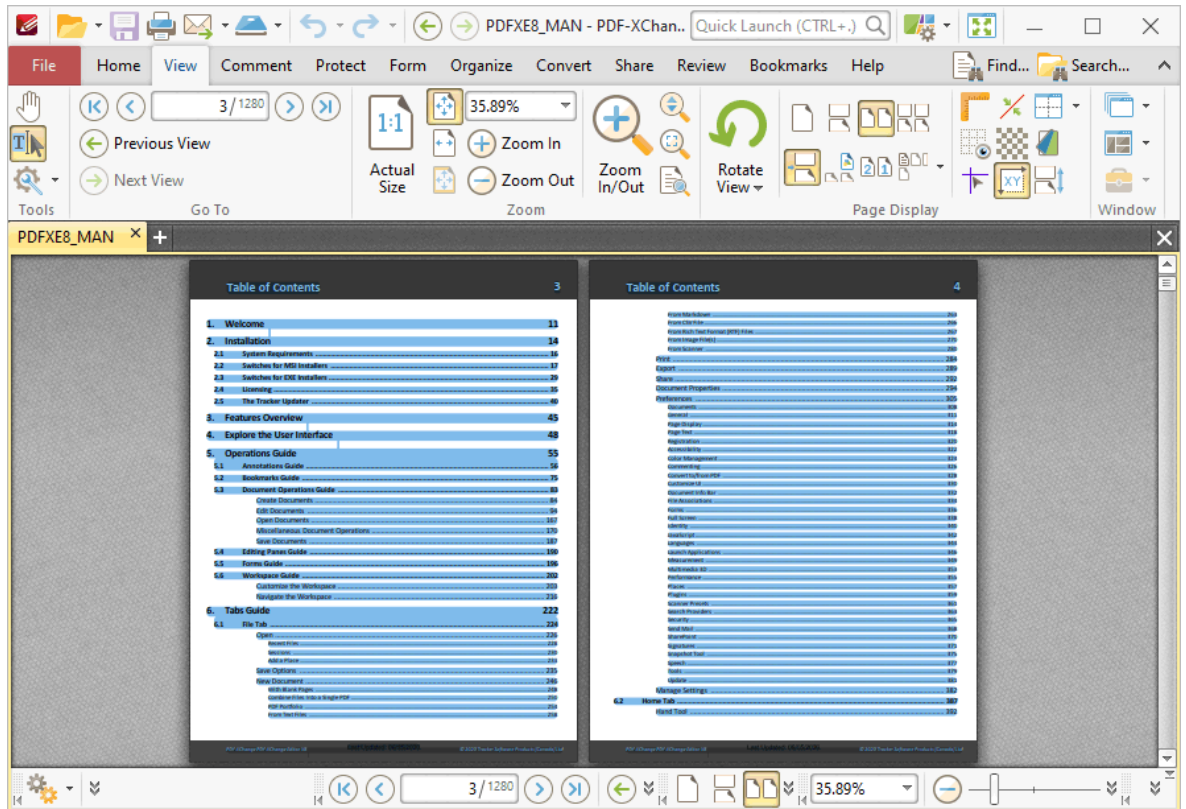

3. Click the **Bookmarks** tab.

4. Click **From Table of Contents**:

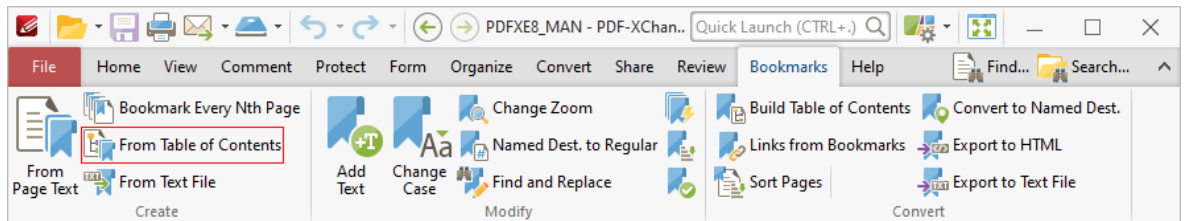

5. Follow the instructions detailed [here](#).<sup>1562</sup>

▼ **Create Bookmarks From Page Text**

1. Click the **Bookmarks** tab.

2. Click **From Page Text**:

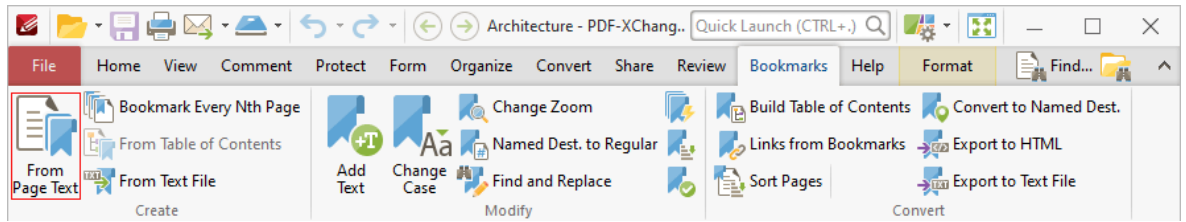

3. Follow the instructions detailed [here](#).<sup>1552</sup>

## ▼ Create Bookmarks From Text Files

1. Click the **Bookmarks** tab.
2. Click **From Text File**:

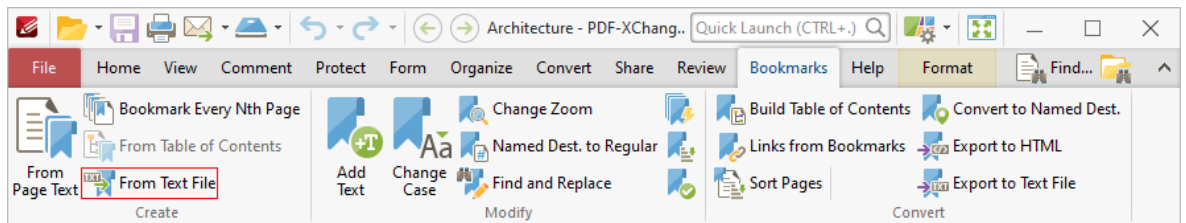

3. Follow the instructions detailed [here](#).<sup>1564</sup>

## ▼ Create Links From Bookmarks

1. Click the **Bookmarks** tab.
2. Click **Links from Bookmarks**:

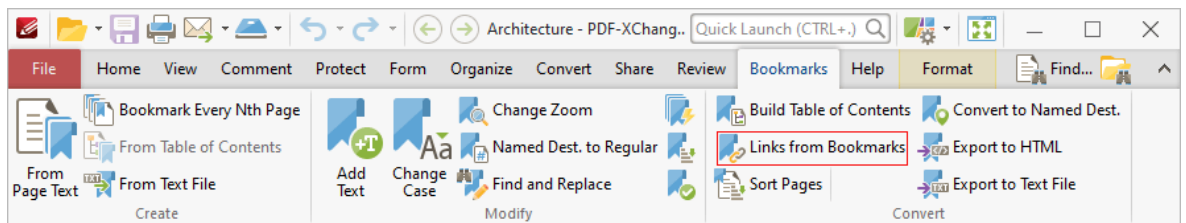

3. Follow the instructions detailed [here](#).<sup>1586</sup>

## ▼ Edit the Case of Bookmark Text

1. Click the **Bookmarks** tab.
2. Click **Change Case**:

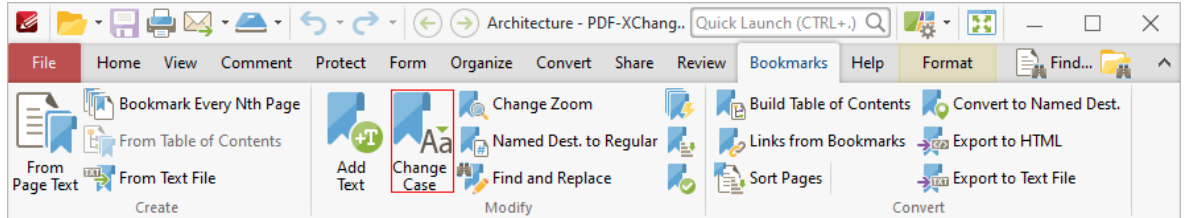

3. Follow the instructions detailed [here](#).<sup>1589</sup>

## ▼ Export Bookmarks to HTML Files

1. Click the **Bookmarks** tab.
2. Click **Export to HTML**:

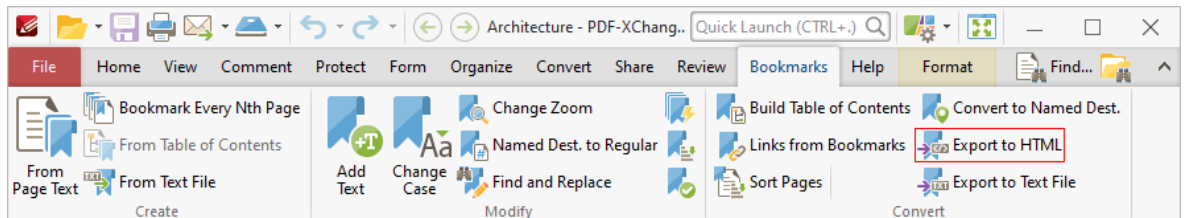

3. Follow the instructions detailed [here](#).<sup>1592</sup>

▼ **Export Bookmarks to Text Files**

1. Click the **Bookmarks** tab.
2. Click **Export Bookmarks to Text File**:

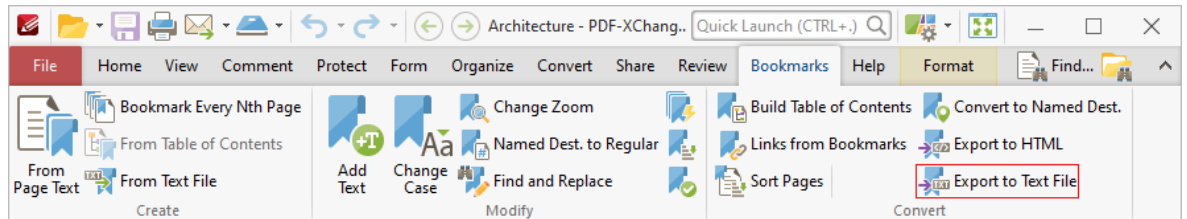

3. Follow the instructions detailed [here](#).<sup>1593</sup>

▼ **Find and Replace Bookmark Text**

1. Click the **Bookmarks** tab.
2. Click **Find And Replace**:

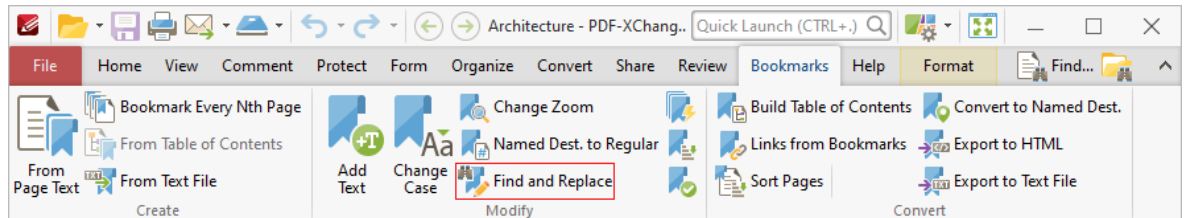

3. Follow the instructions detailed [here](#).<sup>1575</sup>

▼ **Remove Actions from Bookmarks**

1. Click the **Bookmarks** tab.
2. Click **Remove Actions**:

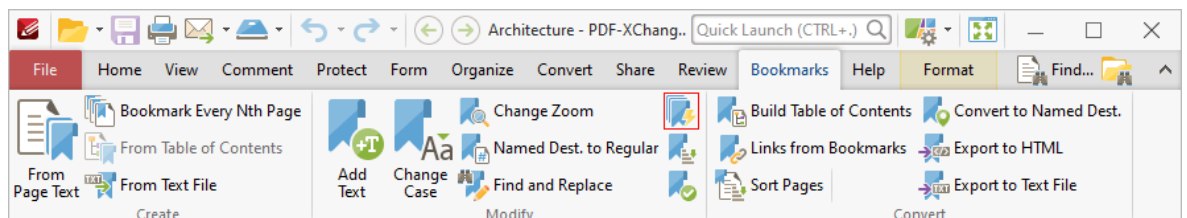

3. Follow the instructions detailed [here](#).<sup>1577</sup>

### ▼ Sort Bookmarks

1. Click the **Bookmarks** tab.
2. Click **Sort Bookmarks**:

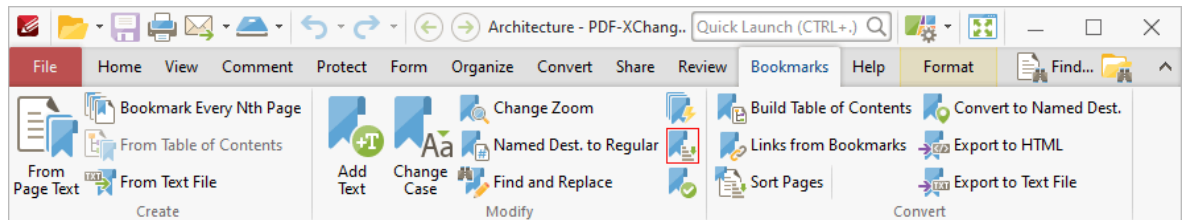

3. Follow the instructions detailed [here](#).<sup>1580</sup>

### ▼ Sort Pages by Bookmarks

1. Click the **Bookmarks** tab.
2. Click **Sort Pages**:

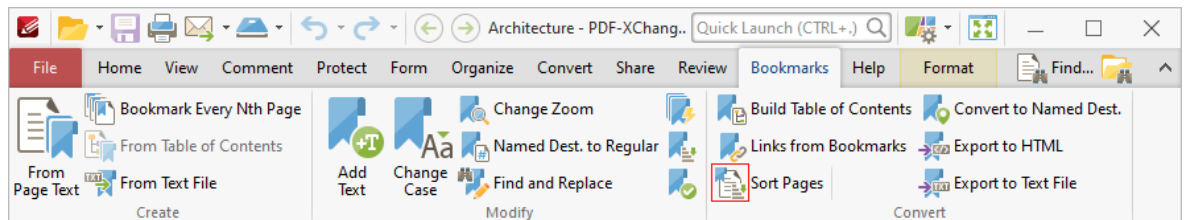

3. Follow the instructions detailed [here](#).<sup>1589</sup>

### ▼ Use Bookmarks to Create a Table of Contents

1. Click the **Bookmarks** tab.
2. Click **Build Table of Contents**:

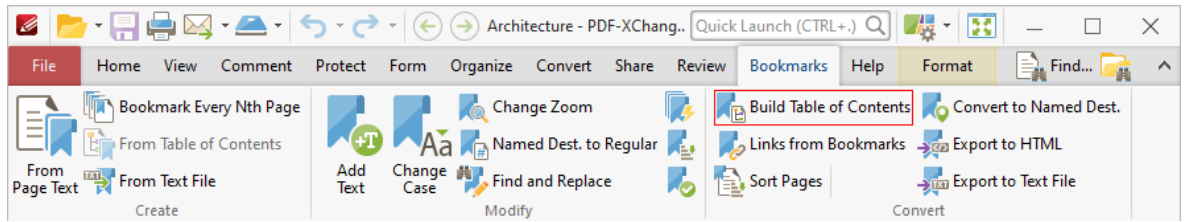

3. Follow the instructions detailed [here](#).<sup>1584</sup>

## ▼ Validate Bookmarks

1. Click the **Bookmarks** tab.
2. Click **Validate**:

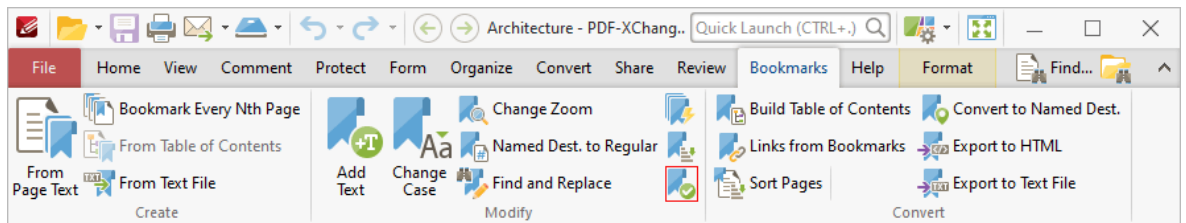

3. Follow the instructions detailed [here](#).<sup>1582</sup>

Additionally, several of the [Keyboard Shortcuts](#)<sup>1697</sup> relate to the creation and editing of bookmarks.

### 10.3.3 Document Operations Guide

---





## Document Operations Guide

---

This section of the manual contains the operations in **PDF-XChange Editor** that relate to documents:

 [Create Documents](#) <sup>[633]</sup> - a breakdown of the ways in which it is possible to create PDF documents, including how to create documents from image files, text files, RTF files, the local scanner, and how to create blank documents or create a single document from multiple input files.

 [Edit Documents](#) <sup>[643]</sup> - a breakdown of the the multiple ways in which it is possible to edit documents, including how to add dynamic features, certify documents, convert documents into various formats, restructure/crop/OCR/delete pages, manipulate base content, set document zoom, insert content, adjust document tabs, sign/validate documents, edit text and measure documents.

 [Open Documents](#) <sup>[715]</sup> - a breakdown of how to open documents located in URLs, **Dropbox**, **SharePoint**, **Google Drive** and the local computer.

 [Miscellaneous Document Operations](#) <sup>[716]</sup> - a breakdown of miscellaneous document operations, including how to add/edit JavaScript, import/export customized settings, work with named destinations and utilize sessions.

 [Save Documents](#) <sup>[735]</sup> - a breakdown of the way that documents can be saved, including how to save copies of documents, save multiple documents simultaneously and save documents to specific places such as **Dropbox**, **Google Drive** and **SharePoint**.

---



### 10.3.3.1 Create Documents

---



## Create Documents

---

**PDF-XChange Editor** can be used to create new PDF documents in multiple ways. See below for instructions on how to:

### ▼ Create Blank PDF Documents

1. Click the **File** tab.
2. Click **New Document**, then click **With Blank Pages**:

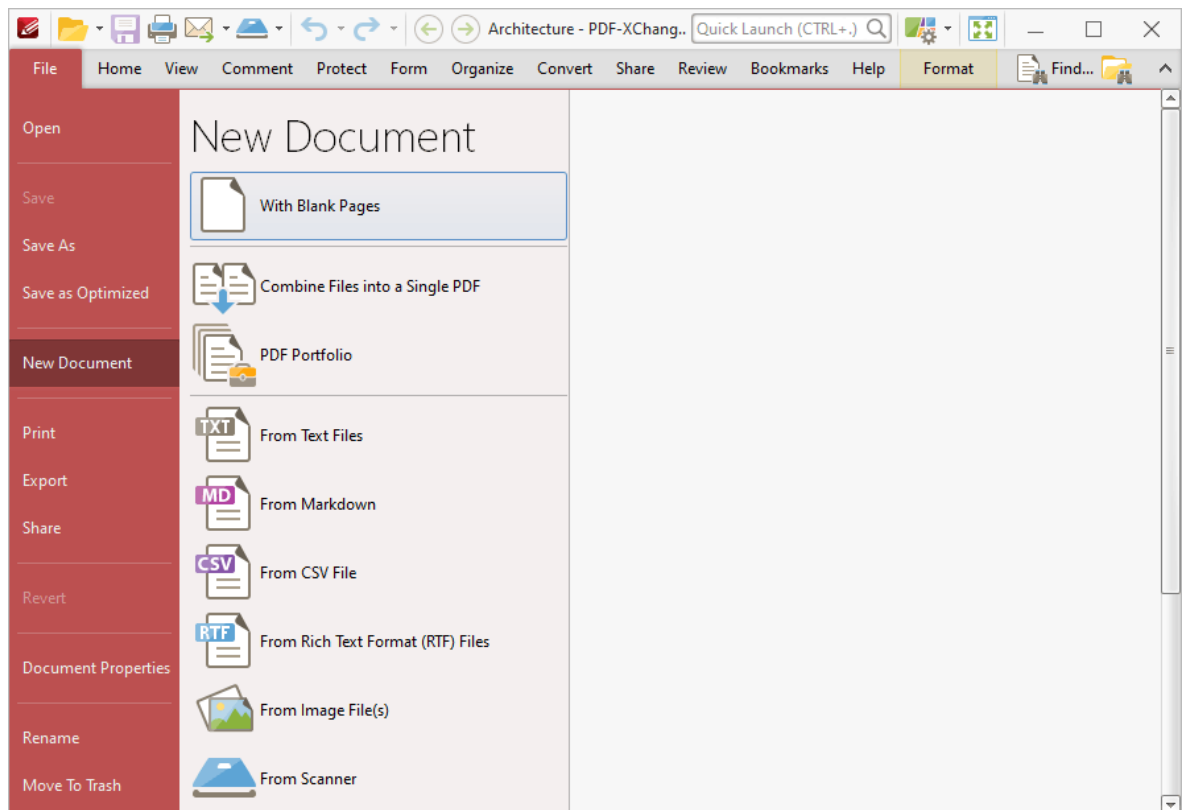

The **New Empty Document** dialog box will open:

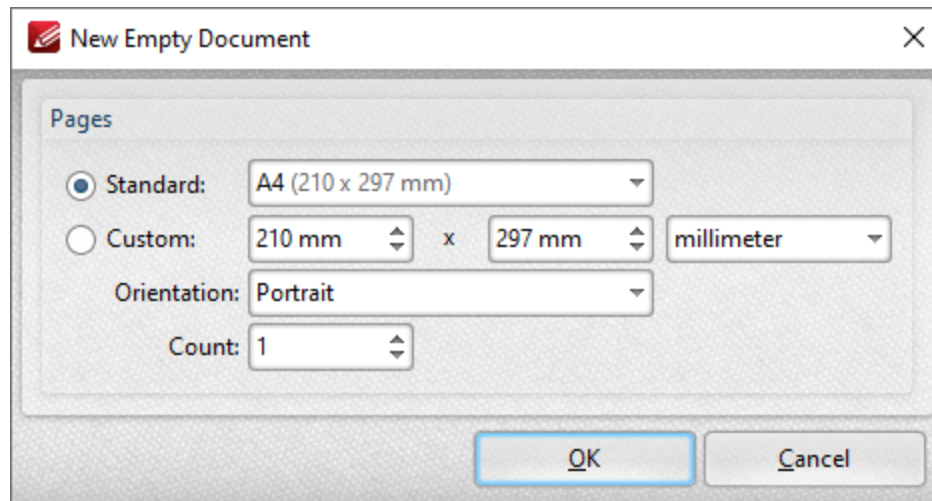

3. Determine parameters as detailed [here](#).<sup>797</sup>

4. Click **OK**.

The keyboard shortcut for this operation is Ctrl+N.

#### ▼ **Create PDF Documents from Image Files**

1. Click the **File** tab.

2. Click **New Document**, then click **From Image File(s)**:

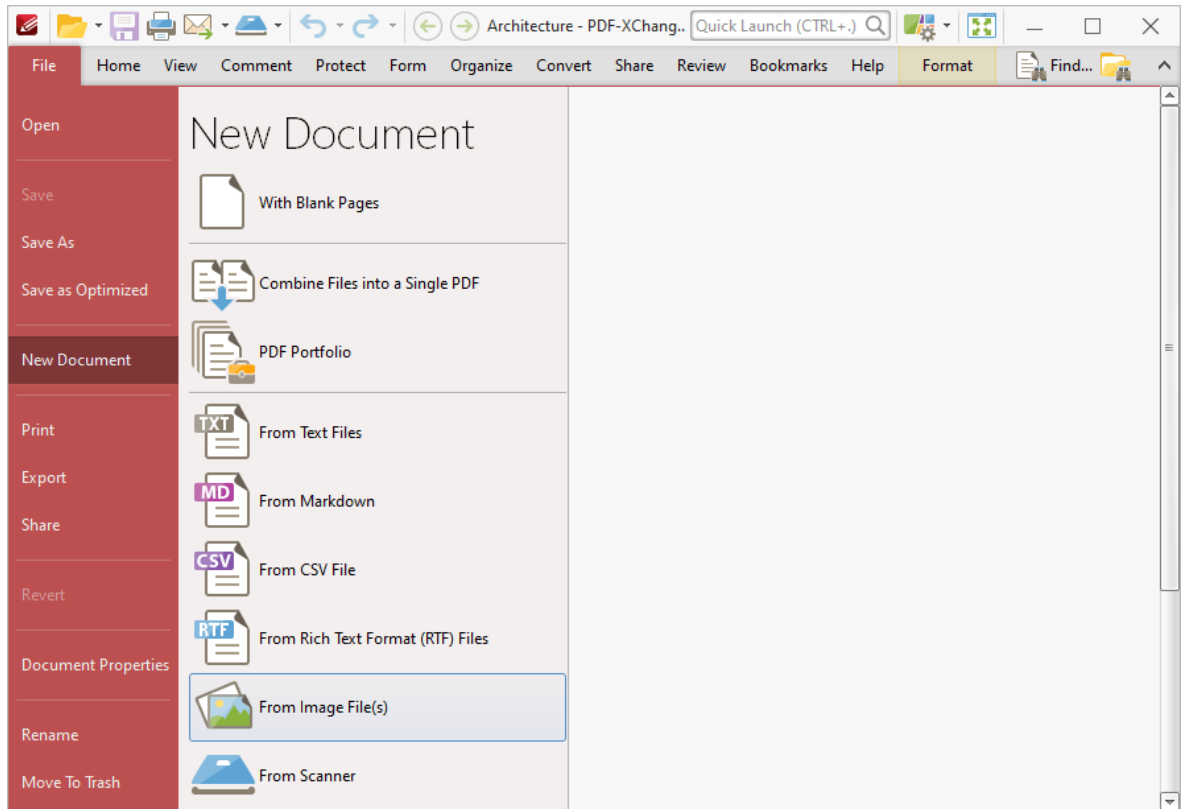

The **Image To PDF** dialog box will open:

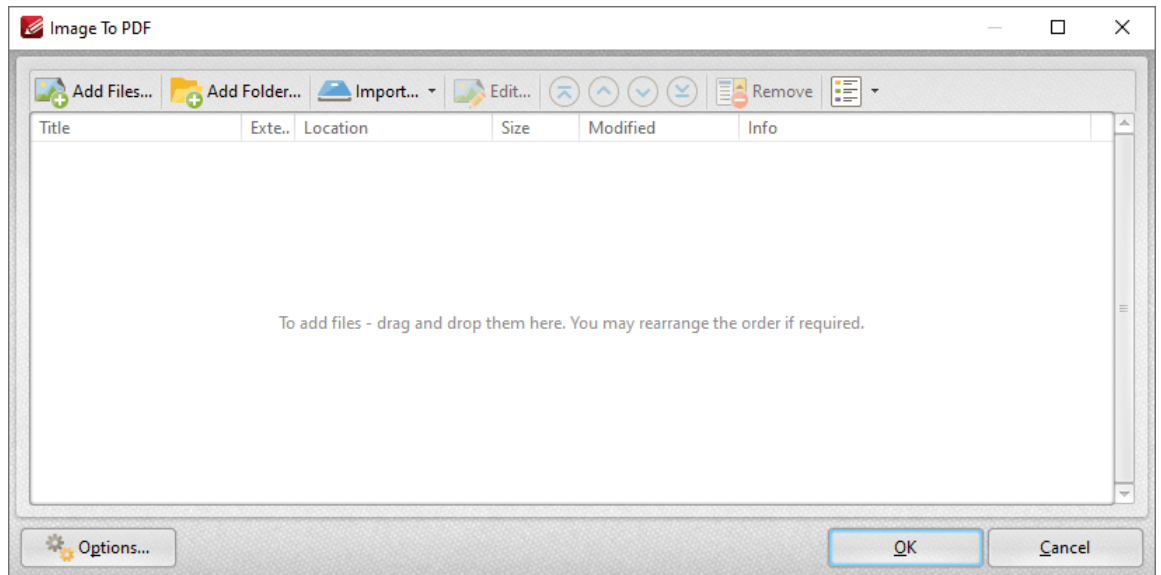

3. Determine parameters as detailed [here](#).<sup>819</sup>

4. Click **OK**.

## ▼ Create PDF Documents from Multiple Files

1. Click the **File** tab.
2. Click **New Document**, then click **Combine Files into a Single PDF**:

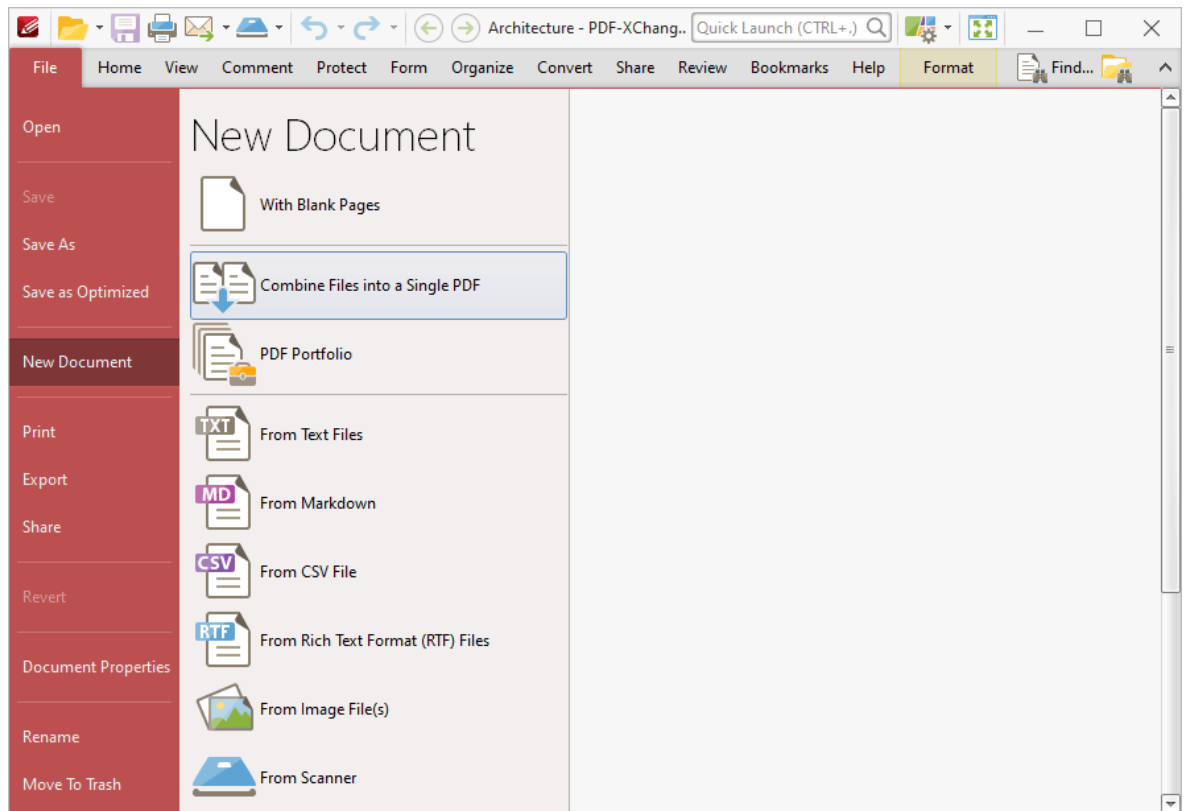

The **Combine Files** dialog box will open:

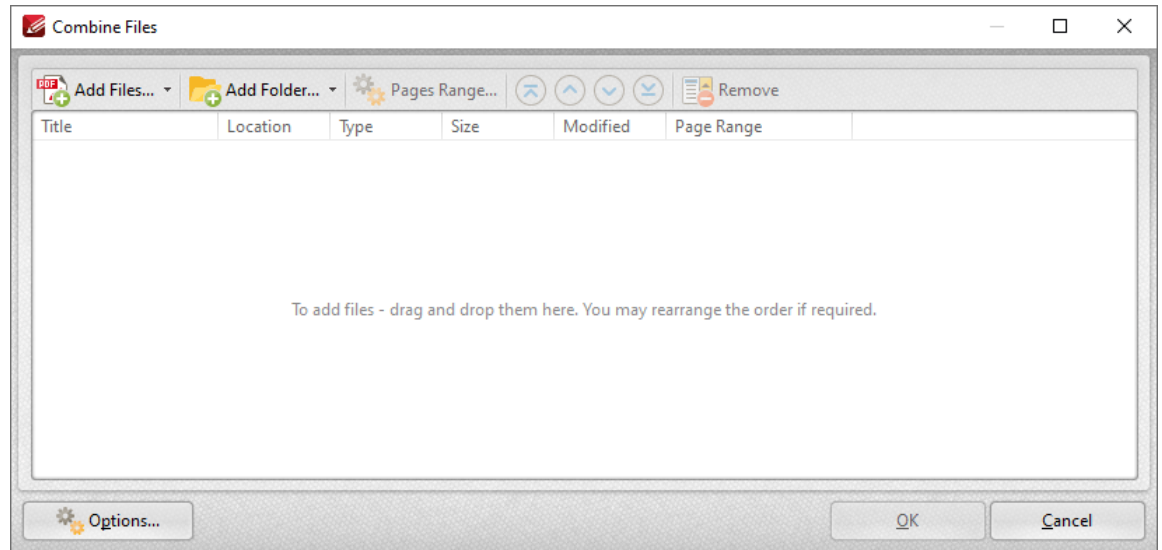

3. Determine parameters as detailed [here](#).

4. Click **OK**.

#### ▼ Create PDF Documents From Text Files

1. Click the **File** tab.

2. Click **New Document**, then click **From Text Files**:

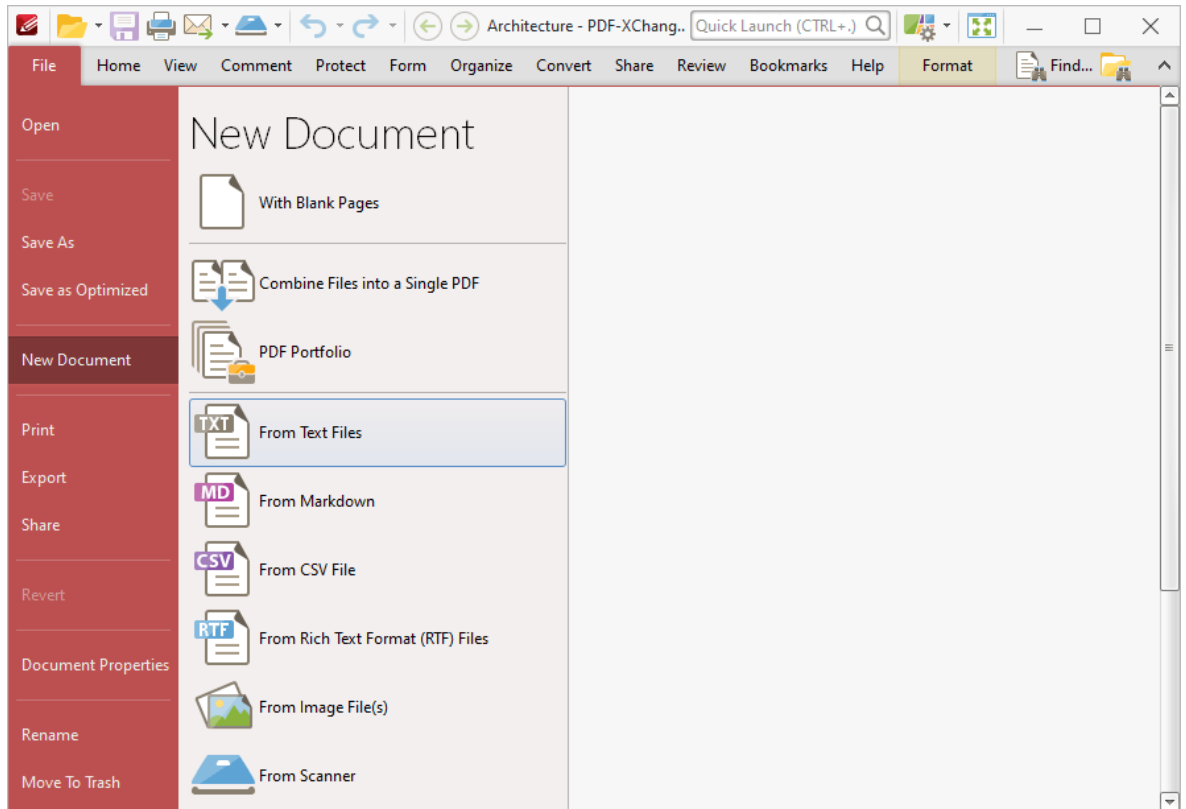

The **Convert Text Files to PDF** dialog box will open:

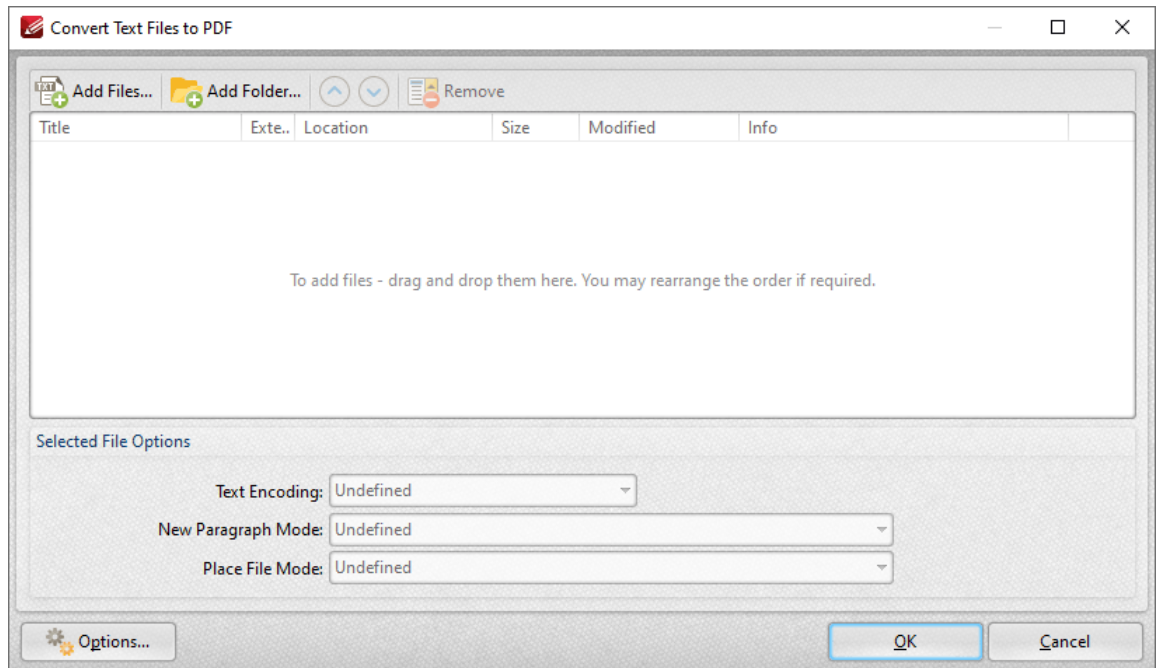

3. Determine parameters as detailed [here](#).<sup>807</sup>

4. Click **OK**.

#### ▼ Create PDF Documents from the Local Scanner

1. Click the **File** tab.
2. Click **New Document**, then click **From Scanner**.

The following options are then available:

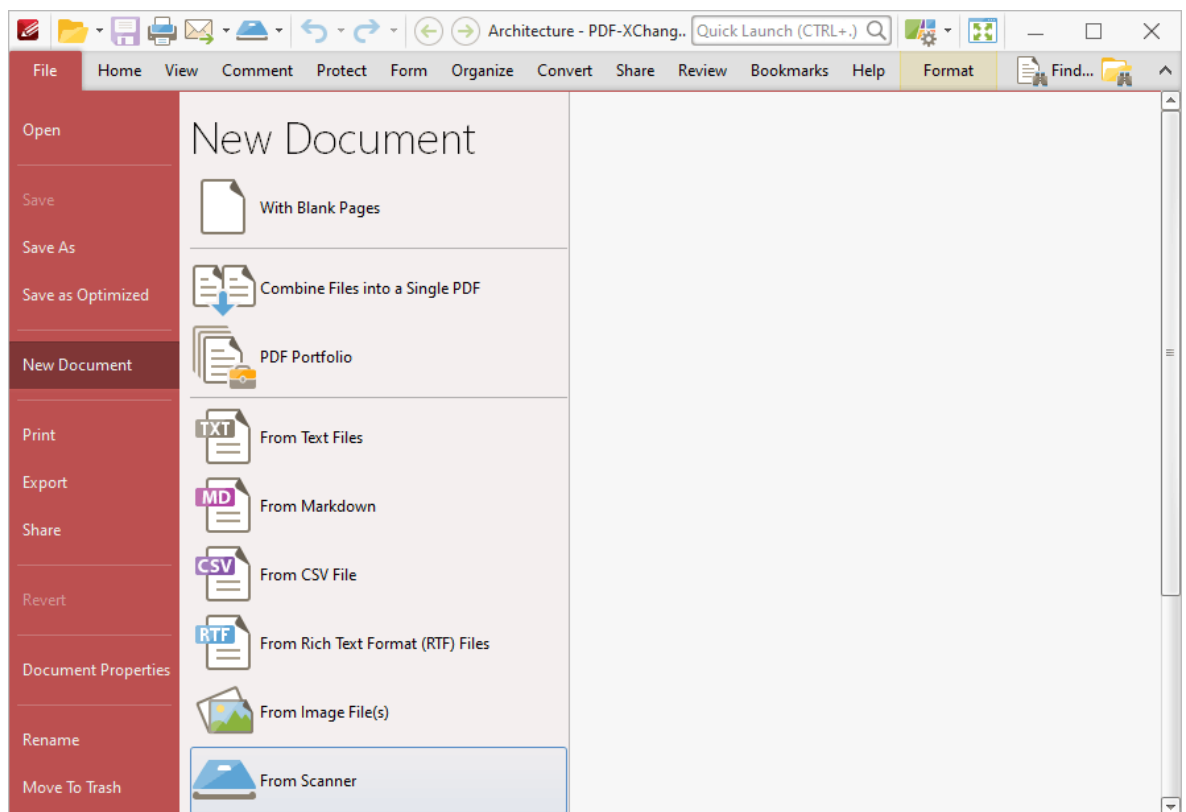

3. Click a preset mode as desired, or click **Custom Scan**.
4. Determine parameters and initiate the scan as detailed [here](#).<sup>829</sup>

#### ▼ Create PDF Documents from RTF Files

1. Click the **File** tab.
2. Click **New Document**, then click **From Rich Text Format (RTF) Files**:

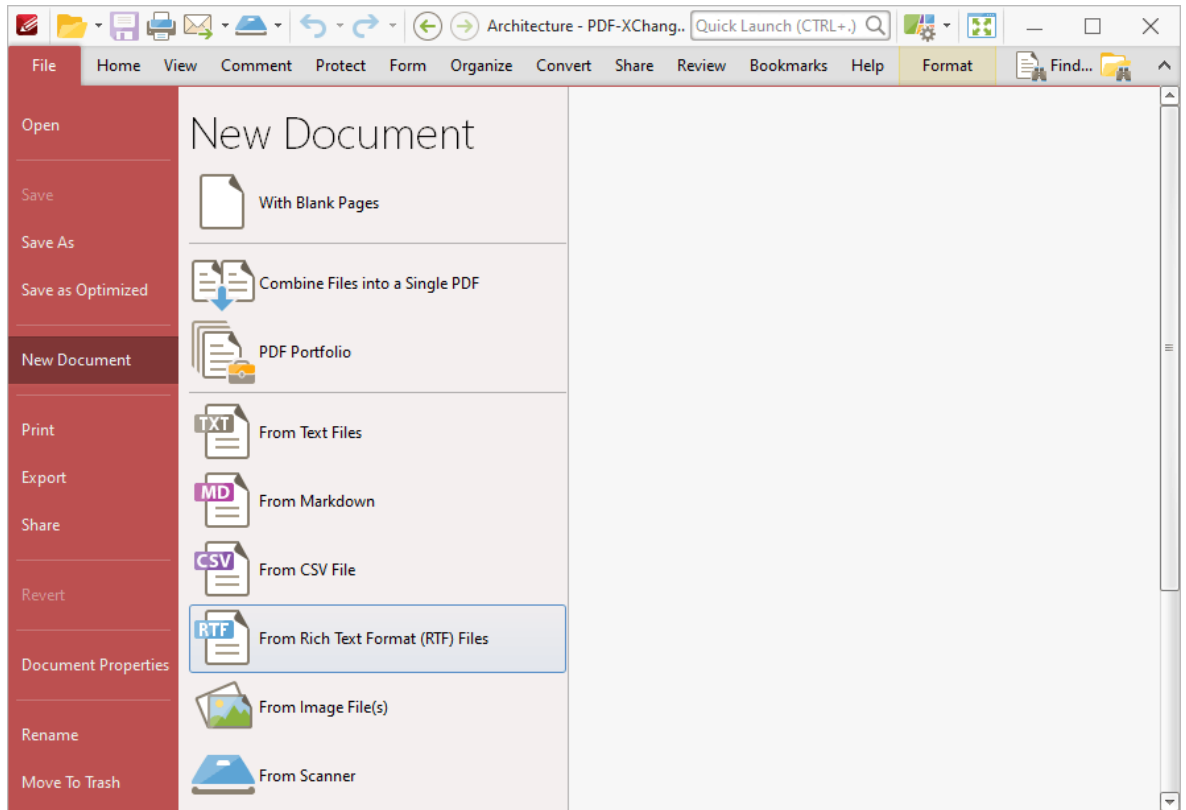

The **Convert RTF Files To PDF** dialog box will open:

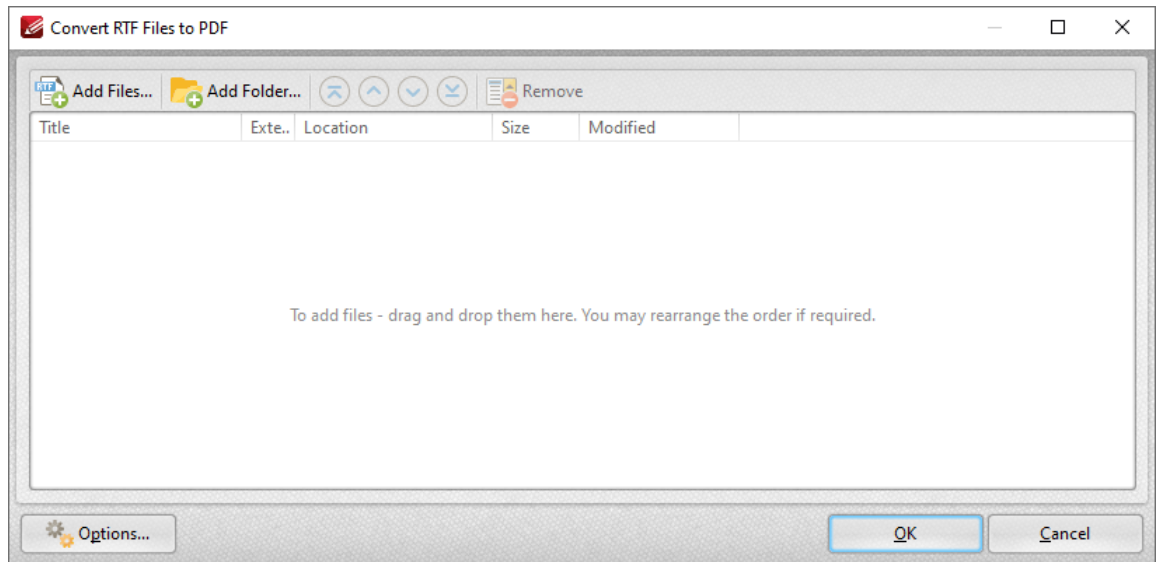

3. Determine parameters as detailed [here](#).<sup>816</sup>

4. Click **OK**.



### ▼ Create PDF Portfolio Files

1. Click the **File** tab.
2. Click **New Document**, then click **PDF Portfolio**:

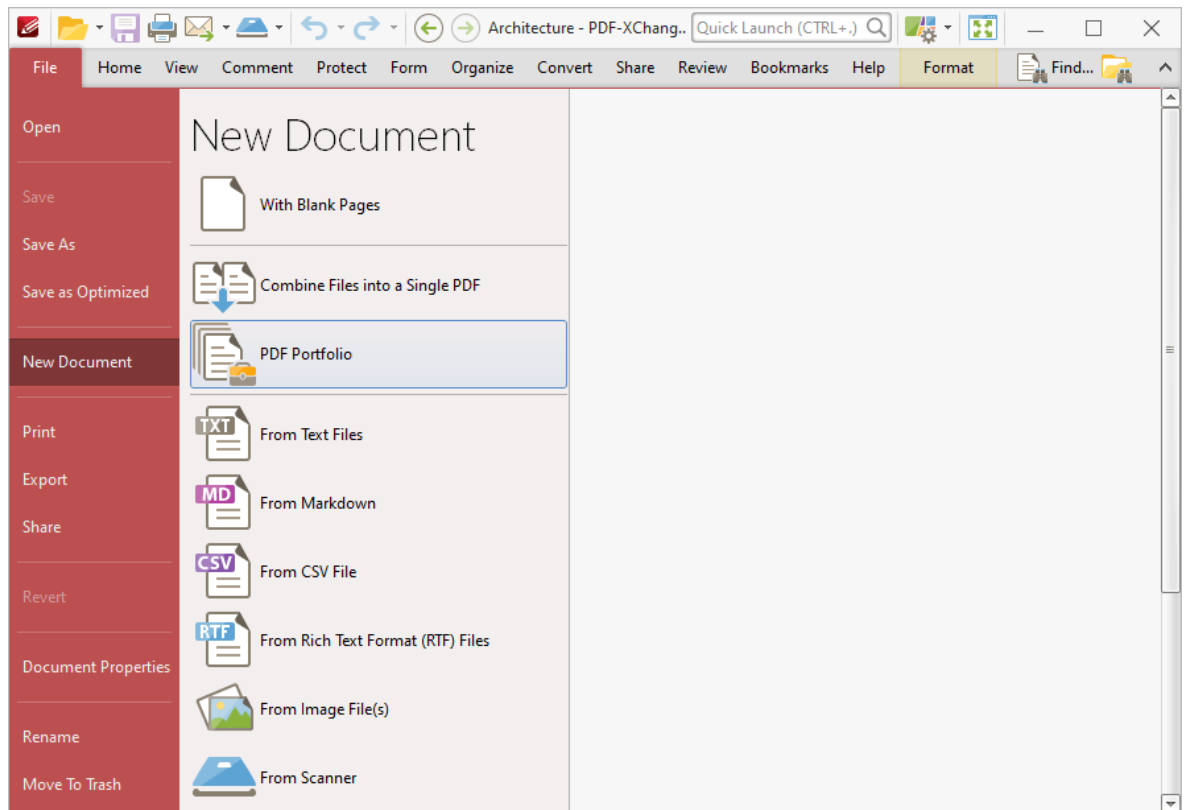

The **Convert Create PDF Portfolio** dialog box will open:

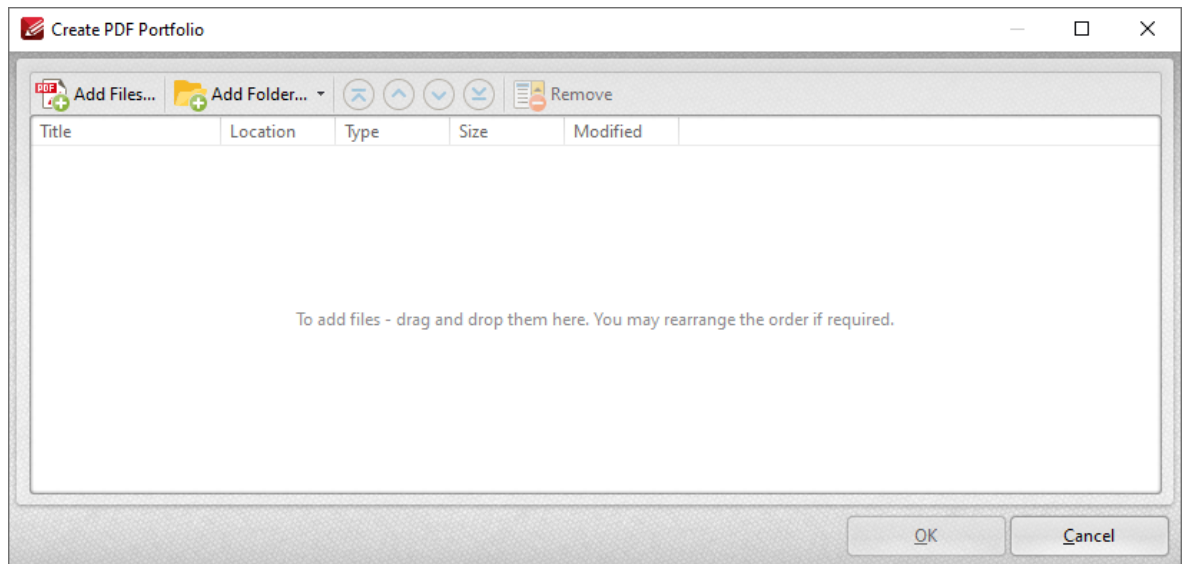

3. Determine parameters as detailed [here](#).<sup>803</sup>

4. Click **OK**.

---

### 10.3.3.2 Edit Documents



## Edit Documents

**PDF-XChange Editor** can be used to edit documents in multiple ways. See below for instructions on how to:

#### ▼ Add Backgrounds to Documents

1. Click the **Organize** tab.
2. Click **Background**, then click **Add**:

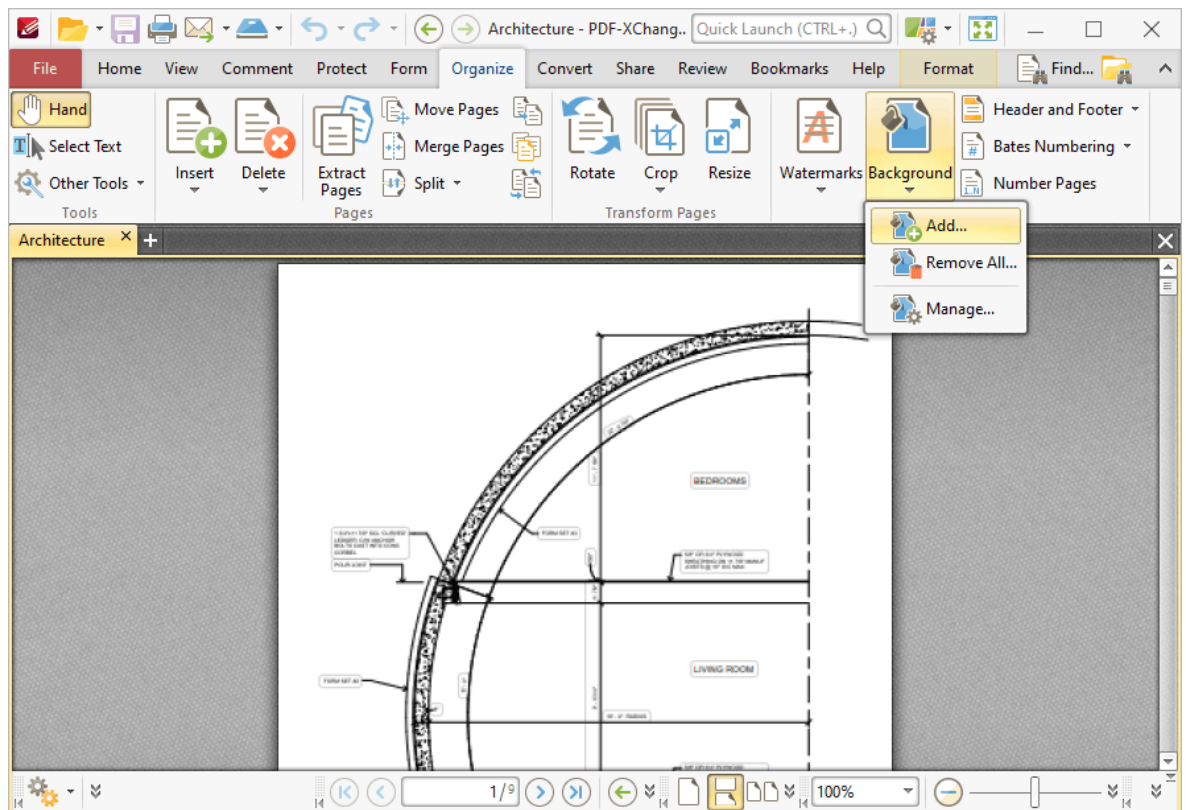

The **Add Background** dialog box will open.

3. Determine parameters as detailed [here](#).
4. Click **OK**.

### ▼ Add Barcodes to Documents

Barcodes are an established standard for the concise storage of complex information. They are compatible with most smartphones and tablets and have several useful templates, such as electronic business cards that can be used for contact details and other personal information. They can also be used to link to URLs, create custom messages and send automatic emails. Follow the steps below to add barcodes to documents:

1. Click the **Home** tab.
2. Click **Add**, then click **Add Barcode**:

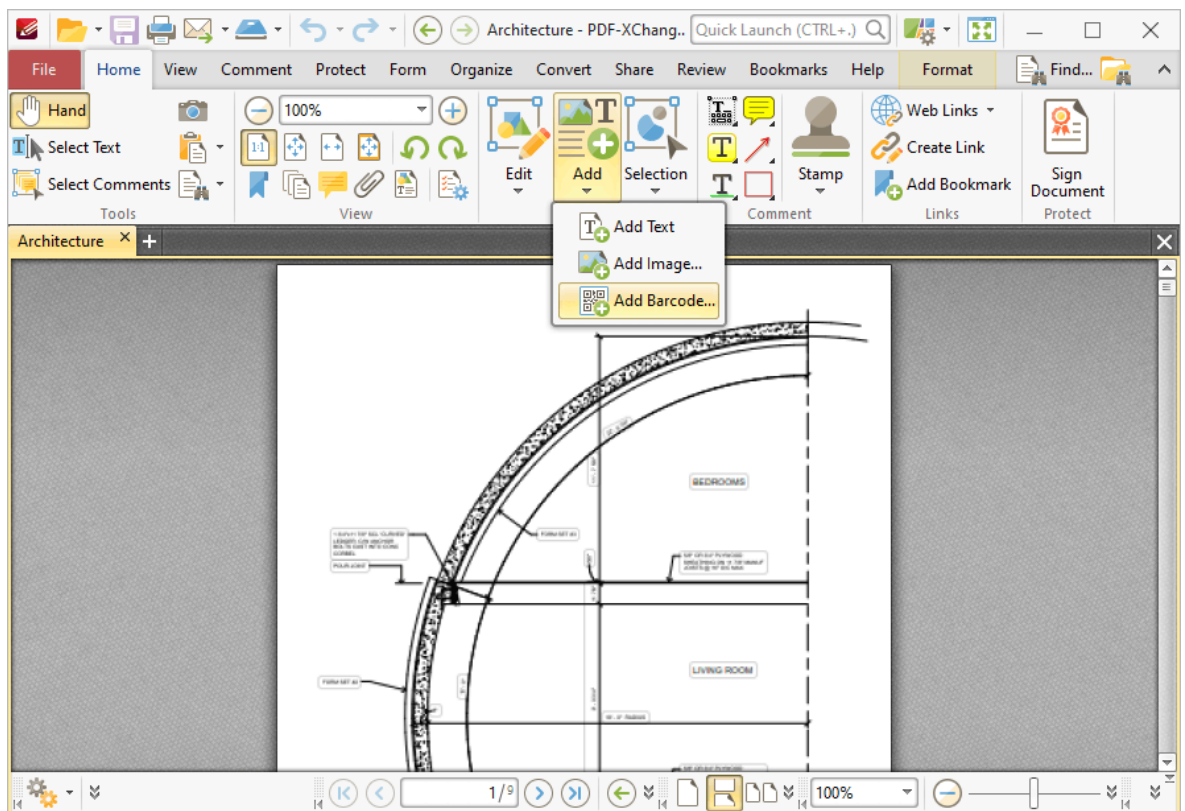

The **Select Barcode Placement Tool** dialog box will open.

3. Click **Drag Barcode Rectangle**.
4. Drag the pointer to determine the size and location of the barcode.

5. Determine parameters as detailed [here](#).

6. Click **Place**.

### ▼ Add Bates Numbering to Documents

Bates numbering is a dynamic way to provide identification, protection and automatic consecutive numbering within documents as they are processed/scanned. Follow the instructions below to add Bates numbering:

1. Click the **Organize** tab.
2. Click **Bates Numbering**, then click **Add**:

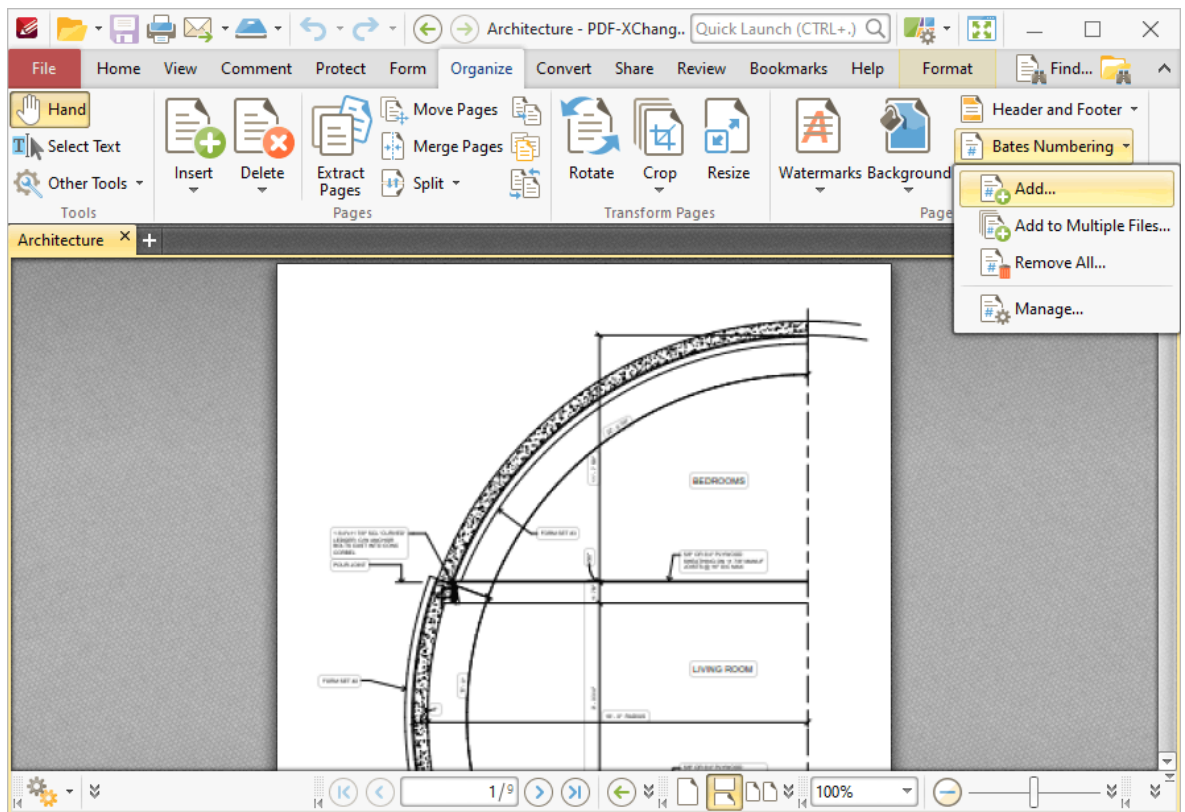

The **Add Bates Numbering** dialog box will open.

3. Determine parameters as detailed [here](#).
4. Click **OK**.

### ▼ Add Bates Numbering to Multiple Documents

Bates numbering is a dynamic way to provide identification, protection and automatic consecutive numbering within documents as they are processed/scanned. Follow the instructions below to add Bates numbering to multiple documents:

1. Click the **Organize** tab.
2. Click **Bates Numbering**, then click **Add to Multiple Files**:

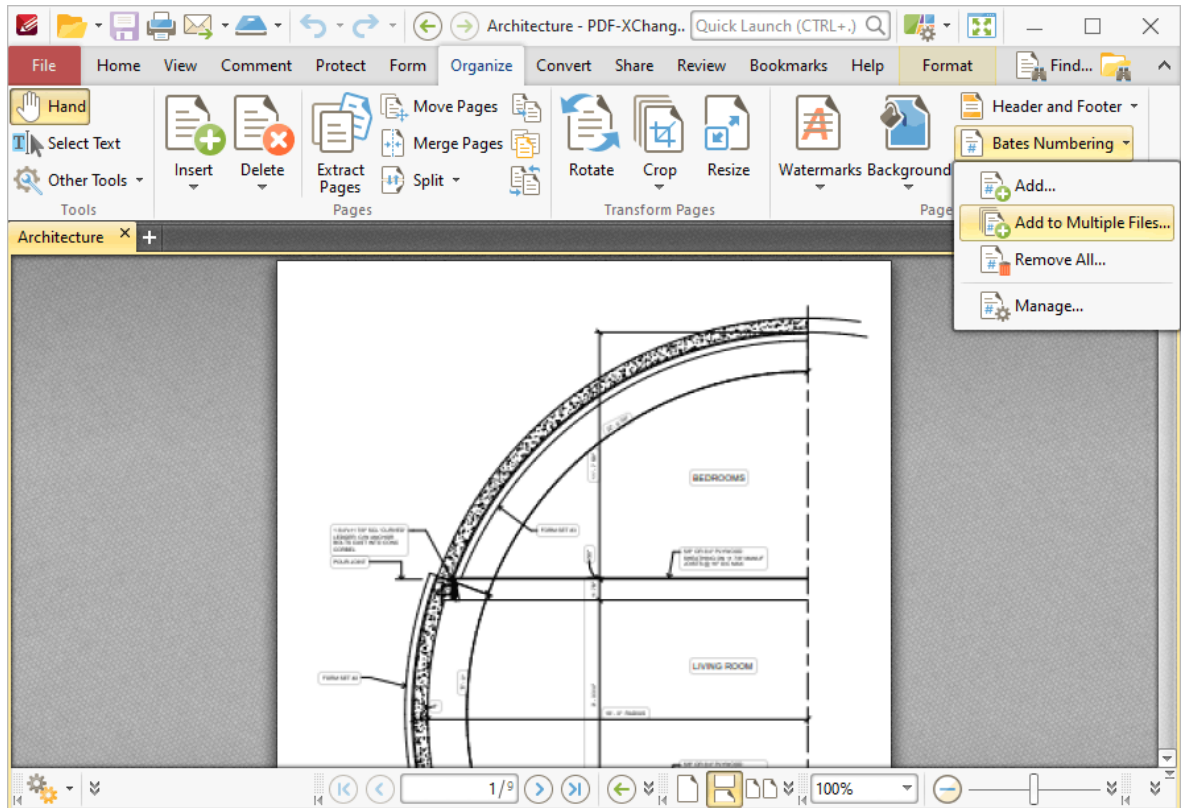

The **Add Bates Numbering** dialog box will open.

3. Determine parameters as detailed [here](#).
4. Click **OK**.

#### ▼ Add Headers and Footers to Documents

Headers and footers are a useful way to add additional information at the top/bottom of documents, such as page numbers and/or the current date. Follow the steps below to add headers and footers to documents:

1. Click the **Organize** tab.
2. Click **Header and Footer**, then click **Add**:

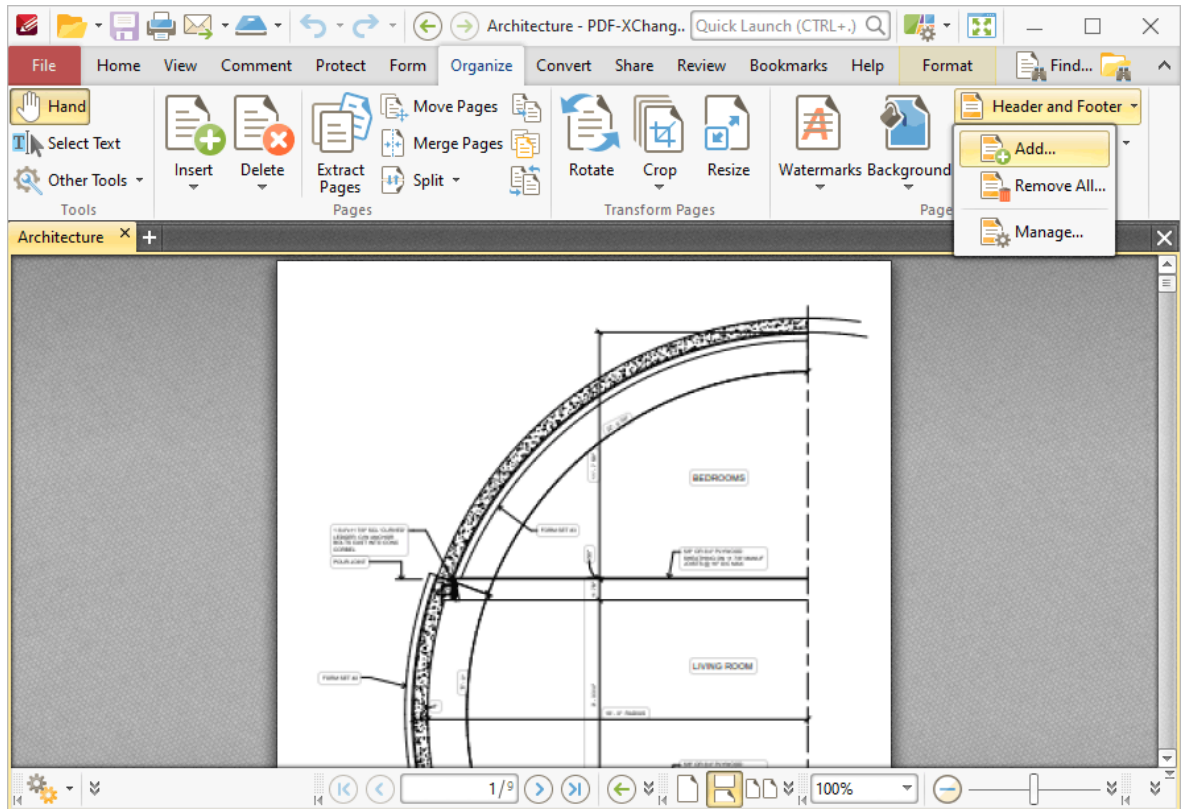

The **Add Header and Footer** dialog box will open.

3. Determine parameters as detailed [here](#).<sup>1497</sup>

4. Click **OK**.

#### ▼ Add Images to Documents

1. Click the **Home** tab.

2. Click **Add**, then click **Add Image**:



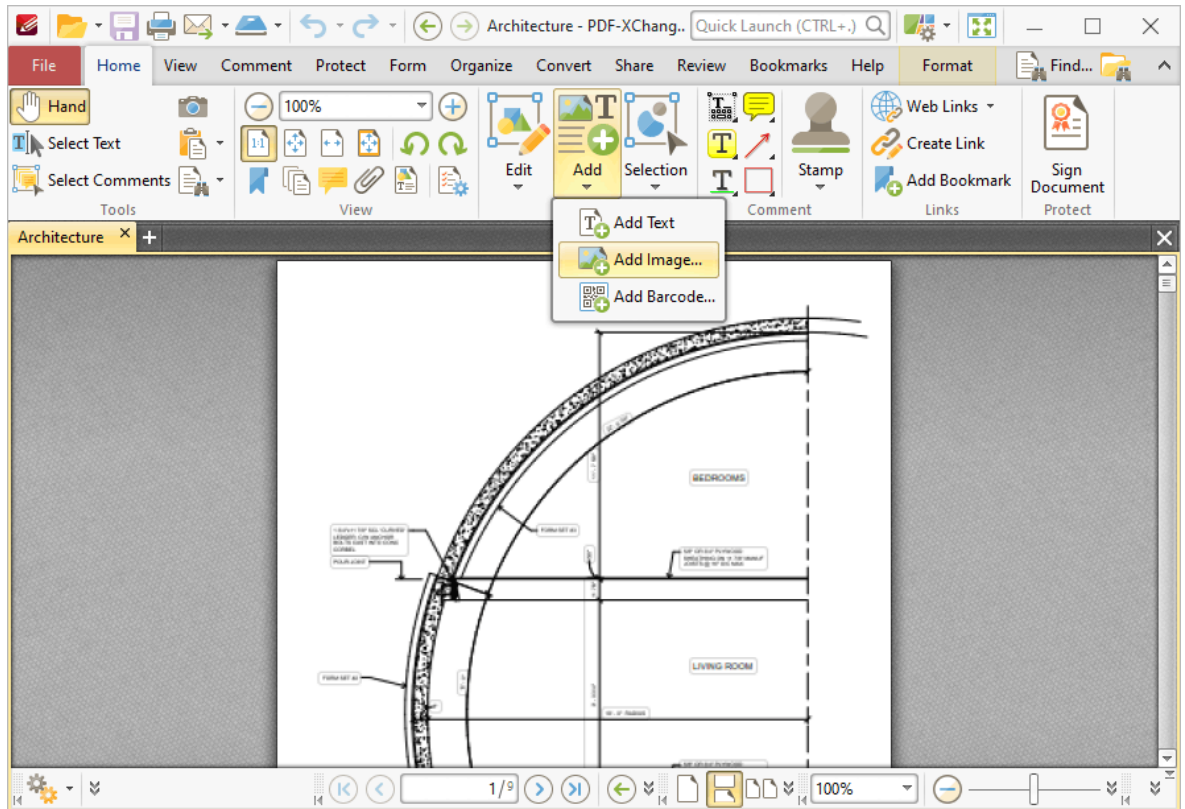

The **Open Files** dialog box will open.

3. Select the desired image and click **Open**.

The **Add Image** dialog box will open.

4. Determine parameters as detailed [here](#).

5. Click **Place**.

#### ▼ **Add Watermarks to Documents**

Watermarks are used to discourage counterfeiting and to display ownership of images and documentation. Follow the steps below to add watermarks to documents:

1. Click the **Organize** tab.

2. Click **Watermarks**, then click **Add**:

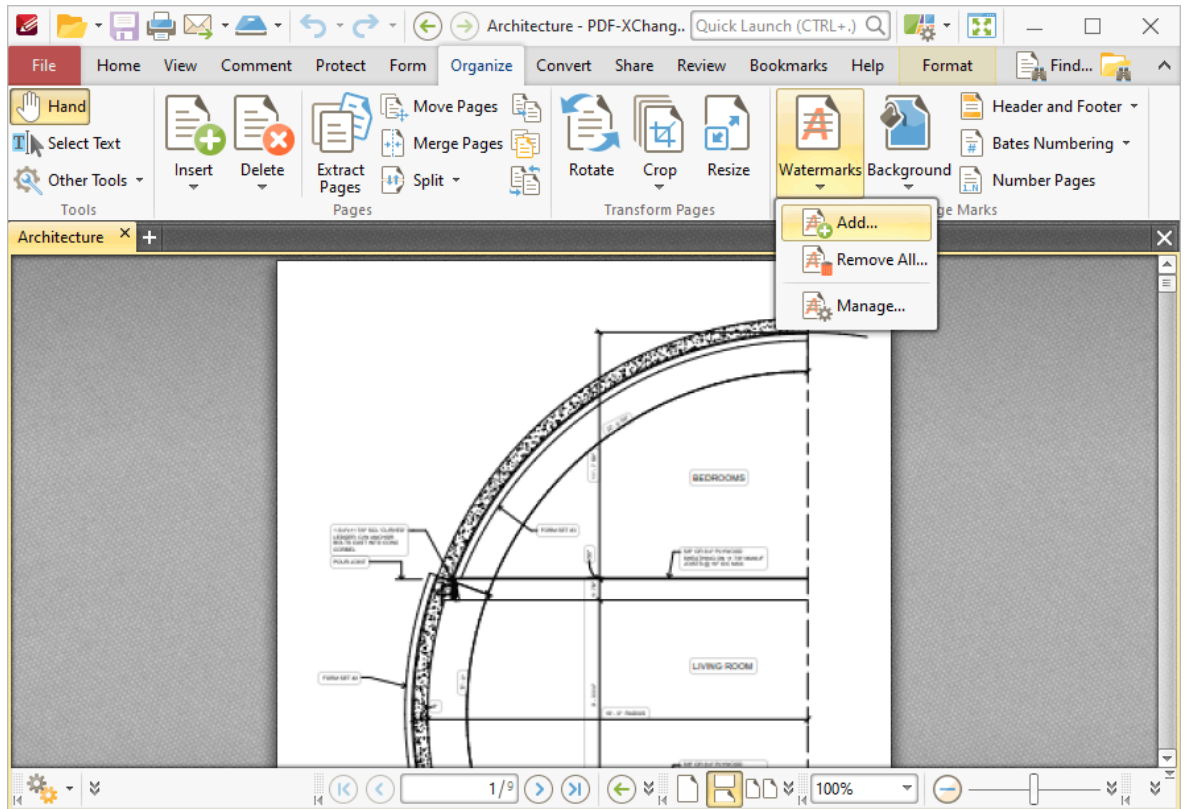

The **Add Watermark** dialog box will open.

3. Determine parameters as detailed [here](#).<sup>1491</sup>

4. Click **OK**.

### ▼ **Certify Documents and Add an Invisible Signature**

Digital signatures are used to demonstrate the authenticity of documents and increase their security. Follow the instructions below to certify documents and add an invisible digital signature. (The inclusion of an *invisible* digital signature means that the document will not feature a physical signature, but it is still 'signed' and certified to the same level as a document that features a physical signature).

1. Click the **Protect** tab.

2. Click **Certify (Invisible)**:

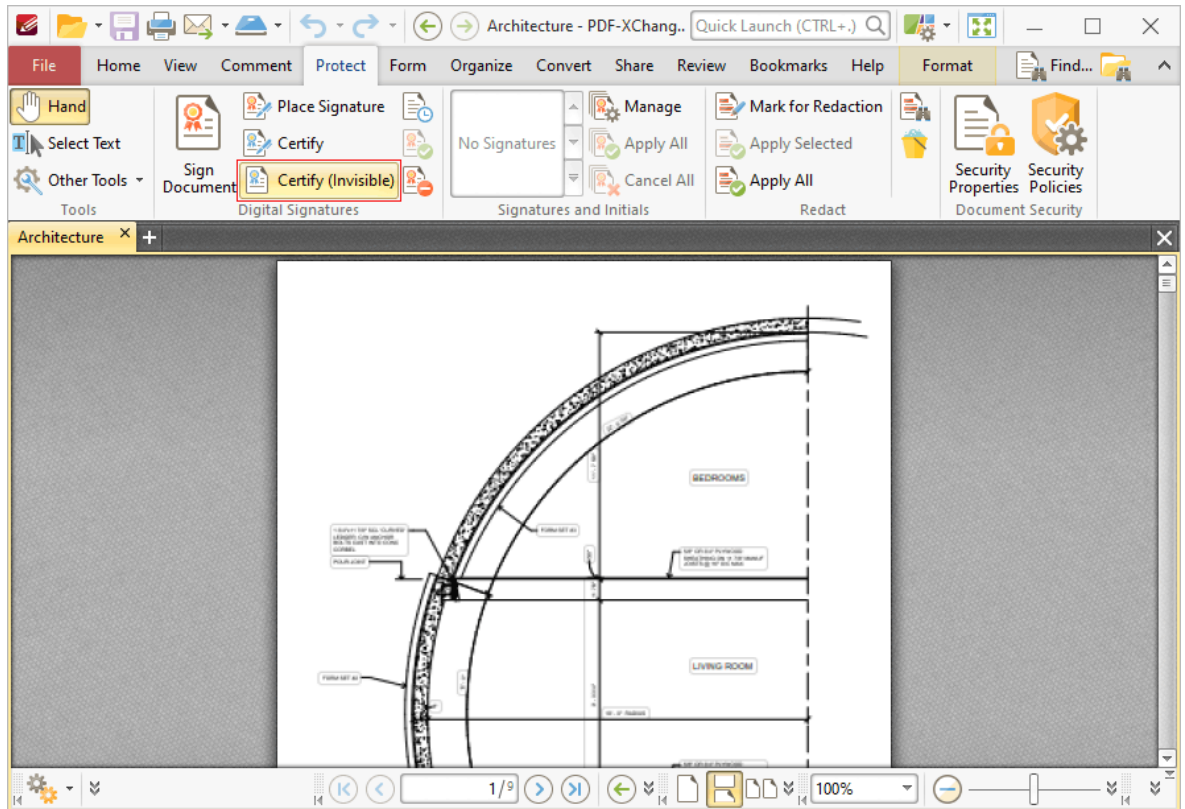

The **Certify Document (Invisible)** dialog box will open.

3. Follow the instructions detailed [here](#).

### ▼ Certify Documents and Add a Visible Signature

Digital signatures are used to demonstrate the authenticity of documents and increase their security. Follow the instructions below to certify documents and add a visible digital signature:

1. Click the **Protect** tab.
2. Click **Certify**:

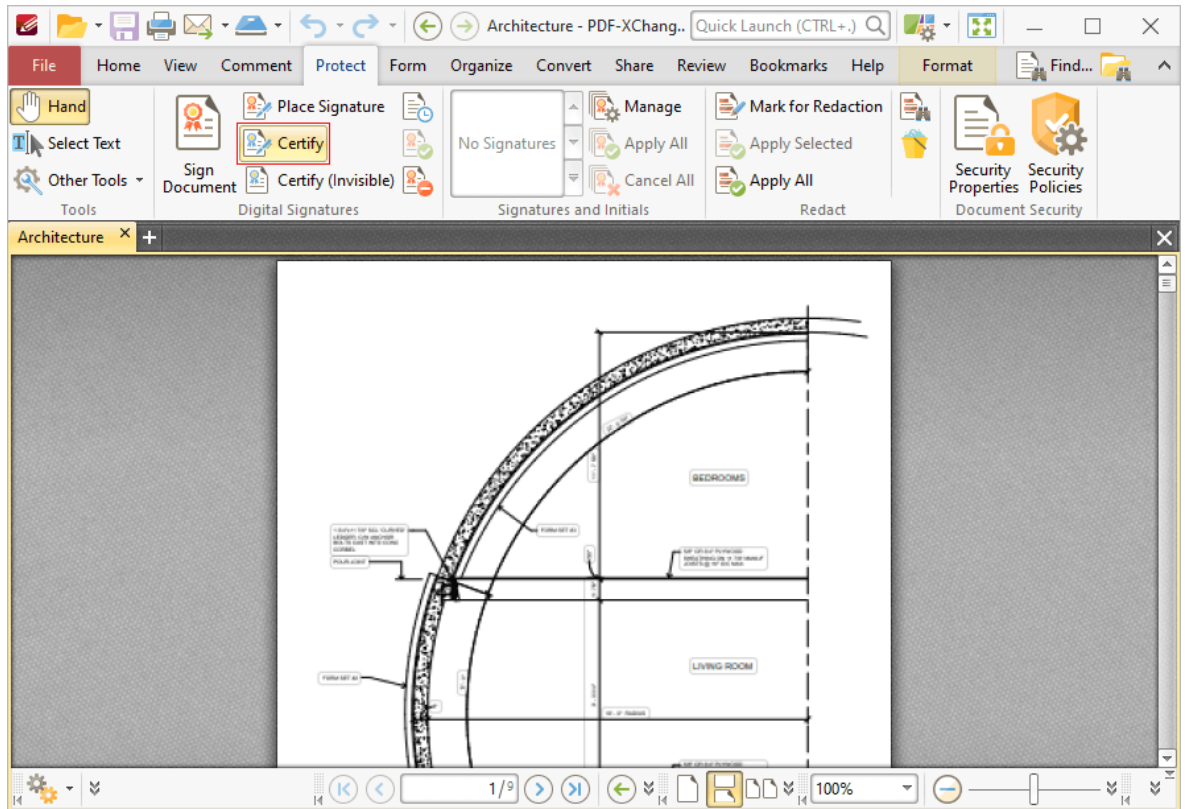

3. Follow the instructions detailed [here](#).<sup>1248</sup>

### ▼ Check Document Spelling

1. Click the **Review** tab.
2. Click **Spell Check**:

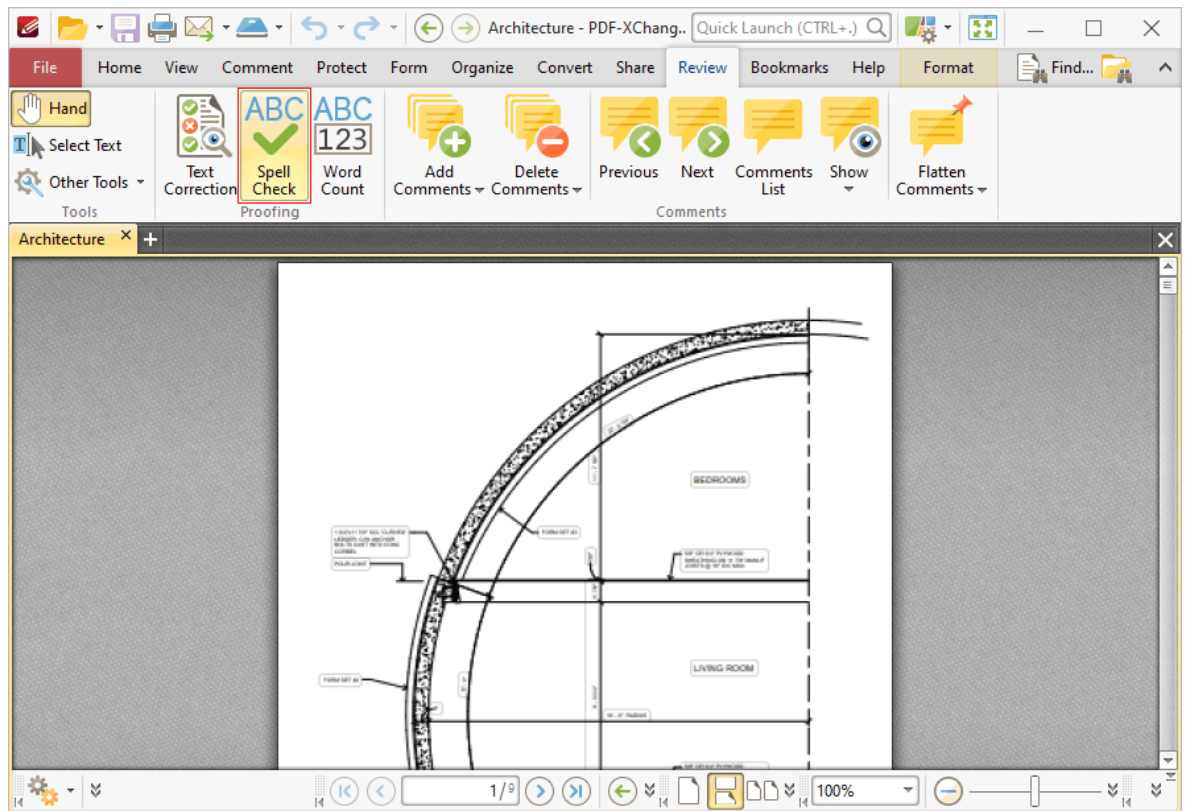

The **Spell Check** pane will open and **PDF-XChange Editor** will check the document spelling. Further information on spell check settings is available [here](#).<sup>1545</sup>

The keyboard shortcut for this operation is F7.

#### ▼ **Clear All Document Signatures**

1. Click the **Protect** tab.
2. Click **Clear All Signatures**:

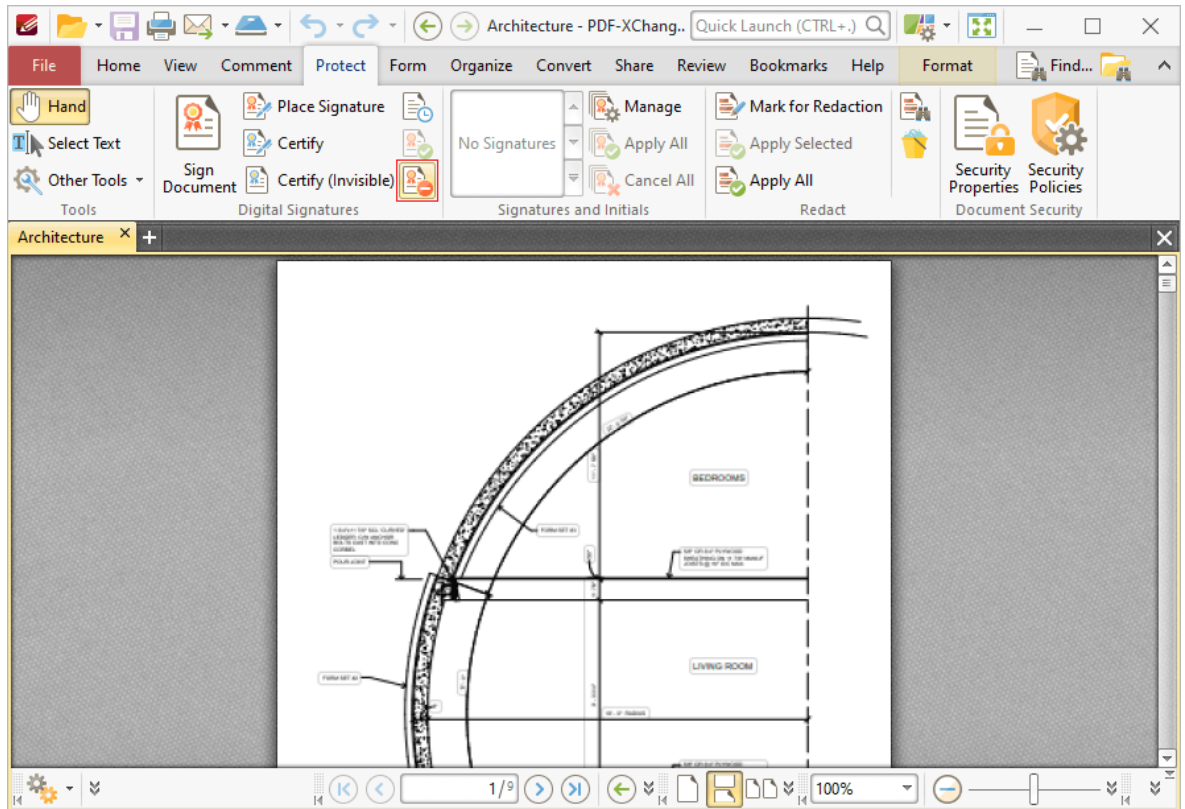

### ▼ Convert Documents to Image Format

1. Click the **File** tab.
2. Click **Export**, then click **Export to Image(s)**:

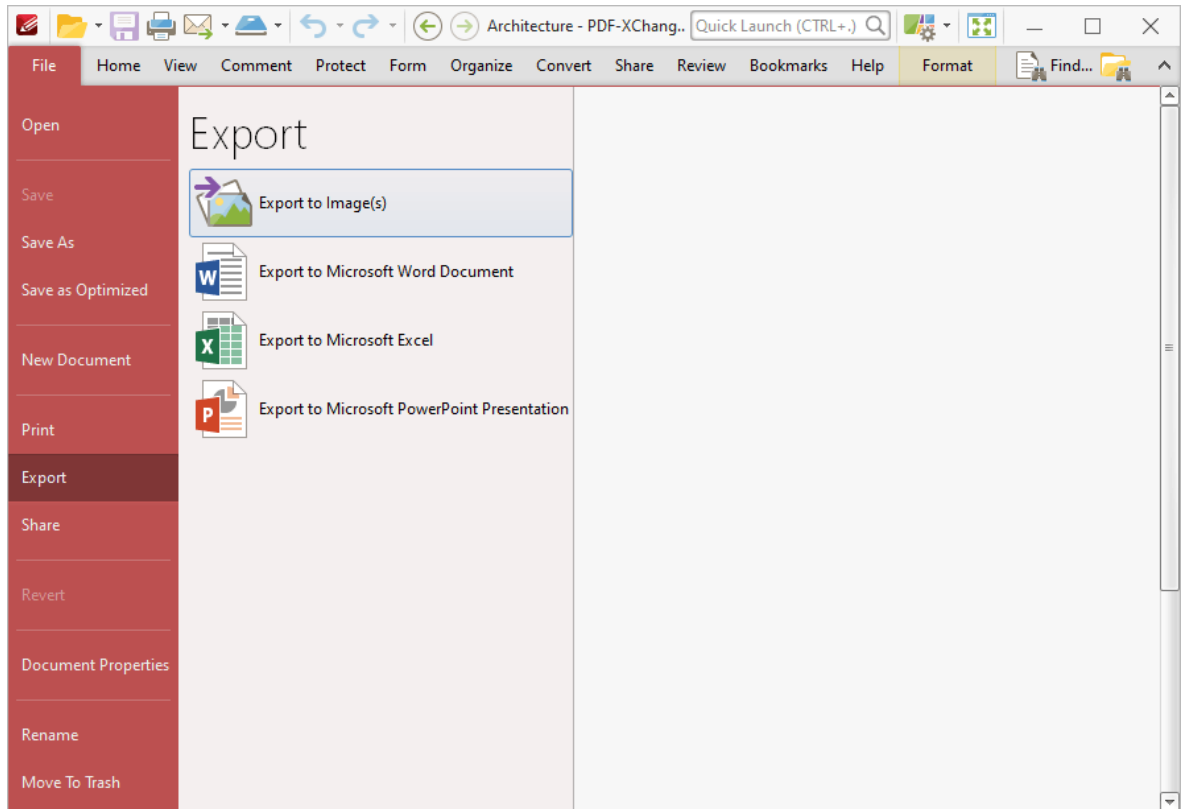

The **Export to Images** dialog box will open.

3. Determine parameters as detailed [here](#).

4. Click **OK**.

#### ▼ **Convert Documents to Microsoft Excel Format**

1. Click the **File** tab.

2. Click **Export**, then click **Export to Microsoft Excel**:

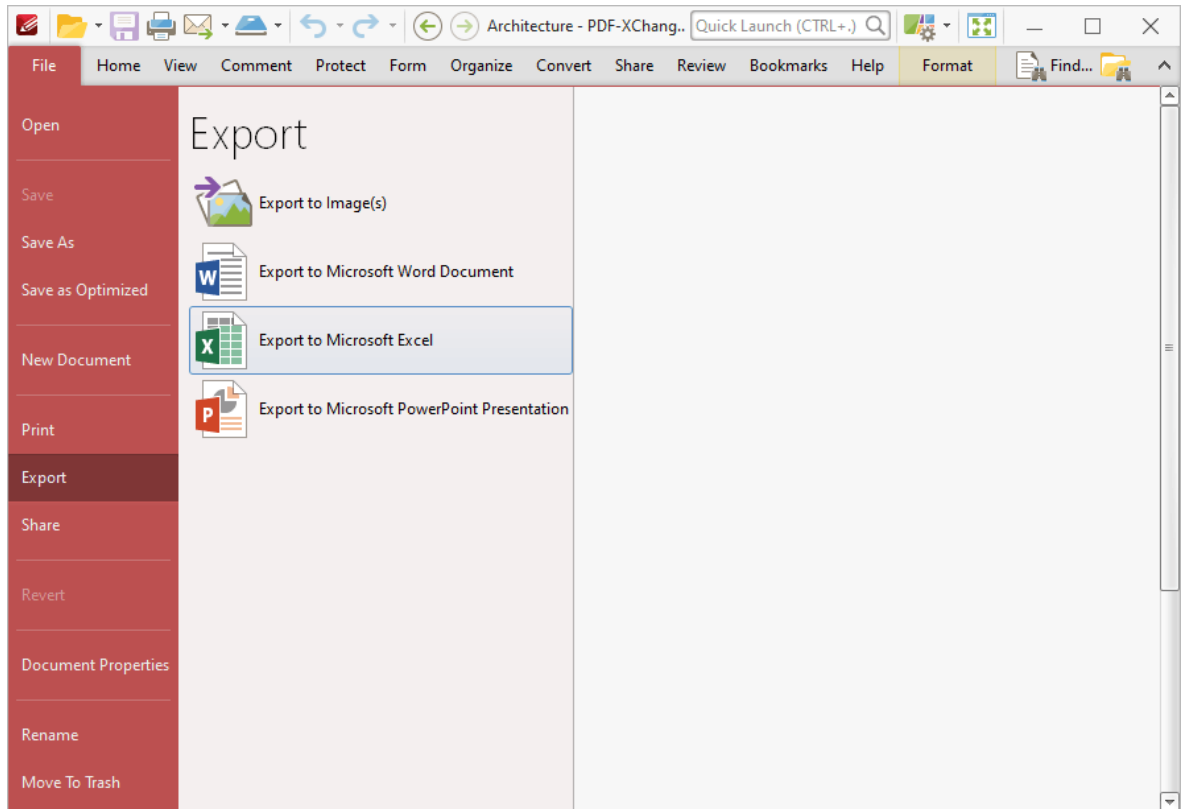

The **Save File** dialog box will open.

3. Enter the desired name for the converted document in the **File name** text box.
4. Click **OK**.

#### ▼ **Convert Documents to Microsoft Powerpoint Format**

1. Click the **File** tab.
2. Click **Export**, then click **Export to Microsoft Powerpoint Presentation**:



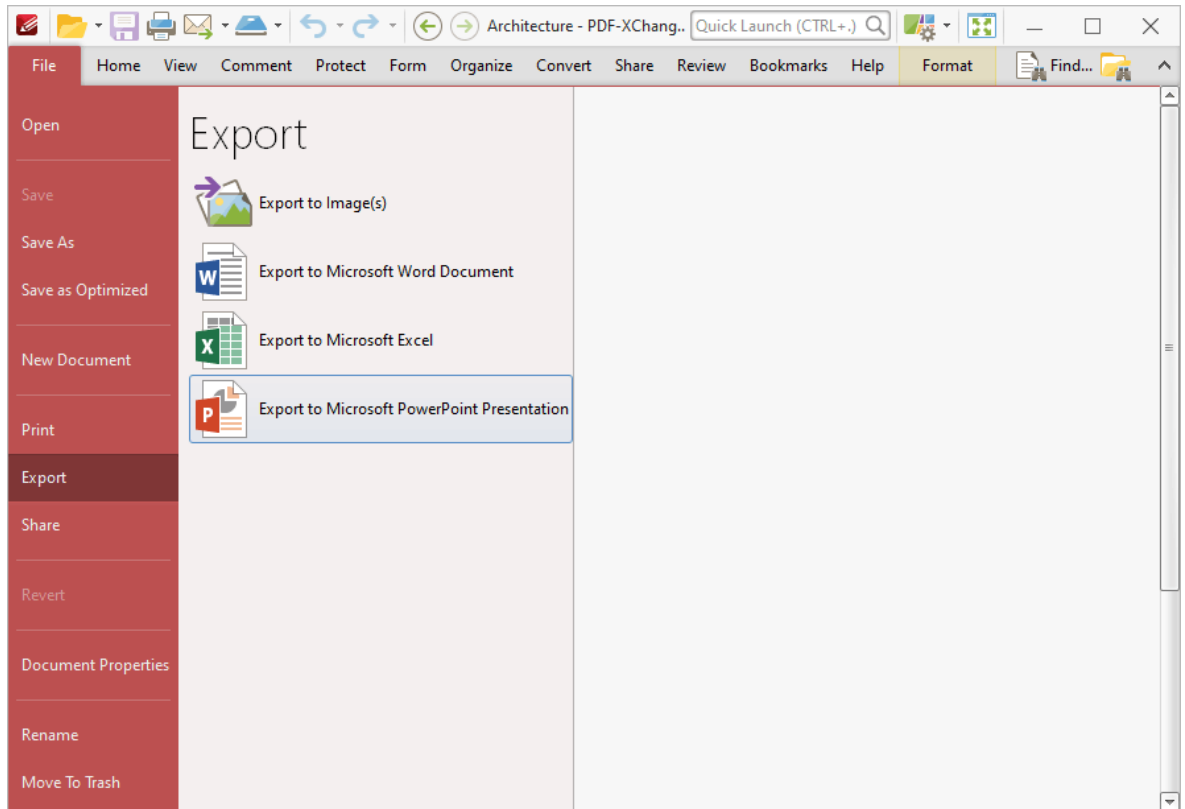

The **Save File** dialog box will open.

3. Enter the desired name for the converted document in the **File name** text box.
4. Click **OK**.

#### ▼ **Convert Documents to Microsoft Word Format**

1. Click the **File** tab.
2. Click **Export**, then click **Export to Microsoft Word Document**:

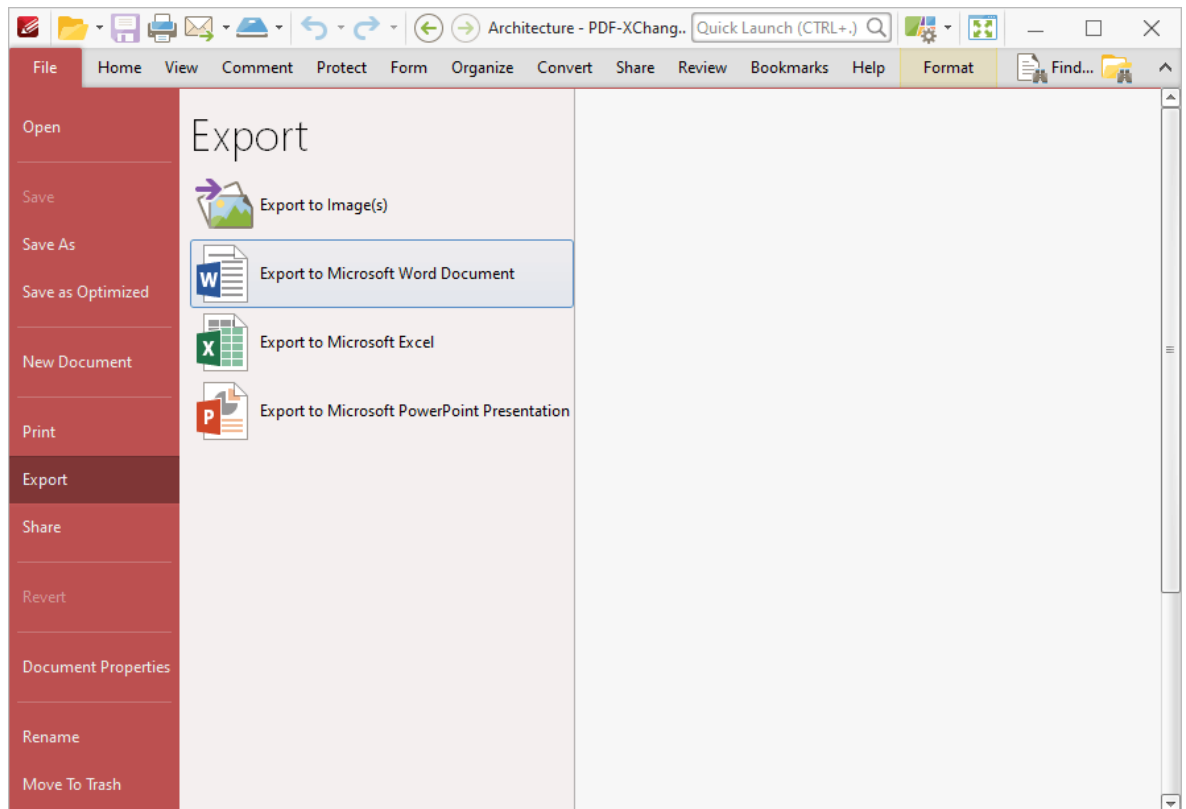

The **Save File** dialog box will open.

3. Enter the desired name for the converted document in the **File name** text box.

4. Click **OK**.

#### ▼ **Copy and Convert Text into Rich Text Format**

1. Click the **Home** tab, then click **Select Text**:

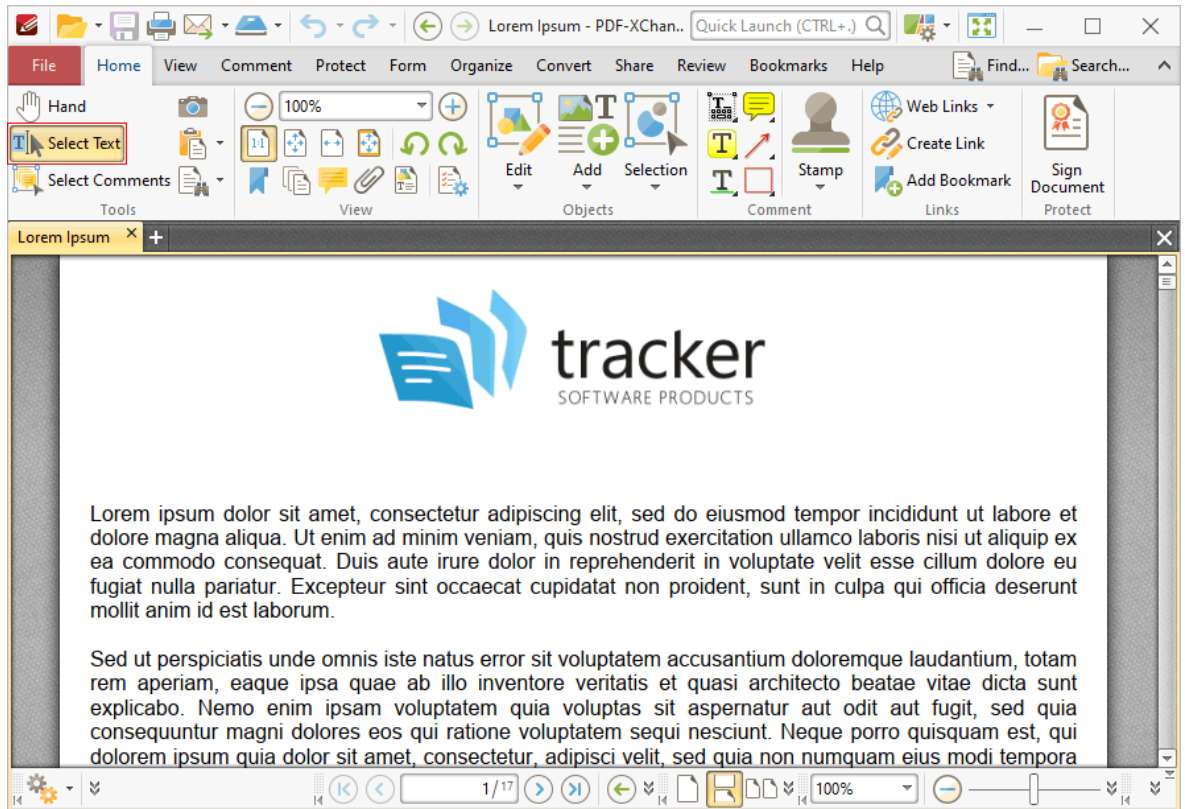

2. Select and then right-click the desired text.
3. Click **Copy as a Rich Text**.

#### ▼ Create a New Document Window

1. Click the **View** tab.
2. Click the **Document Tabs** dropdown menu.
3. Click **New Document Window**:

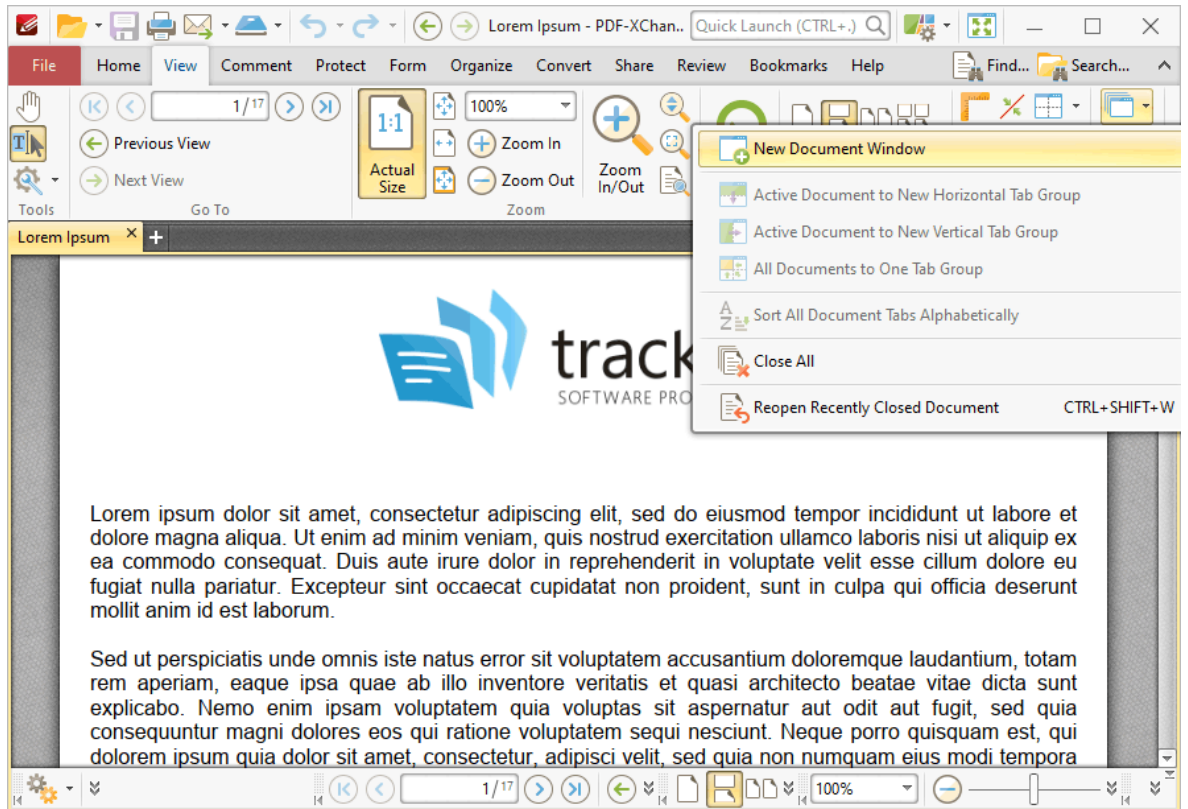

## ▼ Crop Pages

1. Click the **Organize** tab.
2. Click **Crop**, then click **Crop Pages**:

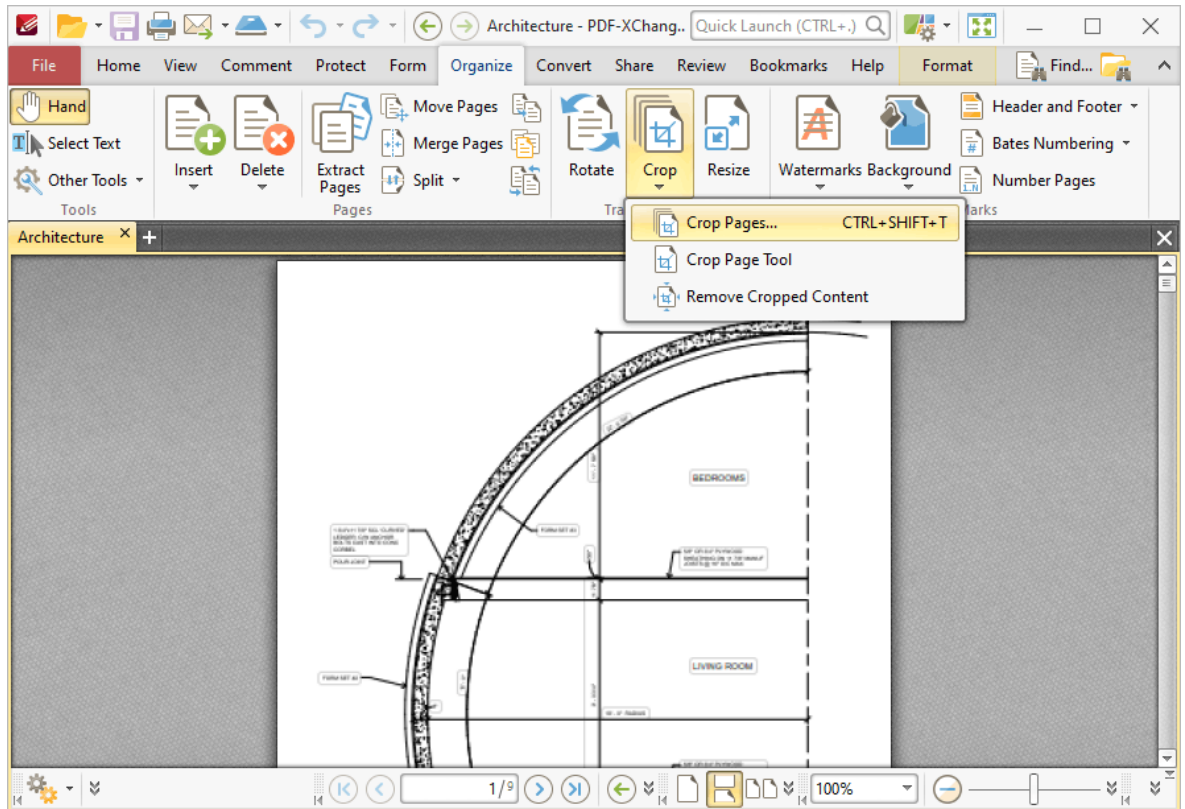

The **Crop Pages** dialog box will open.

3. Determine parameters as detailed [here](#).<sup>1484</sup>

4. Click **OK**.

The keyboard shortcut for this operation is Ctrl+Shift+T.

#### ▼ **Crop Pages Manually**

1. Click the **Organize** tab.

2. Click **Crop**, then click **Crop Page Tool**:

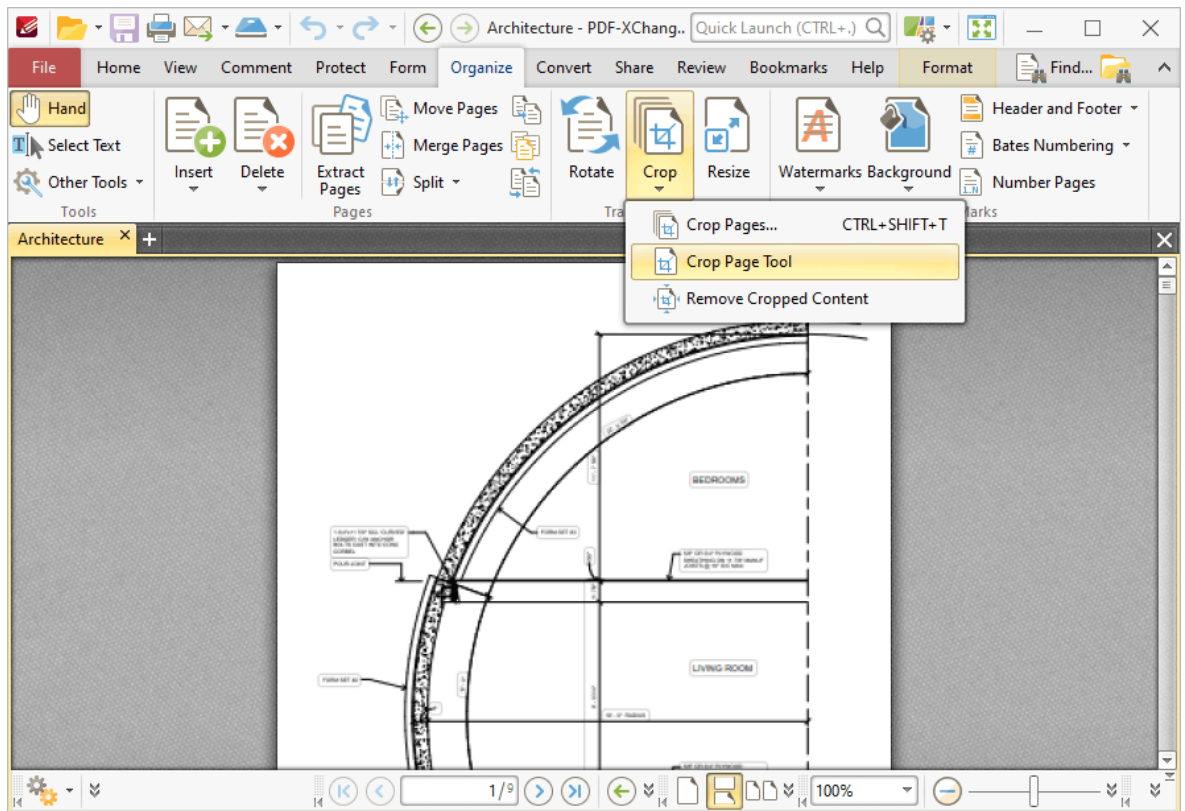

The **Crop Tool** dialog box will open.

3. Click **Drag Crop Rectangle**. The pointer will become a crosshairs icon.

4. Click and drag to determine the crop area. When the mouse button is released the **Crop Pages** dialog box will open.

5. Determine parameters as detailed [here](#).<sup>1496</sup>

6. Click **OK**.

#### ▼ Delete Empty Pages

1. Click the **Organize** tab.

2. Click **Delete**, then click **Delete Empty Pages**:

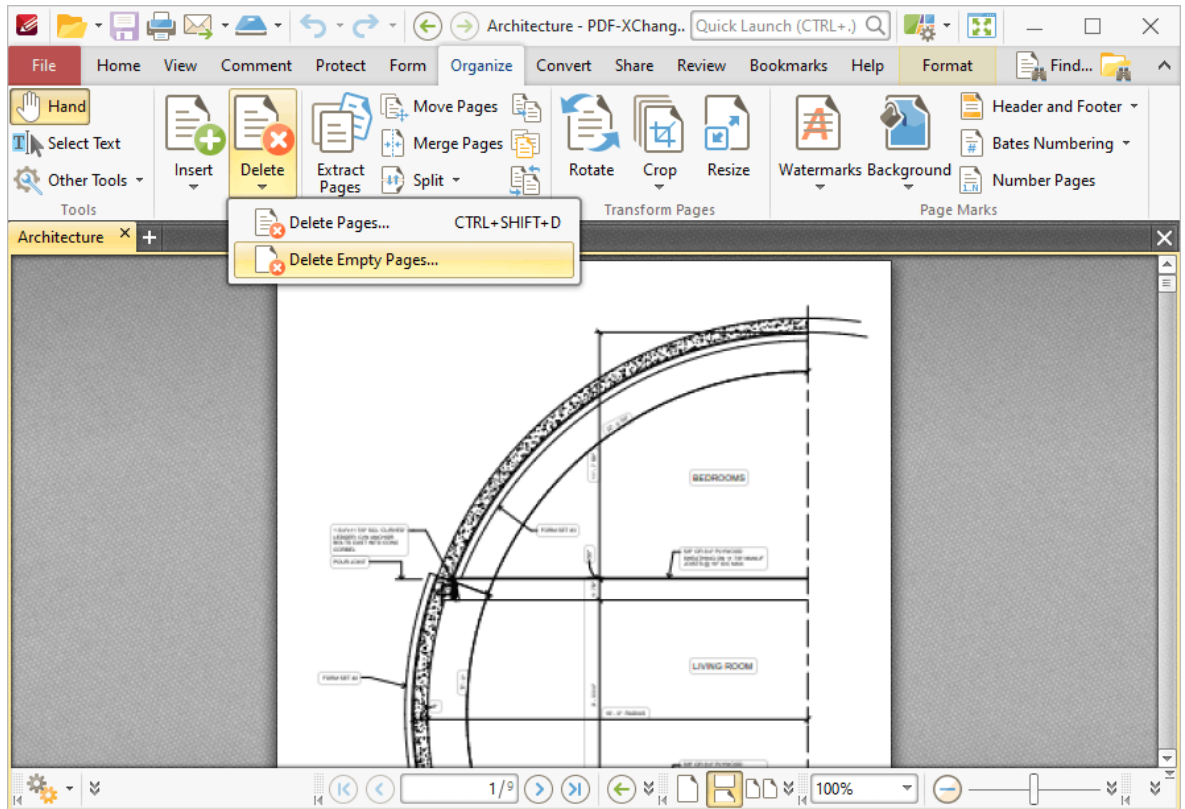

The **Delete Empty Pages** dialog box will open.

3. Determine parameters as detailed [here](#).<sup>1460</sup>

4. Click **OK**.

#### ▼ **Delete Pages**

1. Click the **Organize** tab.

2. Click **Delete**, then click **Delete Pages**:

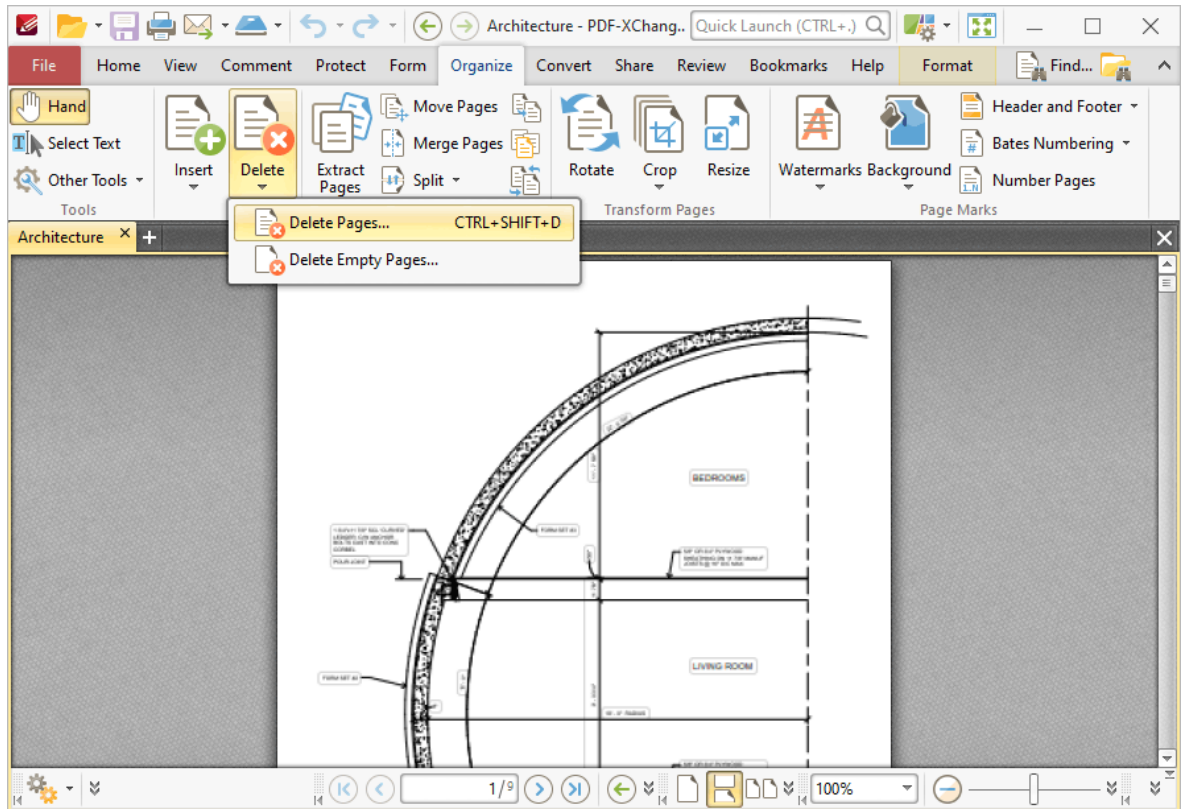

The **Delete Pages** dialog box will open.

3. Determine parameters as detailed [here](#).<sup>1459</sup>

4. Click **OK**.

The keyboard shortcut for this operation is Ctrl+Shift+D.

### ▼ **Determine Advanced Document Settings**

The advanced document settings can be used to determine base URLs for weblinks, "trapping" options for printing, print dialog presets and binding/language options. Follow the instructions below to access and edit advanced document settings:

1. Click the **File** tab.

2. Click **Document Properties**:



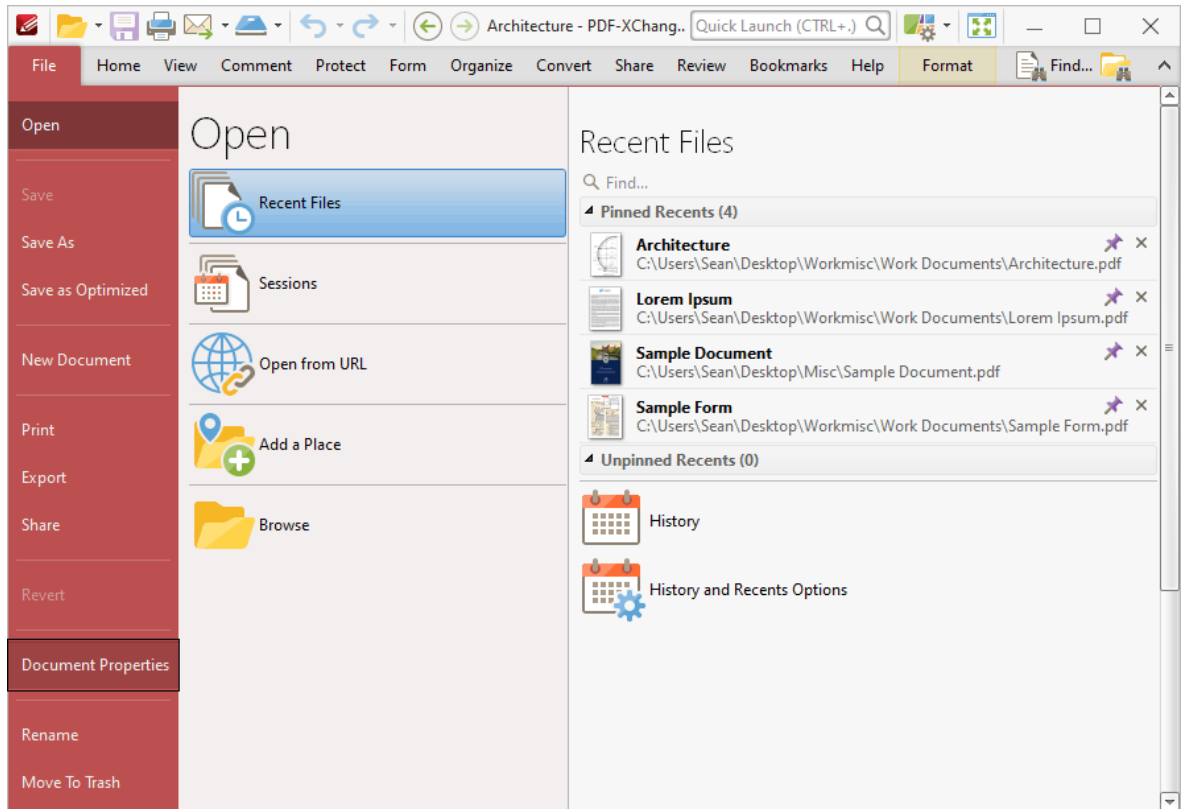

The **Document Properties** dialog box will open.

3. Click **Advanced** in the **Categories** menu.

4. Determine parameters as detailed [here](#).<sup>850</sup>

5. Click **OK**.

### ▼ **Determine Document Settings**

Document settings can be used to configure the layout of tabs and windows, document restore options, saving parameters and the PDF-specification of new documents. Follow the instructions below to access and edit document settings:

1. Click the **File** tab.

2. Click **Preferences**:

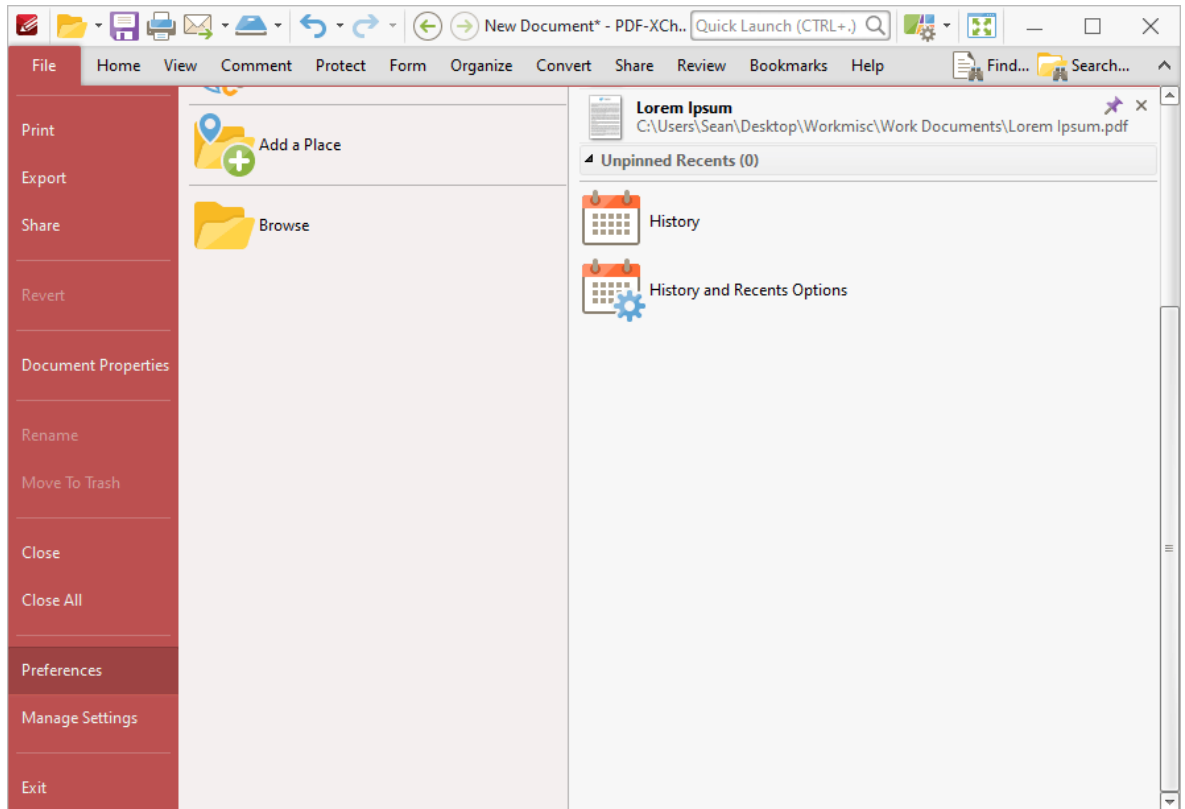

The **Preferences** dialog box will open.

3. Click **Documents** in the **Categories** menu.

4. Determine parameters as detailed [here](#).<sup>857</sup>

5. Click **OK**.

#### ▼ **Determine PDF Portfolio File View Parameters**

PDF portfolio files are dynamic files that contain multiple file formats assembled into an integrated PDF unit. Follow the instructions below to determine how portfolio files are displayed in **PDF-XChange Editor**:

1. Open the portfolio file.

2. Click the **Portfolio** tab:

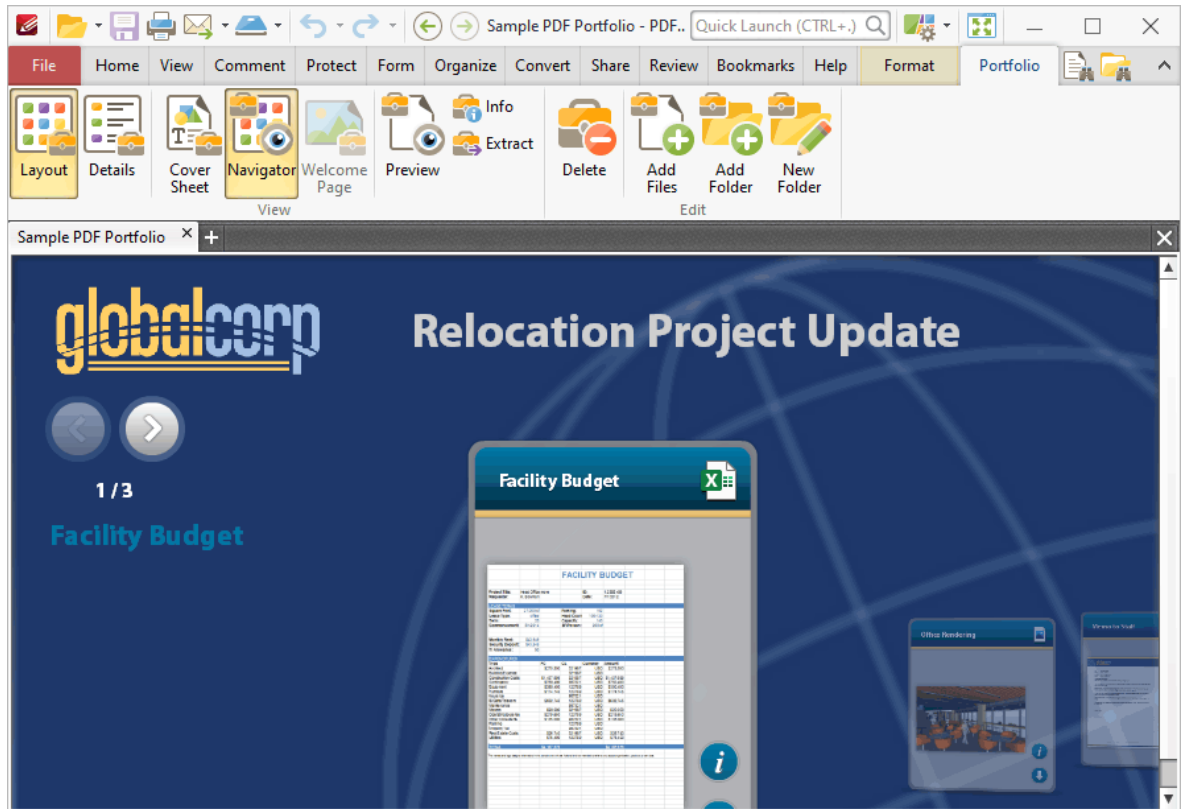

3. Determine parameters as detailed [here](#). <sup>1630</sup>

4. Click **OK**.

### ▼ Determine Security Settings

The security settings in **PDF-XChange Editor** determine file open and program launch options when documents are attempting to open files, attachments or sites. Follow the instructions below to determine these settings:

1. Click the **File** tab.
2. Click **Document Properties**:

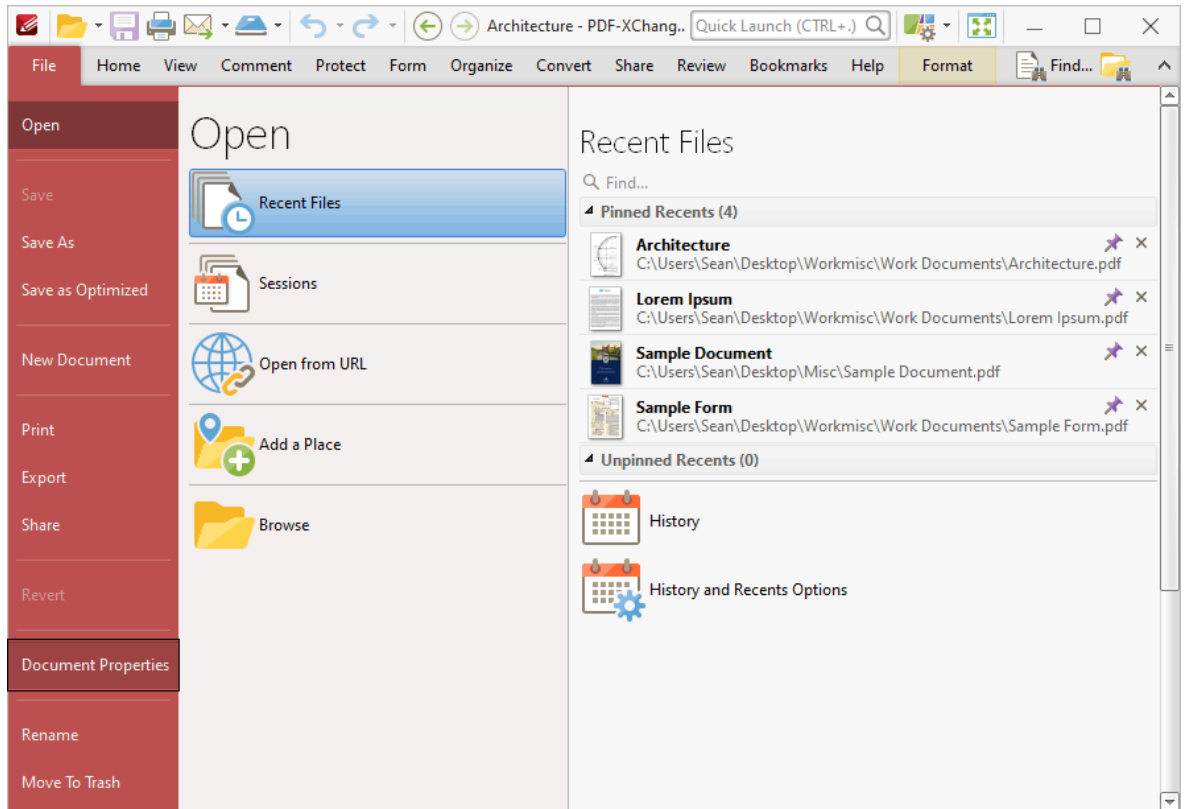

The **Document Properties** dialog box will open.

3. Click **Security** in the **Categories** menu.

4. Determine parameters as detailed [here](#).<sup>850</sup>

5. Click **OK**.

### ▼ **Edit Document Info**

Document information includes the document title, author, subject, keywords and additional metadata. It has various functions and it used during specific operations such as when documents are edited/saved/signed. Follow the instructions below to edit document information:

1. Click the **File** tab.

2. Click **Document Properties**:

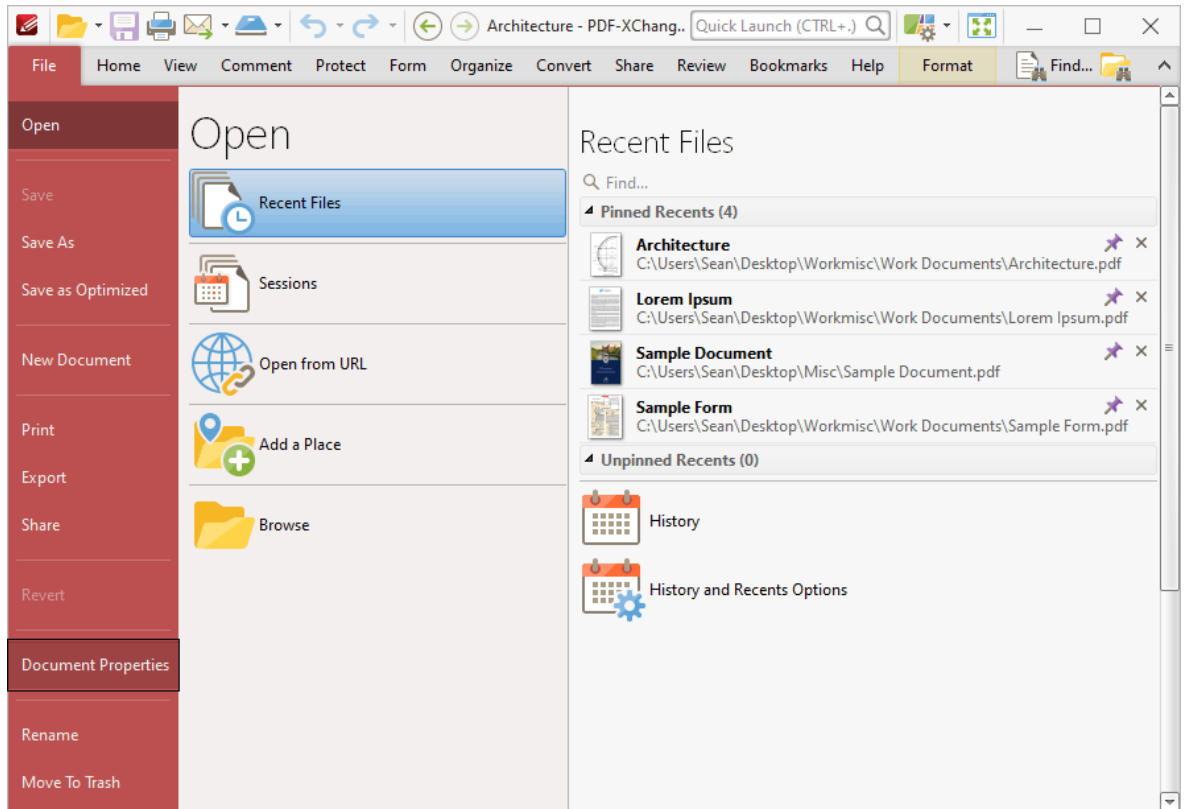

The **Document Properties** dialog box will open.

3. Click **Description** in the **Categories** menu.

4. Determine parameters as detailed [here](#).<sup>850</sup>

5. Click **OK**.

#### ▼ **Edit the Base Content of Documents**

1. Click the **Home** tab.

2. Click **Edit**, then select **All Content, Text, Images** or **Shapes** to determine the content to be edited:

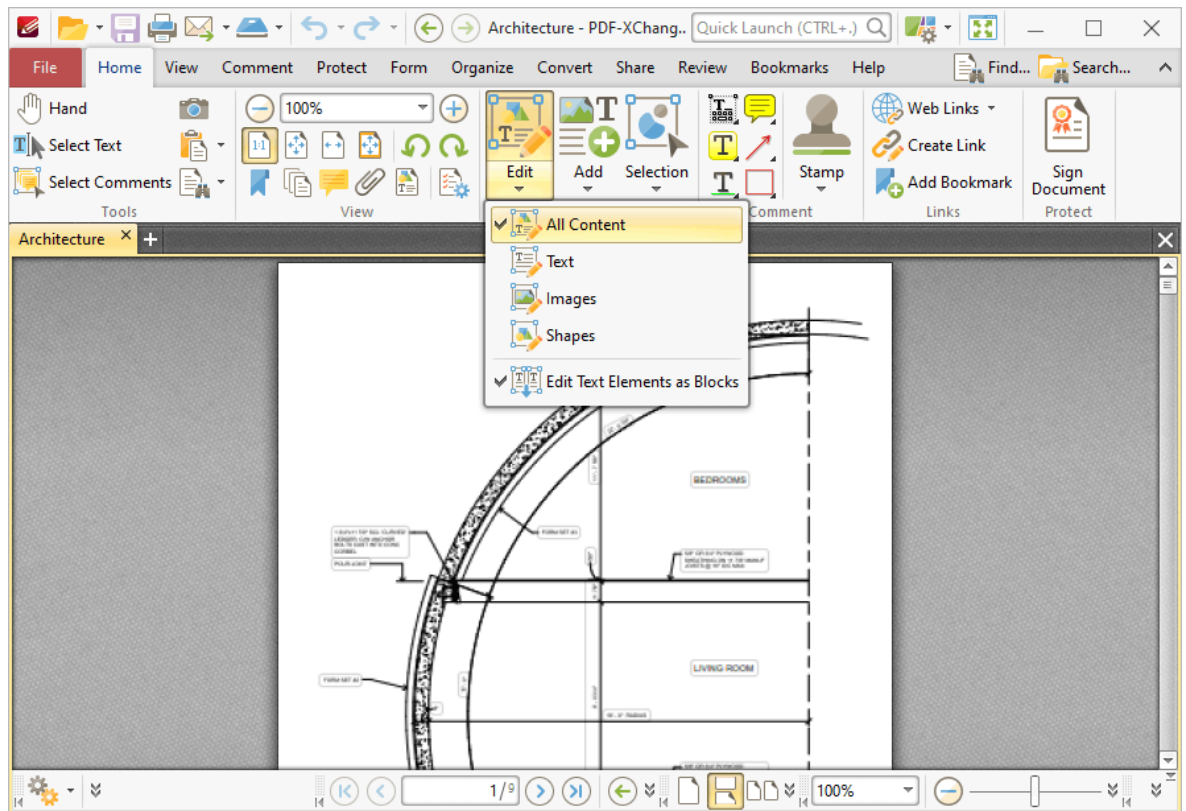

3. Follow the instructions detailed [here](#).<sup>1638</sup>

### ▼ Edit Base Content of Documents in an Alternative Application

When this feature is used, content will update automatically in **PDF-XChange Editor** when it is edited in an alternative application.

1. Click the **Home** tab.
2. Click **Edit**, then select **All Content**:

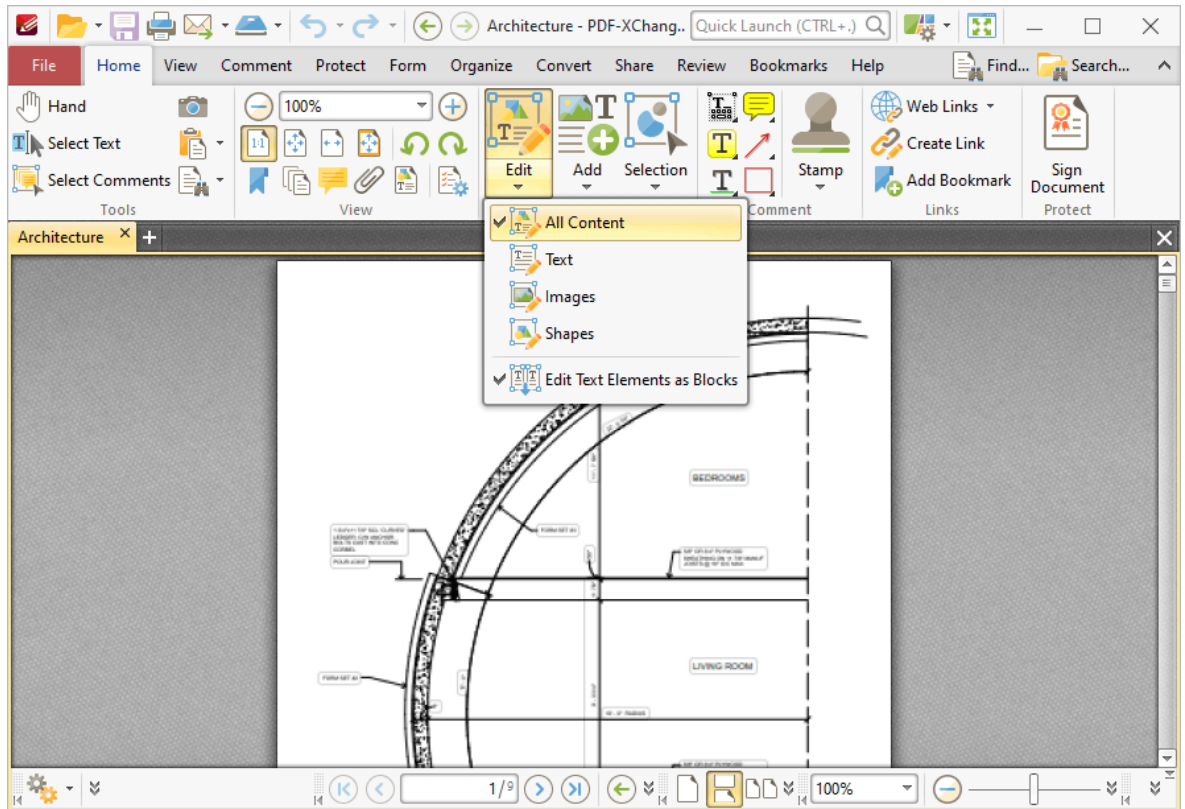

3. Right-click the content item to be edited, then hover over **Edit Image** in the submenu.
4. Click **Default Application** to edit content in the default content editing application, or click **Edit With** to select a different application:

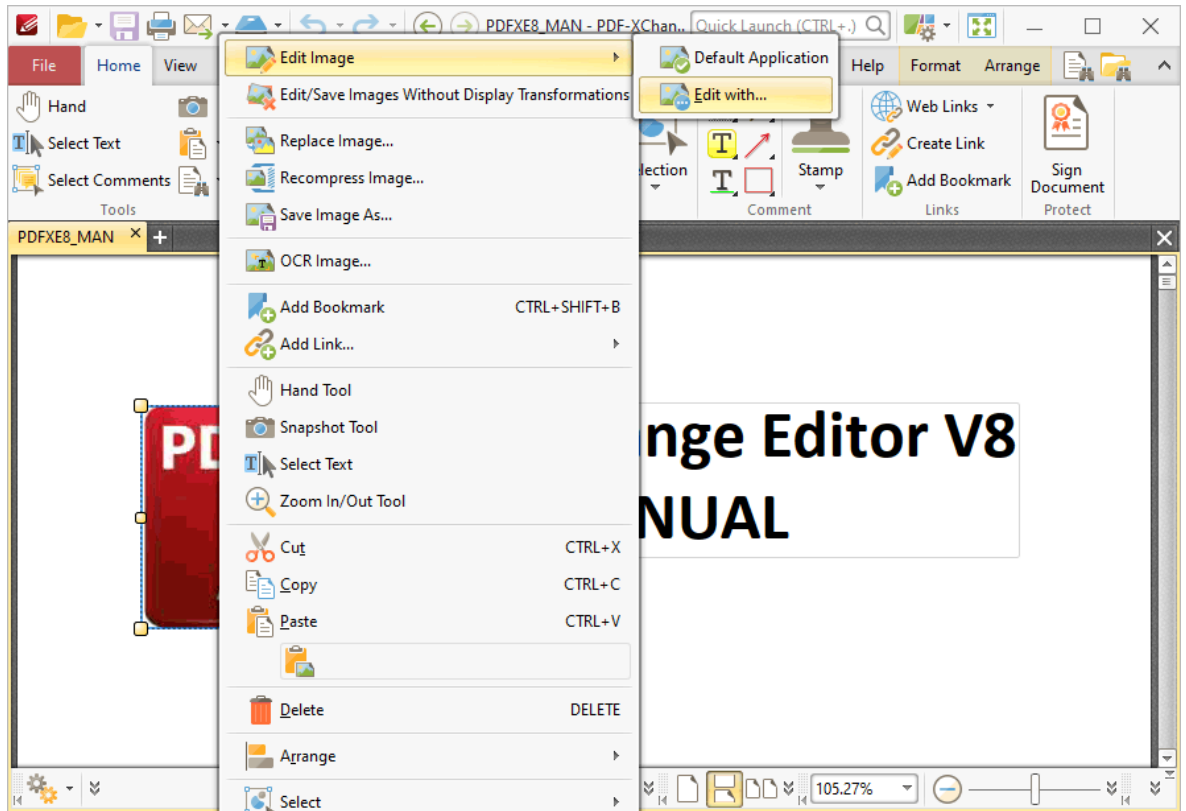

▼ **Enable Dynamic Zoom Panes**

1. Click the **View** tab.
2. Click the **Loupe Tool**:

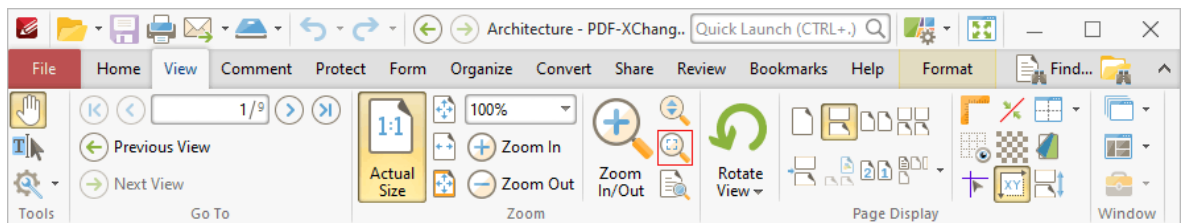

3. Follow the instructions detailed [here](#).

Alternatively:

1. Click the **View** tab.
2. Click **Pan and Zoom**:



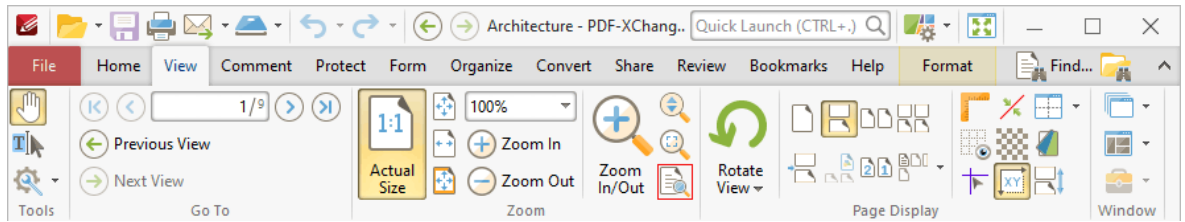

3. Follow the instructions detailed [here](#).<sup>1070</sup>

### ▼ Extract Pages

1. Click the **Organize** tab.

2. Click **Extract Pages**:

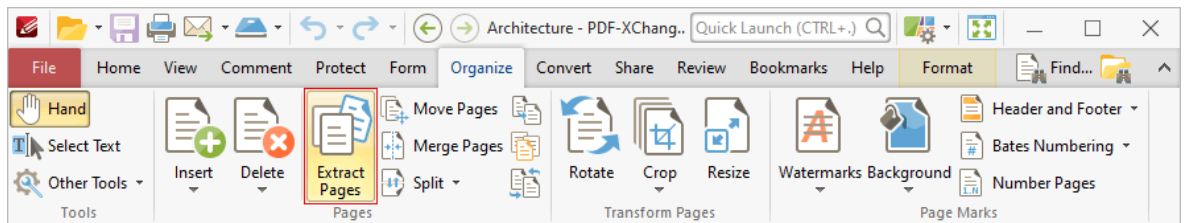

The **Extract Pages** dialog box will open.

3. Determine parameters as detailed [here](#).<sup>1462</sup>

4. Click **OK**.

The keyboard shortcut for this operation is Ctrl+Shift+E.

### ▼ Fit Page to Document Window

1. Click the **View** tab.

2. Click **Fit Page**:

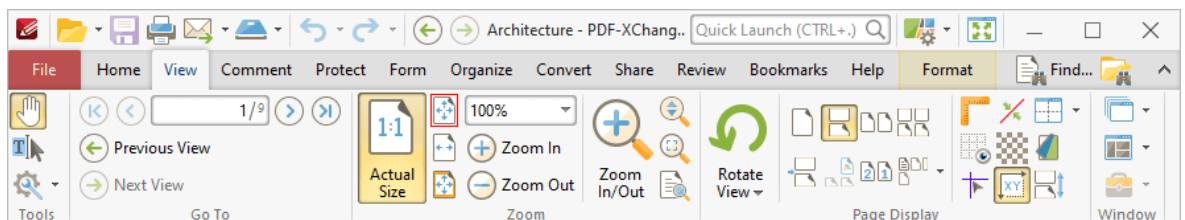

The keyboard shortcut for this operation is Ctrl+0.

#### ▼ Fit Page Width to Document Window

1. Click the **View** tab.
2. Click **Fit Width**:

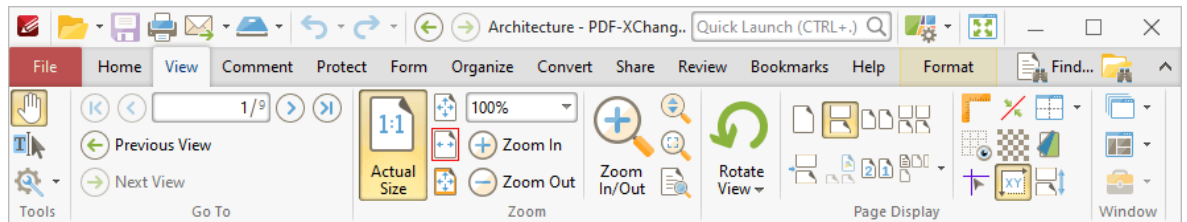

The keyboard shortcut for this operation is Ctrl+2.

#### ▼ Fit Page Width to Document Window and Exclude White Space

1. Click the **View** tab.
2. Click **Fit Visible**.

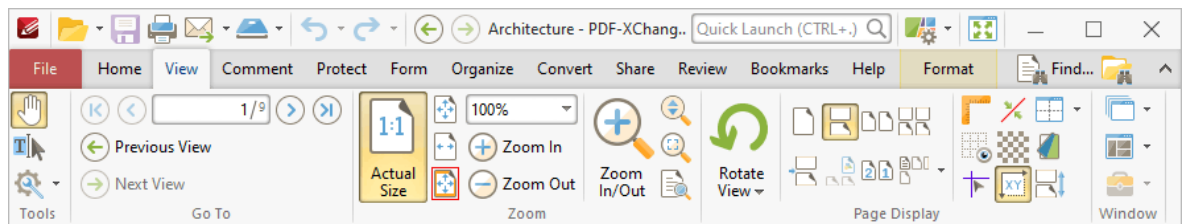

The keyboard shortcut for this operation is Ctrl+3.

#### ▼ Highlight Document Text

1. Click the **Comment** tab.
2. Click **Highlight**:

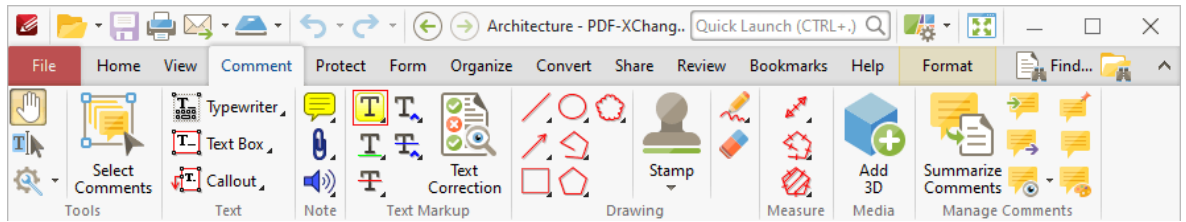

3. Click and drag to highlight text. See [here](#)<sup>1120</sup> for further information.

▼ **Insert Empty Pages**

1. Click the **Organize** tab.
2. Click **Insert**, then click **Insert Empty Pages**:

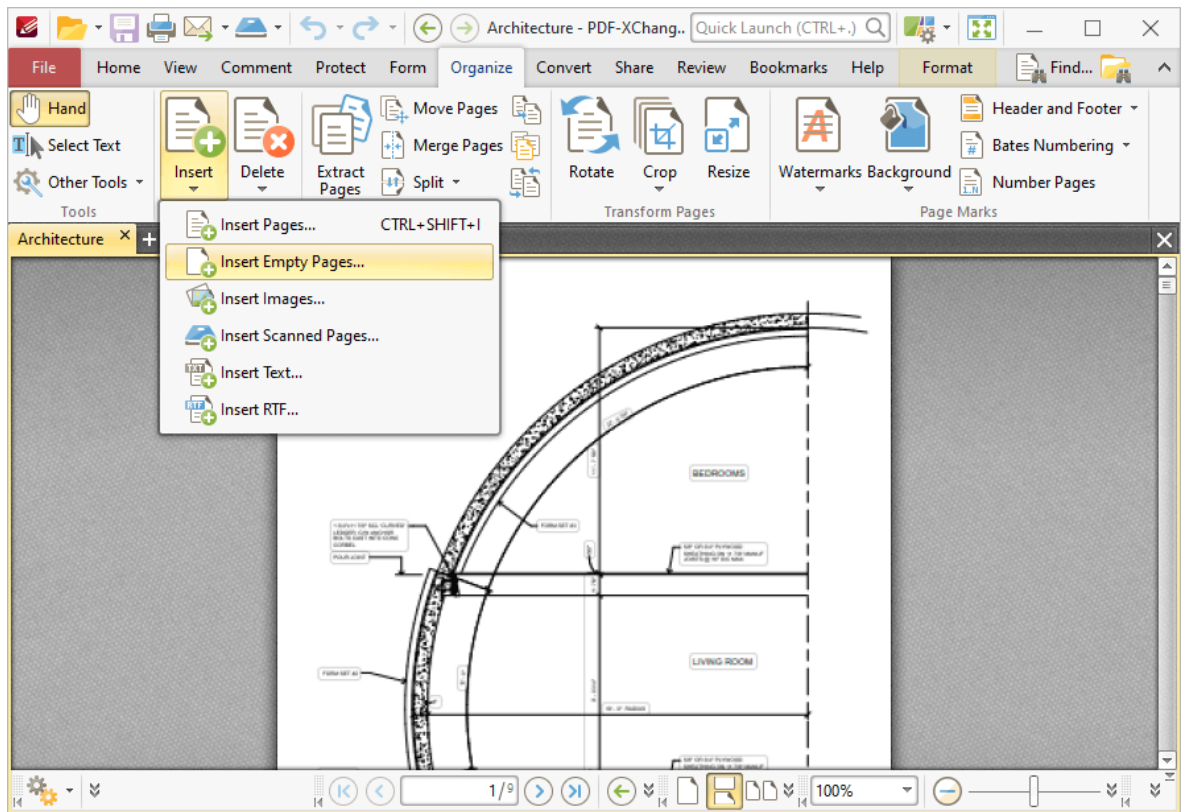

The **Insert Empty Pages** dialog box will open.

3. Determine parameters as detailed [here](#)<sup>1453</sup>
4. Click **OK**.

The keyboard shortcut for this operation is Ctrl+Shift+I.

### ▼ Insert Images as PDF Pages

1. Click the **Organize** tab.
2. Click **Insert**, then click **Insert Images**:

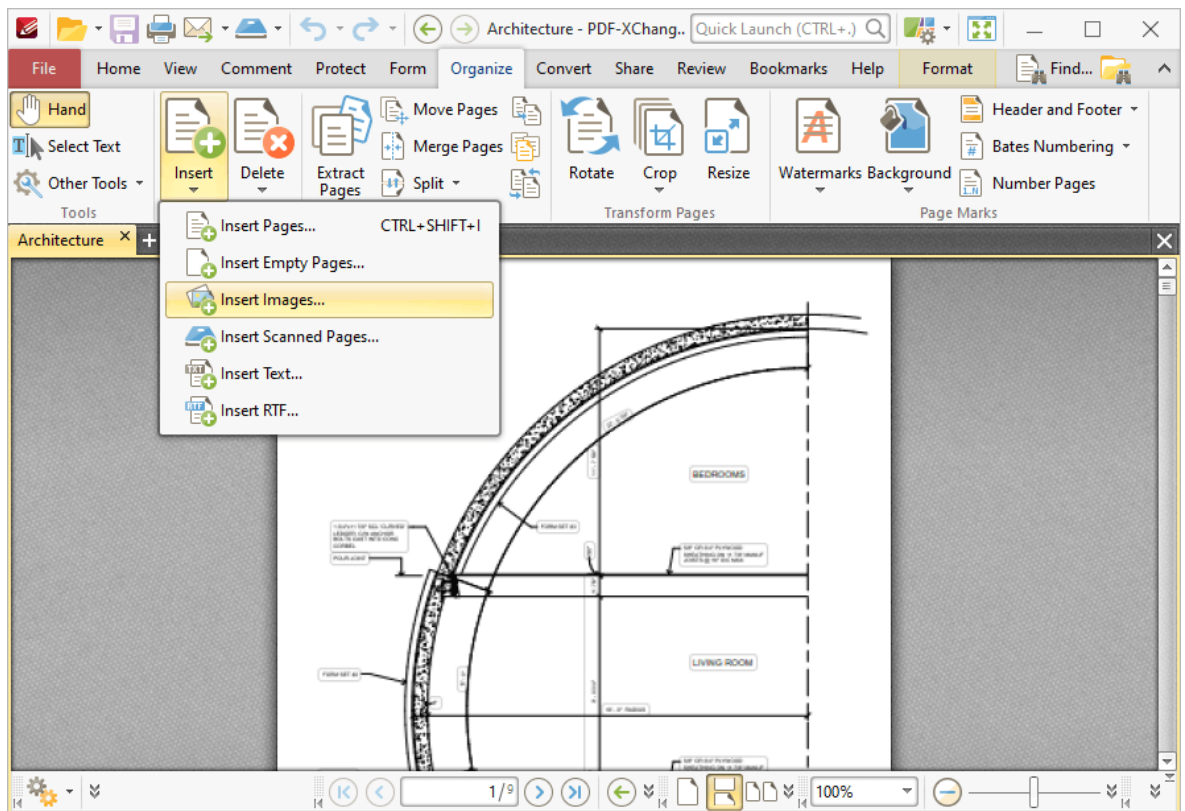

The **Image to PDF** dialog box will open.

3. Determine parameters as detailed [here](#).<sup>1454</sup>
4. Click **OK**.

### ▼ Insert Pages From a Different Document

1. Click the **Organize** tab.
2. Click **Insert**, then click **Insert Pages**:

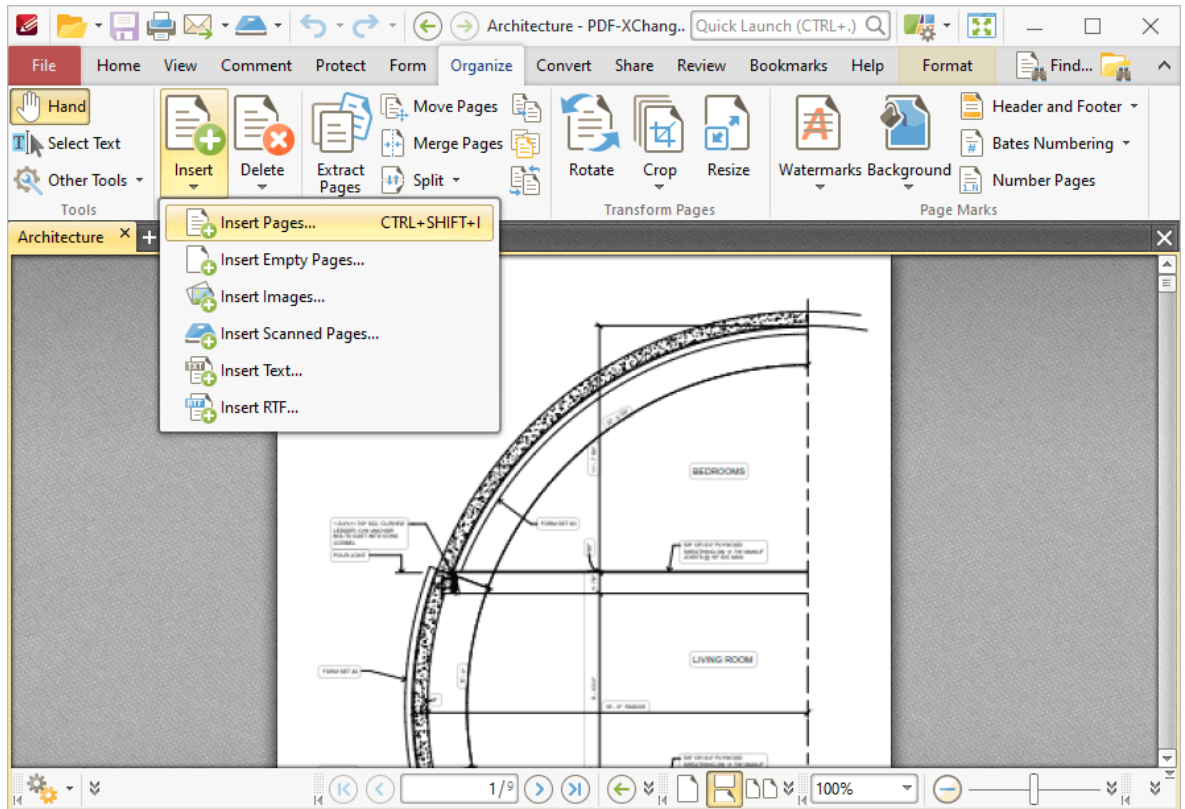

The **Insert Pages** dialog box will open.

3. Determine parameters as detailed [here](#).

4. Click **OK**.

#### ▼ **Insert RTF Content Into PDF Files**

1. Click the **Organize** tab.

2. Click **Insert**, then click **Insert RTF**:

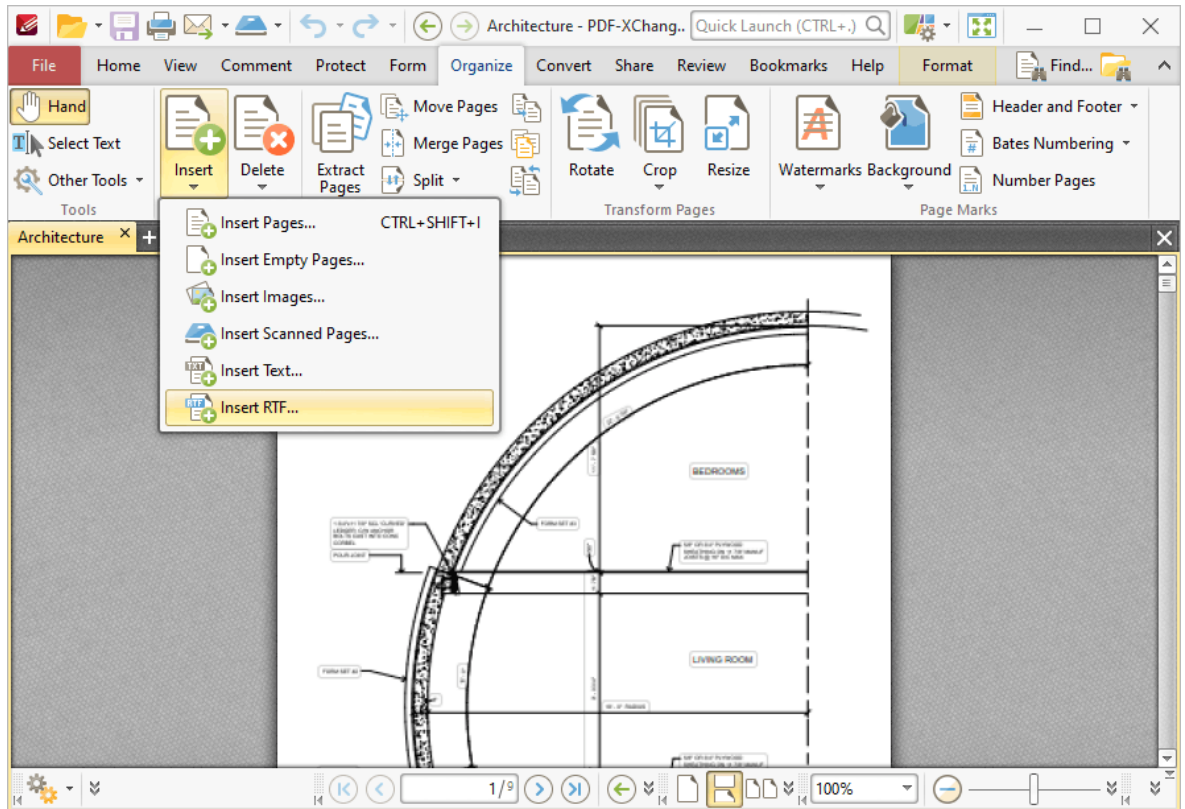

The **Convert RTF Files to PDF** dialog box will open.

3. Determine parameters as detailed [here](#).<sup>1458</sup>

4. Click **OK**.

#### ▼ **Insert Scanned Pages Into PDF Files**

1. Click the **Organize** tab.

2. Click **Insert**, then click **Insert Scanned Pages**:

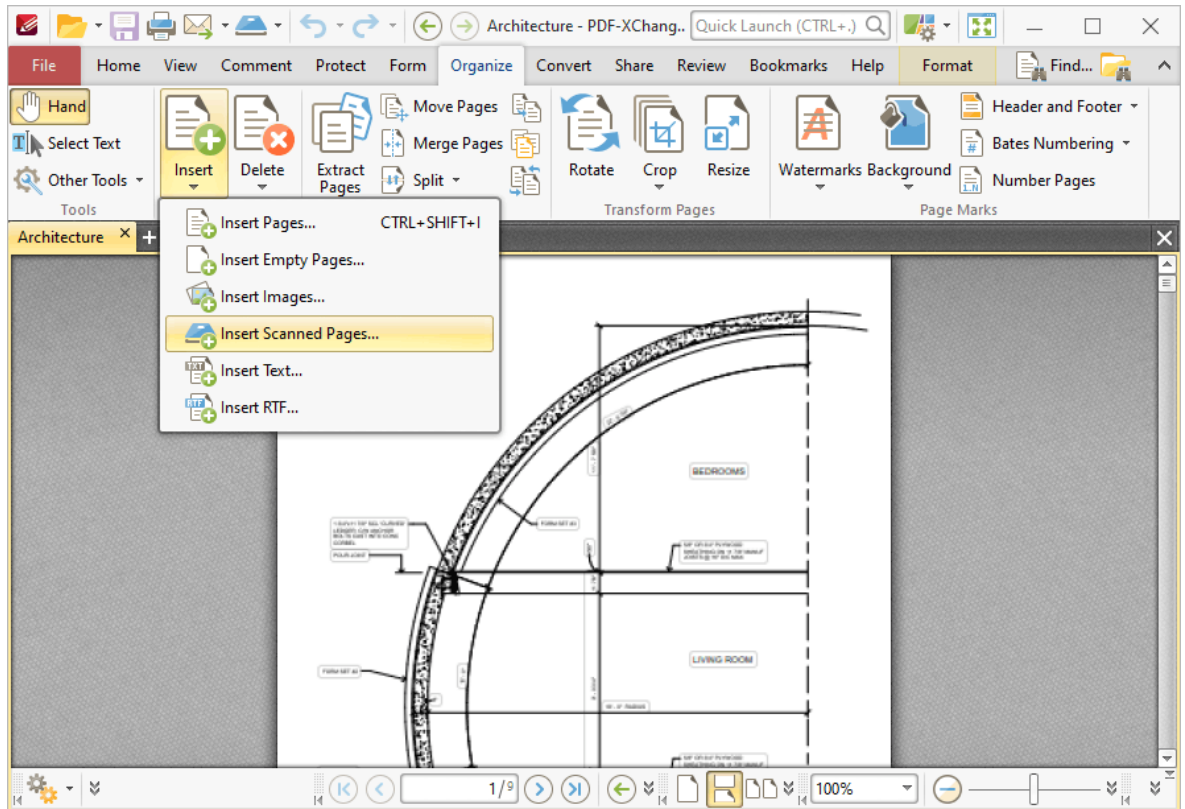

The **Scan Properties** dialog box will open.

3. Determine properties as detailed [here](#).<sup>1454</sup>

4. Click **Scan**.

#### ▼ Insert Text Files into PDF Documents

1. Click the **Organize** tab.

2. Click **Insert**, then click **Insert Text**:

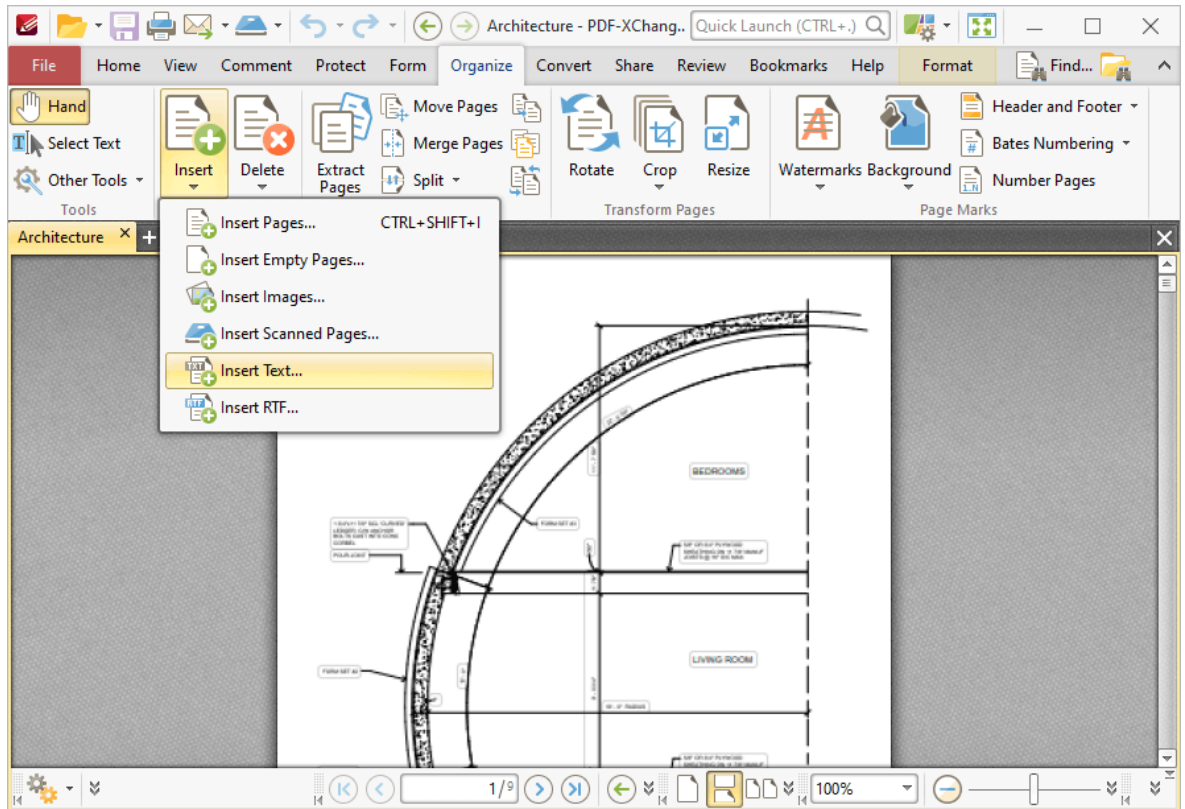

The **Convert Text Files to PDF** dialog box will open.

3. Determine parameters as detailed [here](#).

4. Click **OK**.

#### ▼ **Measure Document Areas**

1. Click the **Comment** tab.

2. Click the **Area Tool**:



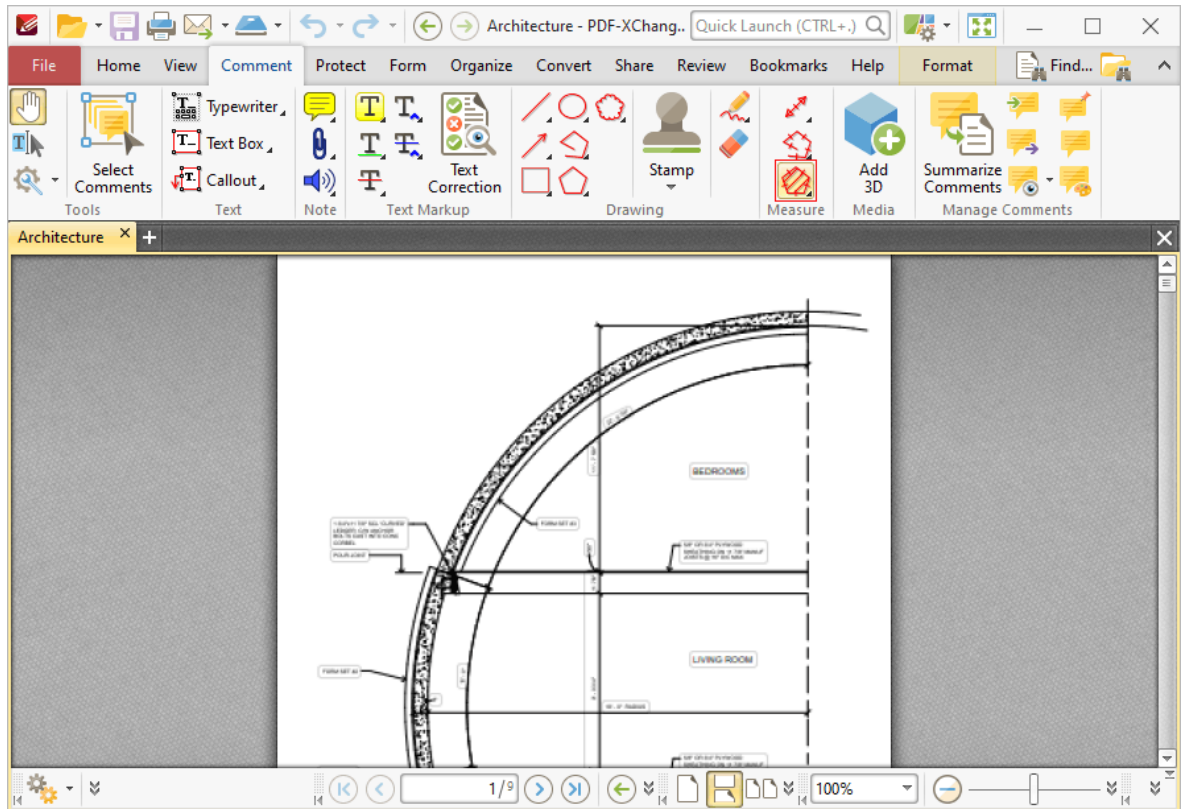

3. Follow the instructions detailed [here](#).<sup>1219</sup>

### ▼ Measure Document Distances

1. Click the **Comment** tab.
2. Click the **Distance Tool**:

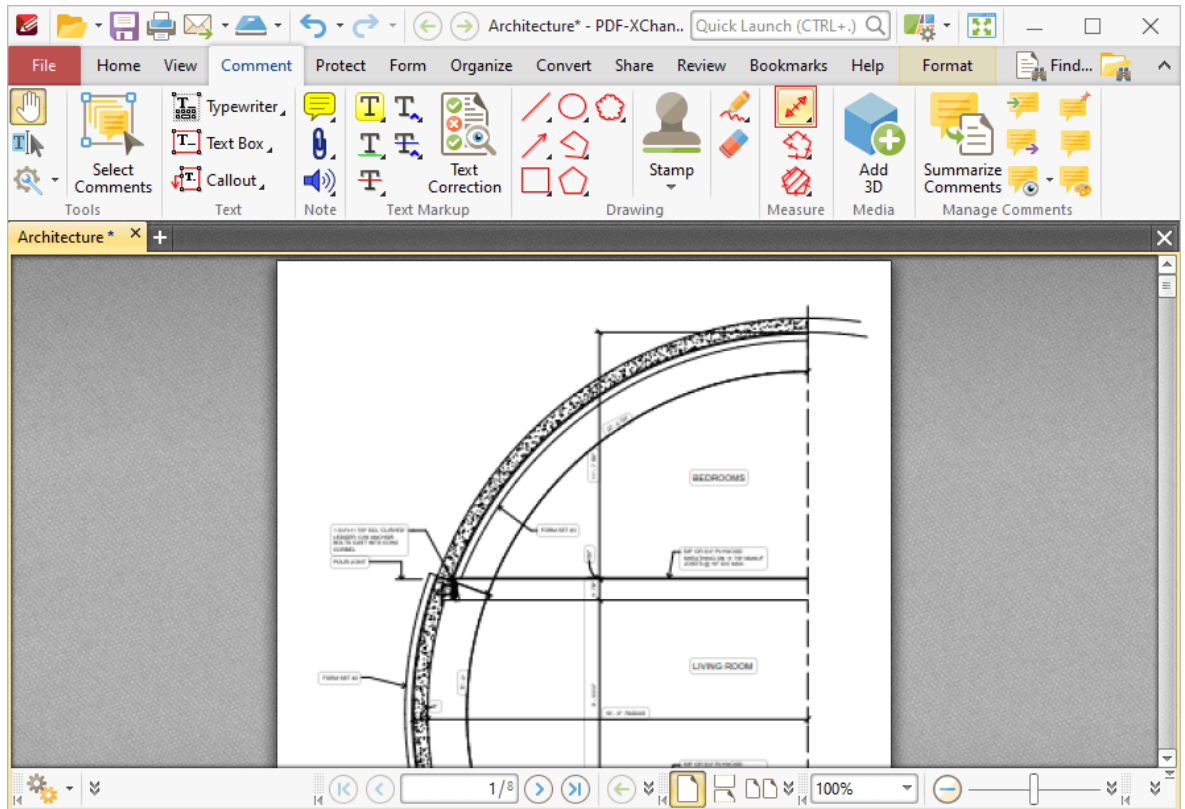

3. Follow the instructions detailed [here](#).<sup>1208</sup>

### ▼ Measure Document Perimeters

1. Click the **Comment** tab.
2. Click the **Perimeter Tool**:

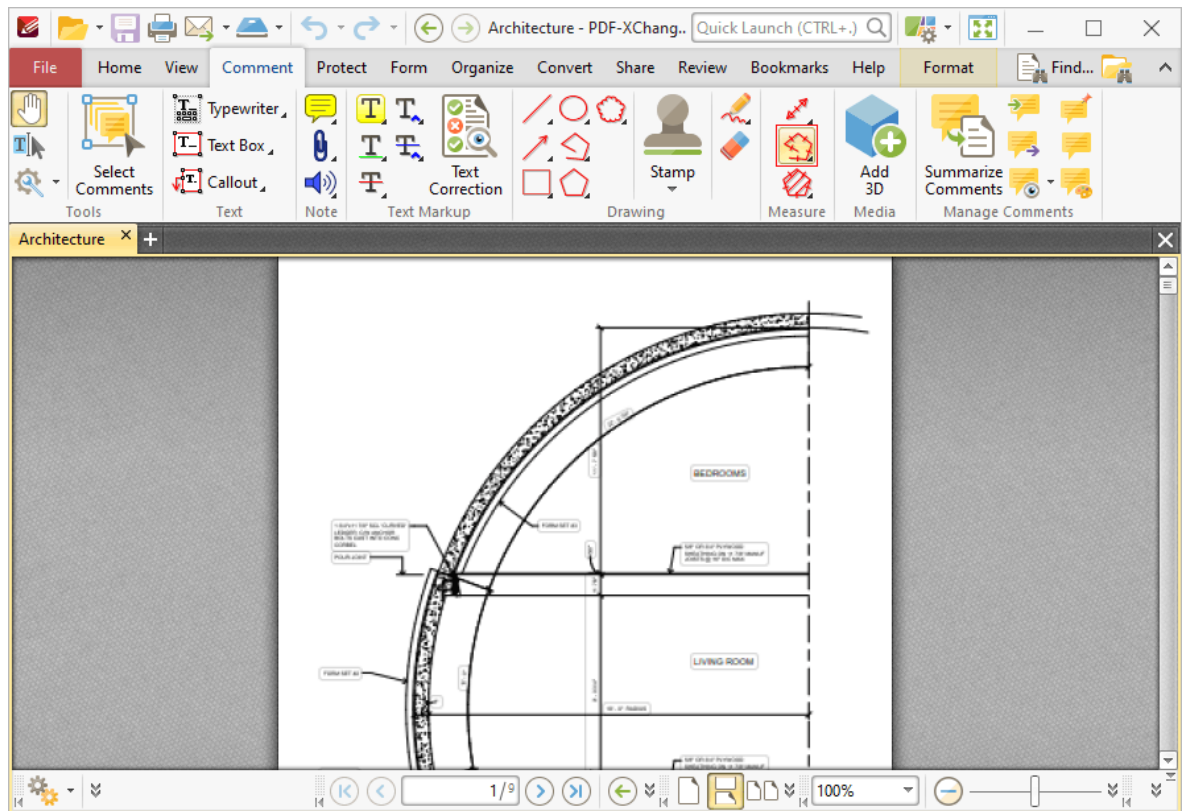

3. Follow the instructions detailed [here](#).<sup>1214</sup>

### ▼ Move All Open Documents to a Single Tab Group

1. Click the **View** tab.
2. Click the **Document Tabs** dropdown menu, then click **All Documents to One Tab Group**:

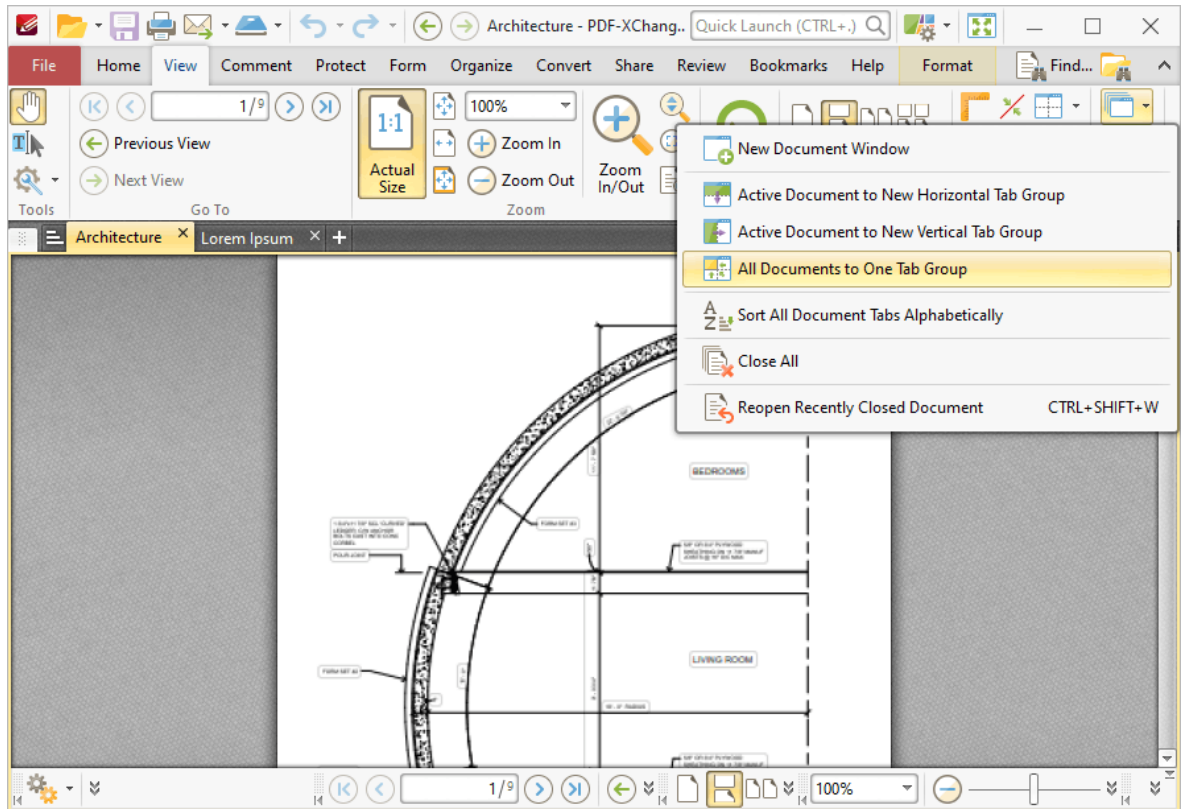

### ▼ Move the Active Document to a New Horizontal Tab Group

1. Click the **View** tab.
2. Click the **Document Tabs** dropdown menu, then click **Active Document to New Horizontal Tab Group**:

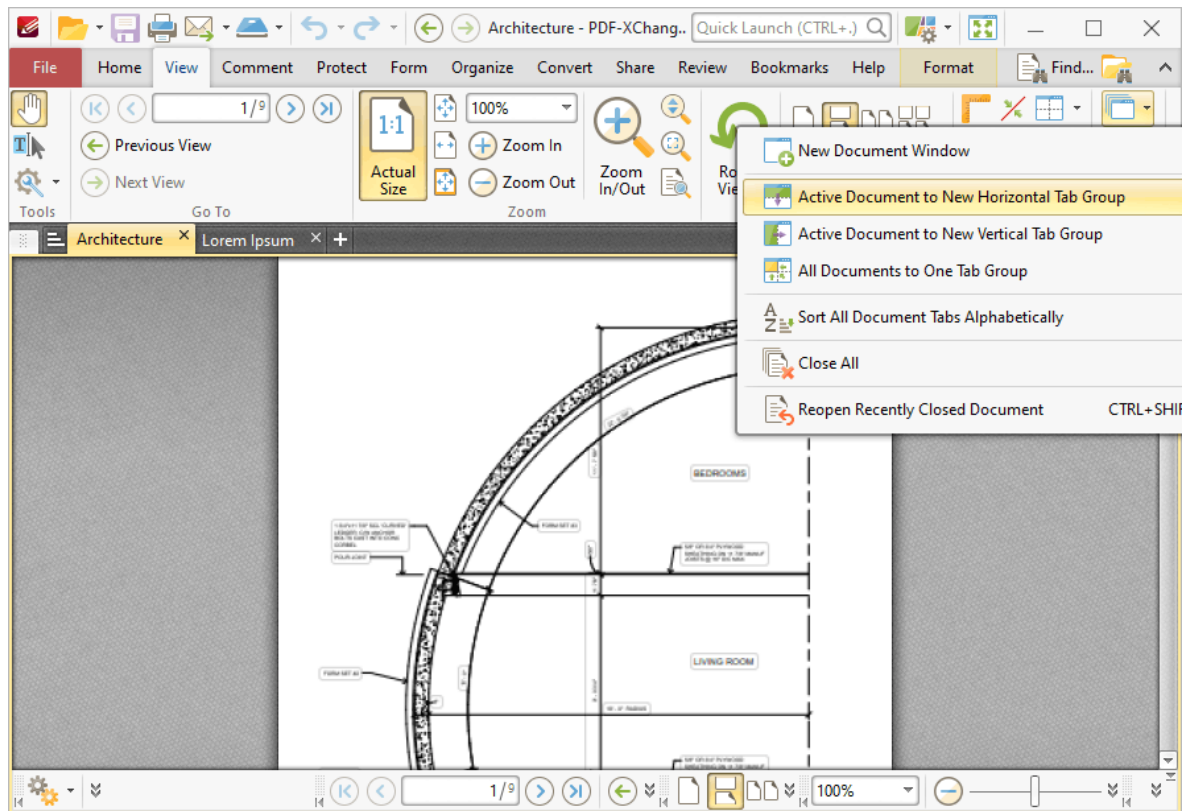

### ▼ Move the Active Document to a New Vertical Tab Group

1. Click the **View** tab.
2. Click the **Document Tabs** dropdown menu, then click **Active Document to New Vertical Tab Group**:

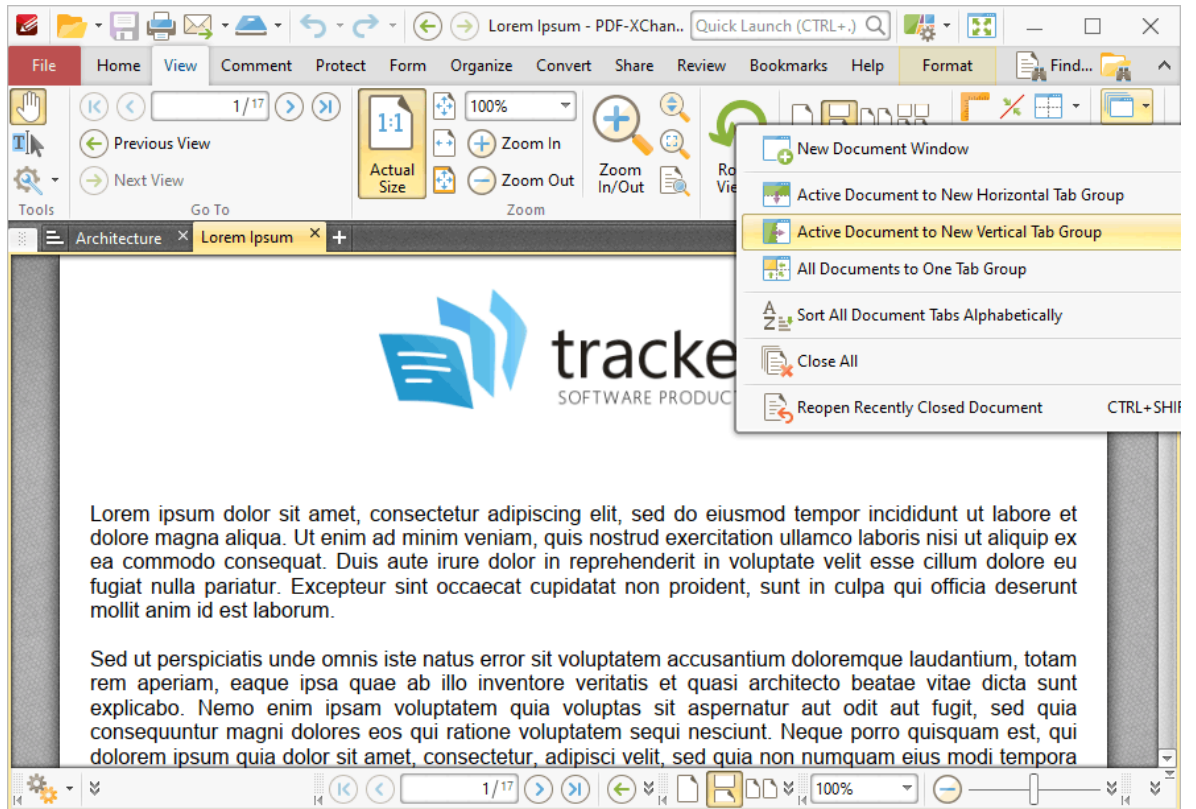

### ▼ Add Number Ranges to Pages

1. Click the **Organize** tab.
2. Click **Number Pages**:

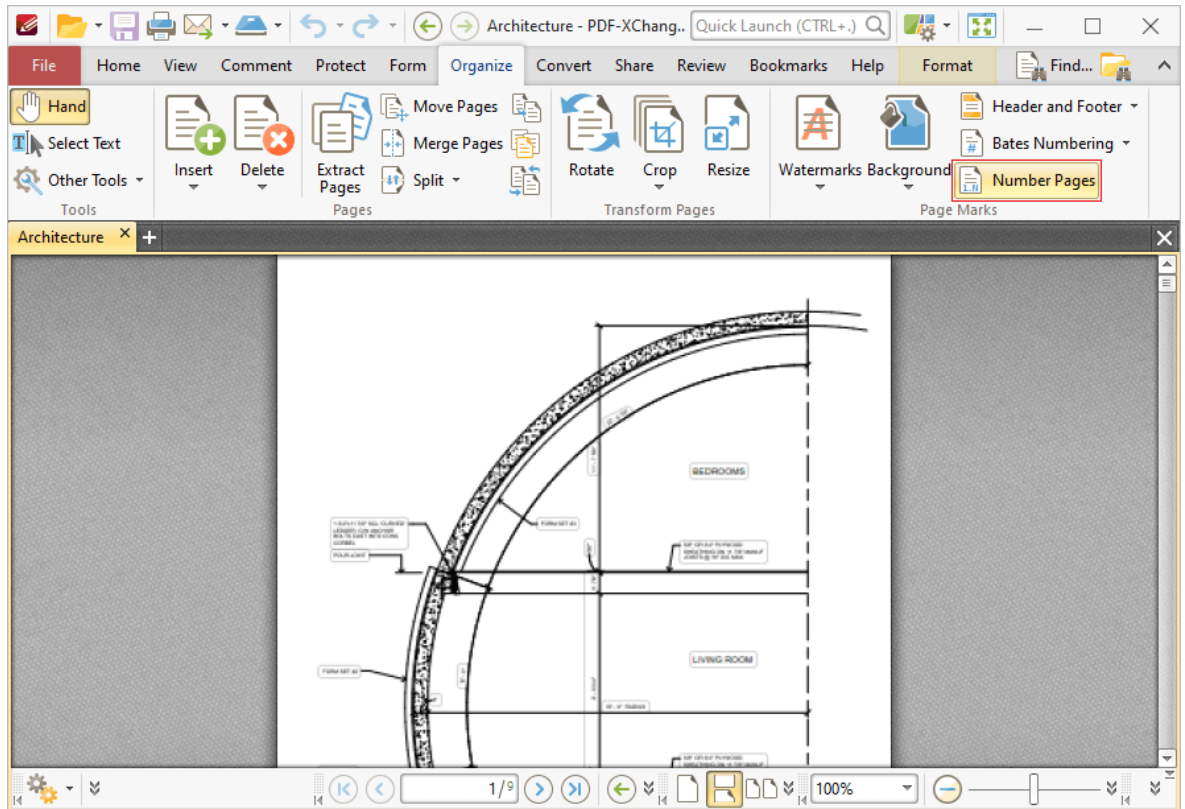

3. Determine parameters as detailed [here](#).<sup>1504</sup>

4. Click **OK**.

### ▼ **OCR Pages**

The optical character recognition (OCR) in **PDF-XChange Editor** analyzes PDF documents, recognizes text and then makes it selectable and searchable. Follow the instructions below to perform OCR on documents:

1. Click the **Convert** tab.

2. Click **OCR Pages**:

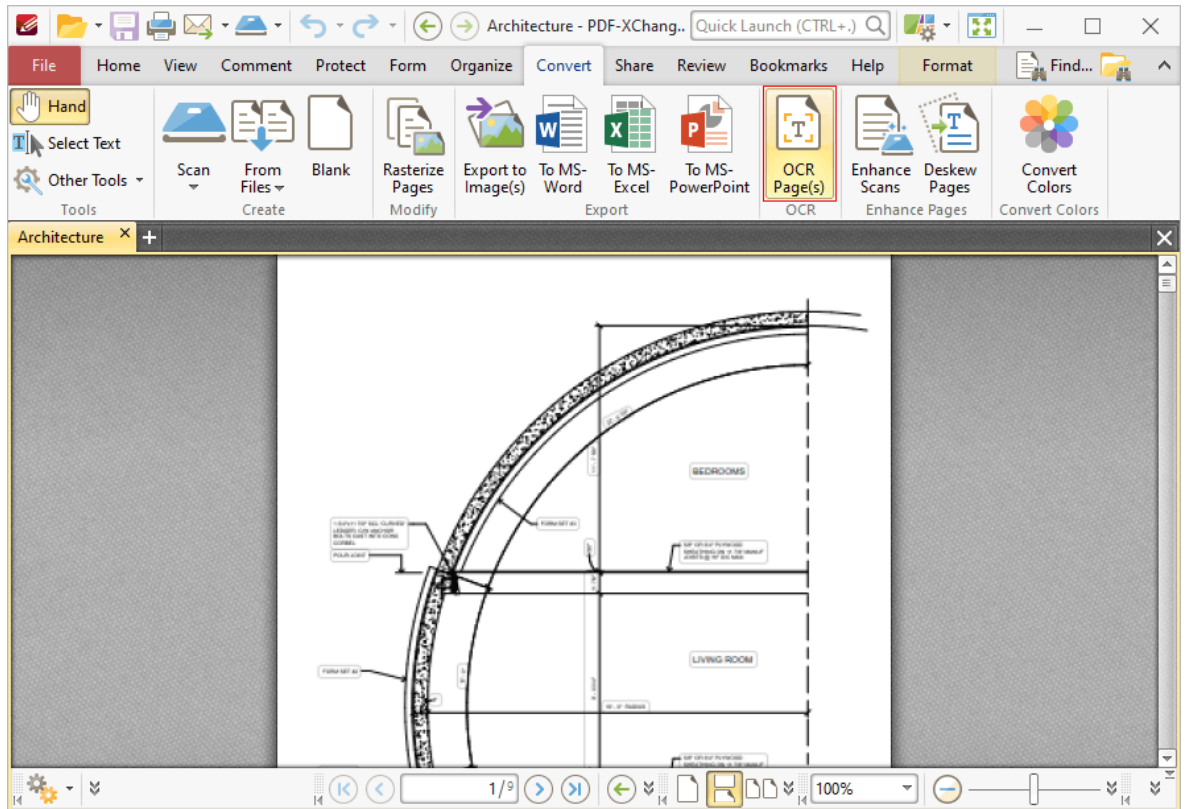

3. Determine parameters as detailed [here](#).<sup>1519</sup>

4. Click **OK**.

### ▼ Place Signatures in Documents

1. Click the **Protect** tab.

2. Click **Place Signature**:



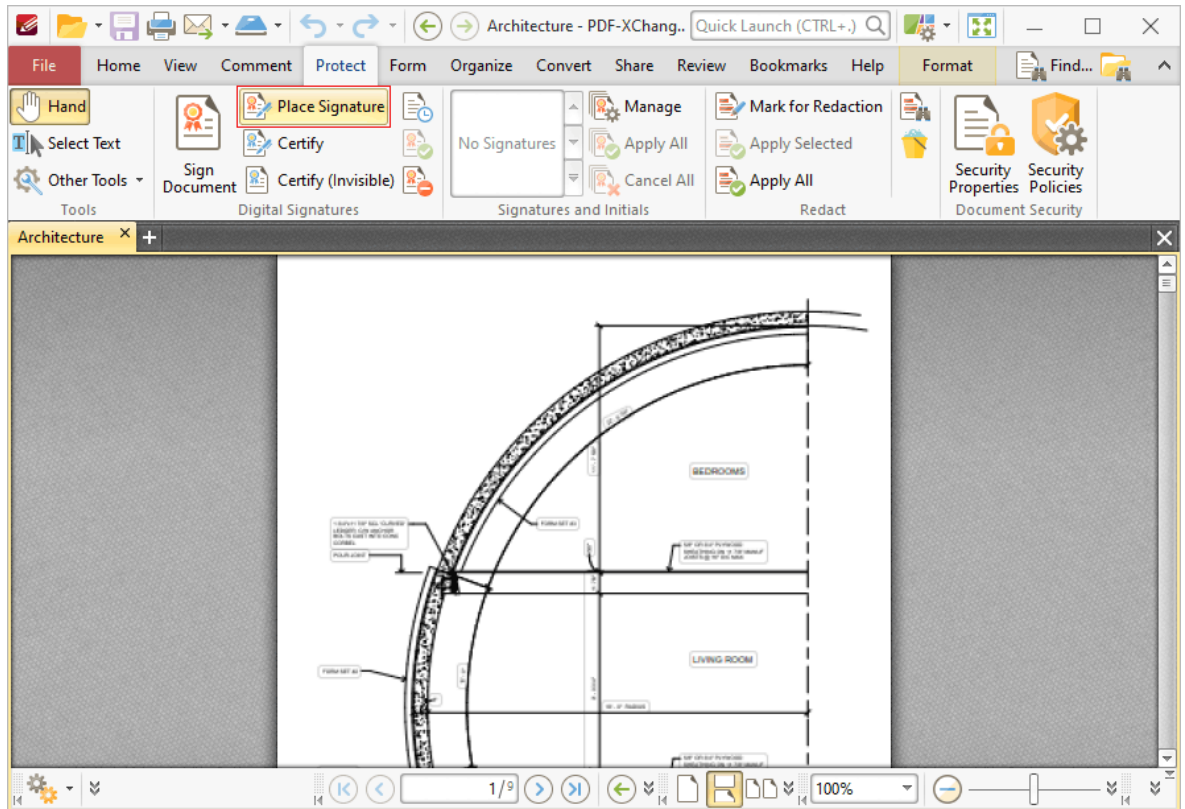

3. Follow the instructions detailed [here](#).<sup>1248</sup>

### ▼ Read Selected Text Out Loud

1. Click the **Home** tab.
2. Click **Select Text Tool**, then highlight the text to be read out loud.
3. Right-click the selected text and then click **Read Selected Text Out Loud** in the submenu:

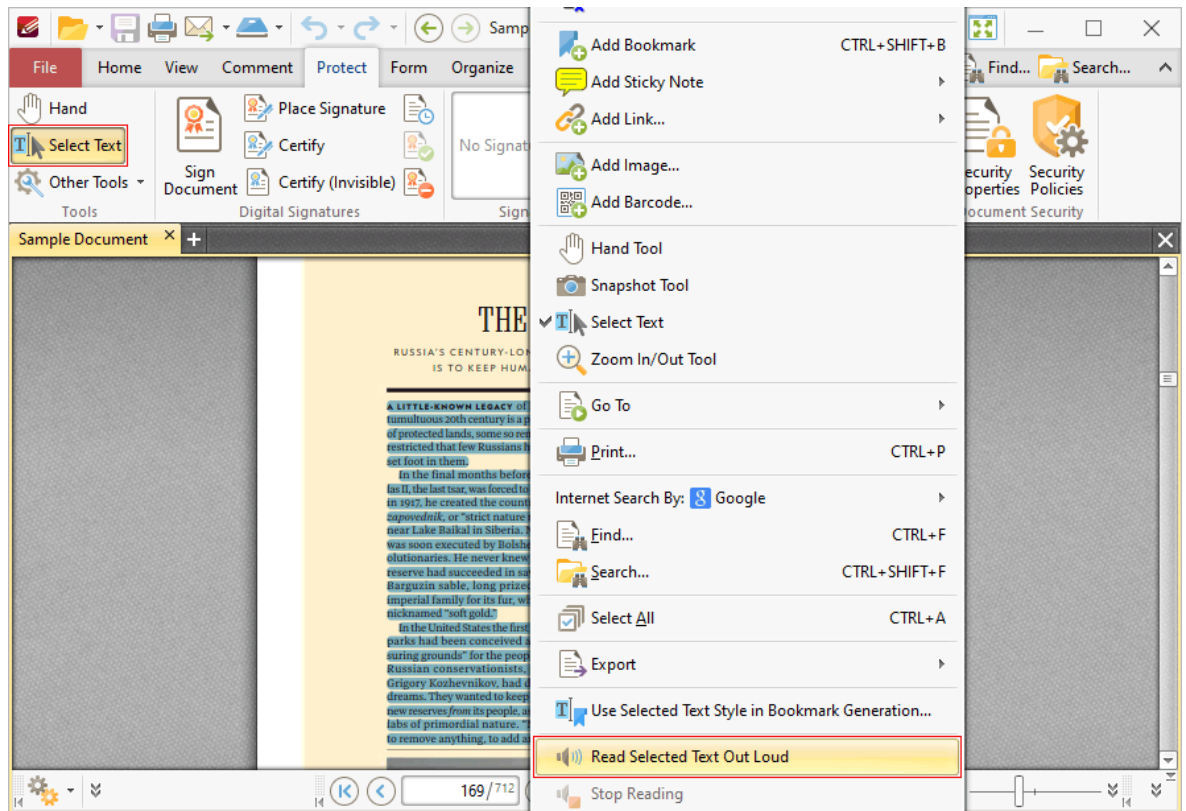

Note that customizable options for this feature are detailed [here](#).<sup>928</sup>

## ▼ Redact Page Content

Redaction can be used to remove content permanently from documents. Redaction is used, instead of a delete option, when it is necessary/desired to show that material has been removed from documents, such as in sensitive material where some content can be shown to all users but other content needs to be protected. Follow the instructions below to redact page content:

1. Click the **Protect** tab.
2. Click **Mark for Redaction**:

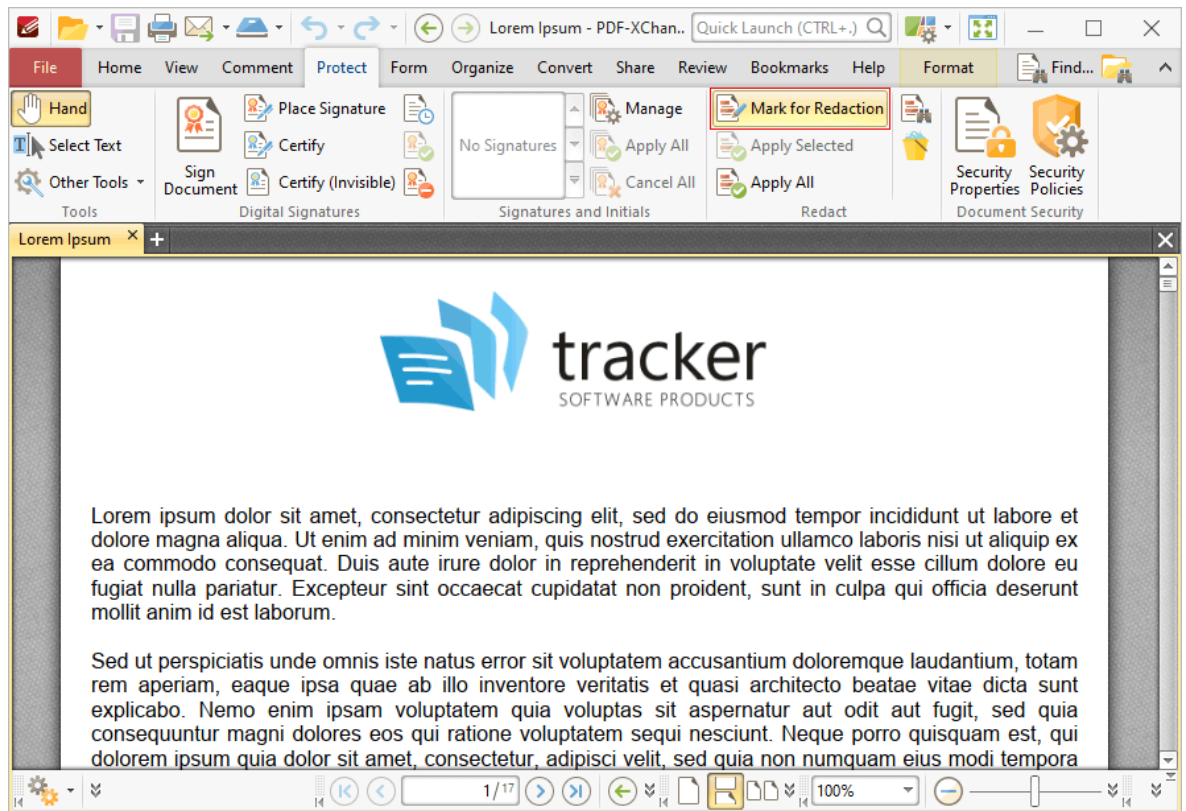

3. Follow the instructions detailed [here](#).

### ▼ Remove Backgrounds from Documents

1. Click the **Organize** tab.
2. Click **Background**, then click **Remove All**:

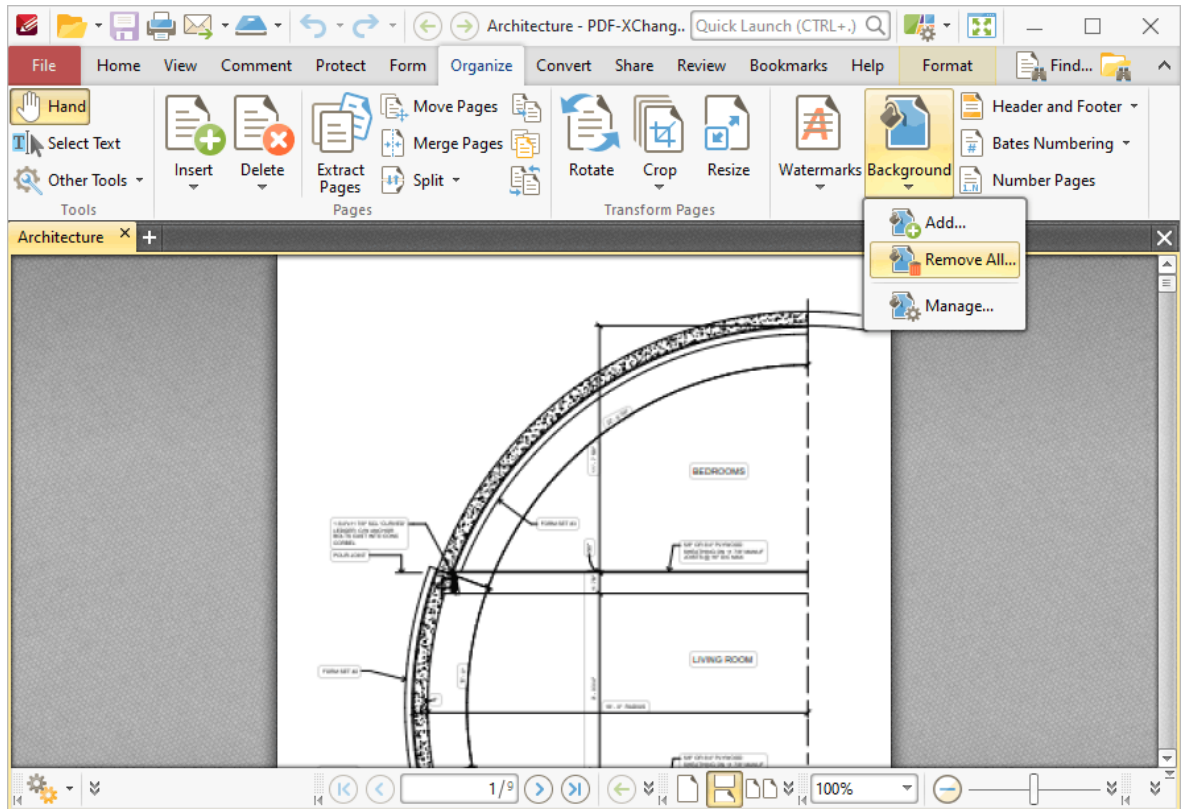

The **Remove Backgrounds** dialog box will open.

3. Click **Yes**.

### ▼ Remove Bates Numbering from Documents

1. Click the **Organize** tab.

2. Click **Bates Numbering**, then click **Remove All**:

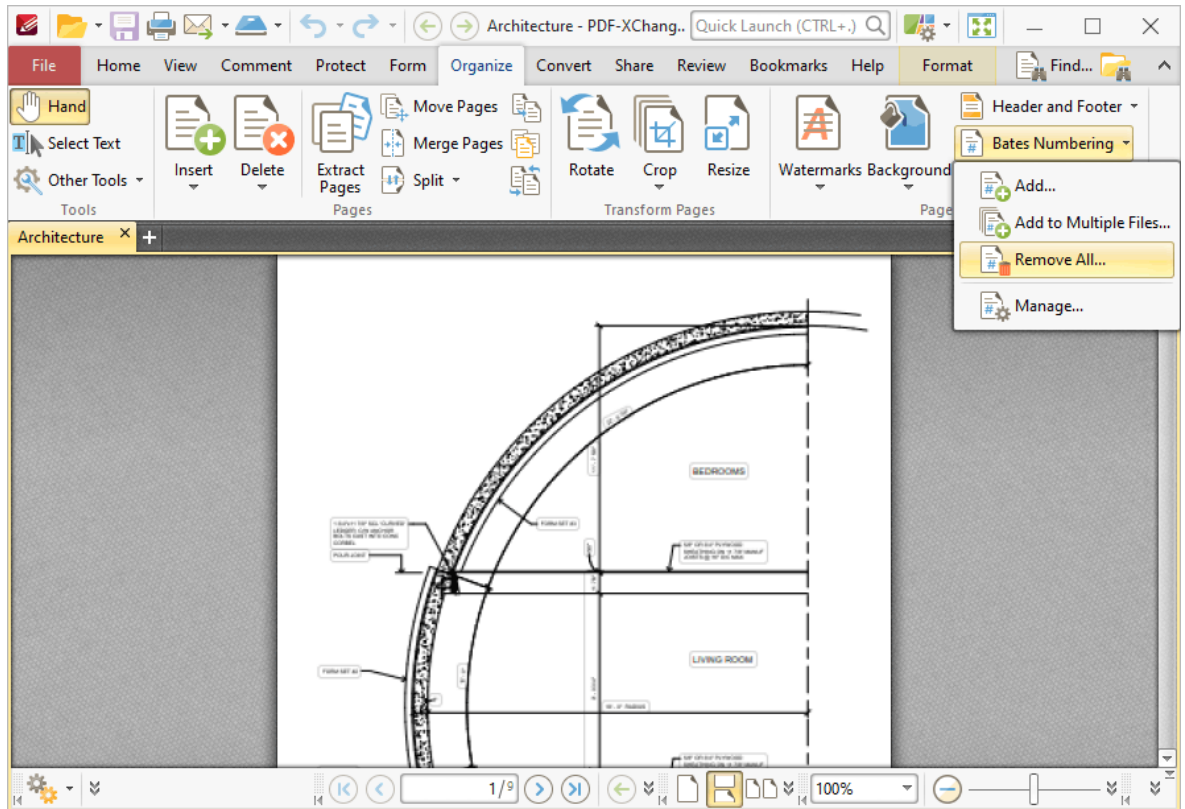

The **Remove Bates Numberings** dialog box will open.

3. Click **Yes**.

### ▼ Remove Cropped Content From Pages

1. Click the **Organize** tab.

2. Click **Crop**, then click **Remove Cropped Content**:

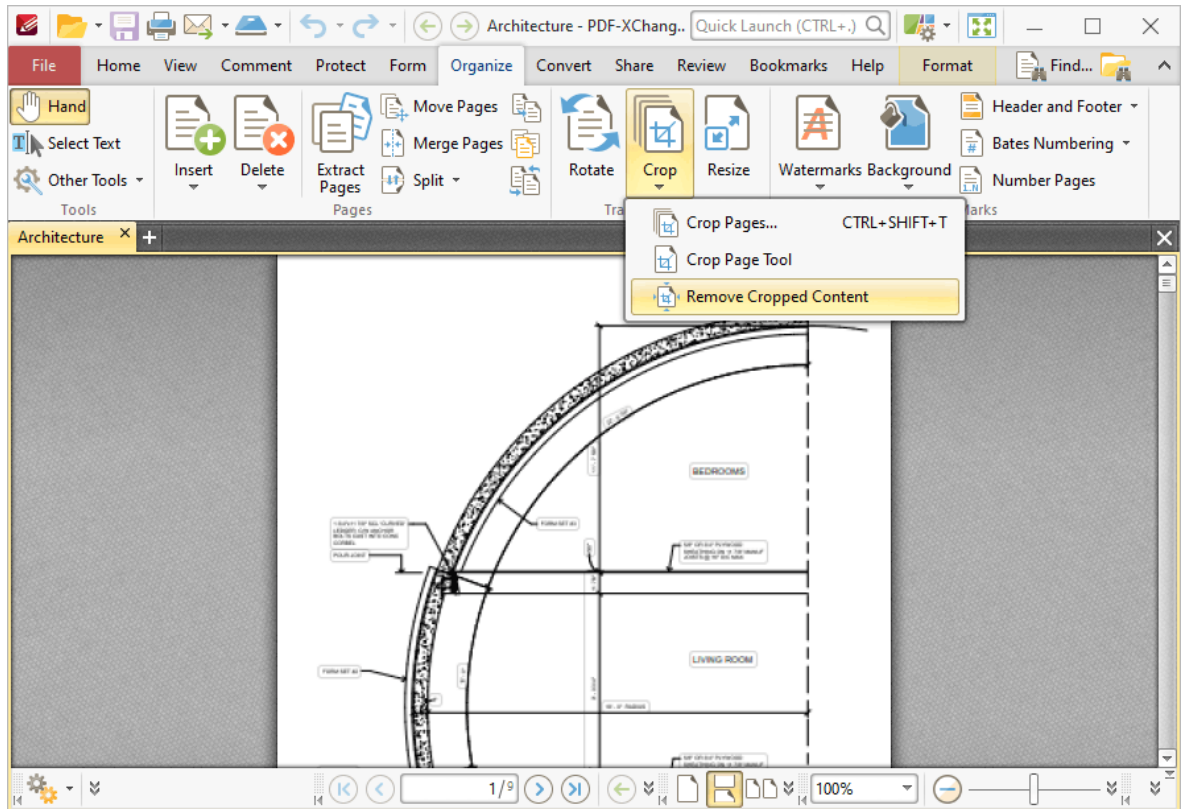

### ▼ Remove Headers and Footers from Documents

1. Click the **Organize** tab.
2. Click **Header and Footer**, then click **Remove All**:

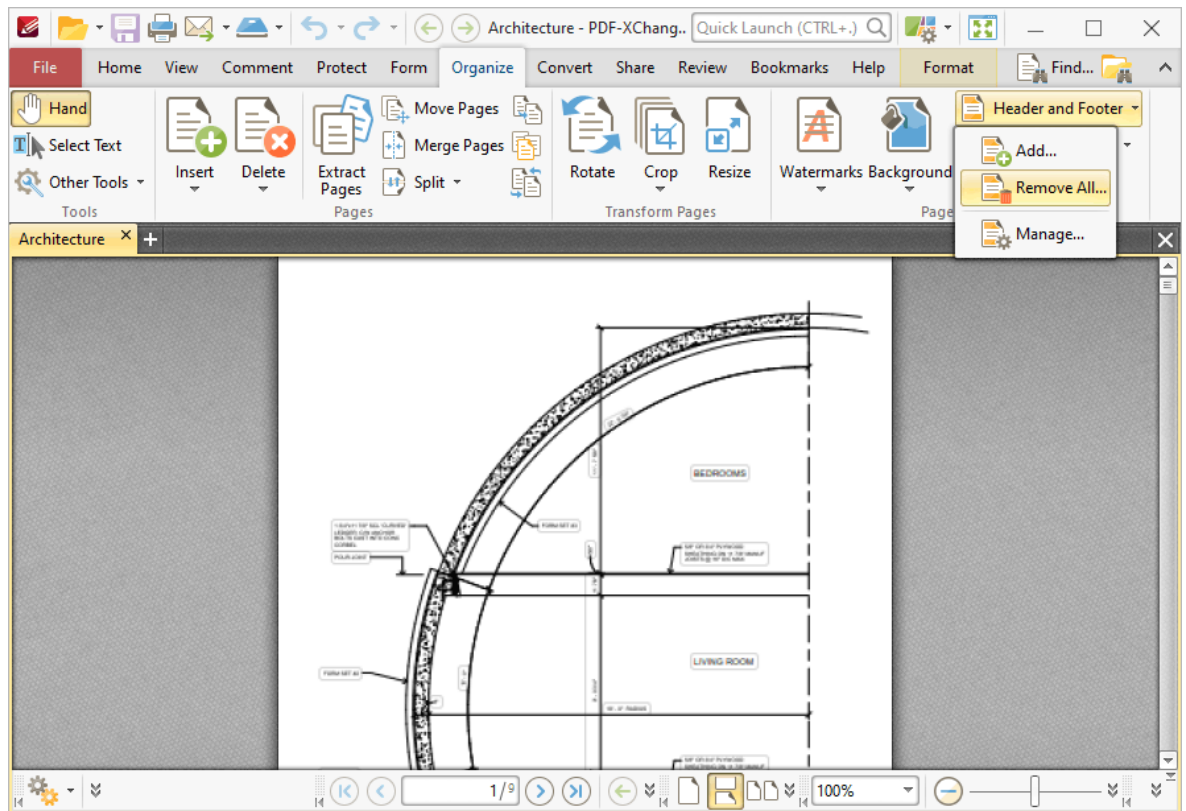

The **Remove Headers and Footers** dialog box will open.

3. Click **Yes**.

#### ▼ **Remove Watermarks from Documents**

1. Click the **Organize** tab.

2. Click **Watermarks**, then click **Remove All**:

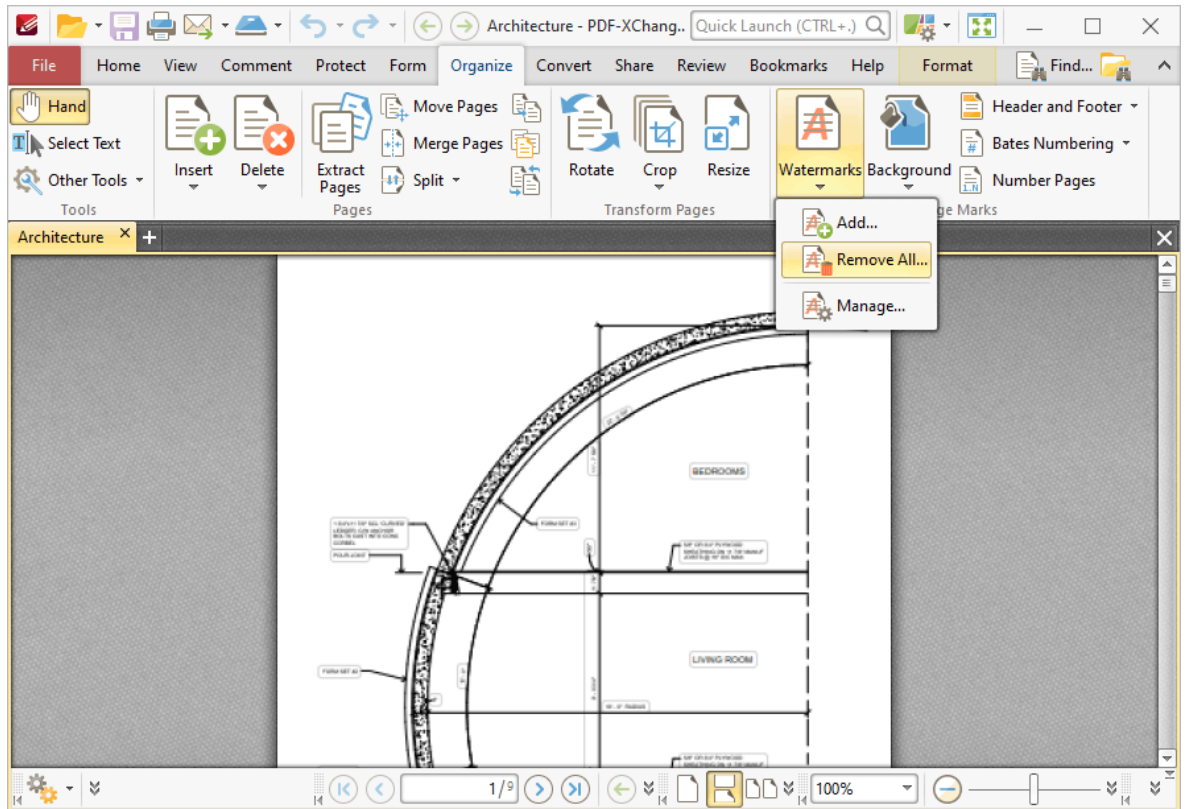

The **Remove Watermarks** dialog box will open.

3. Click **Yes**.

### ▼ Reopen Recently Closed Documents

1. Click the **View** tab.

2. Click the **Document Tabs** dropdown menu, then click **Reopen Recently Closed Document**:



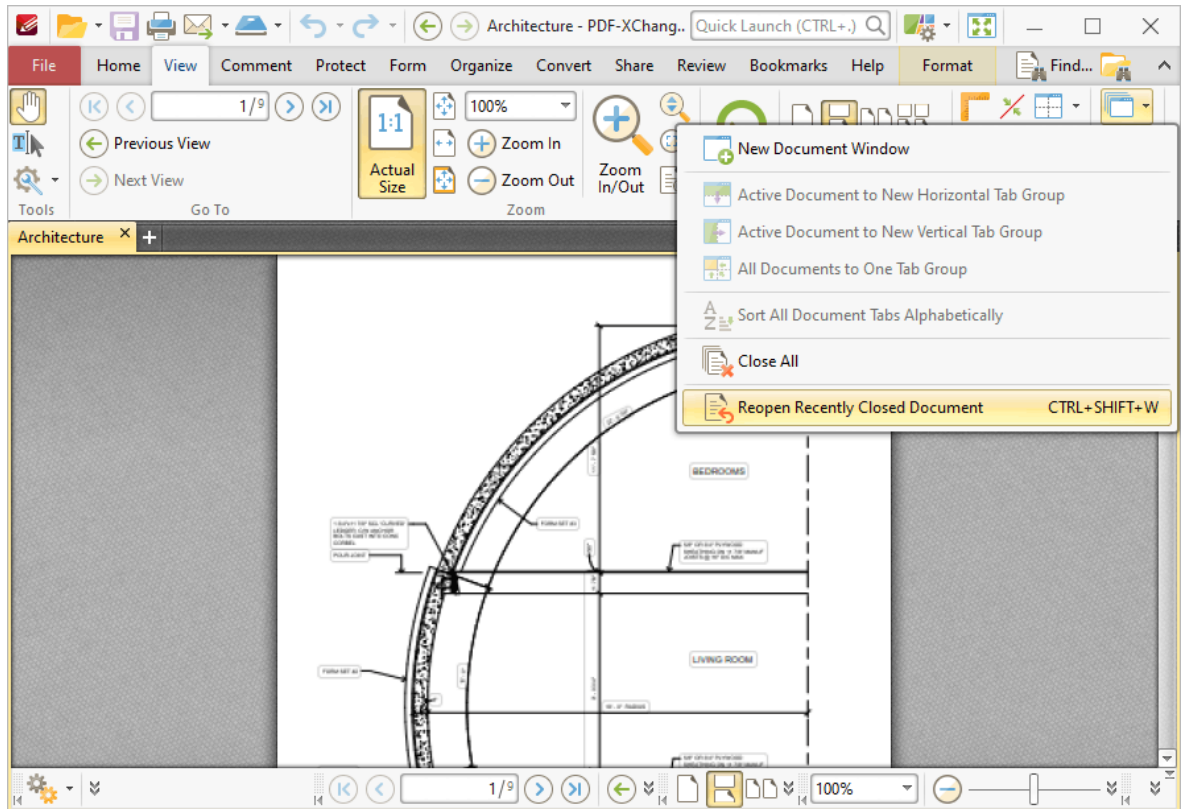

The keyboard shortcut for this operation is Ctrl+Shift+W.

### ▼ Reorder Pages

1. Click the **View** tab.
2. Click the **Panes** dropdown menu, then click **Thumbnails**:

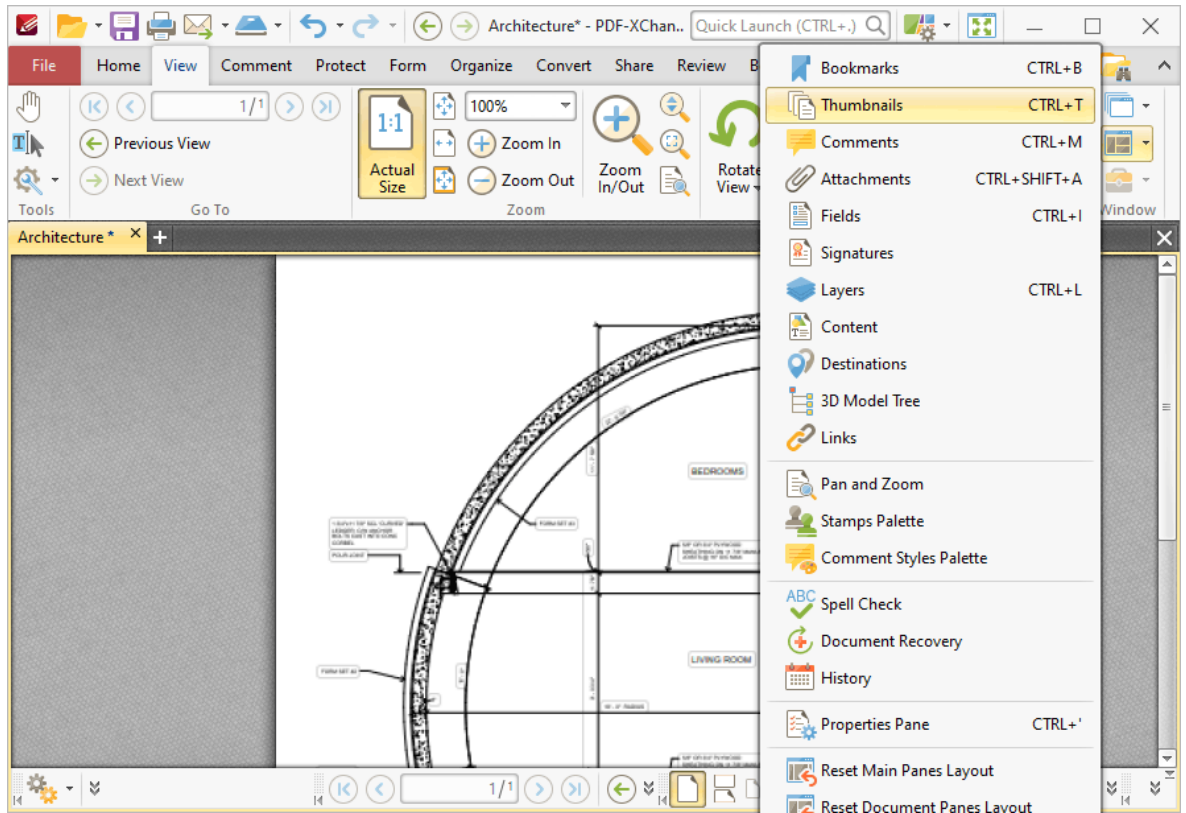

The **Thumbnails** pane will open and display the pages of the current document.

3. Click and drag pages within the pane to reorder them in the active document.

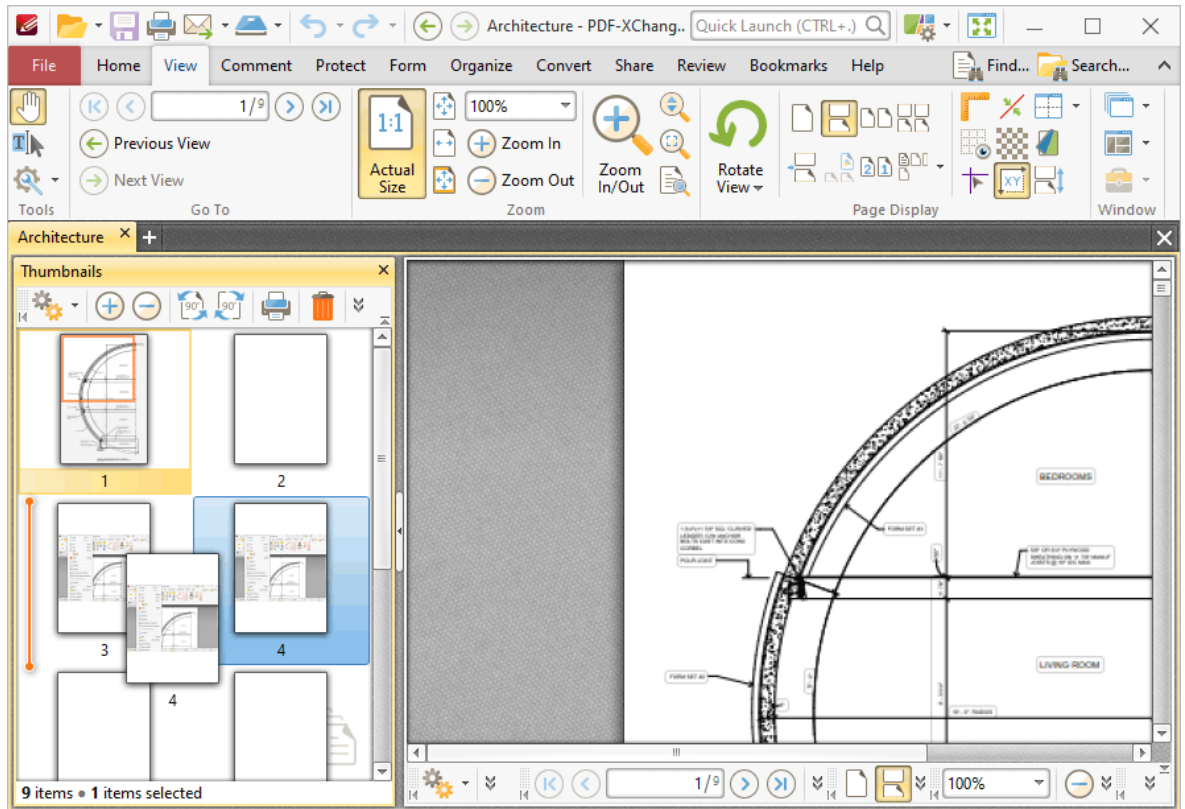

## ▼ Replace Pages

1. Click the **Organize** tab.
2. Click **Replace Pages:**

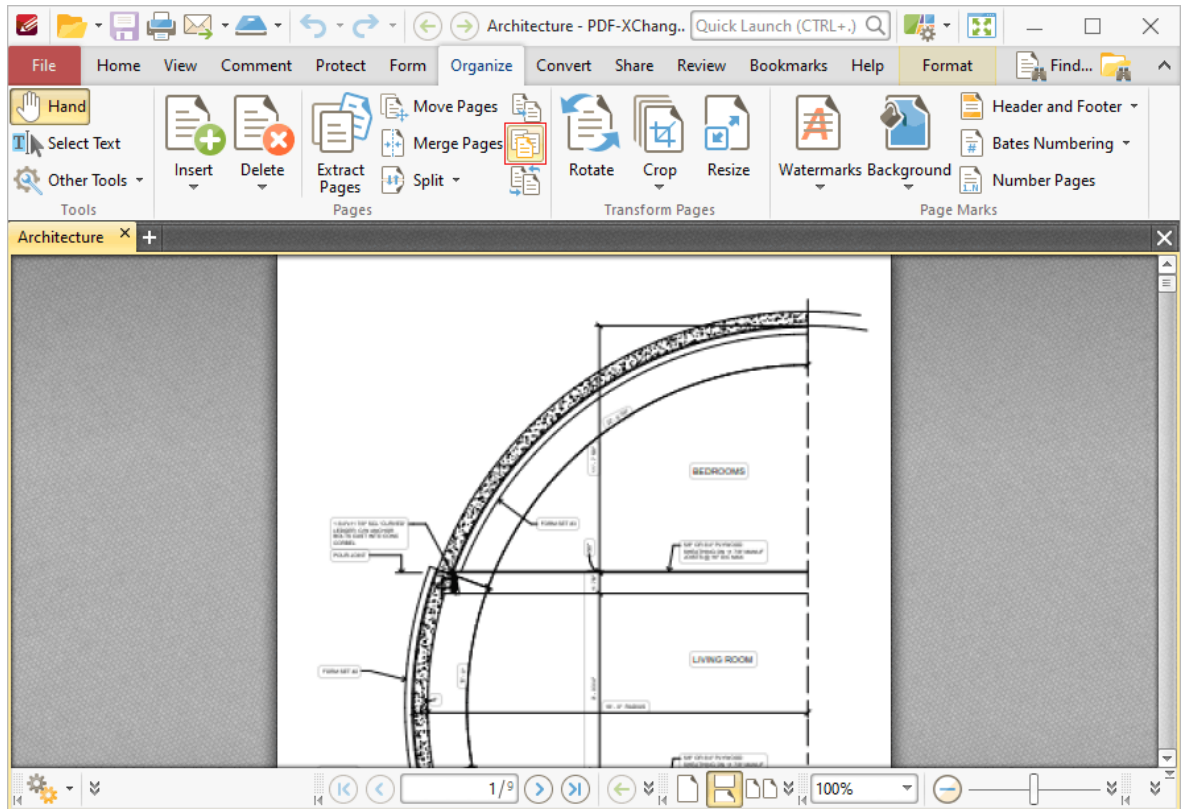

The **Replace Pages** dialog box will open.

3. Determine parameters as detailed [here](#).<sup>1470</sup>

4. Click **OK**.

#### ▼ **Resize Pages**

1. Click the **Organize** tab.

2. Click **Resize Pages**:

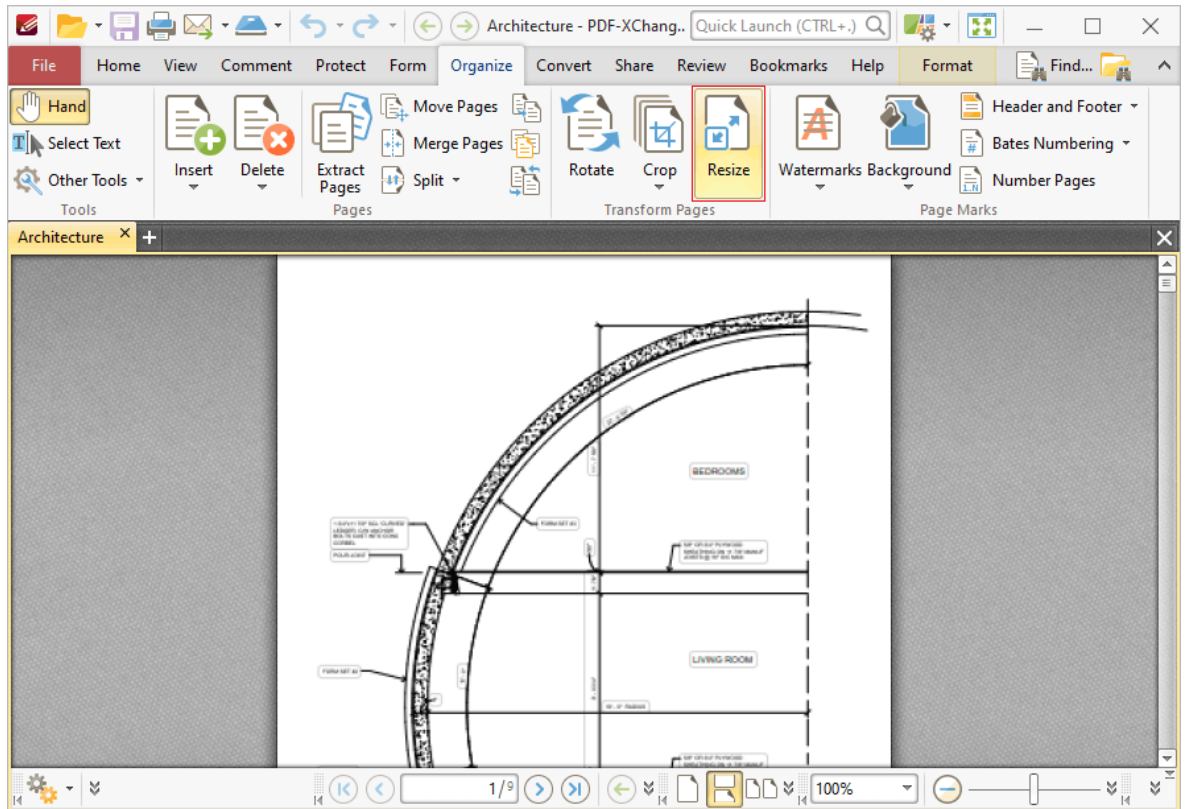

The **Resize Pages** dialog box will open.

3. Determine parameters as detailed [here](#).<sup>1488</sup>

4. Click **OK**.

#### ▼ **Rotate Pages**

1. Click the **Organize** tab.

2. Click **Rotate**:

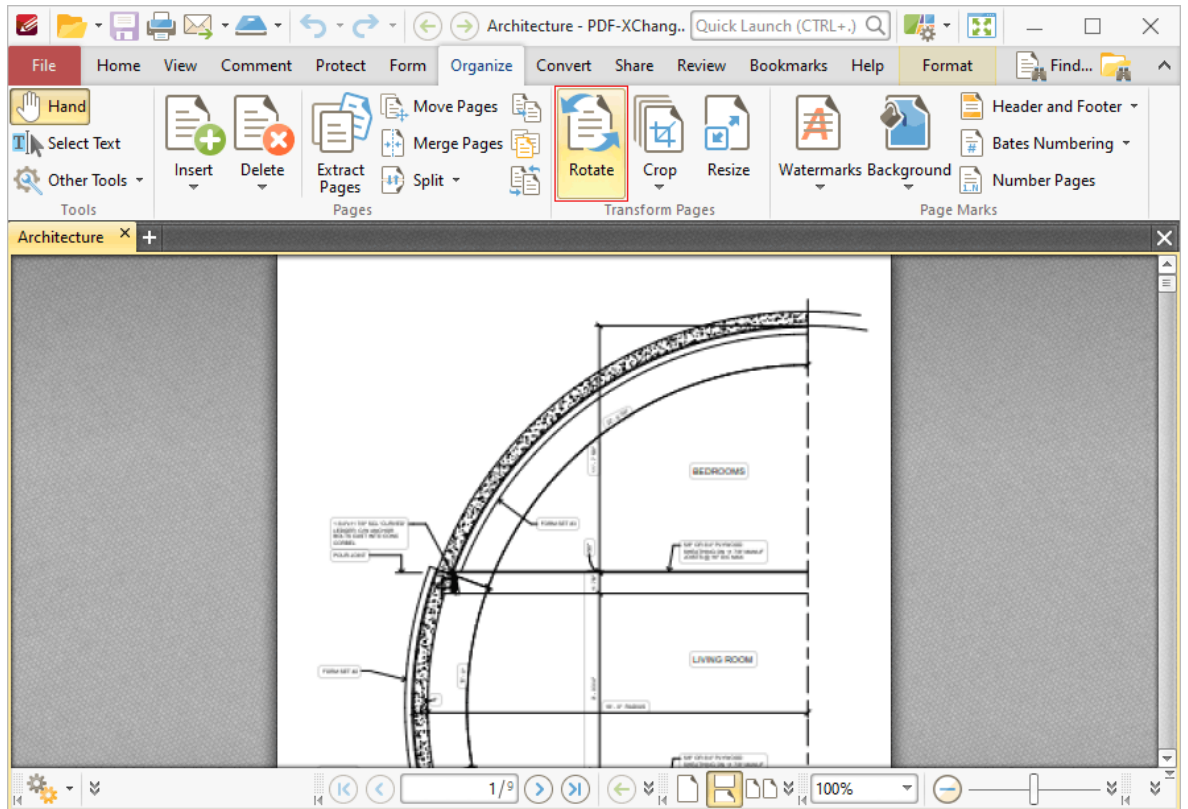

3. The **Rotate Pages** dialog box will open.

4. Determine parameters as detailed [here](#).<sup>1482</sup>

5. Click **OK**.

The keyboard shortcut for this operation is Ctrl+Shift+R.

#### ▼ **Select Document Text**

1. Click the **Home** tab.

2. Click **Select Text**:

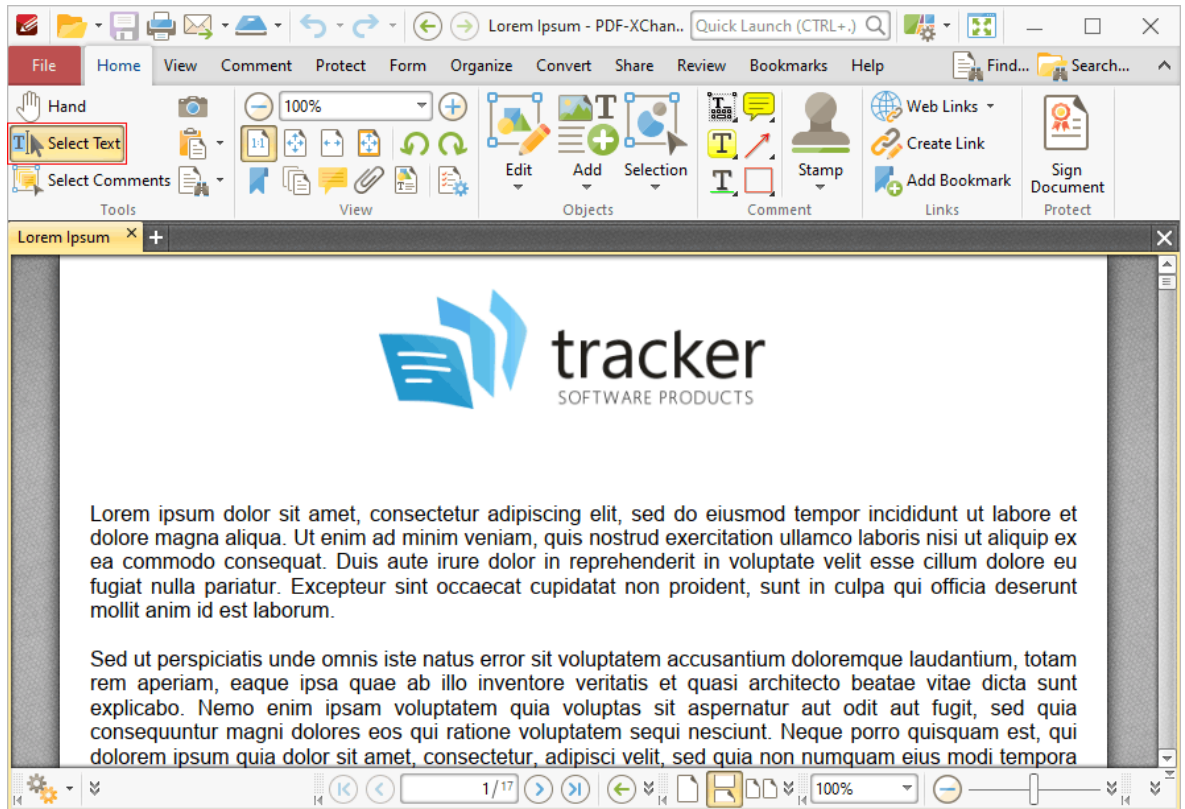

3. Click and drag to select text.

### ▼ Sign Documents

Digital signatures are used to demonstrate the authenticity of documents and increase their security. Follow the instructions below to sign documents:

1. Click the **Protect** tab.
2. Click **Sign Document**:

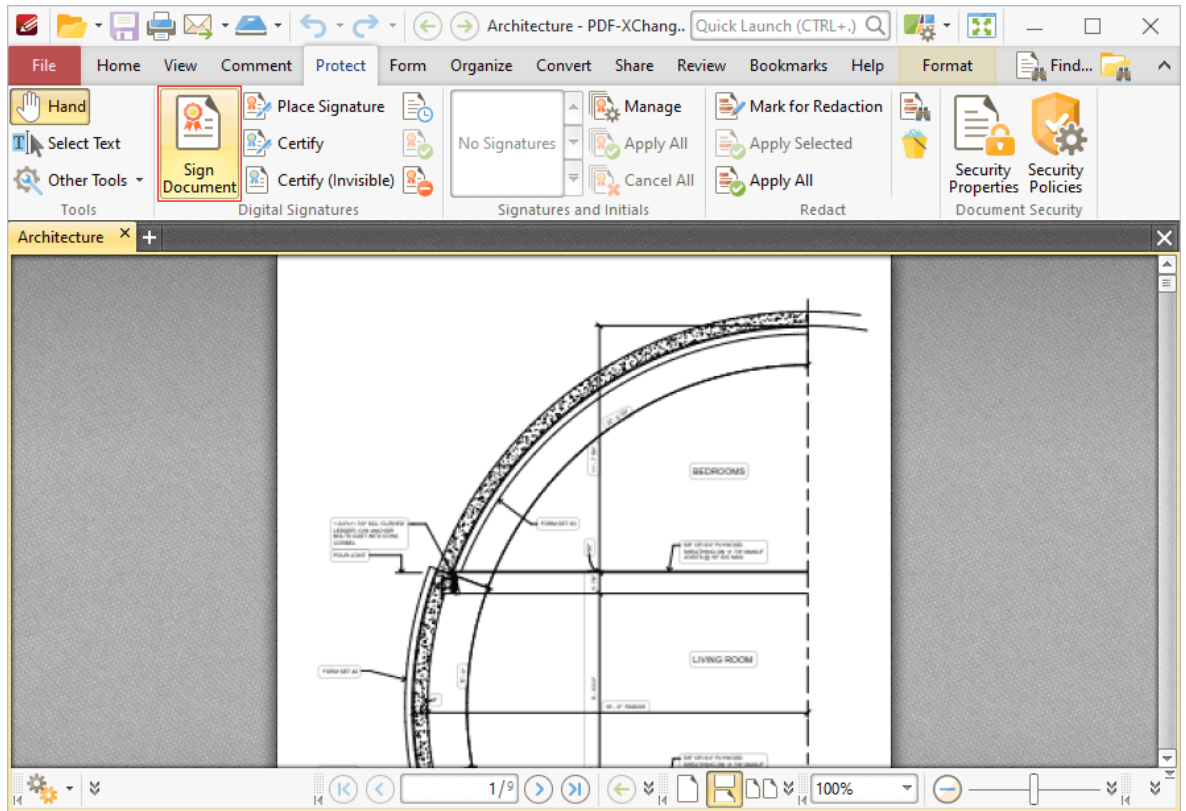

3. Follow the instructions detailed [here](#).<sup>1248</sup>

▼ **Split Document Pages**

1. Click the **Organize** tab.
2. Click **Split**, then click **Split Pages**:



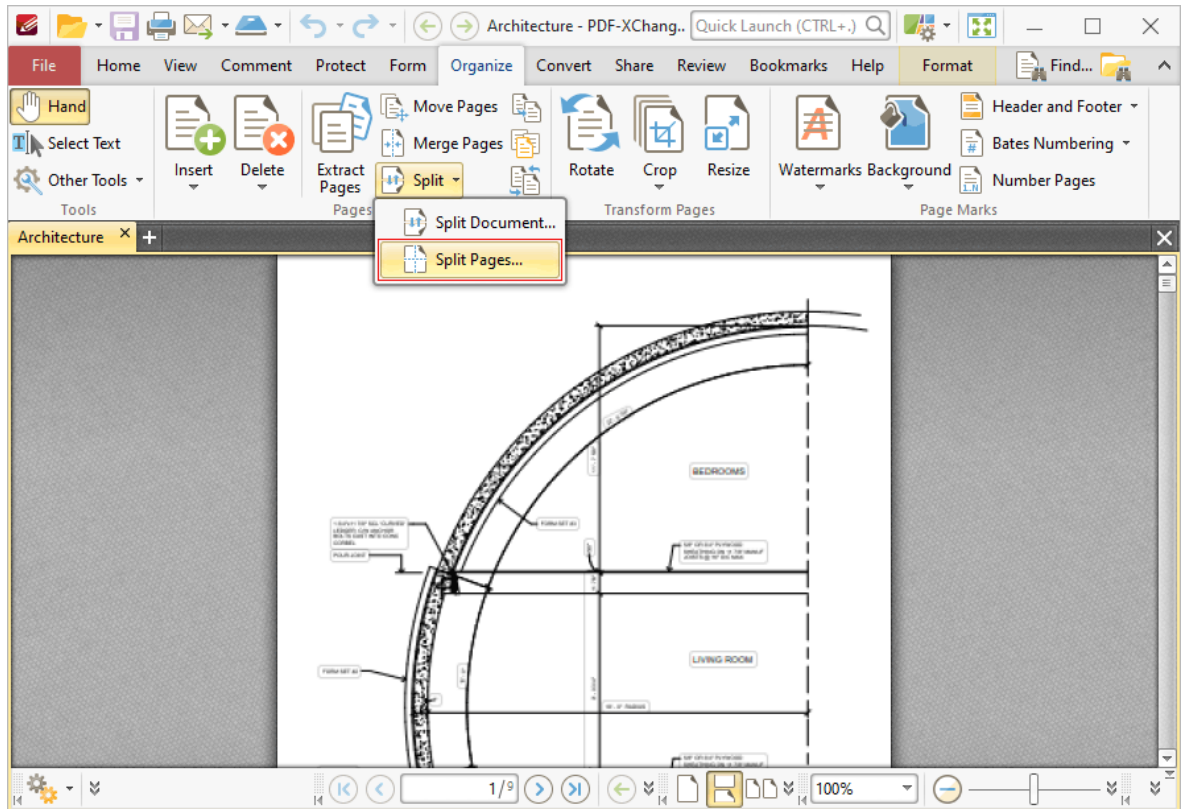

The **Split Pages** dialog box will open.

3. Determine parameters as detailed [here](#).<sup>1473</sup>

4. Click **OK**.

#### ▼ **Split Documents**

1. Click the **Organize** tab.

2. Click **Split**, then click **Split Document**:

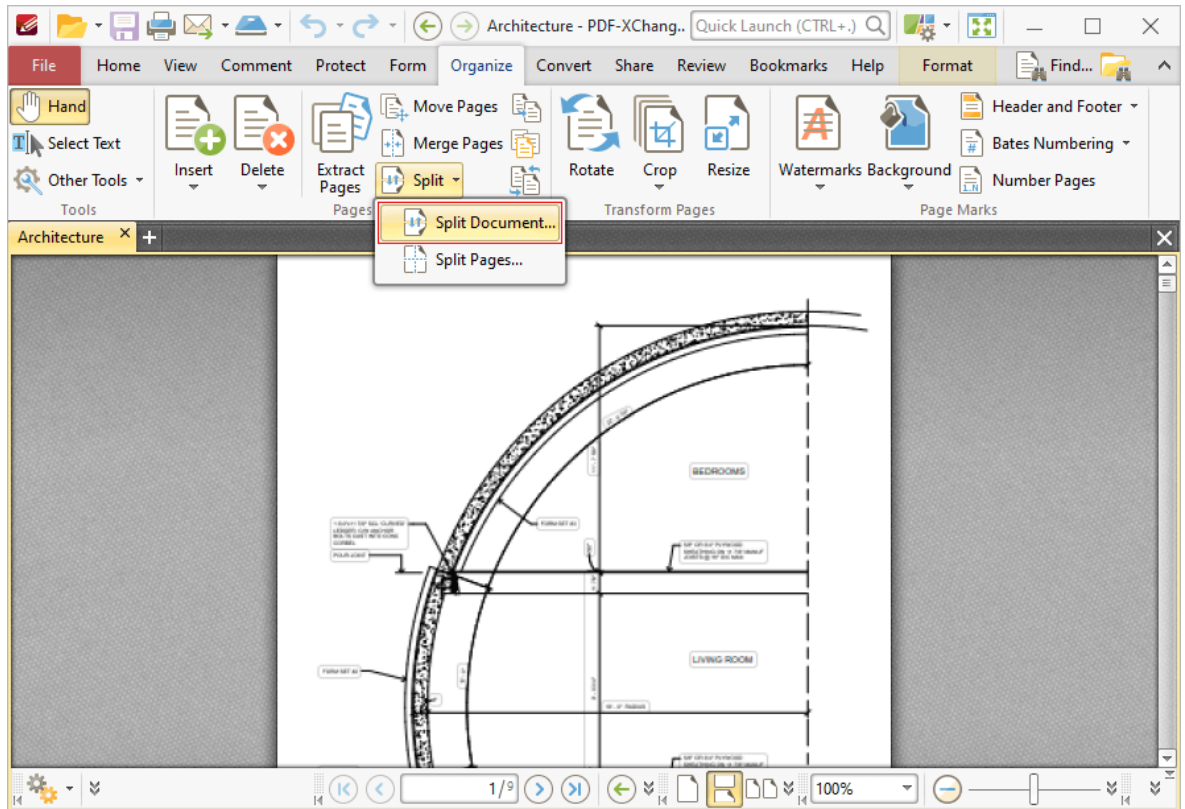

The **Split Document** dialog box will open.

3. Determine parameters as detailed [here](#).<sup>1473</sup>

4. Click **OK**.

#### ▼ **Split the Active Document View into Two Horizontal Sections**

1. Click the **View** tab.

2. Click **Split**, then click **Horizontal Split**:

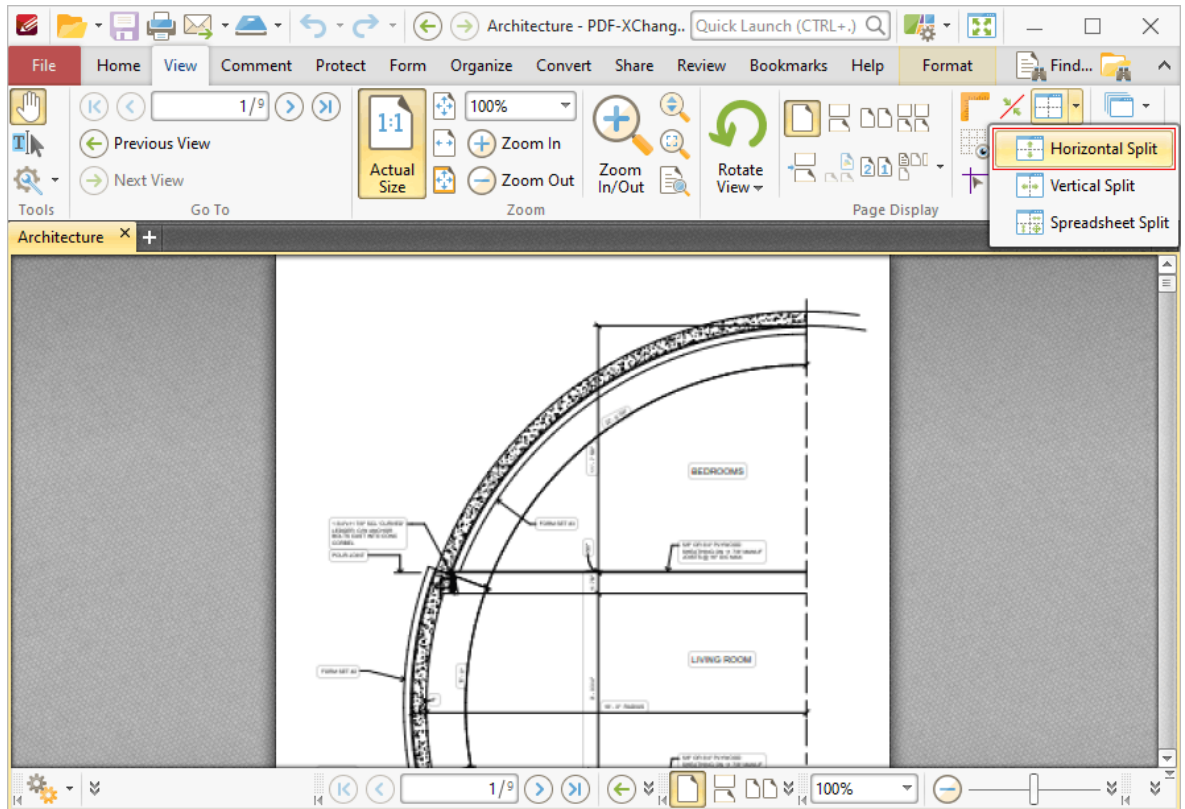

### ▼ Split the Active Document View into Two Vertical Sections

1. Click the **View** tab.
2. Click **Split**, then click **Vertical Split**:

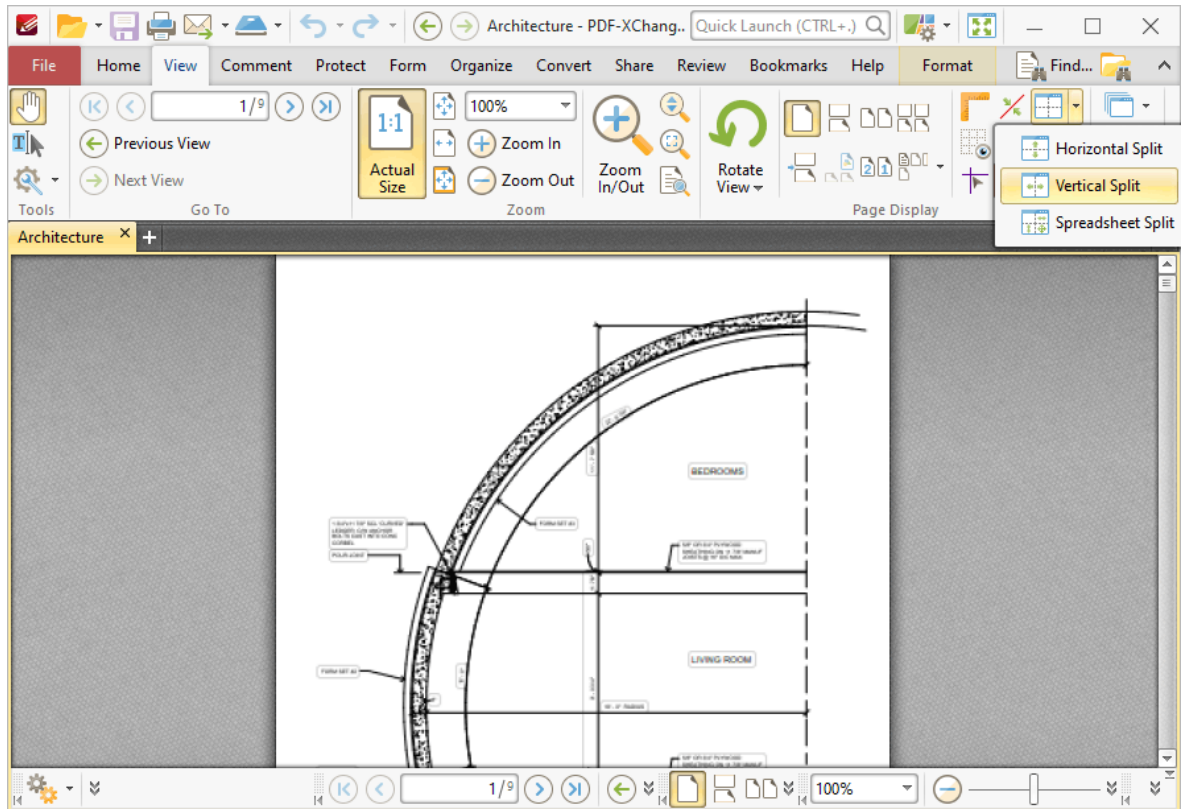

### ▼ Spreadsheet Split the Active Document

1. Click the **View** tab.
2. Click **Split**, then click **Spreadsheet Split**:

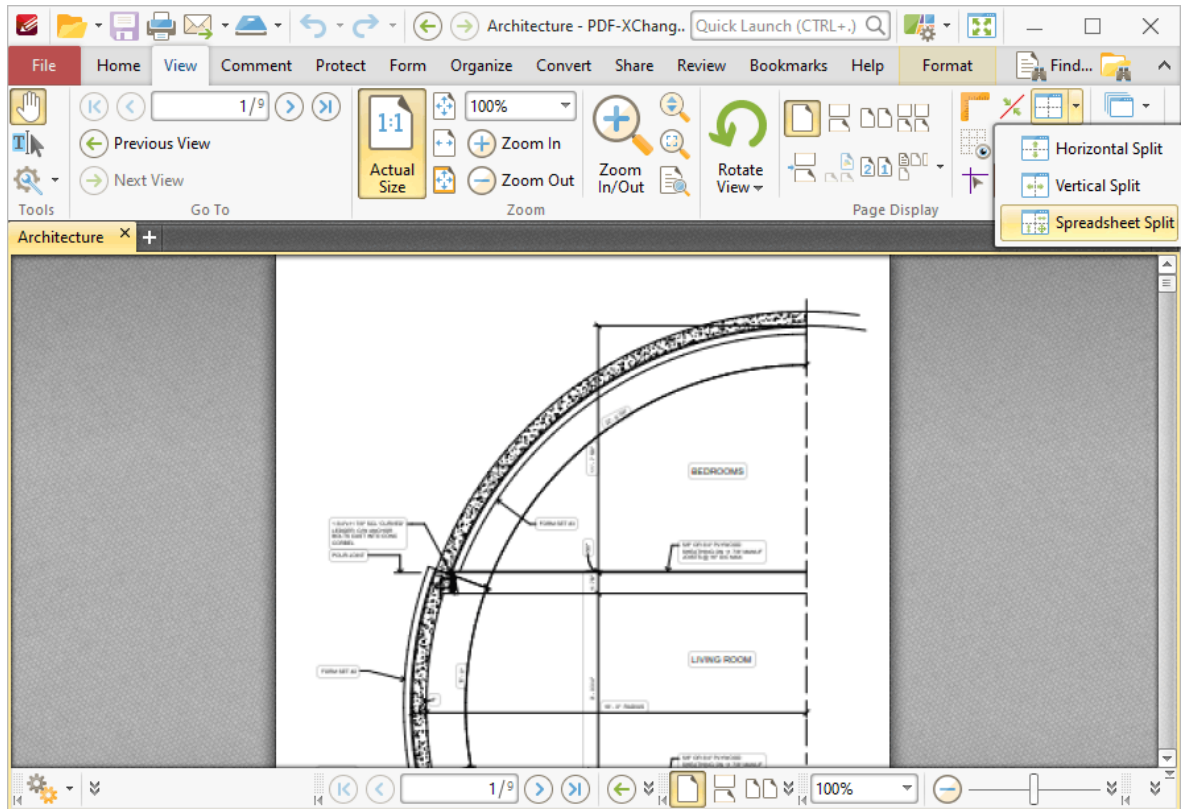

### ▼ Strikeout Document Text

1. Click the **Comment** tab.
2. Click **Strikeout**, then click and drag to strikeout text:

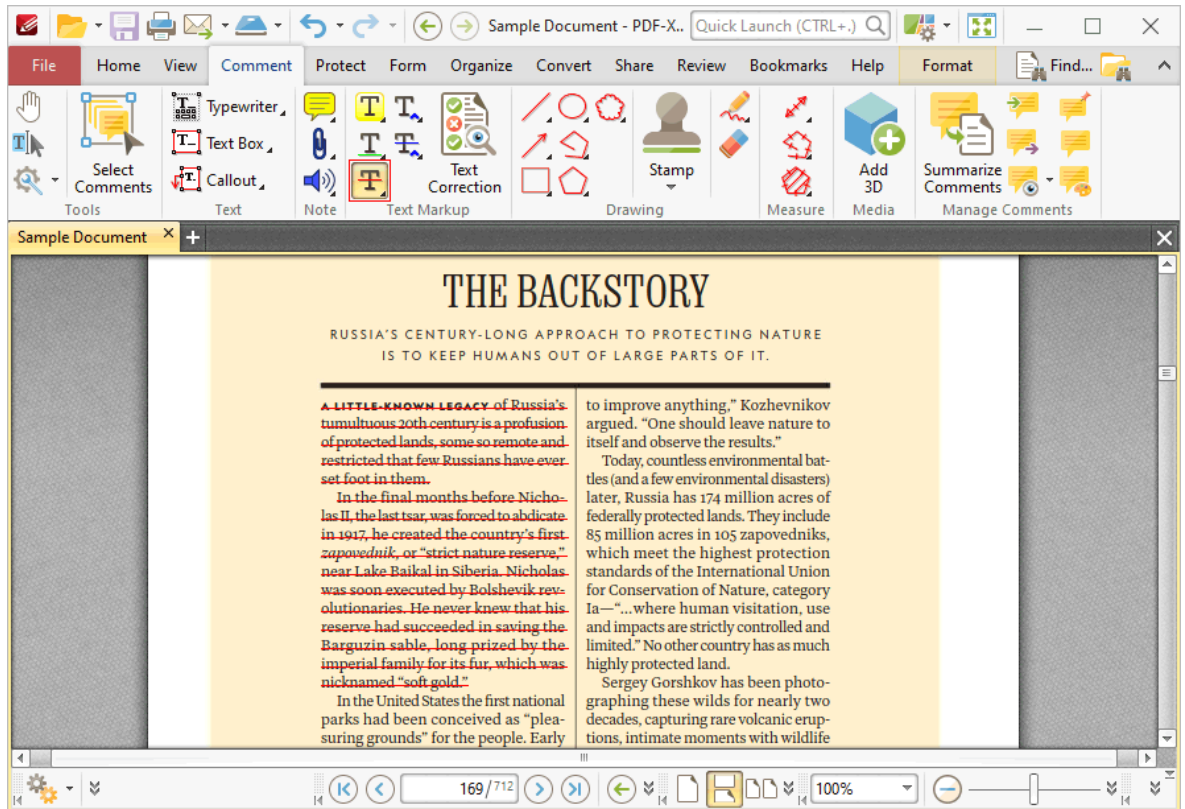

Further information on this feature is available [here](#).<sup>1130</sup>

The keyboard shortcut for this operation is Ctrl+Shift+S.

### ▼ Timestamp Documents

Timestamps are used to ensure the long-term preservation of digital signatures, time-seal date objects (to prove when they were received), protect copyrights/intellectual property and provide notarization services. Follow the instructions below to timestamp documents:

1. Click the **Protect** tab.
2. Click **Timestamp**:

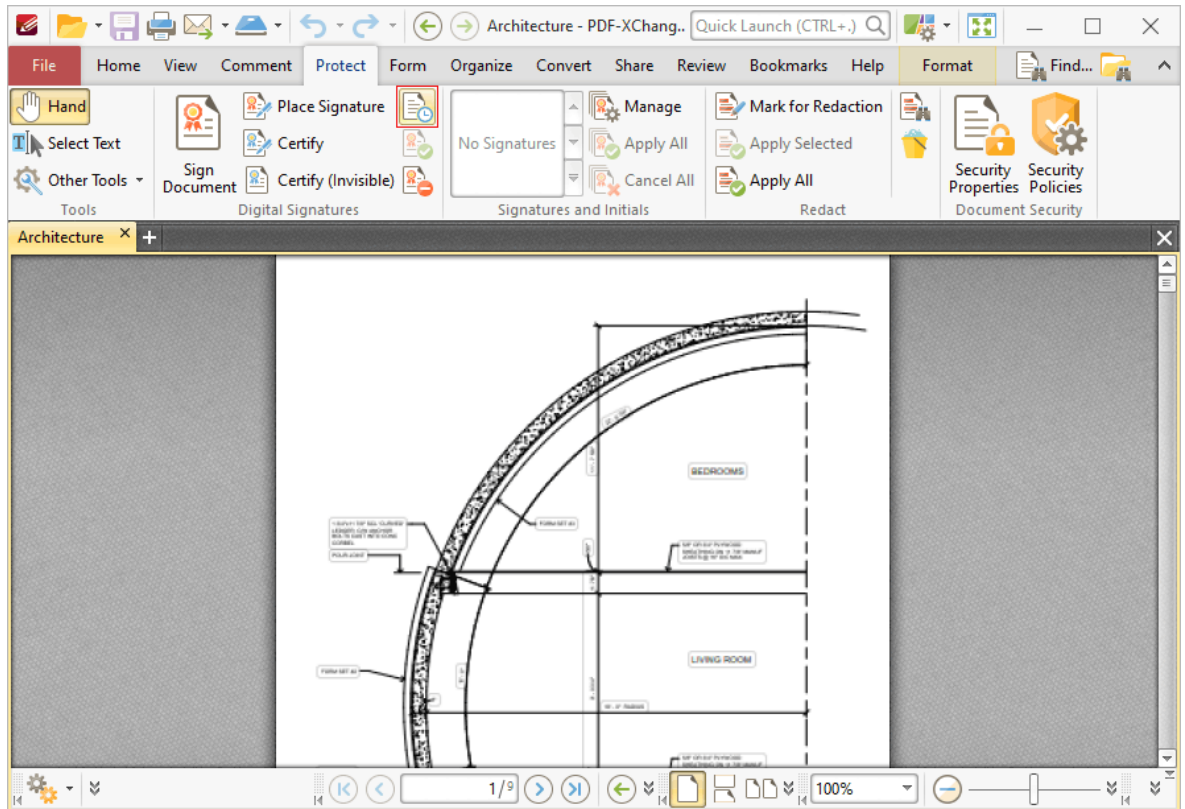

3. Follow the instructions detailed [here](#).

### ▼ Underline Document Text

1. Click the **Comment** tab.
2. Click **Underline**, then click and drag to underline text:

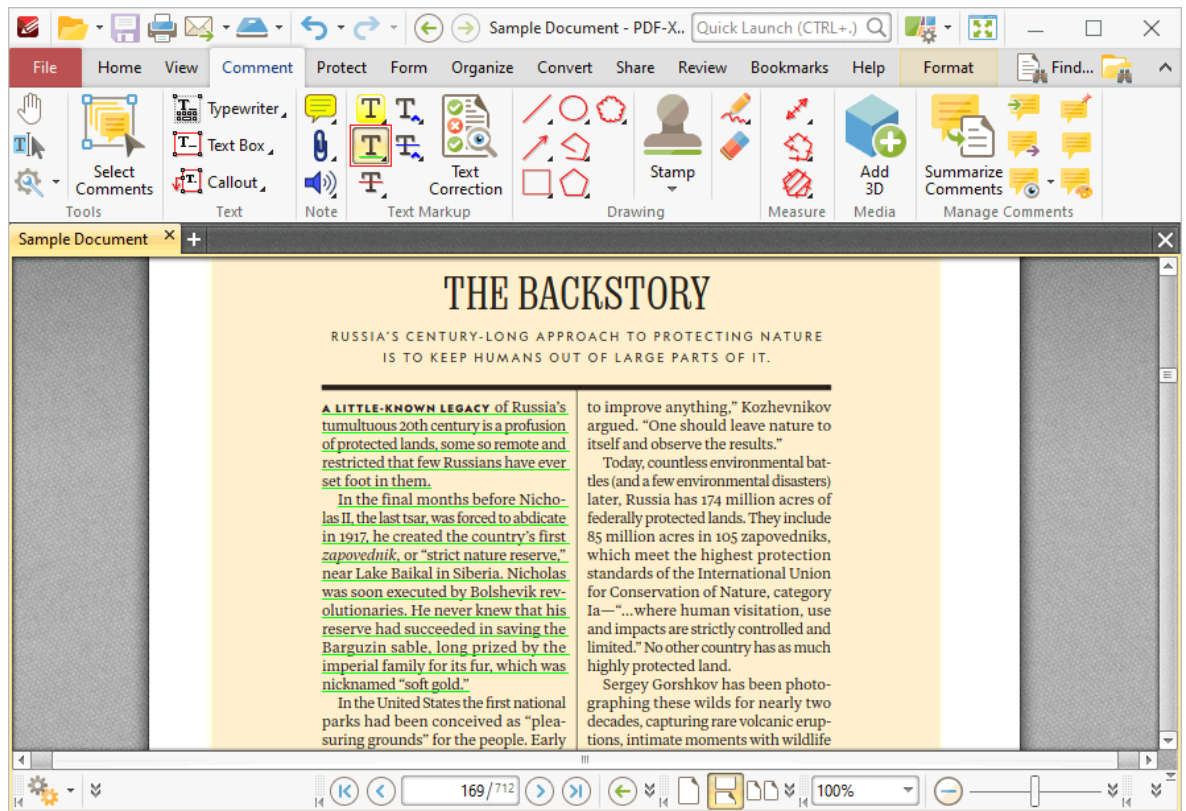

Further information on this feature is available [here](#).<sup>1125</sup>

The keyboard shortcut for this operation is Ctrl+U.

### ▼ Validate Document Signatures

This feature makes it possible for signatures to be validated when the documents that contain them are received. Please note that the default settings of the local computer that receives files may result in this process taking place automatically. Follow the instructions below to validate document signatures:

1. Click the **Protect** tab.
2. Click **Validate All Signatures**:



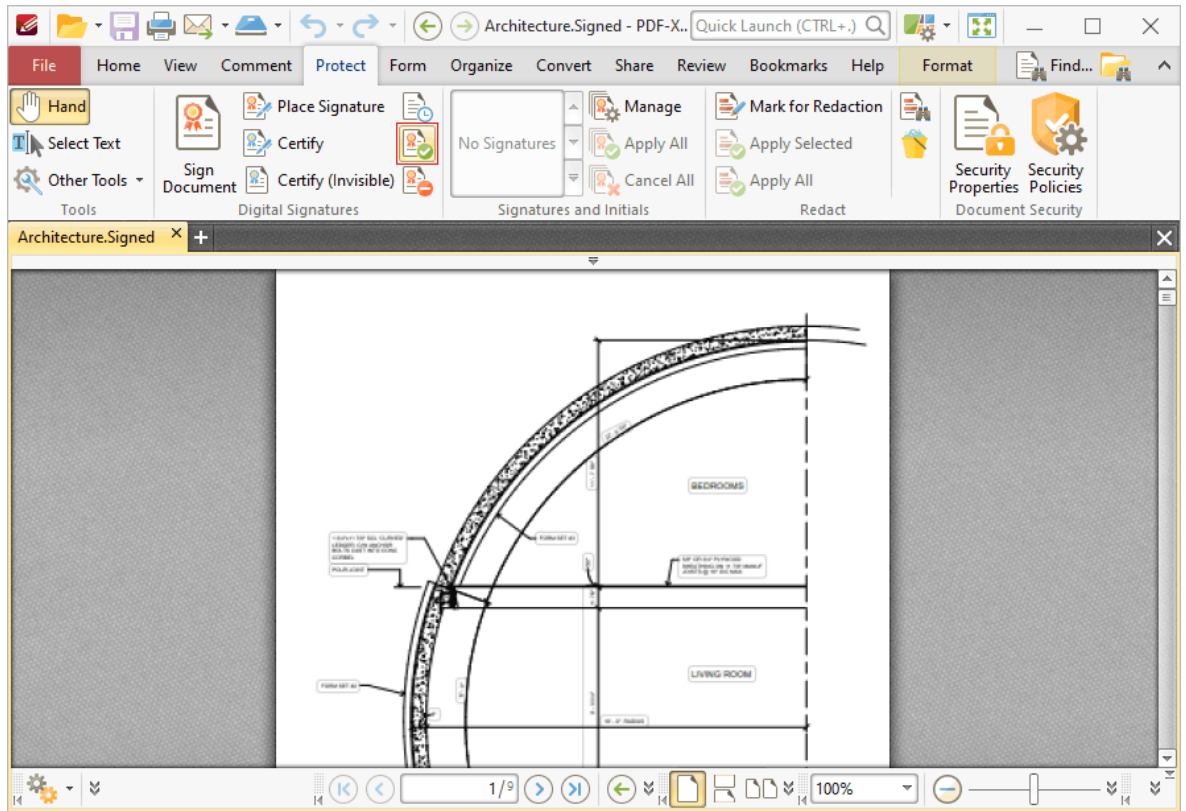

▼ **Zoom to Actual Document Size**

1. Click the **View** tab.
2. Click **Actual Size**:

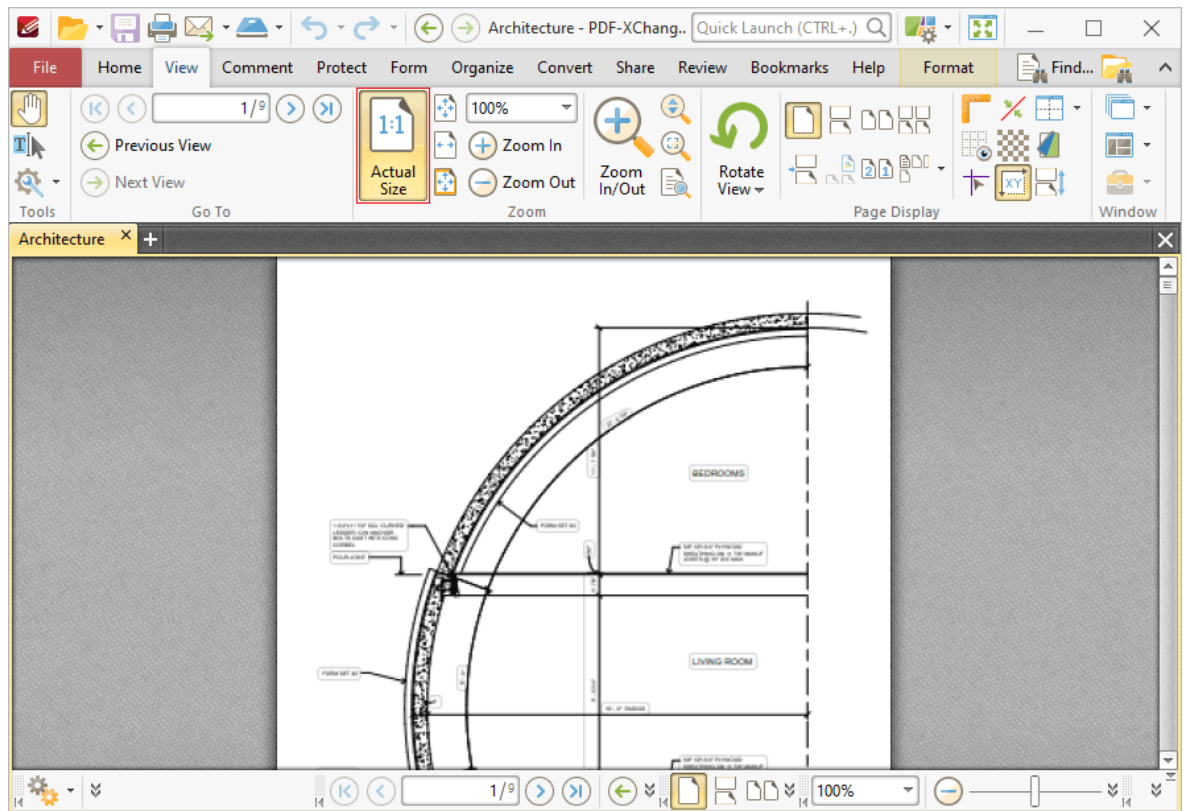

The keyboard shortcut for this operation is Ctrl+1.

Additionally, see the [Forms Guide](#)<sup>744</sup> for further elements that can be added to documents, including check boxes, buttons, digital signatures, dropdown menus, list boxes, radio buttons and text fields.

The [Keyboard Shortcuts](#)<sup>1691</sup> section contains several useful editing shortcuts.

---

### 10.3.3.3 Open Documents

---



## Open Documents

---

There are multiple ways to open documents in **PDF-XChange Editor**. See below for instructions on how to:

#### ▼ Open Documents Located in a Dropbox Folder

1. Click the **File** tab.
2. Click **Add a Place**, then click **Dropbox**. The **Authenticate** dialog box will open.
3. Enter the login details of the **Dropbox** account and click **Sign in**. The **Open File** dialog box will open.
4. Select the desired file and click **Open**.

#### ▼ Open Documents Located in Box.com

1. Click the **File** tab.
2. Click **Add a Place**, then click **Box.com**. The **Box.com Authentication** dialog box will open.
3. Enter the login details of the **Box.com** account and click **Authorize**. The **Open File** dialog box will open.
4. Select the desired file and click **Open**.

#### ▼ Open Documents Located in Microsoft OneDrive

1. Click the **File** tab.

2. Click **Add a Place**, then click **One Drive**. The **One Drive Authentication** dialog box will open.

3. Enter the login details of the **Microsoft One Drive** account and click **Authorize**. The **Open File** dialog box will open.

4. Select the desired file and click **Open**.

#### ▼ **Open Documents Located at a URL**

1. Click the **File** tab.

2. Click **Open from URL**. The **Open a Web Link** dialog box will open.

3. Enter the desired URL in the text box and click **OK**.

#### ▼ **Open Documents Located in a SharePoint Account**

1. Click the **File** tab.

2. Click **Add a Place**, then click **Sharepoint**. The **SharePoint URL** dialog box will open.

3. Enter the address of the file in the text box and click **Connect**.

#### ▼ **Open Documents Located on a Google Drive**

1. Click the **File** tab.

2. Click **Add a Place**, then click **Google Drive**. The **Google Drive Authentication** dialog box will open.

3. Enter the login details of the **Google Drive** account and sign in.

4. Double-click the desired file.

#### ▼ **Open Documents Located on the Local Computer**

1. Click the **File** tab.

2. Click **Browse**.

3. Select the desired file and click **Open**.

The keyboard shortcut for this operation is Ctrl+O.

---

### 10.3.3.4 Miscellaneous Document Operations

---



## Miscellaneous Document Operations

---

There are multiple further options that relate to document-level operations within **PDF-XChange Editor**. See below for instructions on how to:

### ▼ Add JavaScript to Documents

JavaScript is an object-oriented computer programming language that is used to create interactive effects within documents/web browsers. Follow the instructions below to add JavaScript to documents:

1. Click the **File** tab, then click **Document Properties**.
2. Click **JavaScript** in the **Categories** menu.
3. Click the **Add** button. The **JavaScript Editor** dialog box will open.
4. Enter a name for the Javascript, then enter the new JavaScript in the text box.
5. Click **OK**.

Note that JavaScript preferences can be determined [here](#).<sup>891</sup>

### ▼ Check for Product Updates

1. Click the **Help** tab.
2. Click **Check for Updates**.

### ▼ Close All Active Documents

1. Click the **File** tab.

2. Click **Close All**.

#### ▼ Close Documents

1. Click the **File** tab.
2. Click **Close**. Alternatively, click the cross located at the top-right of the document name in the document tab.

#### ▼ Convert Documents to a Different Format

1. Click the **File** tab.
2. Click **Save As**, then click **Browse**. The **Save File As** dialog box will open.
3. Select the desired format in the **Save as type** dropdown menu.
4. Click **Save**.

#### ▼ Convert Named Destinations into Regular Destinations

Named destinations are user-defined locations in documents that operate in a similar manner to bookmarks, with the difference that they remain constant when pages are moved or deleted. They can be used in conjunction with [Bookmarks](#),<sup>[994]</sup> [Go To Page](#)<sup>[965]</sup> actions and the [/Open](#)<sup>[1674]</sup> command line to navigate to specified locations. Follow the instructions below to convert named destinations into regular destinations. Further information on named destinations is available [here](#).<sup>[1036]</sup>

1. Click the **Bookmarks** tab
2. Click **Convert Named Destinations To Regular Destinations**.
3. Follow the instructions detailed [here](#).<sup>[1573]</sup>

#### ▼ Convert Text into Named Destinations

Named destinations are user-defined locations in documents that operate in a similar manner to bookmarks, with the difference that they remain constant when pages are moved or

deleted. They can be used in conjunction with [Bookmarks](#), [Go To Page](#) actions and the [/Open](#) command line to navigate to specified locations. Follow the instructions below to convert document text into named destinations. All instances of the specified text will be turned into a separate named destination. Further information on named destinations is available [here](#).

1. Click the **Bookmarks** tab.
2. Click **Convert to Named Destinations**.
3. Follow the instructions detailed [here](#).

#### ▼ Create Named Destinations

Named destinations are user-defined locations in documents that operate in a similar manner to bookmarks, with the difference that they remain constant when pages are moved or deleted. They can be used in conjunction with [Bookmarks](#), [Go To Page](#) actions and the [/Open](#) command line to navigate to specified locations. Follow the instructions below to create named destinations:

1. Move to the desired new named destination location.
2. Click the **View** tab, then click the **Panes** dropdown menu and click **Destinations**. The **Named Destinations** pane will open.
3. Click the **New Destination** button. A new entry will appear in the **Named Destinations** pane. Further information on named destinations is available [here](#).

#### ▼ Create JavaScript Links

1. Click the **Home** tab, then click **Create Link**.
2. Click and drag the pointer to determine the size and location of the link. The **Browse for Link Target** dialog box will open:



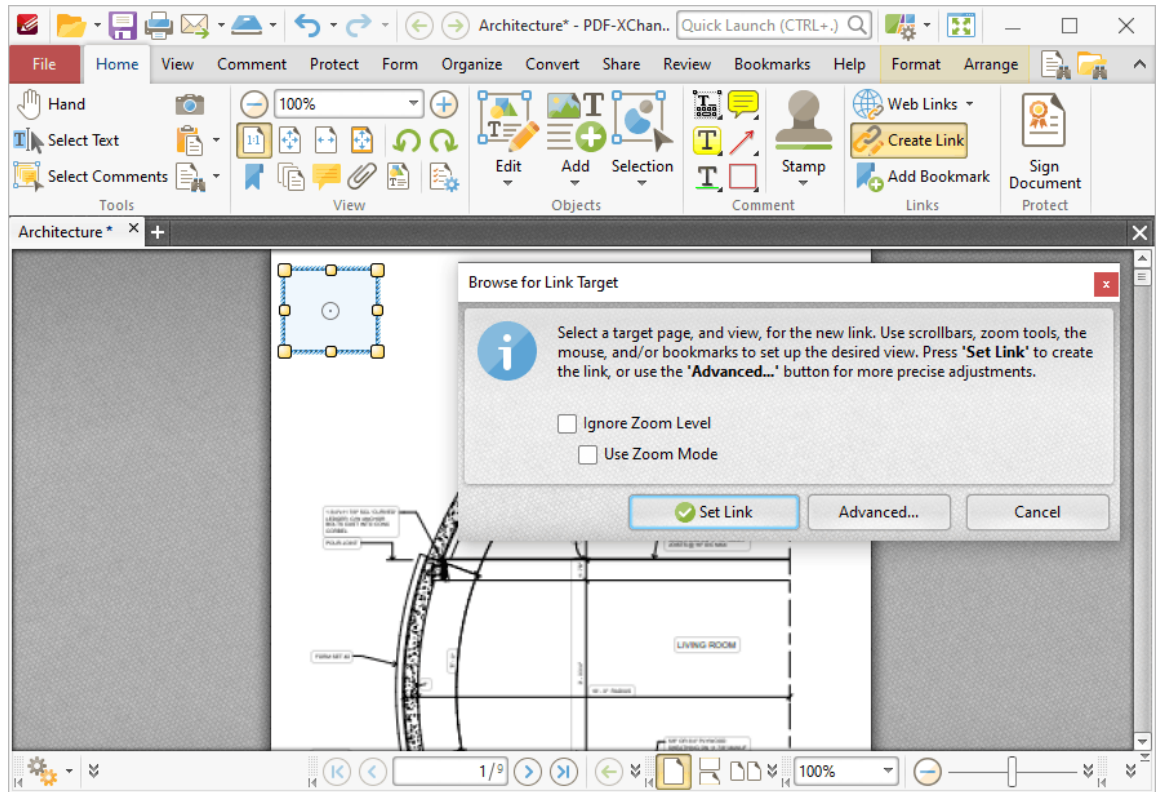

3. Click **Advanced**. The **Edit Action List** dialog box will open and the **Add** dropdown menu will be expanded:

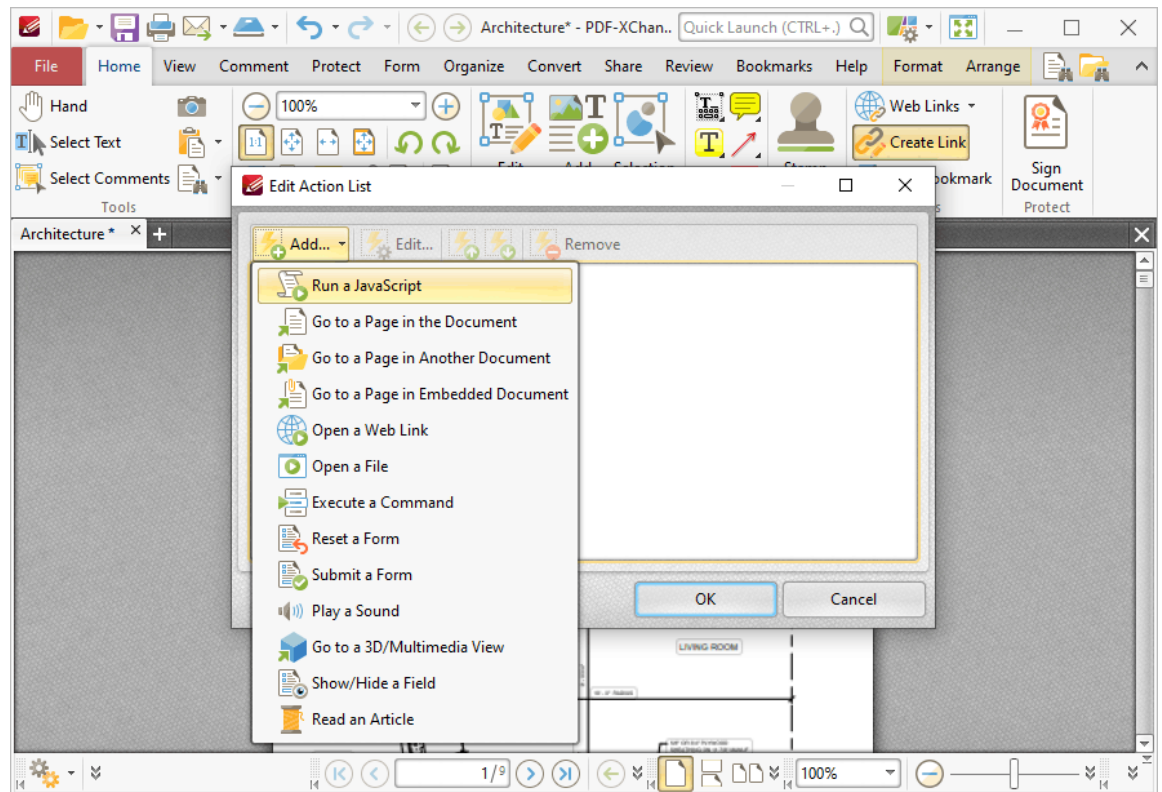

4. Click **Run a JavaScript**. The **Add Action: "Run a JavaScript"** dialog box will open. Enter the desired JavaScript and click **OK** to create the JavaScript link.

### ▼ Delete JavaScript

1. Click the **File** tab, then click **Document Properties**. The **Document Properties** dialog box will open.
2. Click **JavaScript** in the **Categories** menu.
3. Select the desired JavaScript and click **Delete**.

### ▼ Duplicate Document Pages

1. Click the **Organize** tab.
2. Click **Duplicate Pages**. The **Duplicate Pages** dialog box will open.
3. Follow the instructions detailed [here](#).

### ▼ Edit JavaScript

1. Click the **File** tab, then click **Document Properties**. The **Document Properties** dialog box will open.
2. Click **JavaScript** in the **Categories** menu.
3. Select the desired JavaScript and click **Edit**. The **JavaScript Editor** dialog box will open.
4. Edit the JavaScript as desired and click **OK** to save.

The keyboard shortcut for this operation is Ctrl+J.

### ▼ Email Documents

This feature emails documents directly from **PDF-XChange Editor**. It uses the mailing parameters defined in the **Send Mail** section of the **Preferences** settings, which can be determined [here](#). Follow the instructions below to email documents:

1. Click the **Send by E-Mail** icon in the **Quick Access Toolbar**, which is located in the upper-left section of the user interface. The default email client will open.
2. Enter the name of the recipient and send the email.

Further information on email preferences is available [here](#).

### ▼ Enable/Disable Stroke Adjust

This feature is used to specify that the line widths and coordinates of strokes are adjusted automatically to produce strokes of uniform thickness. This is performed in order to

compensate for the effects of rasterization and fit lines (and other figures) more precisely to the pixel grid of monitors and other displays.

1. Click the **File** tab, then click **Preferences**. The **Preferences** dialog box will open.
2. Click **Page Display** in the **Categories** menu.
3. Click the **Rendering** button, then use the **Stroke Adjust** dropdown menu to enable/disable stroke adjust as desired.

Further information on this feature is available [here](#).<sup>863</sup>

### ▼ **Enhance Scanned Pages**

This feature is used to enhance the quality of scanned pages:

1. Click the **Convert** tab.
2. Click **Enhance Scanned Pages**.
3. Follow the instructions detailed [here](#).<sup>1526</sup>

### ▼ **Export Selected Content to a New PDF Document**

This feature copies and exports content selected in the current document to a new document:

1. Click the **Home** tab, then click **Edit Content**.

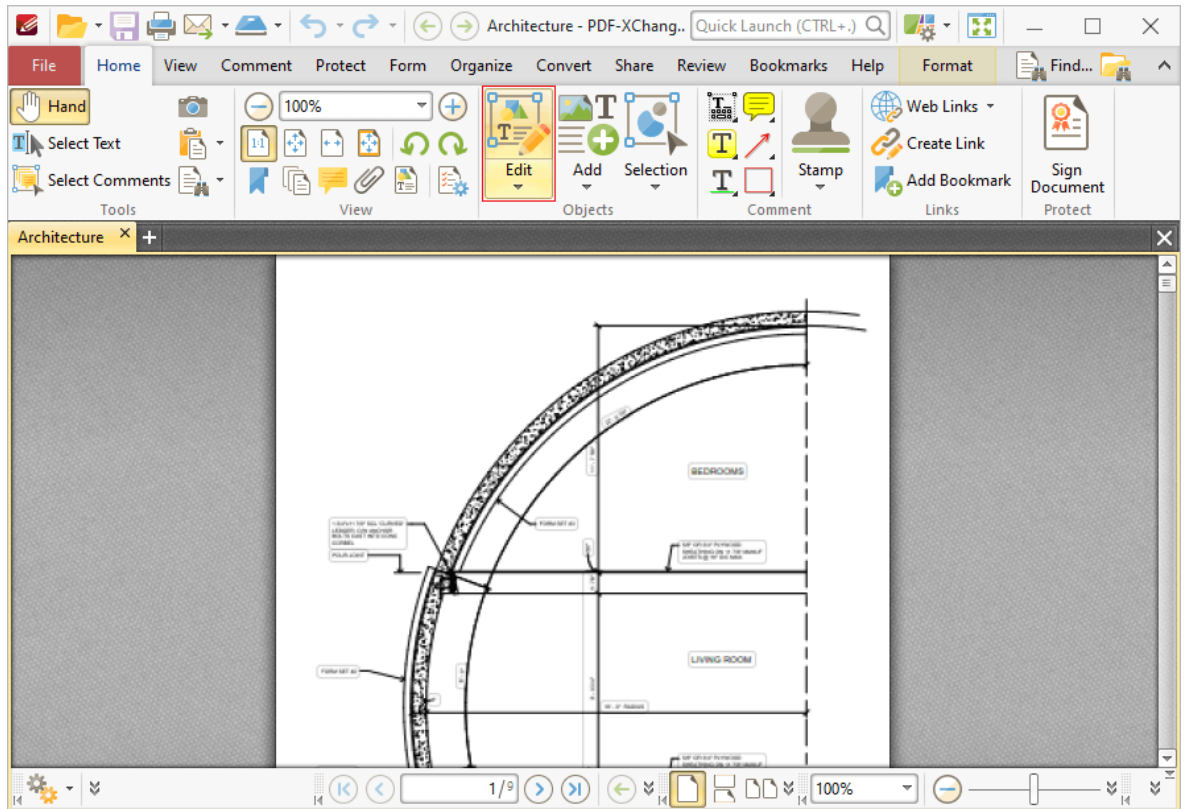

2. Click and drag to select content, then right-click the selection and click **New Document from Selection** in the shortcut menu.

#### ▼ Export Selected Content to a New Stamp

This feature exports content selected in the current document to a new stamp that can be used in conjunction with the [Stamp Tool](#): 

1. Click the **Home** tab, then click **Edit Content**:

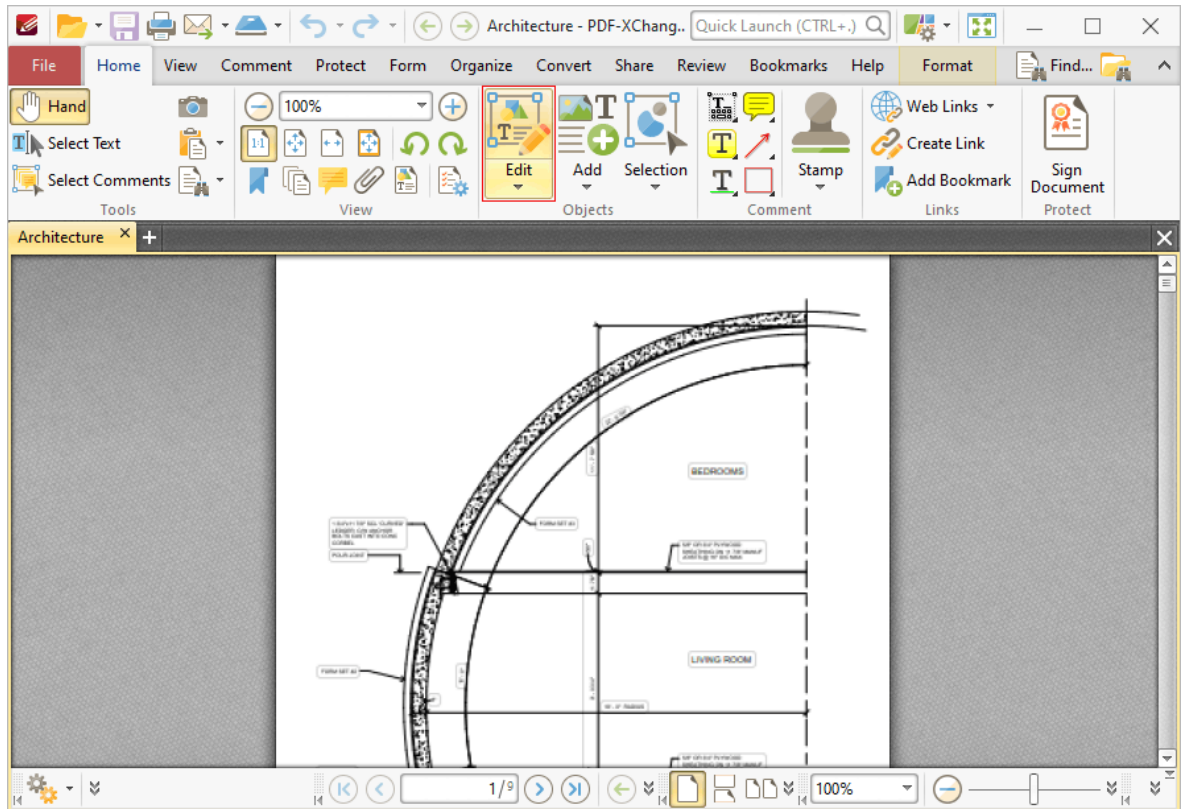

2. Click and drag to select content, then right-click the selection and click **New Stamp from Selection** in the shortcut menu.

Note that if multiple items are selected then a stamp will be created for each item.

### ▼ Export Settings

This feature makes it possible to save and export customized settings for subsequent use:

1. Click the **File** tab.
2. Click **Manage Settings**, then click **Export Settings**. The **Export Settings Options** dialog box will open.
3. Determine parameters as detailed [here](#).<sup>933</sup>
4. Click **OK**.

### ▼ Find Text

1. Click the **Find** icon in the **Quick Find** toolbar, which is located in the upper-right section of the user interface. The **Find Function** will launch:



2. Follow the instructions detailed [here](#).

The keyboard shortcut for this operation is Ctrl+F.

### ▼ Import Saved Settings

This feature is used to import customized settings that have been saved using the [Export Settings](#) feature. Follow the instructions below to import settings:

1. Click the **File** tab, then click **Manage Settings**.
2. Click **Import Settings**. The **Import Settings from File** dialog box will open.
3. Select the desired settings for import and click **OK**.

### ▼ Insert Images Into a Snapshot Area

This feature is used to insert images into areas that the **Snapshot** tool has defined:

1. Click **Snapshot Tool** in the **Home** tab.
2. Click and drag to define a snapshot area.
3. Right-click the snapshot area, then click **Add Image** in the shortcut menu.

The **Open Files** dialog box will open.

4. Select the desired image and click **Open**.

### ▼ Launch the JavaScript Console

The **JavaScript Console** is used to add, edit and remove JavaScript from documents. Follow the instructions below to launch the **JavaScript Console**:

1. Click the **Form** tab.
2. Click **JavaScript Console**. Further information on the **JavaScript Console** is available [here.](#)<sup>1429</sup>

The keyboard shortcut for this operation is Ctrl+J.

### ▼ Merge Document Pages

The **Merge Pages** feature is used to merge document pages:

1. Click the **Organize** tab.
2. Click **Merge Pages**.
3. Follow the instructions detailed [here.](#)<sup>1479</sup>

### ▼ Print Documents

1. Click the **File** tab.
2. Click **Print**. The **Print** dialog box will open. Set the desired printing parameters as detailed [here.](#)<sup>833</sup>
3. Click **Print**.

The keyboard shortcut for this operation is Ctrl+P.

### ▼ Print Snapshots

1. Click the **Home** tab, then click **Snapshot** and take the desired snapshot.
2. Click the **File** tab, then click **Print**. The **Print** dialog box will open.
3. Select **Selected Graphic** in the **Page Range Section**, and **Fit to Printer Margins** and **Auto-Center Page on Paper** in the **Page Placement and Scaling** section:



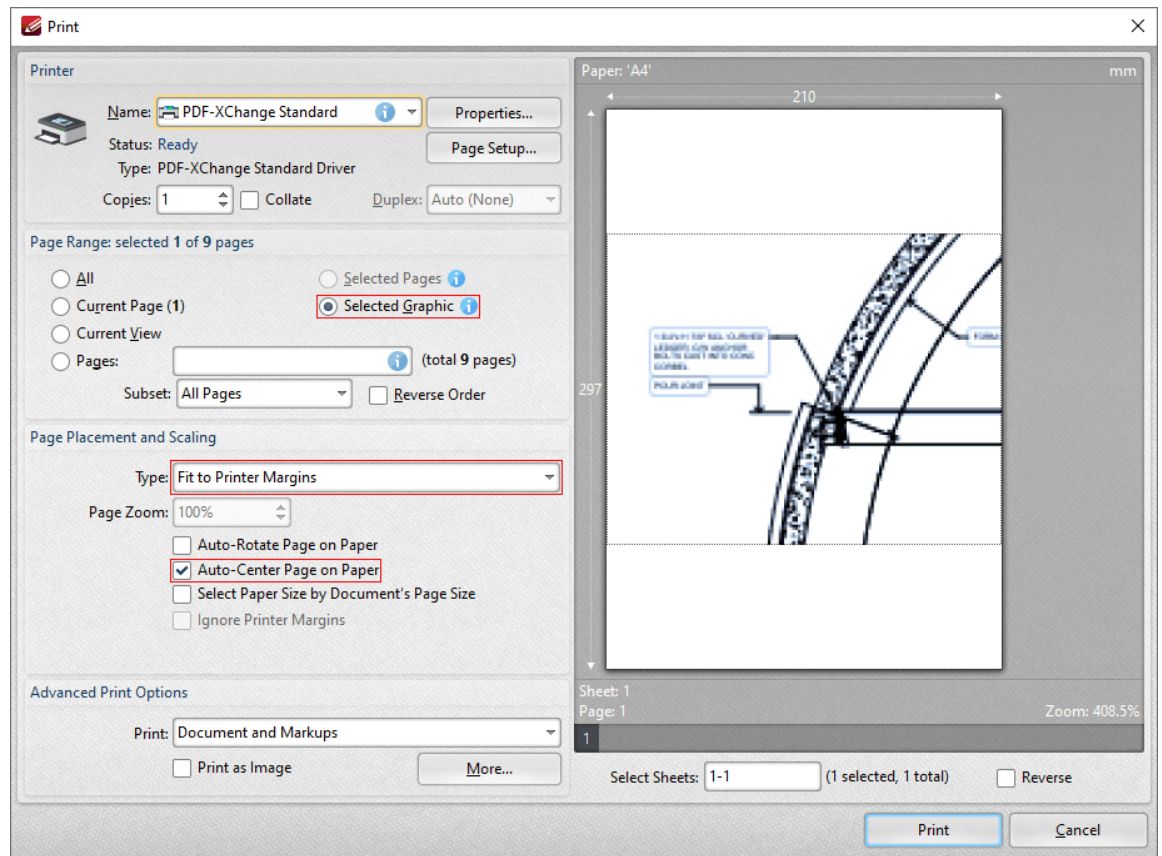

4. Click **Print**.

#### ▼ **Print the Current View**

1. Click the **File** tab.

2. Click **Print**. The **Print** dialog box will open.

3. Select **Current View** in the **Page Range Section**, and **Fit to Printer Margins** and **Auto-Center Page on Paper** in the **Page Placement and Scaling** section:

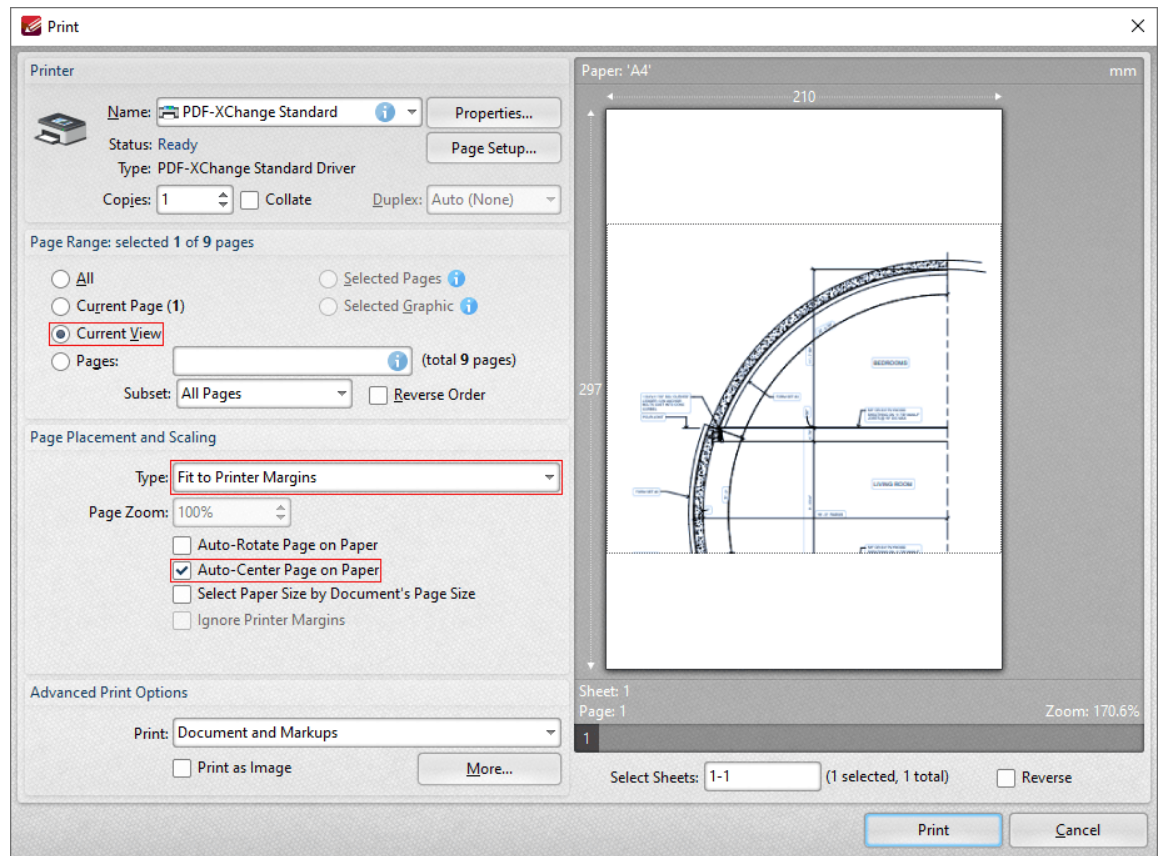

4. Click **Print**.

#### ▼ **Replace Document Images**

This feature is used to replace images in PDF files:

1. Click the **Home** tab, then click **Edit Content**.
2. Right-click the image and then click **Replace Image** in the shortcut menu.

The **Open Files** dialog box will open.

3. Select the desired image and then click **Open** to replace the image selected in the document.

#### ▼ **Reset Document Settings**

This feature resets document settings as desired. Settings that can be reset are program options, including common options, presets, trusted/untrusted lists, prompts and the UI language, as well as the program history, custom stamp collections and digital signature appearance templates. Follow the instructions below to reset document settings:

1. Click the **File** tab.
2. Click **Manage Settings**, then click **Reset Settings**. The **Reset Settings Options** dialog box will open.
3. Follow the instructions detailed [here](#).<sup>[933]</sup>

#### ▼ **Revert Documents to Original State**

1. Click the **File** tab.
2. Click **Revert**.

#### ▼ **Save Document Images**

This feature is used to save images directly from a PDF to a new file:

1. Click the **Home** tab, then click **Edit Content**.
2. Right-click the image and then click **Save Image As** in the shortcut menu.

#### ▼ **Search for Text in Documents/Folders**

1. Click **Search** in the **Quick Find** toolbar, which is located in the upper-right section of the user interface. The **Search** pane will open.
2. Follow the instructions detailed [here](#).<sup>[1776]</sup>

The keyboard shortcut to launch the **Search** pane is Ctrl+Alt+F.

#### ▼ **Swap Document Pages**

1. Click the **Organize** tab.

2. Click **Swap Pages**. The **Swap Pages** dialog box will open.
3. Enter the page numbers of the pages to be swapped and click **OK**.

#### ▼ Take Document Snapshots

The **Snapshot Tool** is a quick and efficient method of creating images of the current view within **PDF-XChange Editor** and pasting them immediately to the clipboard of the local computer. Follow the instructions below to enable and use the **Snapshot Tool**:

1. Click the **Home** tab.
2. Click the **Other Tools** dropdown menu, then click **Snapshot Tool**.
3. Click or click and drag to take snapshots.

Customizable parameters for this tool are detailed [here](#).<sup>926</sup>

#### ▼ Transform the Current Selection

This feature is used to edit the position, size and/or rotation of selected annotations/content items:

1. Click the **Home** tab, then click the **Edit Content Tool**.
2. Click and drag to determine the content to be transformed.
3. Click **Selection**, then click **Transform**.
4. Follow the instructions detailed [here](#).<sup>948</sup>

#### ▼ Utilize Sessions

The **Sessions** options in **PDF-XChange Editor** provide a useful method of retaining the parameters of the active session for subsequent use. The retained parameters include which documents were open, their order/layout within the main window, the location of the main window on the screen and the status of editing panes such as the **Thumbnails/Properties** pane. Follow the instructions below to:

##### ▼ Save the Current Session

1. Click the **File** tab, then click **Sessions**.
2. Click **Save Current Session**. The **Save Current Session** dialog box will open:

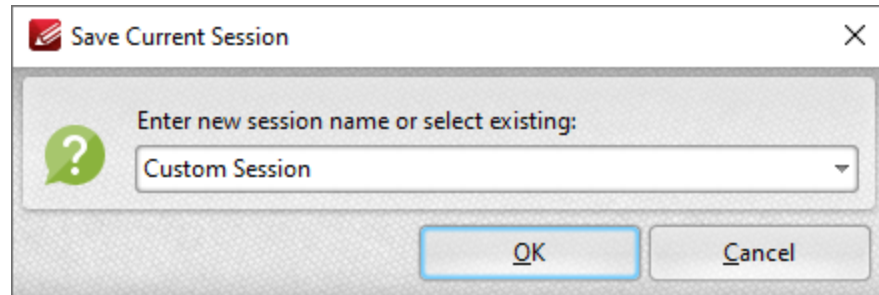

3. Enter a name for the session and click **OK**. Further information on sessions is available [here](#).<sup>[779]</sup>

#### ▼ Save the Current Session to a File

1. Click the **File** tab, then click **Sessions**.
2. Click **Save Current Session to a File**. The **Save Current Session** dialog box will open.
3. Enter a name for the session in the **File name** text box and click **Save**.

#### ▼ Open a Session From a File

1. Click the **File** tab, then click **Sessions**.
2. Click **Open Session from a File**. The **Open Session** dialog box will open.
3. Select the desired session and click **Open**.

#### ▼ Manage Existing Sessions

1. Click the **File** tab, then click **Sessions**.
2. Click **Manage Sessions**. The **Manage Sessions** dialog box will open.

3. Follow the instructions detailed [here](#).<sup>779</sup>

#### ▼ View Document Font Details

1. Click the **File** tab.
  2. Click **Document Properties**. The **Document Properties** dialog box will open.
  3. Click **Fonts** in the **Categories Menu**. A list of fonts used in the active document will be displayed. Please note that this information is read-only. See [here](#).<sup>784</sup> for instructions on how to customize font embedding options.
-

### 10.3.3.5 Save Documents

---



## Save Documents

---

There are multiple ways to save documents in **PDF-XChange Editor**. See below for instructions on how to:

#### ▼ Save Optimized Copies of the Active Document

1. Click the **File** tab.
2. Click **Save as Optimized**. The **Optimize PDF** dialog box will open. Select the desired optimization parameters, as detailed [here](#),<sup>[784]</sup> then click **OK**. The document will then be optimized and the **Save File** dialog box will open.
3. Enter a file name in the **File name** text box.
4. Click **Save**.

#### ▼ Save Documents

1. Click the **File** tab.
2. Click **Save**.

The keyboard shortcut for this operation is Ctrl+S.

#### ▼ Save Documents with a New Name/to a New Location

1. Click the **File** tab.
2. Click **Save As**, then click **Browse**.
3. Move to the location and/or enter a new file name in the **File name** text box.

4. Click **Save**.

The keyboard shortcut for this operation is Ctrl+Shift+S.

#### ▼ **Save to a Box.com Account**

1. Click the **File** tab.
2. Click **Save As**.
3. Click **Box.com**. The **Authenticate** dialog box will open. Enter the details of the **Box.com** account and click **Sign in**. The **Save File** dialog box will open.
4. Enter a file name in the **File Name** text box and click **Save**.

#### ▼ **Save to a Dropbox Folder**

1. Click the **File** tab.
2. Click **Save As**.
3. Click **Dropbox**. The **Authenticate** dialog box will open. Enter the details of the **Dropbox** account and click **Sign in**. The **Save File** dialog box will open.
4. Enter a file name in the **File Name** text box and click **Save**.

#### ▼ **Save to a Google Drive**

1. Click the **File** tab.
2. Click **Save As**.
3. Click **Google Drive**, then click **Allow** in the **Google Drive Authentication** dialog box. The **Save File to Google Drive** dialog box will open.
4. Enter a file name in the **File Name** text box and click **Save**.

#### ▼ **Save to a One Drive Account**



1. Click the **File** tab.
2. Click **Save As**.
3. Click **One Drive**, then click **Yes** in the **One Drive Authentication** dialog box. The **Save File to OneDrive** dialog box will open.
4. Enter a file name in the **File Name** text box and click **Save**.

▼ **Save to a SharePoint Account**

1. Click the **File** tab.
  2. Click **Save As**.
  3. Click **SharePoint**. The **Save File** dialog box will open.
  5. Enter the **SharePoint** address in the text box, then click **Navigate**.
  6. Select a location from the list.
  7. Click **Save**.
-

### 10.3.4 Editing Panes Guide

---



## Editing Panes Guide

---

There are sixteen editing panes in **PDF-XChange Editor** that enable the efficient browsing and editing of documents. Click the links below for instructions on how to open and utilize:

#### ▼ The 3D Model Tree Pane

1. Click the **View** tab, then click the **Panes** dropdown menu.
2. Click **3D Model Tree**.
3. Follow the instructions detailed [here](#).<sup>1039</sup>

#### ▼ The Attachments Pane

1. Click the **View** tab, then click the **Panes** dropdown menu.
2. Click **Attachments**.
3. Follow the instructions detailed [here](#).<sup>1014</sup>

The keyboard shortcut to show/hide the **Attachments** pane is Ctrl+Shift+B.

#### ▼ The Bookmarks Pane

1. Click the **View** tab, then click the **Panes** dropdown menu.
2. Click **Bookmarks**. The **Bookmarks** pane will open.
3. Follow the instructions detailed [here](#).<sup>994</sup>

The keyboard shortcut to show/hide the **Bookmarks** pane is Ctrl+B.

### ▼ The Comments Pane

1. Click the **View** tab, then click the **Panes** dropdown menu.
2. Click **Comments**.
3. Follow the instructions detailed [here](#).

The keyboard shortcut to show/hide the **Comments** pane is Ctrl+M.

### ▼ The Content Pane

1. Click the **View** tab, then click the **Panes** dropdown menu.
2. Click **Content**.
3. Follow the instructions detailed [here](#).

### ▼ The Document Recovery Pane

1. Click the **View** tab, then click the **Panes** dropdown menu.
2. Click **Document Recovery**.
3. Follow the instructions detailed [here](#).

### ▼ The Fields Pane

1. Click the **View** tab, then click the **Panes** dropdown menu.
2. Click **Fields**.
3. Follow the instructions detailed [here](#).

The keyboard shortcut to show/hide the **Fields** pane is Ctrl+I.

### ▼ The History Pane

1. Click the **View** tab, then click the **Panes** dropdown menu.
2. Click **History**.
3. Follow the instructions detailed [here](#).

### ▼ The Layers Pane

1. Click the **View** tab, then click the **Panes** dropdown menu.
2. Click **Layers**.
3. Follow the instructions detailed [here](#).

The keyboard shortcut to show/hide the **Layers pane** is Ctrl+L.

### ▼ The Links Pane

1. Click the **View** tab, then click the **Panes** dropdown menu.
2. Click **Links**.
3. Follow the instructions detailed [here](#).

### ▼ The Named Destinations Pane

1. Click the **View** tab, then click the **Panes** dropdown menu.
2. Click **Destinations**.
3. Follow the instructions detailed [here](#).

### ▼ The Pan and Zoom Pane

1. Click the **View** tab, then click the **Panes** dropdown menu.
2. Click **Pan and Zoom**.

3. Follow the instructions detailed [here.](#)

#### ▼ The Properties Pane

1. Click the **View** tab, then click the **Panes** dropdown menu.
2. Click **Properties**.
3. Follow the instructions detailed [here.](#)

The keyboard shortcut to show/hide the **Properties** pane is Ctrl+'.

#### ▼ The Signatures Pane

1. Click the **View** tab, then click the **Panes** dropdown menu.
2. Click **Signatures**.
3. Follow the instructions detailed [here.](#)

#### ▼ The Spell Check Pane

1. Click the **View** tab, then click the **Panes** dropdown menu.
2. Click **Spell Check**.
3. Follow the instructions detailed [here.](#)

▼ **The Thumbnails Pane**

1. Click the **View** tab, then click the **Panes** dropdown menu.
2. Click **Thumbnails**. The **Thumbnails** pane will open.
3. Follow the instructions detailed [here](#).

The keyboard shortcut to show/hide the **Thumbnails pane** is Ctrl+T.

Additionally, please note that the tabs detailed below can be used to minimize/maximise editing panes:

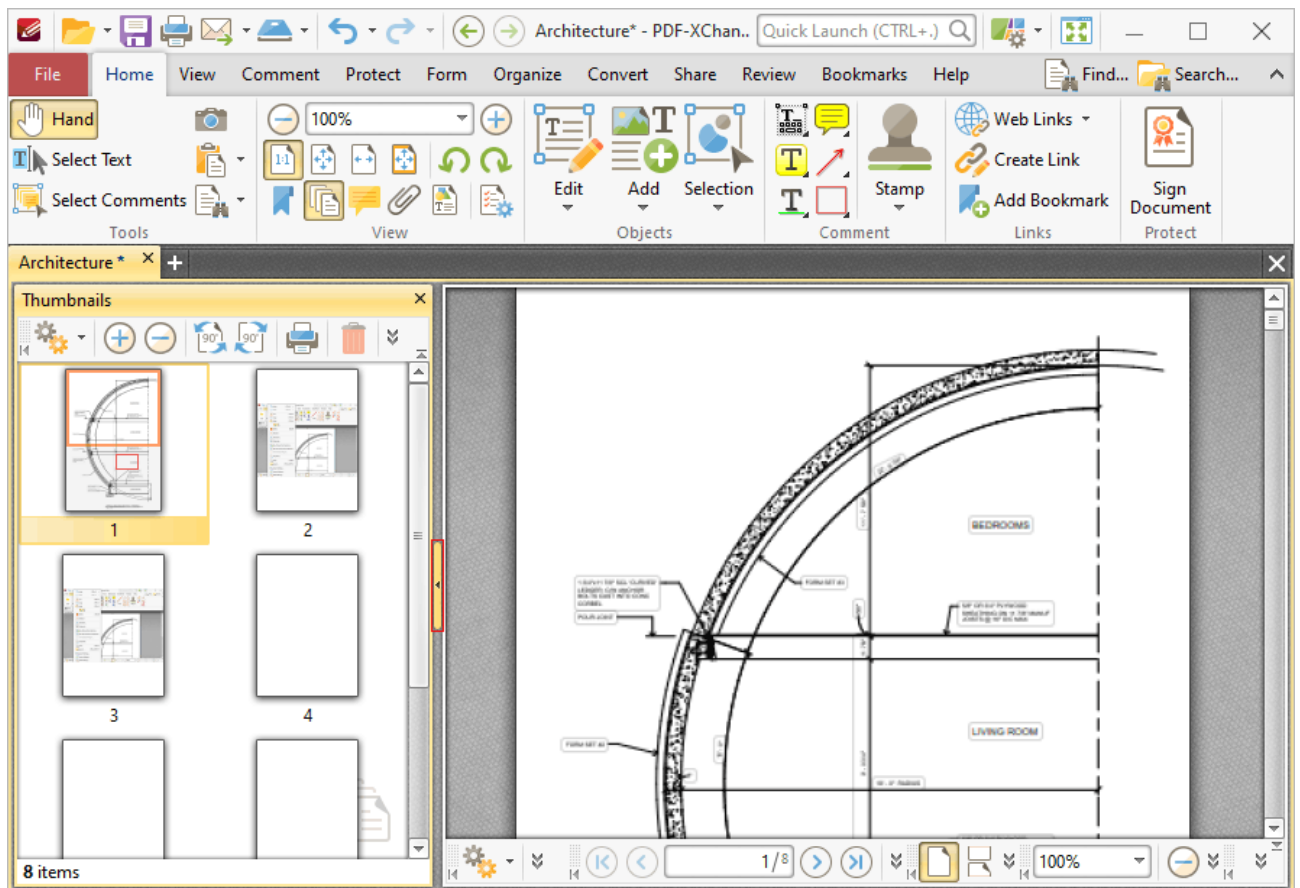

**Figure 1.** Minimise Pane Tab

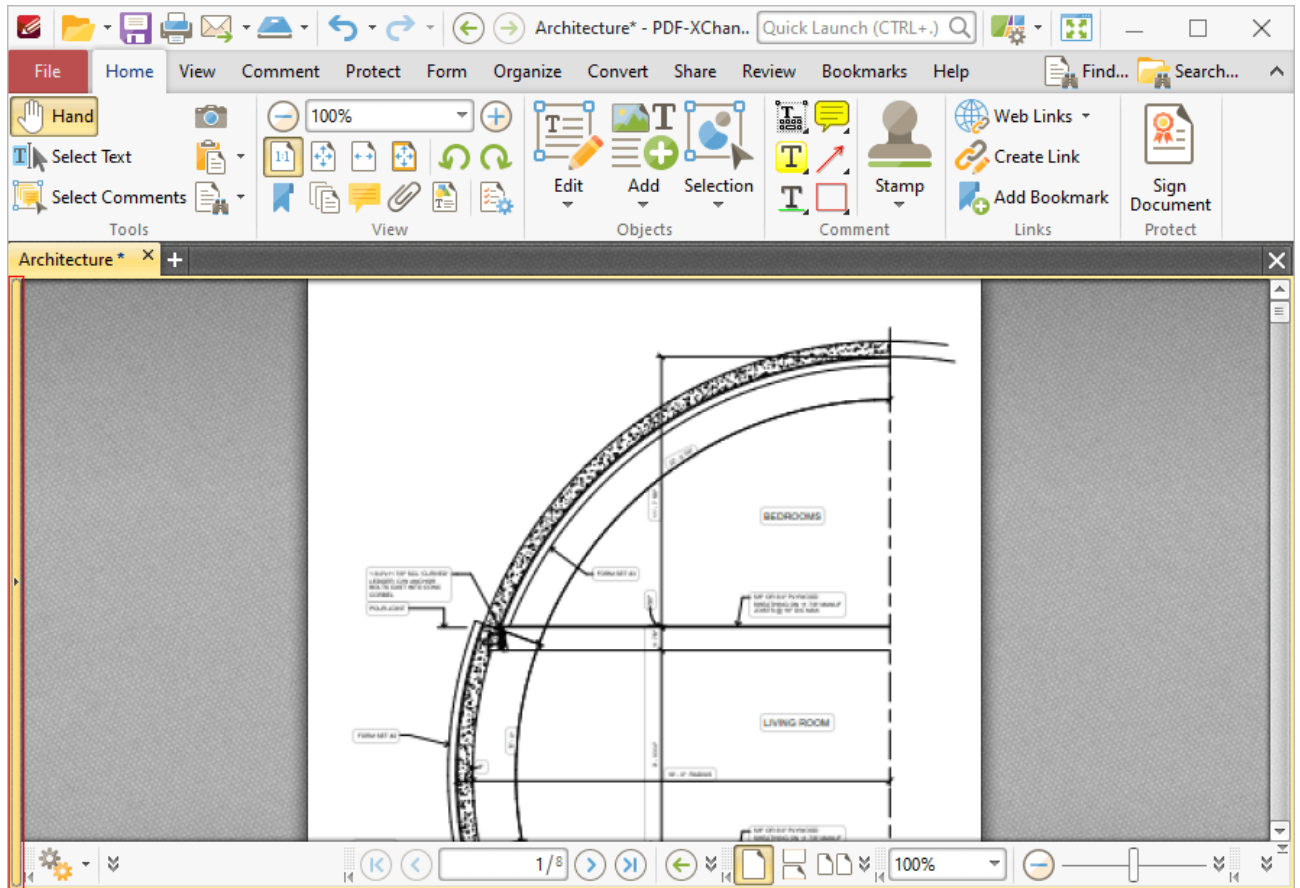

Figure 2. Maximise Pane Tab

### 10.3.5 Forms Guide

---



## Forms Guide

---

**PDF-XChange Editor** includes functionality that adds/edits fillable forms. This functionality can be used to create dynamic documents such as those used to make credit card payments and create website accounts. Please note that this is a licensed feature. Therefore, unless **PDF-XChange Editor Plus** is used, documents will feature watermarks when fillable forms are created. See below for instructions on how to:

#### ▼ Add Barcodes to Documents

Barcodes translate form data into an encoded pattern to increase security and efficiency. They are compatible with most smartphones and tablets and have several useful templates, such as electronic business cards that can be used for contact details and other personal information. They can also be used to link to URLs, create custom messages and send automatic emails. Follow the steps below to add barcodes to documents:

1. Click the **Form** tab, then click the **Barcode** button. The pointer will become a crosshairs icon and feature a blue rectangle, which represents the barcode.
2. Place the rectangle at the desired location and click to create the barcode.
3. Use the editing options detailed [here](#)  to edit and enhance barcodes.

#### ▼ Add Buttons to Documents

Buttons are used to enable specific operations within documents, such as opening a web link or playing a sound. The operations are carried out when buttons are clicked. Follow the instructions below to add buttons to documents:

1. Click the **Form** tab, then click the **Button** button. The pointer will become a crosshairs icon and feature a blue rectangle, which represents the button.
2. Place the rectangle at the desired location and click to create the button.



3. Use the editing options detailed [here](#)<sup>1356</sup> to edit and enhance buttons.

#### ▼ Add Check Boxes to Documents

Check boxes allow users to make a binary choice between mutually exclusive options, such as yes/no answers. Follow the instructions below to add check boxes to documents:

1. Click the **Form** tab, then click the **Check Box** button. The pointer will become a crosshairs icon and feature a blue square, which represents the check box.
2. Place the square at the desired location and click to create the check box.
3. Use the editing options detailed [here](#)<sup>1293</sup> to edit and enhance check boxes.

#### ▼ Add Date Fields to Documents

Date fields allow users to specify a date from a dropdown calendar. Follow the instructions below to add date fields to documents:

1. Click the **Form** tab, then click the **Date** button. The pointer will become a crosshairs icon and feature a blue square, which represents the date field.
2. Place the square at the desired location and click to create the date field.
3. Use the editing options detailed [here](#)<sup>1409</sup> to edit and enhance date fields.

### ▼ Add Digital Signature Fields to Documents

Digital signatures are used to demonstrate the authenticity of documents and increase their security. Follow the instructions below to add digital signature fields to documents:

1. Click the **Form** tab, then click the **Digital Signature** button. The pointer will become a crosshairs icon and feature a blue rectangle, which represents the digital signature field.
2. Place the rectangle at the desired location and click to create the digital signature field.
3. Use the editing options detailed [here](#)<sup>1374</sup> to edit and enhance digital signatures.

### ▼ Add Dropdown Menus to Documents

Dropdown menus allow users to select only one value from a list of options contained within a static, multiple line text box, such as a list of nationalities. The option selected is displayed within the dropdown menu. Follow the instructions below to add dropdown menus to documents:

1. Click the **Form** tab, then click the **Dropdown** button. The pointer will become a crosshairs icon and feature a blue rectangle, which represents the dropdown menu.
2. Place the rectangle at the desired location and click to create dropdown menu.
3. Use the editing options detailed [here](#)<sup>1329</sup> to edit and enhance dropdown menus.

### ▼ Add Image Fields to Documents

Image fields are used to add form fields that enable users to the submit images as form data. Follow the instructions below to add image fields to documents:

1. Click the **Form** tab, then click the **Image** button. The pointer will become a crosshairs icon and feature a blue rectangle, which represents the image field.
2. Place the rectangle at the desired location and click to create image field.
3. Use the editing options detailed [here](#)<sup>1420</sup> to edit and enhance dropdown menus.

### ▼ Add List Boxes to Documents

List boxes allow users to select one or more items from a list of options contained within a static, multiple line text box, such as a list of months of the year. The option selected is displayed within the list box. Follow the instructions below to add list boxes to documents:

1. Click the **Form** tab, then click the **List Box** button. The pointer will become a crosshairs icon and feature a blue rectangle, which represents the list box.
2. Place the rectangle at the desired location and click to create the list box.
3. Use the editing options detailed [here](#)<sup>1317</sup> to edit and enhance list boxes.

### ▼ Add Radio Buttons to Documents

Radio buttons are used within fillable forms to denote options that are mutually exclusive, such as answers to multiple-choice questions. Follow the instructions below to add radio buttons to documents:

1. Click the **Form** tab, then click the **Radio** button. The pointer will become a crosshairs icon and feature a blue square, which represents the radio button.
2. Place the square at the desired location and click to create the radio button.
3. Use the editing options detailed [here](#)<sup>1305</sup> to edit and enhance radio buttons.

### ▼ Add Text Fields to Documents

Text fields are used to denote a space in which users can enter text, such as their address or credit card details. Follow the instructions below to add text fields to documents:

1. Click the **Form** tab, then click the **Text Field** button. The pointer will become a crosshairs icon and feature a blue rectangle, which represents the text field.
2. Place the rectangle at the desired location and click to create the text field.
3. Use the editing options detailed [here](#)<sup>1270</sup> to edit and enhance text fields.

### ▼ Change the Tab Order of Forms

When fillable forms have been created, it is sometimes required to change the order in which the Tab key will move through individual form fields. Follow the instructions below to change the Tab order of forms:

1. Click the **View** tab, then click the **Panes** dropdown menu.
2. Click **Fields**. The **Fields** pane will open.
3. Click **Options**. The **Options** submenu will open.
4. Click **Order by Pages**. Then click the **Edit Form** tool in the **Shortcut Toolbar**.
5. Click and drag fields within the **Fields** pane to reorder them.

#### ▼ **Rename Forms**

1. Click the **Form** tab, then click **Select Fields**.
2. Select the form and Press F2. The **Rename Field** dialog box will open.
3. Enter the new name in the text box.
4. Click **OK**.

#### ▼ **Use Forms to Calculate Values**

**PDF-XChange Editor** includes functionality that can be used to carry out calculations on values entered into forms. Follow the instructions below to calculate values based on the information entered into document forms:

1. Place either a **Text Field** or a **Drop Down** form in the active document.
2. Click the **Form** tab, then click **Select Fields**.
3. Right-click the form and select **Properties**. The **Properties** pane will open.
4. Move to the **Format Value** tab and set the **Category** to **Number**.
5. Move to the **Value Calculation** tab and select the desired calculation. After a calculation is selected the **Fields** option will appear in the **Value Calculation** tab.

6. Click the ellipsis icon on the right of the **Fields** option. The **Field Selection** dialog box will open.

7. Select the fields to be included in the calculation and click **OK**. The document will then update with the desired calculations in place. If form data is subsequently changed then forms included in value calculations will update automatically.

All options for this process and a step-by-step walkthrough is available [here](#).

### ▼ Use Forms to Validate Values

**PDF-XChange Editor** includes functionality that can be used to validate figures entered into forms. Follow the instructions below to validate that values entered into document forms fall within a designated range:

1. Place either a **Text Field** or a **Drop Down** form in the active document.
2. Click the **Form** tab, then click **Select Fields**.
3. Right-click the form and select **Properties**. The **Properties** pane will open.
4. Move to the **Format Value** tab and set the **Category** to **Number**.
5. Move to the **Value Validation** tab and select **Value in Range**. The **From** and **To** options will appear in the **Value Validation** tab.
6. Use the **From** and **To** options to determine the desired range.

All options for this process and a step-by-step walkthrough is available [here](#).

Additionally, several of the [Keyboard Shortcuts](#) relate to forms.

---

### 10.3.6 Workspace Guide

---



## Workspace Guide

---

Detailed in this section are operations in **PDF-XChange Editor** that relate to the workspace. Click the subsection titles to open the associated page of the manual:



[Customize the Workspace](#)<sup>[751]</sup> - a breakdown of operations that relate to the customization of the workspace, including how to create customized toolbars, determine preferences, avail of editing aids and set file open security.



[Navigate the Workspace](#)<sup>[764]</sup> - a breakdown of operations that relate to navigating between documents and document pages.

---

### 10.3.6.1 Customize the Workspace

---



## Customize the Workspace

---

**PDF-XChange Editor** features multiple settings that enable the customization of the workspace. See below for instructions on how to:

#### ▼ Add/Remove Serial Keys

1. Click the **File** tab, then click **Preferences**.
2. Click **Registration** in the **Categories** menu.
3. Follow the instructions detailed [here](#).<sup>869</sup>

#### ▼ Create Customized Toolbars

Users of **PDF-XChange Editor** often use the same set of commands, tools and operations repeatedly. If that is the case then it is useful to create a customized toolbar in order to group together these elements of their work process to increase efficiency and output. Follow the instructions below to create customized toolbars:

1. Click the **Help** tab.
2. Click **Customize Toolbars**. The **Customize Toolbars** dialog box will open.
3. Follow the instructions detailed [here](#).<sup>1599</sup>

#### ▼ Customize the UI Appearance

**PDF-XChange Editor** can be fully customized in order to suit the specific the needs and tastes of the user. Follow the instructions below to customize the user interface:

1. Click the **Help** tab.

2. Click **Customize Theme**. The **Customize UI** preferences dialog box will open.
4. Determine parameters as detailed [here](#).<sup>879</sup>
5. Click **OK**.

#### ▼ **Determine Applications Available via the Launch Applications Toolbar**

The **Launch Application Toolbar** facilitates the efficient opening of documents in an alternative PDF program from **PDF-XChange Editor**. Multiple programs can be added to the **Launch Application Toolbar** for your convenience. Follow the instructions below to add/remove programs:

1. Click the **File** tab, then click **Preferences**.
2. Click **Launch Applications** in the **Categories** menu. The **Launch Applications** preferences dialog box will open.
3. Determine parameters as detailed [here](#).<sup>895</sup>
4. Click **OK**.

#### ▼ **Determine Color Management Settings**

1. Click the **File** tab, then click **Preferences**.
2. Click **Color Management** in the **Categories** menu. The **Color Management** preferences dialog box will open.
3. Determine parameters as detailed [here](#).<sup>873</sup>
4. Click **OK**.

#### ▼ **Determine Color Scheme Options**

1. Click the **File** tab, then click **Preferences**.
2. Click **Accessibility** in the **Categories** menu. The **Accessibility** preferences dialog box will open.



3. Determine parameters as detailed [here](#).<sup>871</sup>

4. Click **OK**.

#### ▼ **Determine Comment Options**

The **PDF-XChange Editor** comments feature various viewing and creation options such as to show/hide tooltips, the modification date and subject/author labels in comment pop-ups. Follow the instructions below to determine options for comments:

1. Click the **File** tab, then click **Preferences**.

2. Click **Commenting** in the **Categories** menu. The **Commenting** preferences dialog box will open.

3. Determine parameters as detailed [here](#).<sup>875</sup>

4. Click **OK**.

#### ▼ **Determine Digital Signature Options**

The digital signature options determine various parameters of digital signatures, including creation and appearance options, verification settings and signature template options. Follow the instructions below to view and edit available options:

1. Click the **File** tab, then click **Preferences**.

2. Click **Signatures** in the **Categories** menu. The **Signatures** preferences dialog box will open.

3. Determine parameters as detailed [here](#).<sup>922</sup>

4. Click **OK**.

#### ▼ **Determine Document Options**

The document options determine settings that relate to documents, such as tab and window settings, application start settings, history and recent documents management, save options

and PDF-specification for new documents. Follow the instructions below to view and edit available options:

1. Click the **File** tab, then click **Preferences**.
2. Click **Documents** in the **Categories** menu. The **Documents** preferences dialog box will open.
3. Determine parameters as detailed [here](#).
4. Click **OK**.

#### ▼ **Determine File Associations**

The file association settings can be used to determine the default application for PDF files, options for viewing files in Internet Explorer, the registration options for the NP-plugin in other browsers and the preview/thumbnail handler for PDF files. Follow the instructions below to determine file associations:

1. Click the **File** tab, then click **Preferences**.
2. Click **File Associations** in the **Categories** menu. The **File Associations** preferences dialog box will open.
3. Determine parameters as detailed [here](#).
4. Click **OK**.

#### ▼ **Determine File Formats that can be Converted to/from PDF**

1. Click the **File** tab, then click **Preferences**.
2. Click **Convert to PDF** or **Convert from PDF** in the **Categories** menu.
3. Determine parameters as detailed [here](#).

#### ▼ **Determine Form Settings**

Forms feature multiple settings that apply to their functionality and appearance. Follow the instructions below to view/edit form settings:

1. Click the **File** tab, then click **Preferences**.
2. Click **Forms** in the **Categories** menu. The **Forms** preferences dialog box will open.
3. Determine parameters as detailed [here](#).
4. Click **OK**.

#### ▼ **Determine Identity Options for Comments and Digital Signatures**

Identity options include the user login name, actual name, title and organization details. This information is used in conjunction with comments, reviews and digital signatures. Follow the instructions below to determine identity options:

1. Click the **File** tab, then click **Preferences**.
2. Click **Identity** in the **Categories** menu. The **Identity** preferences dialog box will open.
3. Determine parameters as detailed [here](#).
4. Click **OK**.

#### ▼ **Determine JavaScript Options**

Follow the instructions below to determine options that relate to JavaScript and the **JavaScript Console**:

1. Click the **File** tab, then click **Preferences**.
2. Click **JavaScript** in the **Categories** menu. The **JavaScript** preferences dialog box will open.
3. Determine parameters as detailed [here](#).
4. Click **OK**.

#### ▼ **Determine Measurement Options**

Follow the instructions below to determine measurement settings, such as the display options of rulers, grids and guides and their associated settings:

1. Click the **File** tab, then click **Preferences**.
2. Click **Measurement** in the **Categories** menu. The **Measurement** preferences dialog box will open.
3. Determine parameters as detailed [here](#).<sup>[898]</sup>
4. Click **OK**.

#### ▼ Determine Memory Usage

1. Click the **File** tab, then click **Preferences**.
2. Click **Performance** in the **Categories** menu. The **Performance** preferences dialog box will open.
3. Determine **Memory** and **Threads Usage** settings as detailed [here](#).<sup>[906]</sup>
4. Click **OK**.

#### ▼ Determine Page Display Options

1. Click the **File** tab, then click **Preferences**.
2. Click **Page Display** in the **Categories** menu. The **Page Display** preferences dialog box will open.
3. Determine parameters as detailed [here](#).<sup>[863]</sup>
4. Click **OK**.

### ▼ Determine Page Layout

1. Click the **View** tab.
2. Use the options detailed [here](#)<sup>[989]</sup> to change the page layout.

### ▼ Determine Page Text Options

Page text options include settings for action taken when **PDF-XChange Editor** detects interactive text links such as IP addresses and options for when text is copied or bookmarks are created. Follow the instructions below to determine page text options:

1. Click the **File** tab, then click **Preferences**.
2. Click **Page Text** in the **Categories** menu. The **Page Text** preferences dialog box will open.
3. Determine parameters as detailed [here](#)<sup>[867]</sup>

### ▼ Determine Scanner Presets

1. Click the **File** tab, then click **Preferences**.
2. Click **Scanner Presets** in the **Categories** menu. The **Scanner Presets** preferences dialog box will open.
3. Determine parameters as detailed [here](#)<sup>[912]</sup>
4. Click **OK**.

### ▼ Determine Search Provider Settings

1. Click the **File** tab, then click **Preferences**.
2. Click **Search Providers** in the **Categories** menu. The **Search Providers** preferences dialog box will open.
3. Determine parameters as detailed [here](#)<sup>[914]</sup>
4. Click **OK**.

#### ▼ Determine Speech Options for the Read-Out-Loud Feature

1. Click the **File** tab, then click **Preferences**.
2. Click **Speech** in the **Categories** menu. The **Speech** preferences dialog box will open.
3. Determine parameters as detailed [here](#).
4. Click **OK**.

#### ▼ Determine Send Mail Options

1. Click the **File** tab, then click **Preferences**.
2. Click **Send Mail** in the **Categories** menu. The **Send Mail** preferences dialog box will open.
3. Determine parameters as detailed [here](#).

#### ▼ Determine the Default Tool

1. Click the **File** tab, then click **Preferences**.
2. Click **Tools** in the **Categories** menu. The **Tools** preferences dialog box will open.
3. Use the **Default Tool** dropdown menu to select either the **Hand Tool** or the **Select Text Tool**.
4. Click **OK**.

#### ▼ Determine Tab and Window Options

1. Click the **File** tab, then click **Preferences**.
2. Click **Documents** in the **Categories** menu. The **Documents** preferences dialog box will open.
3. Click **Setup**. The **Manage Tabs and Windows** dialog box will open.

4. Determine parameters as detailed [here](#).<sup>857</sup>

5. Click **OK**.

#### ▼ Determine the UI Language

1. Click the **File** tab, then click **Preferences**.

2. Click **Languages** in the **Categories** menu. The **Languages** preferences dialog box will open.

3. Select the desired language and click **OK**.

#### ▼ Determine the Default Document Layout

1. Click the **File** tab, then click **Preferences**.

2. Click **Initial View** in the **Categories** menu.

3. Determine parameters as detailed [here](#).<sup>848</sup>

4. Click **OK**.

#### ▼ Determine Visible Toolbars

1. Click the **Help** tab, then click **Customize Toolbars**. The **Customize Toolbars** dialog box will open.

2. Select/clear toolbar boxes to show/hide them in the UI.

#### ▼ Display/Hide Guide Lines

Guide lines are used to simplify and make more exact the process of aligning text and objects. Follow the instructions below to enable guides:

1. Click the **View** tab.

2. Click **Show Guides**. Further information about guides is available [here](#).<sup>1075</sup>

The keyboard shortcut for this operation is Ctrl+;

#### ▼ **Display/Hide the Measurement Grid**

The measurement grid is used to assist in the accurate alignment of text and objects. Follow the instructions below to enable the measurement grid:

1. Click the **View** tab.
2. Click **Show Grid**.

The keyboard shortcut for this operation is Ctrl+'.

#### ▼ **Display/Hide Page Measurement Information**

Page measurement information is included to enable precise document editing. When it is enabled the coordinates of the pointer are displayed in the lower-right corner of the user interface. Follow the instructions below to enable page measurement information:

1. Click the **View** tab.
2. Click **Show Page Size/Position**.

#### ▼ **Display/Hide Rulers**

Rulers enable the precise measurement of document objects. Follow the instructions below to display rulers:

1. Click the **View** tab.
2. Click **Show Rulers**.

The keyboard shortcut for this operation is Ctrl+R.

#### ▼ **Enable/Disable Plugins**

**PDF-XChange Editor** features various plugins that heighten the functionality of the software, such as the **Dropbox** plugin, which makes it possible to work with files located in a **Dropbox**



folder, and the OCR plugin, which makes the OCR process possible. Follow the instructions below to view/enable/disable plugins:

1. Click the **File** tab, then click **Preferences**.
2. Click **Plugins**.
3. Determine parameters as detailed [here](#).<sup>[910]</sup>
4. Click **OK**.

### ▼ **Enable Snapping**

Snapping is a dynamic function within **PDF-XChange Editor** that facilitates the precise alignment of annotations and comments to underlying measurement guides or existing objects. Follow the instructions below to enable snapping and view/edit associated parameters:

1. Click the **Document Options** toolbar in the lower-left corner of the user interface.
2. Hover over **Snap**.
3. Click **Enable Snapping**.

The keyboard shortcut for this operation is Ctrl+Shift+;

### ▼ **Hide Licensed Features from Toolbars and Menus**

1. Click the **File** tab, then click **Preferences**.
2. Click **Registration**.
3. Select the **Hide all licensed features from toolbars and menus** box.
4. Click **OK**.

### ▼ **Reset the Panes Layout of Active Documents**

1. Click the **View** tab.

2. Click the **Panes** dropdown menu, then click **Reset Document Panes Layout**.

#### ▼ **Reset the Layout of Global Panes**

This setting is used to reset the layout of all panes within **PDF-XChange Editor**:

1. Click the **View** tab.
2. Click the **Panes** dropdown menu, then click **Reset Main Panes Layout**.

#### ▼ **Set Attachment Security**

The attachment security settings determine the action that **PDF-XChange Editor** takes when opening attachments. Follow the instructions below to determine these settings:

1. Click the **File** tab, then click **Preferences**.
2. Click **Security** in the **Categories** menu.
3. Determine parameters as detailed [here](#).<sup>916</sup>
4. Click **OK**.

#### ▼ **Show/Hide Editing Panes**

There are several editing panes within **PDF-XChange Editor** that assist in the editing of documents. Follow the instructions below to enable these editing panes:

1. Click the **View** tab.
2. Click the **Panes** dropdown menu. Available panes are displayed in the top section of the submenu.
3. Click panes to show/hide them in the workspace.

Further information on all editing panes is available [here](#).<sup>992</sup>

#### ▼ **Set File/Website Open Security**

The file open security settings determine the action that **PDF-XChange Editor** takes when opening files/websites. Follow the instructions below to determine these settings:

1. Click the **File** tab, then click **Preferences**.
2. Click **Security** in the **Categories** menu.
3. Determine parameters as detailed [here](#).<sup>916</sup>
4. Click **OK**.

Additionally, further workspace customization options are available via the [Keyboard Shortcuts](#).<sup>1691</sup>

---

### 10.3.6.2 Navigate the Workspace

---



## Navigate the Workspace

---

**PDF-XChange Editor** features multiple features that enable the navigation of the workspace. See below for instructions on how to:

#### ▼ Browse Open Documents

1. Click the **Home** tab, then click the **Hand Tool**.
2. Click and drag on empty document space to scroll pages. If a different tool from the **Hand Tool** is selected then press and hold the space bar in order to enable the hand tool temporarily.

Note that the [Page Navigation Toolbar](#)<sup>[601]</sup> also provides several useful shortcuts for browsing open documents.

#### ▼ Enable Autoscroll

1. Click the **View** tab.
2. Click **AutoScroll**.

The keyboard shortcut to enable/disable autoscroll is Ctrl+Shift+H. Use the up and down arrows to adjust the autoscroll speed, and/or press the minus key to change the autoscroll direction.

#### ▼ Navigate Backwards One Step

Navigating backwards one step will move to the previously viewed location.

1. Click the **View** tab.

2. Click **Previous View**.

The keyboard shortcut for this operation is Alt+Left.

#### ▼ **Navigate Forwards One Step**

Navigating forwards one step will move to the next viewed location. This option becomes possible when a navigate backwards operation has taken place.

1. Click the **View** tab.
2. Click **Next View**.

The keyboard shortcut for this operation is Alt+Right.

#### ▼ **Move to Selected Bookmark**

1. Click the **View** tab, then click the **Panes** dropdown menu.
2. Click **Bookmarks**. The [Bookmarks pane](#)<sup>994</sup> will open.
3. Select the desired bookmark.
4. Press Space.

#### ▼ **Move to Selected Destination**

1. Click the **View** tab, then click the **Panes** dropdown menu.
2. Click **Destinations**. The [Named Destinations](#)<sup>1036</sup> pane will open.
3. Select the desired destination.
4. Press Space.

#### ▼ **Move to a Specified Page**

1. Click the **View** tab.

2. Enter the desired page number in the number box of the **Go To** section.
3. Press **Enter**.

#### ▼ **Move to the First Page of the Document**

1. Click the **View** tab.
2. Click **First Page**.

The keyboard shortcut for this feature is the Home key.

#### ▼ **Move to the Last Page of the Document**

1. Click the **View** tab.
2. Click **Last Page**.

The keyboard shortcut for this operation is the End key.

#### ▼ **Move to the Next Page of the Document**

1. Click the **View** tab.
2. Click **Next Page**.

The keyboard shortcut for this operation is Ctrl+Right.

#### ▼ **Move to the Previous Page of the Document**

1. Click the **View** tab.
2. Click **Previous Page**.

The keyboard shortcut for this operation is Ctrl+Left.

#### ▼ **Rotate the Current View Clockwise**

1. Click the **View** tab.
2. Click **Rotate View**.
3. Click **Rotate CW**.

The keyboard shortcut for this operation is Ctrl+Shift+Num+.

#### ▼ **Rotate the Current View Counterclockwise**

1. Click the **View** tab.
2. Click **Rotate View**.
3. Click **Rotate CCW**.

The keyboard shortcut for this operation is Ctrl+Shift+Num-.

#### ▼ **Zoom to the Current Selection**

1. Right-click **Selection** in the **Home** tab.
2. Click **Zoom to Selection**.

The keyboard shortcut for this operation is Ctrl+Shift+1.

Note that the **Page Navigation Toolbar** can be used to perform many of the operations detailed above:

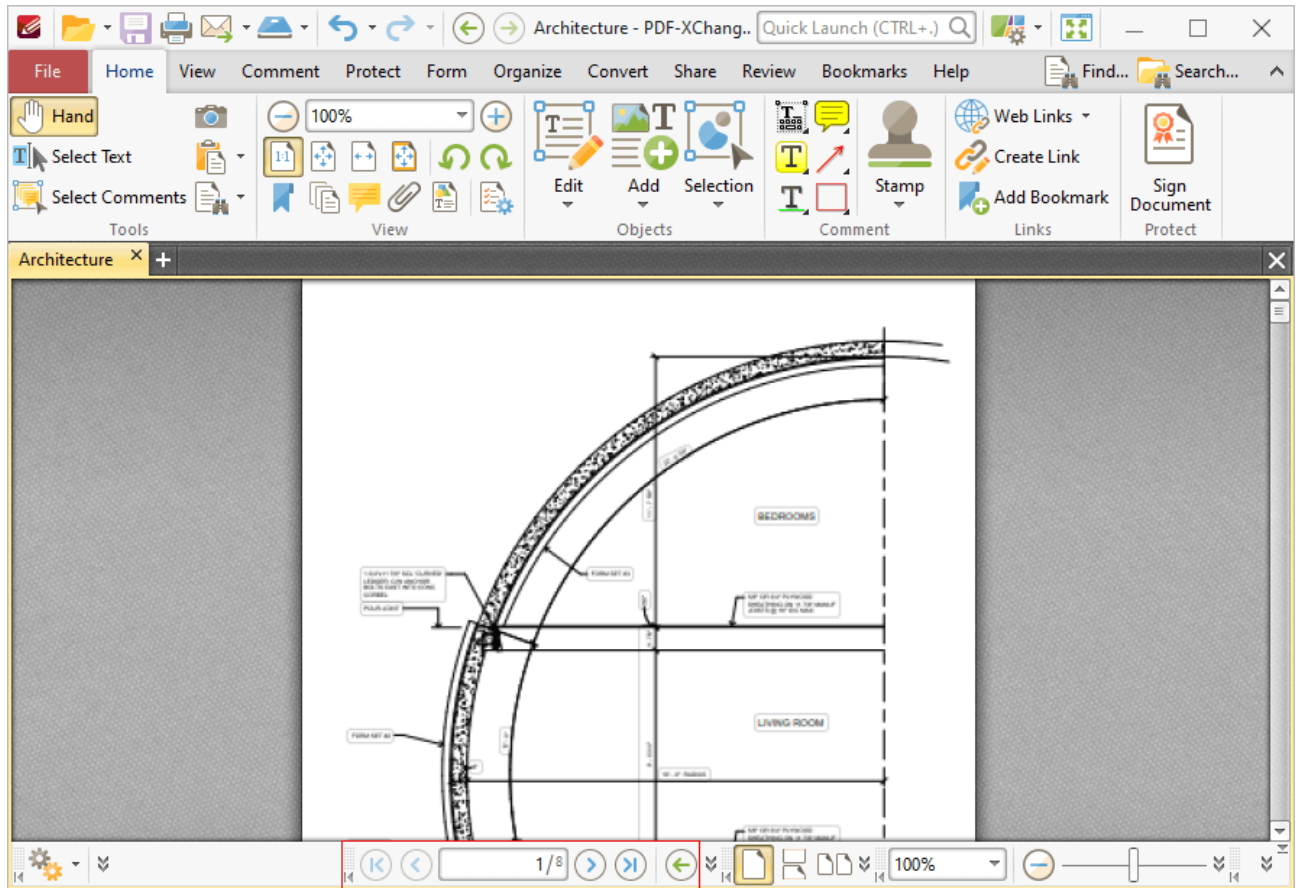

Figure 1. Page Navigation Toolbar

Additionally, the [Thumbnails Pane](#)<sup>1000</sup> can be used to navigate and edit document pages.

Right-click document tabs for additional options:



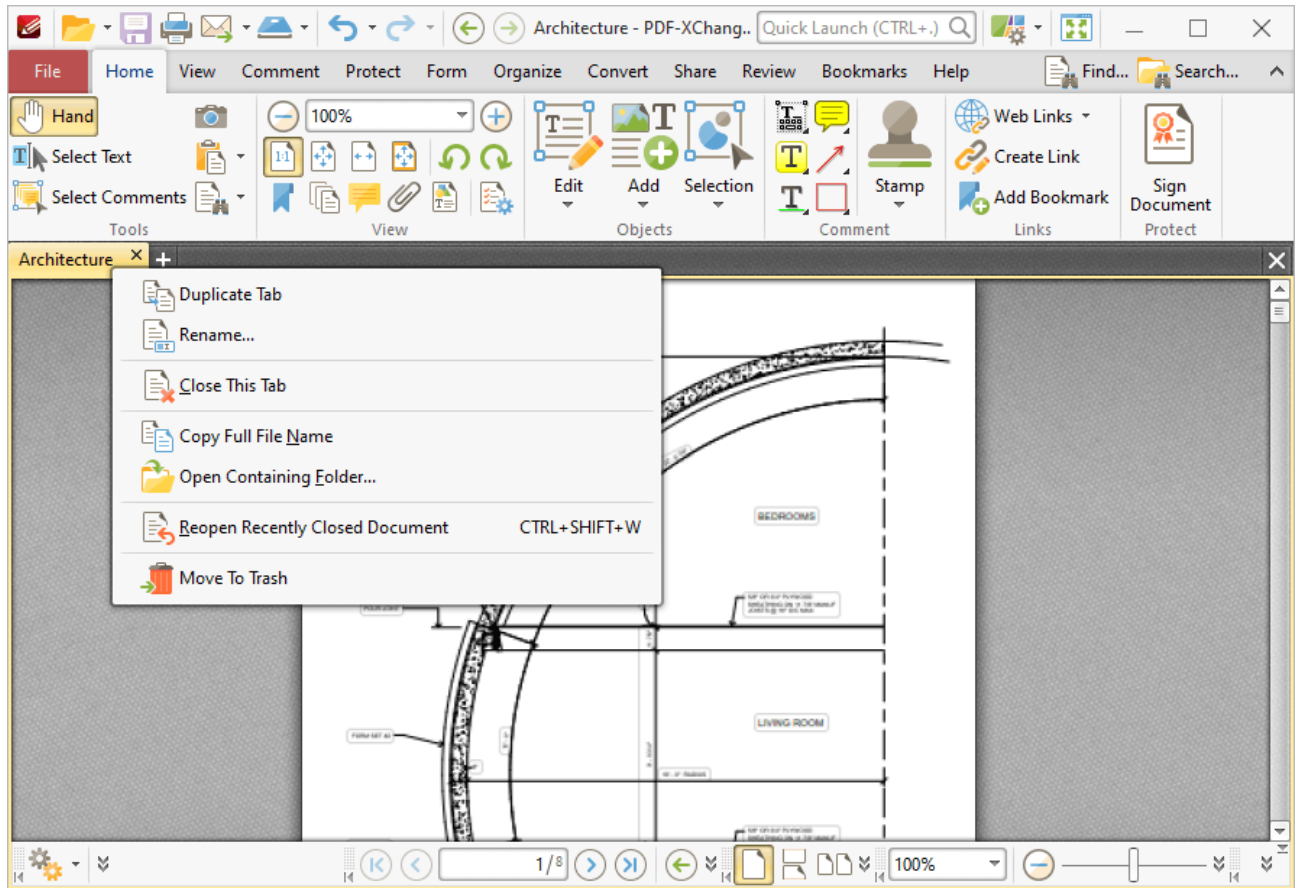

Figure 2. Tab Right-Click Options

## 10.4 Tabs Guide



### Tabs Guide

This section of the manual details the content of the ribbon tabs in **PDF-XChange Editor**. When each tab is selected, a different set of functions appears on the user interface:

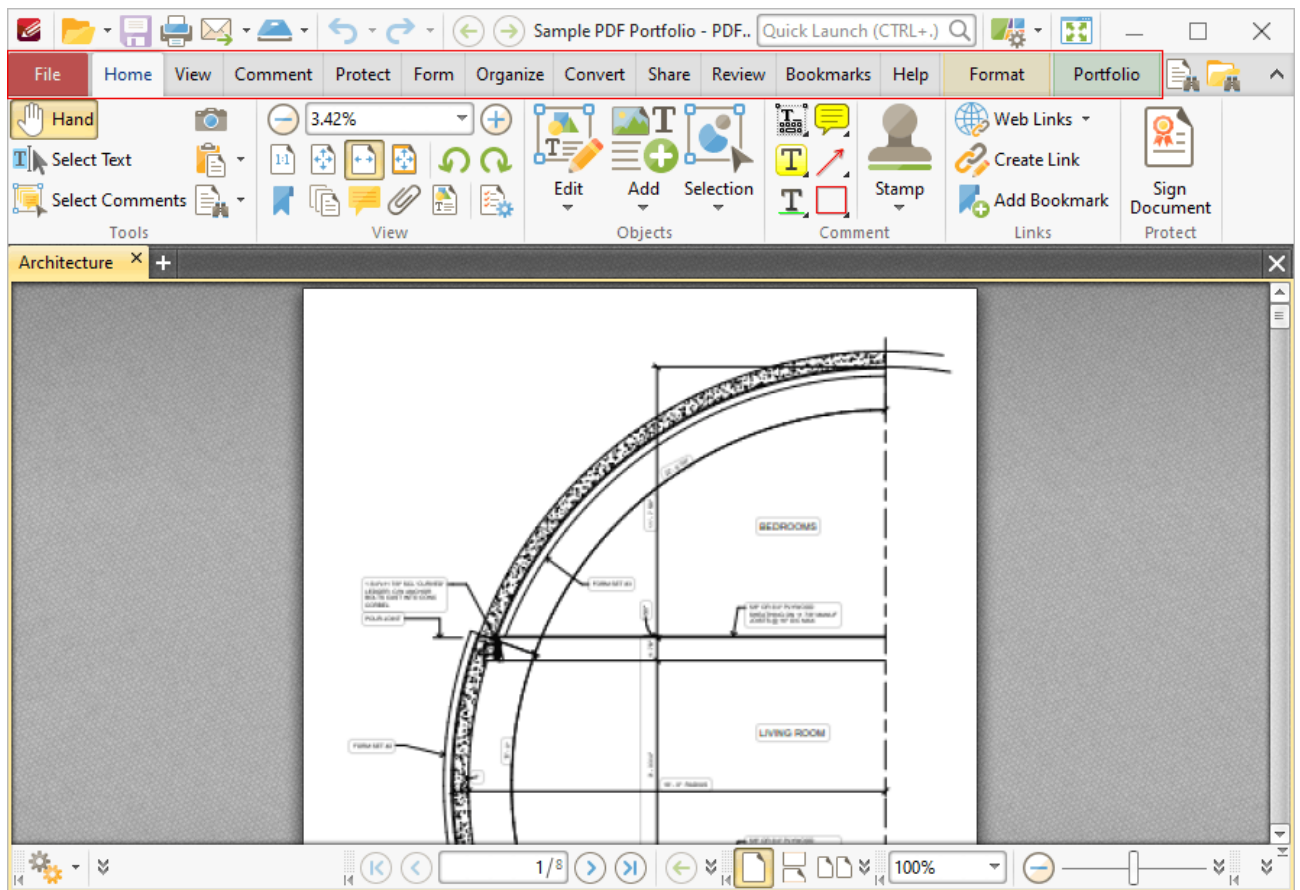

Figure 1. Ribbon Tabs

Click the links below to view the options and functionality of each tab:

- [File](#)<sup>772</sup> contains file-level operations such as open, close, save and print.

- [Home](#)<sup>938</sup> contains the most commonly-used commands, such as the basic tools, links to editing panes, view and rotation options, content-editing features, annotation tools and document signing options.
  - [View](#)<sup>986</sup> contains options that determine what is displayed in the main window such as toolbar shortcuts and editing panes. Document layout options are also available in this tab.
  - [Comment](#)<sup>1082</sup> contains options for editing document comments, such as converting comments to base content, importing/exporting comments and creating a comment summary.
  - [Protect](#)<sup>1244</sup> contains options for signing and certifying documents, creating/editing security policies and redacting documents.
  - [Form](#)<sup>1266</sup> contains options for managing, highlighting and creating document form fields such as radio buttons, dropdown menus and barcodes.
  - [Organize](#)<sup>1447</sup> contains options for editing documents, such as add/remove watermarks, insert/delete/crop/resize pages, edit backgrounds, add headers and footers/Bates numbering.
  - [Convert](#)<sup>1515</sup> contains options for creating documents from the local scanner, combining existing files into a new file, creating blank documents, performing OCR on documents and converting PDF files to other formats such as **MS Word**, **Excel** and **Powerpoint** formats. Note that files exported to **(\* .docx)** format are compatible with **MS Word 2010** and later.
  - [Share](#)<sup>1537</sup> contains options that relate to files associated with the **Microsoft Office SharePoint Server**, such as checking documents in/out or discarding documents from **Sharepoint**, and also contains an option for emailing documents from **PDF-XChange Editor**.
  - [Review](#)<sup>1541</sup> contains options for reviewing documents, such as the spell check and word count features, as well as options to create/delete and manipulate document comments.
  - [Bookmarks](#)<sup>1549</sup> contains options that relate the creation and management of document bookmarks.
  - [Help](#)<sup>1596</sup> contains links to software assistance, such as the **PDF-XChange** main website and user forum, and customizable options for the UI theme and toolbars.
  - [Format](#)<sup>1624</sup> is used to edit content and comment and form field styles in **PDF-XChange Editor**.
  - [Portfolio](#)<sup>1630</sup> is used to edit and manipulate PDF portfolio files.
-

#### 10.4.1 File Tab

---



**File Tab**

---

When the **File** tab is selected, the following options are available:

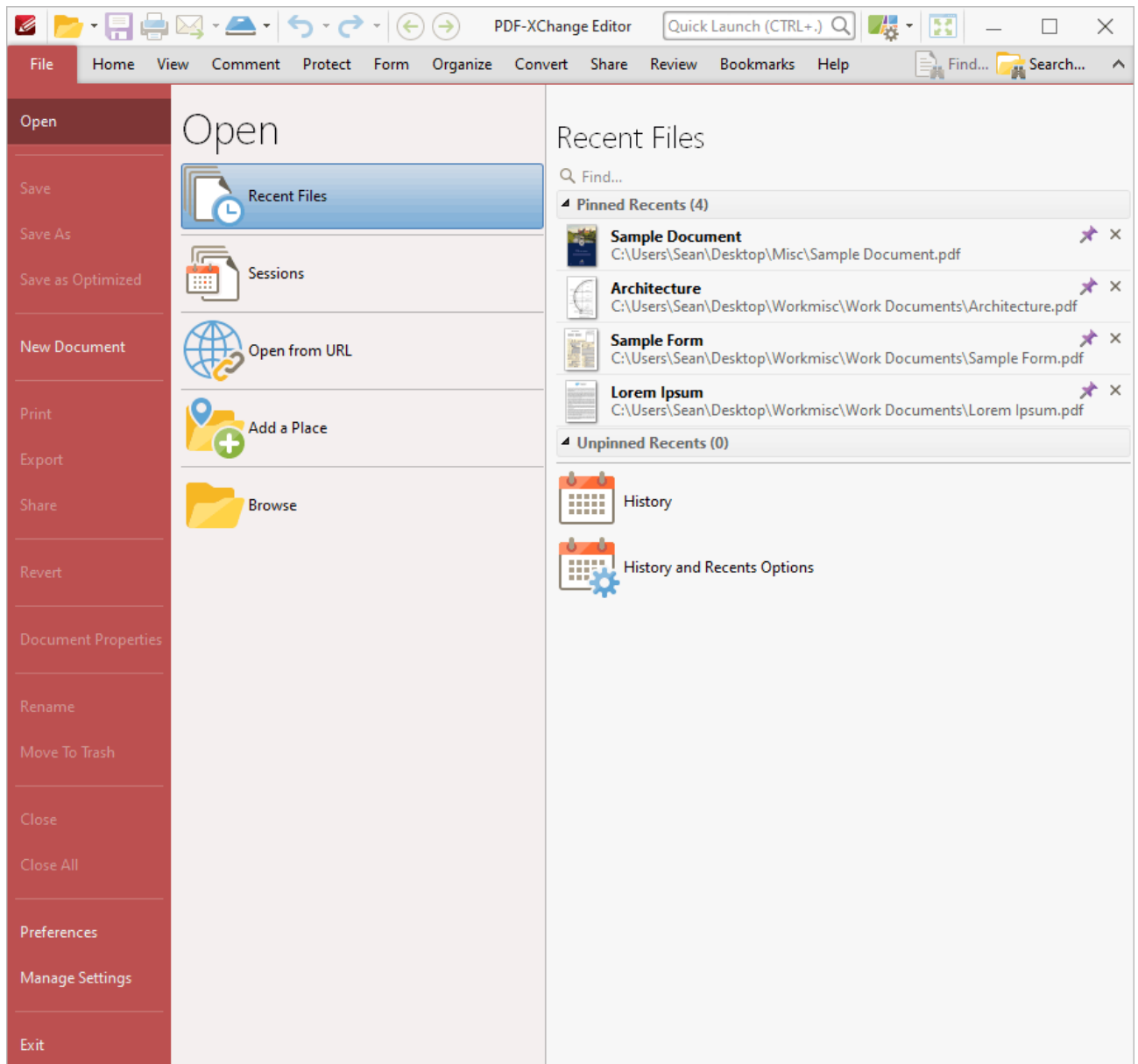

Figure 1. File Tab

Use the options in the pane on the left to perform the following operations:

- Click [Open](#)<sup>[775]</sup> to open documents in **PDF-XChange Editor**, restore previous sessions, link to **Dropbox**, **Google Drive** and **SharePoint** accounts, or open files from URLs.
- Click the [Save Options](#)<sup>[784]</sup> to save documents.
- Click [New Document](#)<sup>[795]</sup> to create new documents. Create documents from text files, rich text format files, image files or the local scanner. Combine existing files into a single document, or create new blank documents.
- Click [Print](#)<sup>[833]</sup> to print documents.

- Click [Export](#)<sup>[838]</sup> to export a copy of documents to image format or **MS Word/Excel/Powerpoint** formats. Note that files exported to **(\* .docx)** format are compatible with **MS Word 2010** and later.
- Click [Share](#)<sup>[841]</sup> to utilize **SharePoint** options or email documents from **PDF-XChange Editor**.
- Click **Revert** to undo changes that have not been saved in the current document.
- Click [Document Properties](#)<sup>[843]</sup> to view/edit document properties.
- Click **Rename** to rename the document.
- Click **Move to Trash** to delete the document.
- Click **Close** to close the current document, or click **Close All** to close all open documents.
- Click [Preferences](#)<sup>[854]</sup> to view/edit the **PDF-XChange Editor** preferences.
- Click the [Manage Settings](#)<sup>[933]</sup> to **Export/Import/Reset** settings.
- Click **Exit** to exit **PDF-XChange Editor**.

Additionally, see the [Document Operations Guide](#)<sup>[632]</sup> for further information and step-by-step instructions for the these features.

---

### 10.4.1.1 Open



The **Open** options are used to open files in **PDF-XChange Editor**:

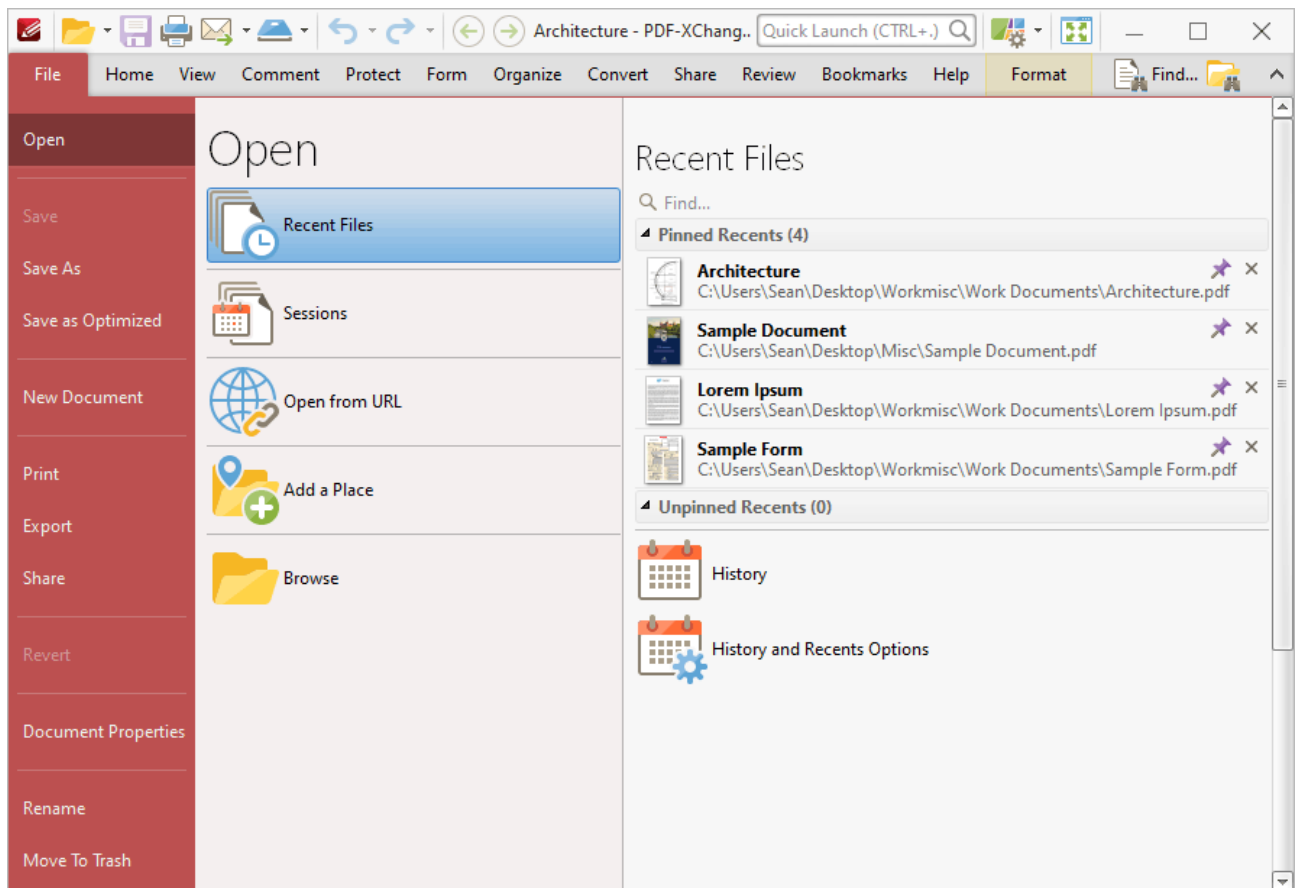

Figure 1. File Tab Submenu, Open Submenu, Recent Files Options

- Click [Recent Files](#)<sup>777</sup> to view/open recent files.
- Click [Sessions](#)<sup>779</sup> to view/open saved sessions.
- Click **Open from URL** to open a document from a **URL**.
- Click [Add a Place](#)<sup>782</sup> to add new places to the **Open** list, such as **Dropbox**, **Google Drive** and **SharePoint** folders.
- Click **Browse** to open a file from the local computer.





### 10.4.1.1.1 Recent Files



## Recent Files

Click **Recent Files** to view files recently open in **PDF-XChange Editor**:

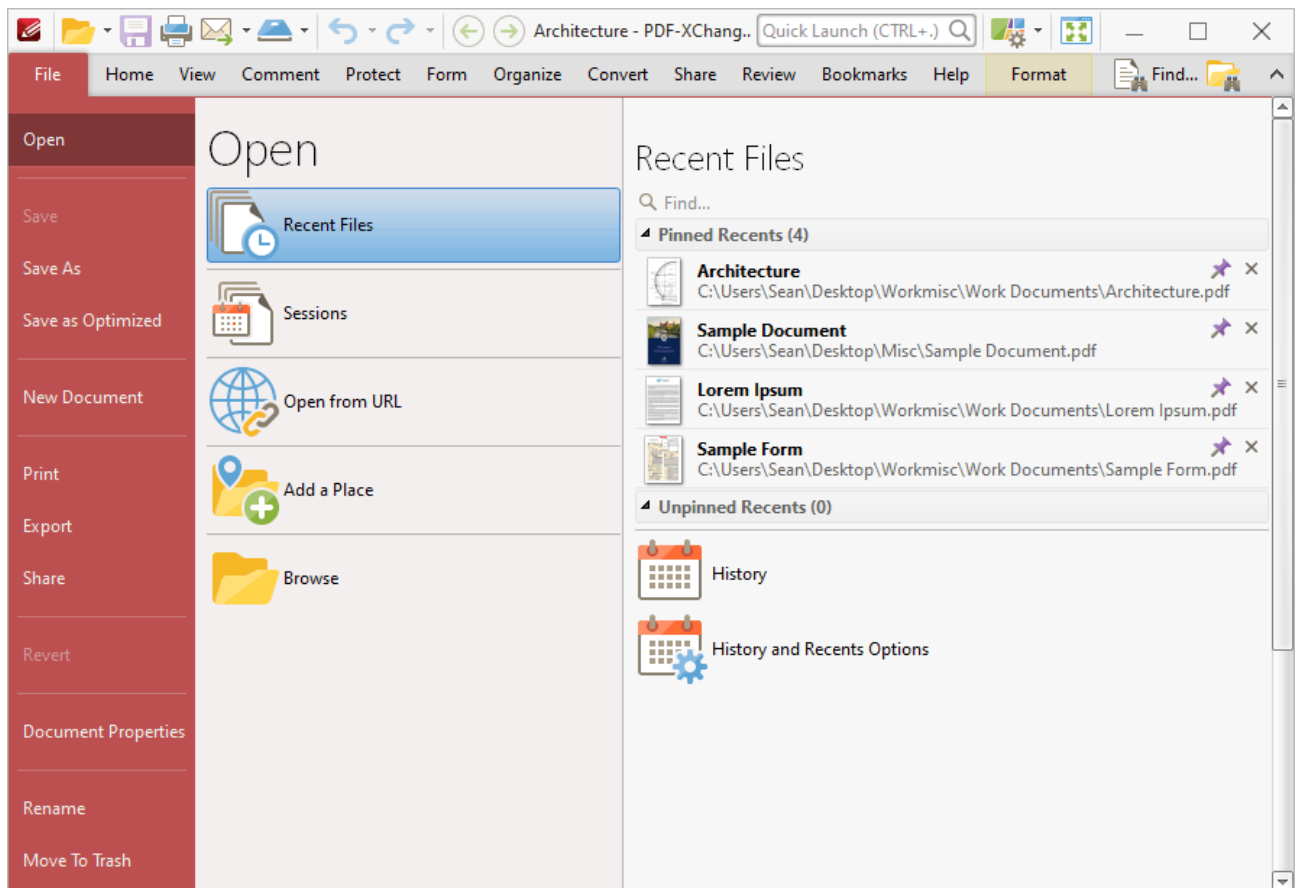

**Figure 1.** File Tab, Open Submenu, Recent Files Options

- All documents viewed previously in **PDF-XChange Editor** are detailed chronologically in the **Unpinned Recents** list.
- Click the pin icon next to unpinned documents in order to add documents to the list of **Pinned Recents**. This feature is included so documents considered more important are not moved down the list when new documents are opened. They remain in the **Pinned Recents** list instead.

- Click the pin icon next to **Pinned Recents** in order to remove documents from the list. Click documents from either list to open them.
- Hover the pointer over documents to view their details.
- Use the **Find** text box to locate and open recent files.
- Click **History** to open the **History** pane in order to view/open recently opened documents, as detailed [here](#).
- Click **Manage History and Recents** to view/edit the **History** and **Recent List Options**:

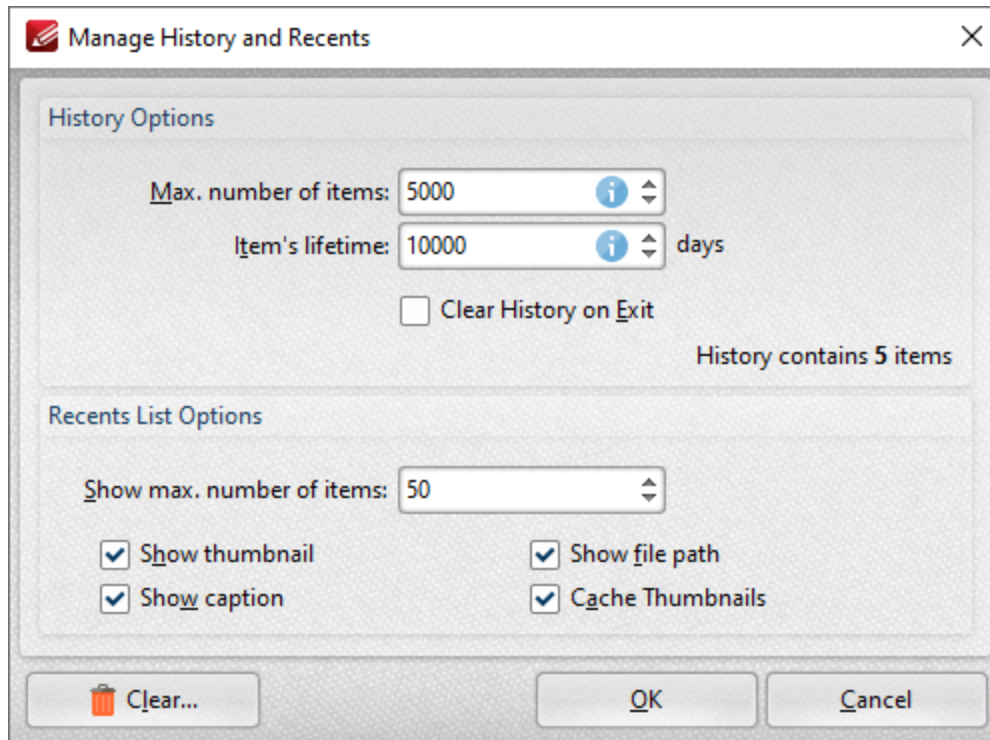

Figure 2. Manage History and Recents Dialog Box

- Use the **Max. number of items** number box to determine the maximum number of files stored in the history of **PDF-XChange Editor**.
- Use the **Item's lifetime** number box to determine the lifetimes of items in the file history list.
- Use the **Show max. number of items** number box to determine the maximum number of items in the **Recents** lists.
- Use the check boxes to determine the elements of files that are displayed in the list.
- Click **Clear** to remove items from the history list.

Click **OK** to save changes.

10.4.1.1.2 Sessions



**Sessions**

Click **Sessions** to view, manage, save or open sessions:

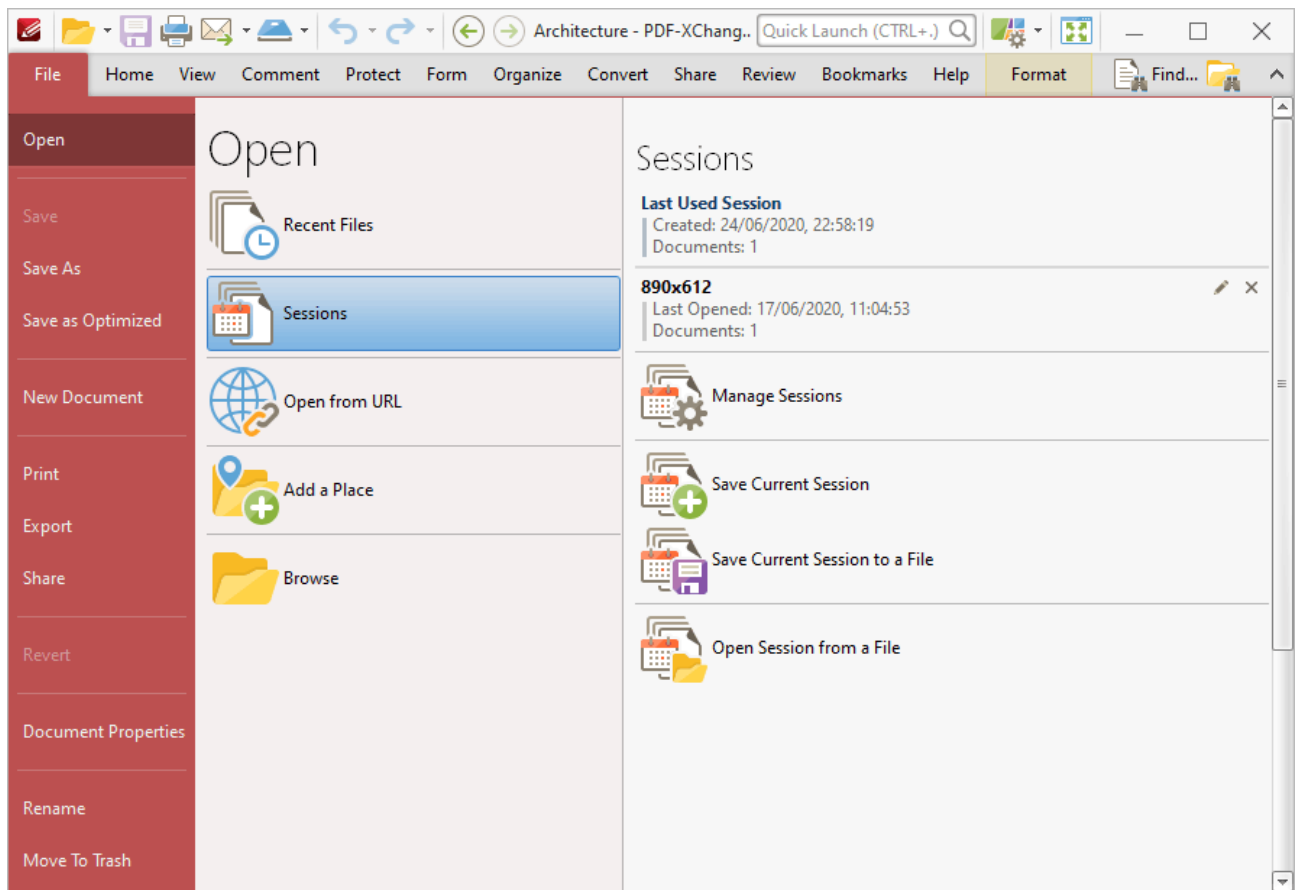

Figure 1. File Tab, Open Submenu, Sessions Options

A session is defined as an active instance of using **PDF X-Change Editor** to view/edit documents. When a session is saved, **PDF-XChange Editor** remembers which documents were open, their order/layout within the main window, the location of the main window on the screen and the status of editing panes. The most recently saved sessions are detailed at the top of the **Sessions** list.

- Click sessions in the **Sessions** list to open them.

- Click **Manage Sessions** to manage existing sessions. The **Manage Sessions** dialog box detailed will open, as detailed in *(figure 2)*.
- Click **Save Current Session** to save the active session. The **Save Current Session** dialog box will open. Enter a name for the session in the text box and click **OK** to save. It will then be available in the **Manage Sessions** list as detailed above.
- Click **Save Current Session to a File** to save the current session as a **.xcsession** file for subsequent use. Saved sessions can be imported via the **Manage Sessions** dialog box. Alternatively, double-click to restore sessions.
- Click **Open Session from a File** to open a session saved in the **.xcsession** format as detailed above.

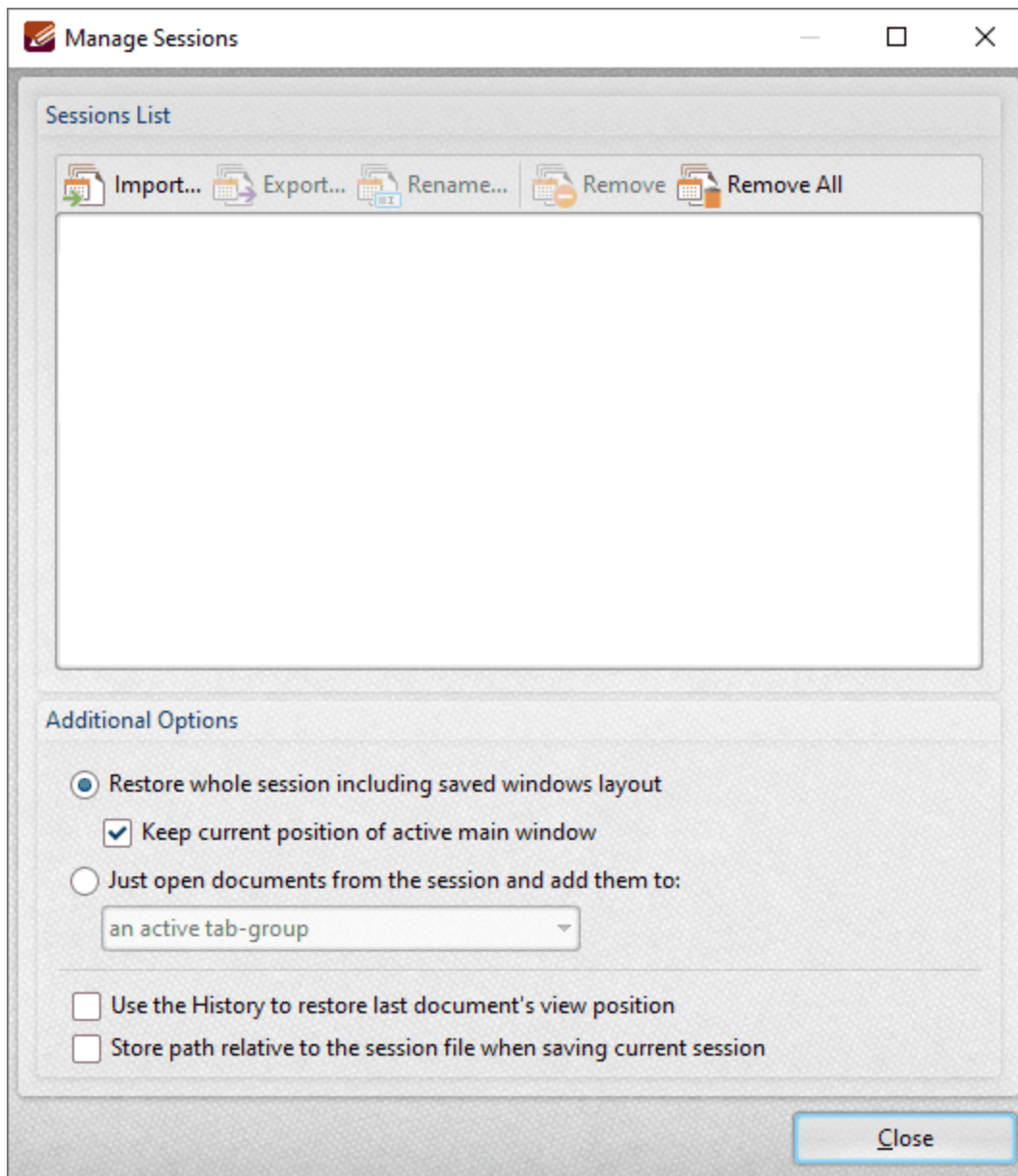

Figure 2. Manage Sessions Dialog Box

- Click **Import** to import a previously saved session. The **Open Session** dialog box will open. Select the desired file and click **Open** to open it.
- Click **Export** to export the session currently selected in the list of sessions. The **Save Current Session** dialog box will open. Enter a name for the file and click **Save** to save it.
- Click **Rename** to rename the session currently selected. The **PDF-XChange Editor** dialog box will open. Enter a new name for the session in the text box and click **OK** to save it.
- Click **Remove** to remove the session currently selected.
- Click **Remove All** to remove all sessions from the list.

Further settings are available in the **Additional Options** section:

- Select the **Restore whole session including saved windows layout** button to restore the open documents and windows layout (such as the **Thumbnails/Bookmarks** pane) when sessions are opened.
    - Select the **Keep current position of active main window** to retain the current position of the main window when sessions are opened.
  - Select the **Just open documents from the session and add them to** button to restore only the open documents from the session, and then select an option from the dropdown menu to determine how the documents are added:
    - **Active Tab Group**
    - **New Tab Group in the Active Window**
    - **New Tab Group in a New Window**
  - Select the **Use the History to restore last document's view position** box to open documents at the location that was current when the document was last closed. If this option is not selected, then documents will open at the location that was current when the session was saved.
  - Select the **Store path relative to the session file when saving current session** to save sessions relative to the session file. This feature is useful in cases where documents (including the session file) are located on a network/portable device such as a USB stick that multiple users will share. Note that the session file and any associated files must be saved on the same disk for this feature to operate.
-

### 10.4.1.1.3 Add a Place



**Add a Place**

Click **Add a Place** to add new places to the **Open** list for subsequent use:

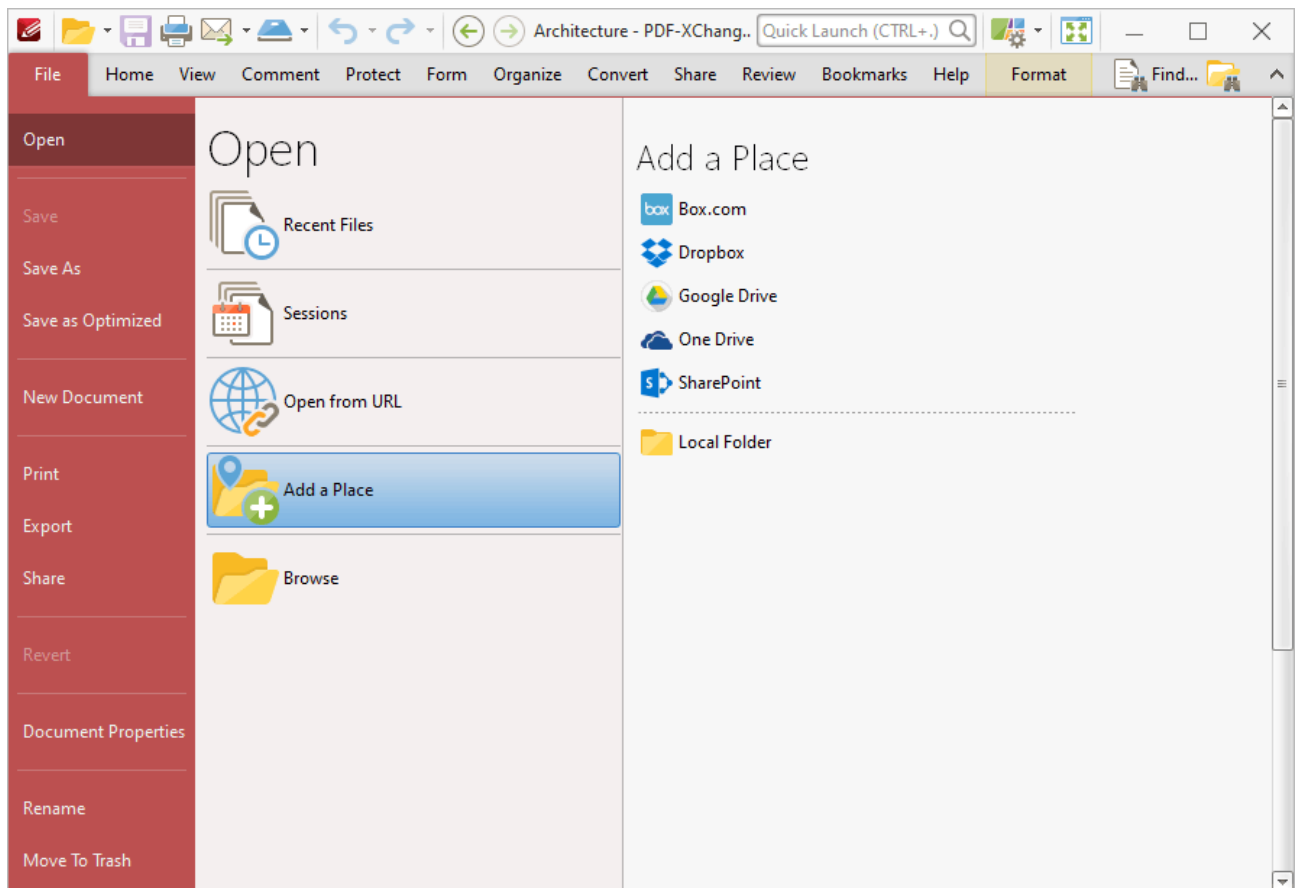

**Figure 1.** File Tab, Open Submenu, Add a Place Options

- Click **Box.com**, **Dropbox**, **Google Drive**, **OneDrive** or **SharePoint**, then enter your login details to add an account to the list.
- Click **Local Folder** to add a folder on the local computer to the list, then select a folder to add it to the list.

Added places appear as detailed below:

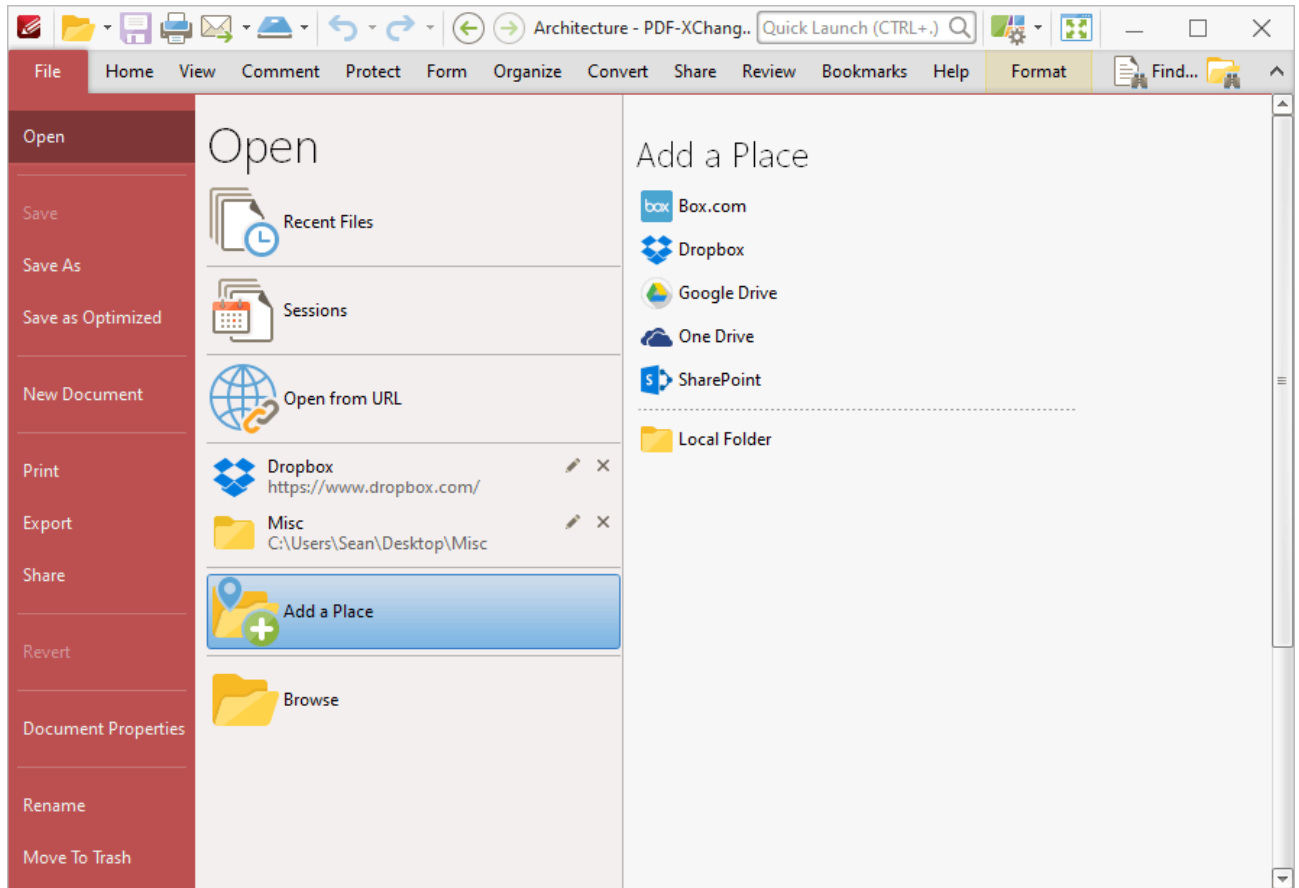

Figure 2. File Tab, Open Submenu, Places Added

Click places to open them, then select files to view/edit them in **PDF-XChange Editor**. Click the 'x' icon to remove places from the list and the pencil icon to rename places.

### 10.4.1.2 Save Options



## Save Options

The save options are used to save documents in **PDF-XChange Editor**:

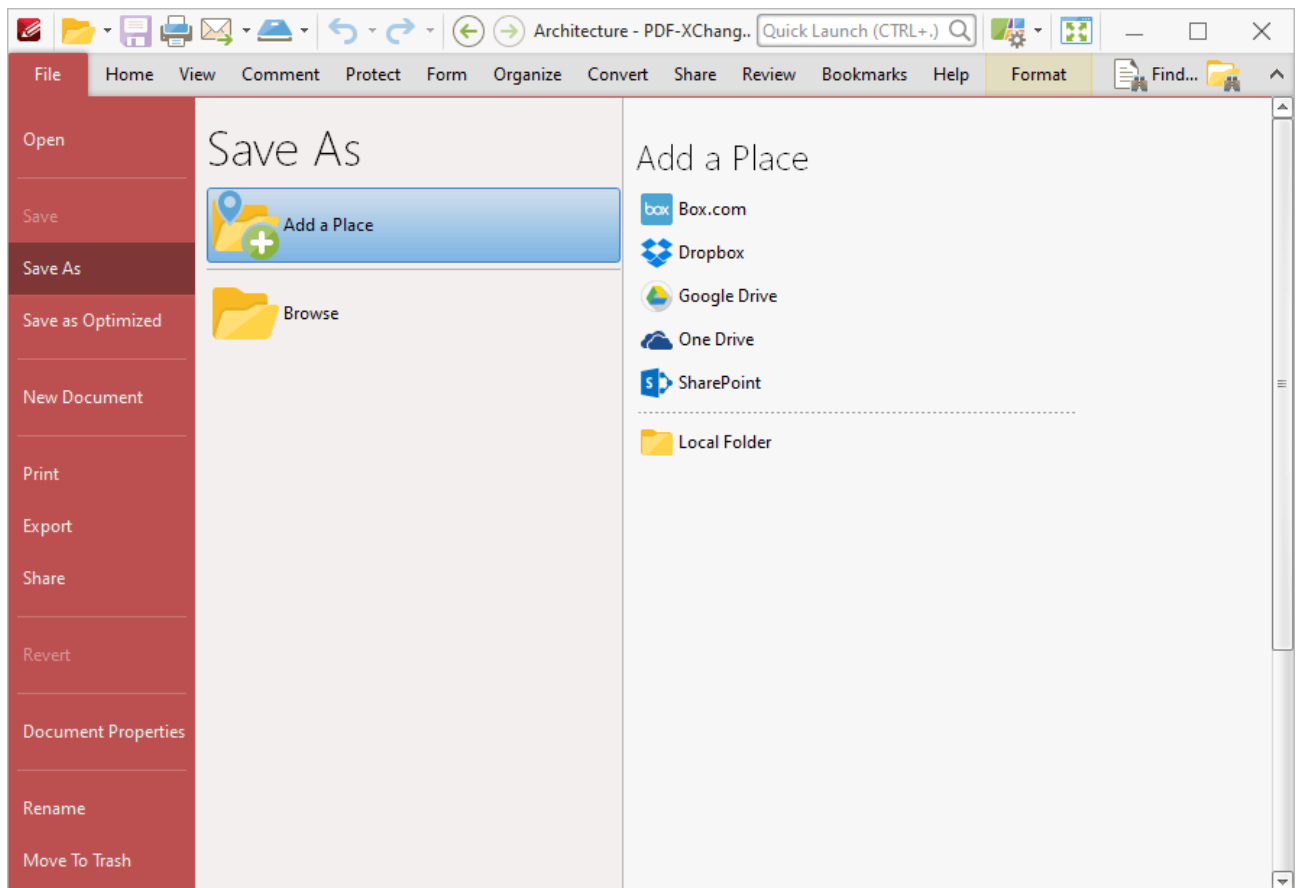

**Figure 1.** File Tab Submenu. Save Options

- Click **Save** to save the active document. Any changes made since the document was opened will be saved and the original version of the document will be overwritten.
- Click **Save As** to save the edited document with a new name and retain the original version of the document.
- Click **Save as Optimized** to optimize files before they are saved, as detailed below.
- Use the **Add a Place** options to add save locations to the **Save As** list:



- Click **Dropbox**, **Google Drive** or **SharePoint**, then enter your login details to add an account to the list.
- Click **Local Folder** to add a folder on the local computer to the list, then select a folder to add it to the list.

Added places are displayed in the **Save As** list:

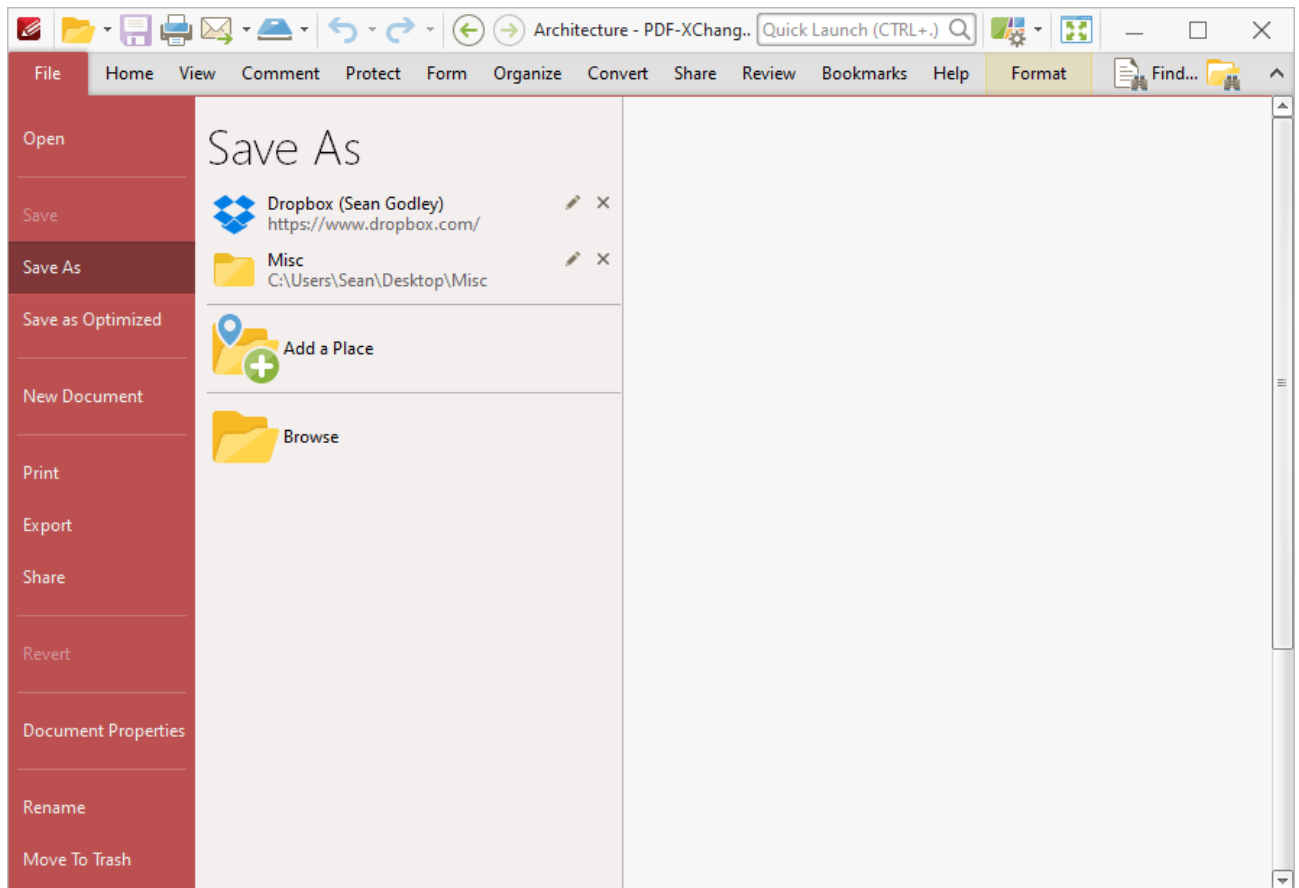

**Figure 2.** File Tab, Save As Submenu, Places Added

Click places to save files to them. Click the 'x' icon to remove places from the list.

## Save As Optimized

When this option is selected the **Optimize PDF** dialog box will open:

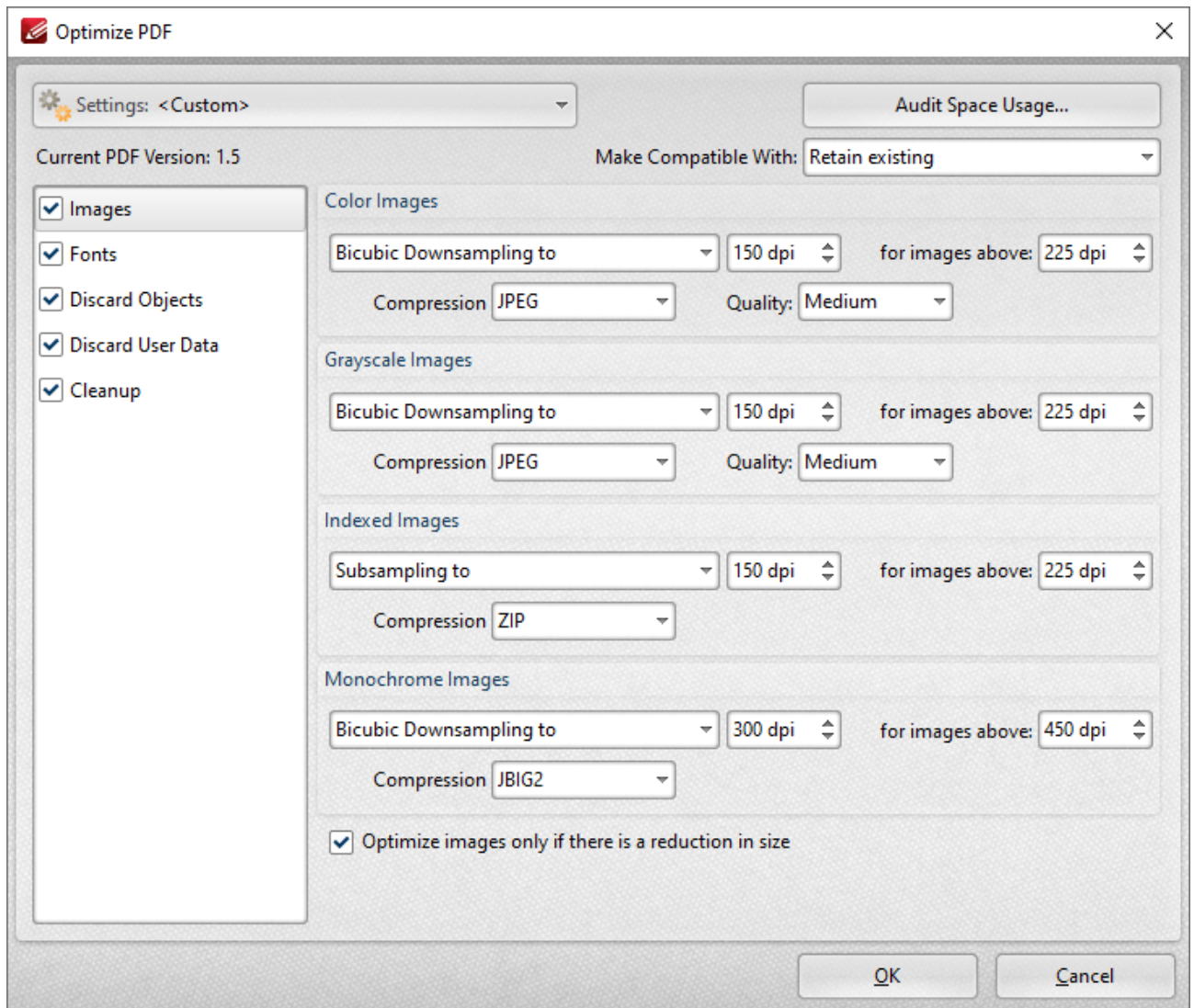

Figure 2. Optimize PDF Dialog Box, Images Tab

These settings are used to optimize PDF content:

## Images

The options for optimizing images are detailed in **(figure 2)**. They are as follows:

- Click the **Color Images, Grayscale Images, Indexed Images** and **Monochrome Images** menus to select settings for the respective image formats.
- Click the **Bicubic Downsampling/Subsampling** menus to increase/reduce the resolution of images.
- Click the arrows in the **DPI** box, or enter a figure manually, to select the dots-per-inch resolution for new images.
- Click the arrows in the **for images above** box, or enter a figure manually, to select the minimum **DPI** at which images are downsampled/subsampled.

- Click the **Compression** menus to select the compression format of images. Where applicable click the **Quality** menu to select the compression quality.
- The **Optimize images only if there is a reduction in size** box is selected by default. Clear this box to optimize images even when there is no reduction in size.

## Fonts

Click **Fonts** to determine the settings for font optimization:

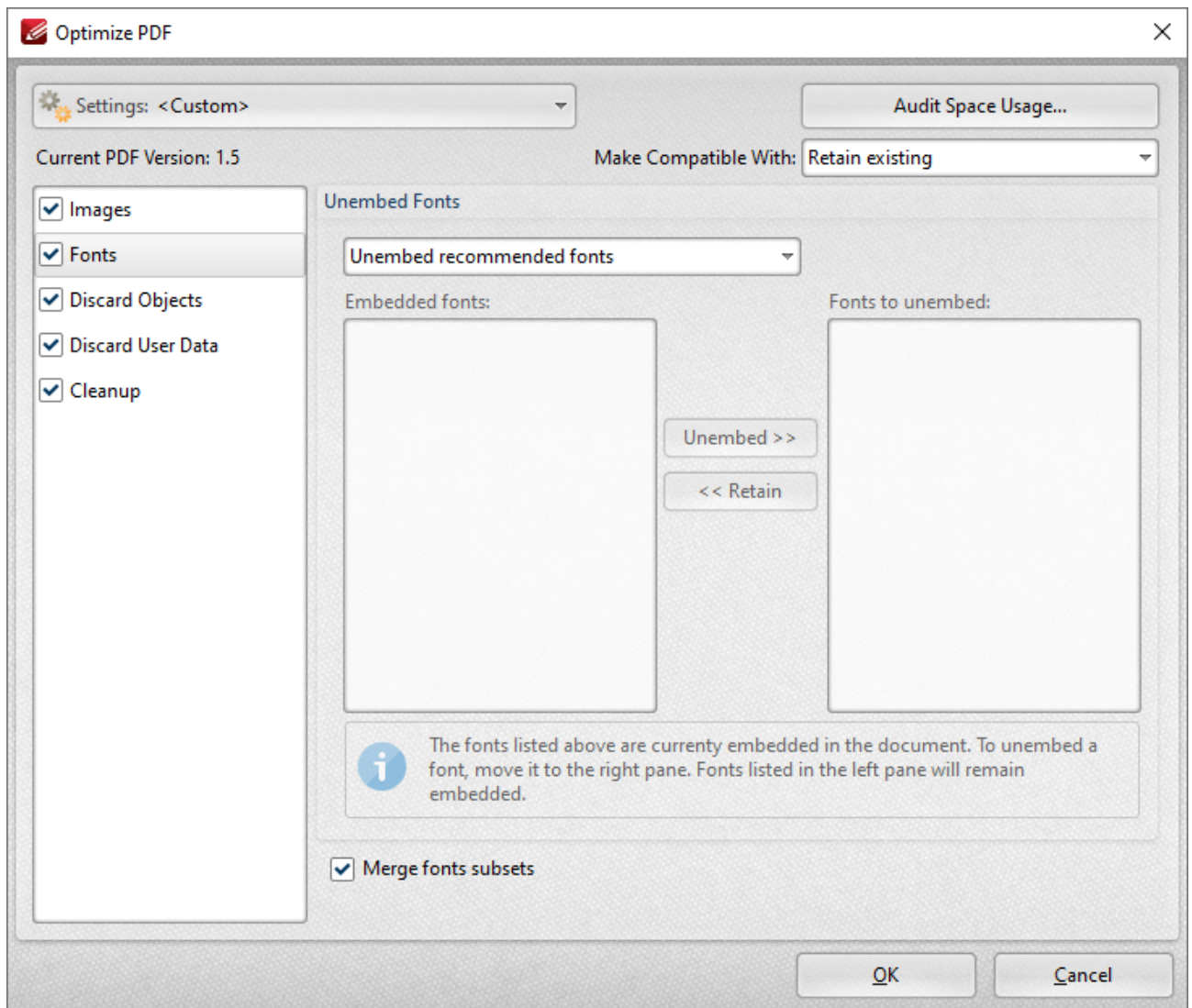

Figure 3. Optimize PDF Dialog Box, Fonts Tab

- Use the **Unembed Fonts** dropdown menu to determine font embedding options:
  - Select **Do Not Unembed any font** to retain all embedded fonts.
  - Select **Unembed recommended fonts** to unembed recommended fonts, which will result in the unembedding of the most common fonts in order to reduce the file size.

- Select **Unembed all fonts** to unembed all fonts. This will reduce the size of files as far as possible with regard to fonts. However, it also increases the risk of compatibility issues for subsequent users of the document. This is because they will not be able to read the document unless the application they are using to view the document contains the font. Therefore this setting should be used only in cases where documents contain only common fonts.
- Select **Select fonts to unembed manually** to unembed a custom selection of fonts. When this option is selected the fonts used in the current document are displayed in the **Embedded Fonts** pane. Select fonts and click the **Unembed** button to unembed them when the file is optimized. Select fonts within the **Fonts to Unembed** pane and click **Retain** to retain them when the file is optimized.
- Select the **Merge fonts subsets** box to merge duplicated font subsets.

## Discard Objects

Click **Discard Objects** to determine the settings for discarding objects:

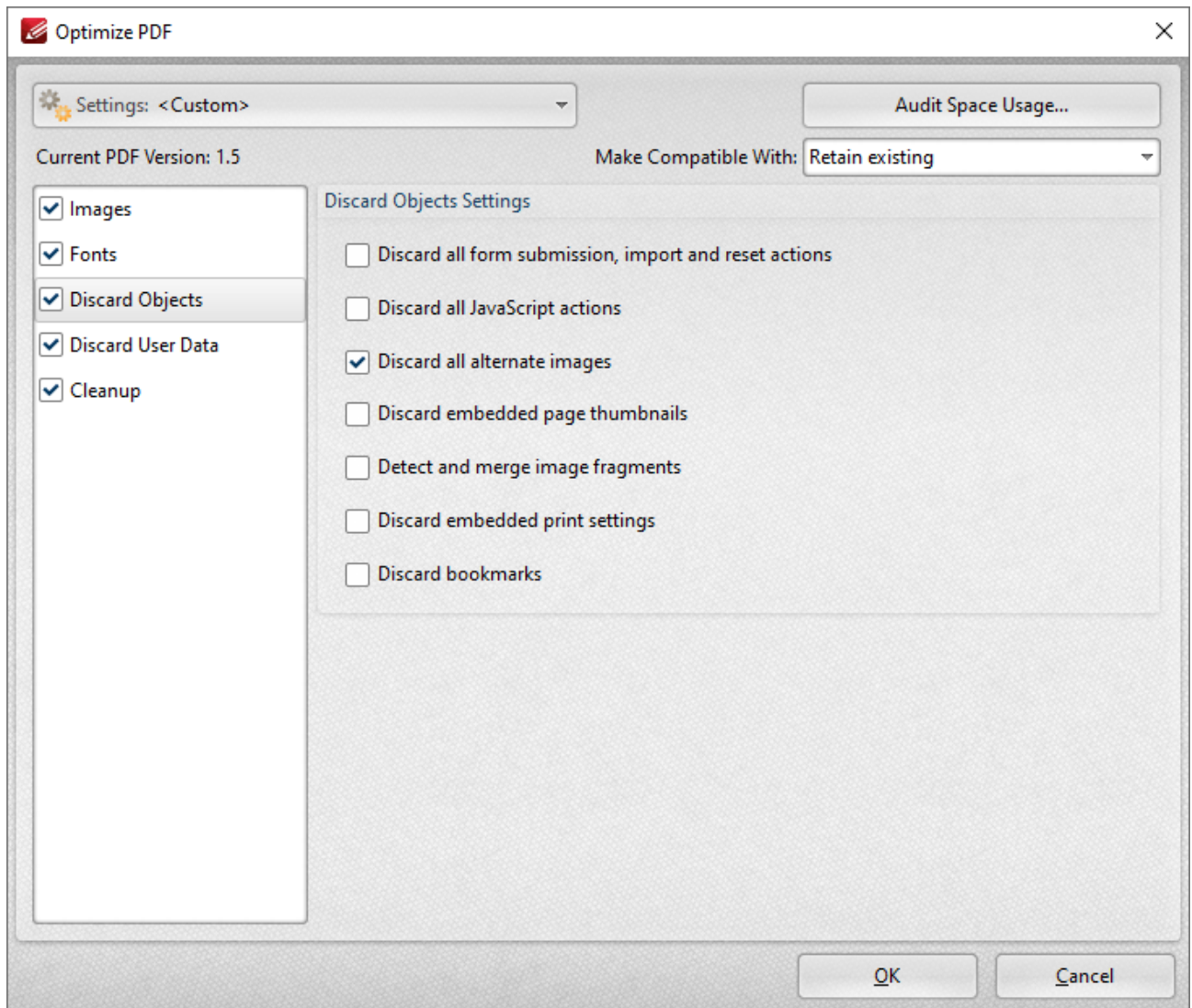

Figure 4. Optimize PDF Dialog Box, Discard Objects Tab

- Select the **Discard all form submissions, import and reset actions** box to remove these elements from the document.
- Select the **Discard all JavaScript actions** box to remove JavaScript actions from the document.
- Select the **Discard all alternate images** box to remove alternate images from the document. Alternate images are additional versions of existing images that may differ slightly, such as in resolution or color space.
- Select the **Discard embedded page thumbnails** box to remove embedded page thumbnails from the document.
- Select the **Detect and merge image fragments** box to merge image fragments. Note that some images are composed of fragmented sections that are spliced together. Merging these fragments will reduce the file size.
- Select the **Discard embedded print settings** box to discard remnant encoding in cases where documents were created with a virtual printer.
- Select the **Discard bookmarks** box to remove all bookmarks from the document.

## Discard User Data

Click **Discard User Data** to determine the settings for discarding user data:

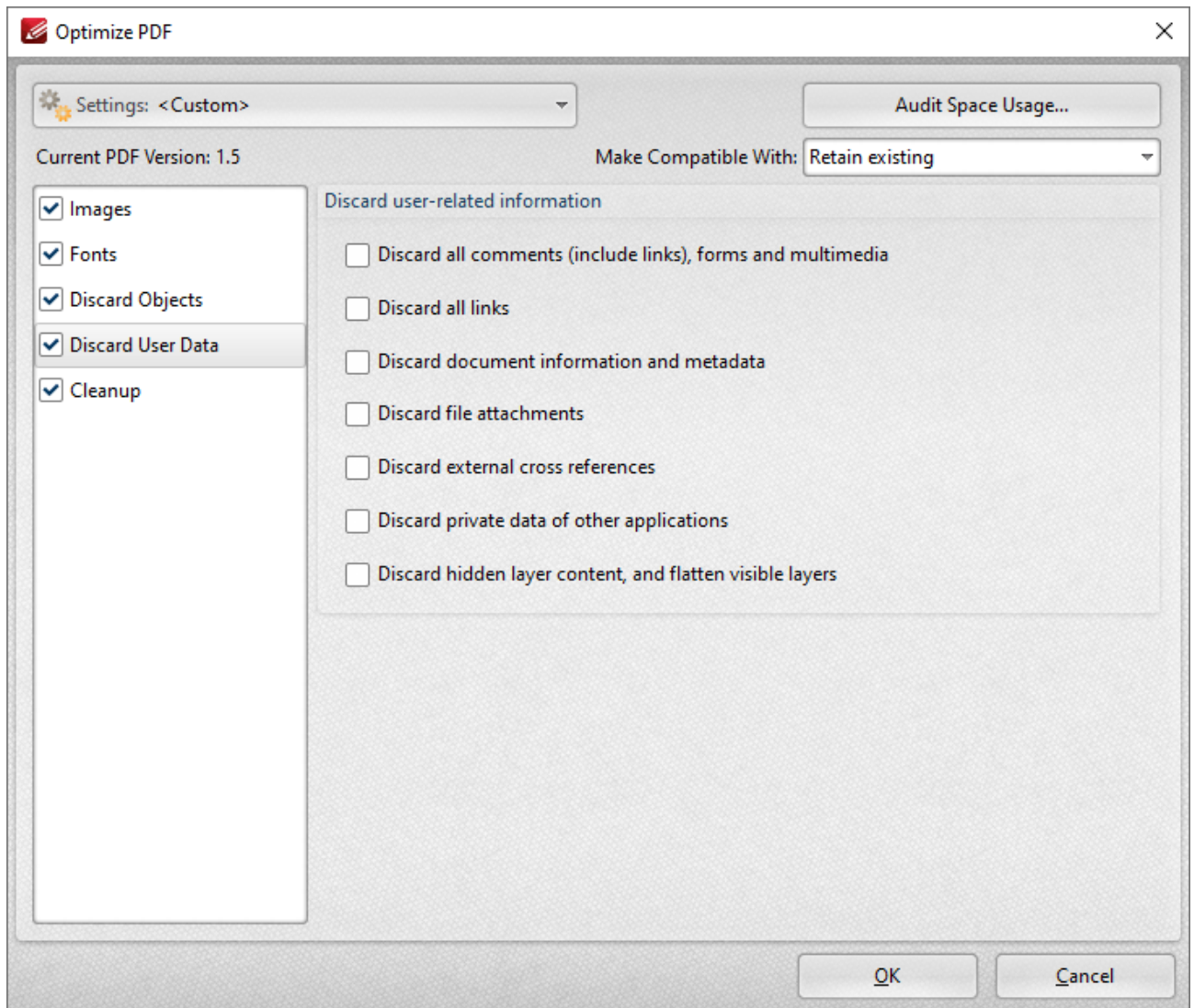

Figure 5. Optimize PDF Dialog Box, Discard User Data Tab

- Select the **Discard all comments, forms and multimedia** box to remove these elements from the document.
- Select the **Discard document information and metadata** box to remove all metadata from the document.
- Select the **Discard file attachments** box to remove attached/embedded files from the document.
- Select the **Discard private data of other applications** box to remove information from the document that is useful only to the application used to create it.

- Select the **Discard hidden layer content and flatten visible layers** box to remove hidden layers from the document and flatten the visible layers to base content.

## Cleanup

Click **Cleanup** to determine cleanup options:

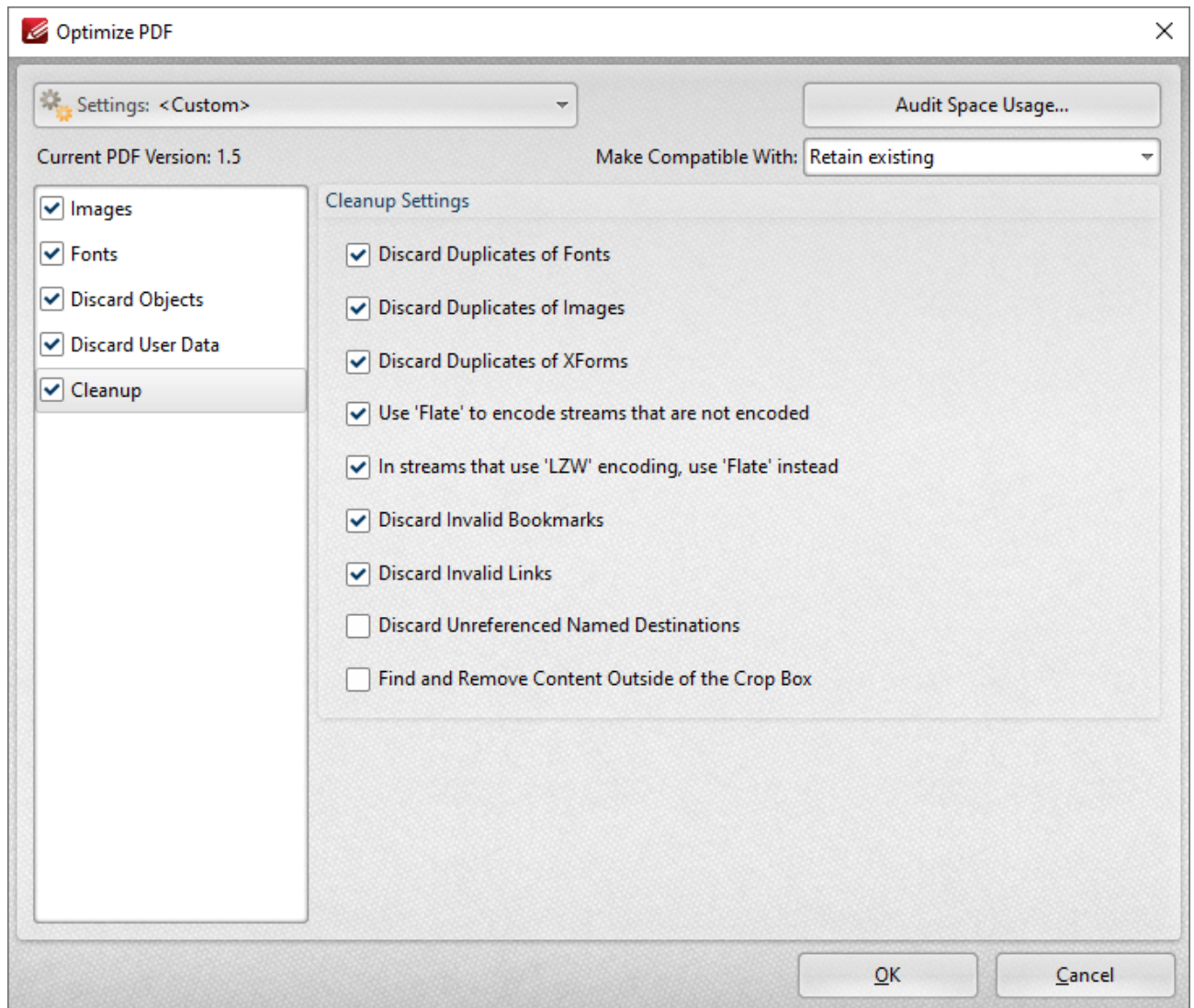

Figure 6. Optimize PDF Dialog Box, Cleanup Tab

- Select the **Discard Duplicates of Fonts** box to remove redundant fonts from the document.
- Select the **Discard Duplicates of Images** box to remove duplicate images from the document.
- Select the **Discard duplicates of XForms** box to remove duplicate XForms from the document.
- Select the **Use Flate to encode streams that are not encoded** box to compress document information that is pending for compression.

- Select the **In Streams that use LZW encoding use Flate instead** box to use **Flate** compression instead of LZW encoding. This is recommended as **Flate** is compatible with a wider range of platforms.
- Select the **Discard Invalid Bookmarks** box to discard bookmarks that do not contain actions/valid destinations.
- Select the **Discard Unreferenced Named Destinations** box to remove named destinations that are not referenced in the document.
- Select the **Find and Remove Content Outside of the Crop Box** box to remove content outside the crop box. Note that this content is hidden when documents are displayed.

## Settings

Click the **Settings** dropdown menu to toggle between **Standard Mode**, which is best for computers, and **Mobile Mode**, which is best for tablets and cell phones:

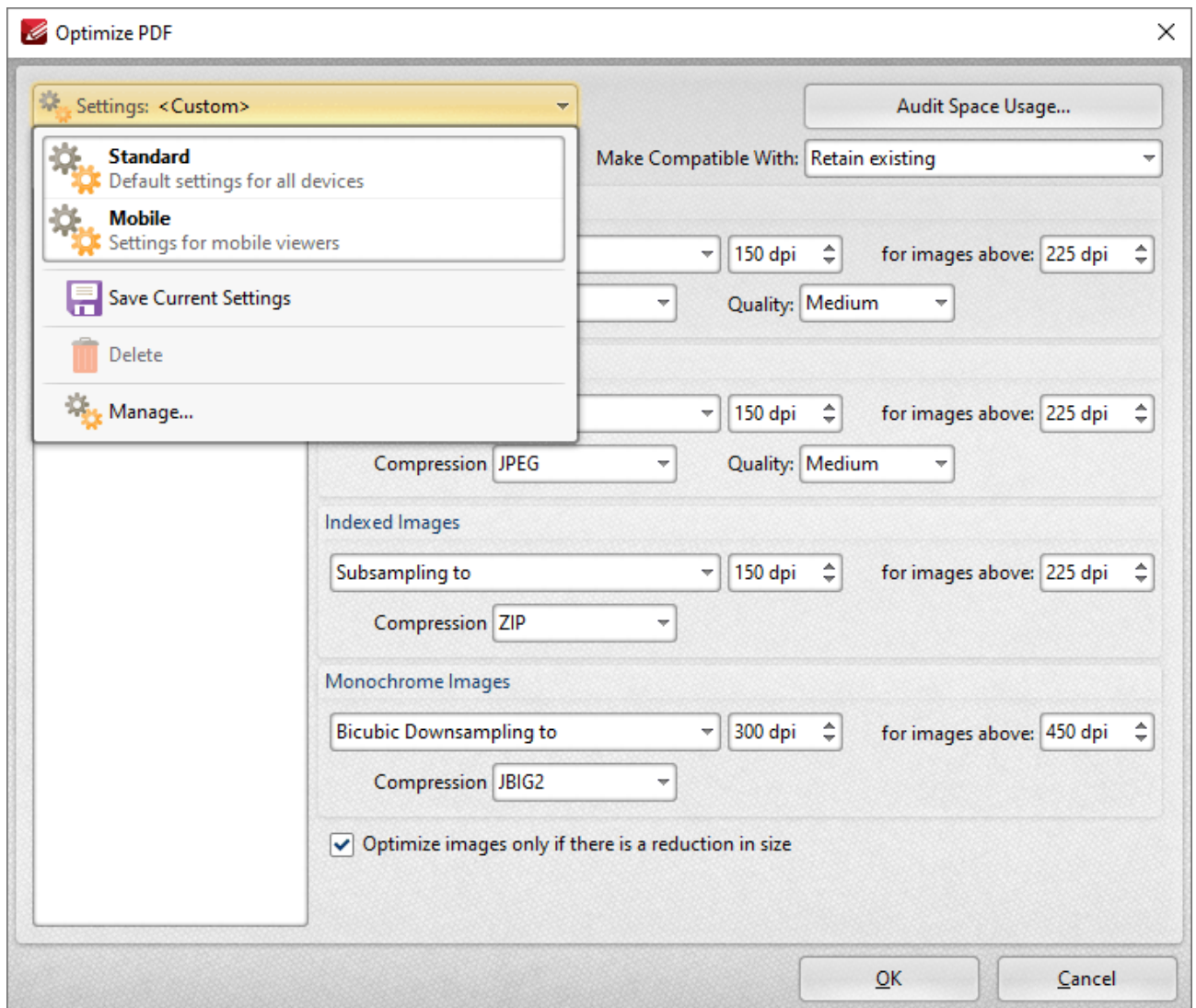

Figure 7. Optimize PDF Dialog Box, Settings Dropdown Menu



The **Settings** dropdown menu is also used to save, manage and delete customized settings:

- Click **Save Current Settings** to save custom settings for subsequent use. Saved profiles are detailed in the **Settings** dropdown menu.
- Click **Delete** to delete selected profiles.
- Click **Manage** to manage saved custom settings. The **Manage Presets** dialog box will open:

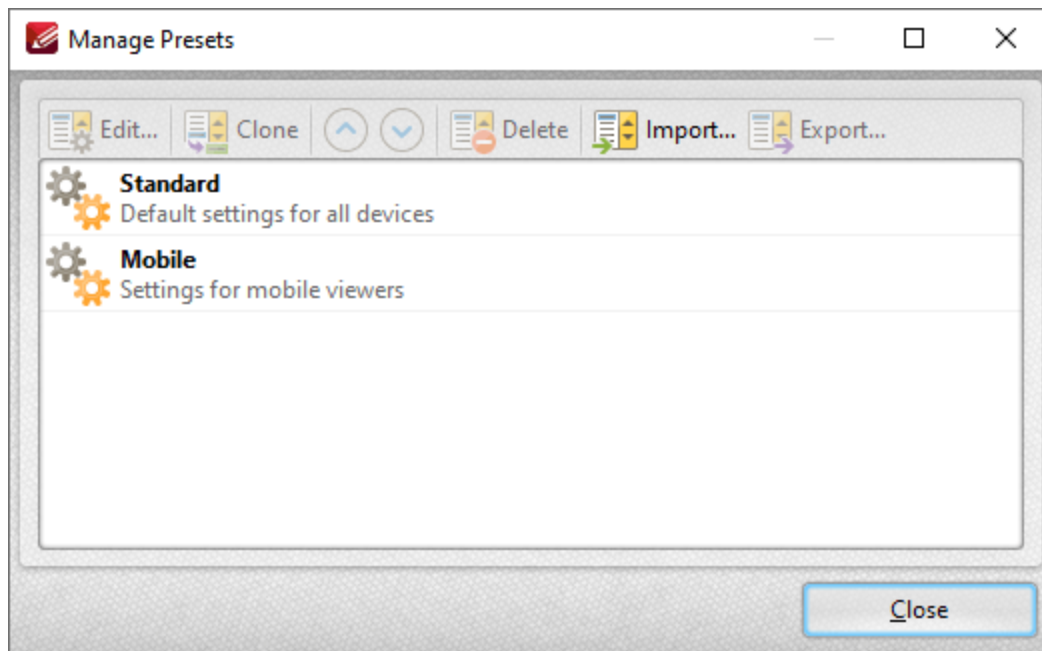

Figure 8. Manage Presets Dialog Box

- Click **Edit** to edit selected profiles.
- Click **Clone** to clone selected profiles. This makes it possible to duplicate profiles and then customize their settings whilst retaining the existing profile and its parameters.
- Use the up and down arrow to move selected profiles up or down in the list.
- Click **Delete** to delete selected profiles.
- Click **Import** to import profiles from a saved file.
- Click **Export** to export profiles to file.

Select an option in the **Make Compatible With** dropdown menu to make optimized documents compatible with specified versions of **Acrobat**:

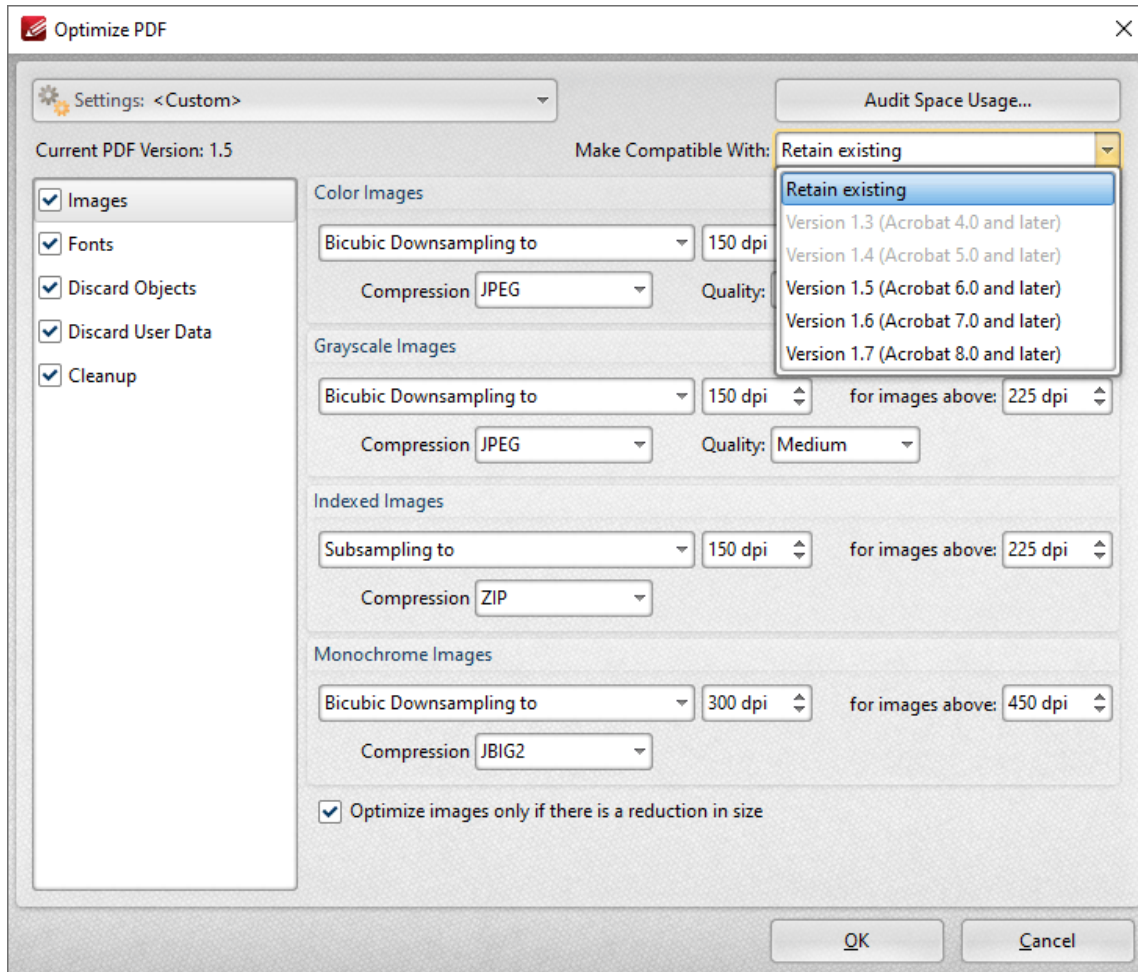

Figure 9. Optimize PDF Dialog Box, Make Compatible Dropdown Menu

Click **Audit Space Usage** to view a breakdown of the space used in the document.

Click **OK** to save changes.

### 10.4.1.3 New Document



## New Document

Click **New Document** to view the options for creating new documents:

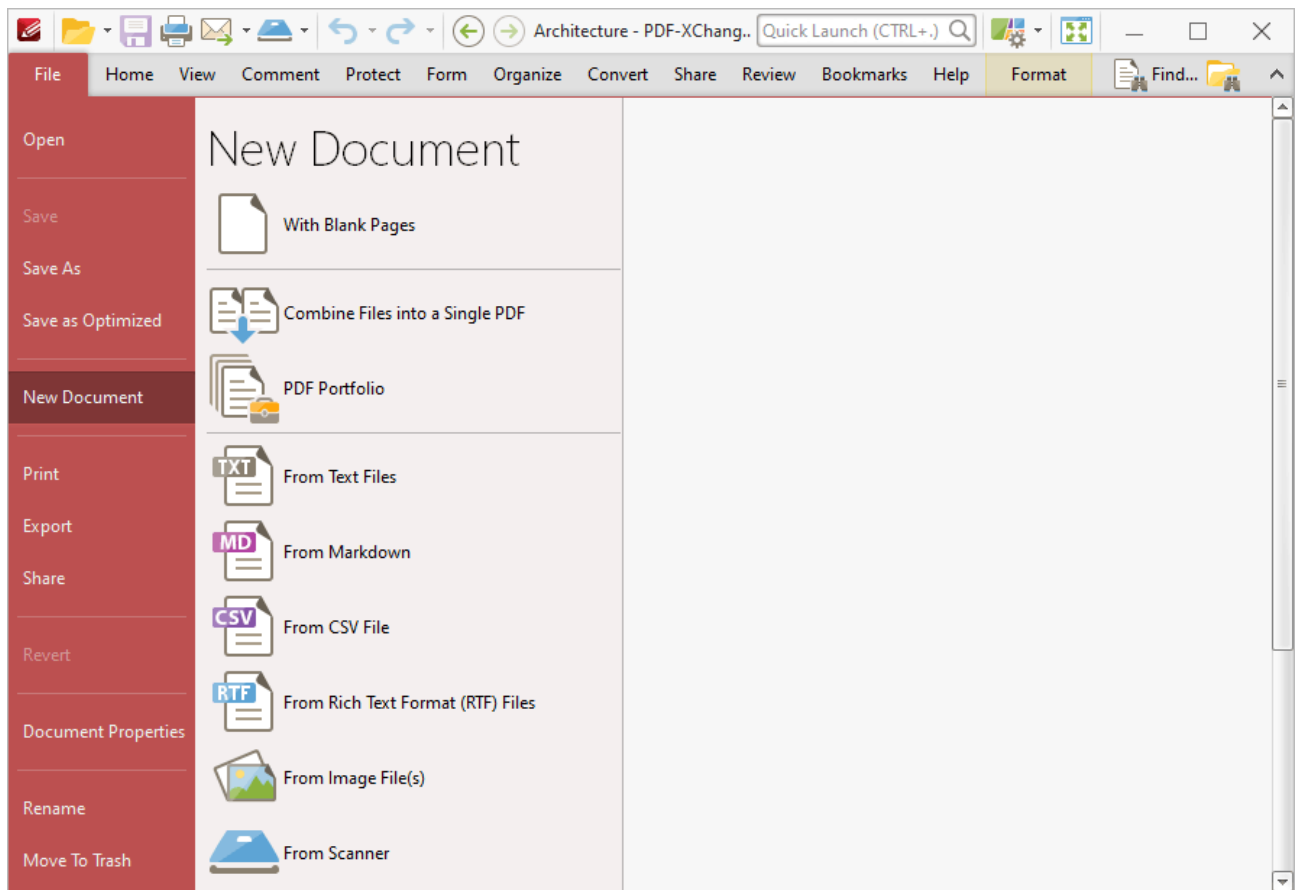



Figure 1. File Tab Submenu, New Document Options

- Click [With Blank Pages](#)<sup>[797]</sup> to create a blank document.
- Click [Combine Files into a Single PDF](#)<sup>[799]</sup> to combine existing files into a single document.
- Click [PDF Portfolio](#)<sup>[803]</sup> to create a PDF portfolio file.
- Click [From Text Files](#)<sup>[807]</sup> to convert text files into PDF.
- Click [From Markdown](#)<sup>[812]</sup> to convert Markdown files into PDF.
- Click [From CSV File](#)<sup>[815]</sup> to convert CSV (comma separated values) files into PDF.

- Click [From Rich Text Format \(RTF\) Files](#)  to convert RTF files into PDF.
  - Click [From Image File\(s\)](#)  to convert image files into PDF.
  - Click [From Scanner](#)  to create new PDF documents from the local scanner.
-

## 10.4.1.3.1 With Blank Pages



### With Blank Pages

Click **With Blank Pages** to create a blank document:

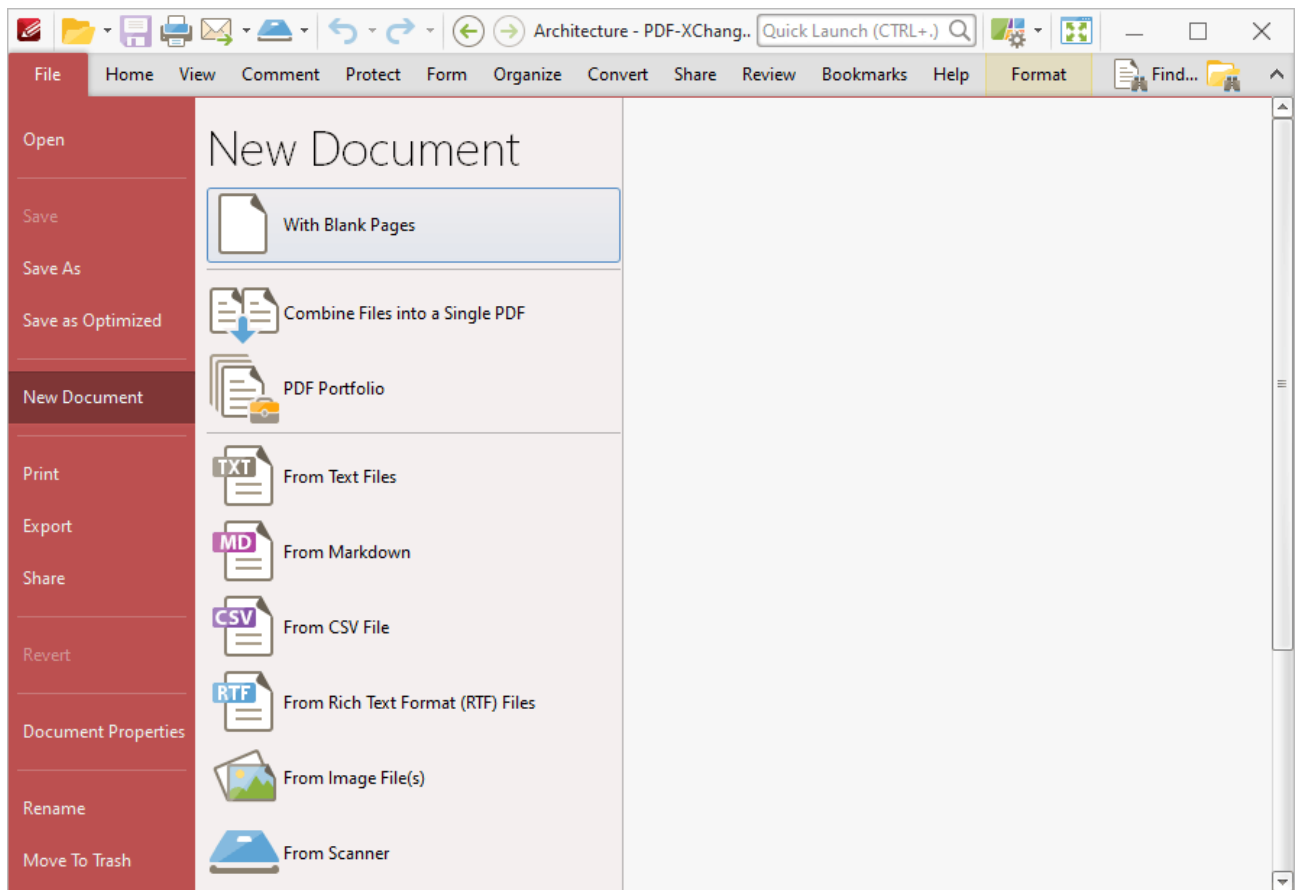

Figure 1. File Tab Submenu, New Document Options, With Blank Pages

The **New Empty Document** dialog box will open:

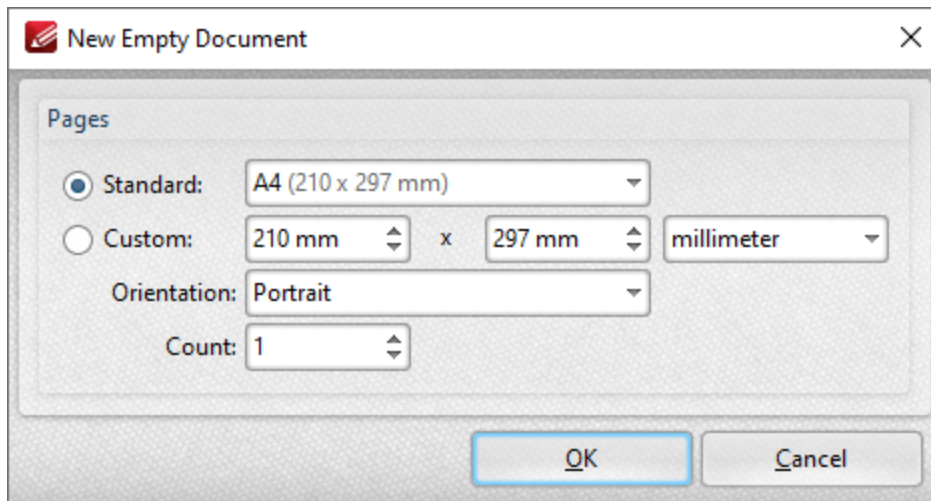

Figure 2. New Empty Document Dialog Box

- The **Standard** options are standard dimensions for documentation such as those used by the **ISO** and **ANSI**.
- The **Custom** options can be used to enter custom dimensions. Enter the desired measurements into the text boxes and select the units of measurement.
- Select either **Portrait** or **Landscape** as the orientation.
- The **Count** option determines how many blank pages are created.

Click **OK** to create the new document.

---

## 10.4.1.3.2 Combine Files Into a Single PDF



### Combine Files into a Single PDF

Click **Combine Files into a Single PDF** to combine existing files into a single document:

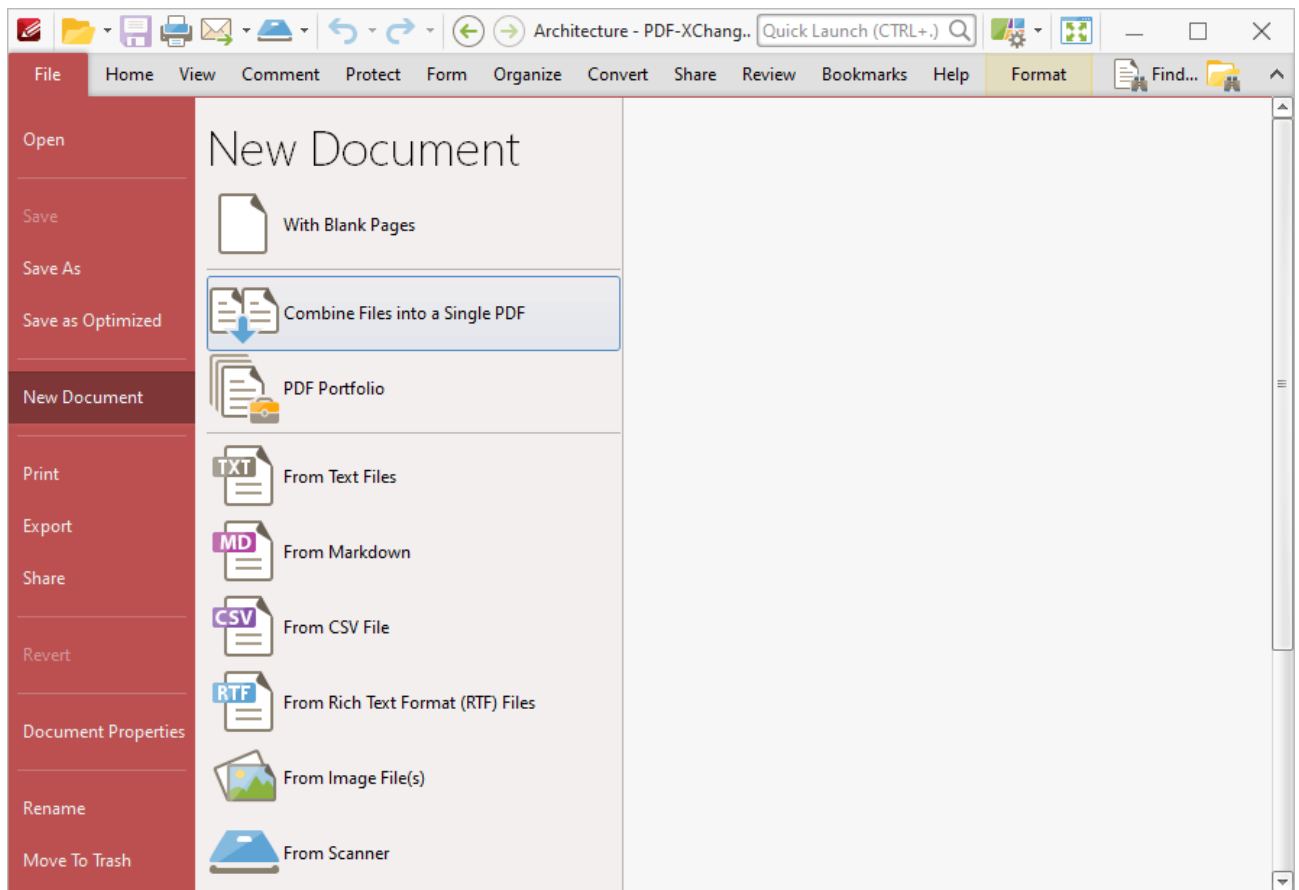

**Figure 1.** File Tab Submenu, New Document Options, Combine Files into a Single PDF

The **Combine Files** dialog box will open:

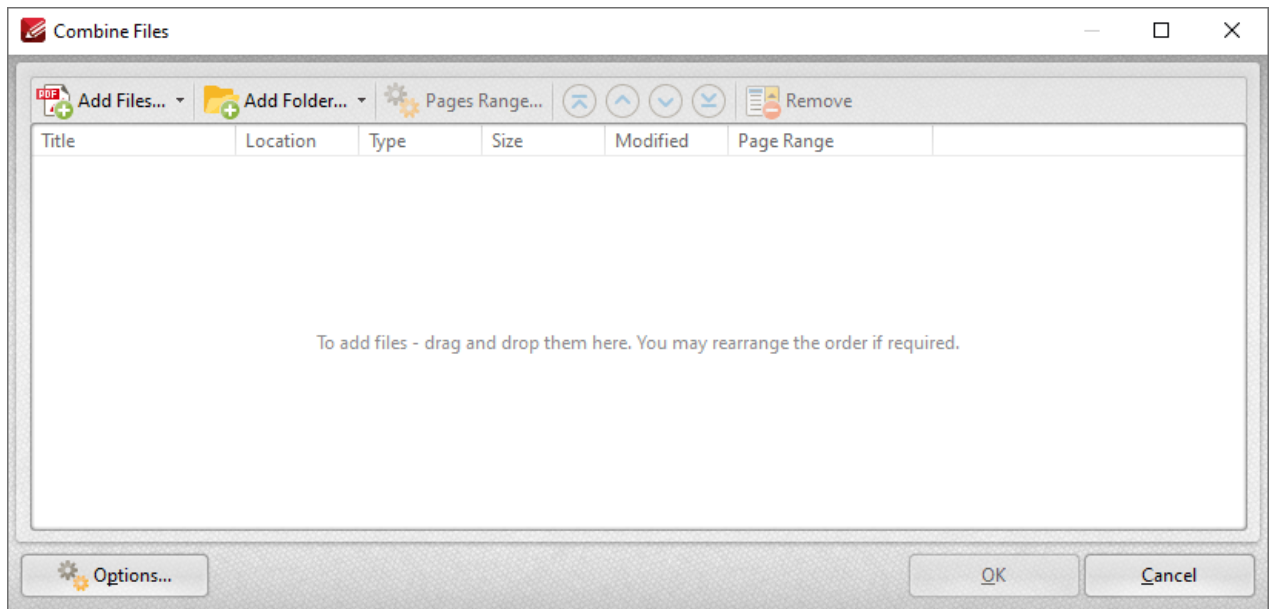

Figure 2. Combine Files Dialog Box

- Click **Add Files** to select files from the local computer to add to the list of source files. Click the dropdown arrow for additional options:
  - Click **Add All Opened Documents in Opened Order** to add all open documents in the order in which they were opened.
  - Click **Add All Opened Documents in the Current Tab Order** to add all open documents in their current order in the document tab.
- Click **Add Folder** to add entire folders to the list of source files. Click the arrow adjacent to the button to determine further options. The **Add Files From Folder Options** dialog box will open. This is detailed in **(figure 3)**.
- Click **Page Range** to determine the page range of selected documents. Page range settings are explained [here](#).
- Use the arrow icons to reorder selected documents in the list. This determines the order in which they appear in the new document.
- Click **Options** to determine the actions taken with objects contained within combined files. The **Options** dialog box will open. The available actions relate to comments, form fields and bookmarks. Select the **Add root bookmark with file name** box as desired.



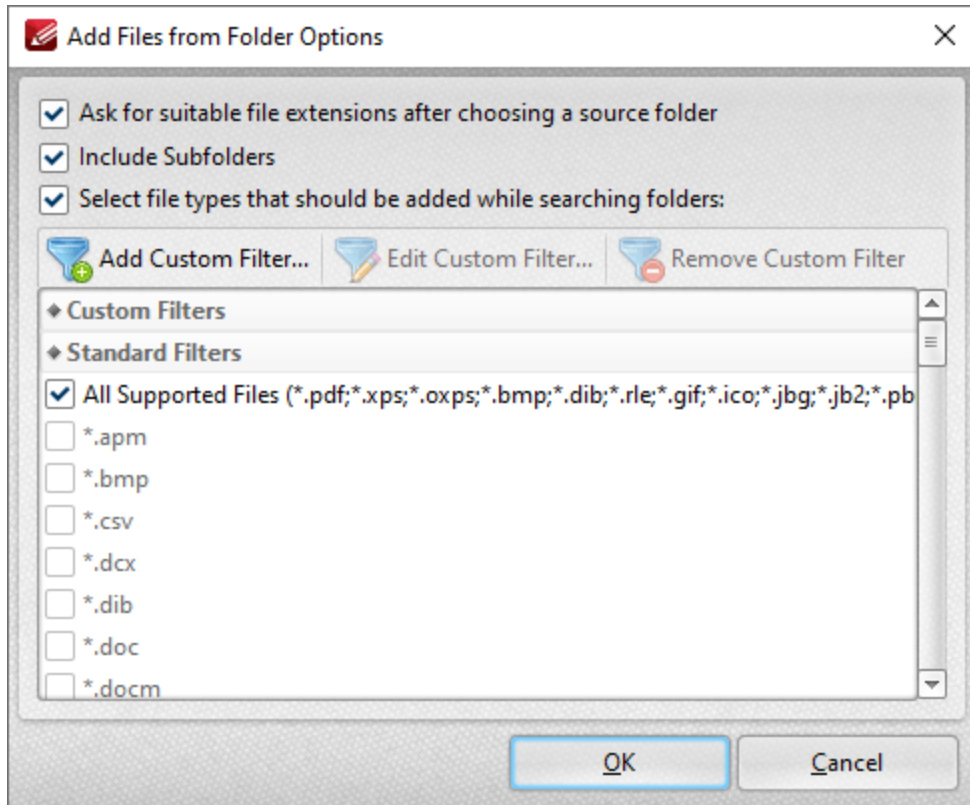

Figure 3. Add Files From Folder Options Dialog Box

- Select the **Ask for suitable file extensions after choosing a source folder** box to launch this dialog box when folders are selected using the **Add Folder** button.
- Select the **Include Subfolders** box to include subfolders of the parent folder when the software searches for files to add to the list of source files.
- Select the **Select file types which should be added while searching folders** box to determine file types to be included when the software performs a search.
- Custom filters can be added using the **Add Custom Filter** option. This facilitates the creation of custom profiles for subsequent use that search for specific file extensions. Click **Add Custom Filter** to open the **Add Custom Filter** dialog box:

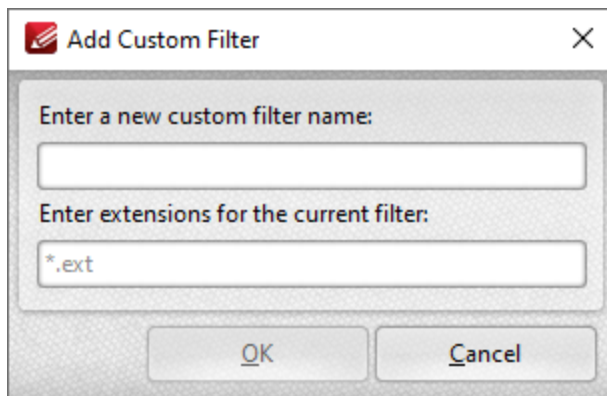

Figure 4. Add Custom Filter Dialog Box

- Enter a name for the custom filter.
  - Enter the desired file extensions. File extensions must begin with an asterisk and a period, for example: **\*.apm**, **\*.bmp**.
  - When the desired details have been entered, click **OK** to save the custom filter.
-

### 10.4.1.3.3 PDF Portfolio



## PDF Portfolio

PDF portfolio files are a unique format of PDF file in which multiple files are assembled into an integrated PDF unit for convenience of use. Click **PDF Portfolio** to create a PDF portfolio file:

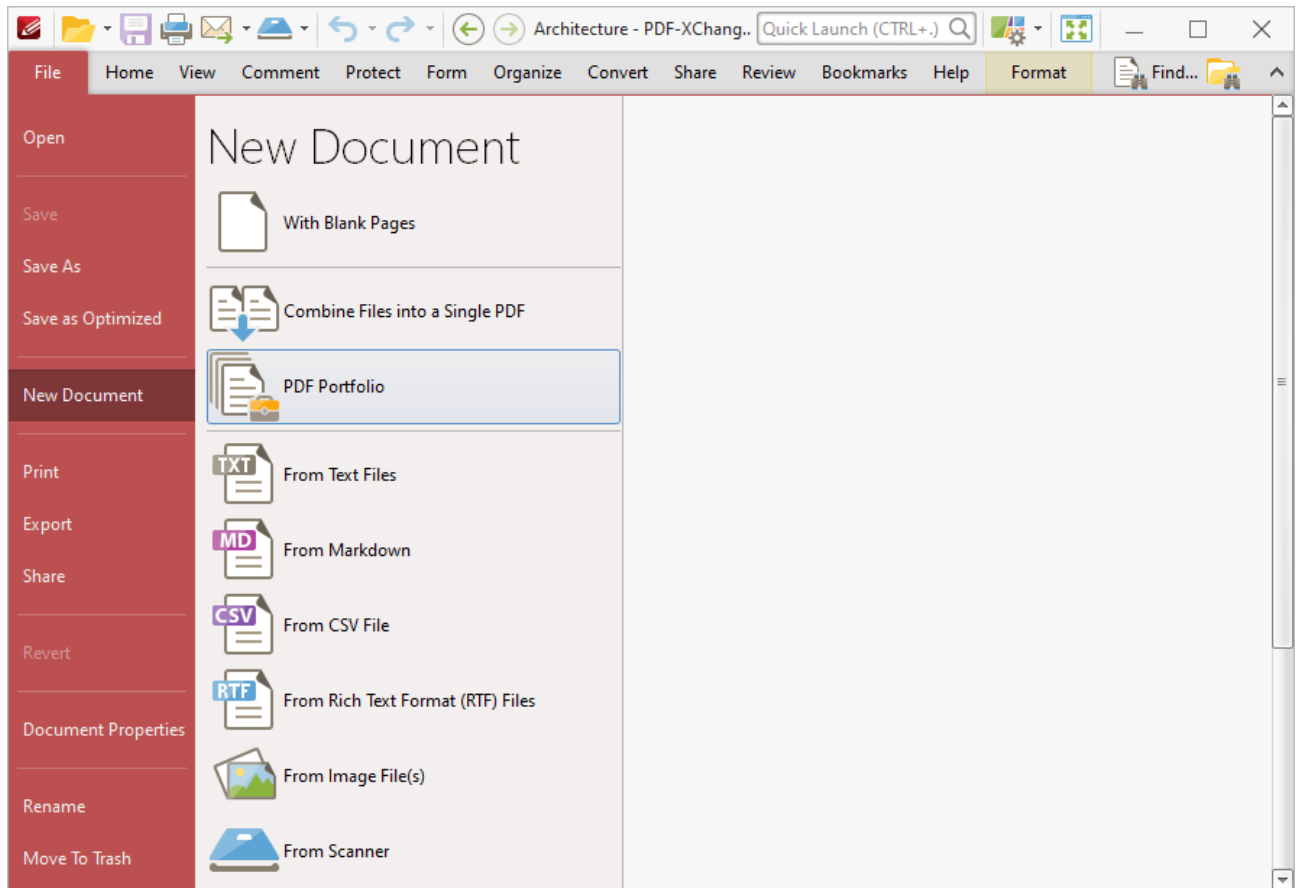
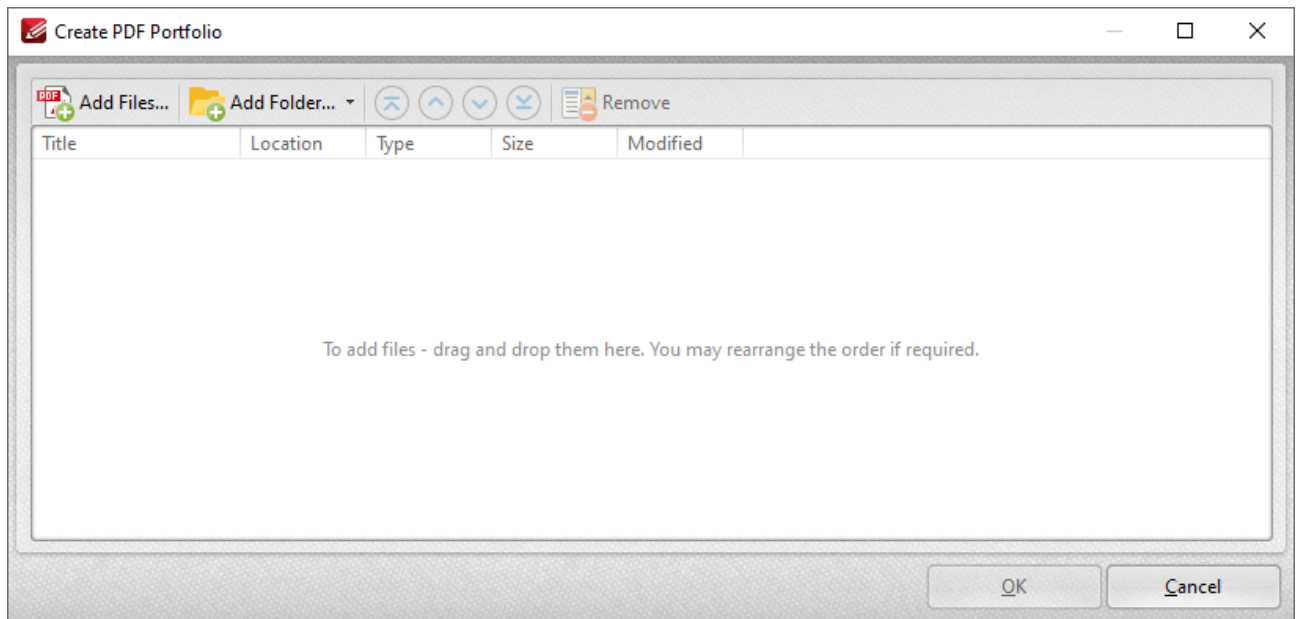

Figure 1. File Tab Submenu, New Document Options, PDF Portfolio

The **Create PDF Portfolio** dialog box will open:



**Figure 2.** Create PDF Portfolio Dialog Box

- Click **Add Files** to select files from the local computer to add to the portfolio file. Click the dropdown arrow for additional options:
  - Click **Add All Opened Documents in Opened Order** to add all open documents in the order in which they were opened.
  - Click **Add All Opened Documents in the Current Tab Order** to add all open documents in their current order in the document tab.
- Click **Add Folder** to add entire folders to the list of source files used to create the portfolio file. Click the arrow adjacent to the button to determine further options. The **Add Files From Folder Options** dialog box will open. This is detailed in *(figure 3)*.
- Use the arrow icons to reorder selected documents in the list. This determines the order in which they appear in the portfolio file.

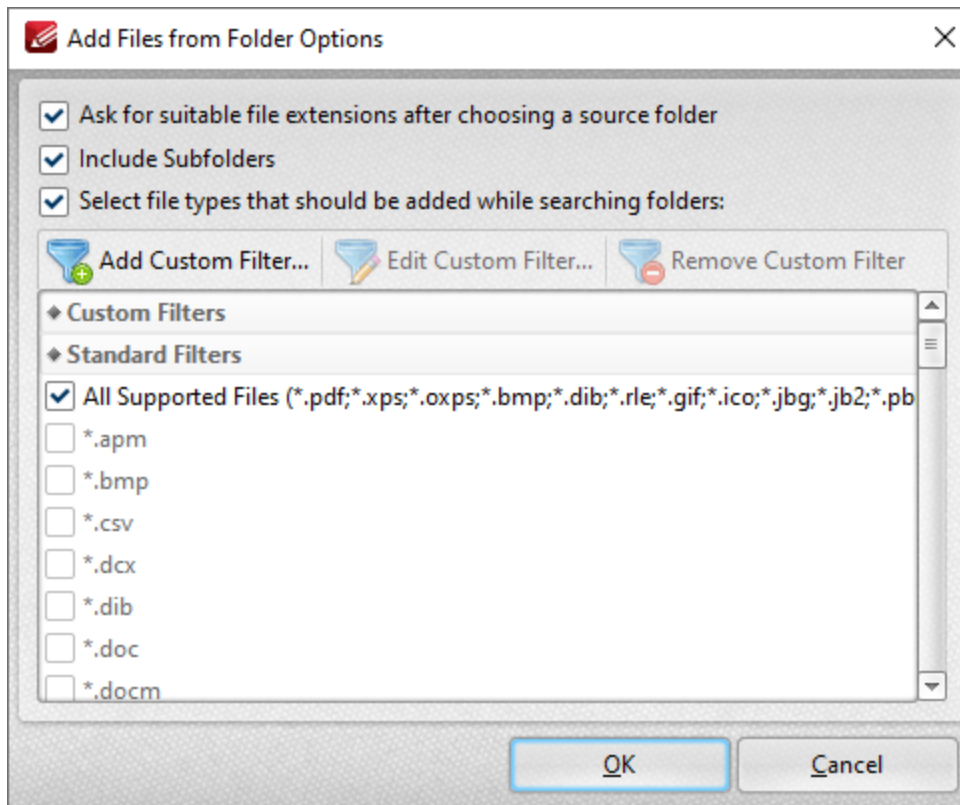

Figure 3. Add Files From Folder Options Dialog Box

- Select the **Ask for suitable file extensions after choosing a source folder** box to launch this dialog box when folders are selected using the **Add Folder** button.
- Select the **Include Subfolders** box to include subfolders of the parent folder when the software searches for files to add to the list of source files.
- Select the **Select file types which should be added while searching folders** box to determine file types to be included when the software performs a search.
- Custom filters can be added using the **Add Custom Filter** option. This facilitates the creation of custom profiles for subsequent use that search for specific file extensions. Click **Add Custom Filter** to open the **Add Custom Filter** dialog box:

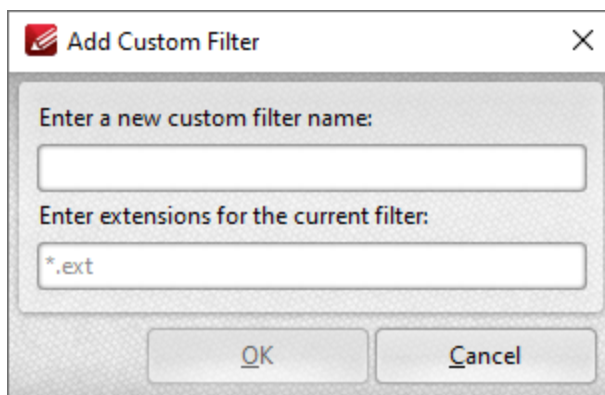

Figure 4. Add Custom Filter Dialog Box

- Enter a name for the custom filter.
  - Enter the desired file extensions. File extensions must begin with an asterisk and a period, for example: **\*.apm**, **\*.bmp**.
  - When the desired details have been entered, click **OK** to save the custom filter.
-

## 10.4.1.3.4 From Text Files



### From Text Files

Click **From Text Files** to convert text files into PDF:

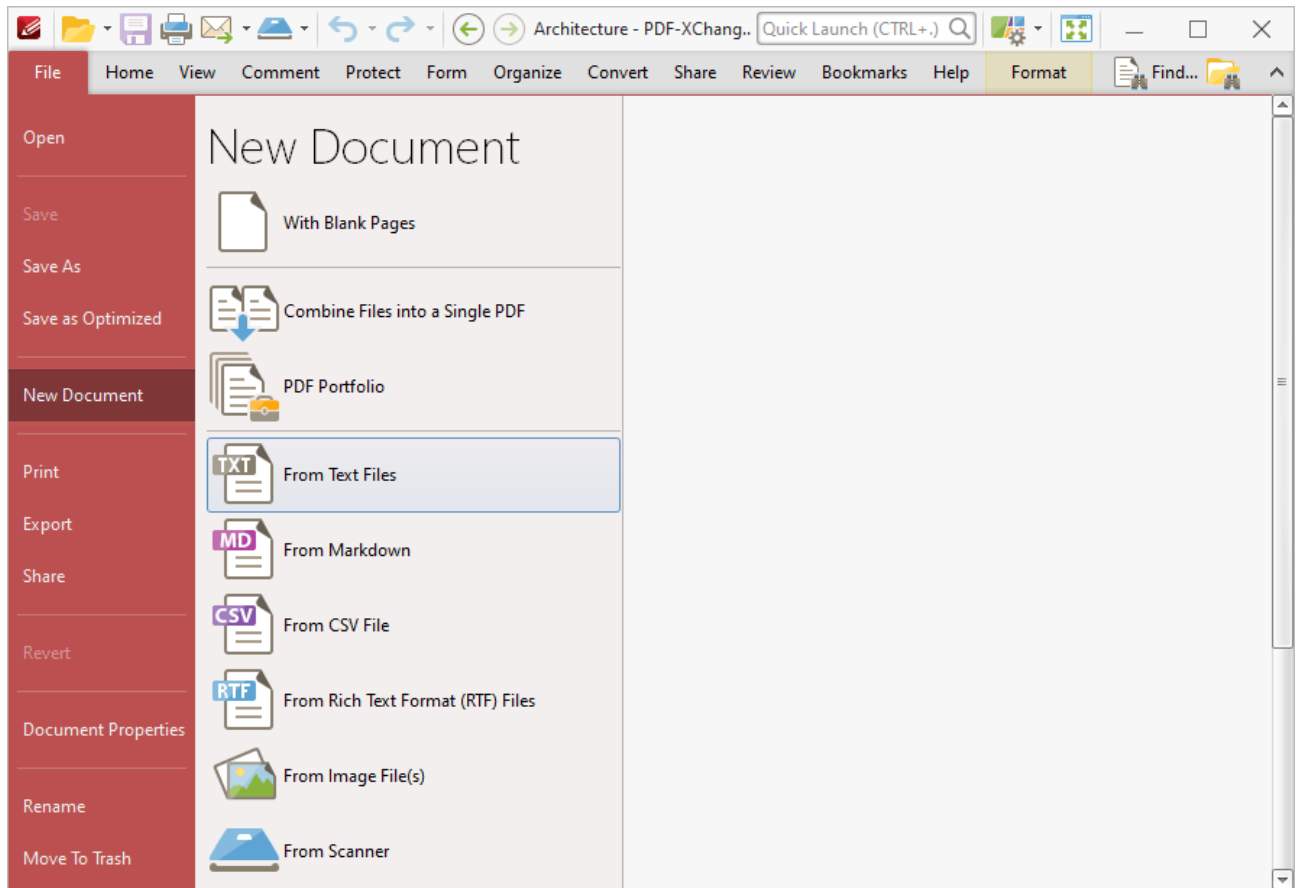

Figure 1. File Tab Submenu, New Document Options, From Text Files

The **Convert Text Files to PDF** dialog box will open:

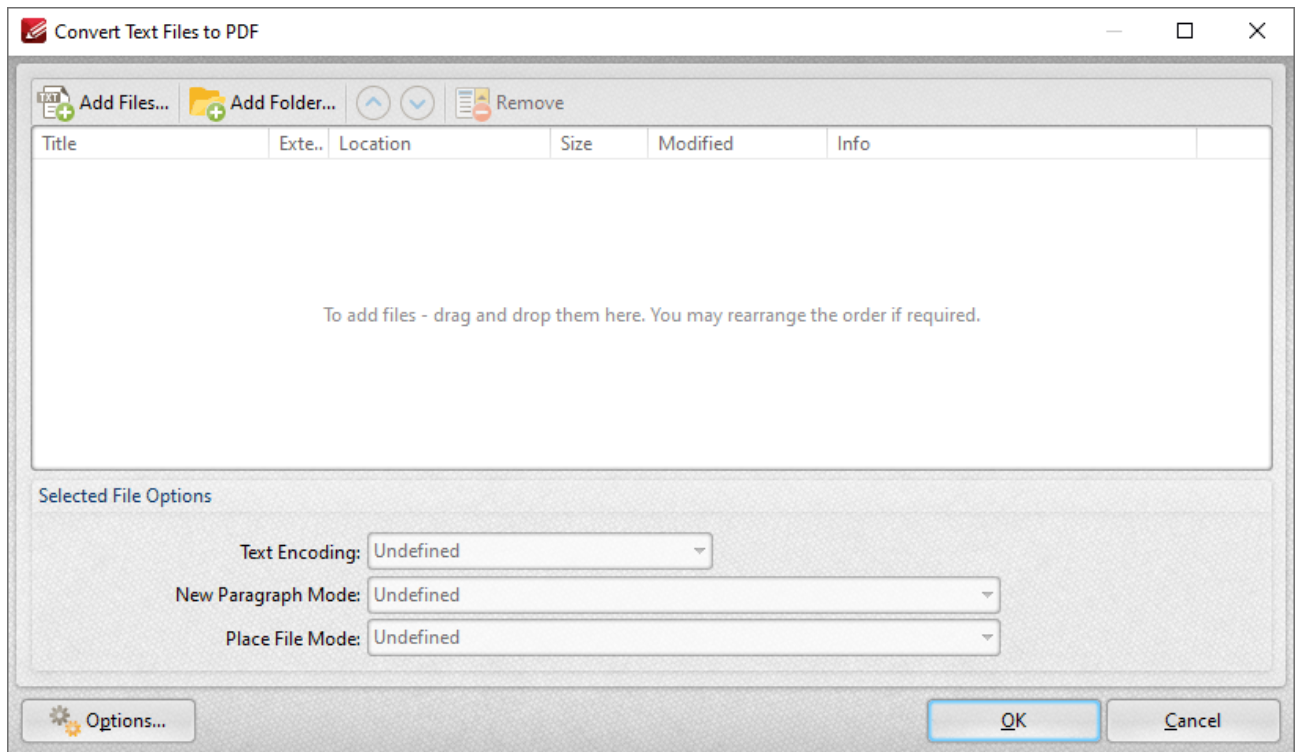

Figure 2. Convert Text Files to PDF Dialog Box

The options in this section are the same as those outlined in the [Combine Files into a Single PDF](#) section, with the difference that files must be in plain text (\*.txt) format. There are also additional options in the **Selected File Options** section:

- **Text Encoding** sets the text encoding format. This determines the representation of language-specific characters within imported files.
- **New Paragraph Mode** defines when new paragraphs are started. There are four options:
  - **Auto Detect** is the default setting. The software will detect automatically when new paragraphs begin.
  - **Each newline character starts a new paragraph.** (A newline is a special character in computing that signifies the end of a line of text).
  - **Double newline character starts a new paragraph, singles ignored.**
  - **Double newline character starts a new paragraph, singles converted into space.**
- **Place File Mode** determines what happens with each file as it is placed in the combined document. There are two options:
  - **Start each file from a new paragraph.**
  - **Start each file from a new page.**
- Click **Options** to view/edit further options:



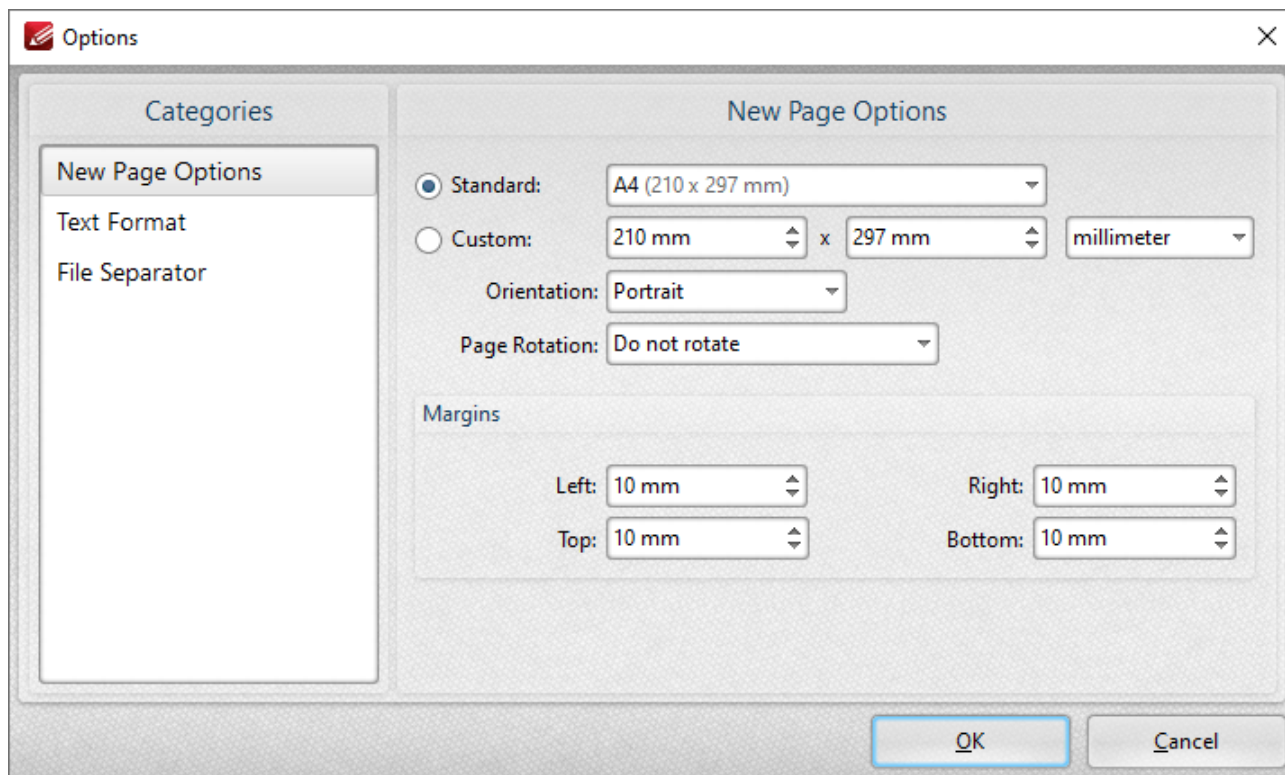

Figure 3. Options Dialog Box

## New Page Options

- The **Standard** option centers the original files in a new PDF of standard size. 'Standard' refers to common sizes such as those used by the **ISO** and **ANSI**.
- The **Custom** option allows the user to enter custom dimensions.
- The **Orientation** option has the settings **Portrait** or **Landscape** as the page orientation.
- The **Page Rotation** option rotates images as required during conversion.
- The **Margins** options facilitate the customization of the image margins. Enter the values desired into the number boxes. The new PDF will feature these dimensions.

## Text Format

When this option is selected, the following dialog box will open:

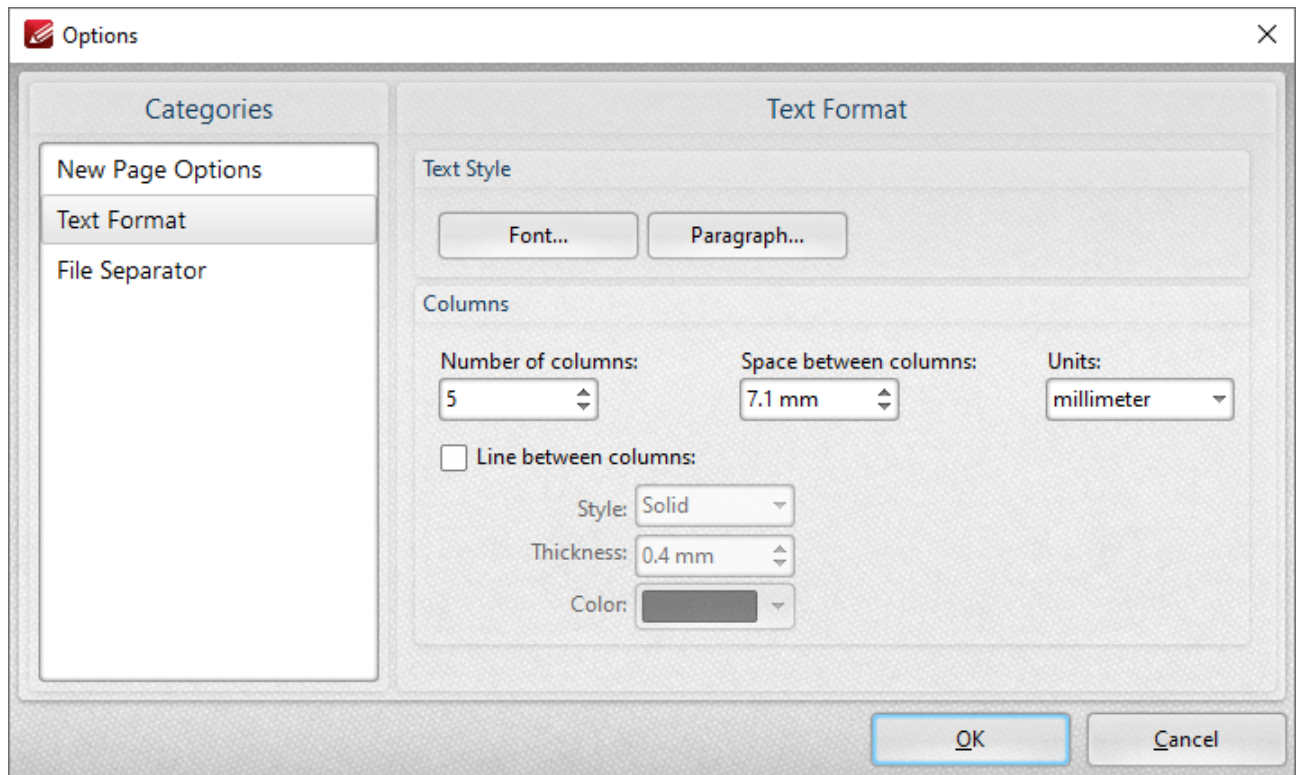

Figure 4. Text Format Options

- The **Font** and **Paragraph** buttons determine the font and paragraph settings of the text.
- The **Columns** options determine the number of columns of text, spaces between columns and unit of measurement for the spaces.
- Select the **Line between columns** box to insert lines between the columns of text. The **Style**, **Thickness** and **Color** settings determine the parameters of the lines.

## File Separator

The **File Separator** inserts a label that shows a divide between files after they have been combined into one document. When the **File Separator** option is selected, the following dialog box opens:

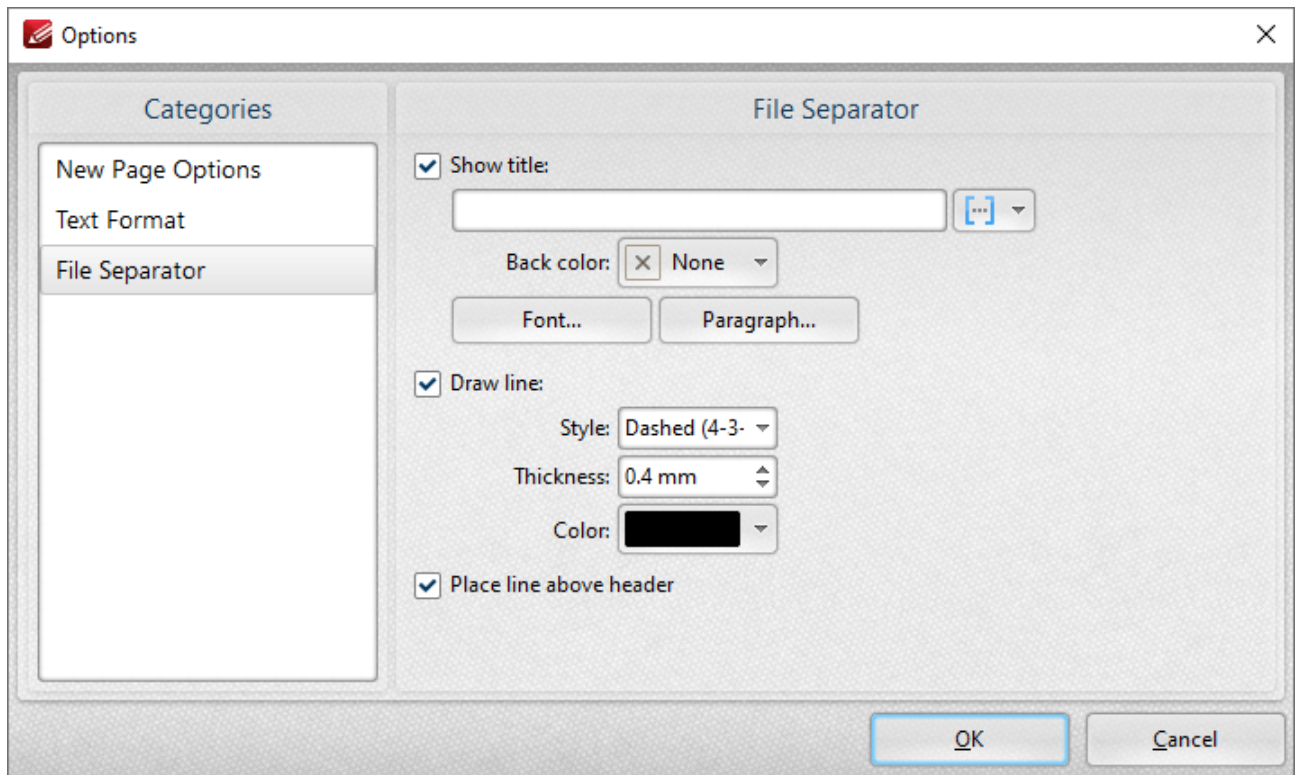

Figure 5. File Separator Options

- Select the **Show title** box to give the file separator a title. Click the icon to add [macros](#).
- The **Back color** option determines the color of the file separator.
- The **Font** and **Paragraph** settings determine the font style and paragraph layout of the file separator.
- Select the **Draw line** box to add a line to the file separator. Use the menus to determine **Style**, **Thickness** and **Color** options.
- Select the **Place line above header** box to position the line above the header of the document.

Click **OK** to save settings.

---

## 10.4.1.3.5 From Markdown



### From Markdown

Click **From Markdown** to convert Markdown files into PDF:

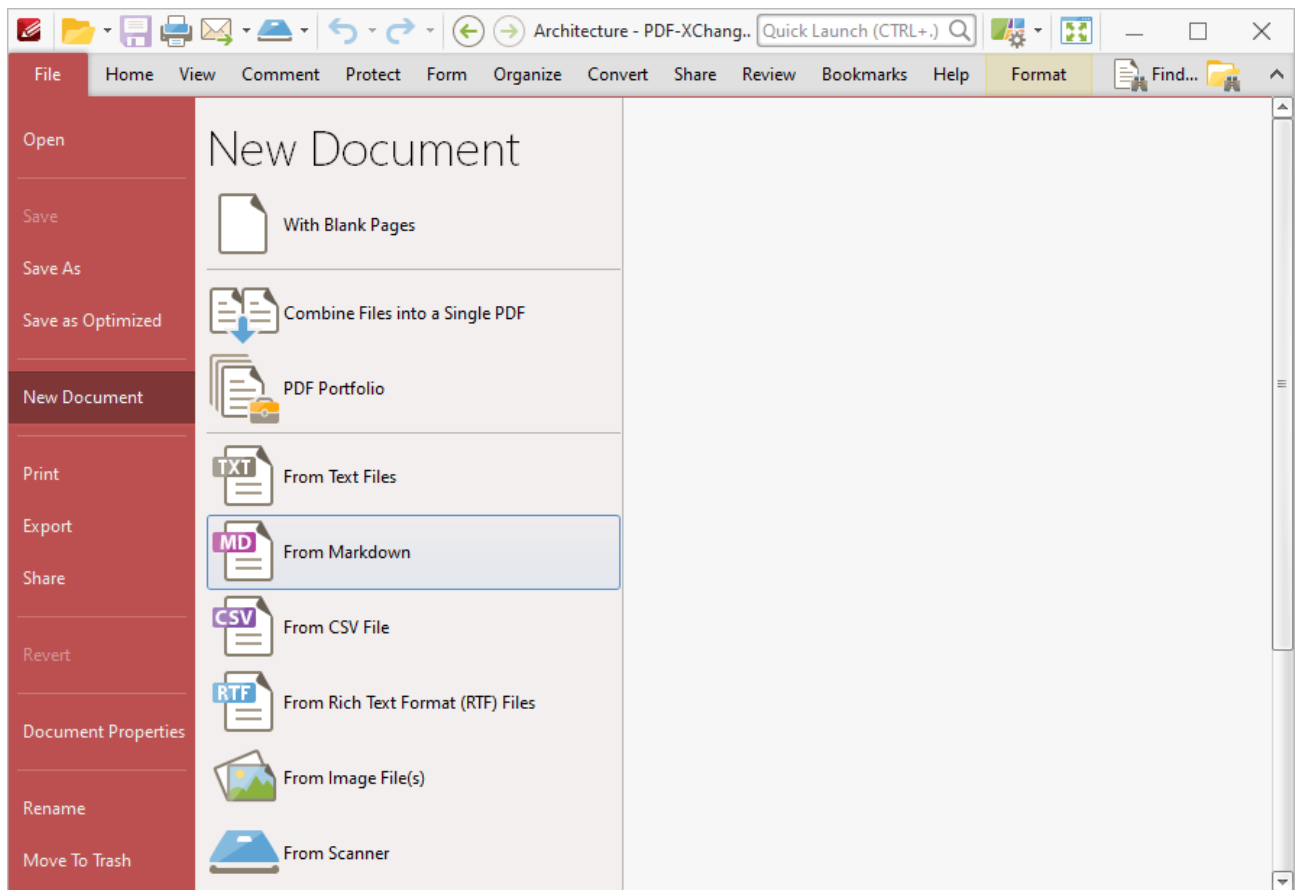
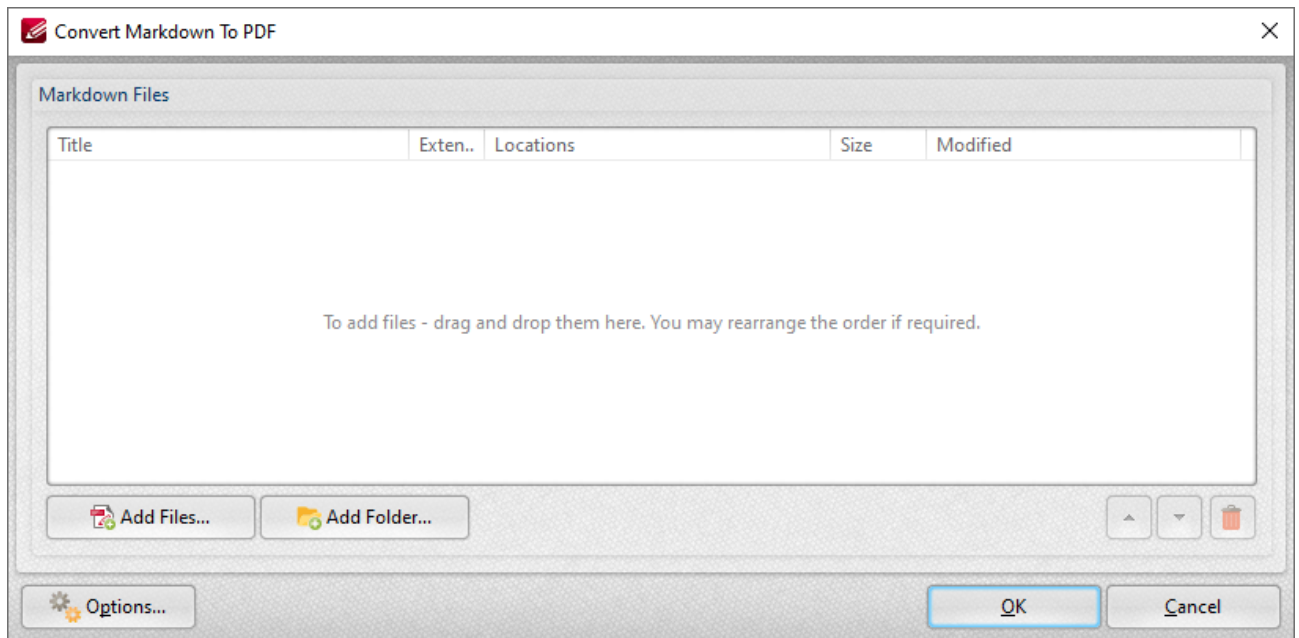

Figure 1. File Tab Submenu, New Document Options, From Markdown

The **Convert Markdown to PDF** dialog box will open:



**Figure 2.** Convert Markdown to PDF Dialog Box

- Click **Add Files** to select files from the local computer to add to the list of source files. Click the dropdown arrow for additional options:
- Click **Add Folder** to add entire folders to the list of source files.
- Use the arrow icons to reorder selected documents in the list. This determines the order in which they appear in the new document.
- Click **Options** to determine conversion options. The **Markdown to PDF** dialog box will open:

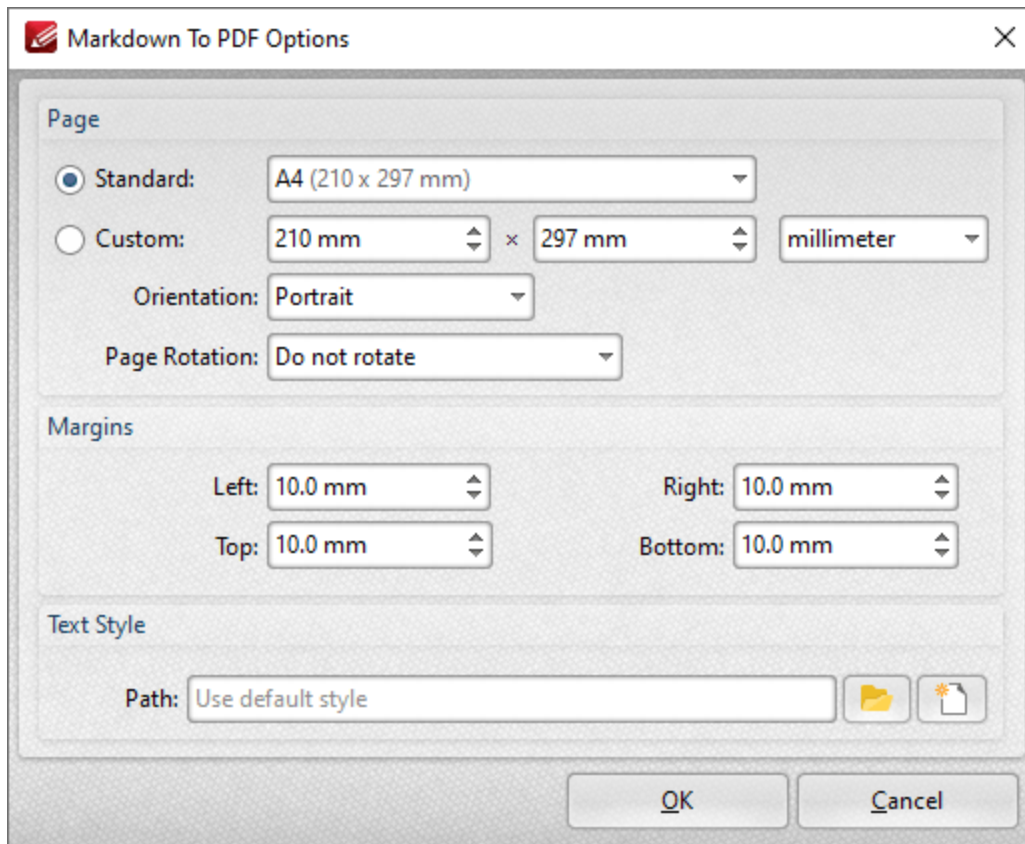

Figure 3. Markdown to PDF Dialog Box

- Use the **Standard** dropdown menu to set a standard document size for the dimensions of the new document.
- Click the **Custom** button to set a custom document size for the dimensions of the new document, then use the number boxes and the units of measurement dropdown menu to determine the dimensions.
- Use the **Orientation** and **Page Rotation** dropdown menus to set the orientation and page rotation of the new document.
- Use the **Margins** dropdown menus to determine the margins of the new document.
- Use the **Path** text box to determine the text style/presentation of the new document. Note that it is necessary to use a (\*.css) file to determine these options. Further information about this file format is available [here](#).

### 10.4.1.3.6 From CSV File



## From CSV File

Click **From CSV File** to convert CSV (comma separated values) files into PDF:

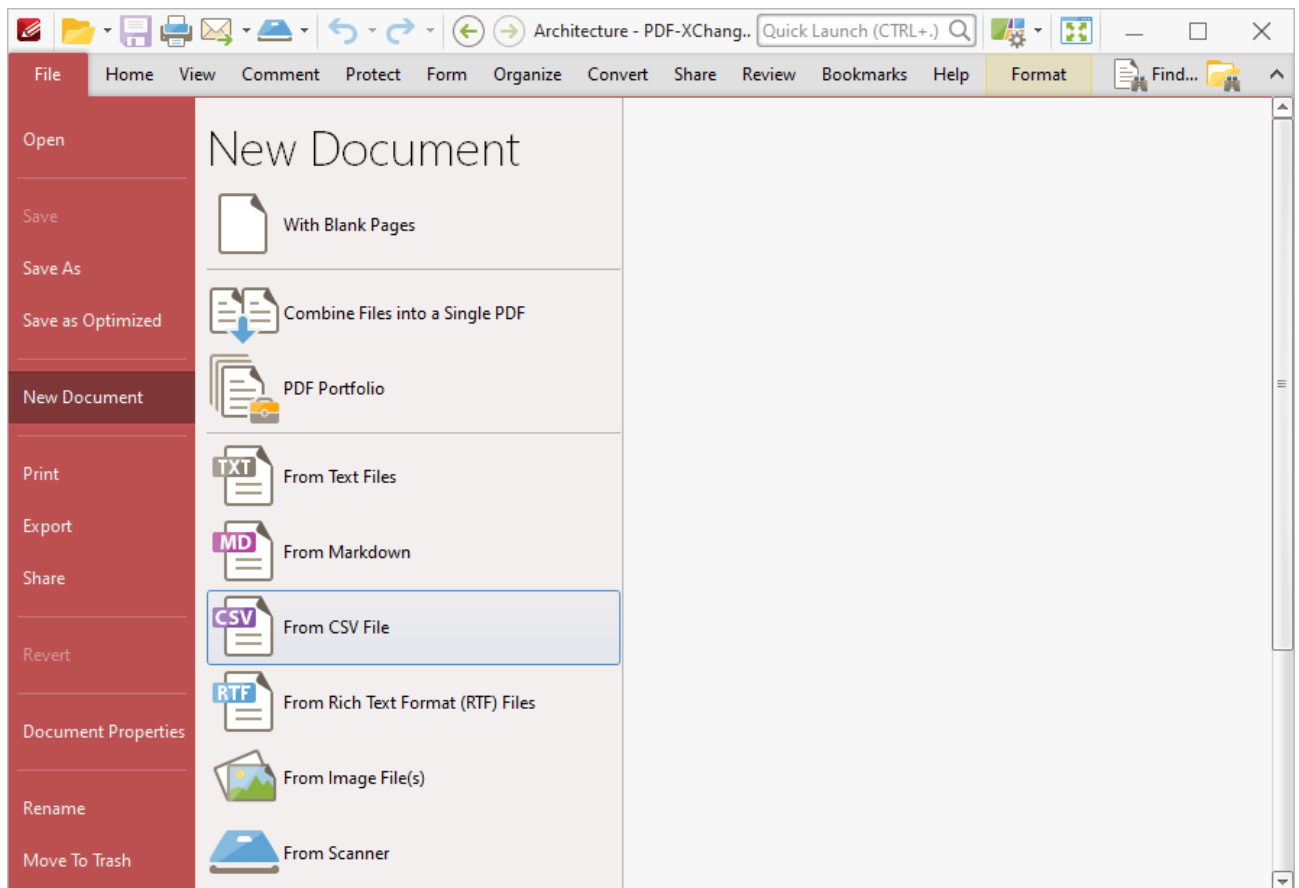

**Figure 1.** File Tab Submenu, New Document Options, From CSV File

The **Open Files** dialog box will open. Select the desired file and click **Open** to convert the file to PDF.

## 10.4.1.3.7 From Rich Text Format (RTF) Files



### From Rich Text Format (RTF) Files

Click **From Rich Text Format (RTF) Files** to convert RTF files into PDF:

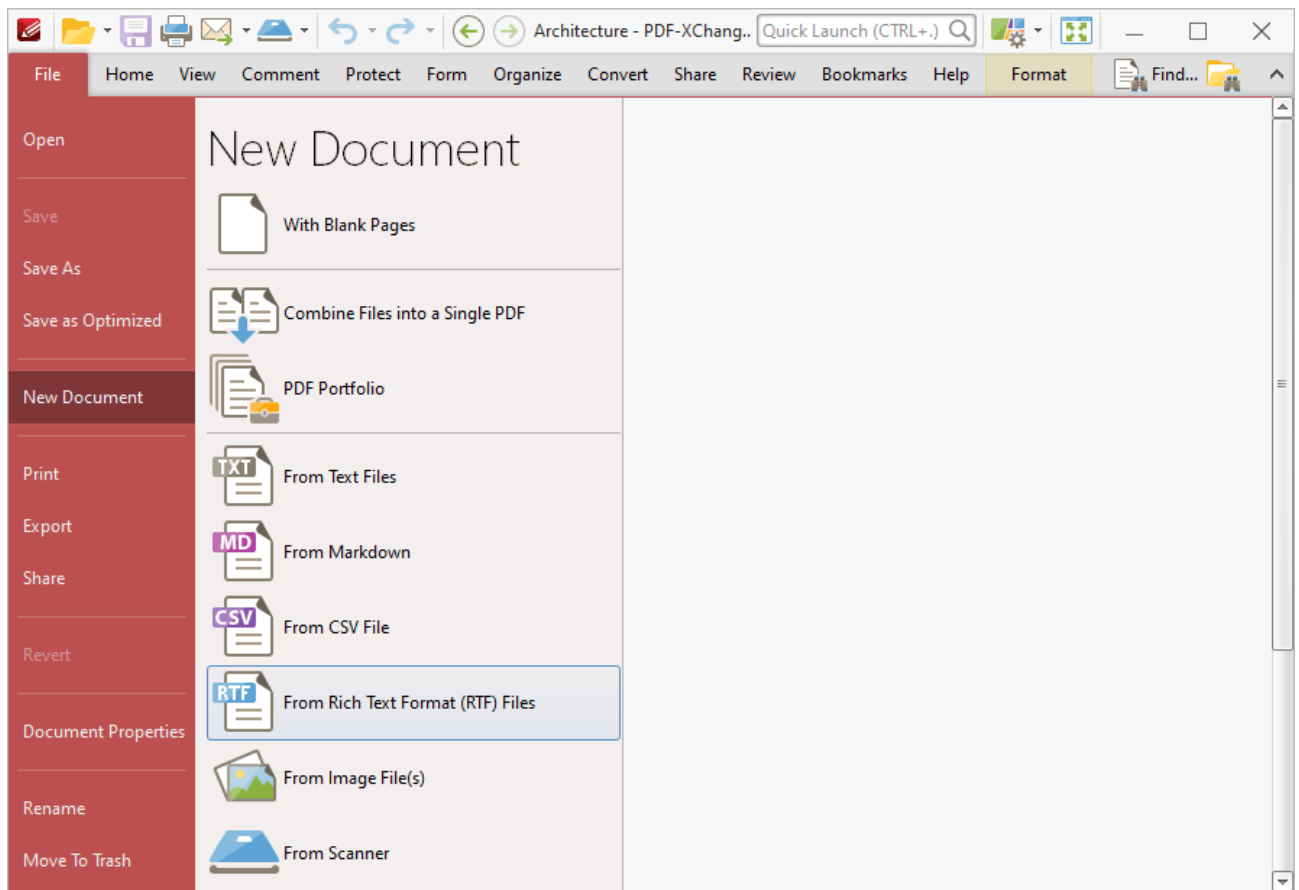

**Figure 1.** File Tab Submenu, New Document Options, From Rich Text Format (RTF) Files

The **Convert RTF Files to PDF** dialog box will open:



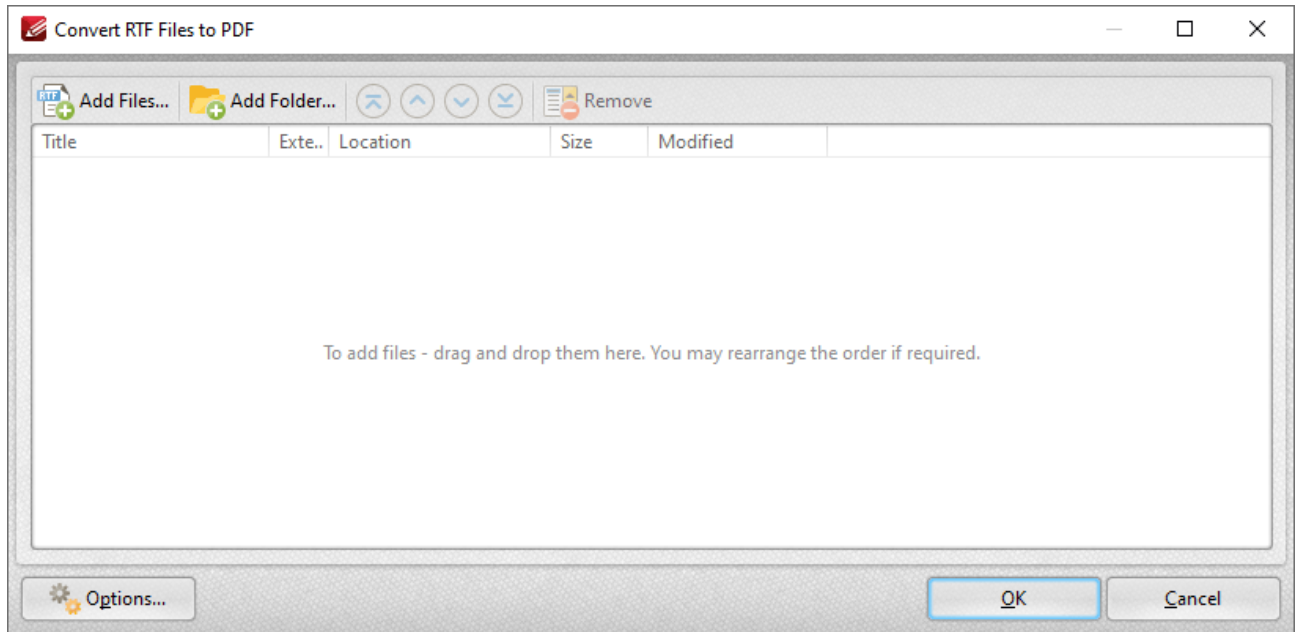

Figure 2. Convert RTF Files to PDF

The options are the same as those outlined in the [Combine Files into a Single PDF](#) section with the differences that files must be in **(\* .rtf)** format, and the available parameters are different in the **Options** dialog box:

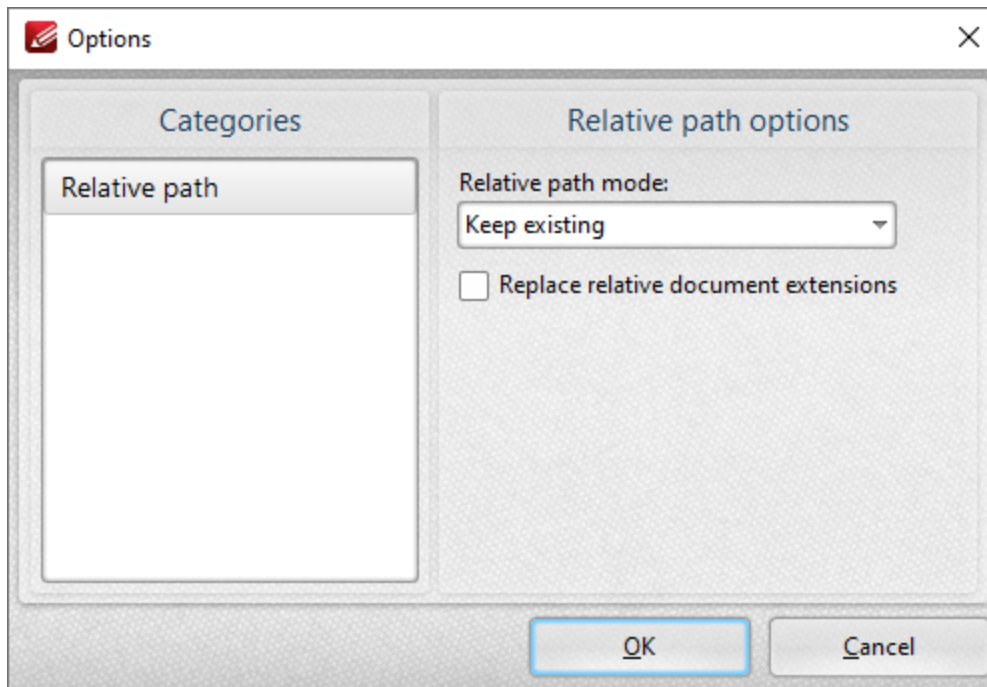

Figure 3. Convert RTF files to PDF Options

**Relative path** is the only option in the categories menu. There are four relative path options:

- **Keep existing** means relative paths remain as they are.
- **Make absolute** makes the relative paths absolute.
- **Make relative** makes the relative paths relative. (Absolute paths show the full name of the file/internet address in question. Relative paths are shorter and link to more specific locations).
- Select the **Replace relative documents extensions** box to create a PDF document from linked RTF files.

Click **OK** to save settings.

---

## 10.4.1.3.8 From Image File(s)



### From Image File(s)

Click **From Image Files** to convert image files into PDF:

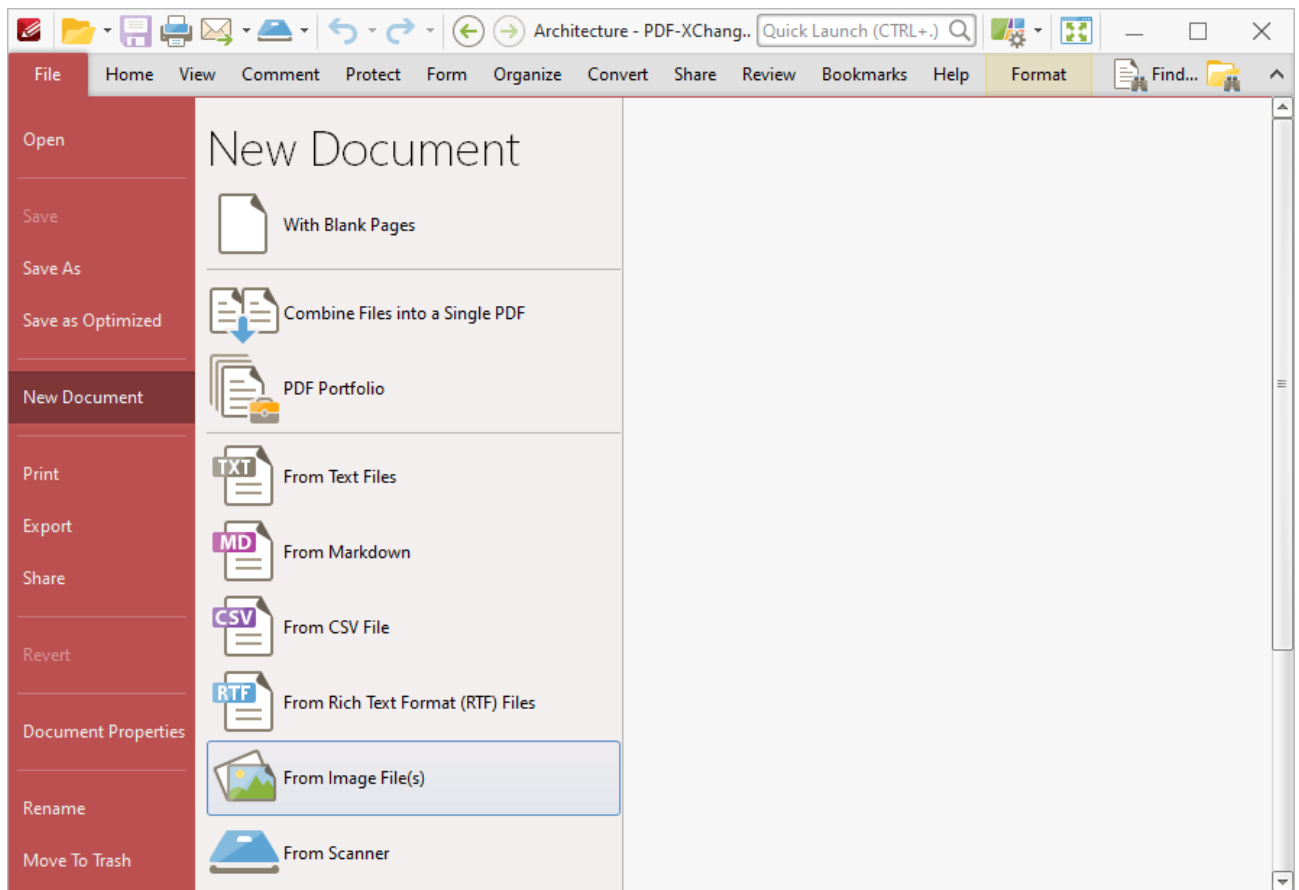

Figure 1. File Tab Submenu, New Document Options, From Image Files

The **Image to PDF** dialog box will open:

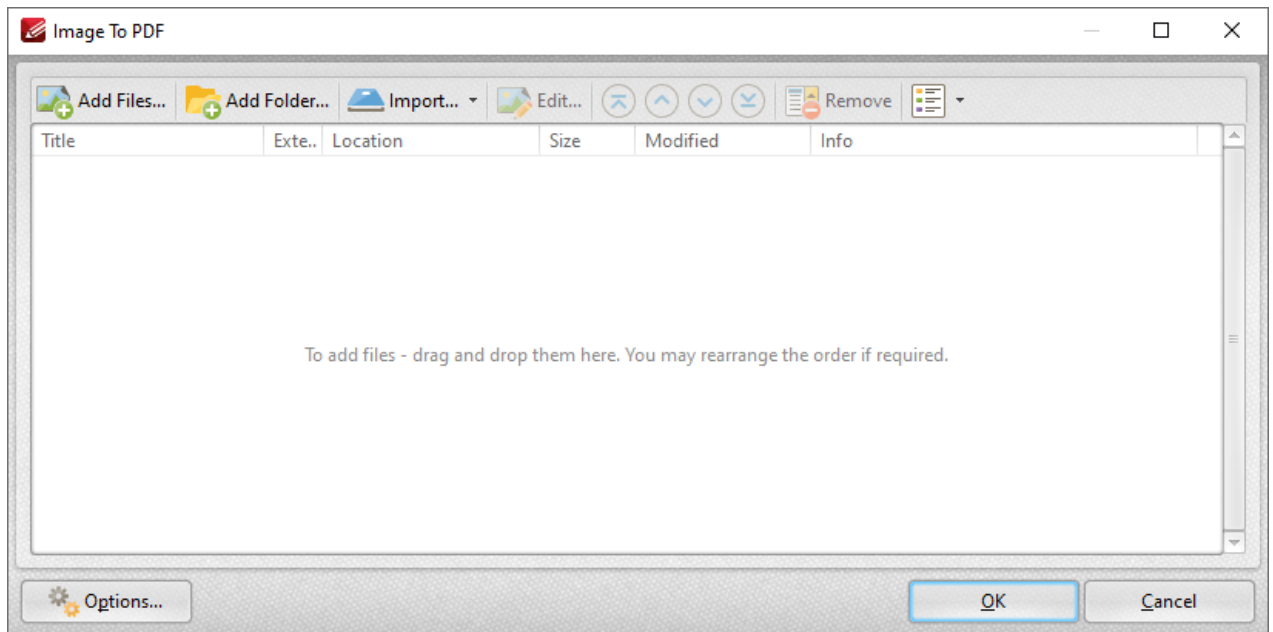

Figure 2. Images to PDF Dialog Box

- The **Add Files** and **Add Folder** options are the same as those outlined above in the [Combine Files into a Single PDF](#) section.
- Click **Import** to add images from the local scanner. The **Scan Properties** dialog box will open. Select the desired parameters as detailed [here](#) and click **Scan** to import images.
- Select an image from the **Source image files** list and click **Edit** to edit it before it is combined with the other documents.
- Click the arrow icons to move images up or down within the list. Click the **Remove** icon to remove selected images from the list. The format in which files are shown within the list can be adjusted using the icon on the far right.
- Click **Options** for further options, as detailed below.
- Click **OK** to create the new document.

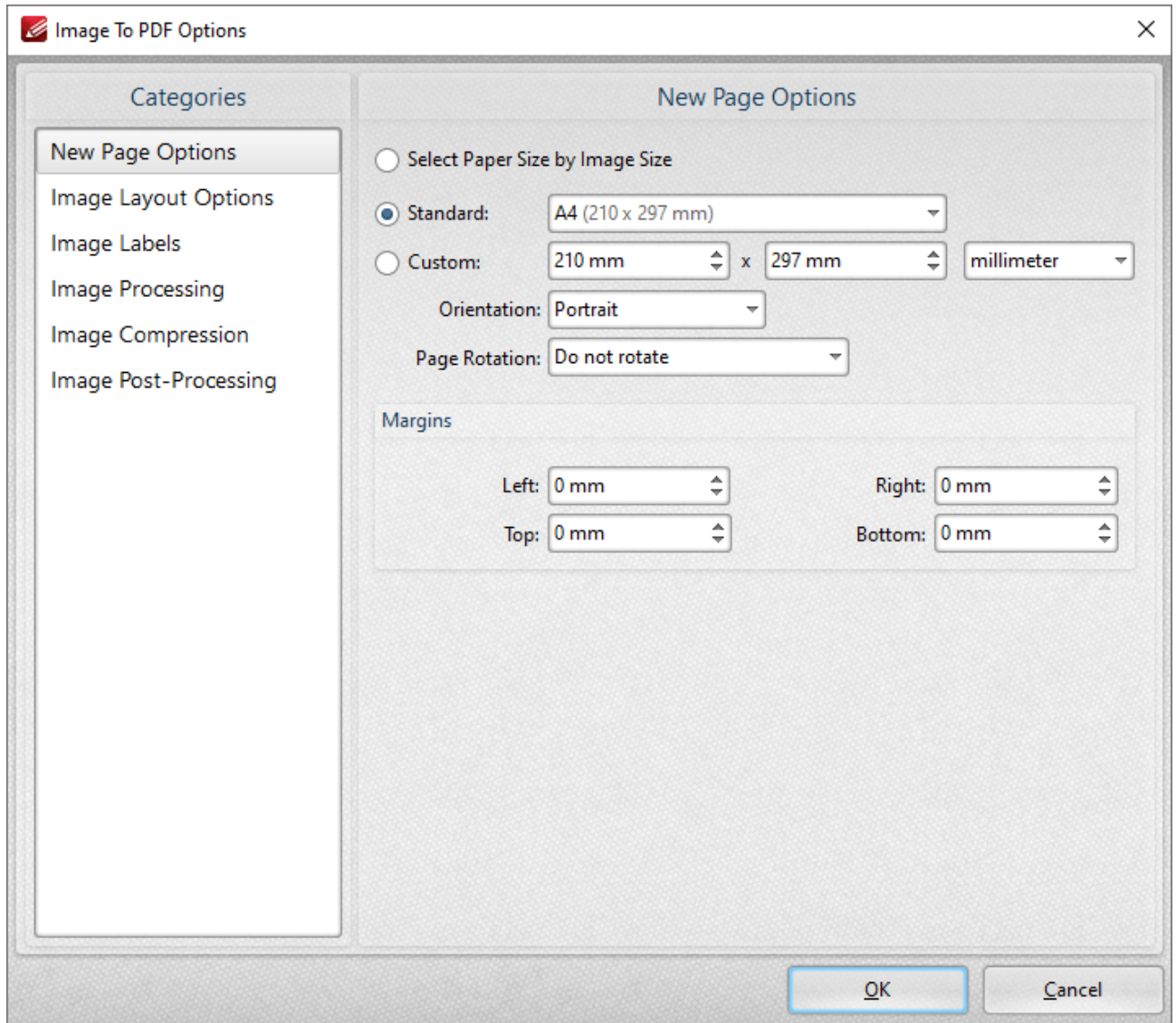

Figure 3. Images to PDF Options Dialog Box, New Page Options

## New Page Options

When this option is selected in the **Categories** menu, the dialog box detailed in **(figure 3)** opens. The options are as follows:

- The **Select Paper Size by Image Size** option crops new documents according to the image size converted. I.e. the borders of the original image define the borders of the new document.
- The **Standard** option centers the original file in a new document of standard size. 'Standard' refers to common sizes such as those used by the **ISO** and **ANSI**. Click the menu for a list of available sizes.
- The **Custom** option allows the user to enter custom dimensions. There is also a choice for portrait or landscape style (unless the **Choose Paper Size by Image Size** option is selected).

- The **Page Rotation** option rotates images as required during conversion. Click the menu for rotation options.
- The **Margins** option facilitates the customization of the image margins. Enter the values desired into the boxes. The new PDF will feature these dimensions.

Click **OK** to save settings.

## Images Layout Options

When this option is selected in the **Categories** menu the following options are available:

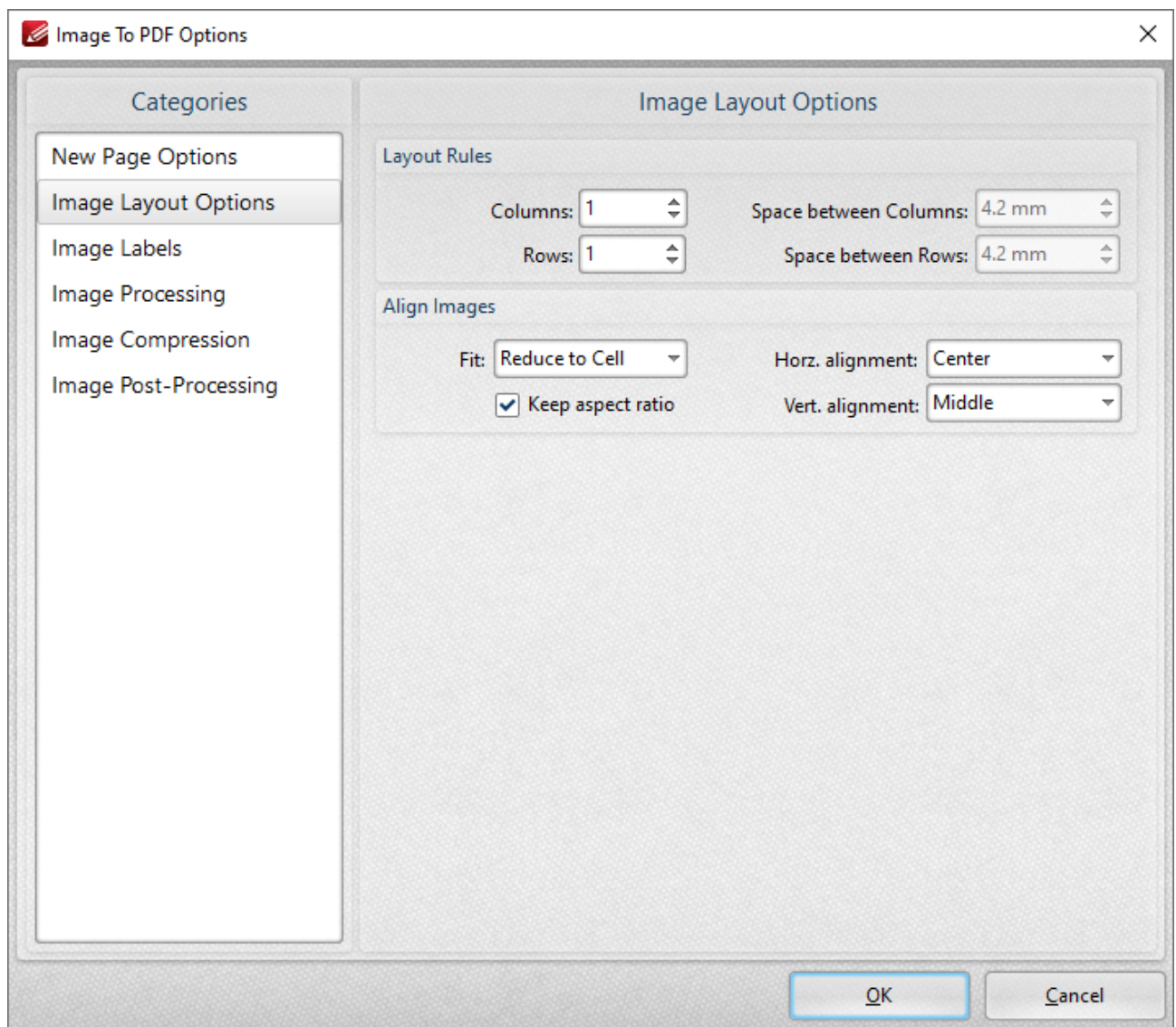

**Figure 4.** Images to PDF Options Dialog Box, Image Layout Options

- The **Layout Rules** options determine the layout of images within new documents. Enter the desired dimensions in the **Columns** and **Rows** number boxes. Use the **Space between**

**Columns** and **Space between Rows** boxes to determine the amount of empty space between columns and rows of images.

- **Align Images** determines the alignment of images within new documents. There are two options: **Reduce to Cell** and **Fit to Cell**. **Reduce to Cell** is the default setting. This reduces the size of the images to fit the size of the document. If the original images are smaller than the document then they will remain at their original size. The **Fit to Cell** setting fits the images to the size of the document. If the images are smaller than the document then they will be increased in size to match the size of the new document.
- The **Keep Aspect Ratio** box is selected by default. This means that images keep their original proportions and fit the specified PDF dimensions as far as possible within those proportions. Clear this box to disable the aspect ratio. Images will then match the PDF size exactly but may distort as a result (depending on the dimensions of the PDF document in relation to the dimensions of the original images).
- **Horizontal and Vertical Alignment** determines the location at which images in the new document appear.

Click **OK** to save settings.

## Image Labels

When this option is selected in the **Categories** menu the following options are available:

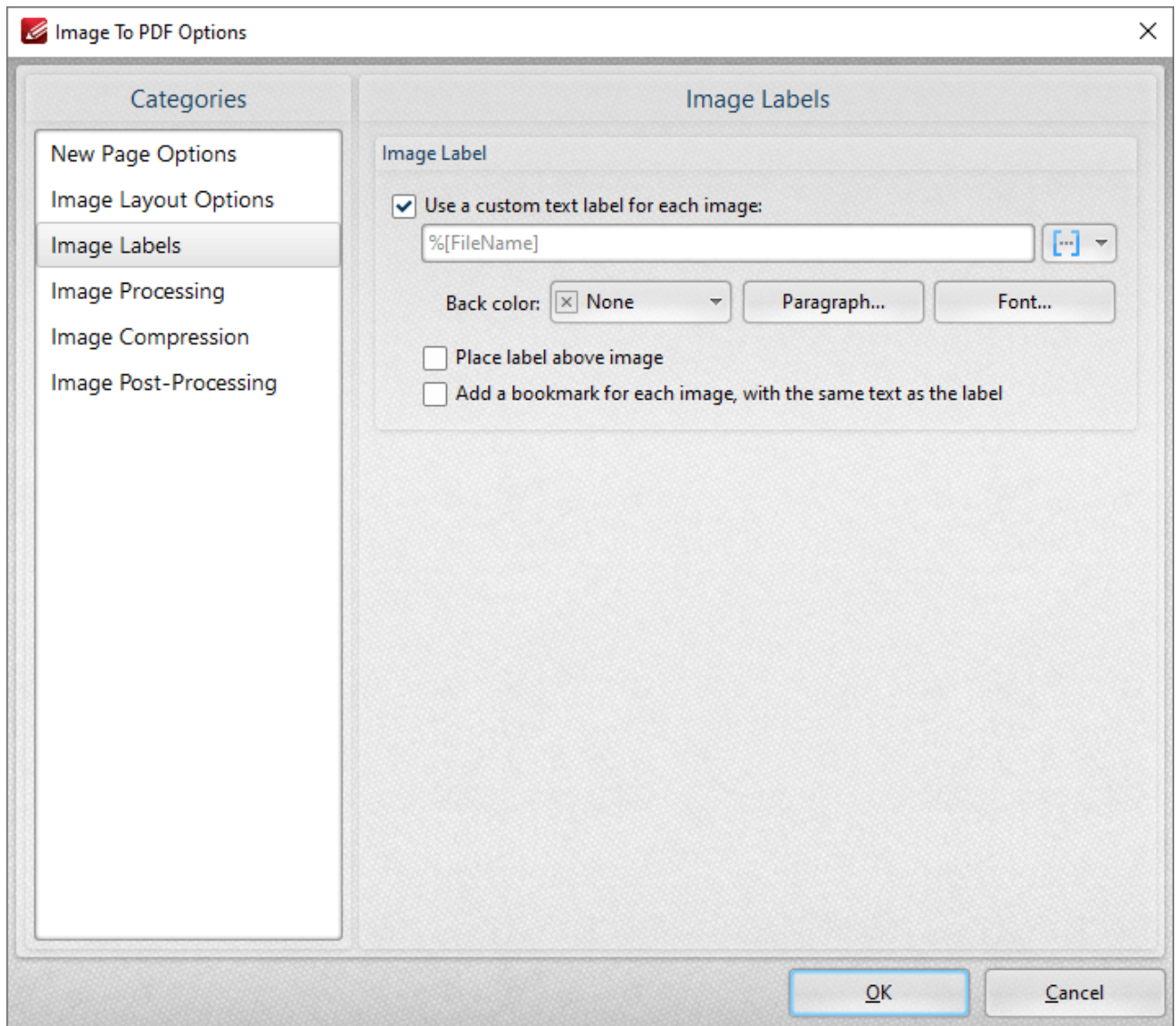

Figure 5. Images to PDF Options Dialog Box, Image Labels Options

- Select the **Use special text label for each image** box to enable further options.
- Enter the desired label text in the text box. Click the blue icon to utilize **Macros**<sup>1707</sup> as desired.
- **Back Color** determines the background color of the label. Click the box to open a menu of available colors.
- The **Paragraph** settings determine the alignment, indentation and spacing of the text on the label. Click **Paragraph** to adjust these settings. The indentation settings include two special options. Select the **First Line** option to indent the first line, as in a standard paragraph. The second special option is **Hanging** indentation, which means the first line is not indented but all subsequent lines are. When either of these settings are being used the **'By'** box must be adjusted accordingly.
- Click **Font** to determine the font used for the label. The dialog box in detailed in **(figure 6)** will open.
- If the **Place label above image** box is not selected then the label will appear below the image.



- Select the **Add bookmark for each image with the same text as label** as desired. Further information about bookmarks is available [here](#).

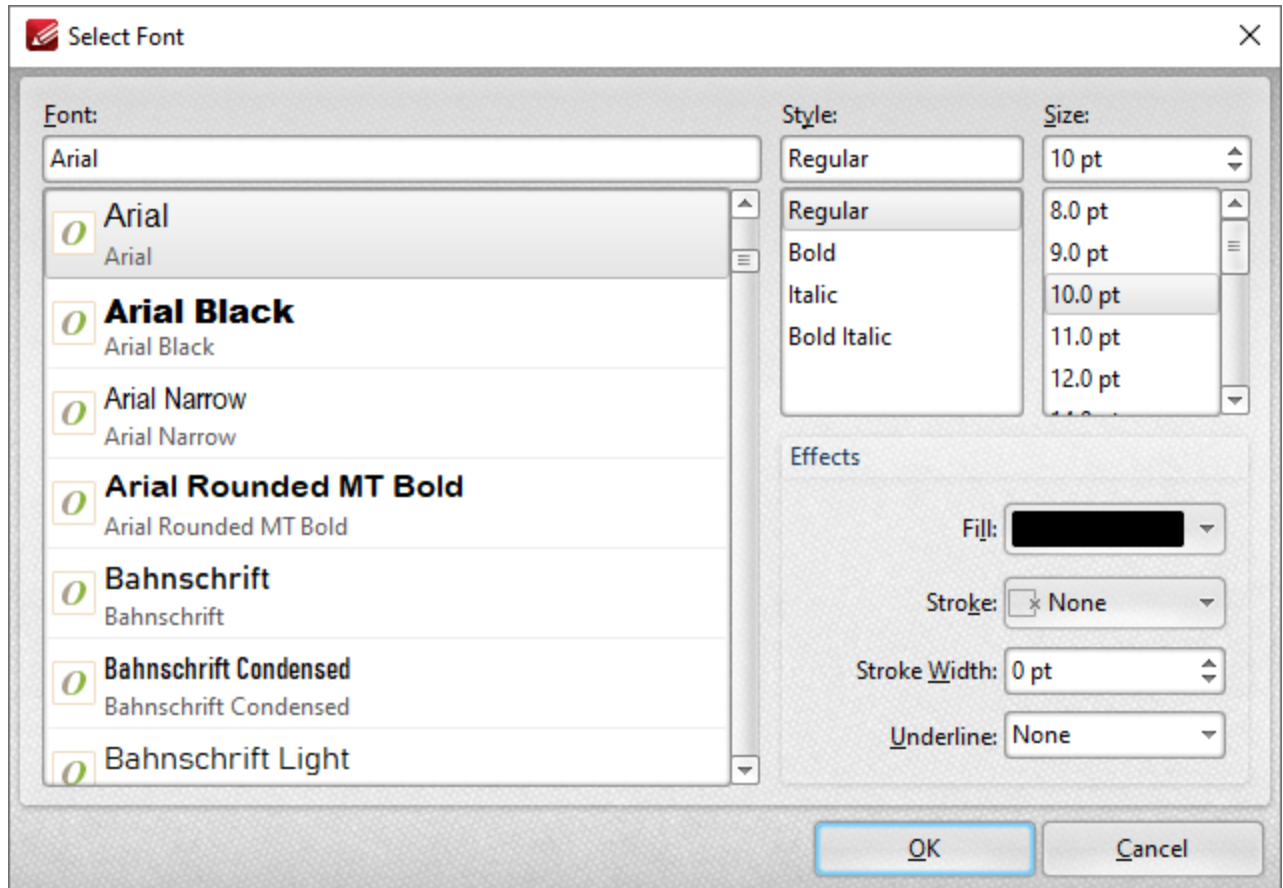

Figure 6. Select Font Dialog Box

- Use the **Font** text box to enter the name of the desired font, or select one from the options listed below the text box.
- Use the **Style** menu to determine the style of the font.
- Use the **Size** menu to determine the size of the font.
- Use the **Fill** menu to determine the color of the font.
- Use the **Stroke** menu to determine the color of the stroke. This color will border the text.
- Use the **Stroke width** menu to determine the size of the stroke.
- Use the **Underline** menu to enable/disable font underline.

Click **OK** to save settings.

## Image Processing

When this option is selected in the **Categories** menu the following options are available:

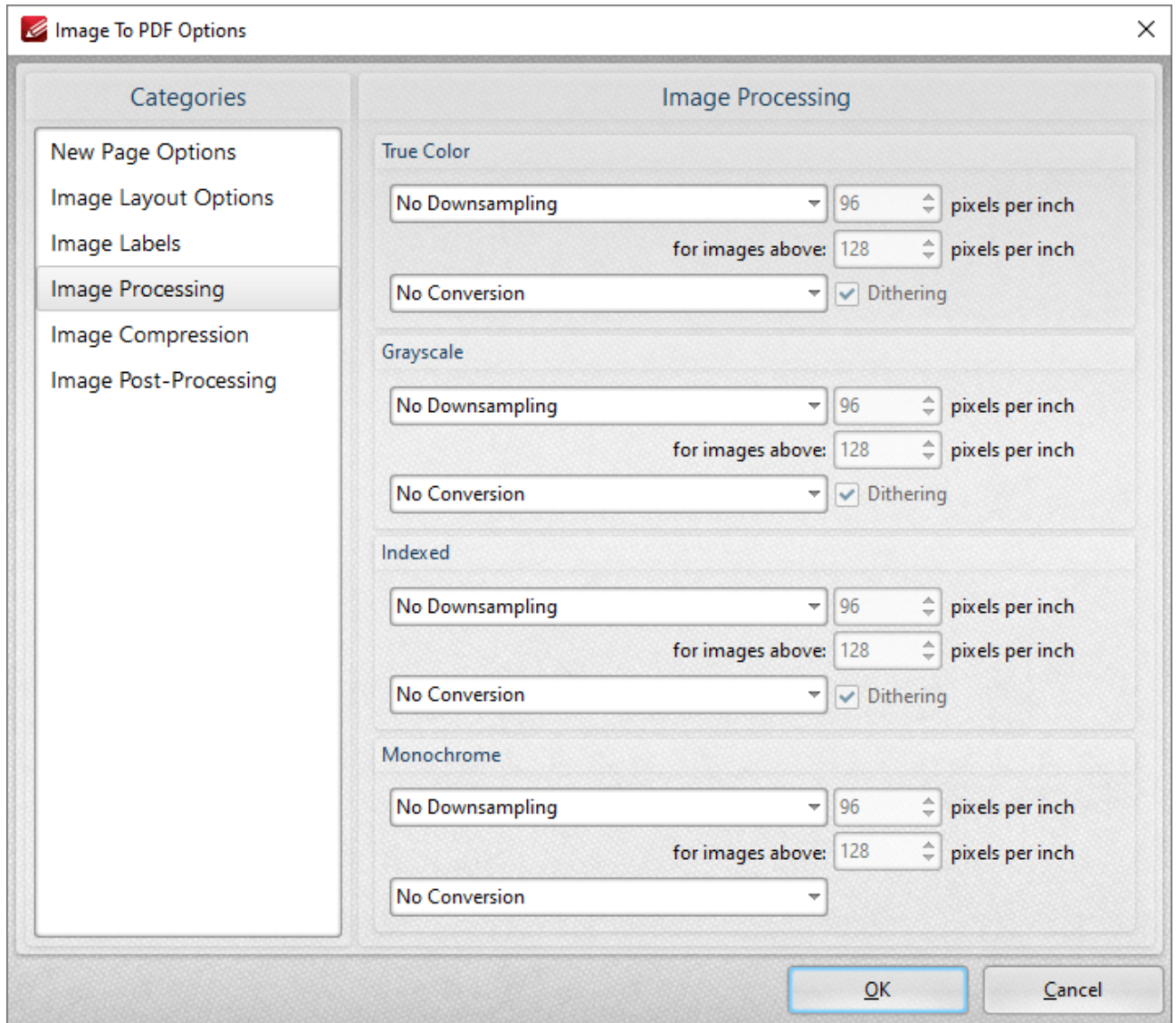

Figure 7. Images to PDF Options Dialog Box, Image Processing Options

- These settings determine the dimensions for converted documents of different formats: **True Color**, **Grayscale**, **Indexed** and **Monochrome**. There are two options for each format:
- **Downsampling** reduces the sampling rate of images. Each format has three options: **Linear**, **Bilinear** and **Bicubic**. Further information about these options is available [here](#). Use the **pixels per inch** boxes to determine the size above which and to which images will be downsampled.
- **Conversion** relates to the automatic conversion of files, where possible, from one format to another. Use this option to convert the format of new files when they are created. Where applicable, select the box for [dithering](#) as desired.

Click **OK** to save settings.

## Image Compression

When this option is selected in the **Categories** menu the following options are available:

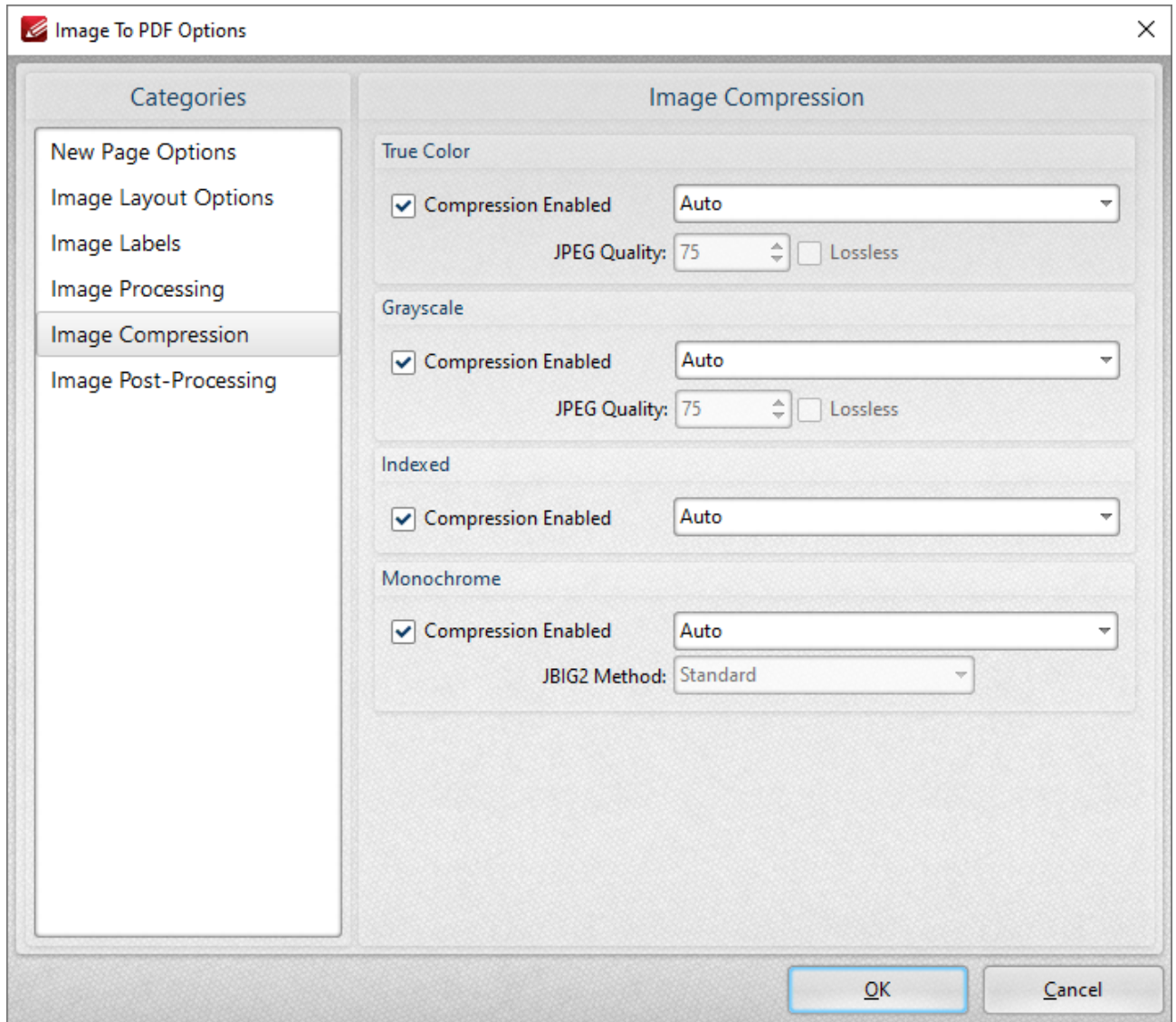

**Figure 8.** Images to PDF Options Dialog Box, Image Compression Options

- Image compression is enabled by default. Clear the boxes to disable this setting.
- When compression is enabled, use the adjacent menu to select the type of compression that the tool performs. **Auto** is the default setting.
- Where applicable, adjust the **JPEG Quality**/**JBIG2 Method** and **Lossless** options as desired.

Click **OK** to save settings.

## Image Post-processing

When this option is selected in the **Categories** menu the following options are available:

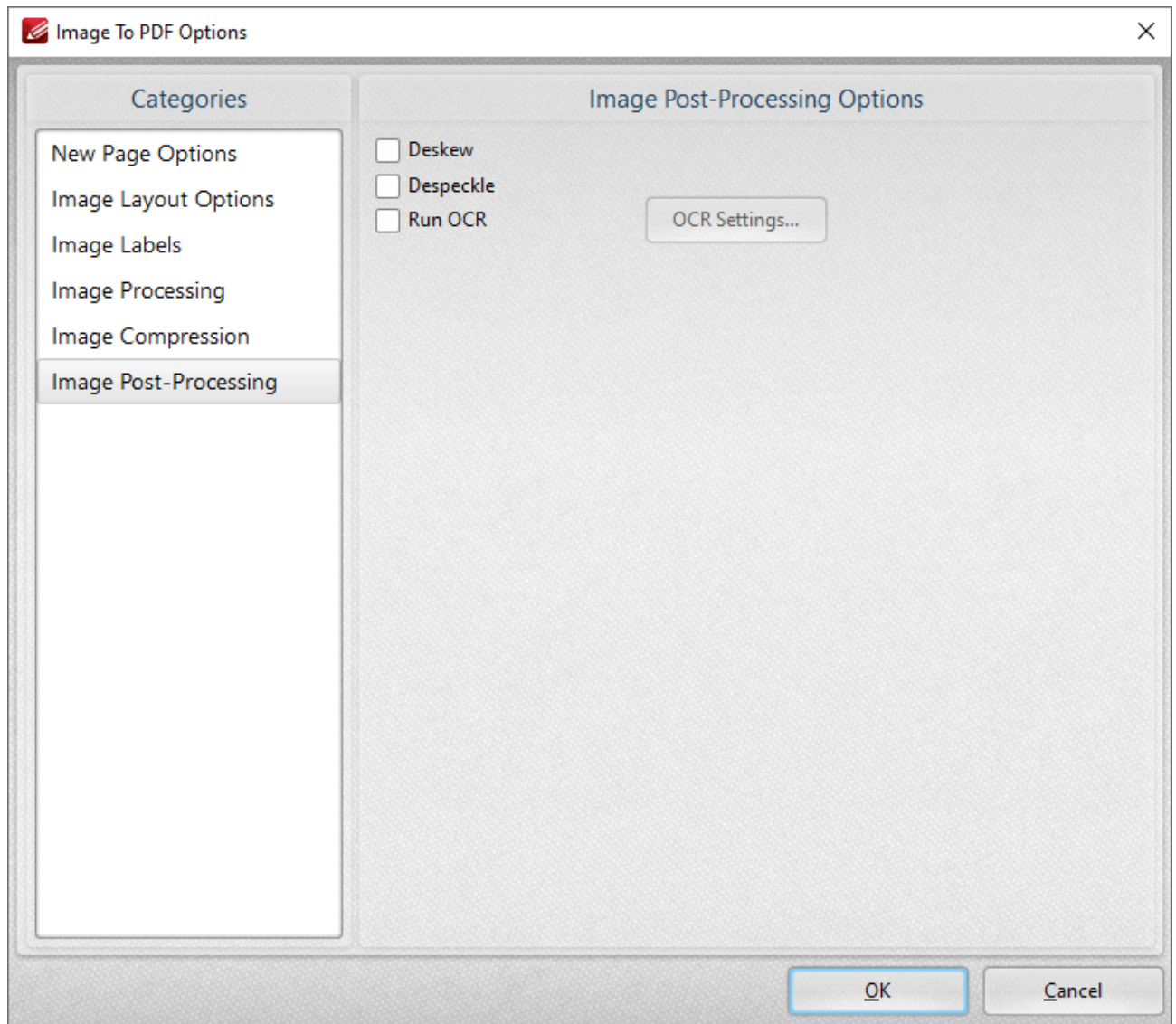

**Figure 9.** Images to PDF Options Dialog Box, Image Post-Processing Options

- Select the **Deskew** box to deskew images. This straightens the edges of images automatically and is a useful tool if images have been scanned or photographed crookedly.
- Select the **Despeckle** box to despeckle images. This removes speckles from images during conversion.
- Select the **Run OCR** box to OCR images after processing. Click the **OCR Settings** button to set the language and accuracy of the OCR process.

Click **OK** to save settings.

---

### 10.4.1.3.9 From Scanner



## From Scanner

Click **From Scanner** to create PDF documents from the local scanner:

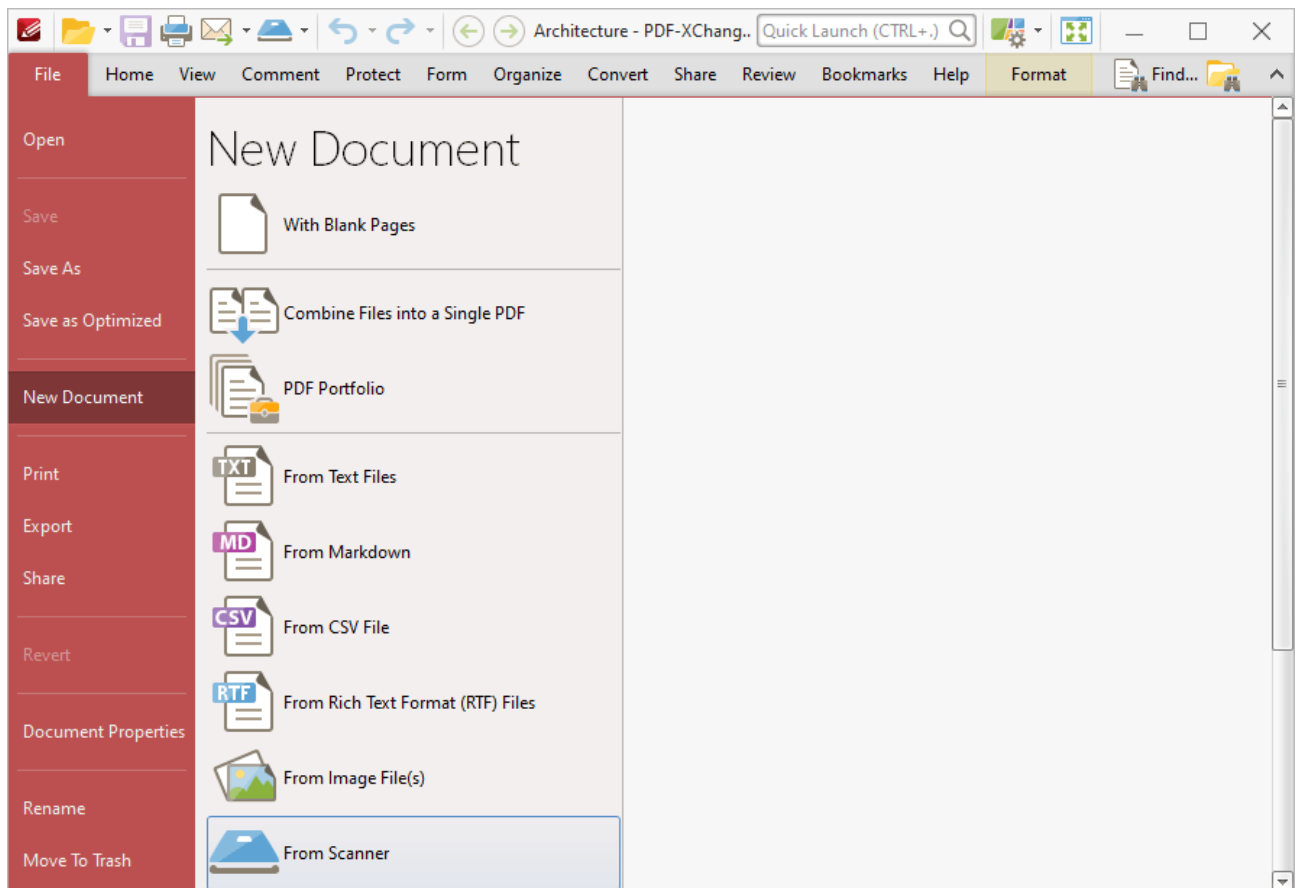

**Figure 1.** New Document Submenu. From Scanner Options

- Preset options are displayed in the **From Scanner** list. Click these options to create a new document according to their preset parameters.
- Click **Configure Presets** to determine preset parameters for each mode, as detailed [here](#).<sup>[912]</sup>
- Click **Custom Scan** to determine custom parameters. The **Scan Properties** dialog box will open:

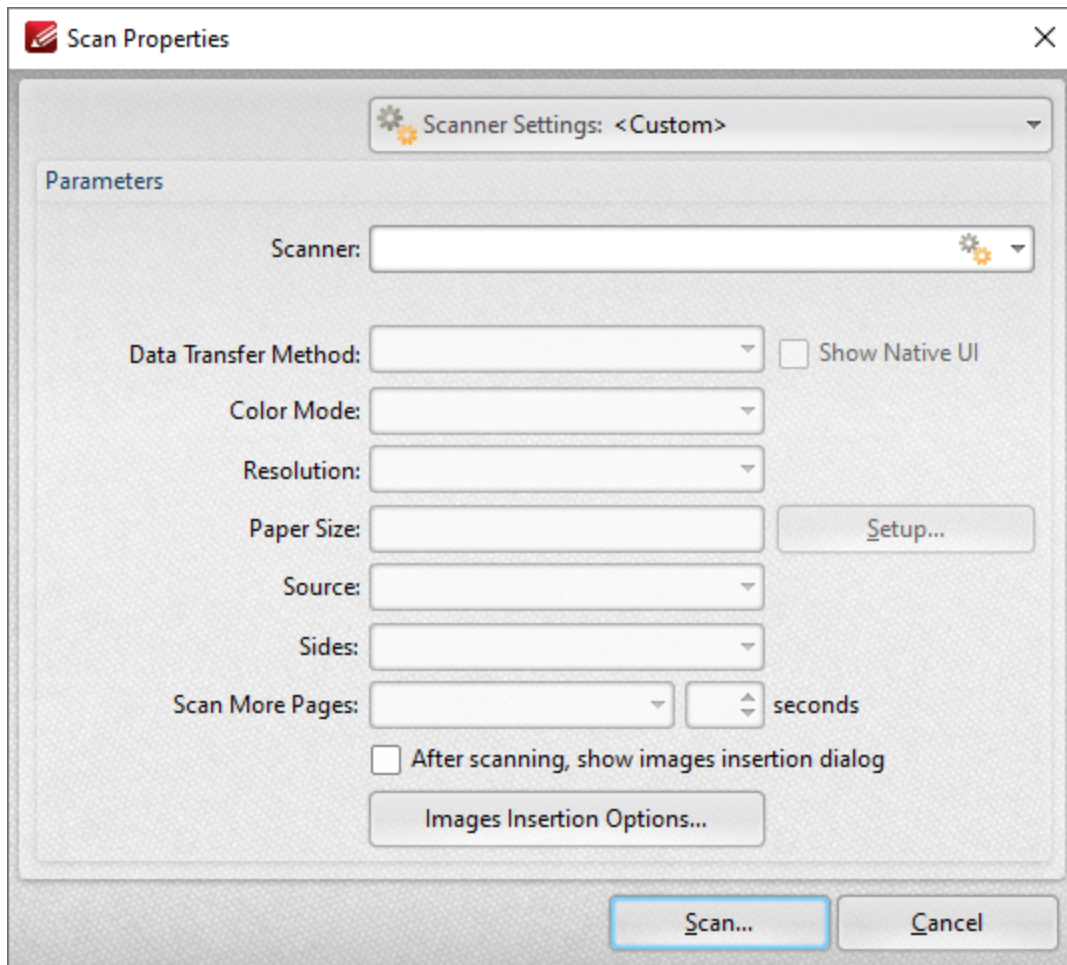



Figure 2. Scan Properties Dialog Box

- Click the **Scanner Settings** menu to select a preset scanning mode.
- Click the **Scanner** menu to select a scanner to use.
- Click the **Data Transfer Method** menu to select either **Native Mode** or **Memory Mode**:
  - **Native Mode** uses a single memory buffer. This is the default and fastest mode, and is compatible with the broadest range of scanners.
  - **Memory Mode** enables the use of multiple memory buffers. This is a useful function in cases where memory is low and/or when large images are being scanned.
- The **Show Native UI** box is selected by default, which means the user interface of the device driver is used. This is the most reliable option, and the scanner will select certain parameters of the scan itself: **Color Mode, Resolution, Paper Size and Source**. Clear the **Show Native UI** box to customize these options:
  - **Color Mode** has four options: **Auto detect, Color, Grayscale** and **Black & White**. These refer to the format of scanned documents.
  - Click the **Resolution** menu to select the **DPI** (dots per inch) of scanned documents.
  - **Paper Size** refers to the size of the paper used when scanning. Click **Setup** for further options, which are as follows:

- The **Automatic** option determines the paper size automatically.
- The **Standard** option contains standard sizes such as those used by the **ISO** and **ANSI**.
- The **Custom** option can be used to enter custom dimensions.
- **Source** has three options **Auto, Flatbed and Feeder**. These refer to the type of scanner being used.
- Click the **Sides** menu to determine which sides of documents are scanned. There are three options: **Simple Scan, Manual Duplex** and **Manual Duplex Reversed**. Click the arrow for an explanation of these options.
- Click the **Scan More Pages** menu to select the setting for when additional pages are scanned.
- Select the **After scanning, show images insertion dialog** box to view the images insertion dialog box after the scan has taken place. This enables the customization of images and images settings.
- Click the **Images Insertion Options** button to determine further options for inserted images. Those options are explained [here](#).

Click **Scan** to scan pages.

## Scanner Settings

Click the **Scanner Settings** menu to save custom settings for subsequent use. The following dialog box will open:

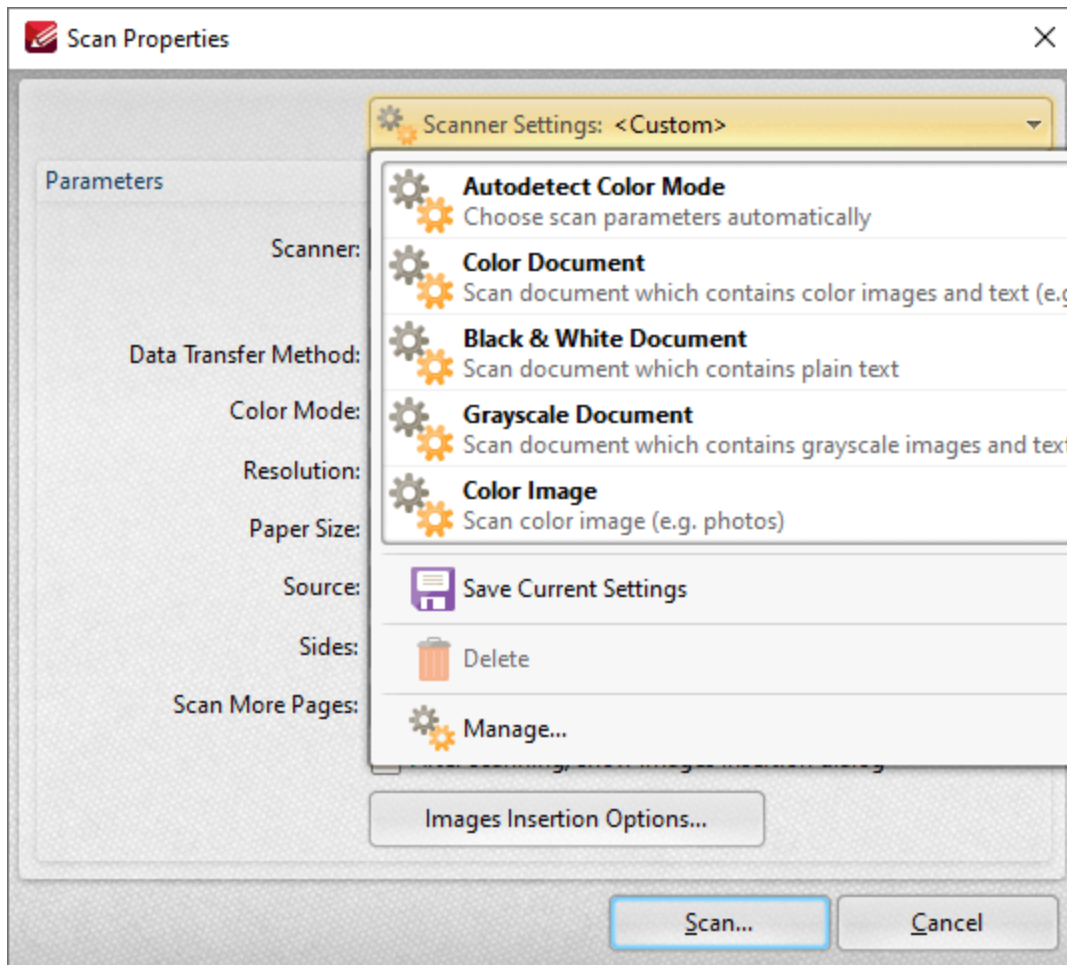

Figure 3. Scanner Settings Options

These options are used to adjust the scanner mode or save custom settings. There are five preset modes that relate to the format of scanned documents. They feature settings that are optimal for their respective modes. These modes can also be selected when choosing the option through which the new document is created. Hover the pointer over the **New Document > From Scanner** option and a menu will appear. The options to **Custom Scan** and **Configure Presets** are also available on this menu. Click **Custom Scan** to launch the **Scan Properties** dialog box shown in (figure 2) above. Click **Configure Presets** to open the **Configure Scanner Presets** dialog box and determine the presets for scanning.

When custom parameters have been entered in the **Scan Properties** dialog box they can be saved for subsequent use with the **Save Current Settings** option. Click the icon/text to save the current settings. Enter a name (and brief description, if desired) for the customized settings. Click **Manage** to edit customized settings and **Delete** to remove them.



## 10.4.1.4 Print



Click **Print** (or press Ctrl+P) to print the current document:

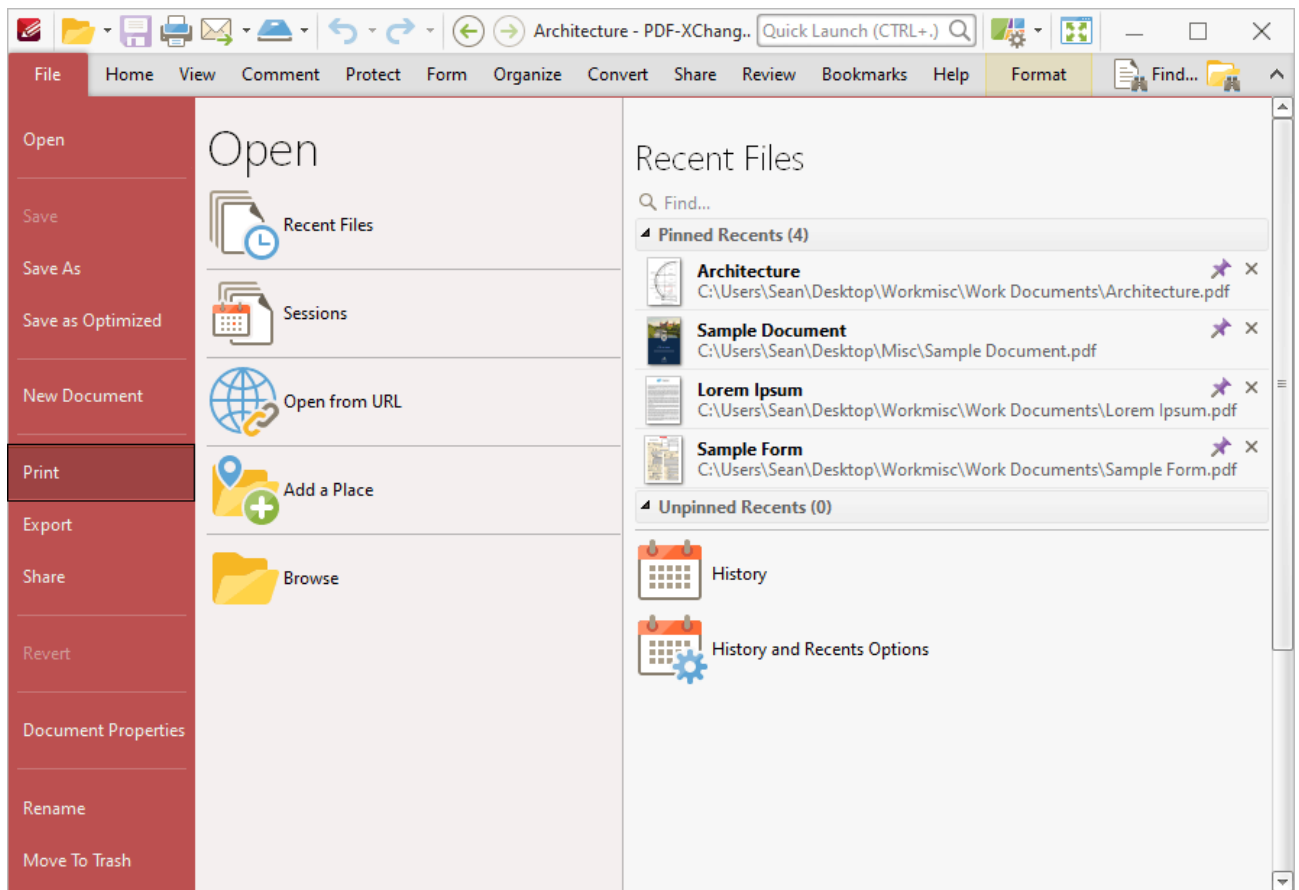

**Figure 1.** File Tab Submenu, Print Options

The **Print** dialog box will open:

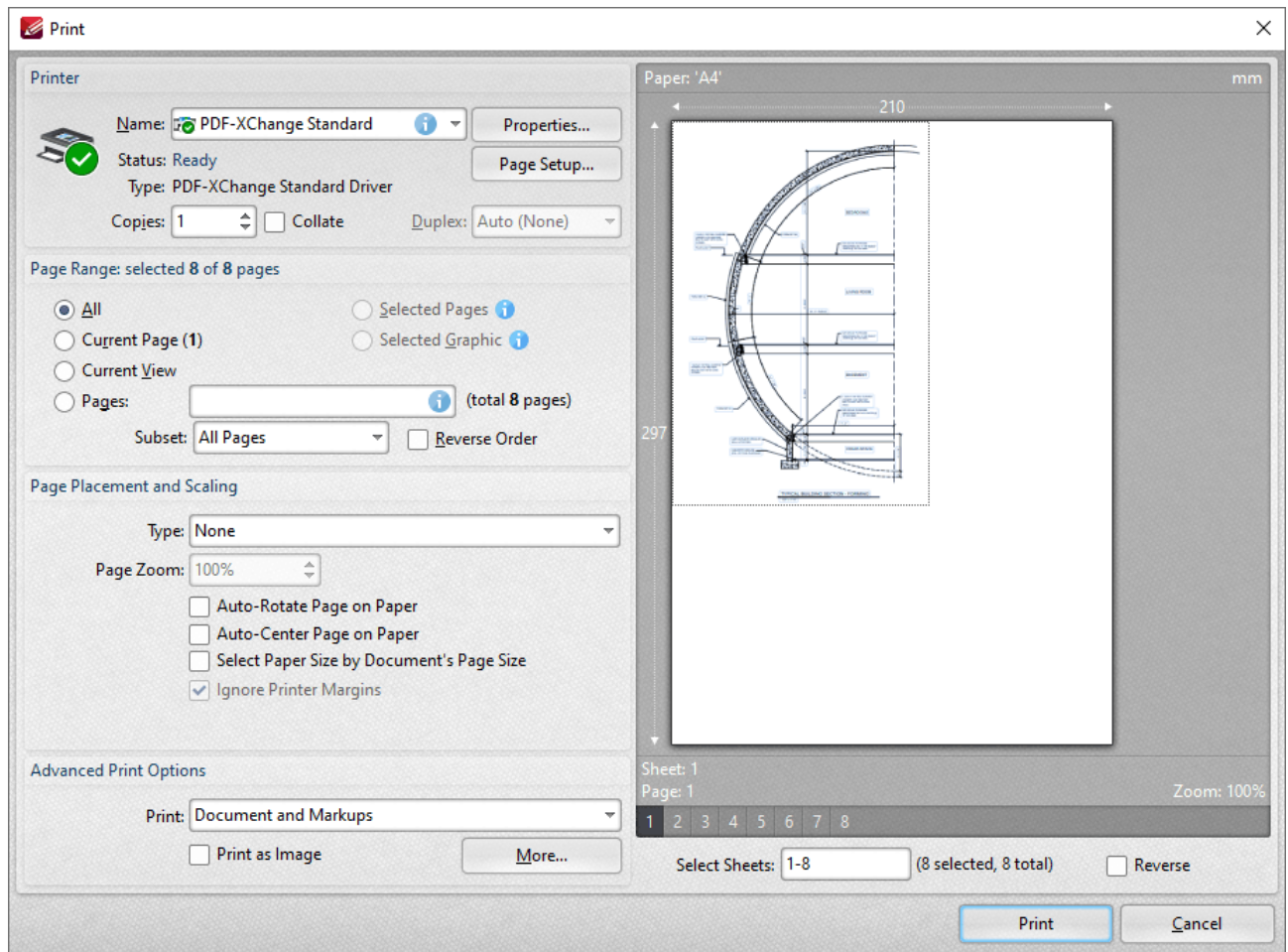

Figure 2. Print Dialog Box

- The options in the **Printer** section determine the printer to be used and its associated settings:
  - Use the **Name** text box to select a printer to use.
  - Use the **Copies** text box to determine how many copies of the document are printed.
  - Select the **Collate** box to collate document pages. This is a useful feature when printing multiple copies of multi-page documents. It prints entire copies of documents together, as opposed to multiple copies of each page at a time.
  - Click the **Properties** button to open the **Properties** dialog box for the selected printer.
  - Click the **Page Setup** button to open the **Page Setup** dialog box. See (figure 3) below.
- The options in the **Page Range** section determine which pages of the document will be printed:
  - Select **All**, **Current Page** or **Current View**.
  - Use the **Pages** box to determine which pages of the document are printed. See [here](#)<sup>1773</sup> for further information.
  - Use the **Subset** option to select **All Pages**, **Odd Pages Only** or **Even Pages Only**.
  - Select the **Reverse Order** box to print documents in reverse numerical order.
- The options in the **Pages Placement and Scaling** section determine the placement and scaling of the document:

- Use the **Type** menu to select a standard placement setting. When a setting is selected its features will be shown in the preview window. Each setting has further options that become available when the setting is selected. The effect that these have will be shown in the preview window when they are adjusted.
- Use the **Page Zoom** number box to determine the level of zoom on the page. Select the check boxes to enable further settings.
- The options in the **Advanced Print Options** tab determine advanced printing options:
  - Use the **Print** menu to determine which elements of the document are printed. Click **More** for further options. See *(figure 4)* below.
  - Select the **Print as Image** box to print the selected pages as images.
  - When the desired parameters have been selected, click **Print** to print the document.

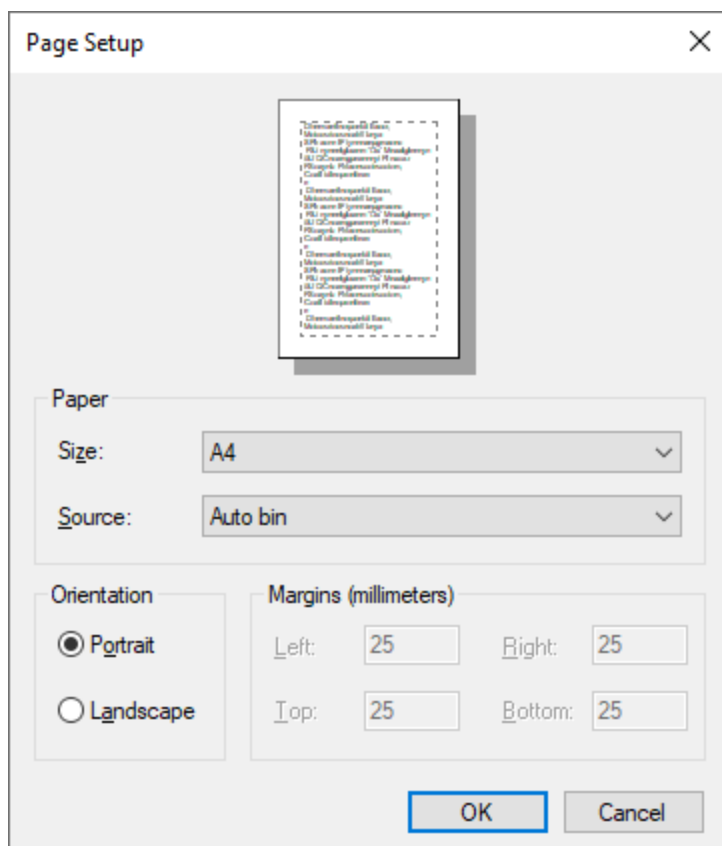

Figure 3. Page Setup Dialog Box

- Select a size for the document from the **Size** menu.
- Select a source for the document from the **Source** menu.
- Use the option buttons to select either **Portrait** or **Landscape** as the orientation for the document.

Click **OK** to apply changes.

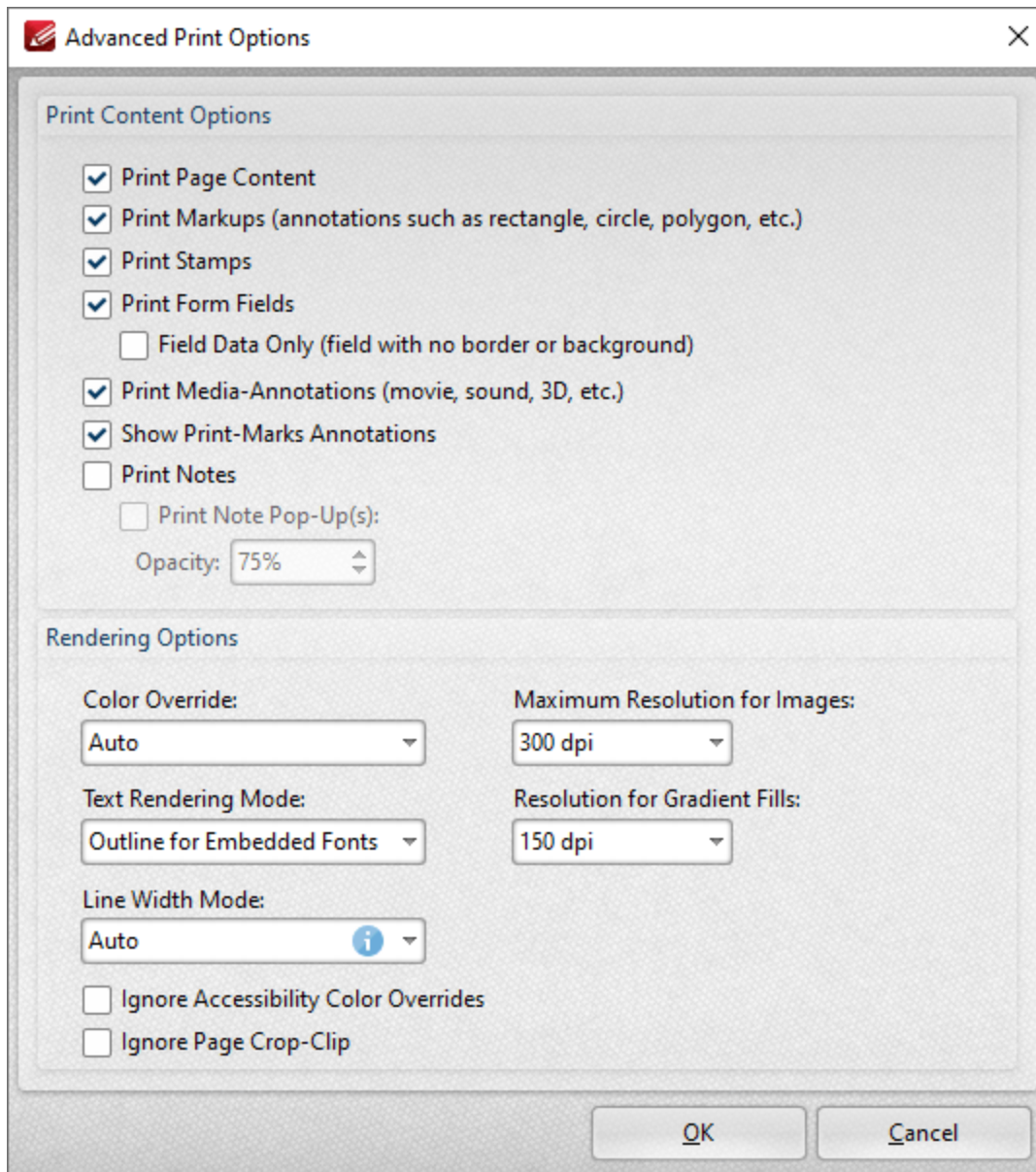

Figure 4. Advanced Print Options Dialog Box

- Use the **Print Content Options** to determine printed document content.
- Use the **Rendering Options** to determine how documents are rendered:
  - Use the **Color Override** dropdown menu to determine color override options:
    - **Auto** permits **PDF-XChange Editor** to select the color override setting.
    - **Grayscale** prints documents in grayscale.
    - **Monochrome** prints documents in monochrome.
    - **Color** prints documents in color.
  - Use the **Text Rendering Mode** dropdown menu to determine how text is rendered:
    - **Auto** permits **PDF-XChange Editor** to select the text rendering mode. Additionally, it should be noted that this option is required in order to print embedded fonts.

- **Outline for Embedded Fonts** prints embedded fonts as outlines, which are vector images.
- **Outline Always** prints all fonts as outlines.
- **Bitmap for Embedded Fonts** prints embedded fonts as bitmap images.
- **Bitmap Always** prints all fonts as bitmap images.
- Use the **Maximum Resolution for Images** dropdown menu to set the maximum resolution of images in printed documents.
- Use the **Resolution for Gradient Fills** dropdown menu to determine the resolution used for gradient fills.
- Select the **Ignore** check boxes as desired.

Click **OK** to apply changes.

---

### 10.4.1.5 Export



## Export

Click **Export** to export a copy of the current document to a different format:

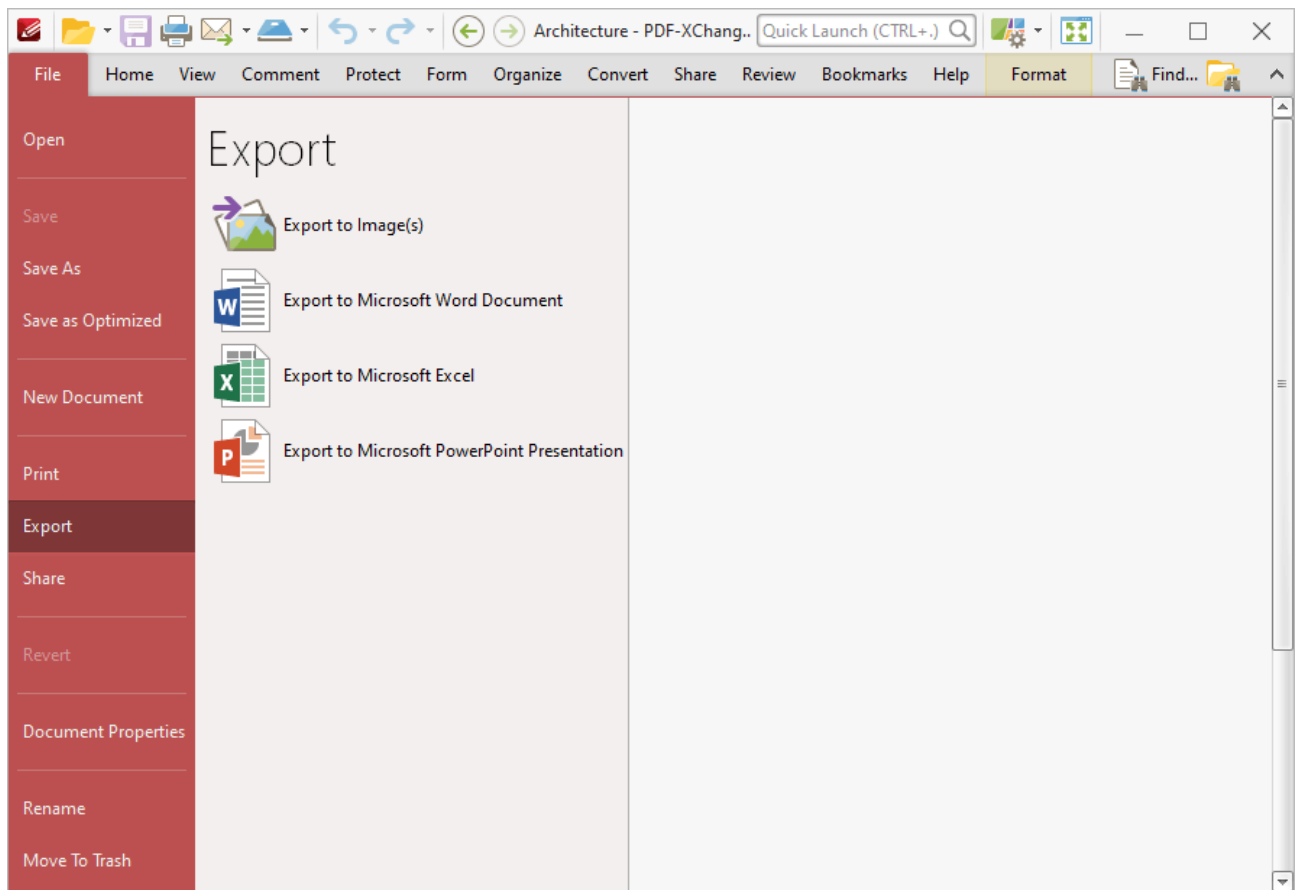

**Figure 1.** File Tab Submenu, Export Options

Click **Export to Image(s)** to export PDF documents into image format. The **Export to Image(s)** dialog box will open:

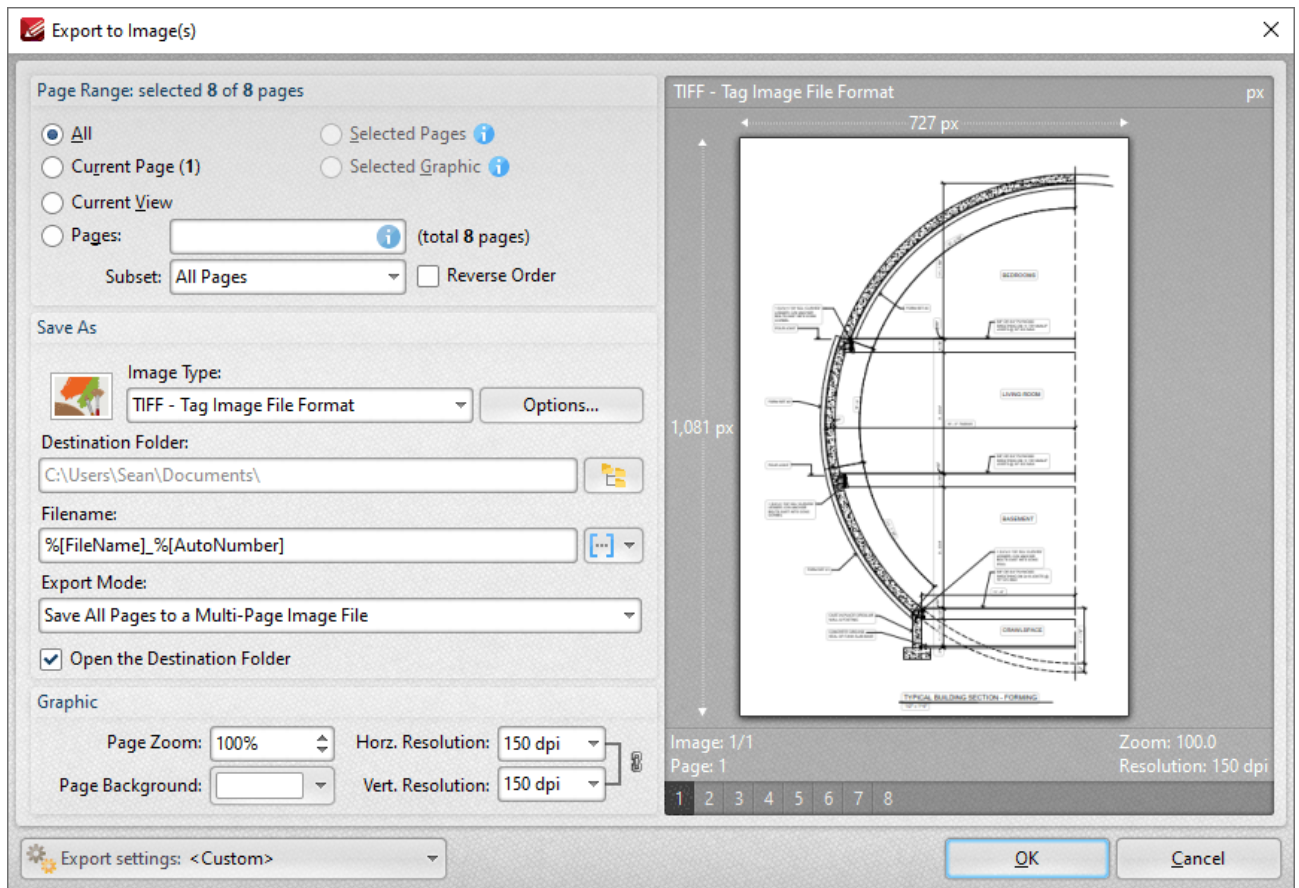

Figure 2. Export to Images Dialog Box

- Use the **Page Range** options to select the pages that will be exported. The following options are available:
  - Click **All** to export the entire document.
  - Click **Current Page** to export only the page that is currently being viewed.
  - Click **Current View** to export what is currently visible in the PDF viewer.
  - Use the **Pages** option to select specific pages or page ranges. See [here](#)<sup>1773</sup> for further information.
  - Use the **Subset** option to select either all odd or all even pages of the document.
  - Select the **Reverse Order** box to export pages in reverse numerical order.
- Use the **Save As** options to determine the file type and location of the saved document:
  - Use the **Image Type** option to determine the image format. Click the **Options** button to determine further document properties.
  - Use the **Destination Folder** text box to enter the folder in which the document will be saved. Alternatively, click the adjacent icon to browse the folders on the local computer.
  - Use the **Filename** text box to enter a file name for the new document. Add [macros](#)<sup>1707</sup> as desired - enter them after the file name or click the adjacent icon.
  - Use the **Export Mode** setting to select the mode in which multiple-page documents are exported. There are three options:
    - Save all pages to a single multi page image file.

- Save each page range to a multi page image file.
- Save each page to a separate single page image file.
- The **Open the Desintation Folder** box is selected by default. Clear this box to disable this function.
- Use the **Graphic** options to determine the graphics settings:
- **Page Zoom** increases or decreases image dimensions.
- The **Resolution** boxes determine the horizontal and vertical resolution of images. The ratio is constrained by default. Click the chain icon to disable this setting.
- The **Page Background** setting determines the color of the background in the new document.

When custom export options have been selected they can be saved using the **Export Settings** menu. Click **Save** to save the current settings. Enter a name (and brief description, if desired) for the settings. Click **Manage** to edit customized settings and **Delete** to remove the setting currently selected.

Click **Export to Microsoft Word Document** to export documents to **(\* .docx)** format, which is intended for use with **Microsoft Word**. The **Save File** dialog box will open and the file name will be added in **(\* .docx)** format automatically.

Click **Export to Microsoft Excel** to export documents to **(\* .xlsx)** format, which is intended for use with **Microsoft Excel**. The **Save File** dialog box will open and the file name will be added in **(\* .xlsx)** format automatically.

Click **Export to Microsoft Powerpoint Presentation** to export documents to **(\* .pptx)** format, which is intended for use with **Microsoft Powerpoint**. The **Save File** dialog box will open and the file name will be added in **(\* .pptx)** format automatically.

Please note that **Microsoft Office** must be installed on the local computer for these features to operate.

---



### 10.4.1.6 Share



Click **Share** to email documents or manipulate **SharePoint** documents:

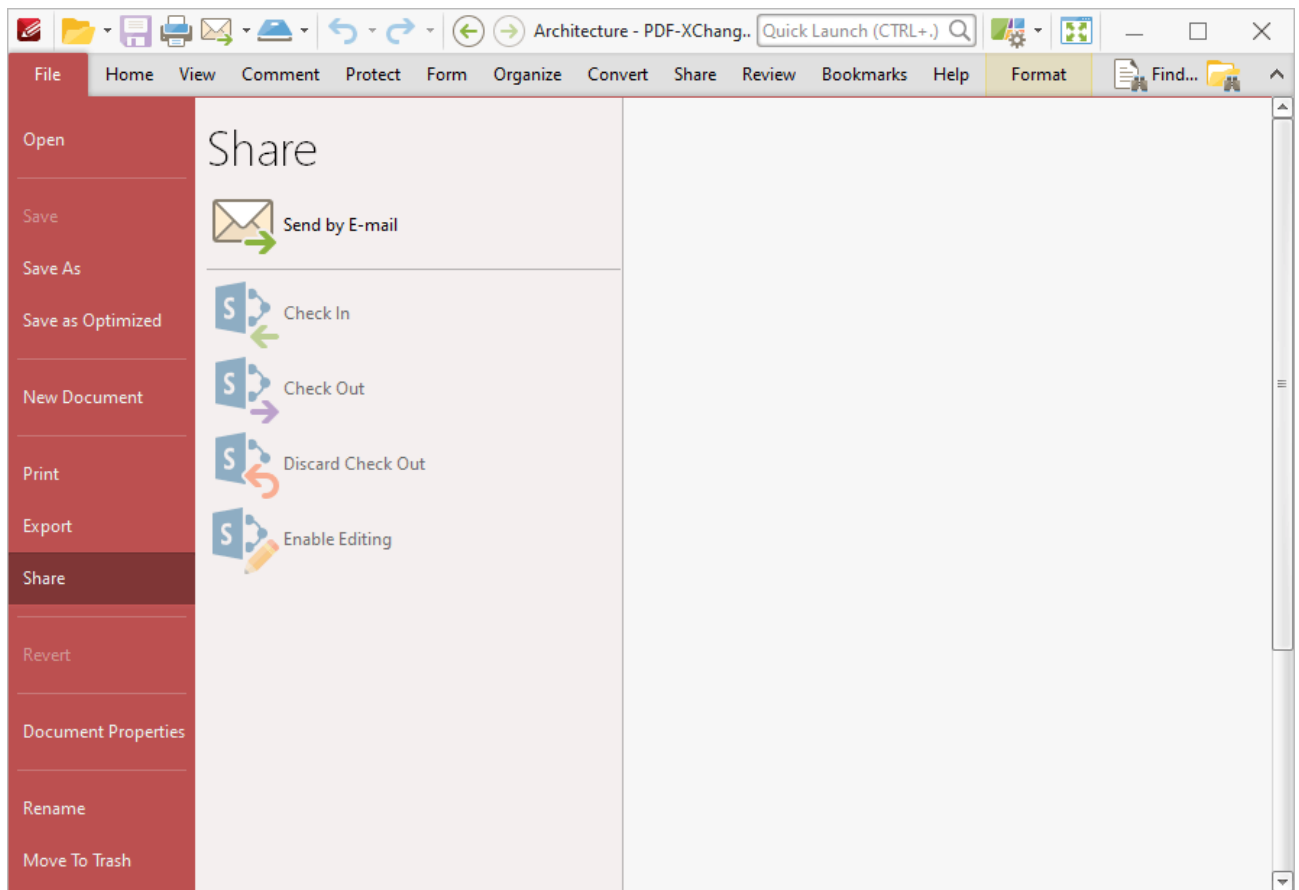

Figure 1. File Tab Submenu, Share Options

- Click **Send by E-mail** to email the document. The mail client set in the [Email Preferences](#)<sup>919</sup> will open and the document will be added to an outgoing email as an attachment.
- Click **Check In/Check Out** to check the document in to/out from a **SharePoint** account.
- Click **Discard Check Out** to discard the file currently checked out from a **SharePoint** account.
- Click **Enable Editing** to enable editing for the file currently checked out from a **SharePoint** account.



10.4.1.7 Document Properties



**Document Properties**

Click **Document Properties** to view/edit document properties:

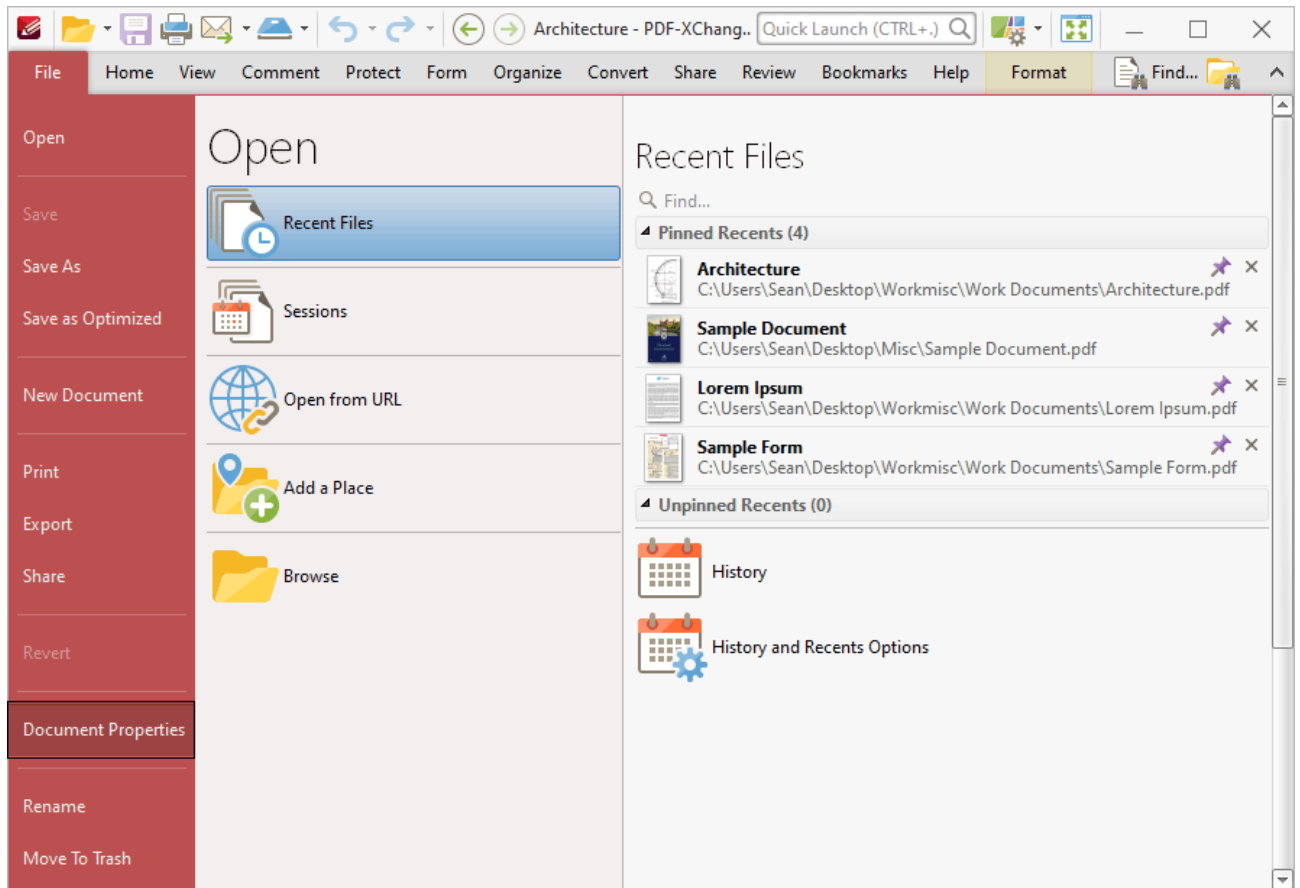

**Figure 1.** File Tab Submenu, Document Properties

The **Document Properties** dialog box will open:

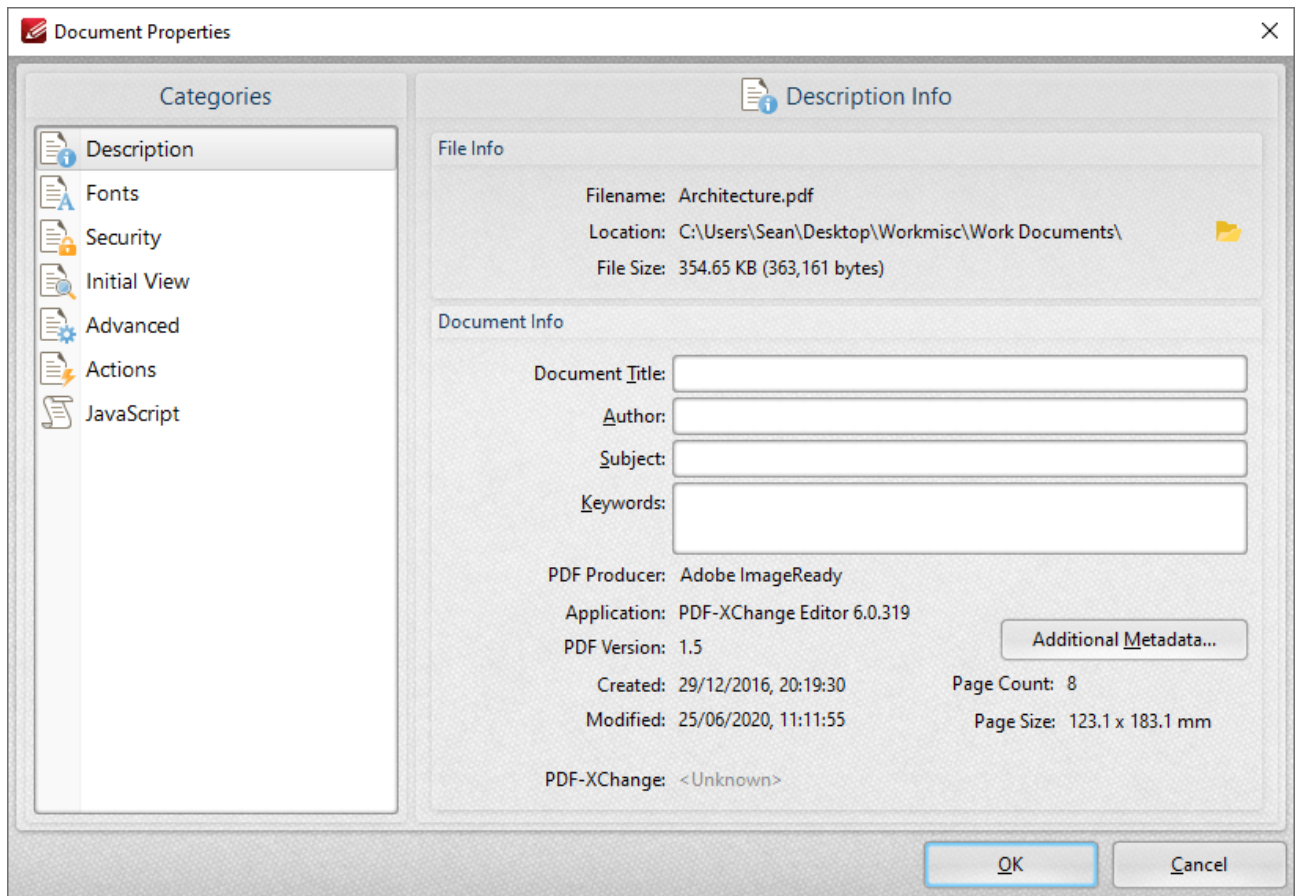

Figure 2. Document Properties Dialog Box, Description Option Selected

Please note that the keyboard shortcut Ctrl+D can also be used to launch this dialog box. Select an option from the **Categories** menu to view/edit properties:

## Description

This option displays details about the document currently selected:

- The **File Info** section contains information about the File name, location and size. Click the folder icon on the right to open the containing folder on the desktop.
- The **Document Info** section contains information about the **Document Title, Author, Subject** and **Keywords**. These can be edited using the adjacent text boxes. Further document details can be viewed beneath this section. Click the **Additional Metadata** button to view/edit additional document details:

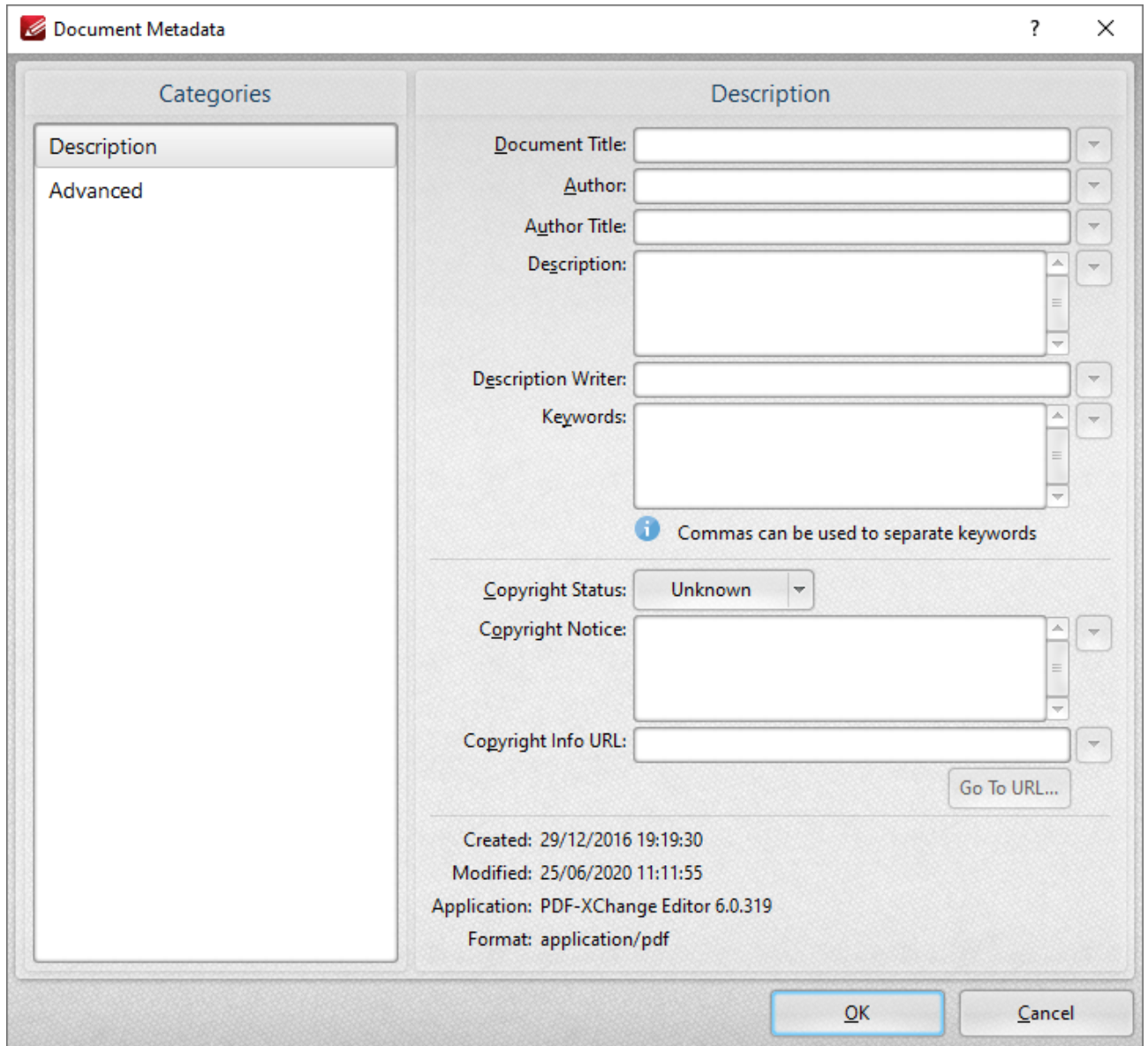

Figure 3. Document Metadata Dialog Box, Description Tab

Use the text boxes to view/edit document metadata. Click **Advanced** in the **Categories** menu to determine document metadata structure.

**Fonts**

This option displays details about document fonts. Please note that the information displayed is read-only. The [Save as Optimized](#)<sup>784</sup> settings can be used to customize font embedding options.

**Security**

This option displays document security details:

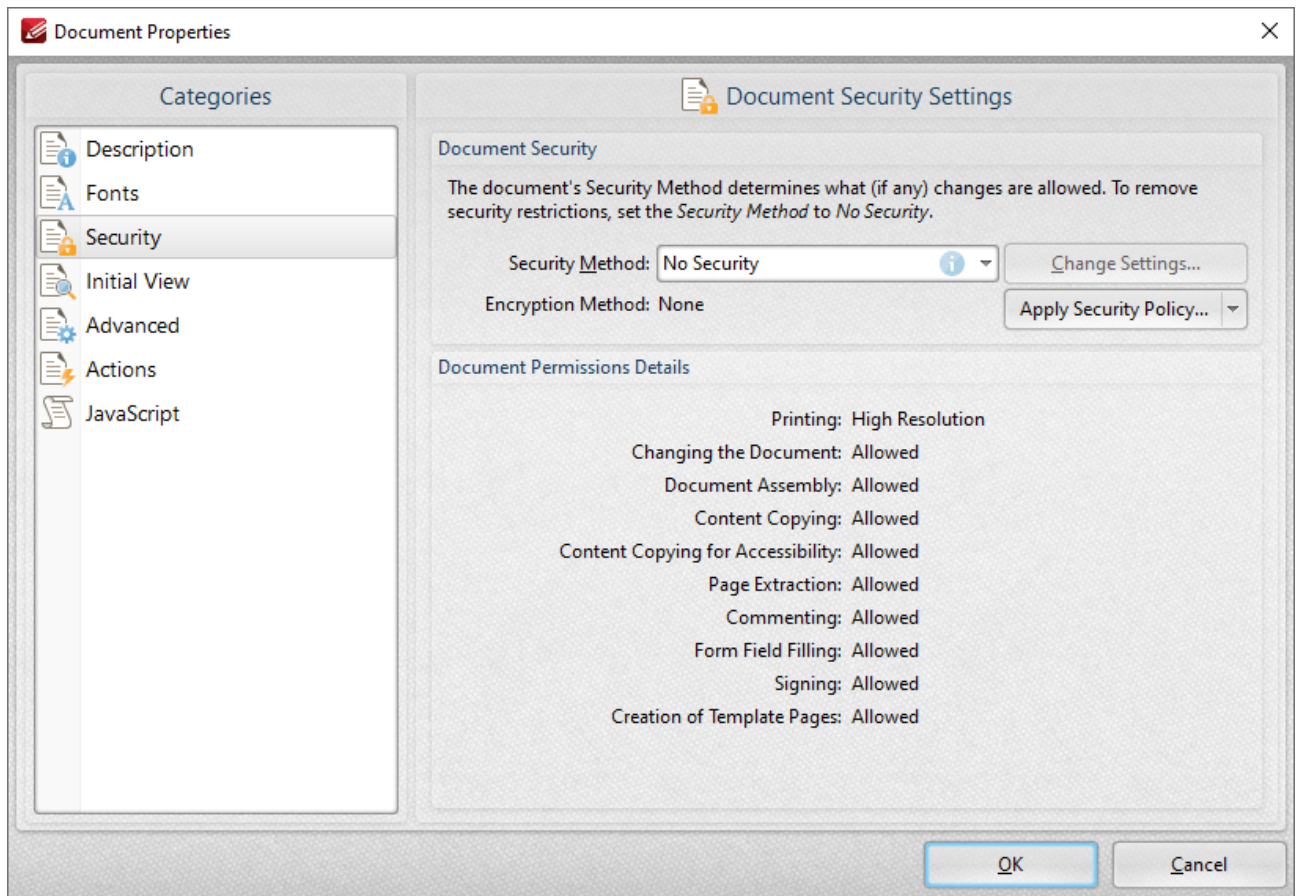

Figure 4. Document Properties Dialog Box, Security Option Selected

- Use the **Security Method** menu to select the type of security used in the document:
  - **No Security** is the default setting, which means subsequent users have no restrictions on editing the document. This option should also be used when removing security from documents.
  - **Password Security** enables document encryption, passwords and permissions. When it is selected the dialog box in *(figure 5)* will open.
  - The **Certificate Security** option is available only when documents feature certificate security.
  - The **FileOpen** option is available only when documents feature **FileOpen** security.
  - Click the **Apply Security Policy** button to apply a new security policy or clone/edit existing policies, as detailed in *(figure 6)*.
  - Additional security options are available [here](#).<sup>916</sup>

Click **OK** to save settings.

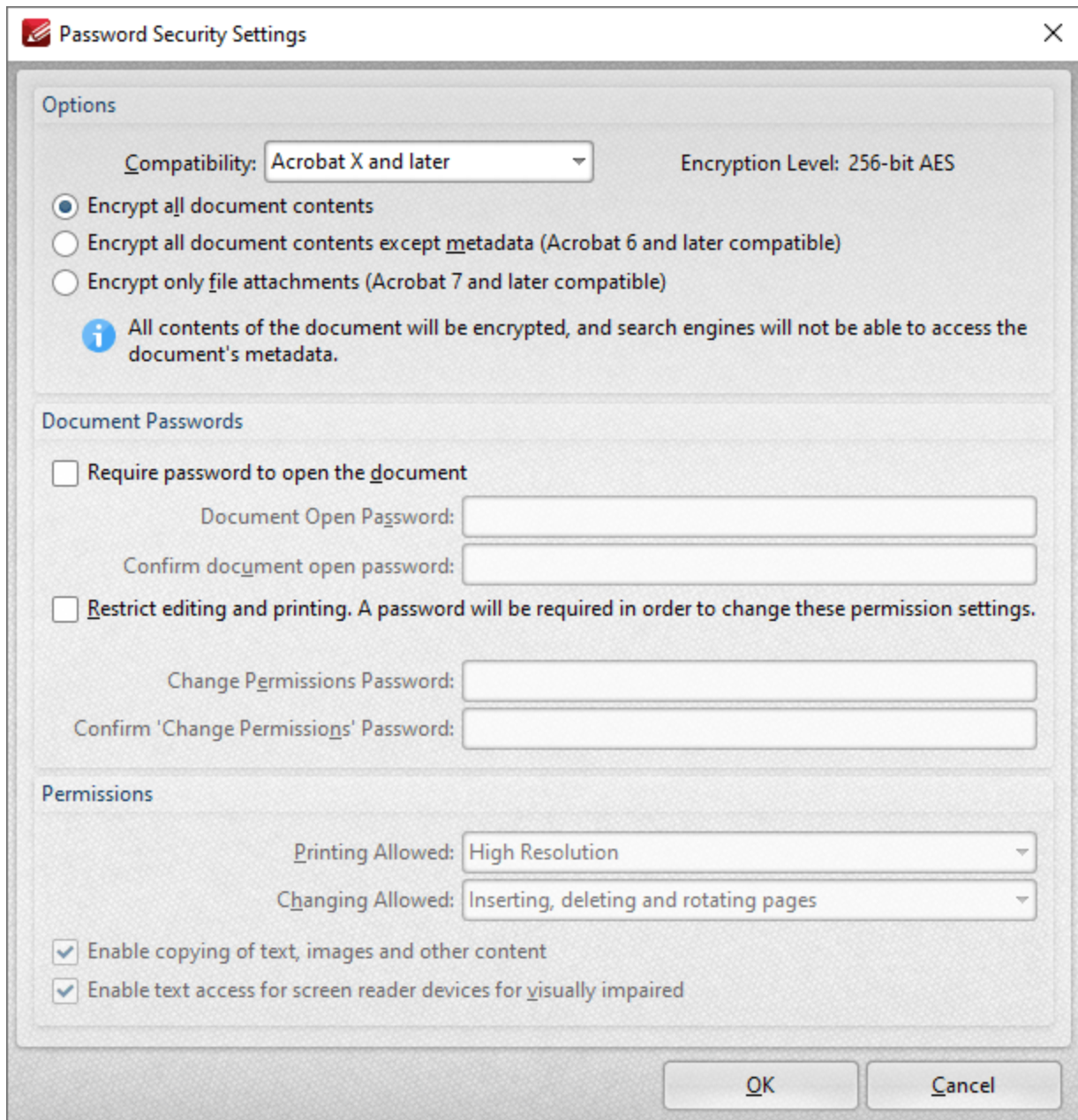
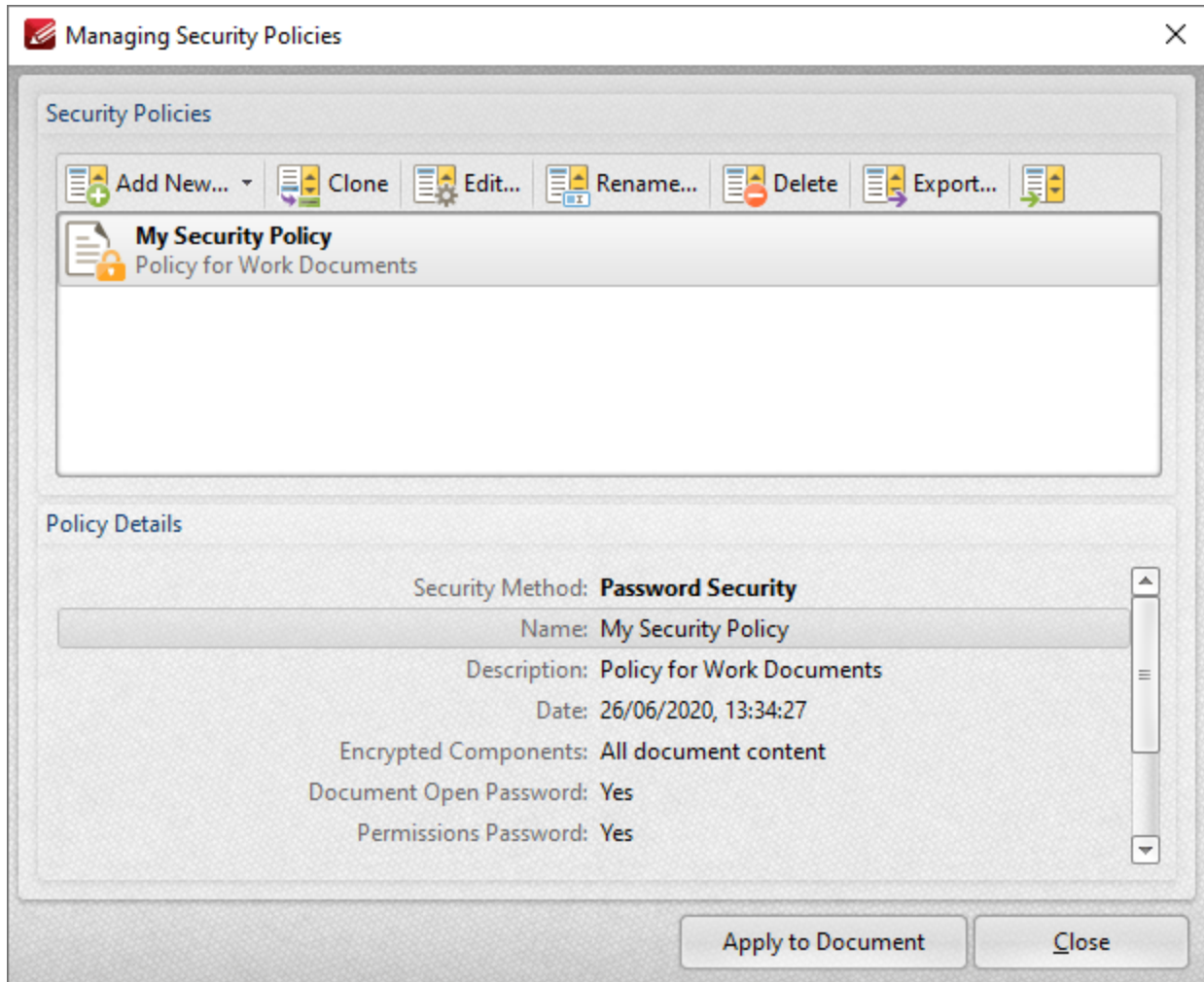

Figure 5. Password Security Settings

- Use the **Compatibility** menu to select the document security compatibility.
- Select an encryption option button to determine which elements of documents are encrypted.
- Select the **Require password to open the document** box to set a password for opening the document. Enter the password in the **Document Open Password** text box and confirm it in the text box below.
- Select the **Restrict editing and printing of the document** box to set a password for editing and printing the document. Enter the password in the **Change Permissions Password** text box and confirm it in the text box below. Use the dropdown menus and check boxes in the **Permissions** section to select the settings that these passwords will enable.

Click **OK** to save settings.



**Figure 6.** Managing Security Policies Dialog Box

This dialog box is used to create and manage security policies:

- Click **Add New** to add a new security policy. The **Password Security Settings** dialog box detailed in **(figure 5)** will open. Determine parameters as desired then click **OK** to save.
- Click **Clone/Edit/Rename/Delete** to perform these operations on selected security policies.
- Click **Export** to export the security policy for subsequent use. Exported polices can be imported with the **Import** button, which is on the right of the **Export** button.
- Click **Apply to Document** to apply the security policy selected in the **Managing Security Policies** dialog box to the current document.

### Initial View

These settings determine the layout when files are opened:



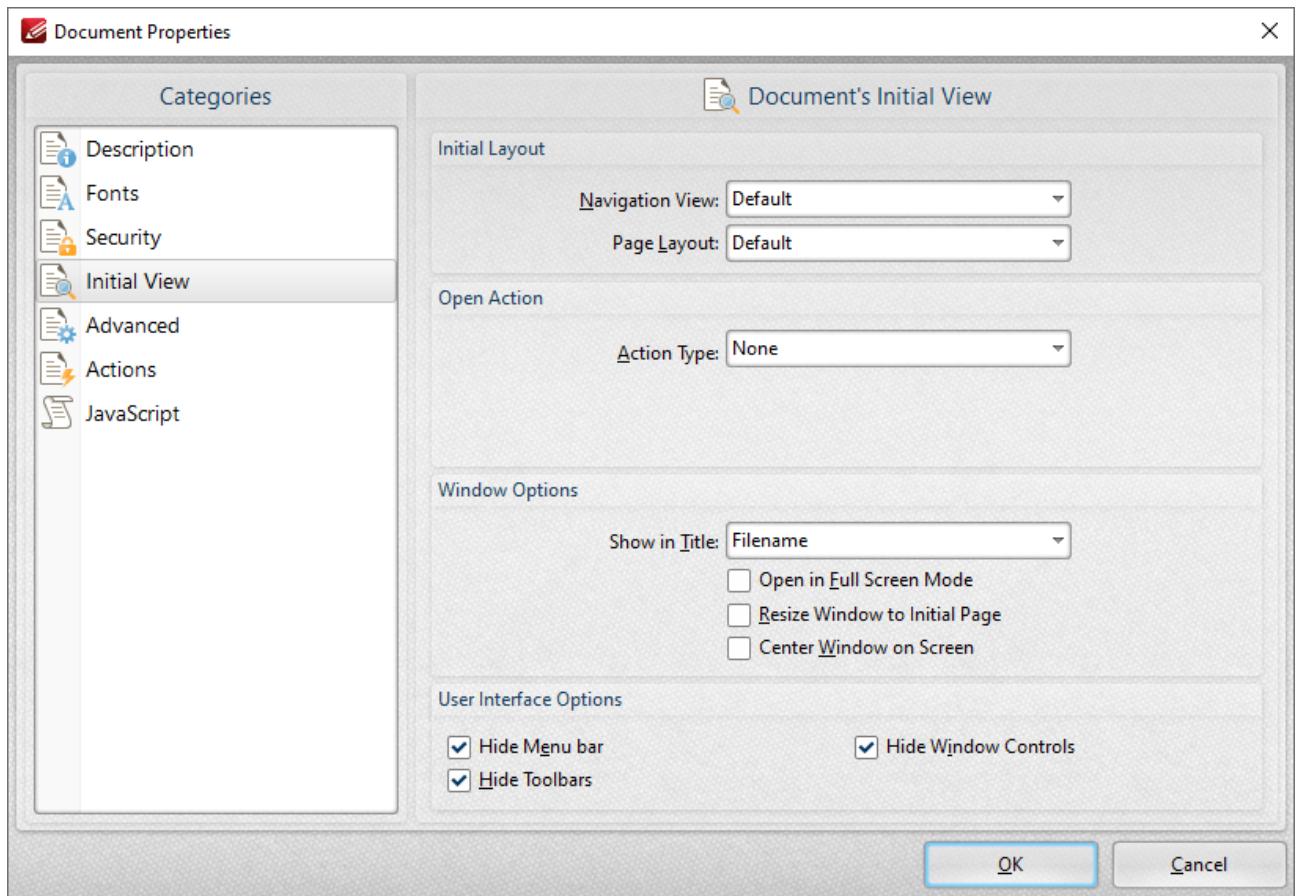

Figure 7. Document Properties Dialog Box, Initial View Option Selected

The **Layout and Magnification** settings are as follows:

- The **Navigation View** menu determines the panes that are visible when documents are opened:
  - Select **Default** to retain the default settings of the application used to open documents.
  - Select **Page Only** to view only the document itself.
  - Select **Bookmarks pane and page** to view the document and the bookmarks pane.
  - Select **Thumbnails pane and page** to view the document and the thumbnails pane.
  - Select **Layers pane and page** to view the document and the layers pane.
  - Select **Attachments pane and page** to view the document and the attachments pane.
- The **Page Layout** menu determines the page layout when documents are opened:
  - Select **Default** to retain the default settings of the application used to open documents.
  - Select **Single Page** to view a single page at a time.
  - Select **Continuous** to view pages in a single, scrolling column.
  - Select **Two Pages Continuous** to view two pages at a time in scrolling columns.
  - Select **Two Pages Continuous, with Cover Page** to view as above, but with a cover page included.
  - Select **Two Pages** to view two pages at a time.

- Select **Two Pages with Cover Page** to view as above, but with a cover page included.
- The **Magnification** menu determines the level of zoom when documents are opened:
  - Select **Default** to retain the default settings of the application used to open documents.
  - Select **Actual Size** to view pages at their actual size. The resulting display will include resolution settings.
  - Select **Fit Page** to view the full extent of page content regardless of its size.
  - Select **Fit Width** to fit pages according to their width.
  - Select **Fit Height** to fit pages according to their height.
  - Select **Fit Visible** to view the entire page within the confines of the viewing area.
  - Alternatively, select an option from the list of numerical percentages to determine the magnification level.
- Use the **Open to Page** dropdown menu to determine the page at which documents open.

The **Window Options** are as follows:

- **Show in Title** determines the name displayed in the document tab when documents are opened. The options are **File Name** or **Document Title**.
- Select the **Open in Full Screen Mode** box to open documents in full screen mode.
- Select the **Resize Window to Initial Page** box to resize the viewing window according to the dimensions of the first page of the document.
- Select the **Center Window on Screen** box to center the viewing window on the monitor screen.

The **User Interface Options** are as follows:

- Select the **Hide Menu Bar** box to hide the **Menu** toolbar when documents are opened.
- Select the **Hide Window Controls** box to hide windows controls when documents are opened.
- Select the **Hide Toolbars** box to hide toolbars when documents are opened.

Click **OK** to save settings.

## Advanced

These settings determine advanced document properties:

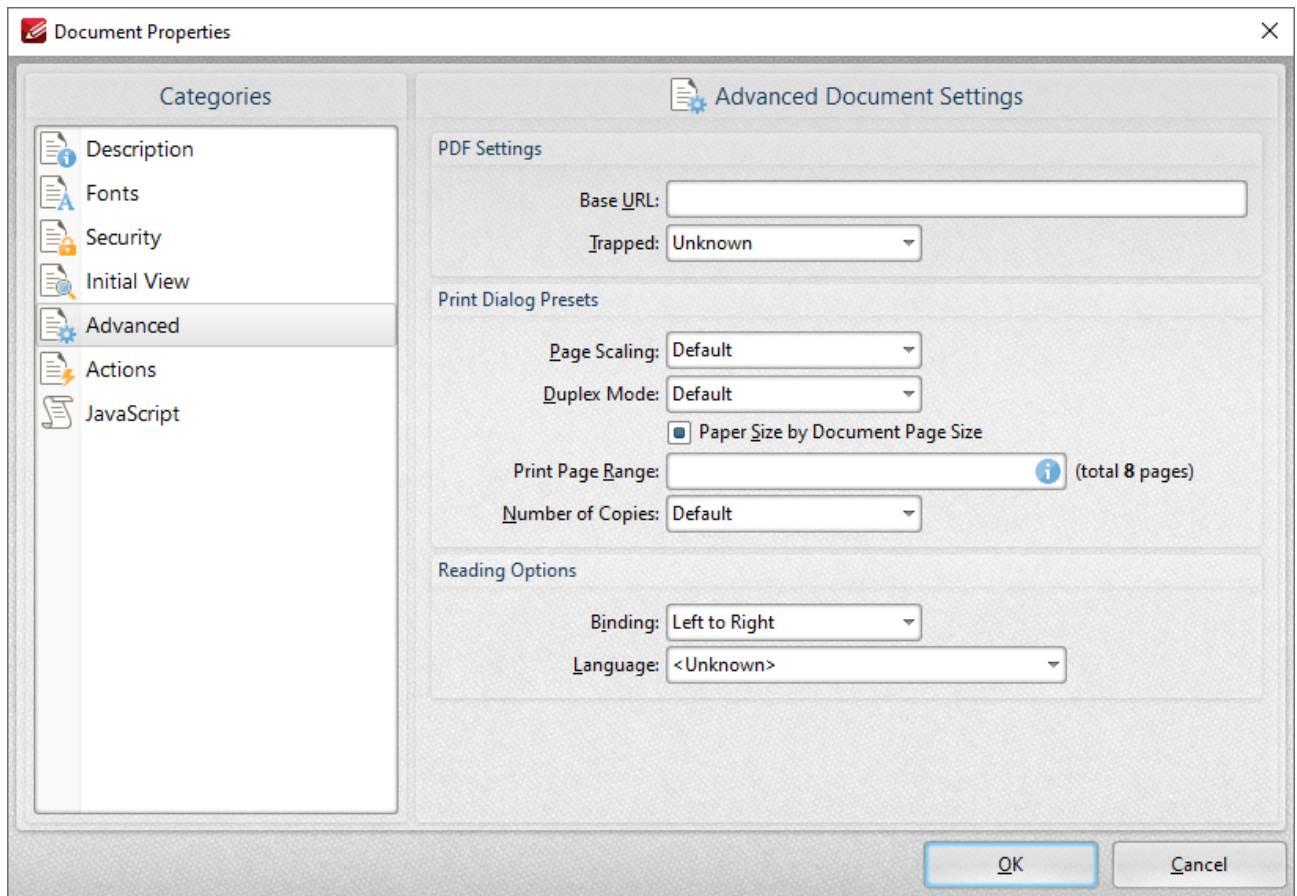

Figure 8. Document Properties Dialog Box, Advanced Option Selected

- The **PDF Settings** feature two parameters:
  - Enter a URL in the **Base URL** text box to specify a base URL for weblinks in documents. The option is included to simplify the management of web links to an external website. If the URL to the external site changes then this setting can be used to avoid having to edit manually every link in documents that refer to the external site. (Please note that the base URL is not used if a link contains a complete URL address).
  - The **Trapped** option determines trapping options with regard to printing. This is a complex process that aims to optimize the quality of printed documents. See [here](#) for further details.
- Select the **Print Dialog Presets** box to override the viewing application's default print settings with those specified within the file itself:
  - Select an option in the **Page Scaling** dropdown menu to determine the page scaling used:
    - **Default** retains the default settings.
    - **None** disables page scaling.
  - Select an option in the **Duplex Mode** dropdown menu to determine the default duplex mode for printing.

- Select the **Paper Size by document Page Size** box to use the size of the document pages to determine the paper size of the document.
  - Enter the pages to be printed in the **Print Page Range** text box. Further information on the specification of page ranges is available [here](#).
  - Use the **Number of Copies** dropdown menu to determine how many copies of the document are printed.
- 
- Select the **Reading Options** box to enable binding and language options:
    - Select either **Left to Right** or **Right to Left** as the document **Binding** option.
    - Select an option in the **Language** dropdown menu to determine the language of the document.

## Actions

These settings enable the activation of JavaScript commands when documents close/save/print:

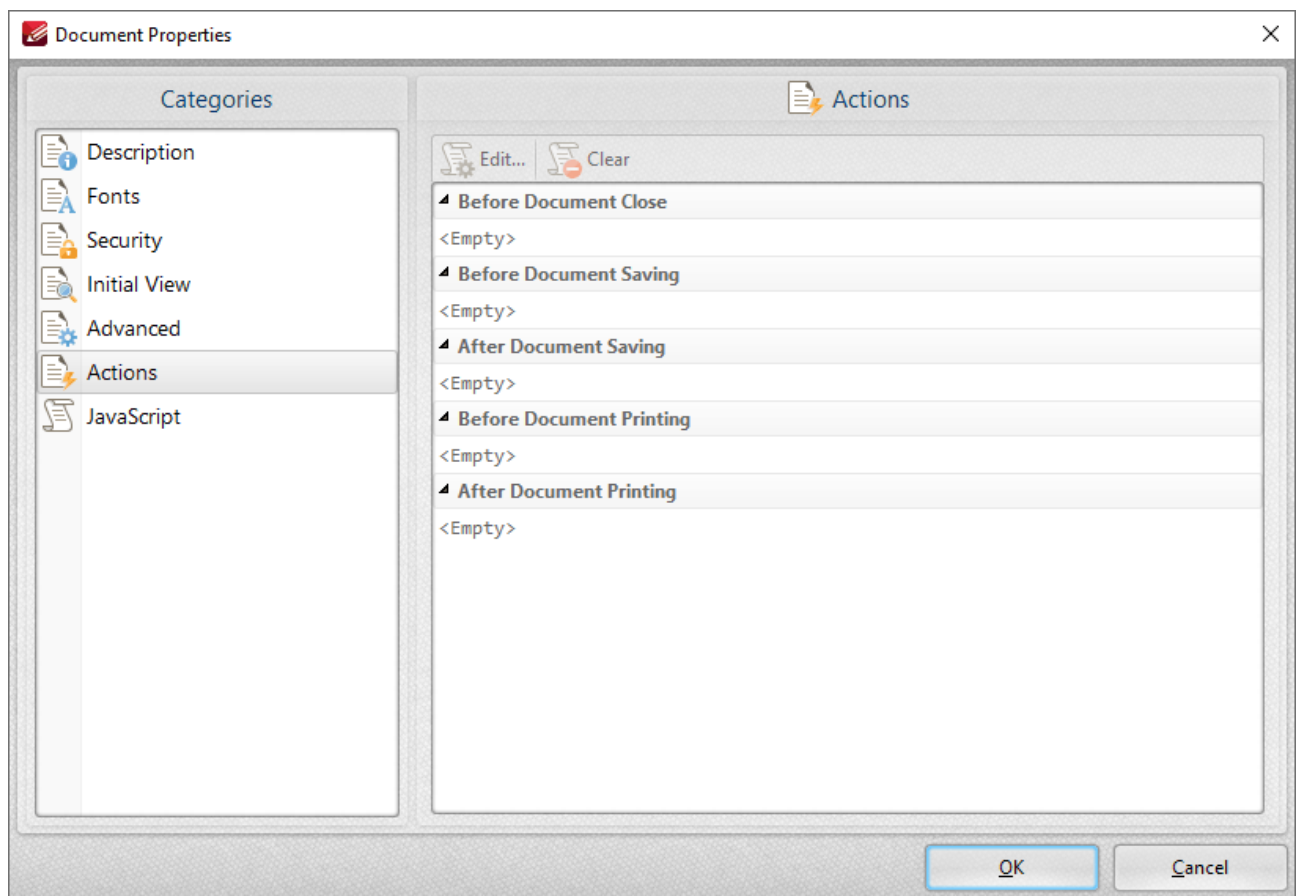

Figure 9. Document Properties Dialog Box, Actions Option Selected

These settings can be used to enable JavaScript commands when the following operations take place:

- **Before Document Close**

- Before Document Saving
- After Document Saving
- Before Document Printing
- After Document Printing

Double-click the text box beneath operations to add JavaScript, as detailed [here](#).<sup>963</sup>

Click **OK** to save settings.

## JavaScript

This option details JavaScript in the active document:

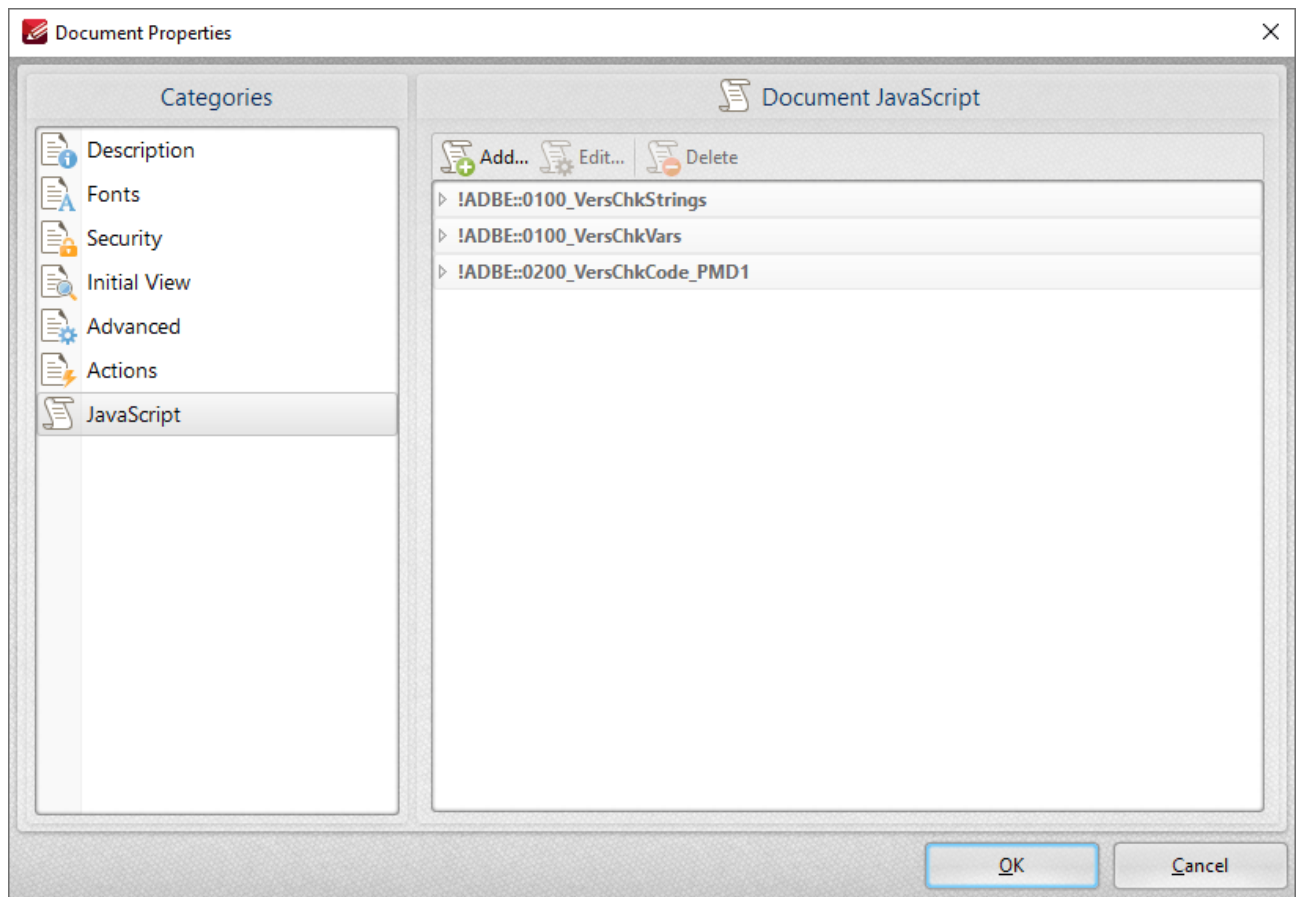

**Figure 10.** Document Properties Dialog Box, JavaScript Option Selected

JavaScript is a high-level programming language that can be used to perform a range of operations. Click **Add**, **Edit** or **Delete** to add/edit/delete JavaScript. See [here](#) for an index of existing JavaScript operations that **PDF-XChange Editor** supports and additional information about JavaScript.

## 10.4.1.8 Preferences



### Preferences

Click **Preferences** (or press Ctrl+K) to view/edit the **PDF-XChange Editor** preferences:

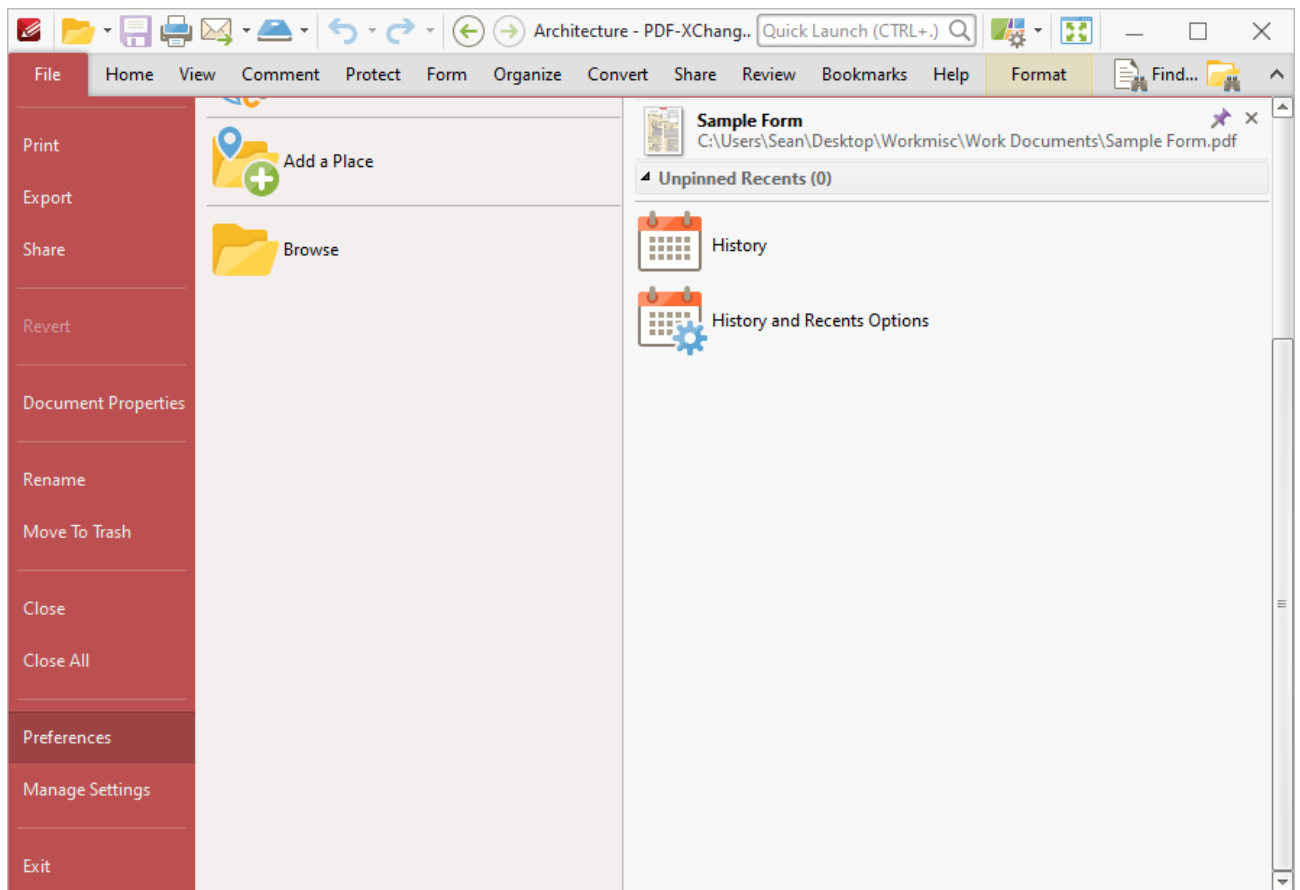

Figure 1. File Tab Submenu, Preferences

The **Preferences** dialog box will open:

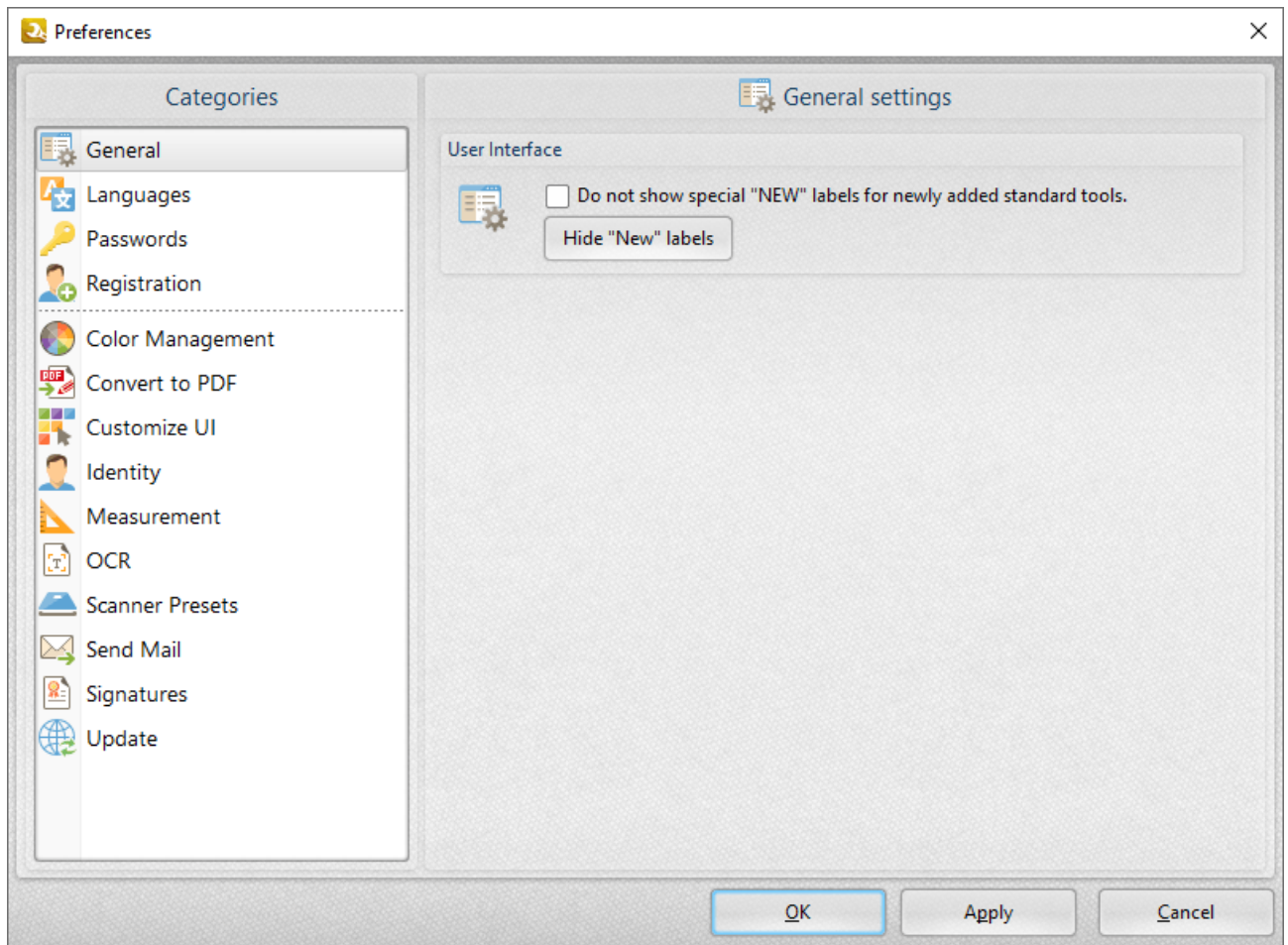





















Figure 2. Preferences Dialog Box

Use the options in the **Categories** pane to determine the settings of the associated section of the software. Click the links for further information:

- [Documents](#) <sup>857</sup>
- [General](#) <sup>860</sup>
- [Page Display](#) <sup>863</sup>
- [Page Text](#) <sup>867</sup>
- [Registration](#) <sup>869</sup>
- [Accessibility](#) <sup>871</sup>
- [Color Management](#) <sup>873</sup>
- [Commenting](#) <sup>875</sup>
- [Convert to/from PDF](#) <sup>877</sup>
- [Customize UI](#) <sup>879</sup>
- [Document Info Bar](#) <sup>881</sup>
- [File Associations](#) <sup>883</sup>
- [Forms](#) <sup>885</sup>
- [Full Screen](#) <sup>887</sup>

- [Identity](#)  889
  - [JavaScript](#)  891
  - [Languages](#)  893
  - [Launch Applications](#)  895
  - [Measurement](#)  898
  - [Multimedia 3D](#)  902
  - [OCR](#)  904
  - [Performance](#)  906
  - [Places](#)  908
  - [Plugins](#)  910
  - [Scanner Presets](#)  912
  - [Search Providers](#)  914
  - [Security](#)  916
  - [Send Mail](#)  919
  - [SharePoint](#)  921
  - [Signatures](#)  922
  - [Snapshot Tool](#)  926
  - [Speech](#)  928
  - [Tools](#)  930
  - [Update](#)  932
-



## 10.4.1.8.1 Documents



## Documents

When the **Documents** tab is selected the following options are available:

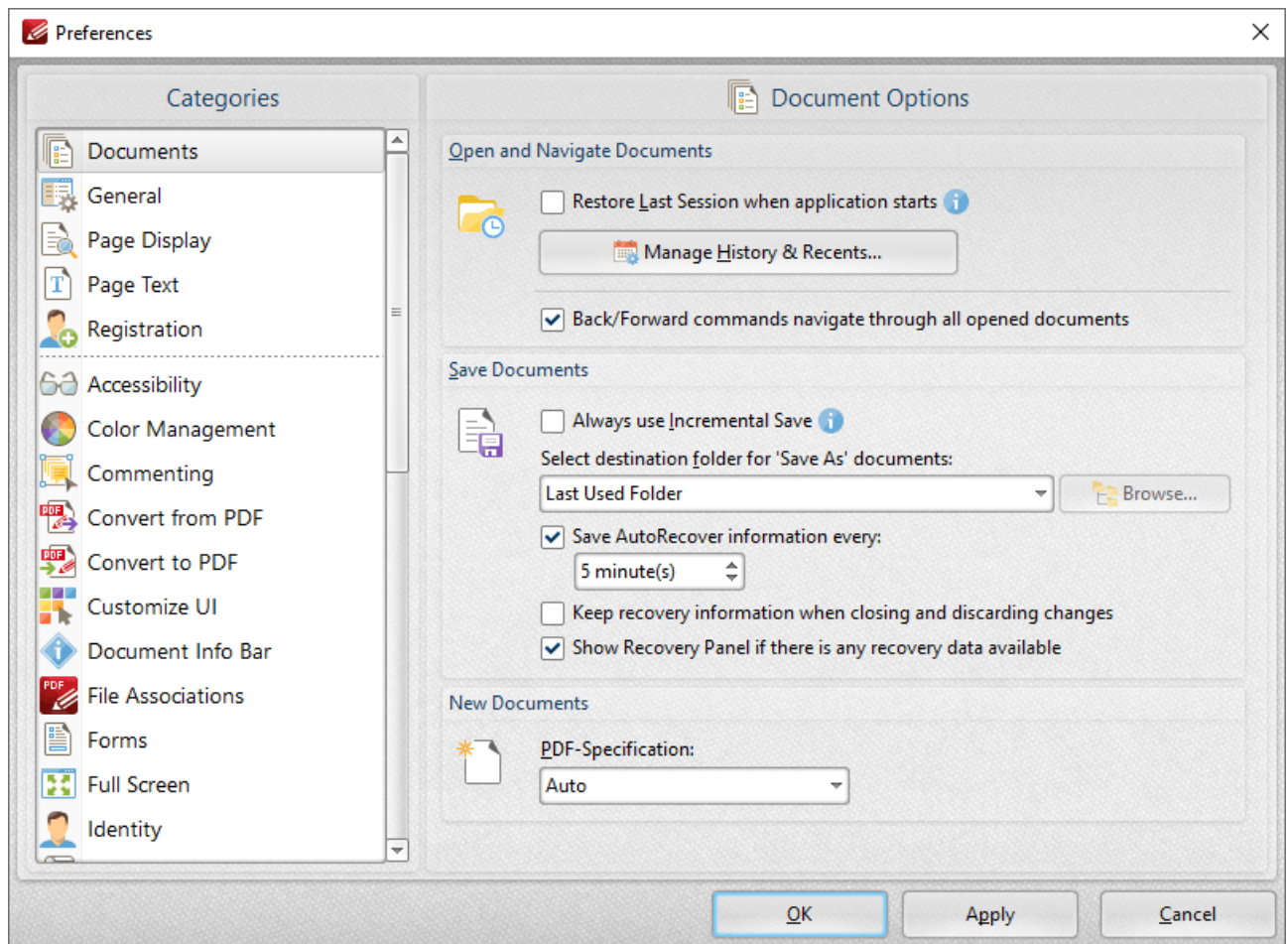

Figure 1. Preferences Dialog Box, Documents Tab Selected

- Select the **Restore Last Session when application starts** box to restore the most recent session when **PDF-XChange Editor** is launched.
- Click **Manage History and Recents** to manage settings for the history of open documents in **PDF-XChange Editor**. The **Manage History and Recents** dialog box will open. See **(figure 2)** below.

- Select the **Back/Forward commands navigate through all opened documents** dialog box to include all open documents when the back/forward navigation commands are used. If this box is not selected then **PDF-XChange Editor** will navigate through the views of only the active document when these commands are used.
- Select the **Always use Incremental Save** dialog box to enable incremental save. **PDF-XChange Editor** will remember the original content of the document when this option is enabled, and will store information about all new changes. This should reduce the amount of time taken to save files, but please note that the size of files will increase each time a save operation is performed.
- Use the **Select destination folder for 'Save As' documents** dropdown menu to determine the folder in which documents are saved when the 'Save As' option is used.
- Select the **'Save Autorecover information every'** box to enable the saving of autorecovery information, which is useful in the event of software crashes or when documents are closed without changes having been saved. Use the number box to determine the interval at which autorecovery information is saved.
- Select the **Keep recovery information when closing and discarding changes** box as desired.
- Select the **Show Recovery Panel if there is any recovery data available** to launch the **Document Recovery Panel** whenever there is recovery data available.
- Use the **PDF-Specification** dropdown menu to determine the PDF specification of documents created in **PDF-XChange Editor**.

Click **Apply** to apply changes and **OK** to save changes.

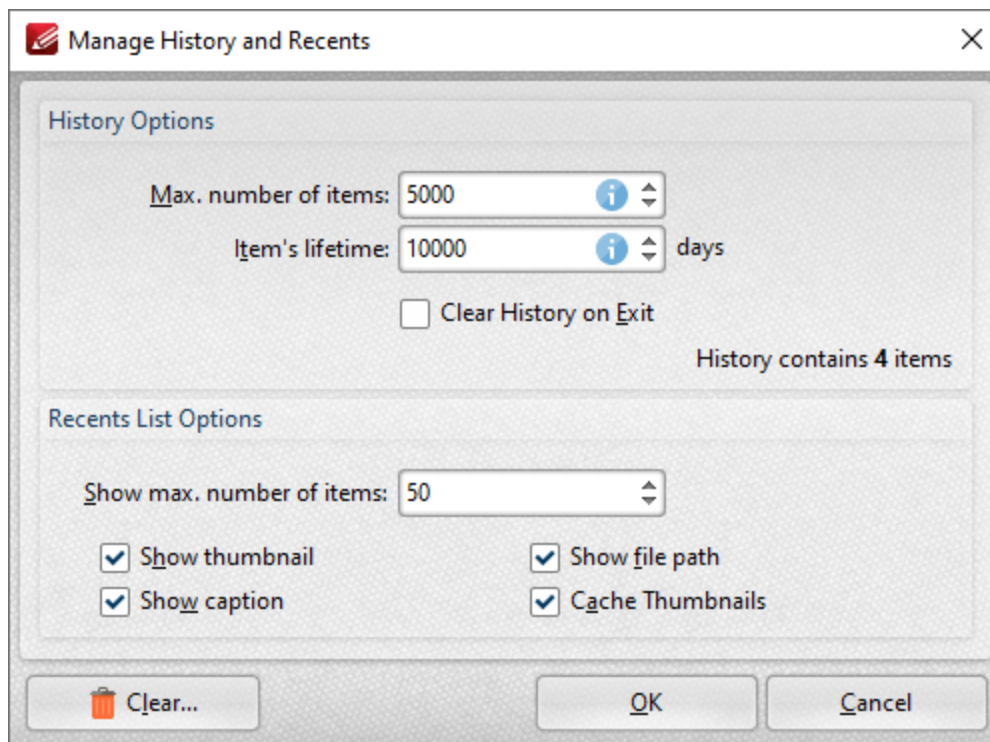

Figure 2. Manage History and Recents Dialog Box

- Use the **Max. number of items** number box to determine the maximum number of files stored in the history of **PDF-XChange Editor**.
- Use the **Item's lifetime** number box to determine the lifetimes of items in the file history list.
- Use the **Show max. number of items** number box to determine the maximum number of items in the **Recents** lists.
- Use the check boxes to determine the elements of files that are displayed in the list.
- Click **Clear** to remove items from the history list.

Click **OK** to save changes.

---

## 10.4.1.8.2 General

**General**

When the **General** tab is selected the following options are available:

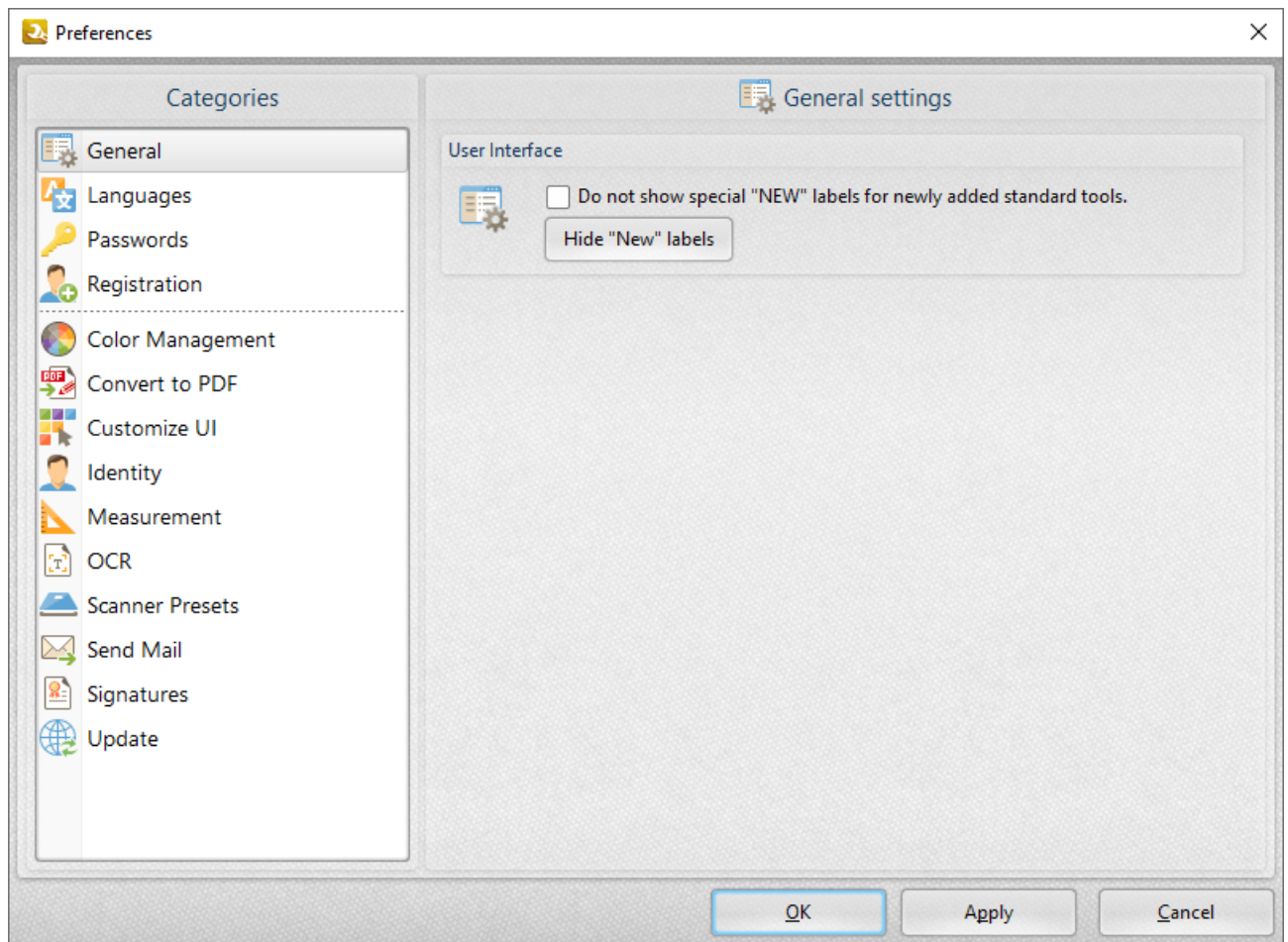

**Figure 1.** Preferences Dialog Box, General Tab Selected

- Click **Setup** to determine the tabs and windows settings in **PDF-XChange Editor**. These options are detailed beneath (**figure 2**).
- Click **Reset** to reset the prompts and warning message dialog boxes in **PDF-XChange Editor**.
- Use the **UI Scaling** dropdown menu to set the UI scale used for monitors when you are switching between screens that have different resolution settings. Note that if **No Scale** is

selected then **PDF-XChange Editor** will use the **DPI** of the default screen and will not scale between monitors.

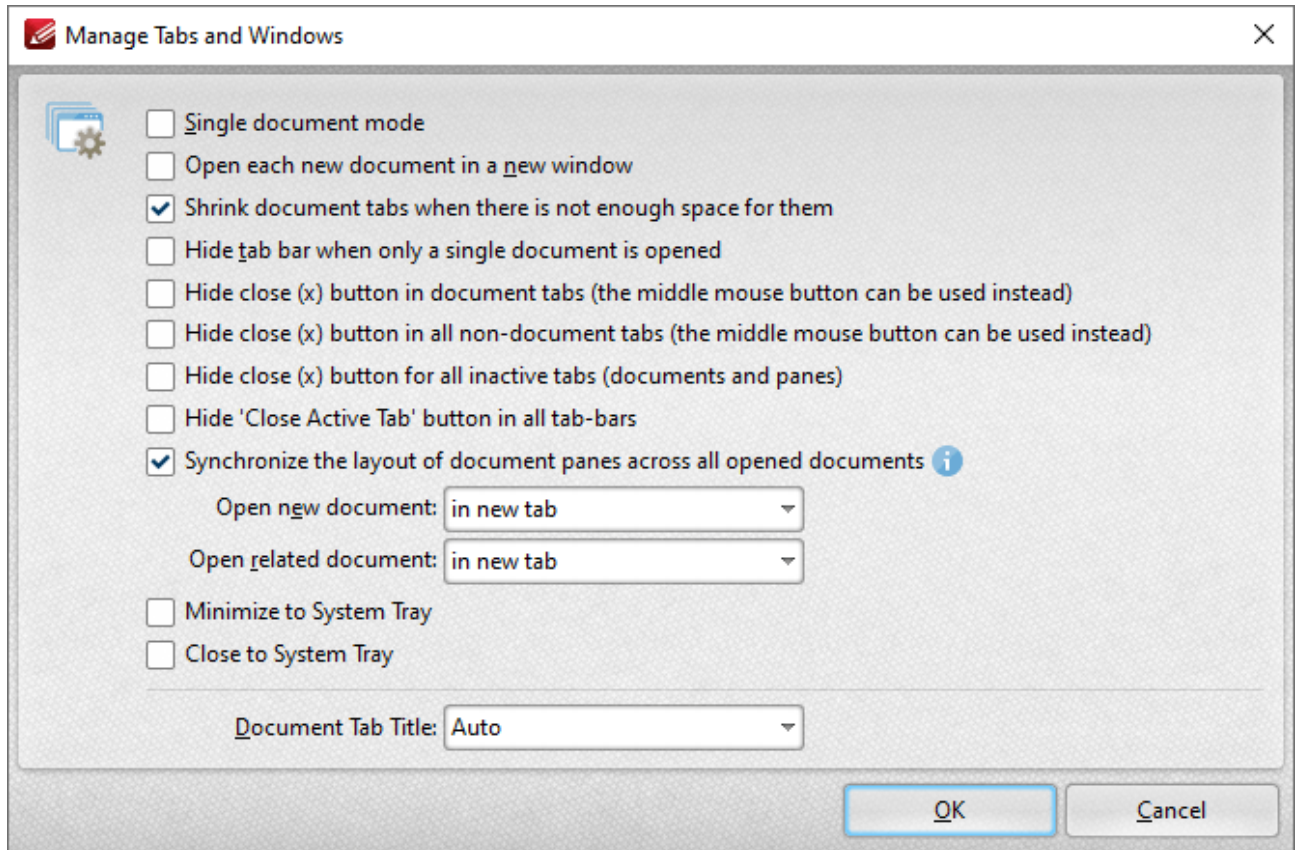

Figure 2. Manage Tabs and Windows Dialog Box

- Select the **Single document mode** box to enable single document mode, which means that only one document can be open at a time.
- Select the **Open each document in a new window** box to open each new document in a new **PDF-XChange Editor** window.
- Select the **Shrink document tabs when there is not enough space for them** box to shrink the size of document tabs when there are multiple tabs open and not enough space to display the names of all open files.
- Select the **Hide tab bar when only a single document is opened** box to hide the tab bar when only one document is open and maximize the workspace area.
- Select the **Hide close (x) button in document tabs** box to hide the close document button in document tabs. Click the mouse wheel to close documents when this option is enabled.
- Select the **Hide close (x) button in all non-document tabs** box to hide the close button in non-document tabs such as the **Thumbnails** and **Bookmarks** panes. Click the mouse wheel to close panes when this option is enabled.
- Select the **Hide close (x) button for all inactive tabs** box to hide the close document button for inactive document tabs.

- Select the **Hide 'Close Active Tab' button in all tab-bars** to hide the close active tab button for all tabs.
- Select the **Synchronize the layout of document panes across all opened documents** box to synchronize the layout of [Editing Panes](#)<sup>[892]</sup> for all open documents.
- Use the **Open new document** dropdown menu to determine the tab location at which new documents are opened:
  - Select **in new tab** to open new documents in a new tab on the document toolbar.
  - Select **in new adjacent tab** to open new documents in a new tab adjacent to the tab of the current document in the document toolbar.
- Use the **Open related document** dropdown menu to determine the location at which documents related to the current document, such as attachments and linked documents, are opened:
  - Select **in new tab** to open related documents in a new tab on the document toolbar.
  - Select **in new adjacent tab** to open related documents in a new tab adjacent to the tab of the current document in the document toolbar.
  - Select **in the same tab** to open related documents in the same tab as the current document. Please note that if this option is selected then the current document is closed when related documents are opened.
- Select the **Minimize to System Tray** box to minimize **PDF-XChange Editor** to the system tray when the minimize option is used.
- Select the **Close to System Tray** box to close **PDF-XChange Editor** to the system tray when the close option is used.
- Use the **Document Tab Title** dropdown menu to determine the name of the document as displayed in the tab title:
  - Select **Auto** to allow **PDF-XChange Editor** to select the document tab title automatically.
  - Select **Document Title** to use the document title as defined in the [Document Properties](#)<sup>[843]</sup>.
  - Select **Document filename** to use the document filename.

Click **OK** to save changes.

---

## 10.4.1.8.3 Page Display



## Page Display

When the **Page Display** tab is selected the following dialog box is displayed:

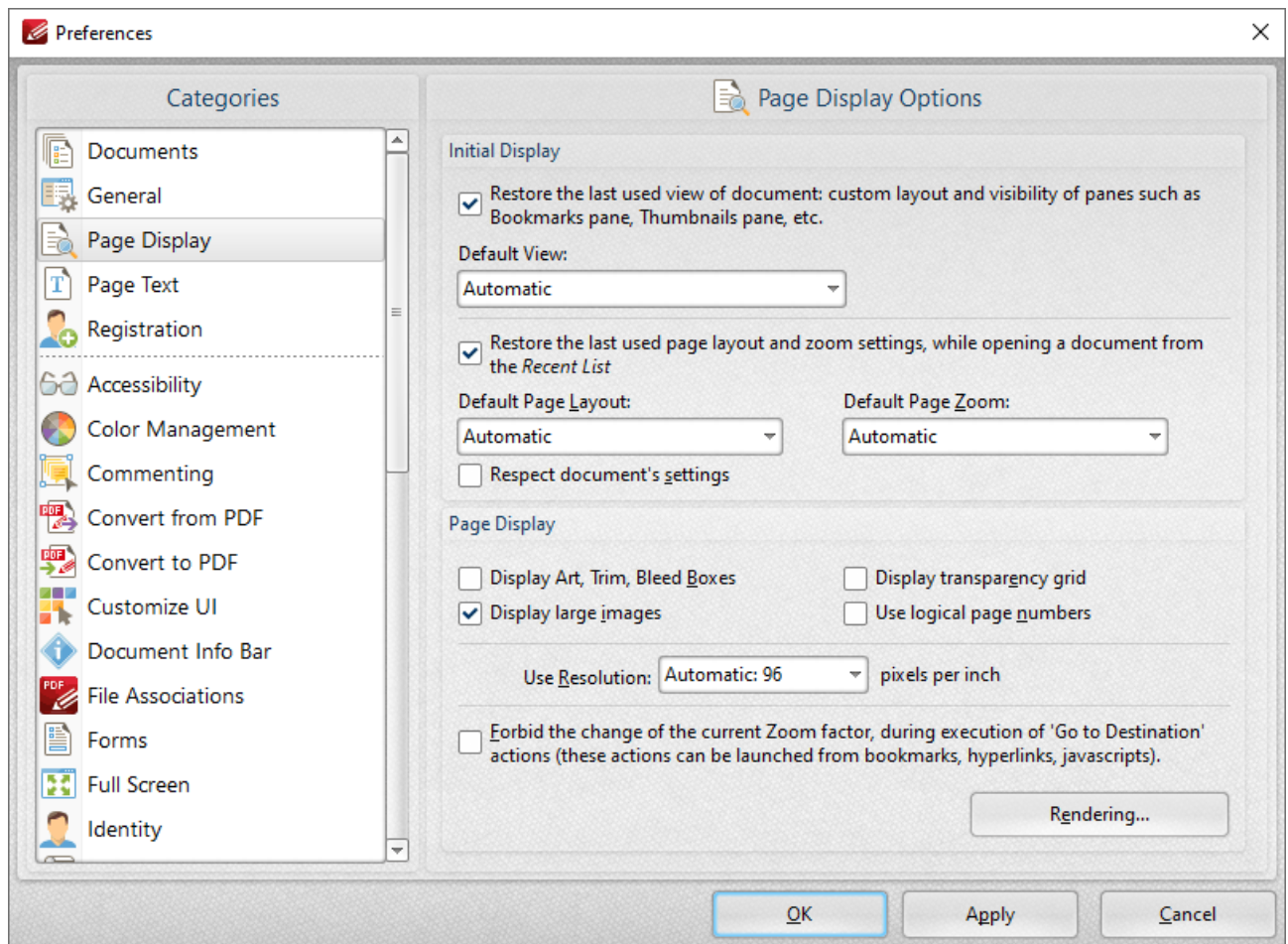

Figure 1. Preferences Dialog Box, Page Display Tab Selected

- The **Initial Display** settings determine the layout of documents when they are opened:
  - Select the upper check box to restore the most recent display settings. Please note that the **Crop Pages** <sup>1484</sup> settings can be used to determine page boxes.
  - Use the **Default View** menu to select the default viewing parameters for documents.

- Select the middle check box to retain the most recently used page layout and zoom settings when recent document are opened.
- Use the **Default Page Layout** and **Default Page Zoom** dropdown menus to determine the default layout and zoom settings.
- Select the lower check box to override the settings determined in this section with the existing settings of documents.
- The **Page Display** settings determine what is displayed on the active page:
  - Select the required check boxes. Please note that the **Crop Pages**<sup>1484</sup> feature can be used to define the **Art, Trim** and **Bleed Boxes**.
  - Select an option from the **Use Resolution** menu to determine the viewing resolution.
  - Select the indicated check box to disable zoom settings when **'Go to Destination'**<sup>965</sup> actions are launched.
  - Click the **Rendering** button to determine the rendering settings. The following dialog box will open:

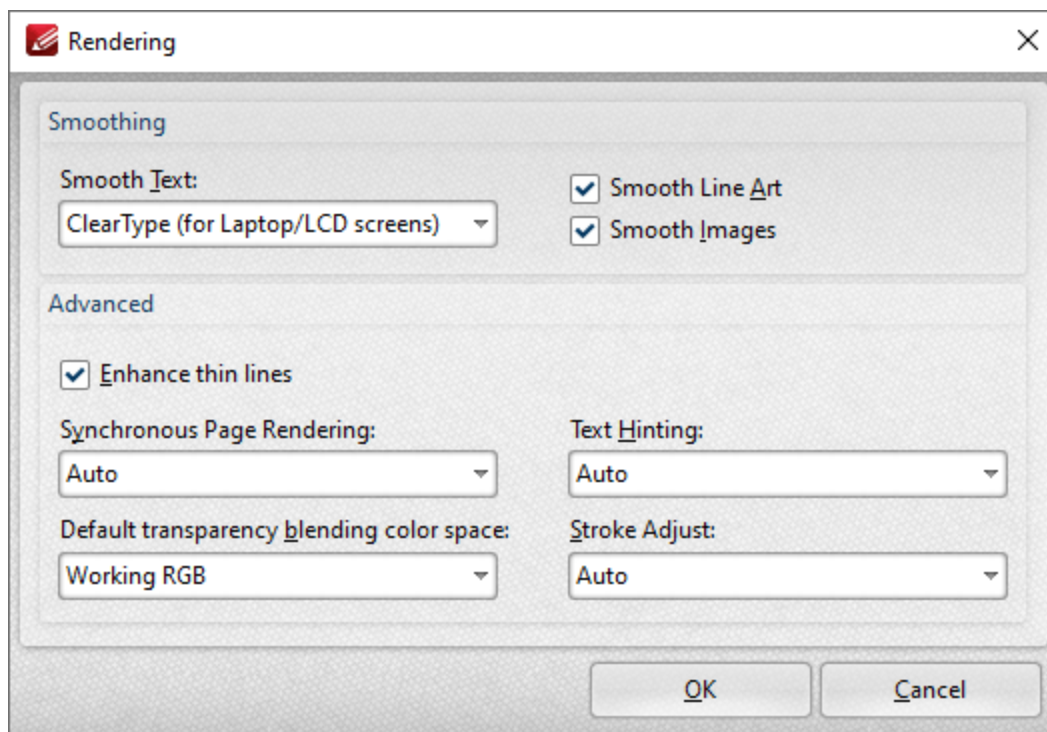

Figure 2. Rendering Dialog Box

- The **Smoothing** options are used to smooth PDF content and create a softer appearance:
  - Select the desired format for smoothing text.
  - Select the **Smooth Line Art** and **Smooth Images** boxes as desired.
  - Please note that some fine detail may be lost as a result of using these options.
- The **Advanced** options determine advanced display settings for color modes and objects:



- Select the **Enhance thin lines box** to repair instances of blurring that may occur when using metric measurements such as point (pt).
- Use the **Synchronous page rendering** menu to define the page rendering method:
  - Select **No** to disable synchronous page rendering. If this option is selected then rendering results are displayed when they are complete. Page scrolling is always smooth when this option is selected, but some pages may be blank initially. This option is best for heavy documents that contain a lot of content, as it ensures that **PDF-XChange Editor** remains fully responsive at all times.
  - Select **Yes** to enable synchronous page rendering. If this option is selected then the page view in **PDF-XChange Editor** will wait until the content of all visible pages is rendered before displaying it on the screen. Pages will not be blank initially, but page scrolling will not always be smooth – especially on pages that contain a significant amount of content. This option is best for light documents – for example documentation that contains predominantly text and a small amount of images.
  - Select **Auto** to combine the benefits of synchronous and asynchronous rendering. If the rendering time is small – for example in light documents – then **PDF-XChange Editor** operates with synchronous rendering enabled. However, if the rendering time exceeds a given threshold, then it will switch to asynchronous rendering. This means that no pages will be displayed as blank initially for light documents, and that page scrolling is always smooth for heavy documents.
- Use the **Default transparency blending color space** menu to select the default color space for transparency blending:
  - **Auto** uses RGB color when there is no transparency between intersecting objects and CMYK in cases of transparency.
  - **Working RGB** uses only RGB color space.
  - **Working CMYK** uses only CMYK color space and converts it to RGB when displayed on-screen.
  - **Working Grayscale** uses only grayscale when rendering.
- Use the **Text Hinting** menu to enable/disable text hinting, or set this feature to **Auto** as desired. Text hinting adjusts the display of outline fonts to make them line up with a rasterized grid.
- Use the **Stroke Adjust** menu to enable/disable the stroke adjust feature. Stroke adjust specifies that the line widths and coordinates of strokes are adjusted automatically to produce strokes of uniform thickness. This is performed in order to compensate for the effects of rasterization and fit lines (and other figures) more precisely to the pixel grid of monitors and other displays. The width will be as near as possible to the requested line width, and no more than half a pixel in difference. Please note that disabling **Smooth Line Art** when stroke adjust is enabled will have a negative effect on image quality.
  - **On** forces the use of stroke adjust in all cases.
  - **Off** disables the use of stroke adjust.
  - **Auto** determines the use of stroke adjust according to the content of the file. Note that stroke adjust is not specified in most cases, and the default value is **On**.

Click **OK** to save changes.

---

## 10.4.1.8.4 Page Text



## Page Text

When the **Page Text** tab is selected the following options are available:

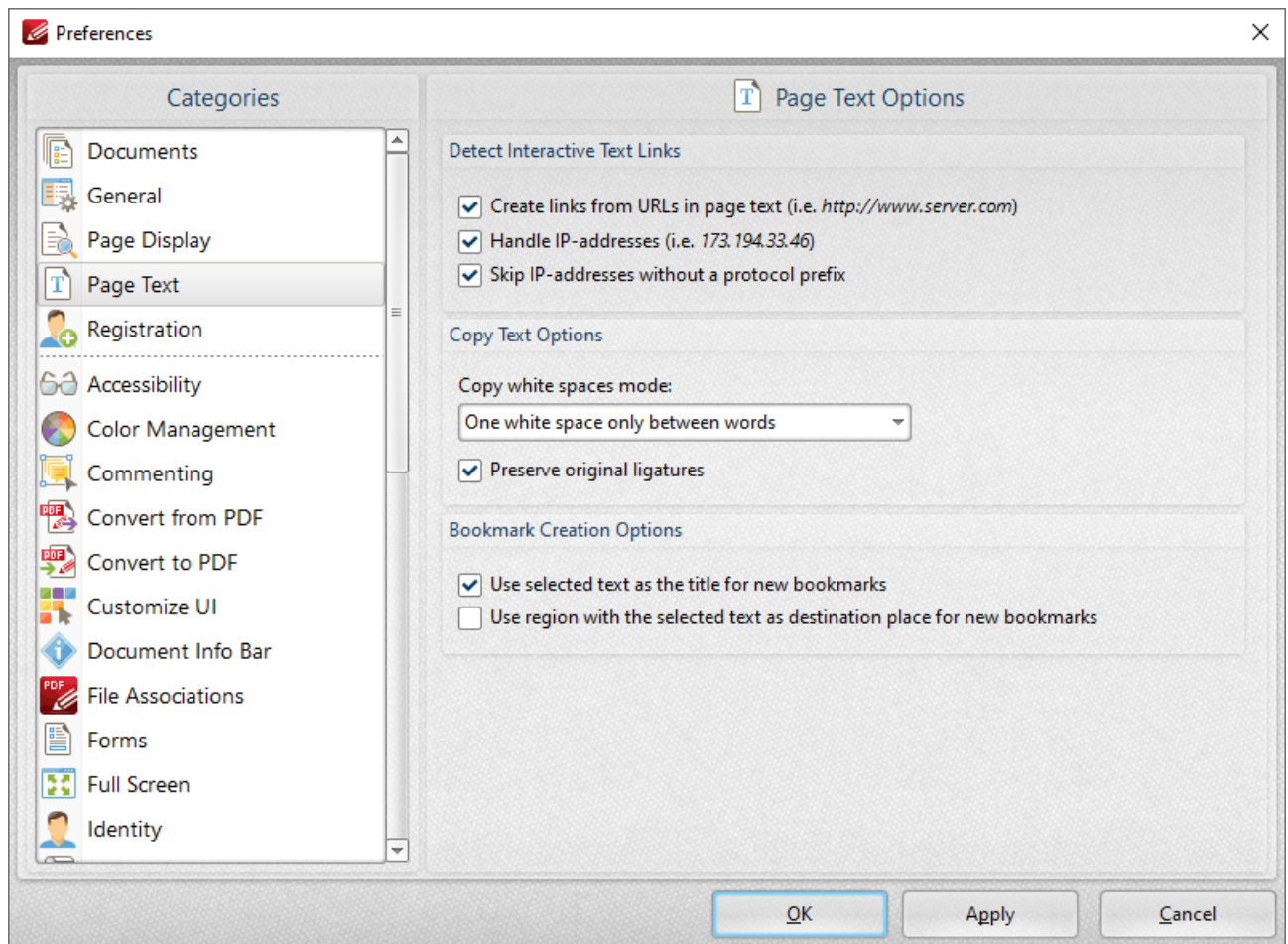

Figure 1. Preferences Dialog Box, Page Text Tab Selected

- Select the **Detect Interactive Text Links** check boxes as desired to determine the parameters for interactive text.
- Select an option from the **Copy white spaces mode** dropdown menu to determine the outcome when white space is copied.

- Select the **Preserve original ligatures** box to preserve original ligatures. (Ligatures occur when letters are joined as single glyphs, such as the "æ" grapheme in English). If this box is cleared then ligatures will be created from individual letters instead.
- Use the check boxes in the **Bookmark Creation Options** section to determine text settings when bookmarks are created.

Click **Apply** to apply changes and **OK** to save changes.

---

## 10.4.1.8.5 Registration

**Registration**

When the **Registration** tab is selected the following options are available:

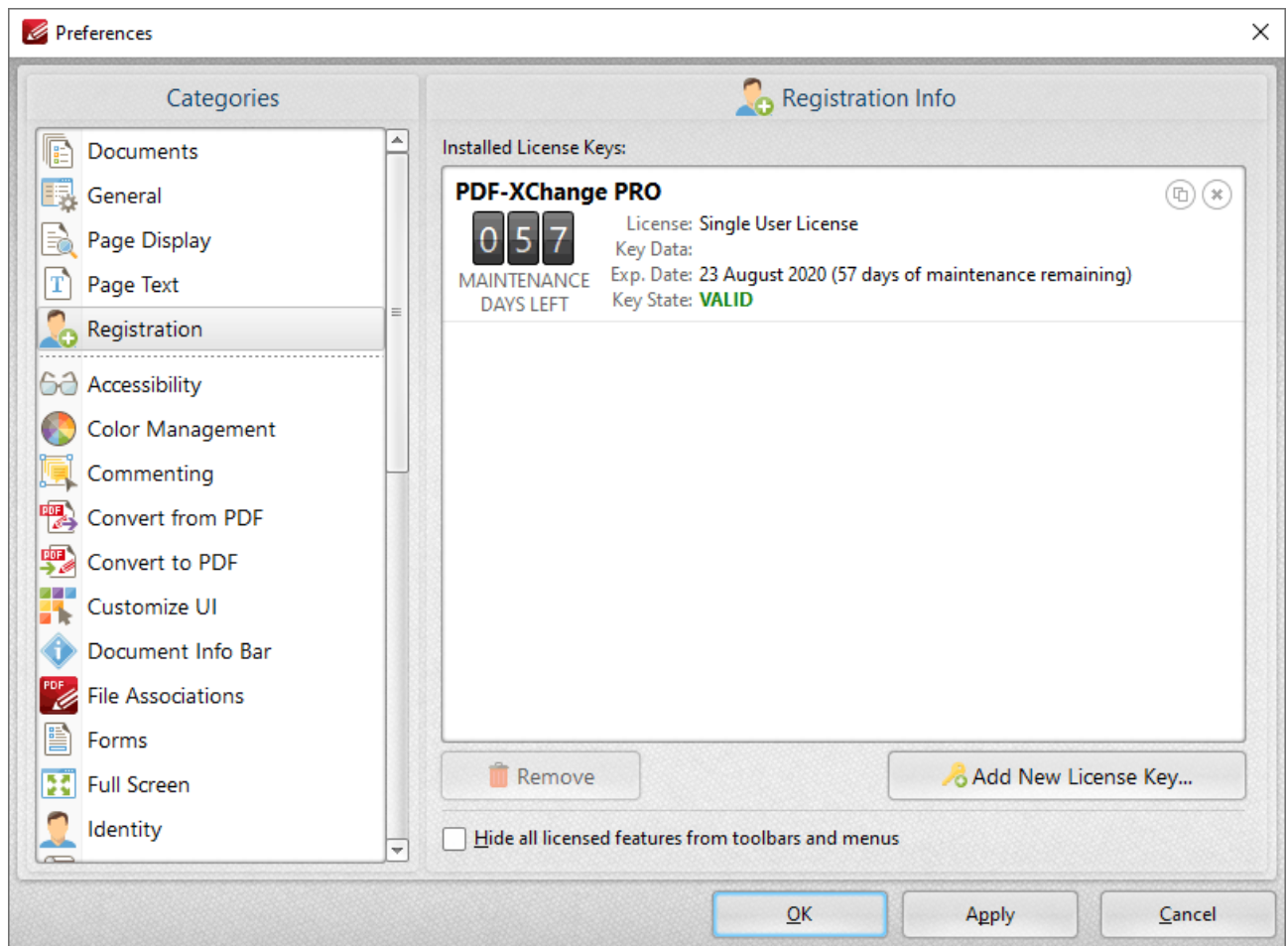

**Figure 1.** Preferences Dialog Box, Registration Tab Selected

The **Registration** tab is used to register/edit license keys for **PDF-XChange Editor**. Current versions and their details are displayed in the **Installed License Keys** pane.

- Click **Add New License Key** to add new license keys.
- Click **Remove** to remove current license keys.

- Select the **Hide all licensed features from toolbars and menus** box to remove licensed features from the free version of **PDF-XChange Editor**.

Click **Apply** to apply changes and **OK** to save changes.

---

## 10.4.1.8.6 Accessibility

**Accessibility**

When the **Accessibility** tab is selected the following options are available:

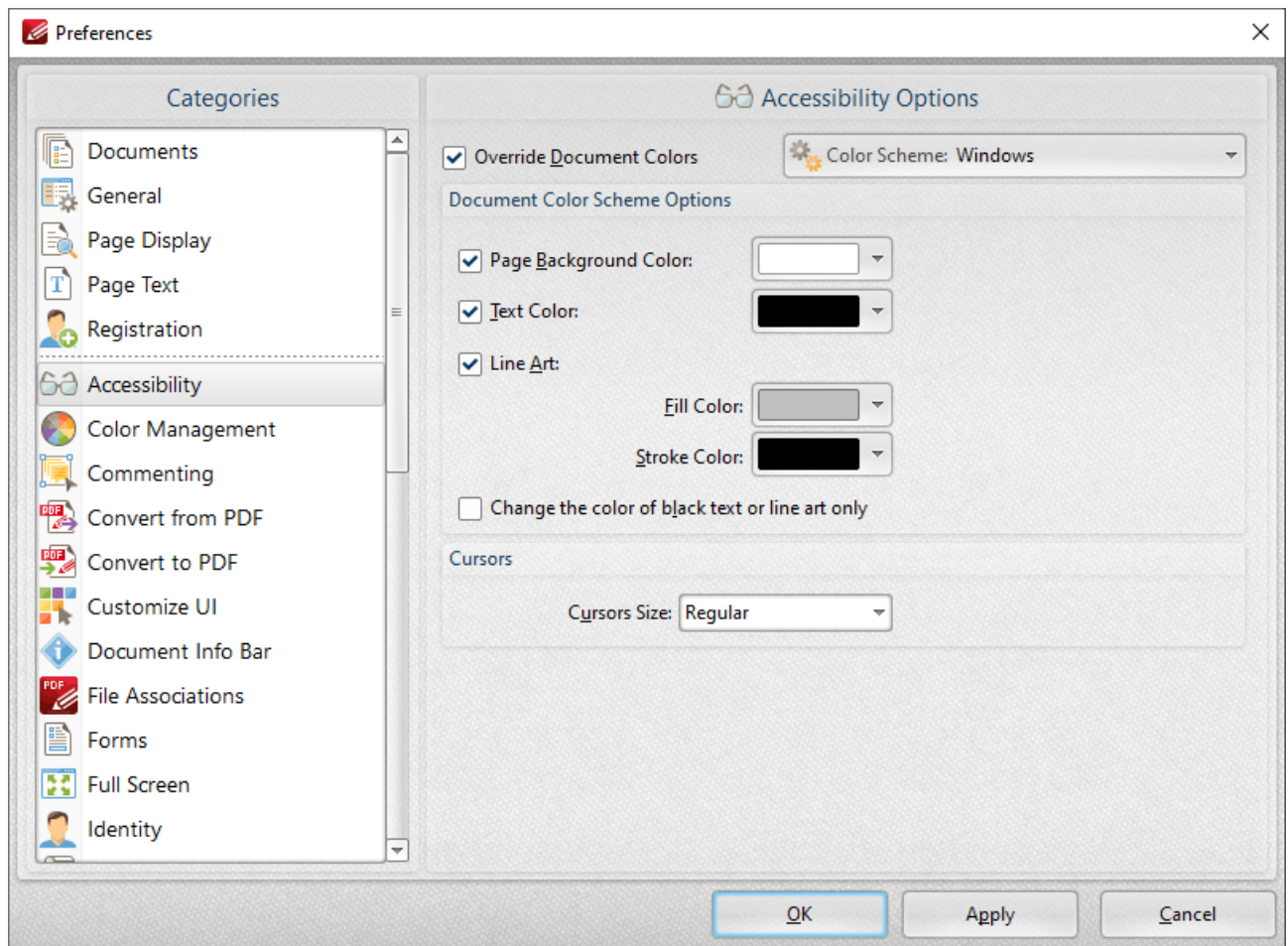

**Figure 1.** Preferences Dialog Box, Accessibility Tab Selected

The **Accessibility** tab is used to control the color options of PDF documents.

- Select the **Override Document Colors** box to enable further options.
- Use the **Page Background Color/Text Color** dropdown menus to determine the page background/text color.

- Use the **Line Art** dropdown menus to determine the **Fill Color** and **Stroke Color** used for line art.
- Select the **Change the color of black text or line art only** box to apply changes to only black text/line art.
- Use the **Cursors Size** dropdown menu to change the size of the cursors in **PDF-XChange Editor**.

Click **Apply** to apply changes and **OK** to save changes.

---



## 10.4.1.8.7 Color Management

**Color Management**

When the **Color Management** tab is selected the following options are available:

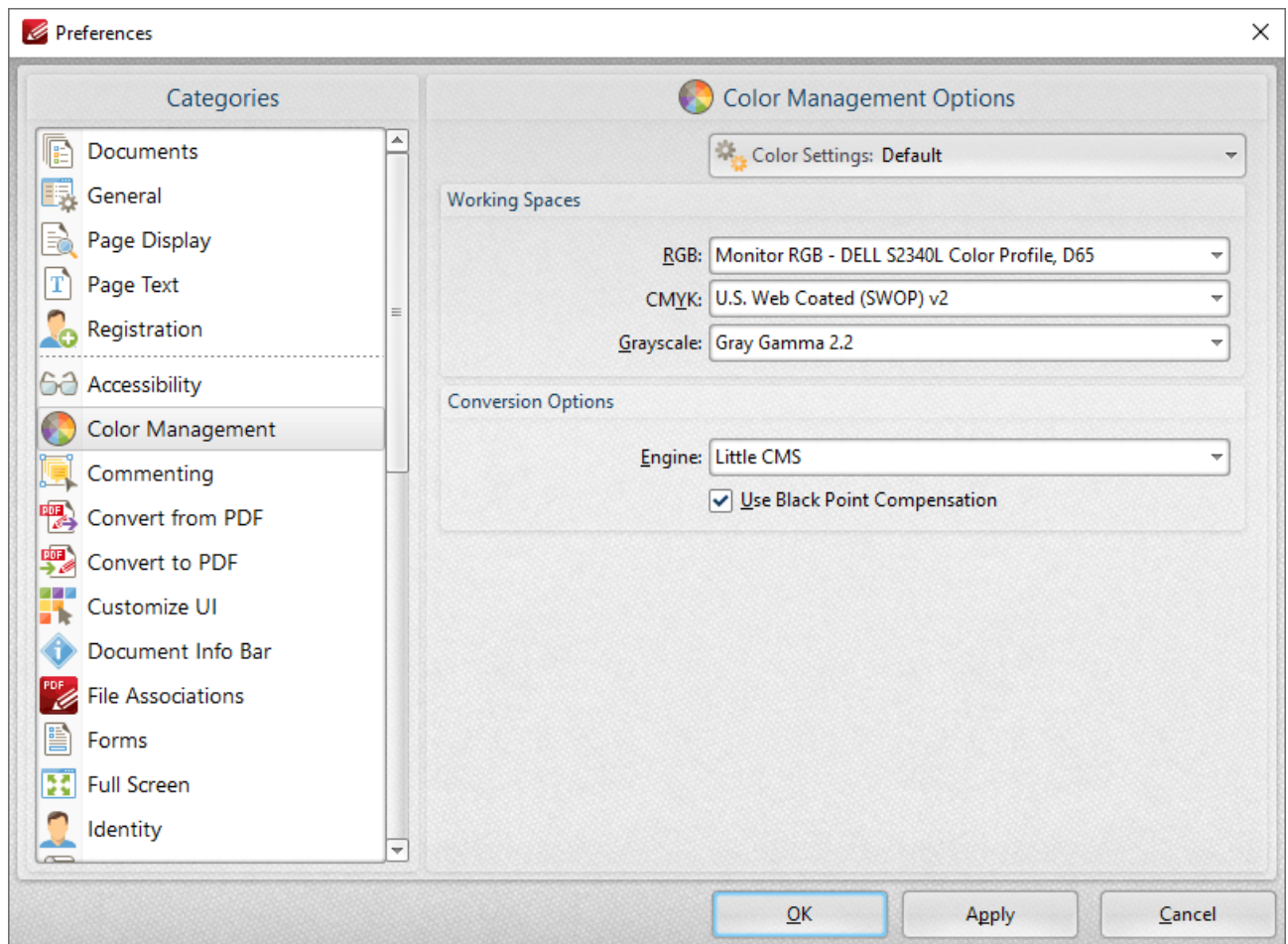

**Figure 1.** Preferences Dialog Box, Color Management Tab Selected

- The **Color Settings** dropdown menu is used to store and manage customized color profiles. Use this menu to save settings when they have been adjusted using the options detailed below.
- Use the **RGB**, **CMYK** and **Grayscale** dropdown menus to determine the settings for these color modes.
- Use the **Engine** dropdown menu to determine the engine used for color management.

- Select the **Use Black Point Compensation** box to enable black point compensation, which is a technique used in digital photography printing for the creation of adjustments between the maximum black levels of digital files and the black capabilities of digital devices.

Click **Apply** to apply changes and **OK** to save changes.

---

## 10.4.1.8.8 Commenting



## Commenting

When the **Commenting** tab is selected the following options are available:

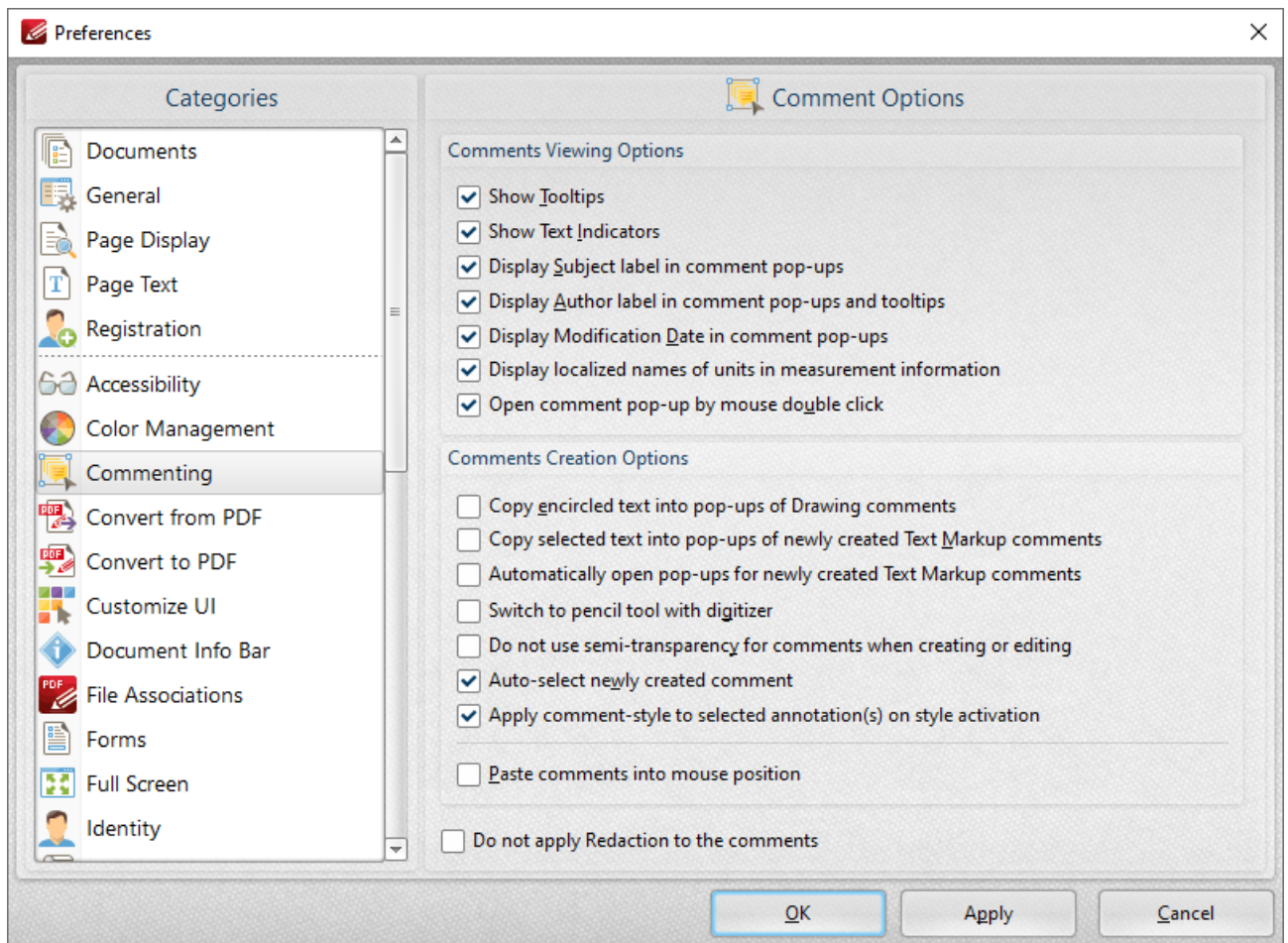



Figure 1. Preferences Dialog Box, Commenting Tab Selected

These options determine the settings for comments:

- Select the boxes in the **Comments Viewing Options** section to determine options for displayed comments.

- Select the **Copy encircled text into Drawing comment pop-ups** box as desired. This setting is used in conjunction with the shape annotations. Text that new shape annotations encircle is automatically added into their pop-up note when this setting is enabled.
- Select the **Copy selected text into Highlight, Cross-Out, and Underline comment pop-ups** box as desired. Text that the **Highlight**, **Strikeout** and **Underline Text** tools are used to annotate will automatically be copied into their pop-up note when this setting is enabled.
- Select the **Switch to pencil tool with digitizer** box as desired.
- Select the **Do not use semi-transparency for comments when creating or editing** box as desired.
- Select the **Auto-select newly created comment** box as desired.
- Select the **Apply comment-style to selected annotation(s) on style activation** box as desired.
- Select the **Paste Comment into mouse position** box to paste copied comments at the current pointer location.
- Select the **Do not apply Redaction to the comments** box to exclude comments when the [Redaction](#)  feature is used.

Click **Apply** to apply changes and **OK** to save changes.

---

10.4.1.8.9 Convert to/from PDF



Convert to/from PDF

Convert to PDF

When the **Convert to PDF** tab is selected the following options are available:

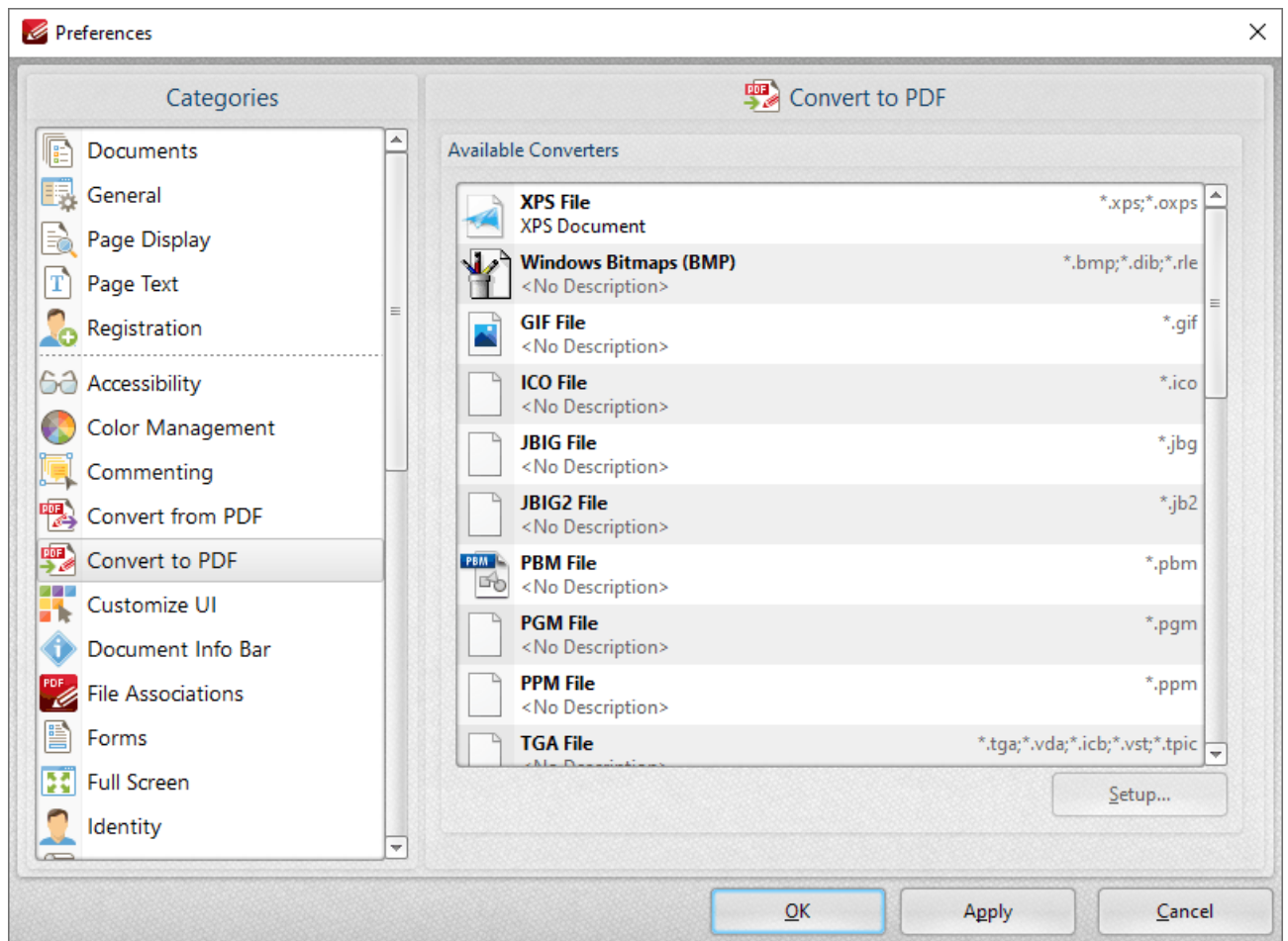

Figure 1. Preferences Dialog Box, Convert to PDF Tab Selected

This option shows the file formats that can be converted to PDF format. If selected formats have further options then the **Setup** button will be enabled.

## Convert from PDF

The options in the **Convert from PDF** tab are the same as those detailed above, but they are used when converting from PDF format.

Click **Apply** to apply changes and **OK** to save changes.

---

## 10.4.1.8.10 Customize UI

**Customize UI**

When the **Customize UI** tab is selected the following options are available:

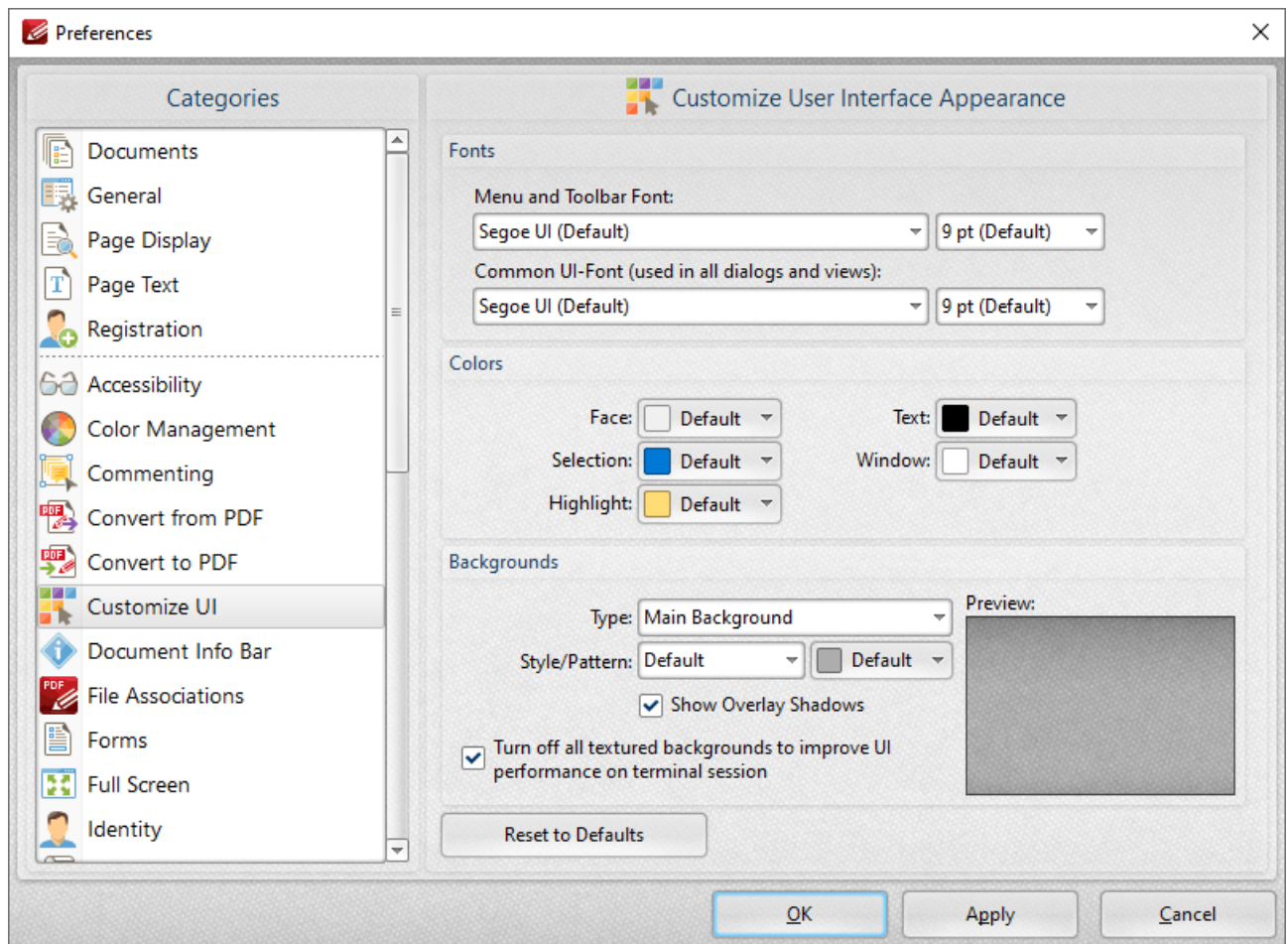

**Figure 1.** Preferences Dialog Box, Customize UI Tab Selected

These settings determine the appearance of the user interface:

- Use the menus in the **Fonts** section to determine the font style and size for menus, toolbars and dialog boxes.
- Use the menus in the **Colors** section to determine the colors of the UI.

- Use the menus in the **Backgrounds** section to determine the UI display for backgrounds:
  - Use the **Type** menu to select the background to customize.
  - Use the **Style/Pattern** menus to select the style and color of the selected background.
  - Select the **Show Overlay Shadows** box as desired.
  - Select the **Turn off all textured backgrounds to improve UI performance on terminal session** box as desired.
  - Click **Reset to Defaults** to reset all UI customization.

It is also possible to customize toolbars in **PDF-XChange Editor**, as detailed [here](#).

Click **Apply** to apply changes and **OK** to save changes.

---



10.4.1.8.11 Document Info Bar



Document Info Bar

When the **Document Info Bar** tab is selected the following options are available:

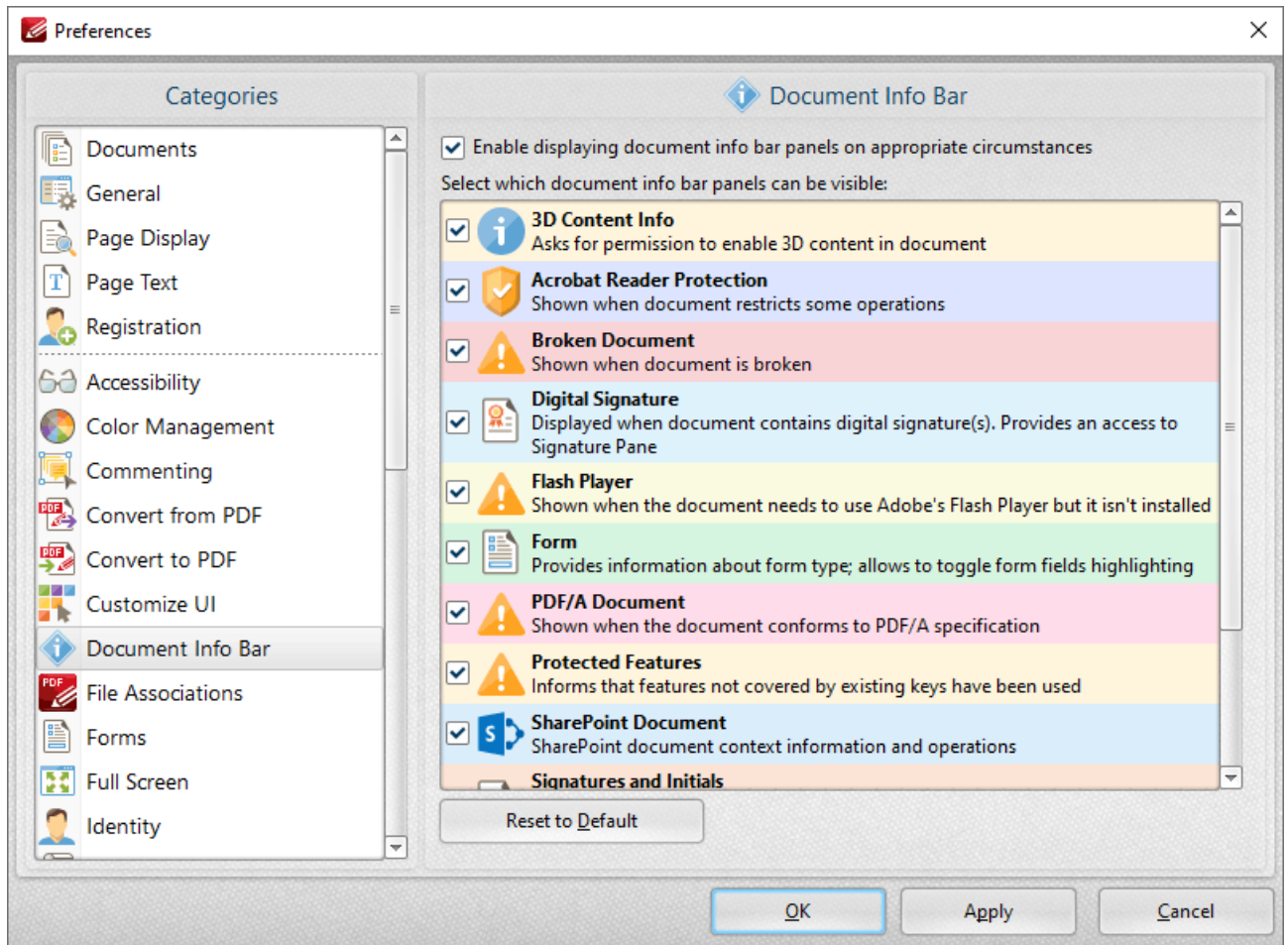

Figure 1. Preferences Dialog Box, Document Info Bar Tab Selected

**Document Info Bars** appear to alert users of specific information when documents are viewed/edited in **PDF-XChange Editor**, as detailed in (figure 1).

- Select/clear the upper check box to enable/disable **Document Info Bars**.

- Select/clear the eight remaining check boxes to enable/disable the associated **Document Info Bars**.
- Click **Reset to Default** to reset all **Document Info Bars** to their default values.

Click **Apply** to apply changes and **OK** to save changes. A sample **Document Info Bar** is displayed below:

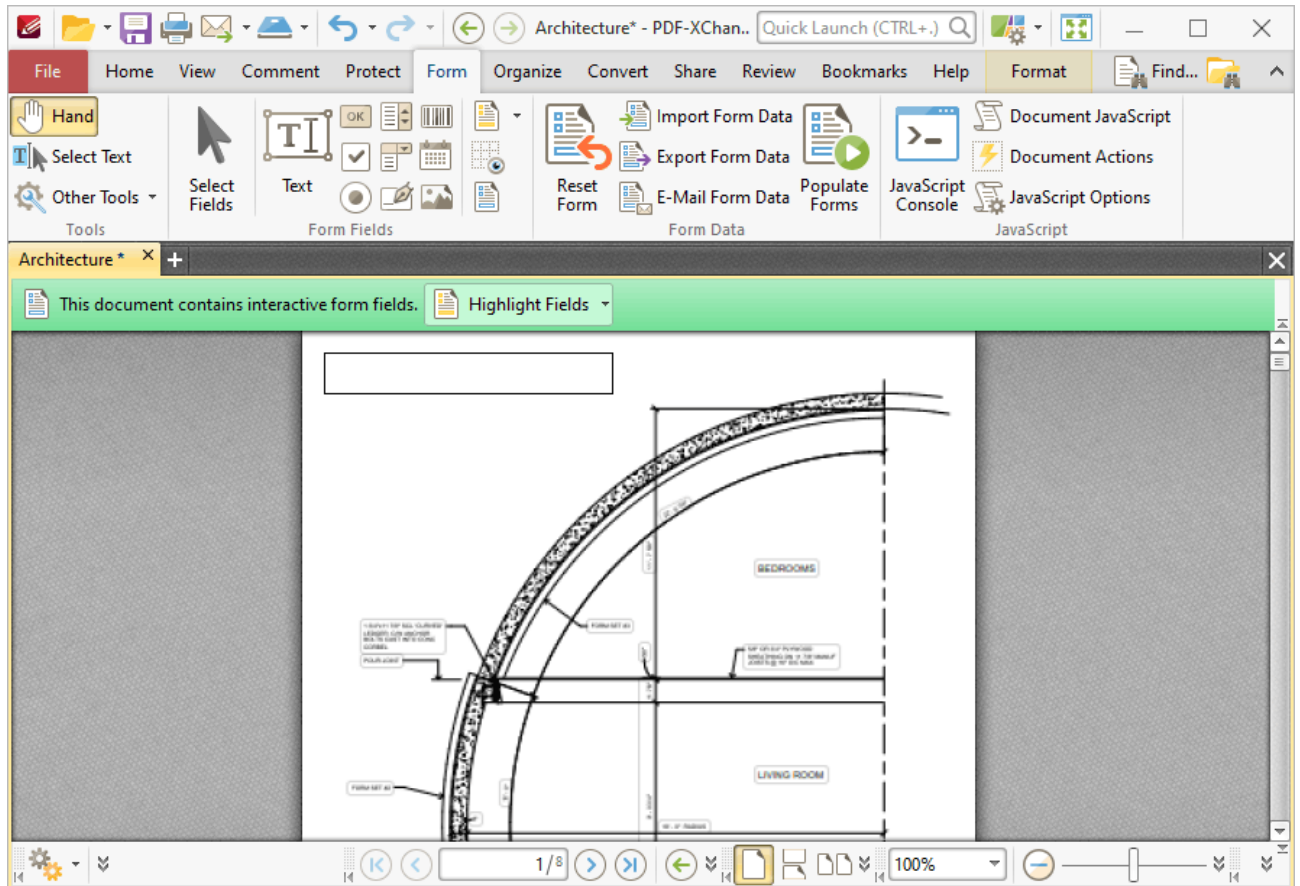

Figure 2. Form Document Info Bar

## 10.4.1.8.12 File Associations



## File Associations

When the **File Associations** tab is selected the following options are available:

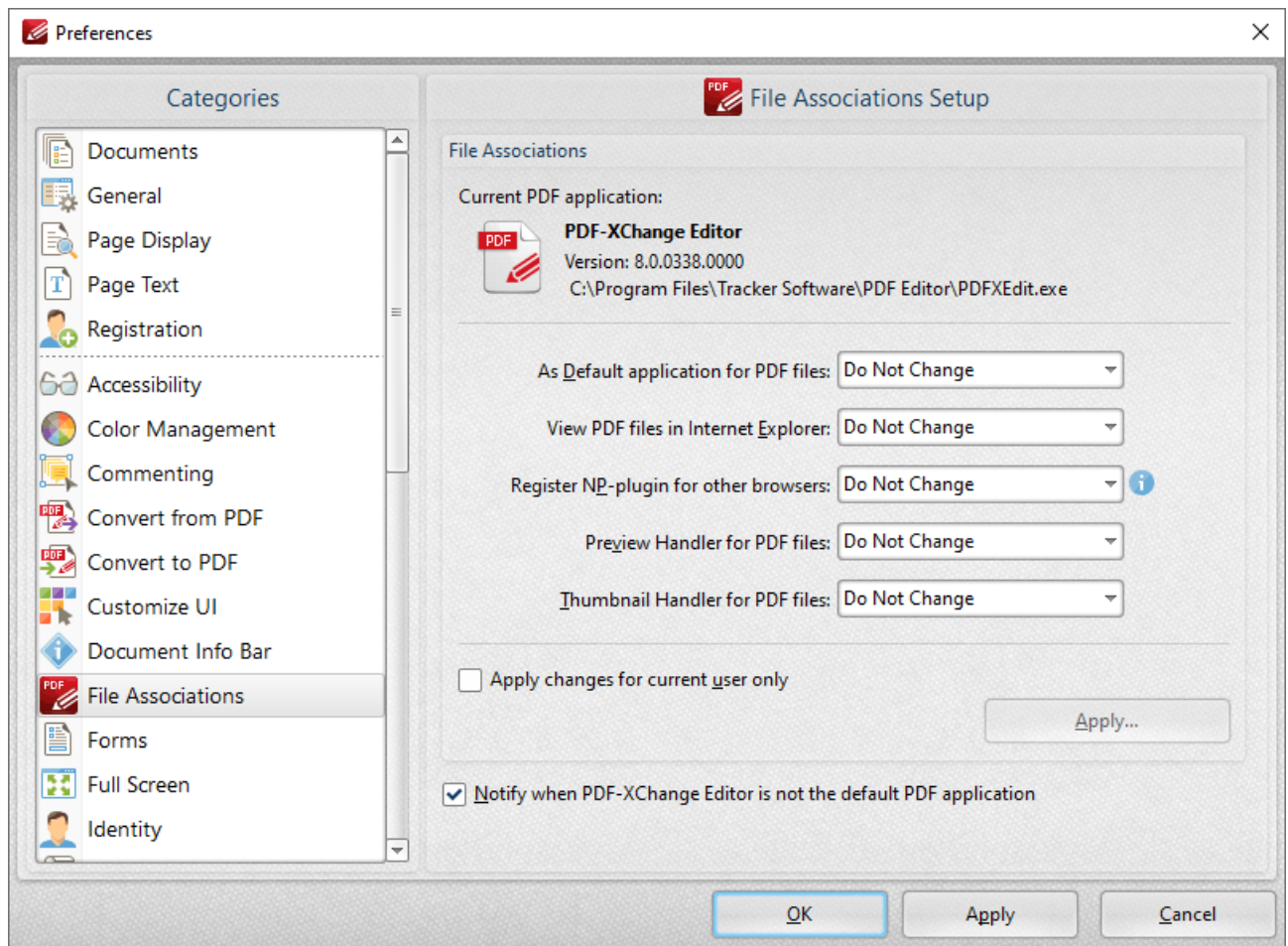

Figure 1. Preferences Dialog Box, File Associations Tab Selected

File associations are used to associate file types with applications capable of opening those file types. The file association preferences in **PDF-XChange Editor** determine the settings for the **PDF** application designated as the current application for PDF files. This file association settings for **Windows** can be used to determine the current application for PDF files. **PDF-XChange Editor** is set as the default application in **(figure 1)**.

- Use the dropdown menus to adjust the settings for the current application.
- Select the **Apply changes only for current user** box as desired. Click **Apply** to apply changes for only the current user.
- The **Notify when PDF-XChange Editor is not default PDF Application** box is selected by default. Clear the box to disable notifications.

Click **Apply** to apply changes and **OK** to save changes.

---

10.4.1.8.13 Forms



Forms

When the **Forms** tab is selected the following options are available:

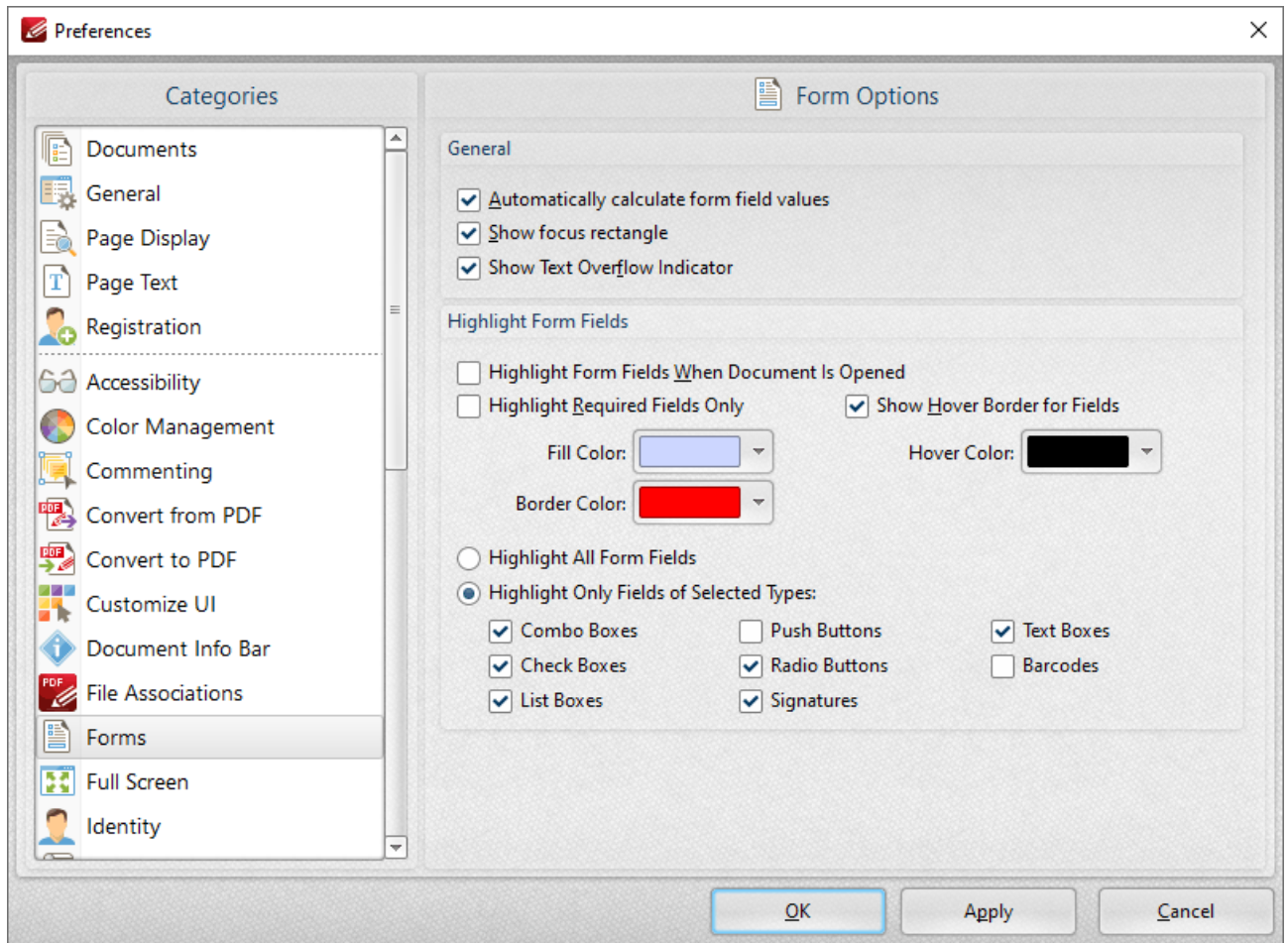

Figure 1. Preferences Dialog Box, Forms Tab Selected

These settings determine the options for forms in **PDF-XChange Editor**. There are several forms available in **PDF-XChange Editor**, which each feature different features and functionality. Further information on forms is available [here](#).

The options in the **General** section are as follows:

- Select the **Automatically calculate form field values** box to perform form field calculations automatically in forms that have been set up to perform calculations. Further information on this process is available [here](#).<sup>1284</sup>
- Select the **Show focus rectangle** box to enable the focus rectangle, which indicates the form field that has focus when multiple fields are selected.
- Select the **Show text overflow indicator** box to enable the text overflow indicator, which is an icon that appears when text exceeds the bounds specified when form fields are created.

The options in the **Highlight Form Fields** section are as follows:

- Select the **Highlight Form Fields When Document Is Opened** box as desired.
- Select the **Highlight Required Fields Only** box as desired. Fields designated as required must be filled before documents can be submitted. See [here](#).<sup>1437</sup> for information on how to designate forms as required forms.
- Select the **Show Hover Border for Fields** box as desired.
- Use the dropdown menus to select the **Fill Color**, **Border Color** and **Hover Color** for highlighted forms.
- Select the **Highlight All Form Fields** option button as desired.
- Alternatively, select the **Highlight Only Fields of Selected Types** option button and then select the desired forms to be highlighted when documents are opened.

Click **Apply** to apply changes and **OK** to save changes.

---

10.4.1.8.14 Full Screen



Full Screen

When the **Full Screen** tab is selected the following options are available::

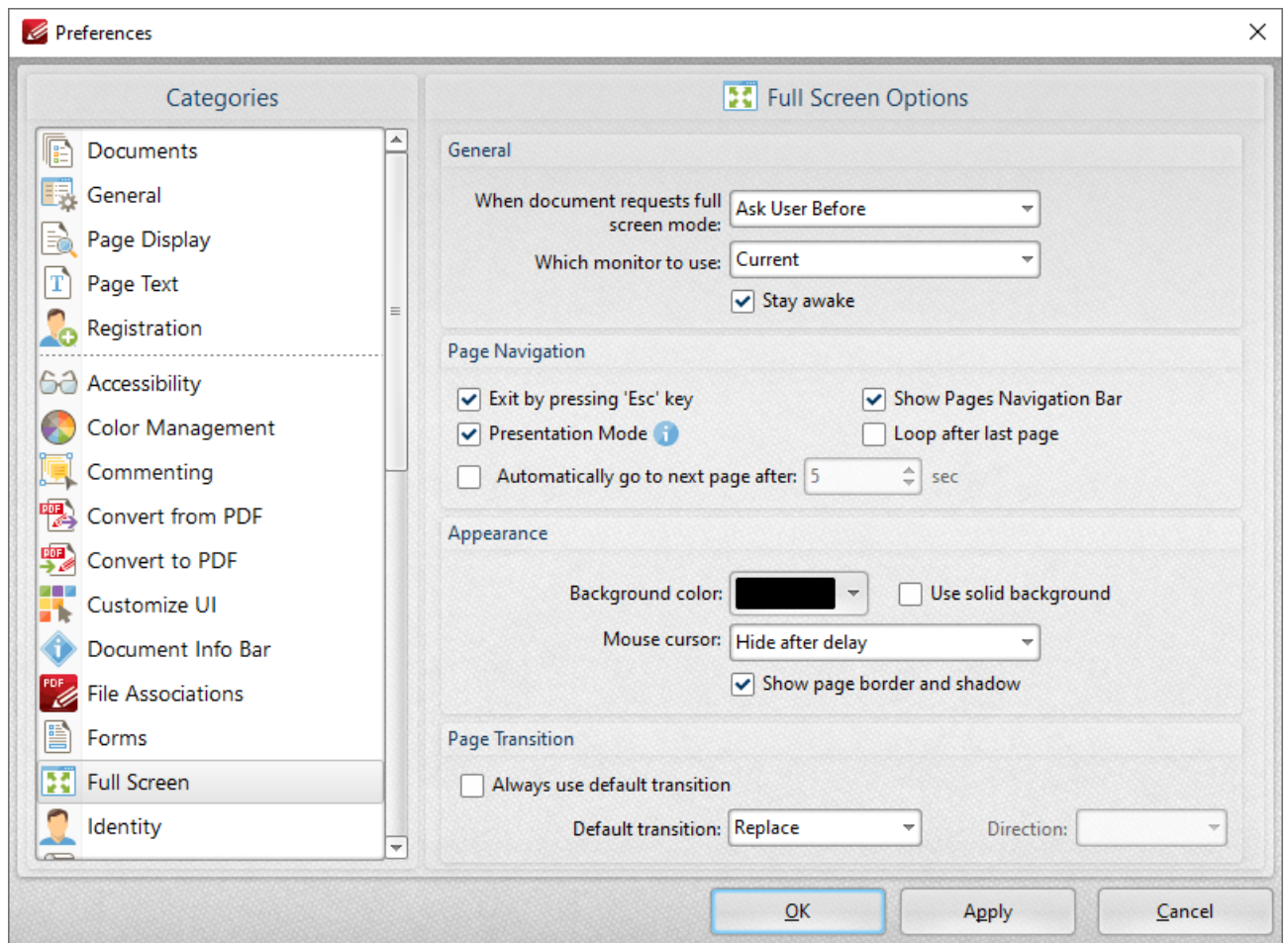



Figure 1. Preferences Dialog Box, Full Screen Tab Selected

- The **General** settings determine parameters for full screen mode:
  - Use the upper dropdown menu to determine what happens when documents request full screen mode.
  - Use the lower dropdown menu to determine which monitor is used for full screen mode.

- Select the **Stay awake** box to prevent the computer from going into screensaver/sleep/hibernate mode.
- The **Pages Navigation** settings determine navigation parameters for full screen mode:
  - Select the **Exit by pressing 'Esc' key** box to enable the use of the Esc key to exit full screen mode.
  - Select the **Show Pages Navigation Bar** to enable the [Page Navigation Toolbar](#) when full screen mode is active.
  - Select **Presentation Mode** to enable **Presentation Mode** when full screen is enabled. This is a unique mode that is designed for giving presentations. When it is enabled the following settings are active:
    - Left-click moves to next page.
    - Right-click moves to previous page.
    - Press 'B' or 'W' to make the entire screen black or white.
    - Press 'P' to pause/resume the automatic scrolling of documents.
    - Commenting is disabled.
  - Select the **Loop after last page** box repeat documents when the last page is reached and **Presentation Mode** is enabled.
  - Select the **Automatically go to the next page after** box to enable the automatic page-browsing feature. Enter a value in number box to determine the rate of browsing.
  - Select/clear the **Show page border and shadow** box as desired.
- The **Appearance** settings determine further options of the software when full-screen mode is enabled:
  - Use the **Background color** dropdown menu to determine a background color when full screen mode is enabled.
  - Select the **Use solid background** box set a solid background color in full screen mode.
  - Select an option from the **Mouse Cursor** dropdown menu to determine the setting for the mouse cursor in full screen mode.
- The **Page Transition** settings determine the page transition settings:
  - Select the **Always use default transition** box to use the transition determined in the dropdown menu immediately below.
  - Select an option from the **Default Transition** menu to determine the page transition style in full screen mode.
  - Use the **Direction** dropdown menu to determine the direction of the transition style selected in the **Default transition** dropdown menu.

Click **Apply** to apply changes and **OK** to save changes.

---



## 10.4.1.8.15 Identity

**Identity**

When the **Identity** tab is selected the following options are available:

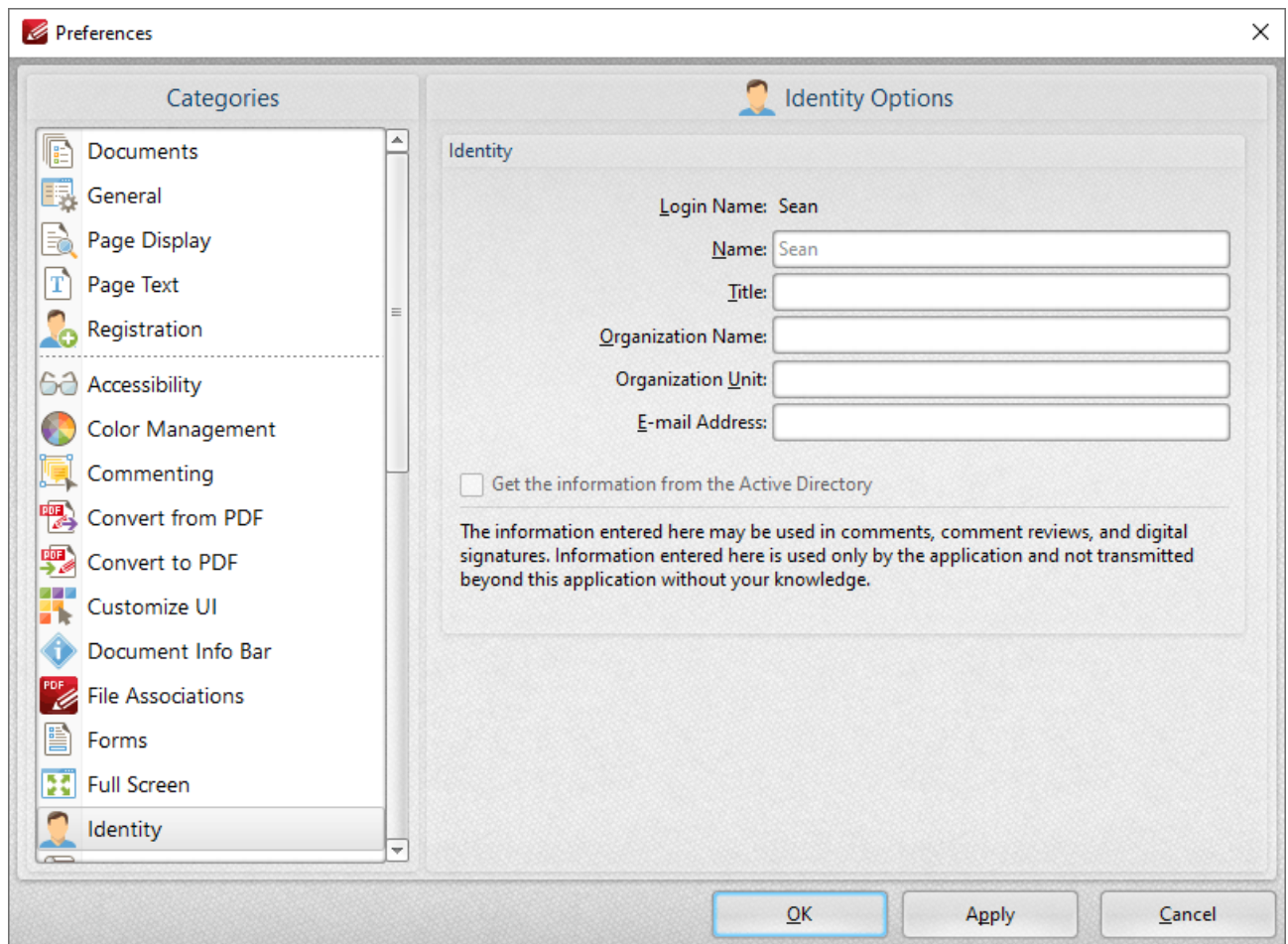

**Figure 1.** Preferences Dialog Box, Identity Tab Selected

The **Identity** text boxes store user information for use in comments, comment reviews and digital signatures. Enter details into the text boxes as desired.

Click **Apply** to apply changes and **OK** to save changes.



## 10.4.1.8.16 JavaScript



## JavaScript

When the **JavaScript** tab is selected the following options are available:

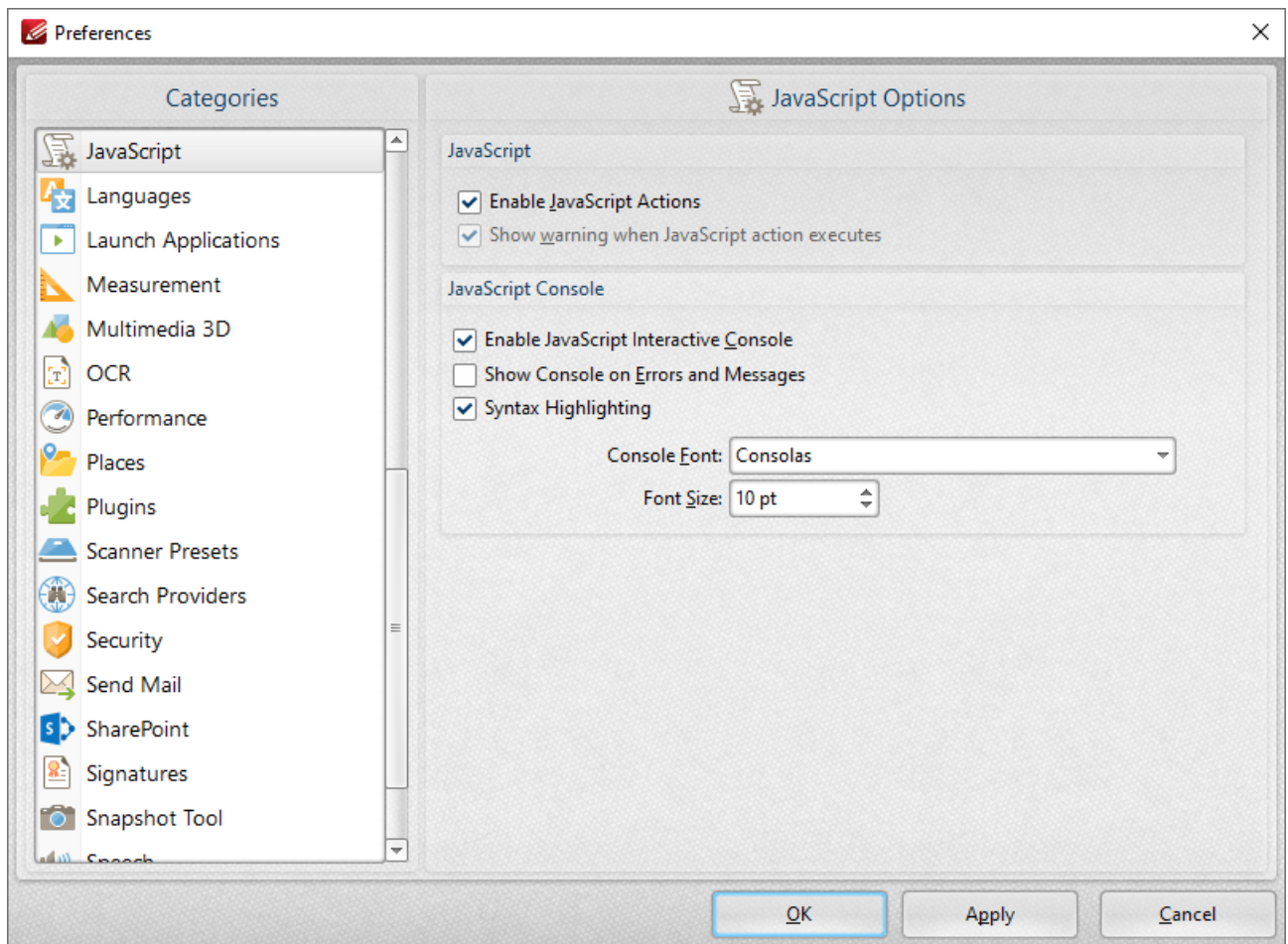

Figure 1. Preferences Dialog Box, JavaScript Tab Selected

These settings determine the **JavaScript** options in **PDF-XChange Editor**:

- Select the check boxes as desired in the **JavaScript** section.
- Select the **Enable Javascript Interactive Console** box to enable the **JavaScript Console**, which is detailed [here](#).<sup>1429</sup>

- Select the **Show Console on Errors and Messages box** to activate the console when JavaScript encounters errors.
- Select the **Syntax Highlighting** box to highlight syntax entered into the **JavaScript Console**.
- Use the **Console Font** and **Font Size** menus to determine font settings in the **JavaScript Console**.

Click **Apply** to apply changes and **OK** to save changes.

---

## 10.4.1.8.17 Languages



## Languages

When the **Languages** tab is selected the following options are available:

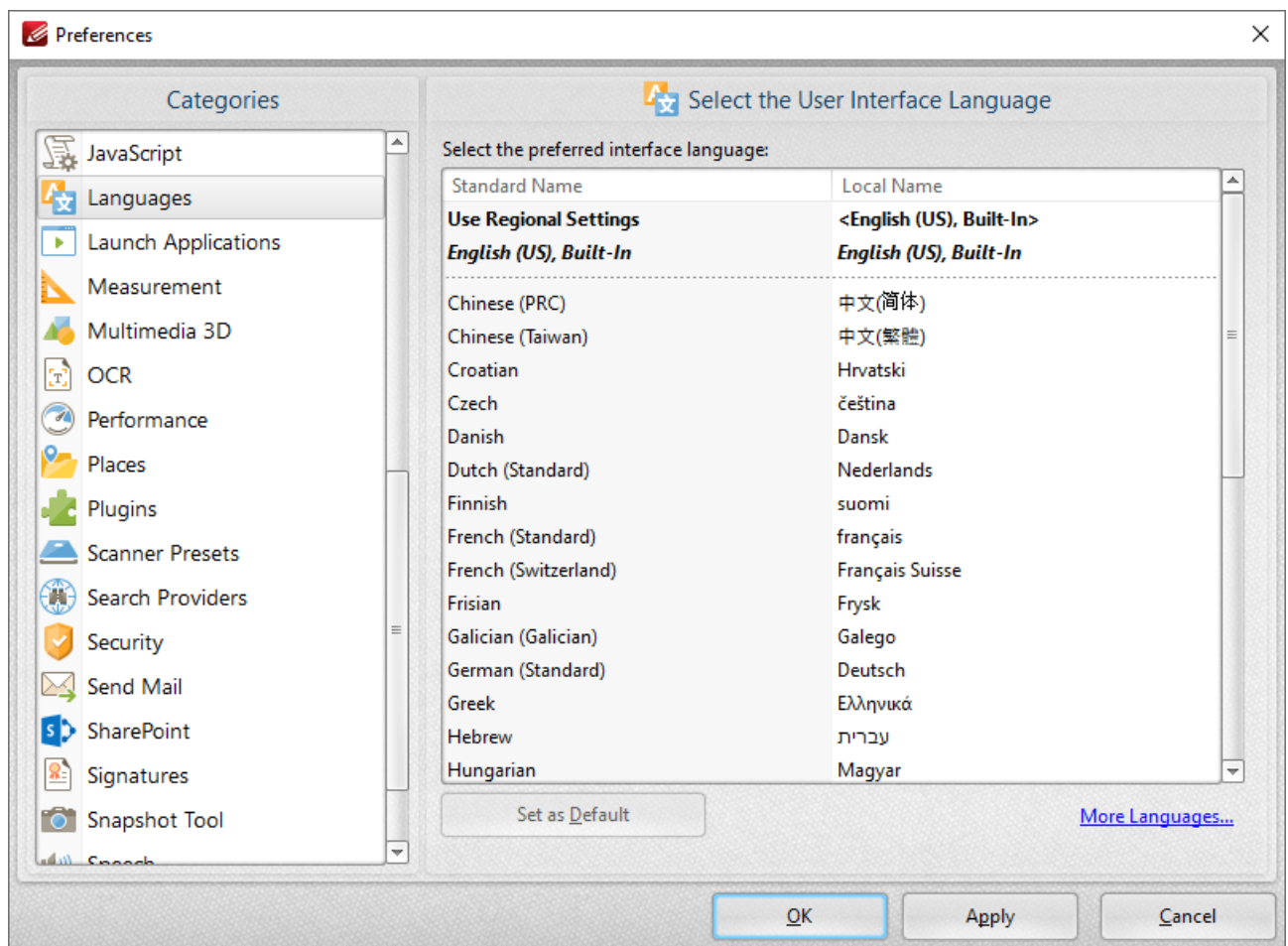

Figure 1. Preferences Dialog Box, Languages Tab Selected

- Use the language pane to set the language for the user interface of **PDF-XChange Editor**.
- Click **Set as Default** to set the selected language as the default language.
- See [here](#) for further information on languages in **PDF-XChange Editor**.

Click **Apply** to apply changes and **OK** to save changes.



#### 10.4.1.8.18 Launch Applications



### Launch Applications

When the **Launch Applications** tab is selected the following options are available:

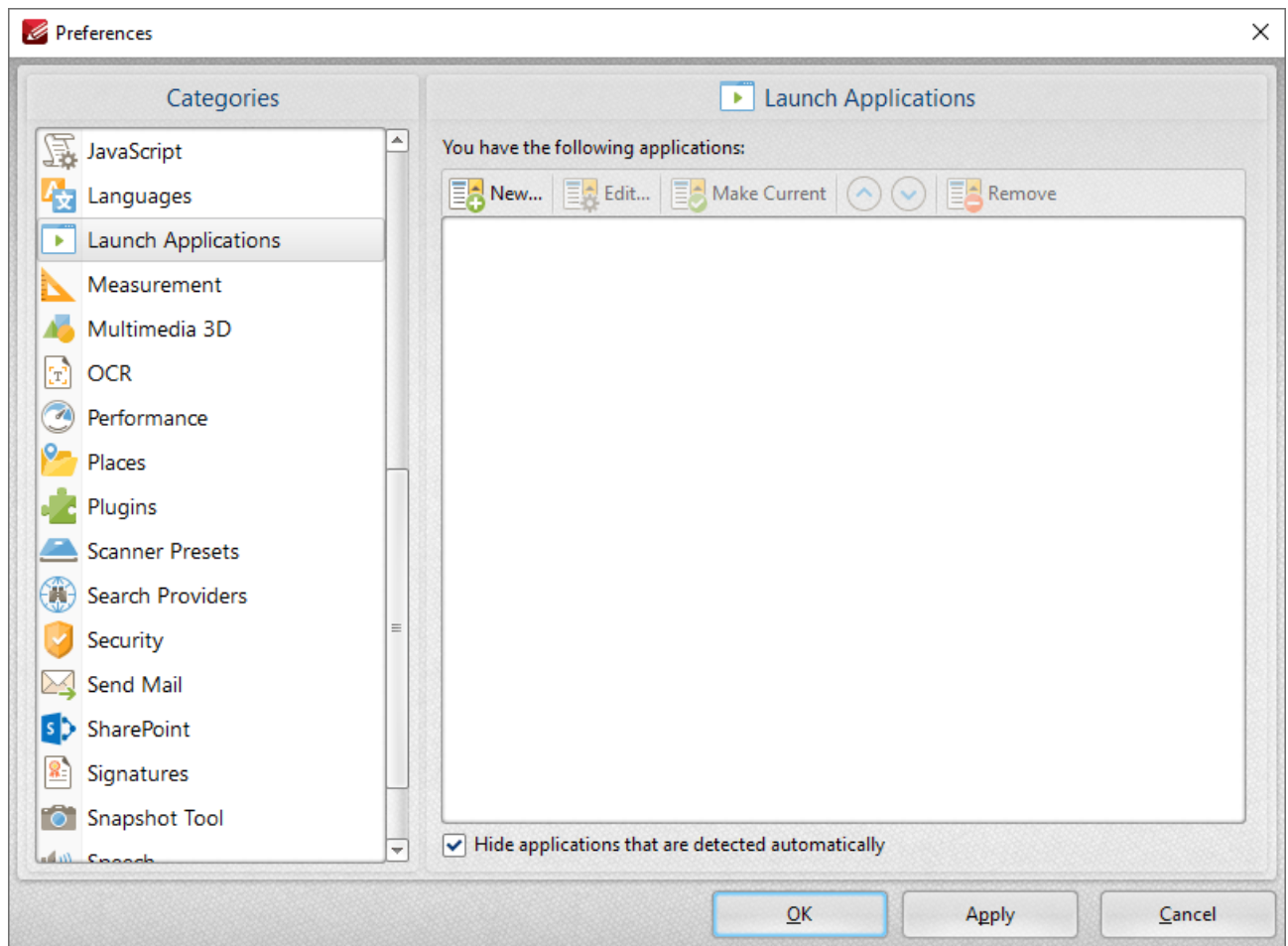

**Figure 1.** Preferences Dialog Box, Launch Applications Tab Selected

This pane displays the list of third-party applications currently featured in the [Launch Applications Toolbar](#).<sup>1609</sup> This toolbar provides a convenient way to open active documents using third-party applications. Follow the instructions below to add/edit applications:

- Click **New** to add a new application. The dialog box in **(figure 2)** will open.

- Click **Edit** to edit the selected application.
- Click **Make Current** to set the selected application as the default application.
- Use the arrows to move selected launch applications up or down in the window.
- Click **Remove** to remove selected applications.
- Select the **Hide applications that are detected automatically** box as desired.

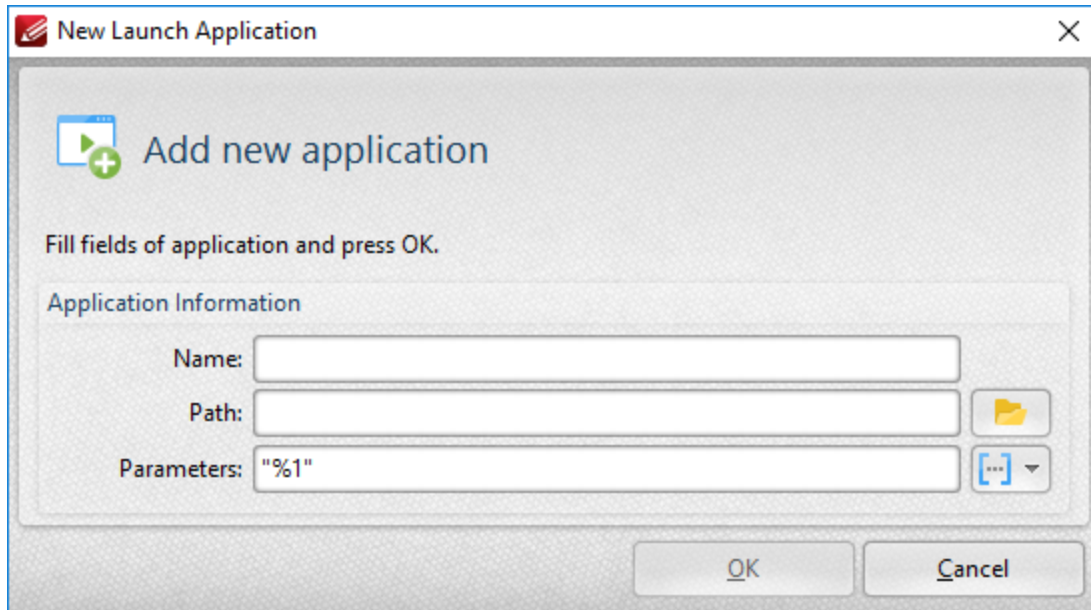

Figure 2. New Launch Application Dialog Box

- Enter a name for the launch application in the **Name** text box.
- Enter the path executable in the **Path** text box, or use the folder icon to select the application manually.
- Use the **Parameters** text box to add additional parameters to new applications. These parameters are variables that result in the retention of specific document values when documents are opened in third-party applications via the **Launch Applications Toolbar**. All available parameters are [macros](#).<sup>1707</sup> 'Macro' is an abbreviation of 'macroinstruction' - a term in computer science for a rule that specifies how input characters should be entered to create corresponding output. Enter macros in the **Parameters** text box as desired. Alternatively, use the dropdown icon to select macros manually. The following parameters are available for all applications:
  - **File name**, which uses the syntax **%1** and inherits the file name and path. This is the only parameter that is required in all cases and it must be contained in double quotation marks.
  - **Zoom**, which uses the syntax **%z** and inherits the zoom level.
  - **Page Number**, which uses the syntax **%p** and inherits the current page number.
  - **Page (0-base numeration)**, which uses the syntax **%p0** and inherits the first numerical page number that starts at 01, 02 etc.
  - **Position X (in pixels)**, which uses the syntax **%vx** and inherits the position viewed along the x axis.



- **Position Y (in pixels)**, which uses the syntax **%vy** and inherits the position viewed position viewed along the y axis.
  - **Position X (in pt)**, which uses the syntax **%px** and inherits the position viewed position viewed along the x axis in pt.
  - **Position Y (in pt)**, which uses the syntax **%py** and inherits the position viewed position viewed along the y axis in pt.
  - **View Rotation**, which uses the syntax **%vr** and inherits the rotation value of documents.
- Additional macros to those detailed above are available, but it is necessary to use the launch commands of the application in question. For example, if **PDF-XChange Viewer** is being used, the launch command to open a file to a specific page is **/A "page= <page\_number>"**. Therefore the parameter **/A "page=%p" "%1"** would be used, where the desired page number is entered as the **%p** variable and the file name is entered as the **%1** variable. If more than one parameter is being used then parameters must be separated with an **"&"** symbol. Please note that some applications may not support the use of parameters.

Click **OK** to add new applications.

---

## 10.4.1.8.19 Measurement

**Measurement**

When the **Measurement** tab is selected the following options are available:

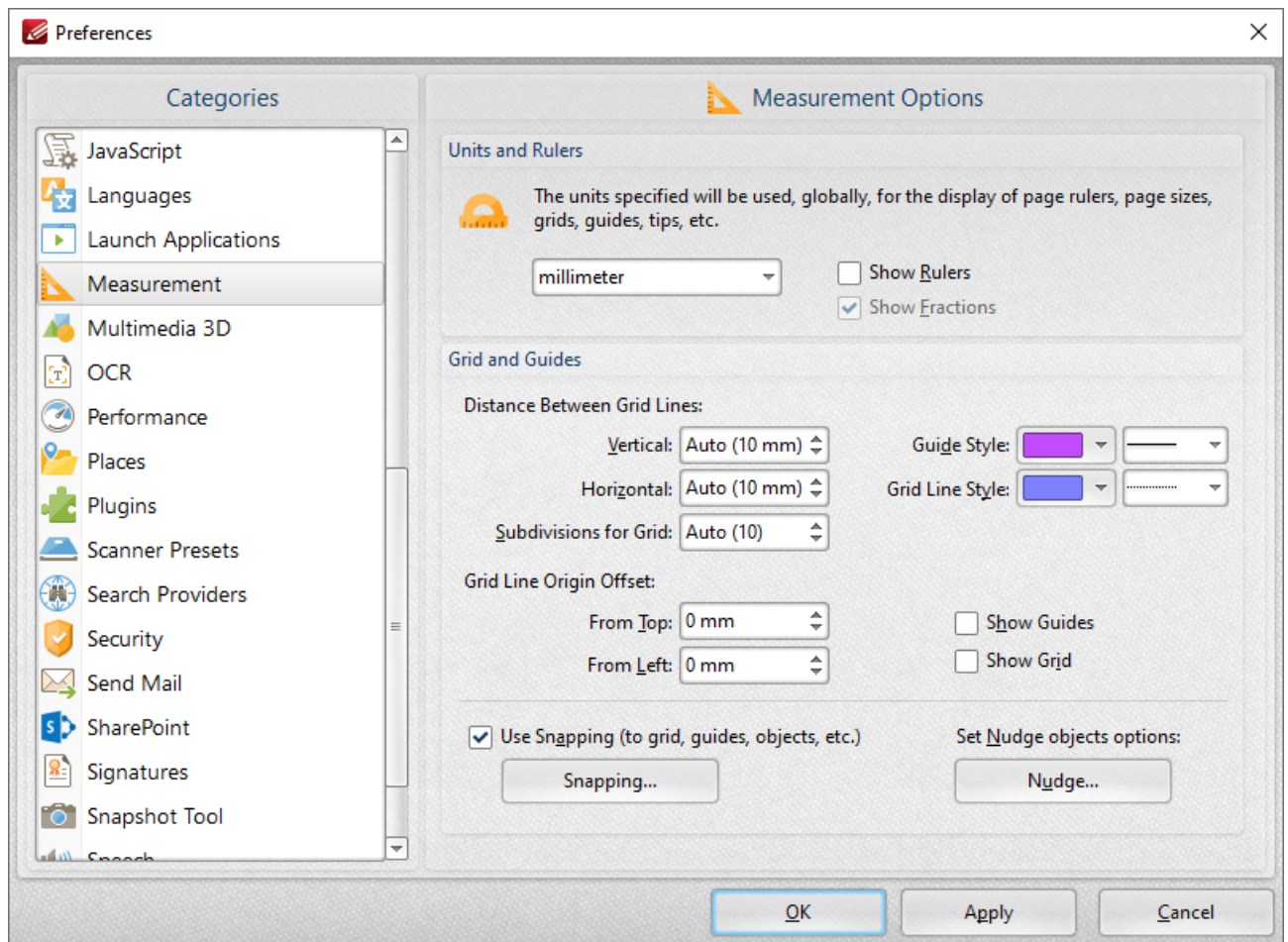

**Figure 1.** Preferences Dialog Box, Measurement Tab Selected

These options determine the units of measurement and certain feature layout options in **PDF-XChange Editor**:

- Use the **Units** and **Rulers** dropdown menu to determine the units of measurement.
- Select the **Show Rulers** box to enable document rulers.

- Select the **Show Fractions** box to enable fractions in units of measurement.
- Use the **Grids and Guides** section to determine the layout and color of document grids/guides. These features are used to assist in document editing, as detailed [here](#).
- Select the **Use Snapping** box to enable snapping, which assists in the precise placement of document content, as detailed in *(figure 4)* below.
- Click **Nudge** to determine the settings for the nudge feature, which is used to manually adjust the position of selected document content/comments:

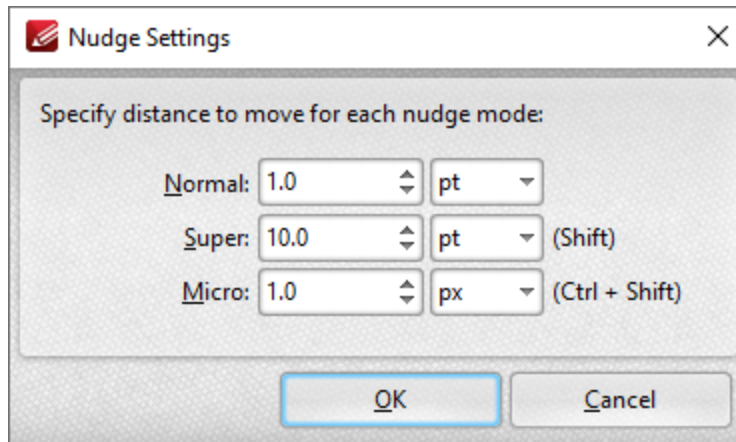

Figure 2. Nudge Settings Dialog Box

- Enter the desired value and units of measurement in the **Normal** dropdown menus to determine the standard nudge size. Selected content will be moved according to these dimensions when the arrow keys are used.
- Enter the desired value and units of measurement in the **Super** dropdown menus to determine the 'super' nudge size. Selected content will be moved according to these dimensions when Shift is pressed and the arrow keys are used.
- Enter the desired value and units of measurement in the **Micro** dropdown menus to determine the 'micro' nudge size. Selected content will be moved according to these dimensions when Ctrl+Shift are pressed and the arrow keys are used.
- Click **Snapping** to customize snapping parameters:

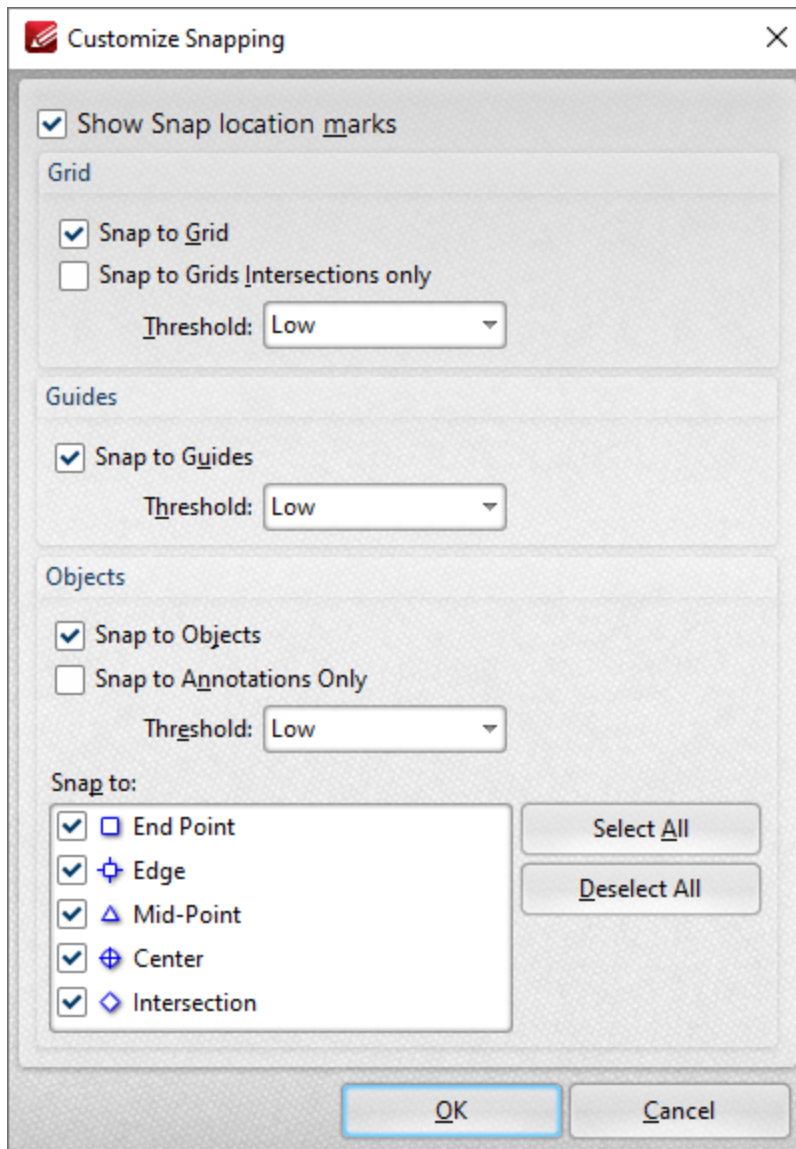

Figure 3. Customize Snapping Dialog Box

- Select the **Show Snap location marks** box as desired.
- Use the **Grid** settings to determine how objects in the document interact with grids:
  - Select the **Snap to Grid** box to align objects with the nearest grid line when they are moved.
  - Select the **Snap only to Grids Intersections** box to align objects to only the grid intersections.
- Select the **Snap to Guides** box to snap objects to guide lines when they are moved.
- Use the **Threshold** menu to determine the level of sensitivity for guide lines.
- Use the **Objects** settings to determine how snapping operates in conjunction with objects:
  - Select the **Snap to Objects** box to enable snapping to objects.
  - Select the **Snap to Annotations Only** box to enable snapping to only annotations and not other objects.

- Use the **Threshold** menu to determine the level of sensitivity for snapping to objects.
- Select the check boxes in the **Snap to** menu to determine at which points snapping is enabled for objects.

Click **OK** to save settings. Then, in the **Preferences** dialog box, click **Apply** to apply changes and **OK** to save changes.

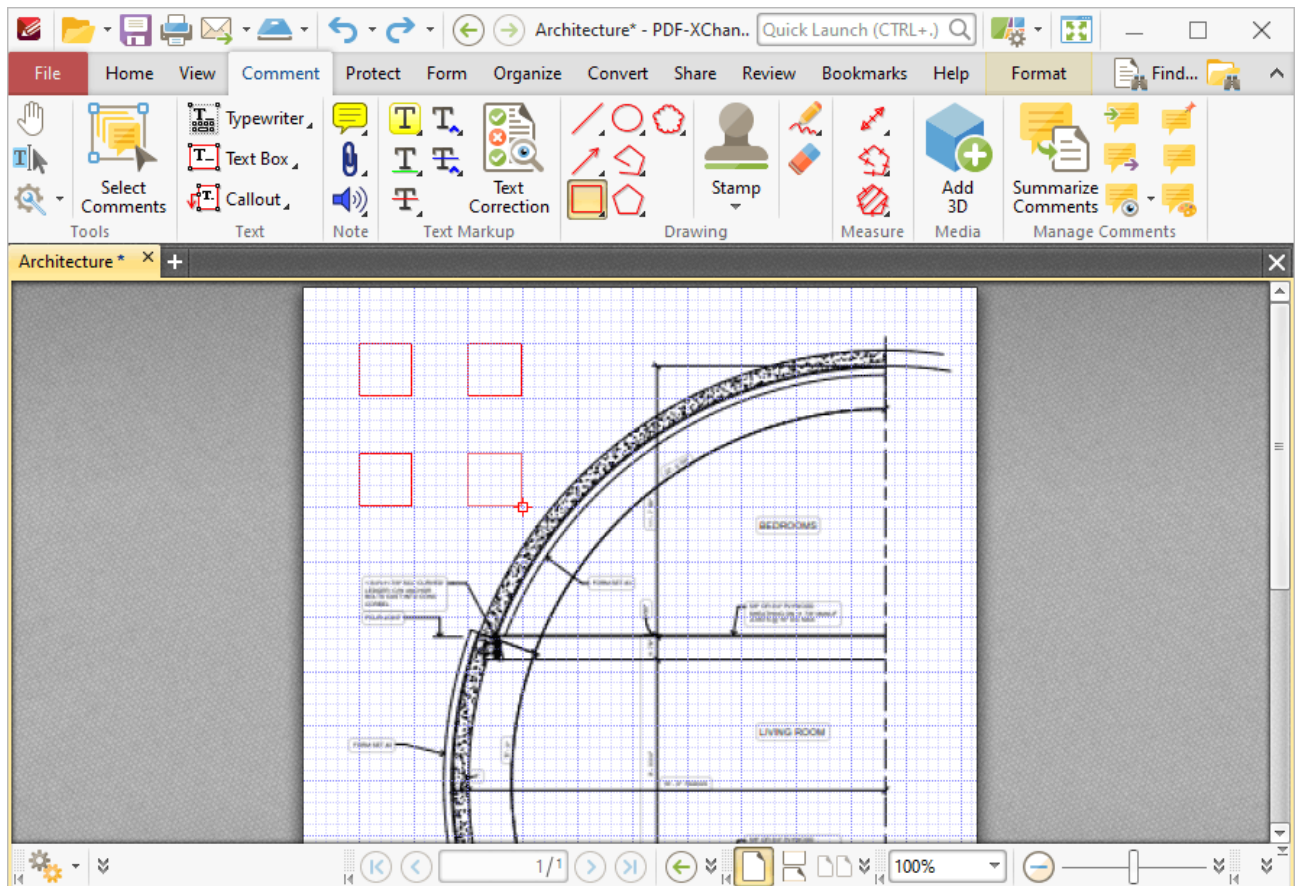
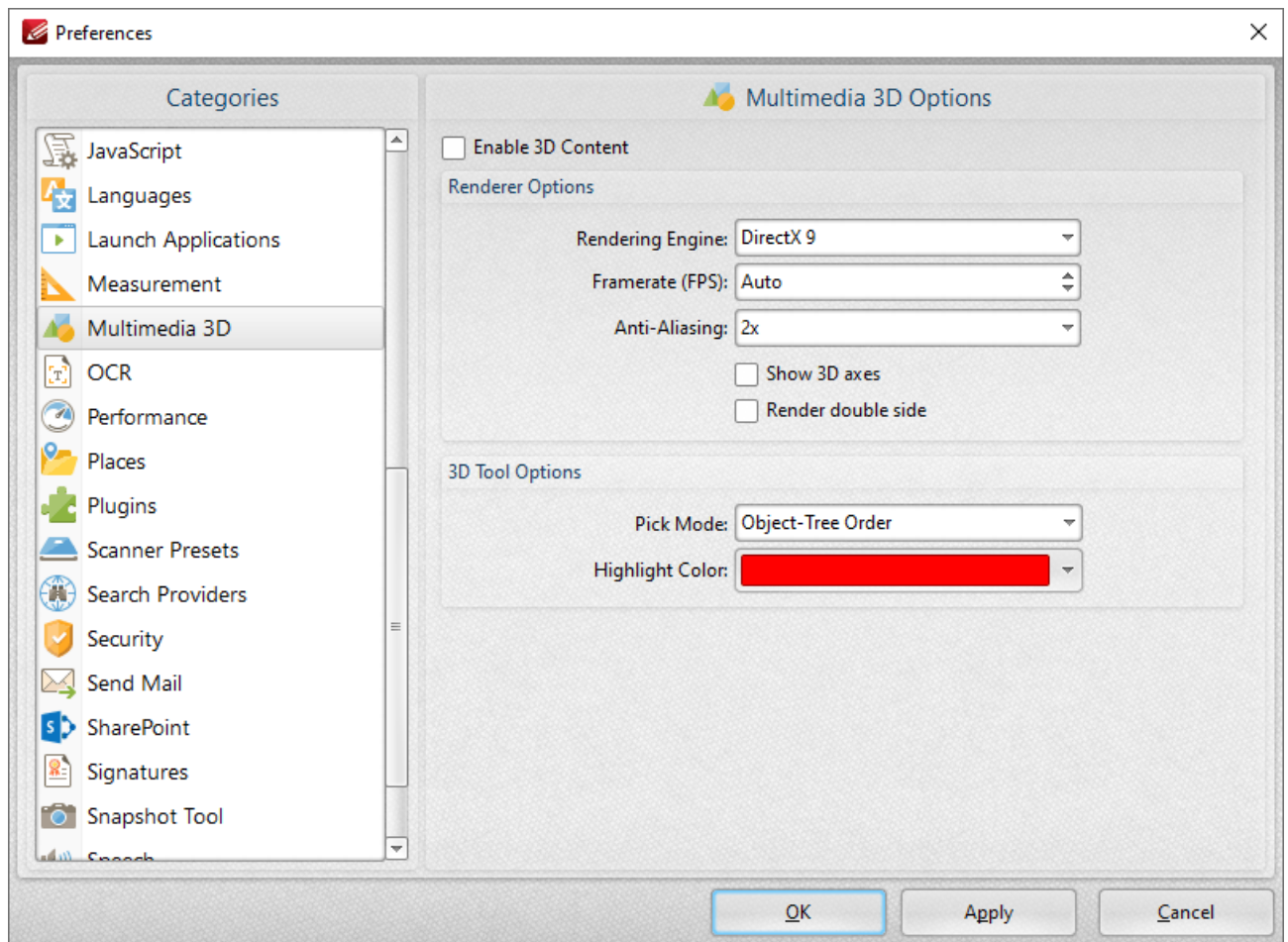

Figure 4. Active Snapping Feature

## 10.4.1.8.20 Multimedia 3D

**Multimedia 3D**

When **Multimedia 3D** tab is selected the following options are available:



**Figure 1.** Preferences Dialog Box, Multimedia 3D Tab Selected

- Select the **Enable 3D Content** box to enable 3D content in documents. Note that only U3D content is supported at the moment.
- Use the **Renderer Options** to determine how 3D content is rendered:
  - Select an option in the **Rendering Engine** dropdown menu to determine the rendering engine used.

- Select an option in the **Framerate** dropdown menu to determine the frames per second for 3D content.
- Select an option in the **Anti-Aliasing** dropdown menu to determine the level of anti-aliasing, which reduces the level of distortion that is sometimes seen in 3D images. Note that increasing the level of anti-aliasing requires more memory.
- Select/clear the **Show 3D axes** box to display/hide 3D axes as desired.
- Select an option in the **Pick Mode** dropdown menu to determine the order in which 3D objects are selected.
- Select a **Highlight Color** as desired.

Click **Apply** to apply changes and **OK** to save changes.

---

10.4.1.8.21 OCR



When **OCR** tab is selected the following options are available:

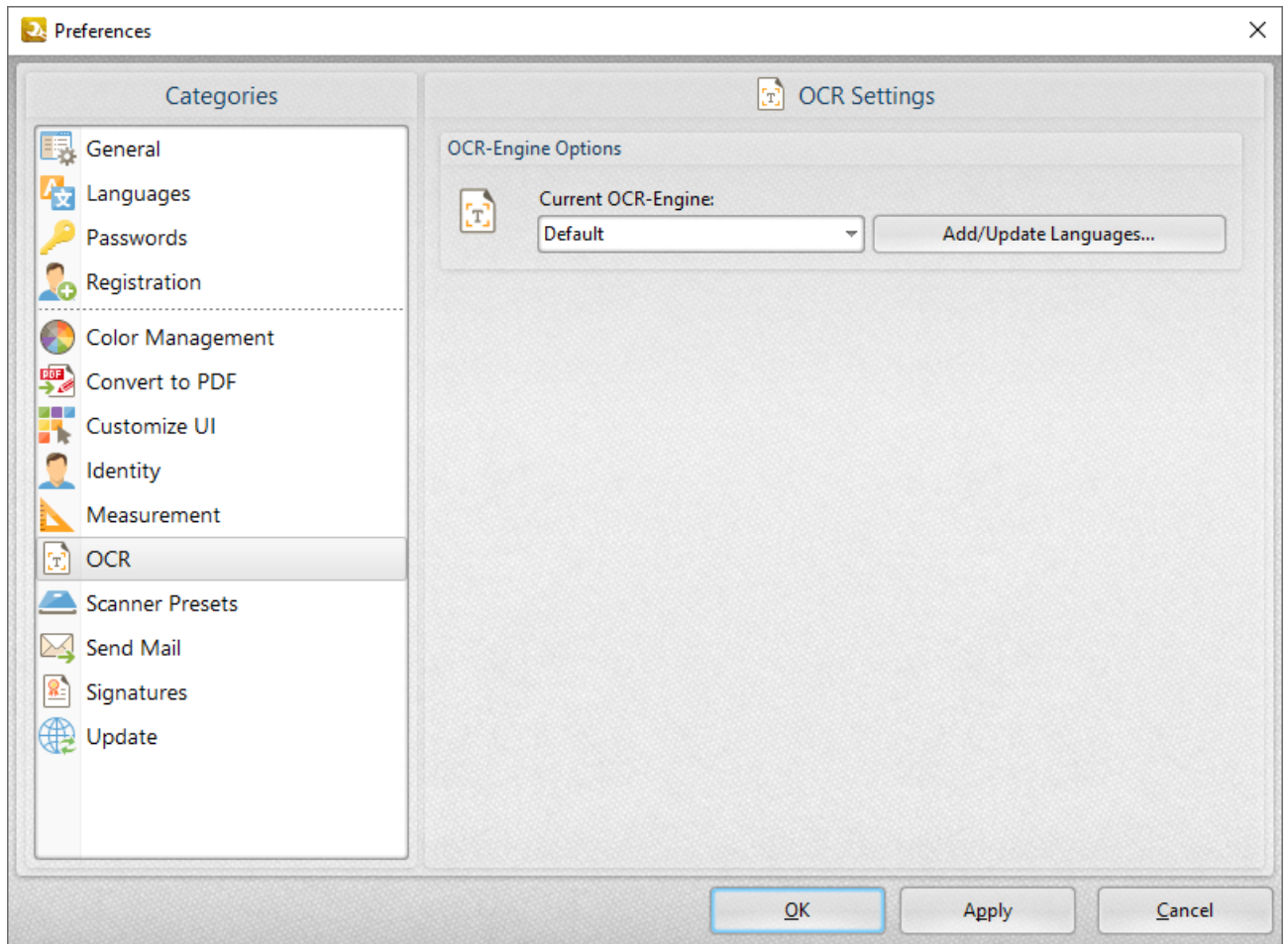

Figure 1. Preferences Dialog Box, OCR Tab Selected

Note that two OCR engines are available in **PDF-XChange Editor** - the default OCR engine, which is available to all users, and the **Enhanced OCR** engine, which is available as an optional plugin. The **Enhanced OCR** engine is significantly faster and more accurate than the default OCR engine and it contains several extra features. Further information and purchasing options for the **Enhanced OCR** engine are available [here](#).



- Use the dropdown menu to select either the **Enhanced** or **Default** OCR engine.
- Click **Add/Update** languages to view/download languages to use in conjunction with the OCR features of **PDF-XChange Editor**.

Click **Apply** to apply changes and **OK** to save changes.

---

## 10.4.1.8.22 Performance

**Performance**

When the **Performance** tab is selected the following options are available:

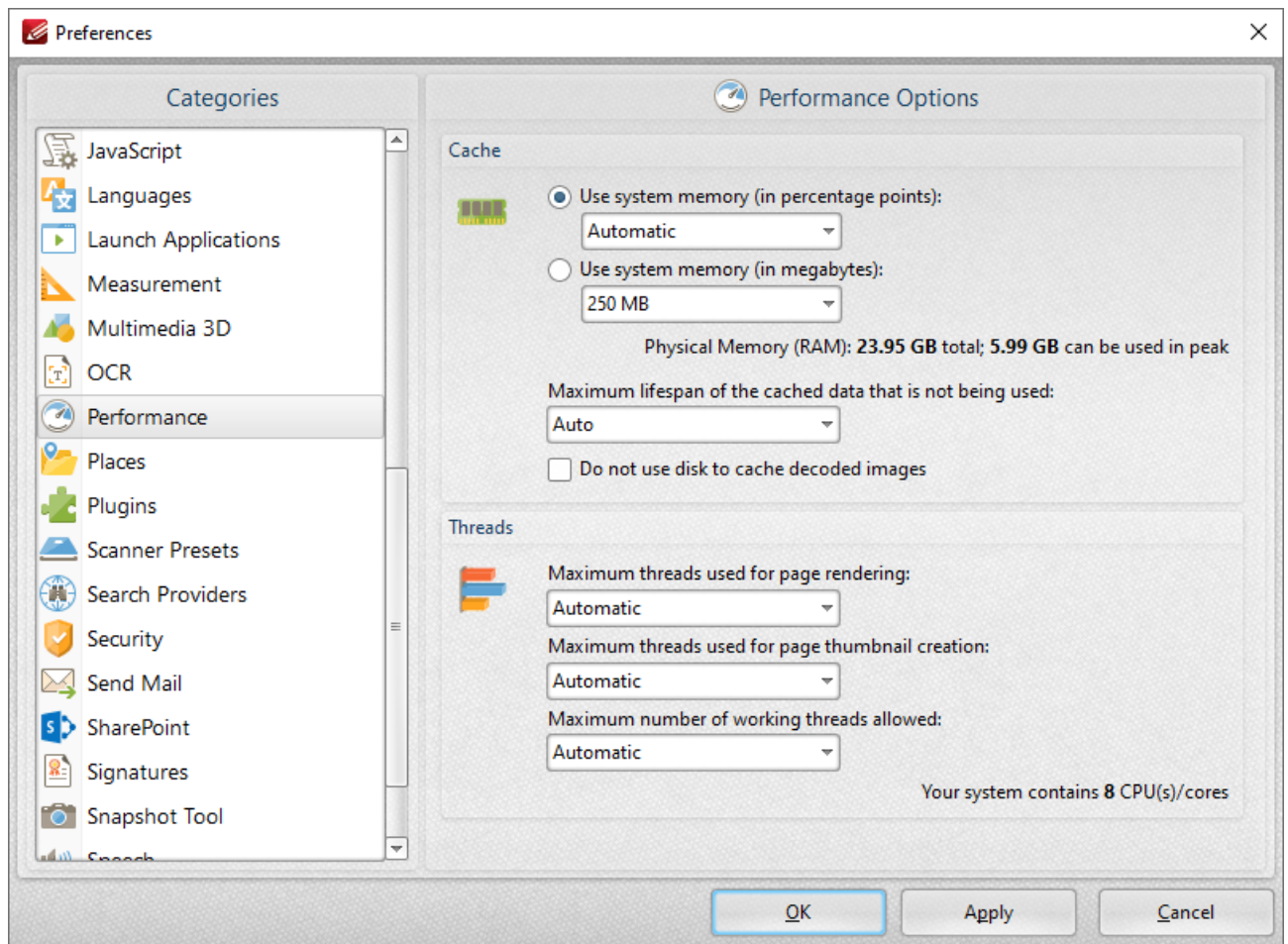

**Figure 1.** Preferences Dialog Box, Performance Tab Selected

- Use the **Cache** settings to determine how much system memory **PDF-XChange Editor** is permitted to use:
  - Select an option from the **Use system memory (in percentage points)** menu to set memory usage to **Automatic** or one of the listed percentages of total system memory.

- Select an option from the **Use system memory (in megabytes)** menu to set memory usage in megabytes.
- Use the dropdown menu to determine the maximum lifespan of cached data that is not being used. Note that selecting **Auto** will result in the optimal setting for your hardware.
- Please note that increasing memory usage will improve the performance of **PDF-XChange Editor**, but may also impact overall system performance.

Use the **Threads** dropdown menus to determine how many threads are used for page rendering and thumbnail creation, and the maximum amount of working threads at any given moment.

Click **Apply** to apply changes and **OK** to save changes.

---

## 10.4.1.8.23 Places

**Places**

When the **Places** tab is selected the following options are available:

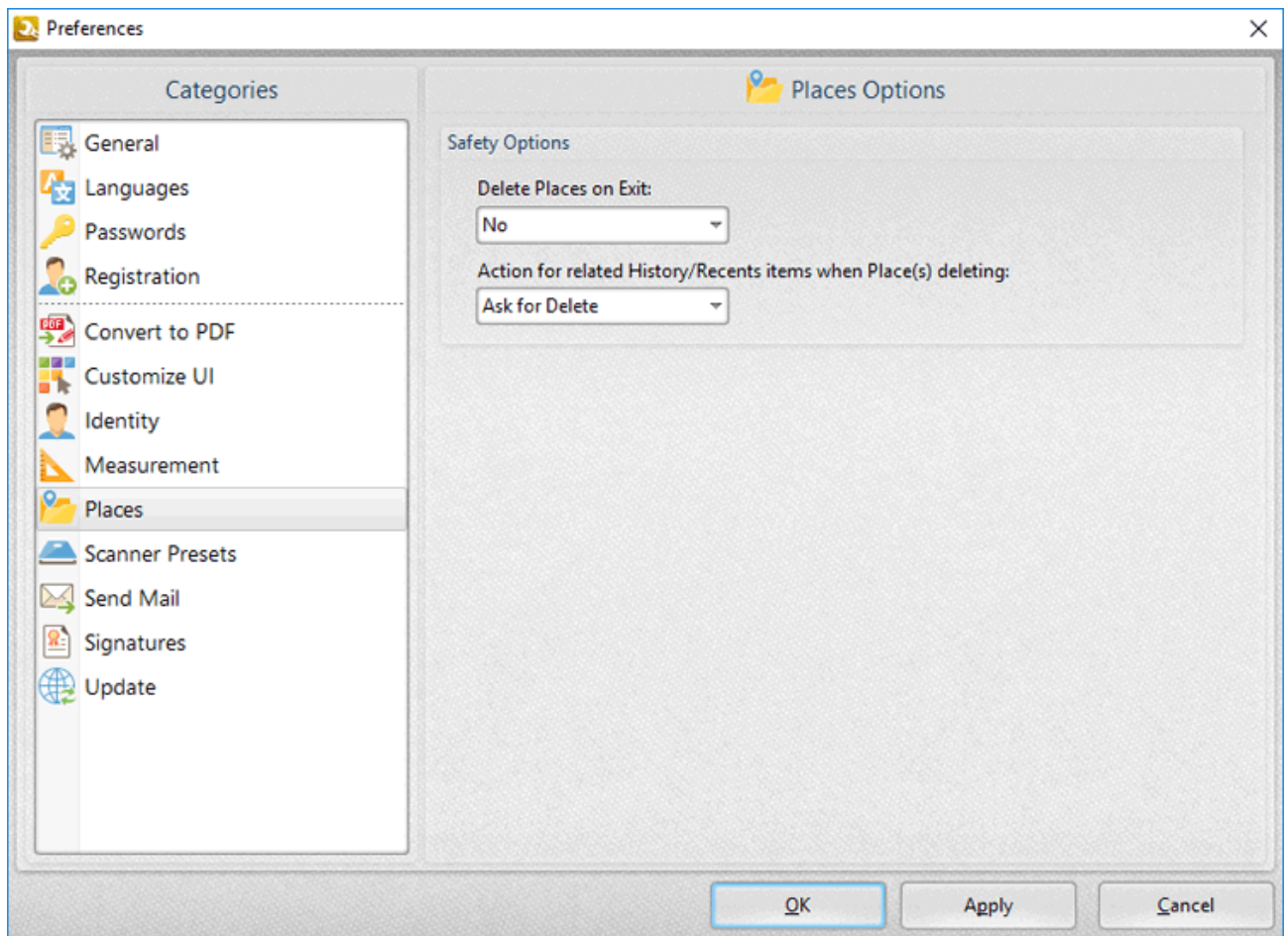

**Figure 1.** Preferences Dialog Box, Places Tab Selected

- Use the **Delete Places on Exit** dropdown menu to determine what happens to places when **PDF-XChange Editor** is closed:
  - **No** retains all places when **PDF-XChange Editor** is closed.
  - **All** deletes all places when **PDF-XChange Editor** is closed.

- **Only Newly Added** deletes only places that have been recently added when **PDF-XChange Editor** is closed.
- Use the **Action for related History/Recents items when Place(s) deleting** dropdown menu to determine what happens to items in the history/recents lists when the places from which they came are deleted:
  - **Ask for Delete** displays a message and prompts the user for action to take.
  - **Delete** means that associated items will be removed from the History/Recents lists.
  - **Keep** means that associated items will be retained in the History/Recents lists.

Click **Apply** to apply changes and **OK** to save changes.

---

## 10.4.1.8.24 Plugins



## Plugins

When the **Plugins** tab is selected the following options are available:

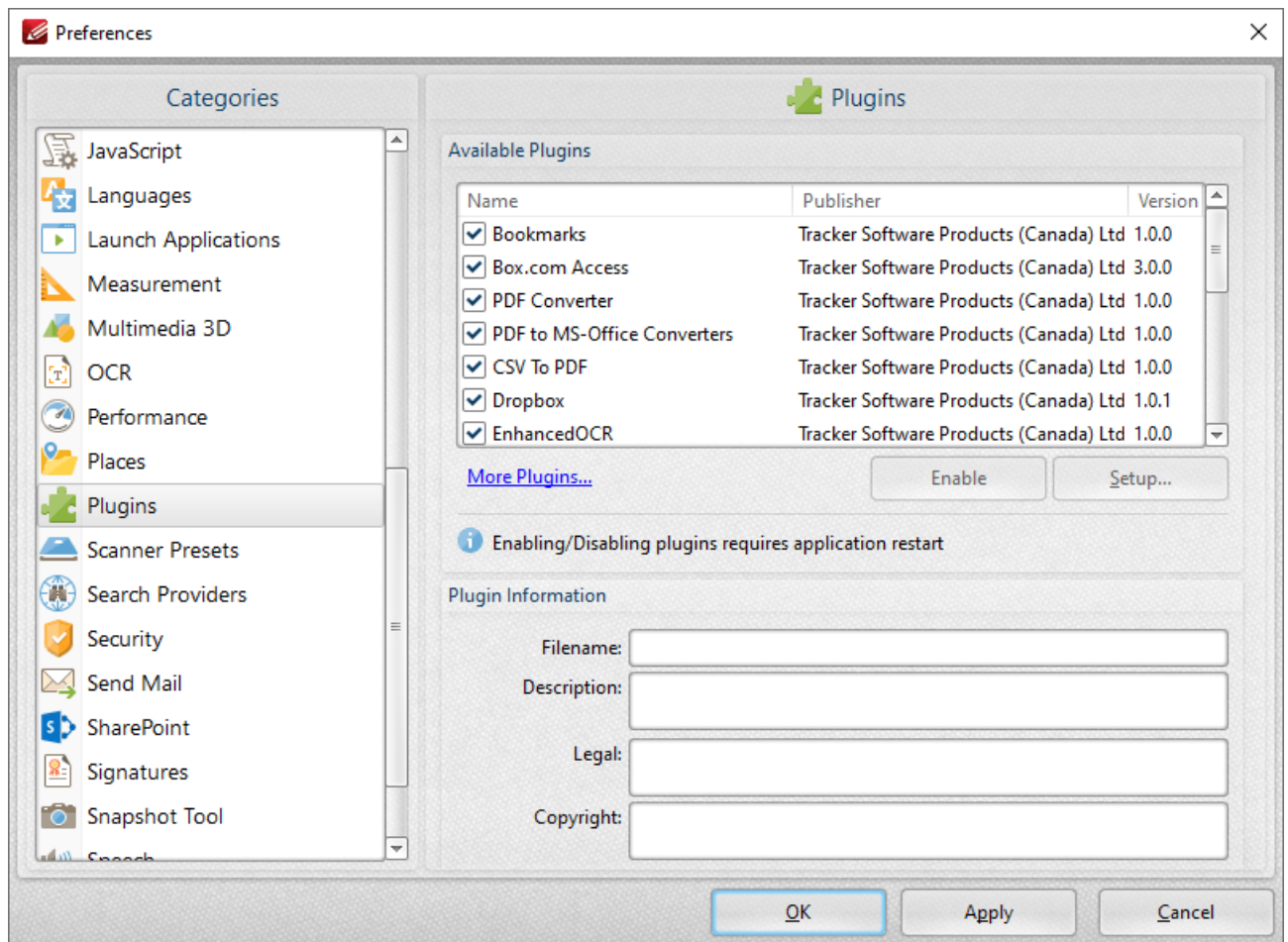

Figure 1. Preferences Dialog Box, Plugins Tab Selected

This dialog box shows plugins available for **PDF-XChange Editor**.

- Select plugins to view their details in the **Plugin information** section.
- Click the **Enable/Disable** buttons to enable/disable selected plugins.
- Click **More plugins** to view further plugins available from **PDF-XChange**.

Click **Apply** to apply changes and **OK** to save changes.

---

## 10.4.1.8.25 Scanner Presets



## Scanner Presets

When the **Scanner Presets** tab is selected the following options are available:

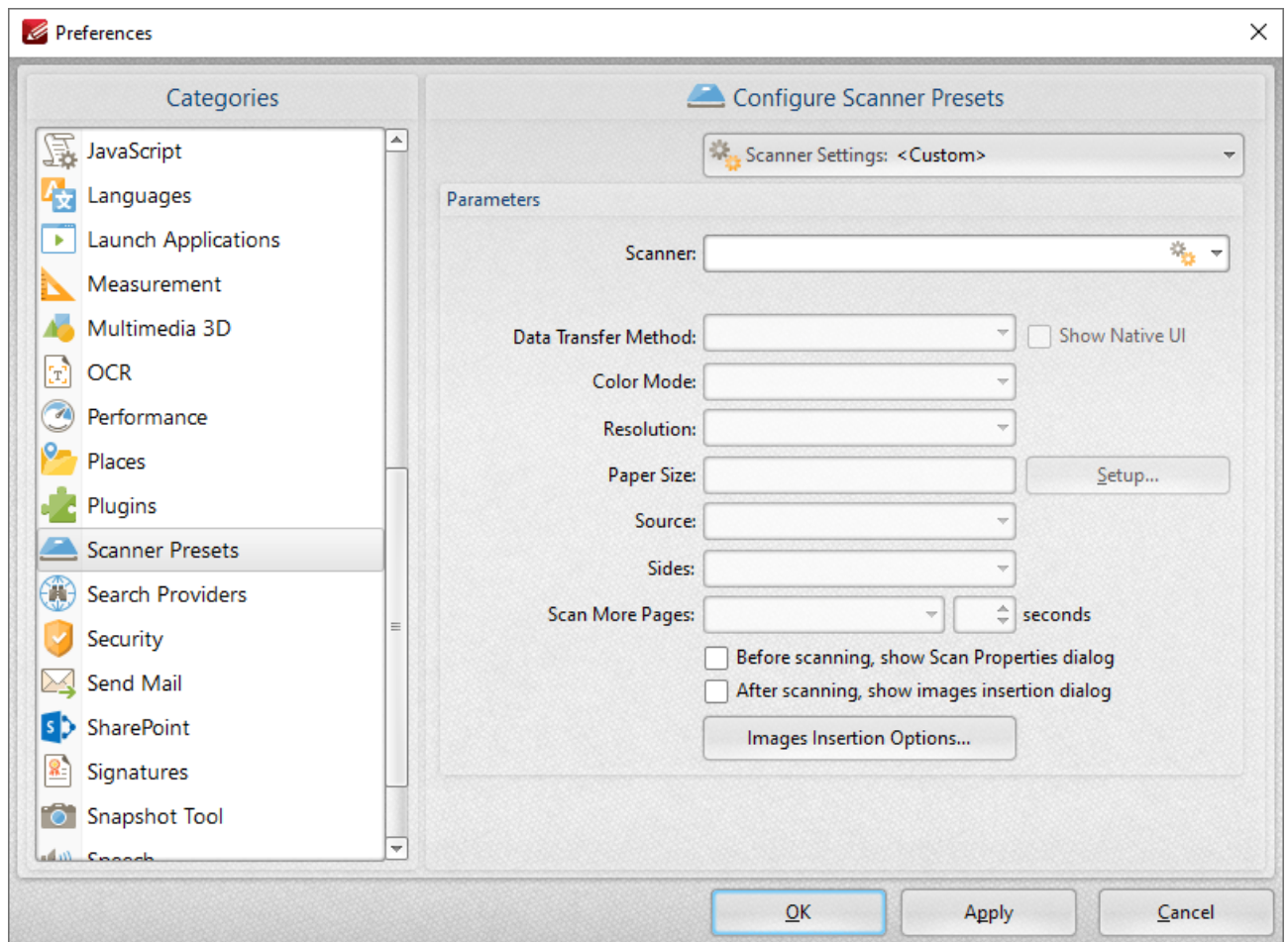

Figure 1. Preferences Dialog Box, Scanner Presets Tab Selected

These settings determine the presets for scanning:

- Click the **Scanner Settings** menu to select a preset scanning mode or a saved profile.
- Click the **Scanner** menu to select a scanner to use.
- Click the **Data Transfer Method** menu to select either **Native Mode** or **Memory Mode**:



- **Native Mode** uses a single memory buffer. This is the default and fastest mode, and is compatible with the broadest range of scanners.
- **Memory Mode** enables the use of multiple memory buffers. This is a useful function in cases where memory is low and/or when large images are being scanned.
- The **Show Native UI** box is selected by default, which means the user interface of the device driver is used. This is the most reliable option, and the scanner will select certain parameters of the scan itself: **Color Mode**, **Resolution**, **Paper Size** and **Source**. Clear the **Show Native UI** box to customize these options:
  - **Color Mode** has four options: **Auto detect**, **Color**, **Grayscale** and **Black & White**.
  - Click the **Resolution** menu to select the **DPI** (dots per inch) of scanned documents.
  - **Paper Size** refers to the size of the paper used when scanning. Click **Setup** for further options:
    - **Automatic** determines the paper size automatically.
    - **Standard** contains standard sizes such as those used by the **ISO** and **ANSI**.
    - **Custom** can be used to enter custom dimensions.
  - **Source** has three options **Auto**, **Flatbed** and **Feeder**. These refer to the type of scanner used for scanning.
- Click the **Sides** menu to determine which sides of documents are scanned. There are three options: **Simple Scan**, **Manual Duplex** and **Manual Duplex Reversed**. Click the dropdown arrow for an explanation of these options.
- Click the **Scan More Pages** menu to select the setting for when additional pages are scanned.
- Select the **Before scanning, show Scan Properties dialog** box to view/edit scan properties before scans take place.
- Select the **After scanning, show images insertion dialog** box to view/edit the images insertion dialog box after the scan has taken place. This dialog box enables image customization.
- Click the **Images Insertion Options** button to determine further options for inserted images. Those options are explained [here](#).<sup>[820]</sup>

Use the **Scanner Settings** menu to save custom settings. Click **Save Current Settings** to create a custom profile for subsequent use. Click **Manage** to manage previously saved profiles and **Delete** to remove the profile currently selected.

Click **Apply** to apply changes and **OK** to save changes.

---

## 10.4.1.8.26 Search Providers



## Search Providers

When the **Search Providers** tab is selected the following options are available:

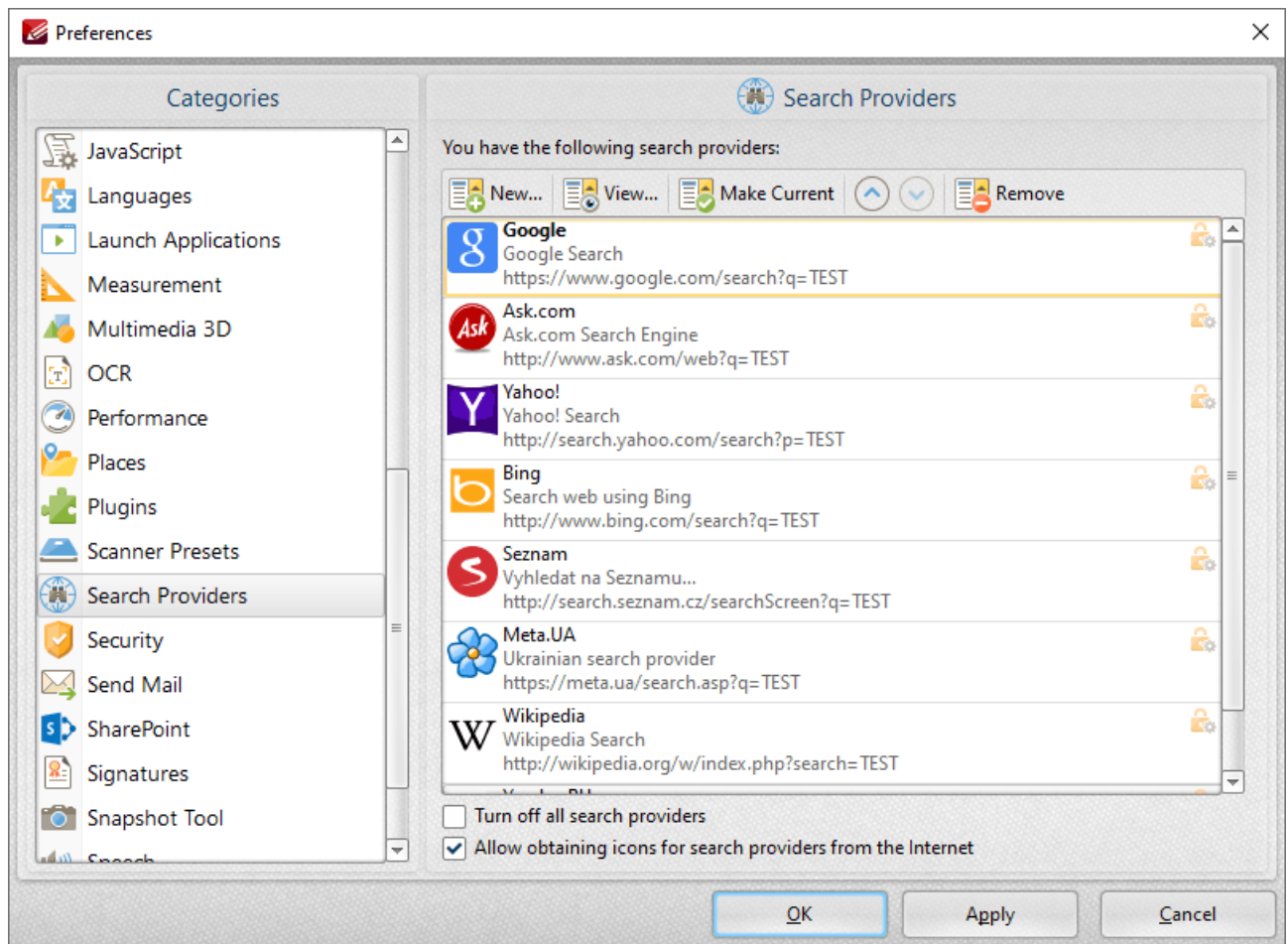

Figure 1. Preferences Dialog Box, Search Providers Tab Selected

This pane displays a list of available search providers. These search providers are used to search the internet for text selected with the **Select Text Tool** in the current document. Select the desired text with the **Select Text Tool** and then right-click the text and click **Internet Search By** to select the desired search provider.

The **Search Providers** preferences dialog box contains the following options:

- Click **New** to add a new search provider.
- Click **Edit** to edit the selected search provider.
- Click **Make Current** to set the selected search provider as the default search provider.
- Use the arrows to move the selected search provider up or down in the display window.
- Click **Remove** to remove the selected search provider.
- Select the **Turn off all search providers** box to disable all search providers.
- Select the **Allow obtaining icons for search providers from the Internet** option to permit the software to obtain search provider icons.

Click **Apply** to apply changes and **OK** to save changes.

---

## 10.4.1.8.27 Security



When the **Security** tab is selected the following options are available:

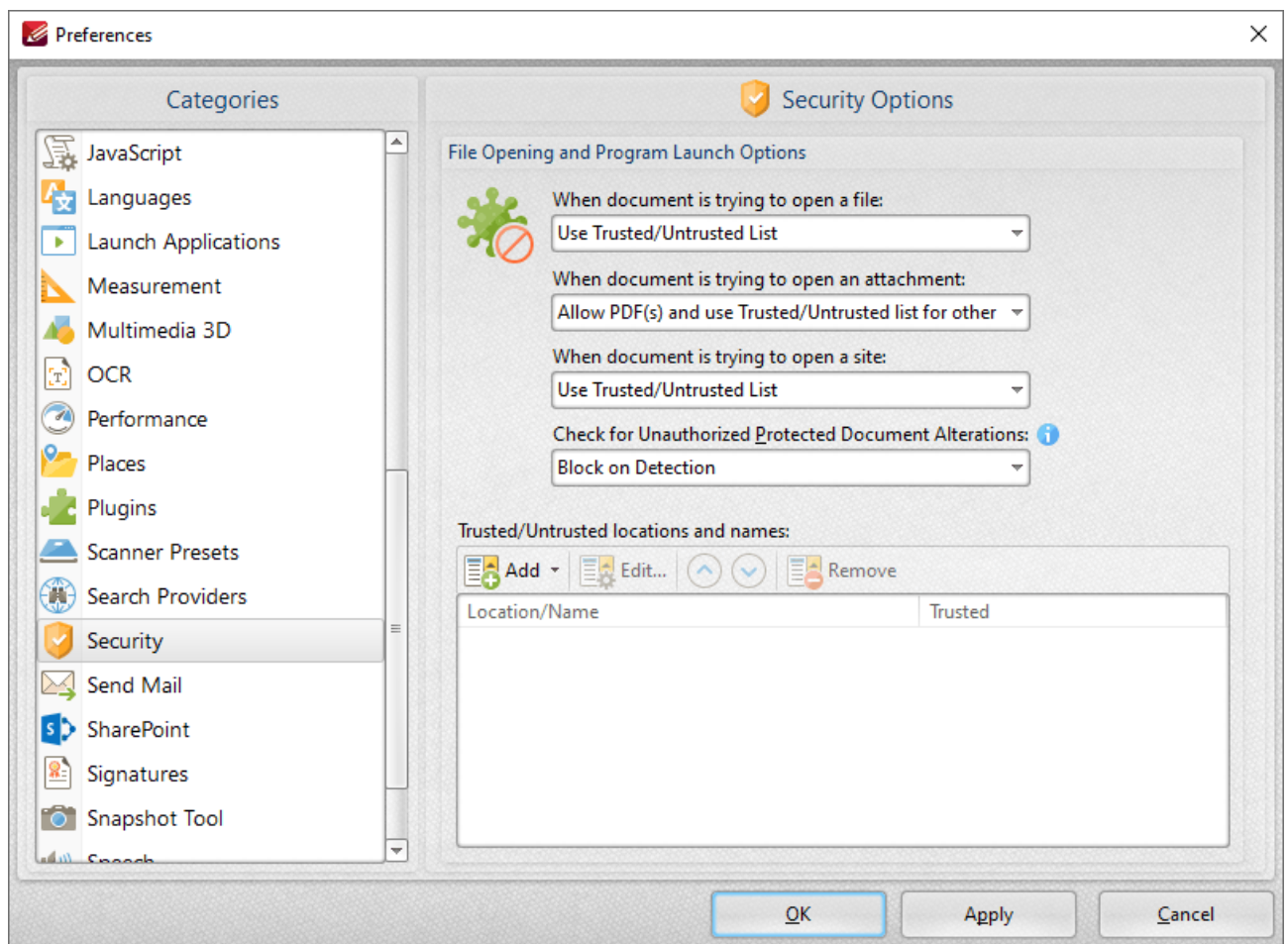

Figure 1. Preferences Dialog Box, Security Tab Selected

The **Security** settings are used to determine the actions that **PDF-XChange Editor** takes when documents attempt to open files/attachments/sites:

- There are four options when the software is opening a file or an attachment:

- **Use Trusted/Untrusted list**, which can be specified using the **Trusted/Untrusted locations and names** text box. If the file/attachment is not specified then **PDF-XChange Editor** will prompt before opening.
  - **Prevent it**, which prevents all files and attachments from being opened. The [Attachments pane](#)<sup>1014</sup> can be used to open attachments when this option is enabled.
  - **Allow it**, which allows all files and attachments to be opened.
  - **Allow PDF(s) and use Trusted/Untrusted list for other**, which allows all PDF files/attachments to be opened and refers to the **Trusted/Untrusted list** for other formats. If a file/attachment is not specified in the list then **PDF-XChange Editor** will prompt before opening it.
- There are three options when the software is opening a site:
    - **Use Trusted/Untrusted list**, which can be specified using the **Trusted/Untrusted locations and names** text box. If the site is not specified in the list then **PDF-XChange Editor** will prompt before opening it.
    - **Prevent it**, which prevents all sites from opening.
    - **Allow it**, which allows all sites to be opened.

Use the **Trusted/Untrusted locations and names** window to determine trusted and untrusted elements. Click **Add** to add new elements. The following menu will be displayed:

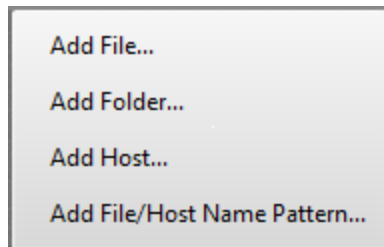

Figure 2. Add Trusted/Untrusted Options

- Click **Add File** to launch the **Add File** dialog box and add files from the local computer.
- Click **Add Folder** to launch the **Add Folder** dialog box and add folders from the local computer.
- Click **Add Host** to launch the **Add New Trusted/Untrusted Item** dialog box. Enter the internet address of the desired host and select **Trusted** or **Untrusted** as required, then click **OK** to save the host.
- Click **Add File/Host Name Pattern** to specify a text pattern as either **Trusted** or **Untrusted**. Text patterns can include any text but are intended for use with file extensions.

Click **Apply** to apply changes and **OK** to save changes.

Additional security options are available [here](#).<sup>845</sup>



## 10.4.1.8.28 Send Mail



## Send Mail

When the **Send Mail** tab is selected the following options are available:

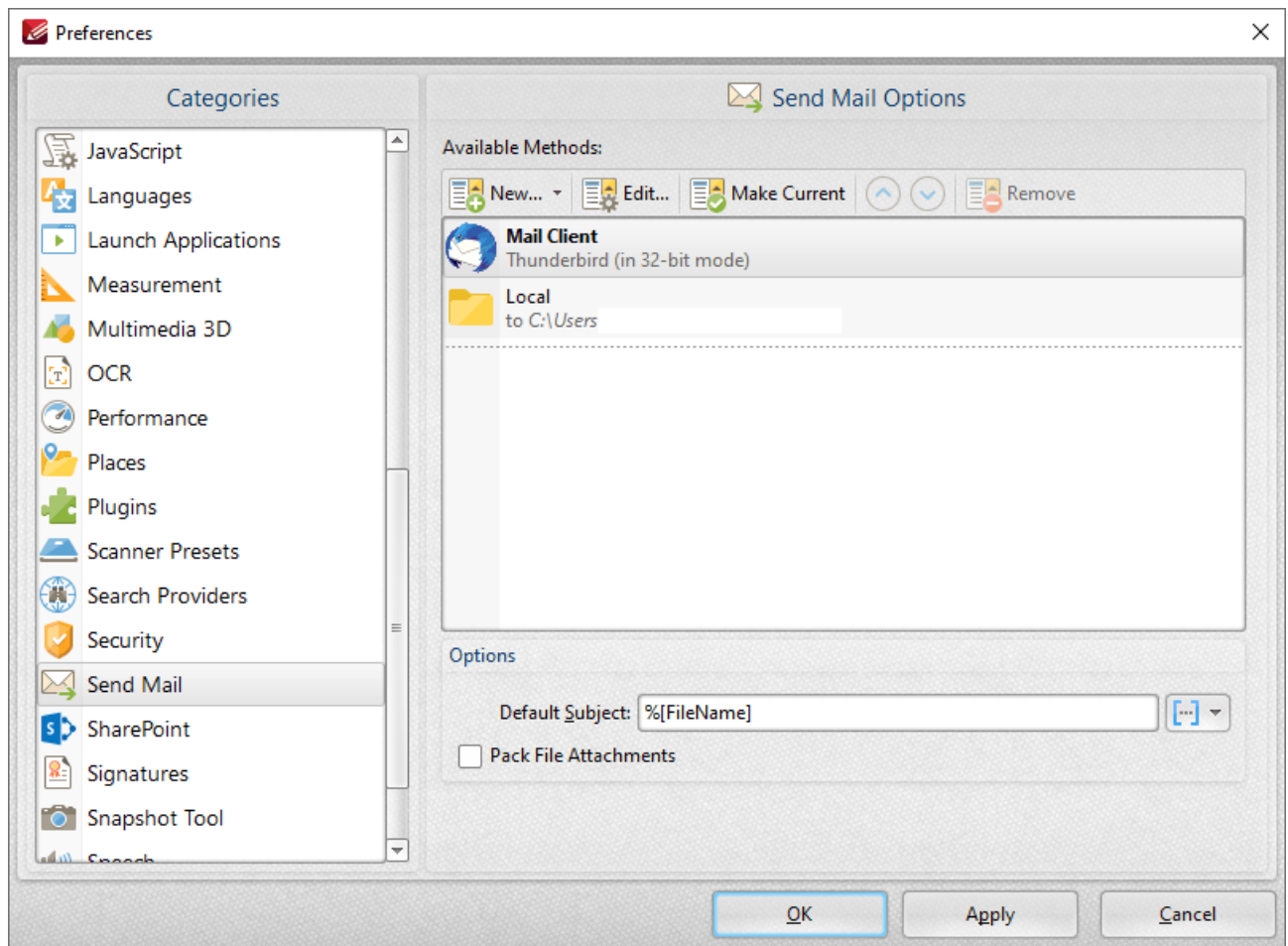

Figure 1. Preferences Dialog Box, Send Mail Tab Selected

These settings determine parameters for the [Send by Email](#)<sup>841</sup> feature of **PDF-XChange Editor**. Existing email methods are displayed in the **Available Methods** pane.

- Click **New** to add new email methods. Select **Custom SMTP**, **Yahoo SMTP**, **Hotmail SMTP**, **Outlook SMTP**, **GMX SMTP**, **Mail.ru SMTP**, **GMail Webmail**, **Outlook Webmail** or **GMail**

**Send** as desired. Please note that the **GMail Send** option operates via **GMail** SMTP and does not open your webmail when the [Send by Email](#)<sup>841</sup> feature is used. It uses your **GMail** credentials to email silently via Google's SMTP, which requires SMTP to be enabled in your **GMail** account, as detailed [here](#).

- Click **Edit** to edit selected email methods.
- Click **Make Current** to enable the selected email method.
- Click **Remove** to remove the selected email method.
- Use the **Default Subject** text box to determine an automated subject line of emails. [Macros](#)<sup>1707</sup> are enabled for this option.
- Select the **Pack File Attachments** box to pack email attachments as **ZIP** files.

Click **Apply** to apply changes and **OK** to save changes.

---



10.4.1.8.29 SharePoint



SharePoint

When the **SharePoint** tab is selected the following options are available:

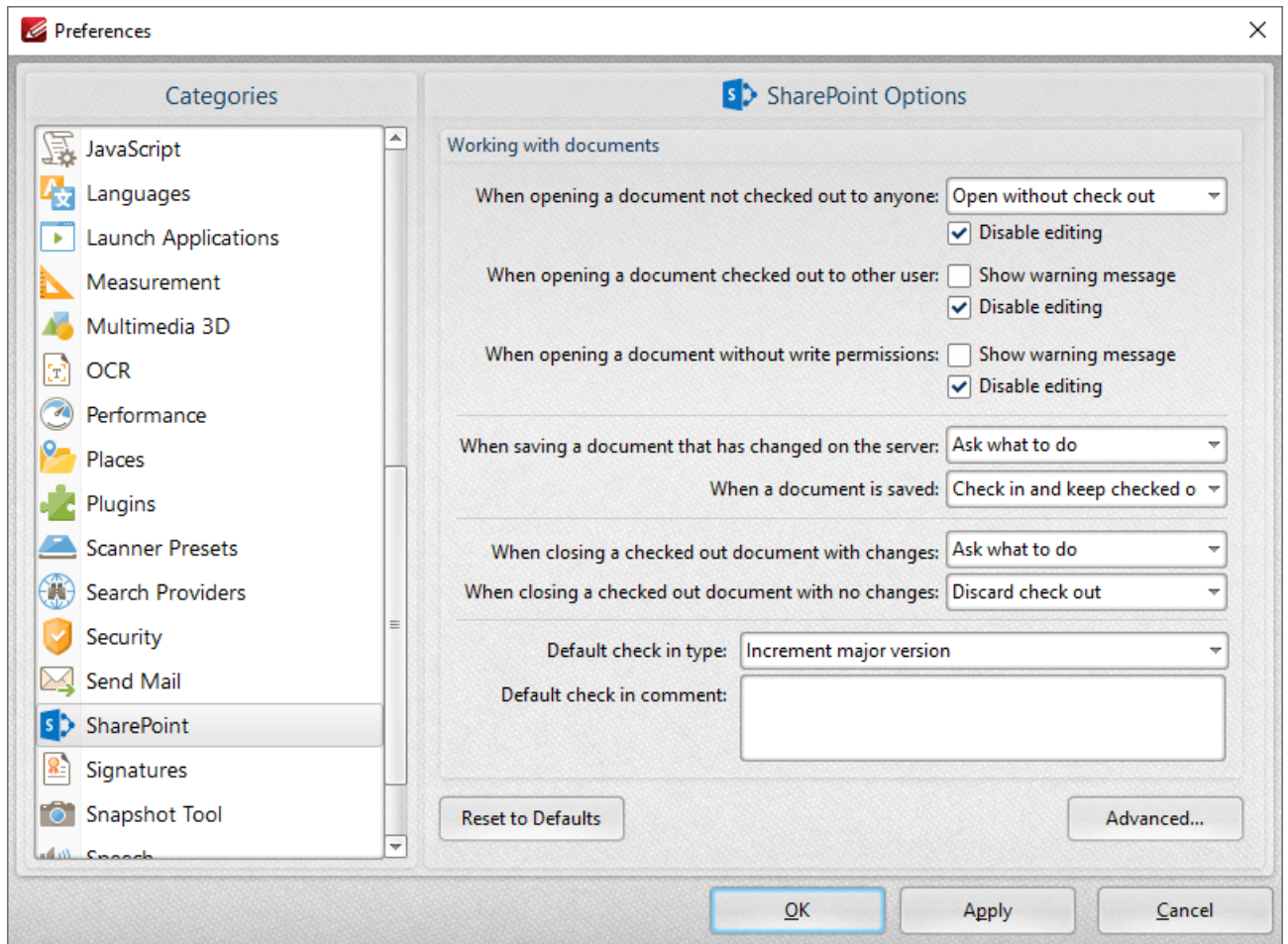

Figure 1. Preferences Dialog Box, SharePoint Tab Selected

Use the dropdown menus and check boxes to determine parameters as desired, then click **Apply** to apply changes and **OK** to save changes.

## 10.4.1.8.30 Signatures



## Signatures

When the **Signatures** tab is selected the following options are available:

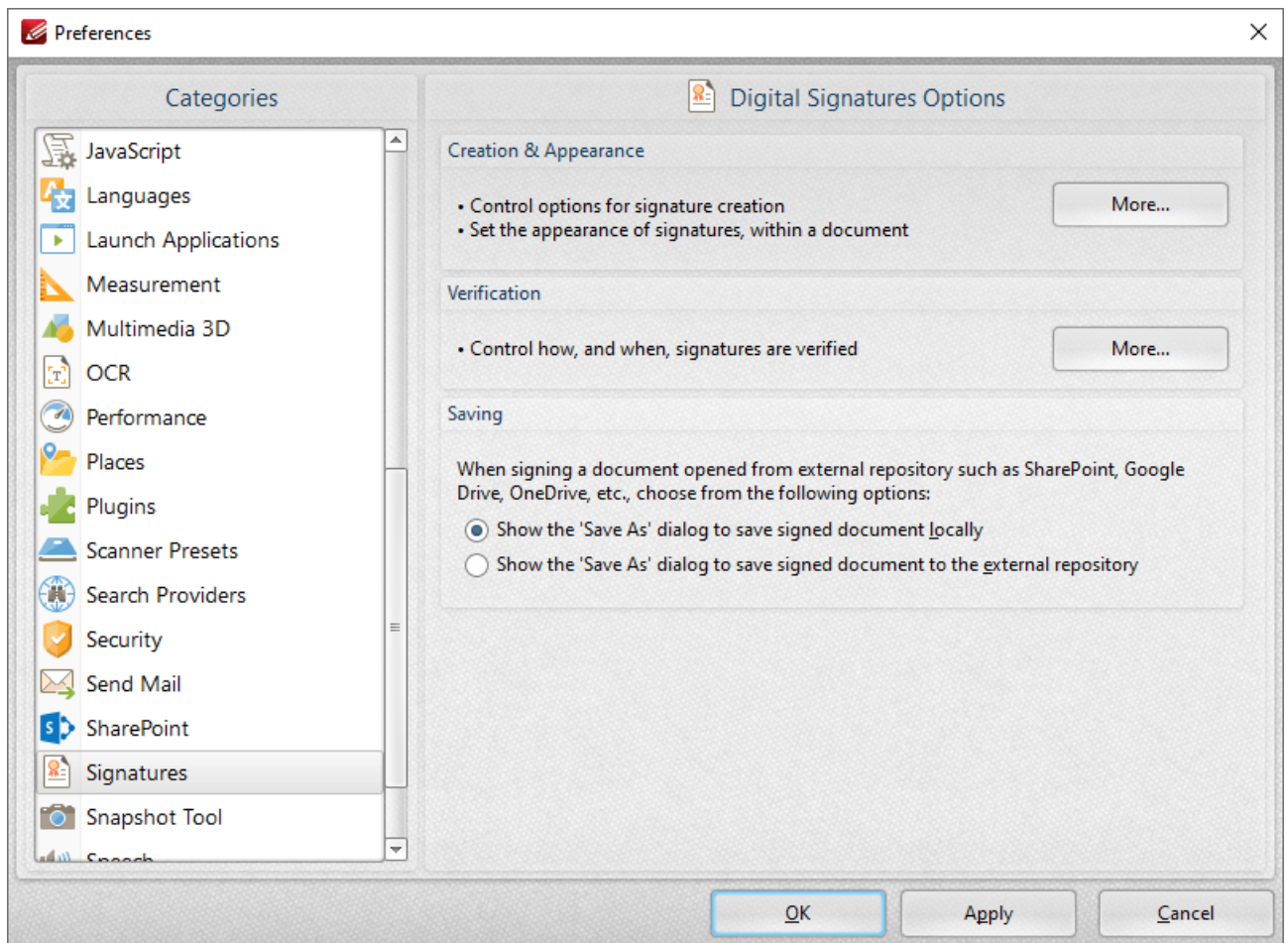

Figure 1. Preferences Dialog Box, Signatures Tab Selected

These options determine the settings for digital signatures:

- The **Creation & Appearance** settings determine the options detailed in **(figure 2)** below. Click **More** to access these settings.

- The **Verification** settings determine how and when signatures are verified. Click **More** to access these settings, then select the check boxes as desired.

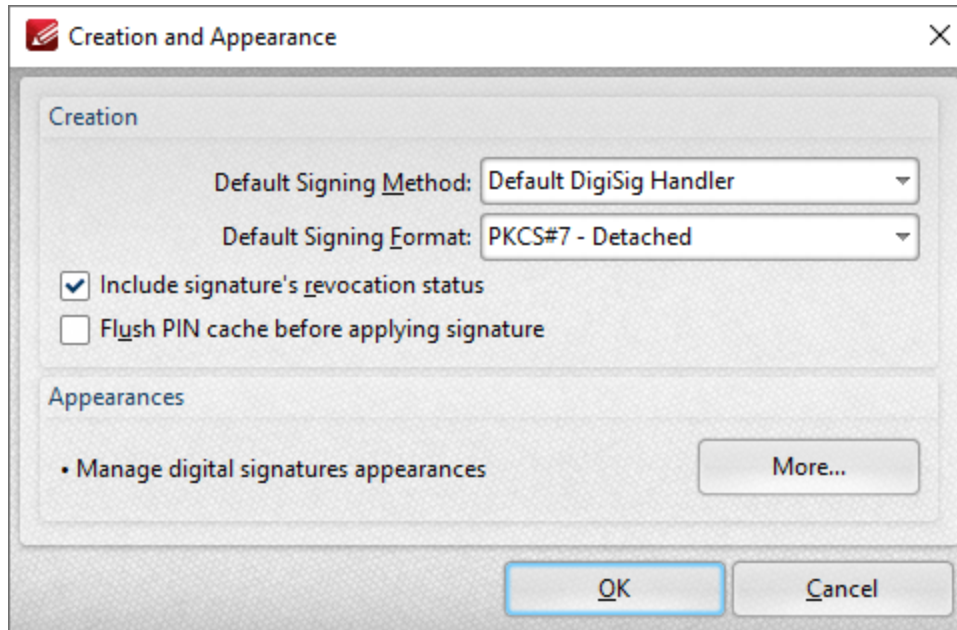

Figure 2. Creation and Appearance Dialog Box

The **Creation** settings are as follows:

- Select an option from the **Default Signing Method** menu to determine the default signing method settings.
- Select an option from the **Default Signing Format** menu to determine the signing format.
  - **PKCS#7 - Detached** encodes certificates in **Abstract Syntax Notation One (ASN.1) format**.
  - **CAdES** is an electronic signature created in compliance with **eIDAS** and has the same legal value as a handwritten signature.
- Select the **Include signature's revocation status** box as desired. The revocation status of the signature will be shown in the main window when this option is enabled. Signatures are long-term validation enabled when this option is selected.
- Select the **Flush PIN cache before applying signature** box as desired.
- Click the **More** button to set the **Digital Sign Appearance Templates**:

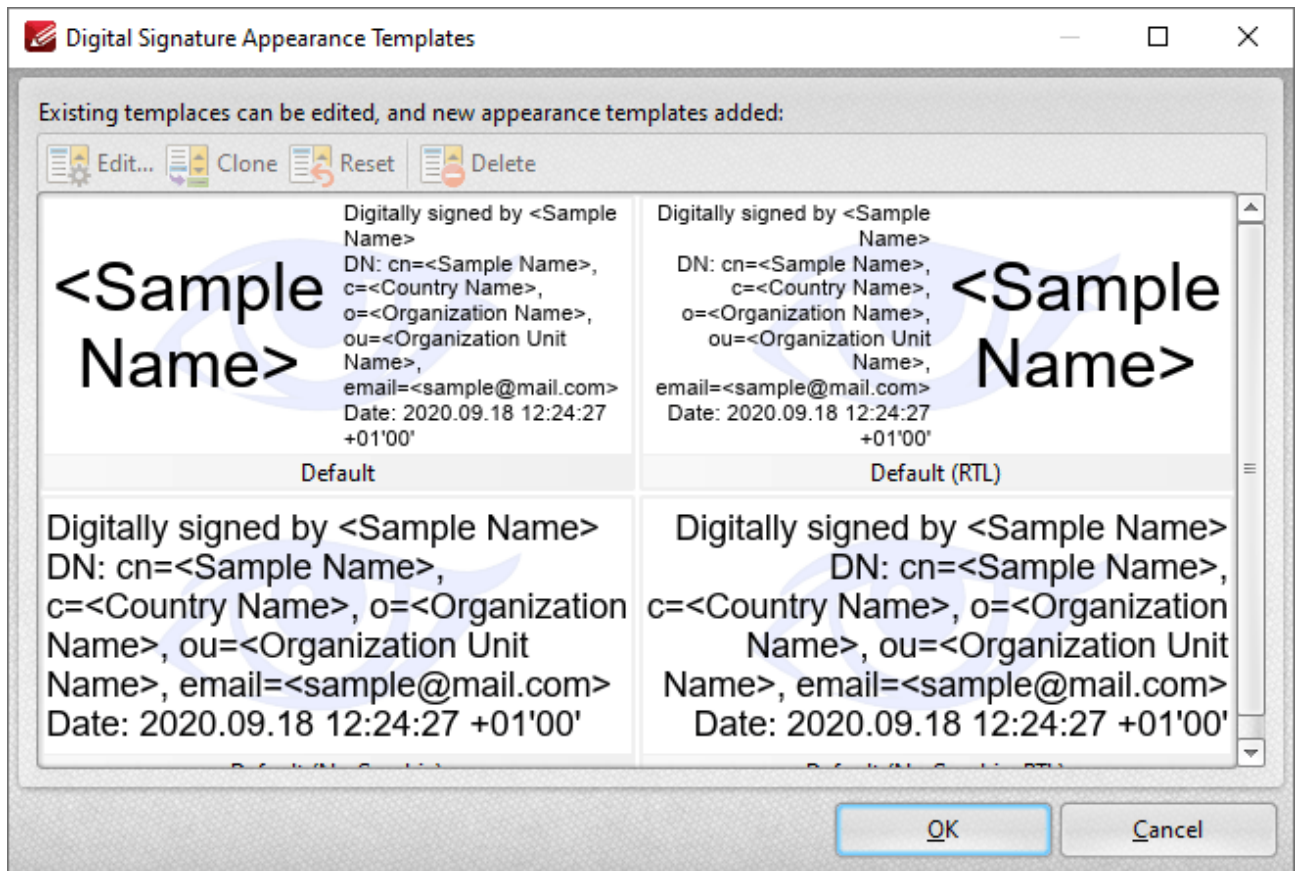

Figure 3. Digital Signature Appearance Templates Dialog Box

- Select signature templates, then select **Clone/Reset/Edit** as desired:
- Click **Clone** to clone the selected signature template. This is a useful feature if parameters of existing signature templates need to be changed and saved without editing the original template.
- Click **Reset** to revert the values of the the selected signature template to its default state.
- Click **Edit** to adjust the values of the selected signature template:

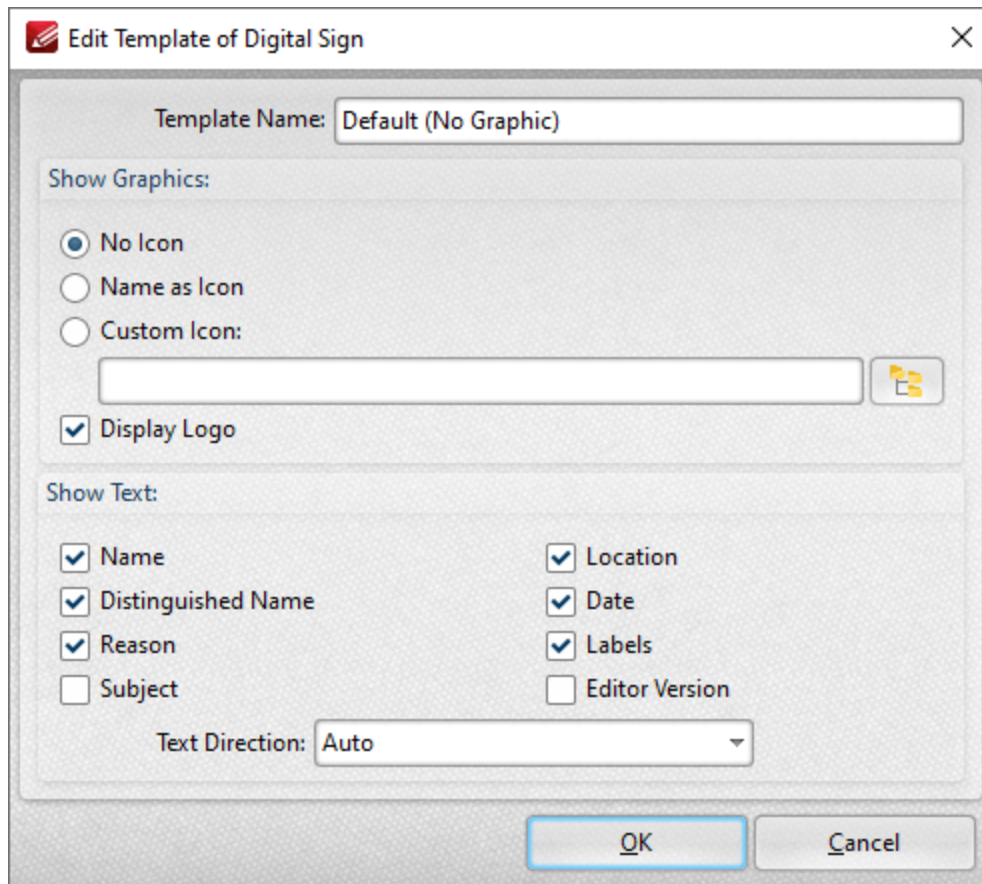

Figure 4. Edit Template of Digital Sign Dialog Box

- Use the **Template Name** text box to edit the name of the signature template.
- Use the **Show Graphics** option buttons to determine the graphics displayed with the template:
  - Select **Name as Icon** to use the name of the current user as the icon.
  - Select **Custom Icon** to use a custom icon. Enter the name of the file to be used in the text box, or click the icon to select a file from the local computer.
- Select the **Display Logo** box to display the logo in the background of signature templates.
- Select the boxes in the **Show Text** section to determine the information that is shown with templates.
- Use the **Text Direction** dropdown menu to determine the text direction.

Click **OK** to save changes.

---

## 10.4.1.8.31 Snapshot Tool

**Snapshot Tool**

The **Snapshot Tool** is used to take document snapshots. When the **Snapshot Tool** tab is selected the following options are available:

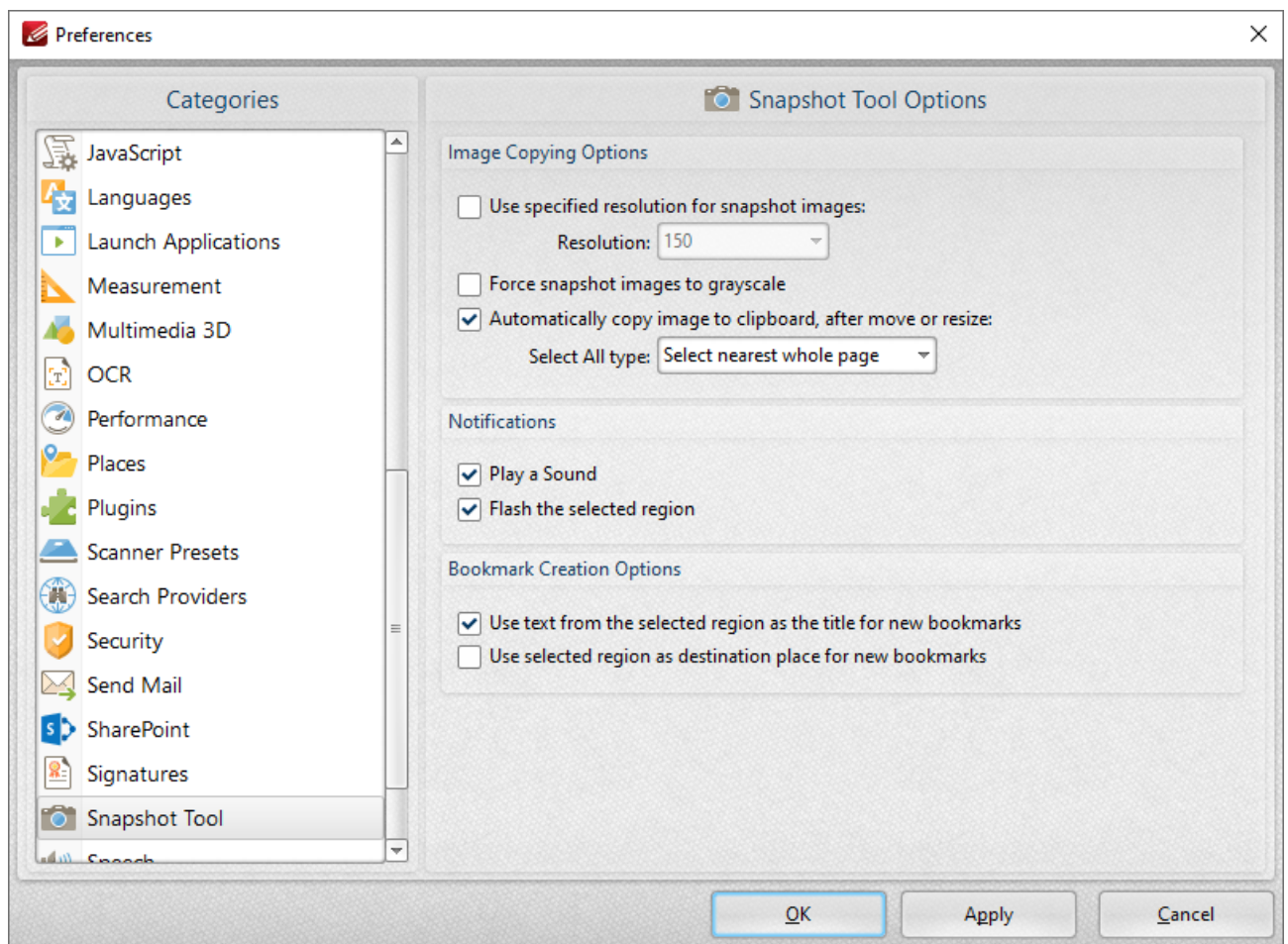

**Figure 1.** Preferences Dialog Box, Snapshot Tool Tab Selected

The **Image Copy Options** determine the settings for images that the **Snapshot** tool produces:

- Use the **Resolution** dropdown menu to specify the image resolution for snapshots.
- Select the **Force snapshot images to grayscale** box as desired.

- Select the **Automatically copy image to clipboard, after move or resize** box as desired.
- Use the **Select All type** dropdown menu to determine the **Select All** setting. This option is available in the right-click shortcut menu when the **Snapshot Tool** is selected. The options are:
  - **Select nearest whole page**, which takes a snapshot of the nearest whole page.
  - **Select visible portion of nearest page**, which takes a snapshot of the visible portion of the nearest page.
- Select the check boxes in the **Notifications** section as desired.

Click **Apply** to apply changes and **OK** to save changes.

---

## 10.4.1.8.32 Speech



## Speech

When the **Speech** tab is selected the following options are available:

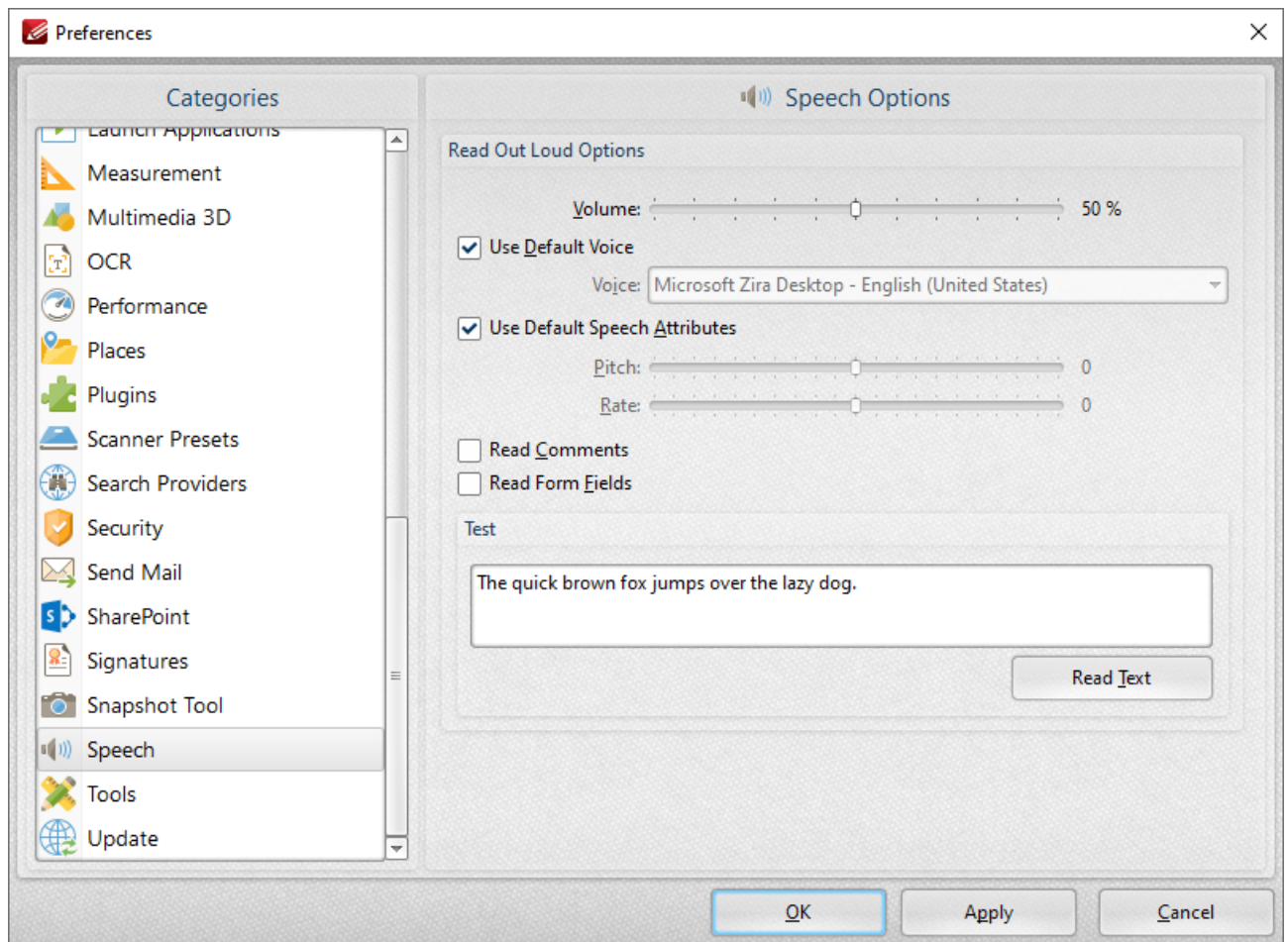

Figure 1. Preferences Dialog Box, Speech Tab Selected

These settings determine the options for the read out loud feature of **PDF-XChange Editor**:

- Select the **Use default voice** box as desired. Clear this box to choose an alternative voice from the **Voice** menu.



- Select the **Use default speech attributes** box as desired. Clear this box to adjust the **Pitch** and **Rate** settings.
- Select the **Read comments** and **Read Form Fields** boxes as required.
- Use the **Test** text box to test customized settings. Enter sample text into the text box and click **Read this text** to test settings.

Instructions on how to use the **Read Out Loud** feature are available [here](#).

Click **Apply** to apply changes and **OK** to save changes.

---

## 10.4.1.8.33 Tools

**Tools**

When the **Tools** tab is selected the following options are available::

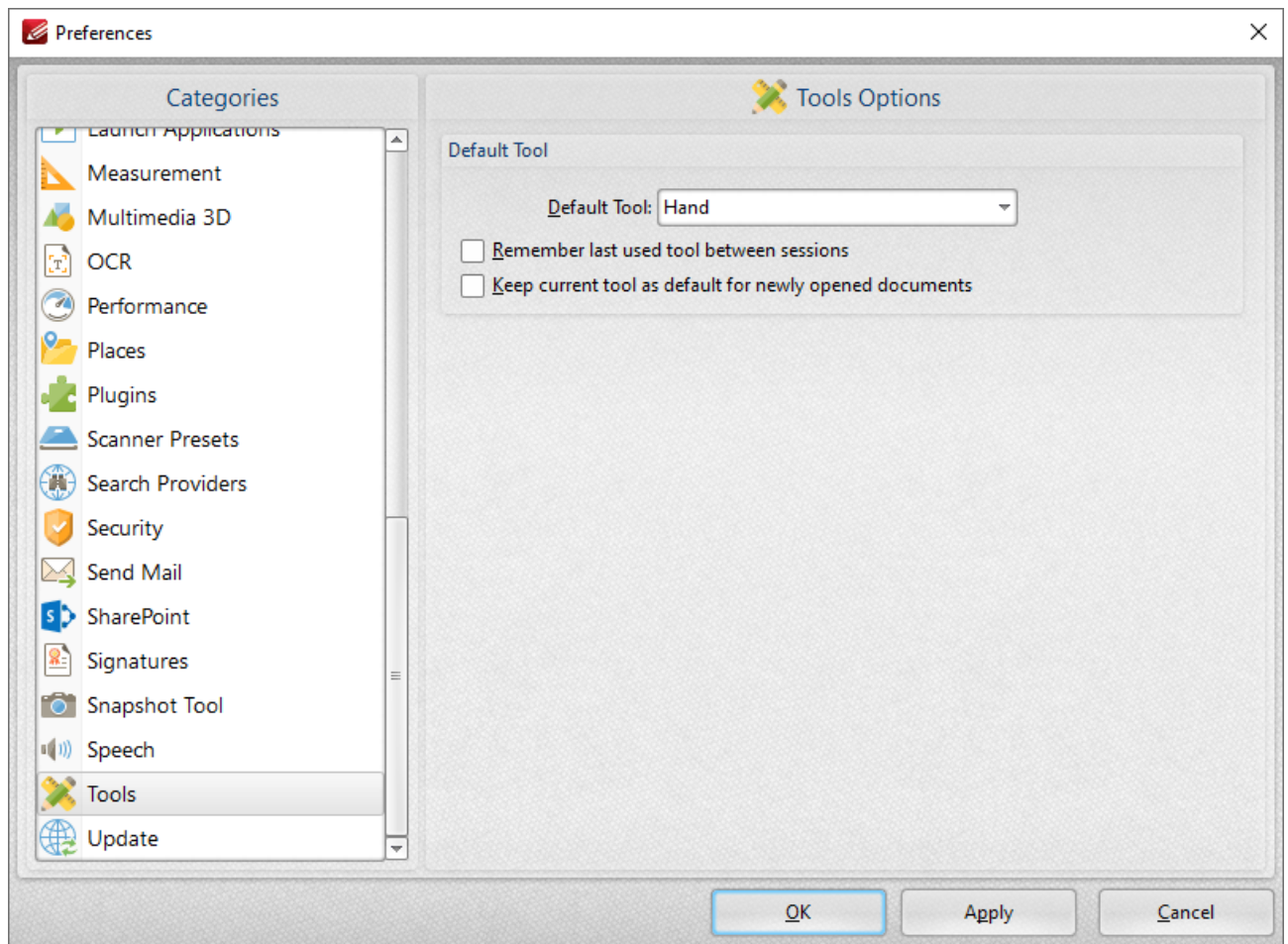

**Figure 1.** Preferences Dialog Box, Tools Tab Selected

- Use the **Default Tool** menu to select the default tool in **PDF-XChange Editor**.
- Select the upper check box to retain the active tool between sessions.
- Select the lower check box to retain the active tool when new documents are opened.

Click **Apply** to apply changes and **OK** to save changes.



#### 10.4.1.8.34 Update

---



#### Update

---

The **Update** tab is used to check for software updates. Click **Check for Updates Now** to search for updates.

---

10.4.1.9 Manage Settings



Manage Settings

Click **Manage Settings** to **Export/Import/Reset** settings in **PDF-XChange Editor**:

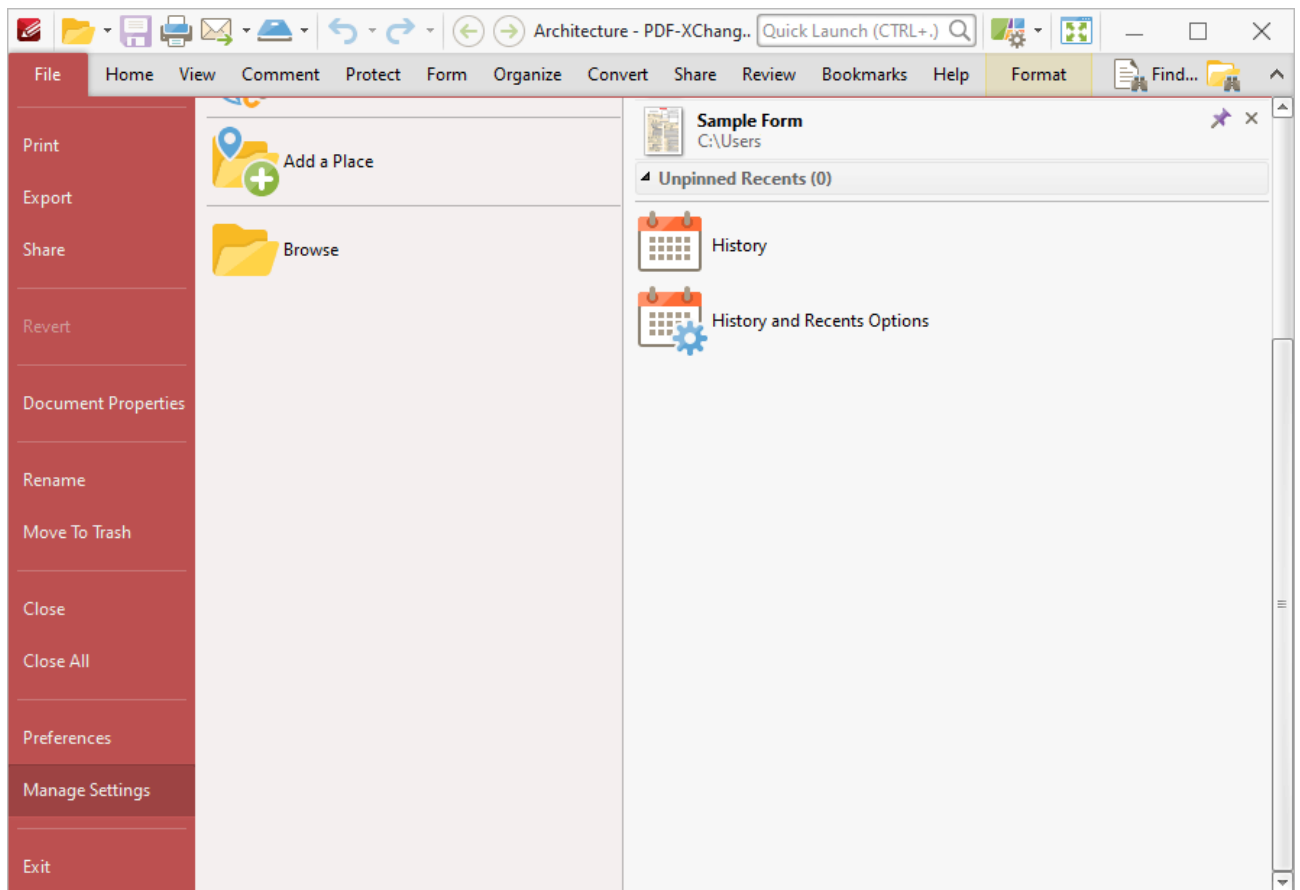

Figure 1. File Tab Submenu, Manage Settings

The following options will be displayed:

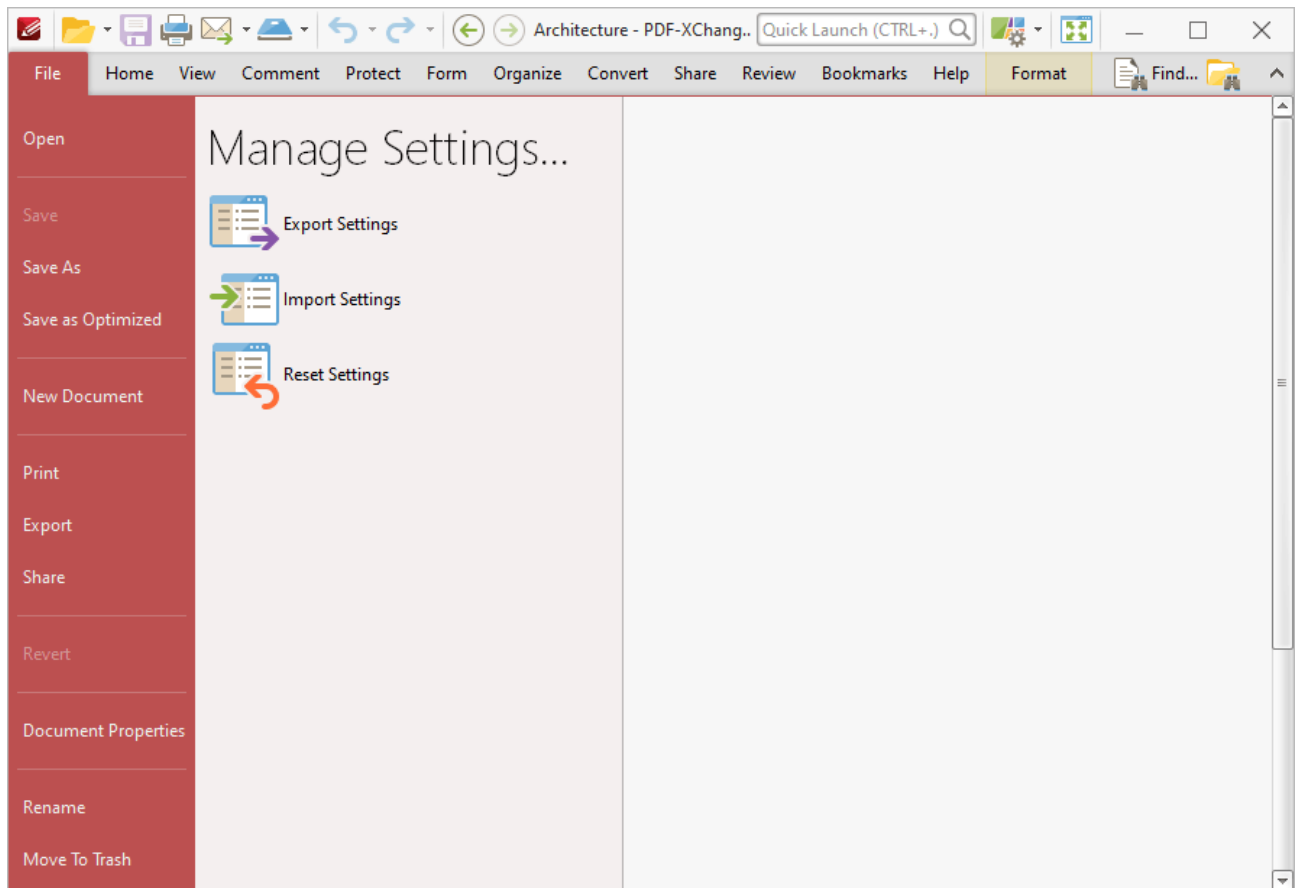

Figure 2. Manage Settings Options

## Export Settings

Click **Export Settings** to export the current settings of **PDF-XChange Editor** to a data file. The **Export Settings Options** dialog box will open:

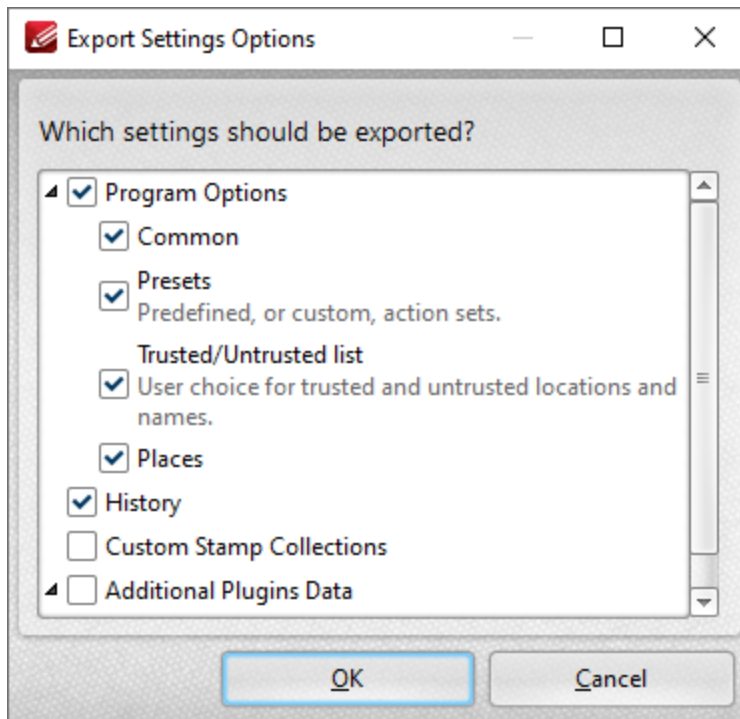

Figure 2. Export Settings Options Dialog Box

Select the settings to be exported and click **OK** to export.

## Import Settings

Click **Import Settings** to import saved settings. The **Import Settings from File** dialog box will open. Select the desired settings file and click **Open**. The **Import Settings Options** dialog box will open:

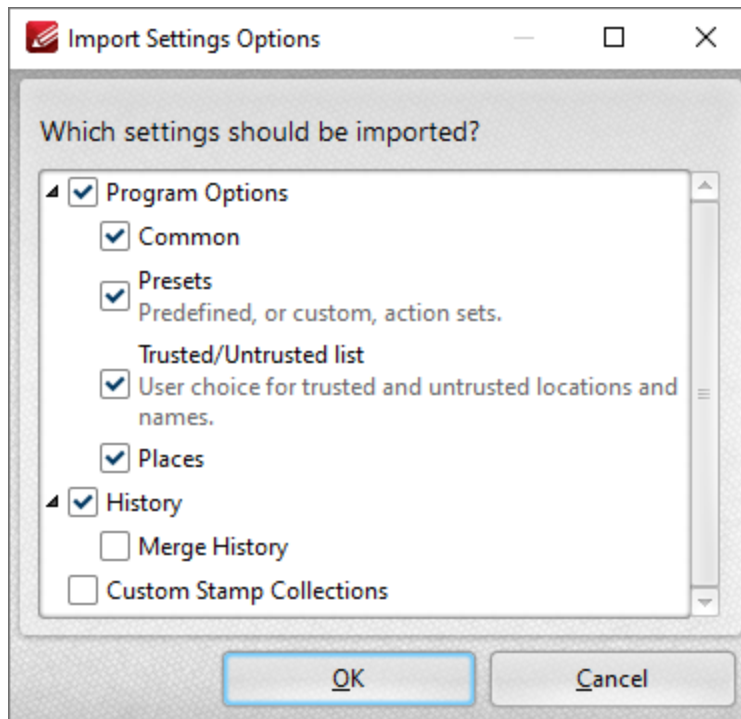

Figure 3. Import Settings Options Dialog Box

Select the desired settings and click **OK** to import.

### Reset Settings

Click **Reset Settings** to revert the current settings of **PDF-XChange Editor** to their default values. The following dialog box will be displayed:



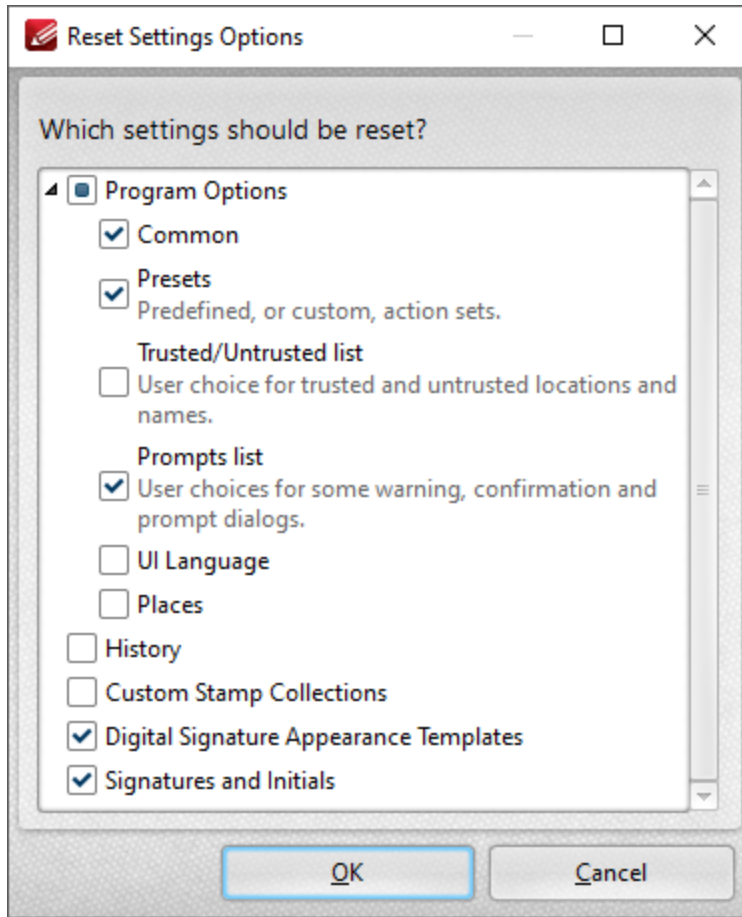

Figure 4. Reset Settings Options Dialog Box

Select the desired settings and click **OK** to reset them.

---

10.4.2 Home Tab



Home Tab

When the **Home** tab is selected, the following options are available:

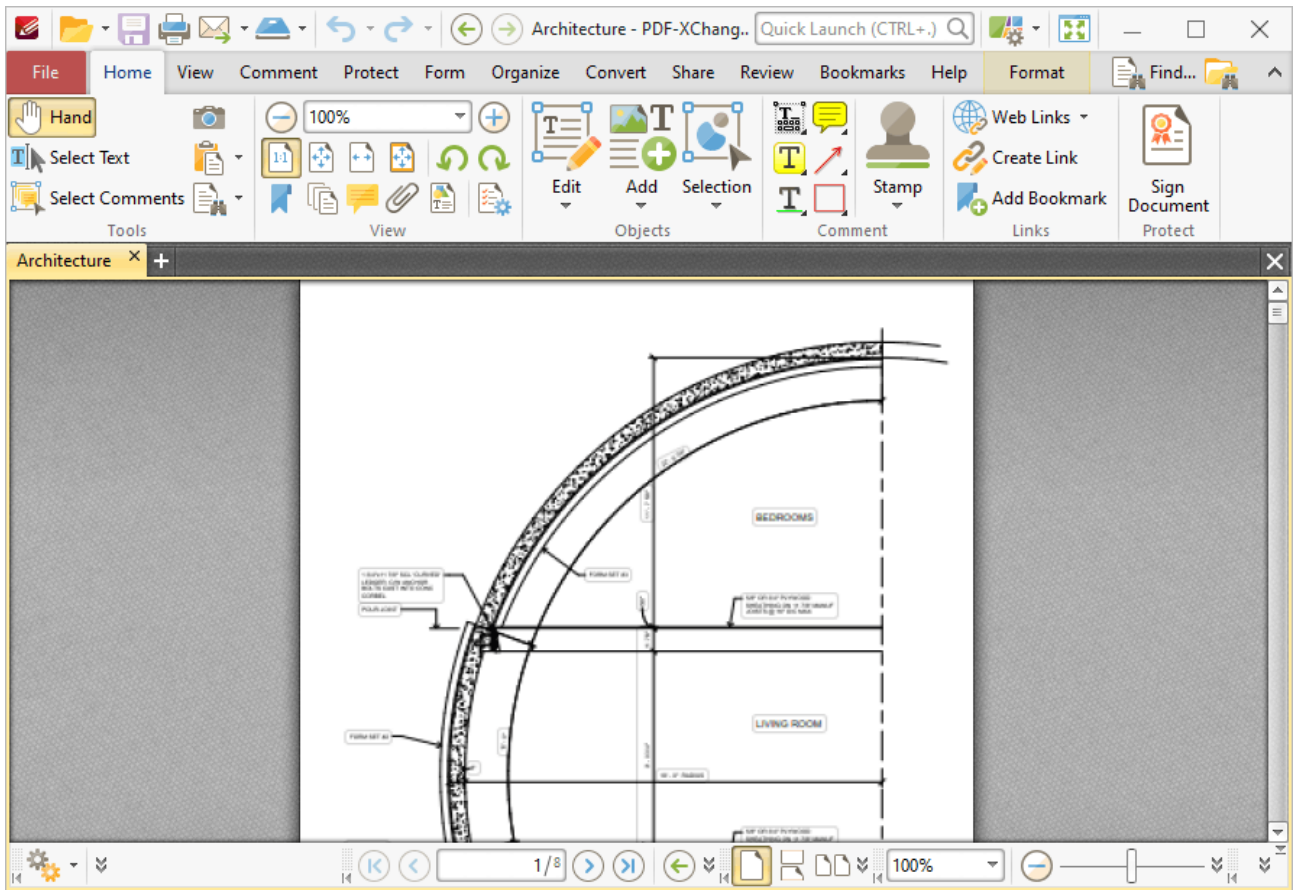

Figure 1. Home Tab

There are five groups in the **Home** tab:

**Tools**

The **Tools** group contains the most commonly-used tools:

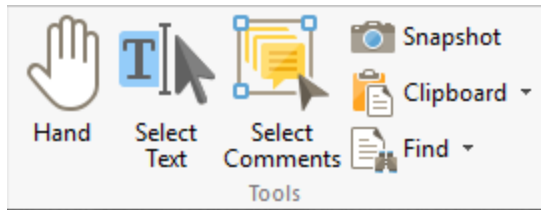

Figure 2. Tools Group

- The **Hand Tool** is used as a basic scrolling device and navigation aid when browsing through documents. Click to enable the **Hand Tool**, then click and drag the page in the desired scrolling direction in order to browse through documents. Further information about the **Hand Tool** and its settings is available [here](#).<sup>[943]</sup>
- The **Select Text Tool** is used to select base-content text. Click to enable the **Select Text Tool**, then click and drag the pointer to select text. Double-click to select words, triple-click to select paragraphs and quadruple-click to select all text on the current page. Right-click selections for editing options, as detailed [here](#).<sup>[1651]</sup>
- The **Select Comments Tool** is used to select and edit comments. Click to enable the **Select Comments Tool**, then click to select comments. Click and drag to select multiple comments. Selected comments can be edited, as detailed [here](#).<sup>[1087]</sup>
- The **Snapshot Tool** is used to take screenshots of pages/selected page content. Click to enable the **Snapshot Tool**, then click or click and drag to take snapshots. Further information about this tool is available [here](#).<sup>[926]</sup>
- The options in the **Clipboard** dropdown menu is used to interact with the current content of the clipboard. Click the dropdown menu to cut/copy/paste clipboard content.
  - The **Find** feature is used to [Find](#)<sup>[1688]</sup> or [Search](#)<sup>[1776]</sup> text, or to search the internet for text selected with the **Select Text Tool** in the current document.

## View

The **View** group contains the most commonly-used viewing commands:

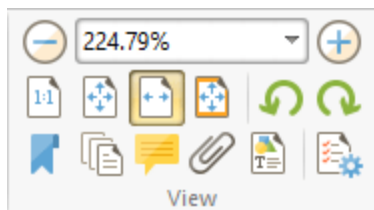















Figure 3. View Group

Use the    **Zoom** feature to change the level of zoom. Click the plus and minus icons, select an option in the dropdown menu or enter a value manually to change the zoom level.

Click  **Actual Size** to set the zoom level to 100% and view pages at their actual size.

- Click  **Fit Page** to fit the page length to the editing space of the user interface.
- Click  **Fit Width** to fit the page width to the editing space of the user interface.
- Click  **Fit Visible** to fit the page width to the editing space of the user interface and ignore white page margins.
- Click  **Rotate CCW** to rotate the current view ninety degrees counter-clockwise.
- Click  **Rotate CW** to rotate the current view ninety degrees clockwise.
- Click  **Bookmarks** to show/hide the [Bookmarks](#)<sup>994</sup> pane, which is used to create/edit bookmarks.
- Click  **Thumbnails** to show/hide the [Thumbnails](#)<sup>1000</sup> pane, which is used to view/edit document pages.
- Click  **Comments** to show/hide the [Comments](#)<sup>1007</sup> pane, which is used to view/edit comments.
- Click  **Attachments** to show/hide the [Attachments](#)<sup>1014</sup> pane, which is used to view/edit attachments to the current document.
- Click  **Content** to show/hide the [Content](#)<sup>1032</sup> pane, which is used to view/edit base content.
- Click  **Properties** to show/hide the [Properties](#)<sup>1065</sup> pane, which is used to view/edit the properties of selected items.

## Objects

The **Objects** group contains options for adding and editing document content:

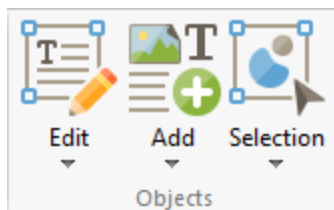

Figure 4. Objects Group

- Click **Edit** to edit base content and images. Further information about this feature is available [here](#).<sup>1638</sup>
- Click **Add** to add content to documents. Use the dropdown menu to select **Text**, **Image** or **Barcode** as desired. Further information on these options is available [here](#).<sup>1648</sup>
- Click **Selection** to edit/interact with the content currently selected in the document. Further information about this feature is available [here](#).<sup>1682</sup>

## Comment

The **Comment** group contains options for adding comments to documents:

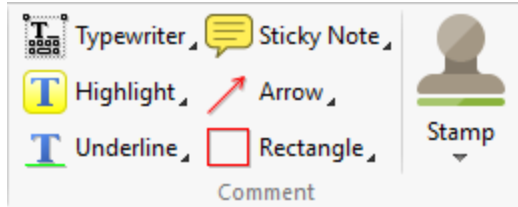

Figure 5. Comment Group

- Click **Typewriter** to add a typewriter-style comment to documents, as detailed [here](#).<sup>[1089]</sup>
- Click **Sticky Note** to add a sticky note comment to documents, as detailed [here](#).<sup>[1105]</sup>
- Click **Highlight** to highlight document text, as detailed [here](#).<sup>[1120]</sup>
- Click **Arrow** to add arrow annotations to documents, as detailed [here](#).<sup>[1149]</sup>
- Click **Underline** to underline document text, as detailed [here](#).<sup>[1125]</sup>
- Click **Rectangle** to add rectangle annotations to documents, as detailed [here](#).<sup>[1162]</sup>
- Click **Stamp** to add stamps to documents, as detailed [here](#).<sup>[1188]</sup>

Right-click options to view/select preset comment styles.

## Links

The **Links** group contains options for creating links/bookmarks:

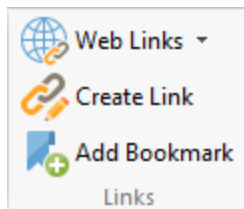
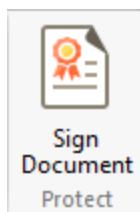

Figure 6. Links Group

- Click **Weblinks** to create/remove weblinks in the current document. Note that weblinks are created from existing URLs in the document when the **Create Weblinks** option is used. Further information about this feature is available [here](#).<sup>[956]</sup>
- Click **Create Link** to create links in the active document. A range of additional actions can be added to links, as detailed [here](#).<sup>[956]</sup>
- Click **Add Bookmark** to create a new bookmark from the current document location. Further information about bookmarks is available [here](#).<sup>[994]</sup>

## Protect

The **Protect** group contains one option:



**Figure 7.** Protect Group

Click **Sign Document** to add a digital signature to documents. Further information about this feature is available [here](#).<sup>1249</sup>

---

### 10.4.2.1 Hand Tool



## Hand Tool

The **Hand Tool** is used as a basic scrolling device and navigation aid when browsing through documents. It is located in the upper-left section of the UI in several of the tabs:

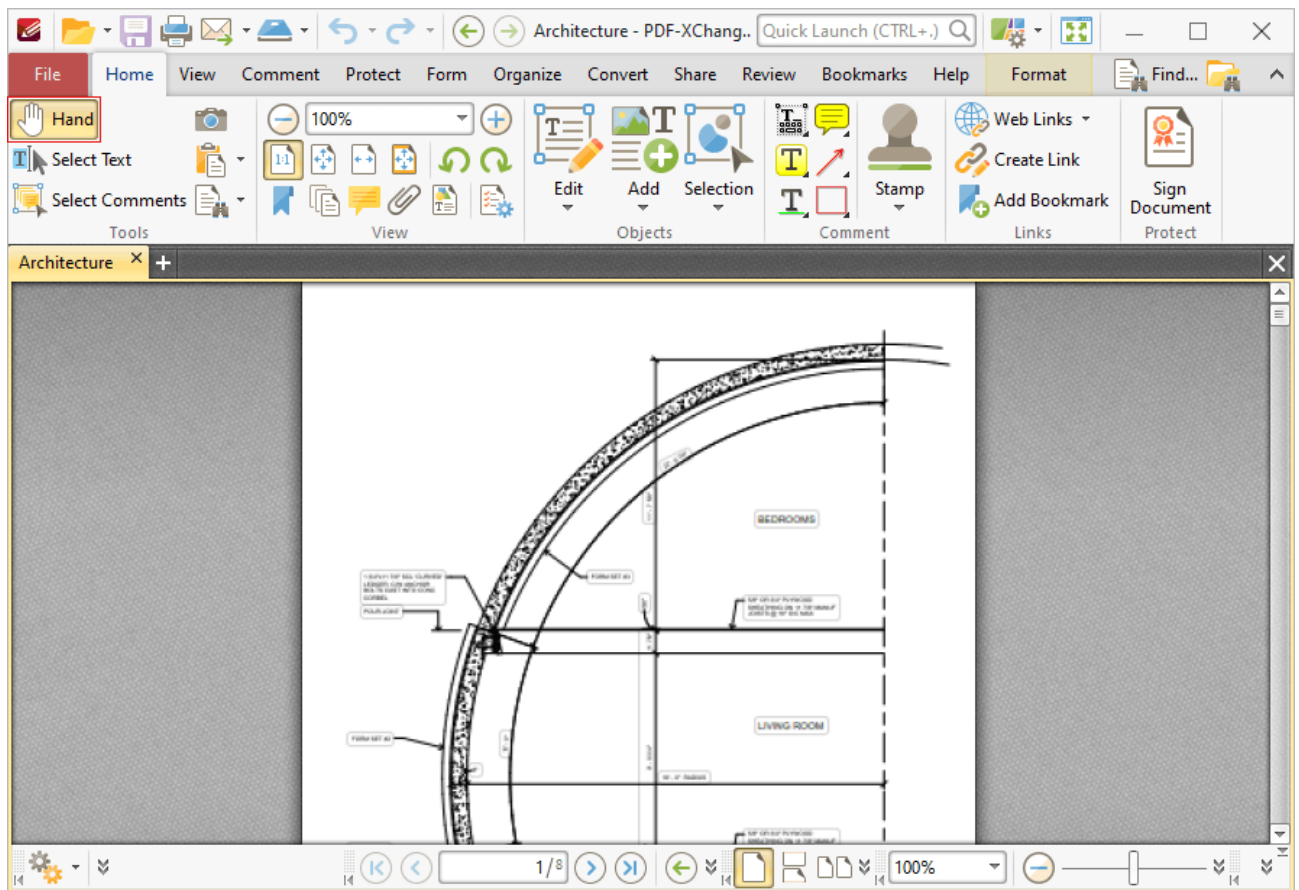

Figure 1. Home Tab, Hand Tool Highlighted

Click to enable the **Hand Tool**, then click and drag the page in the desired scrolling direction in order to browse through documents. When the **Hand Tool** is selected, click the **Format** tab to customize how the tool operates:

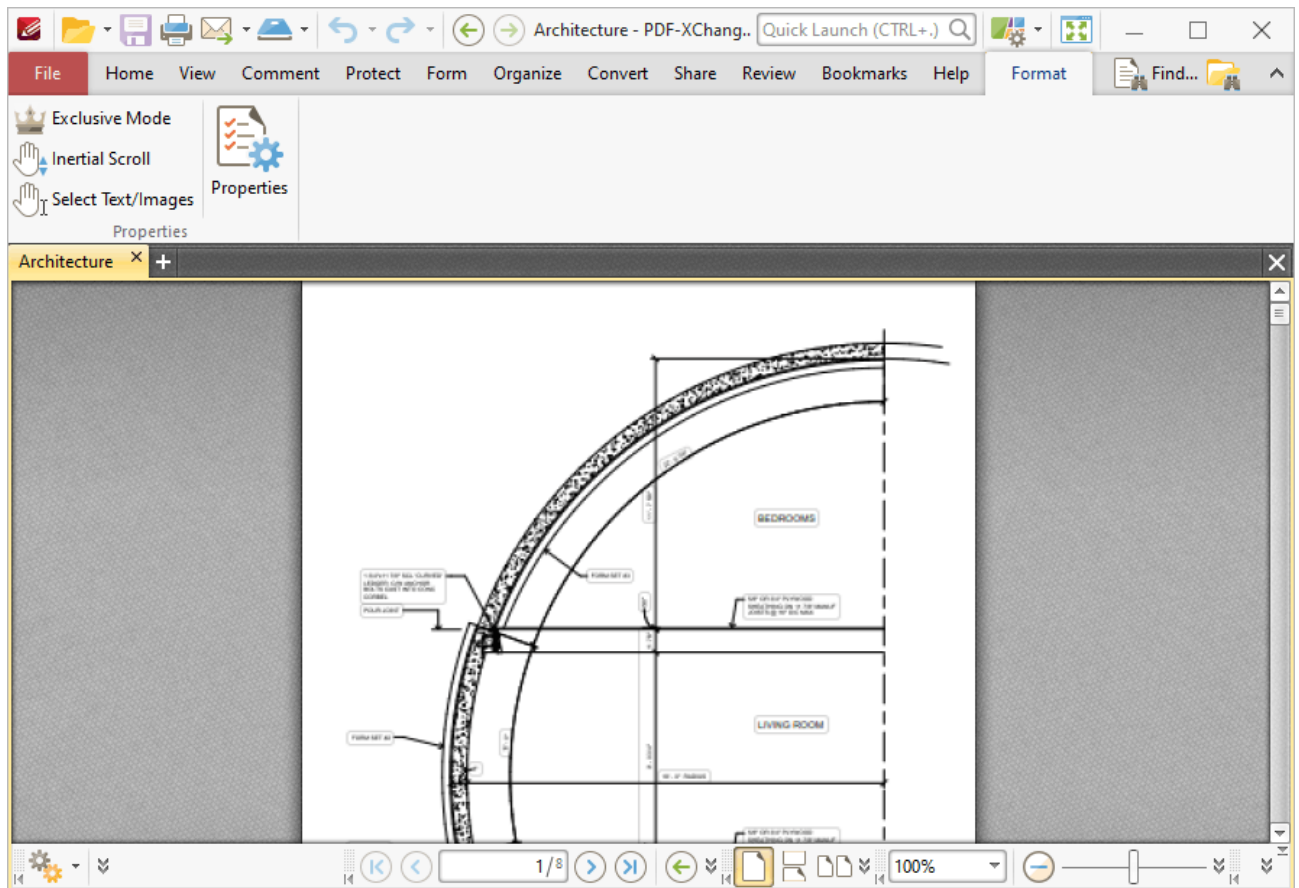

Figure 2. Hand Tool, Format Tab

- Click **Exclusive Mode** to enable exclusive mode, which simplifies the process of using the **Hand Tool**. When **Exclusive Mode** is enabled, the pointer ignores all interactive elements of documents other than base content. This makes it possible to click on areas that overlap with other content and navigate through documents without the risk of accidentally selecting undesired items. When **Exclusive Mode** is disabled, the pointer recognizes and interacts with all underlying elements in the usual manner.
- Click **Inertial Scroll** to enable inertial scroll. When this feature is enabled, document pages will continue to scroll and come to a stop gradually after scrolling actions are performed. When it is disabled document pages will scroll in synchronization with the pointer.
- Click **Select Text/Images** to enable the selection of text and images with the **Hand Tool**. The tool will then be able to select text/images when it is hovered over text-based/image content, and indicates that it is able to do so via a change in the cursor. Click and drag to select text, or click to select images. Note that you can also double/triple/quadruple-click text to select words/paragraphs/all document text. Click outside of selected text/images to cancel the selection. If you are using a touch-based device then tap text to enable text-selection mode, or tap images to select them. Touch outside selected text/images and then move and release in order to cancel the selection mode. If the page has no regions that do not contain text/images, touch on any image then move and release in order to cancel the selection mode, or simply tap



outside of the page. Note that if you are using a touchscreen in conjunction with a stylus/digitizer, then the behavior is identical to using a mouse in desktop mode.

---

### 10.4.2.2 Selection Options



## Selection Options

Use the **Selection** dropdown menu to edit and manipulate selected content:

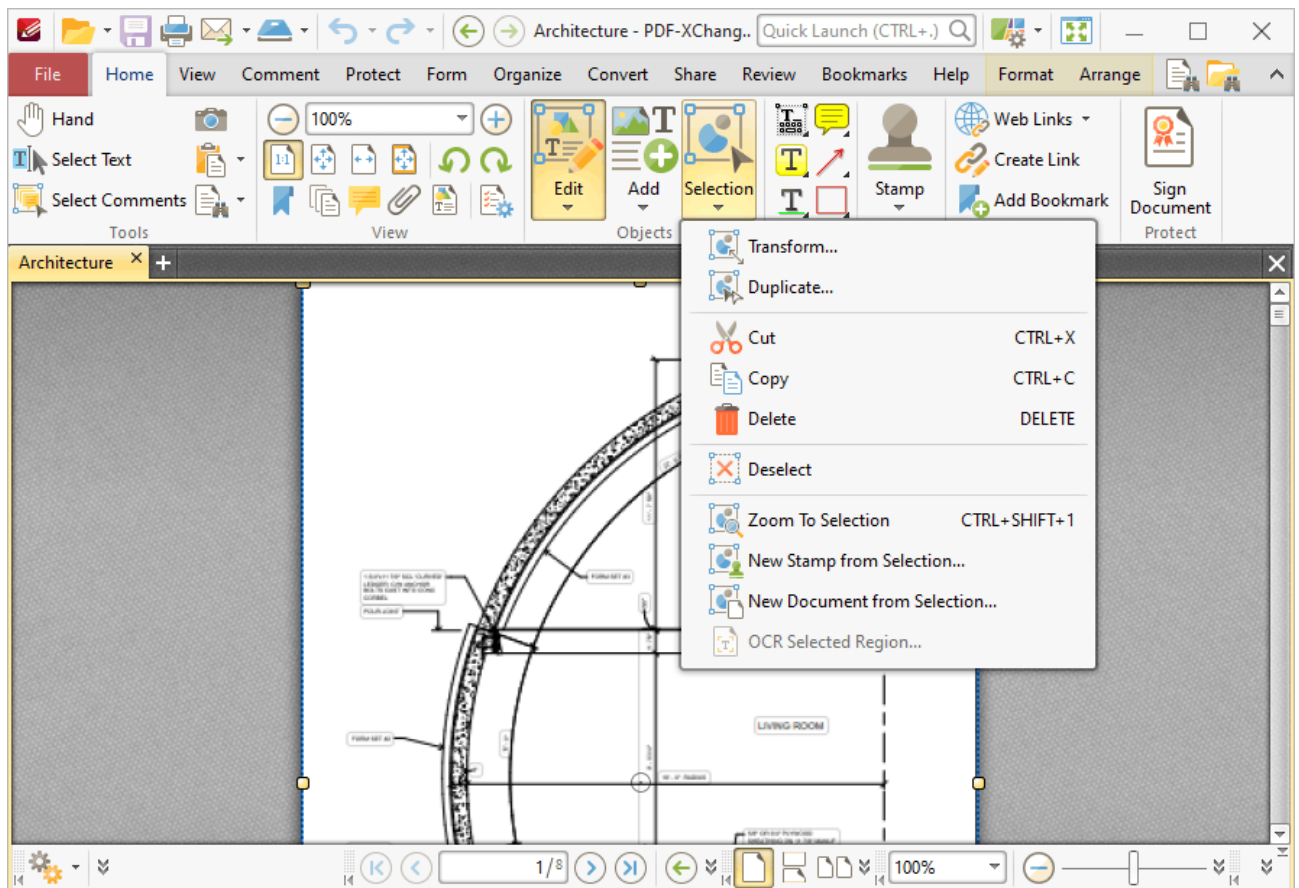

Figure 1. Selection Dropdown Menu

- Click **Transform** to edit the position, size and/or rotation of selected annotations/content items, as detailed [here](#).<sup>948</sup>
- Click **Duplicate** to duplicate selected annotations/content items, as detailed [here](#).<sup>950</sup>
- Click **Copy**, **Cut**, **Delete**, **Deselect** or **Zoom To Selection** to perform these operations on selected annotations/content items.

- Click **New Stamp from Selection** to create a new stamp from selected annotations/content items, as detailed [here](#).<sup>953</sup>
  - Click **New Document from Selection** to create a new document from selected annotations/content items, as detailed [here](#).<sup>955</sup>
  - Click **OCR Selected Region** to perform optical character recognition on the selected region of the document, as detailed [here](#).<sup>1524</sup>
-

10.4.2.3 Transform



**Transform**

Click **Transform** to edit the position, size and/or rotation of selected annotations/content items:

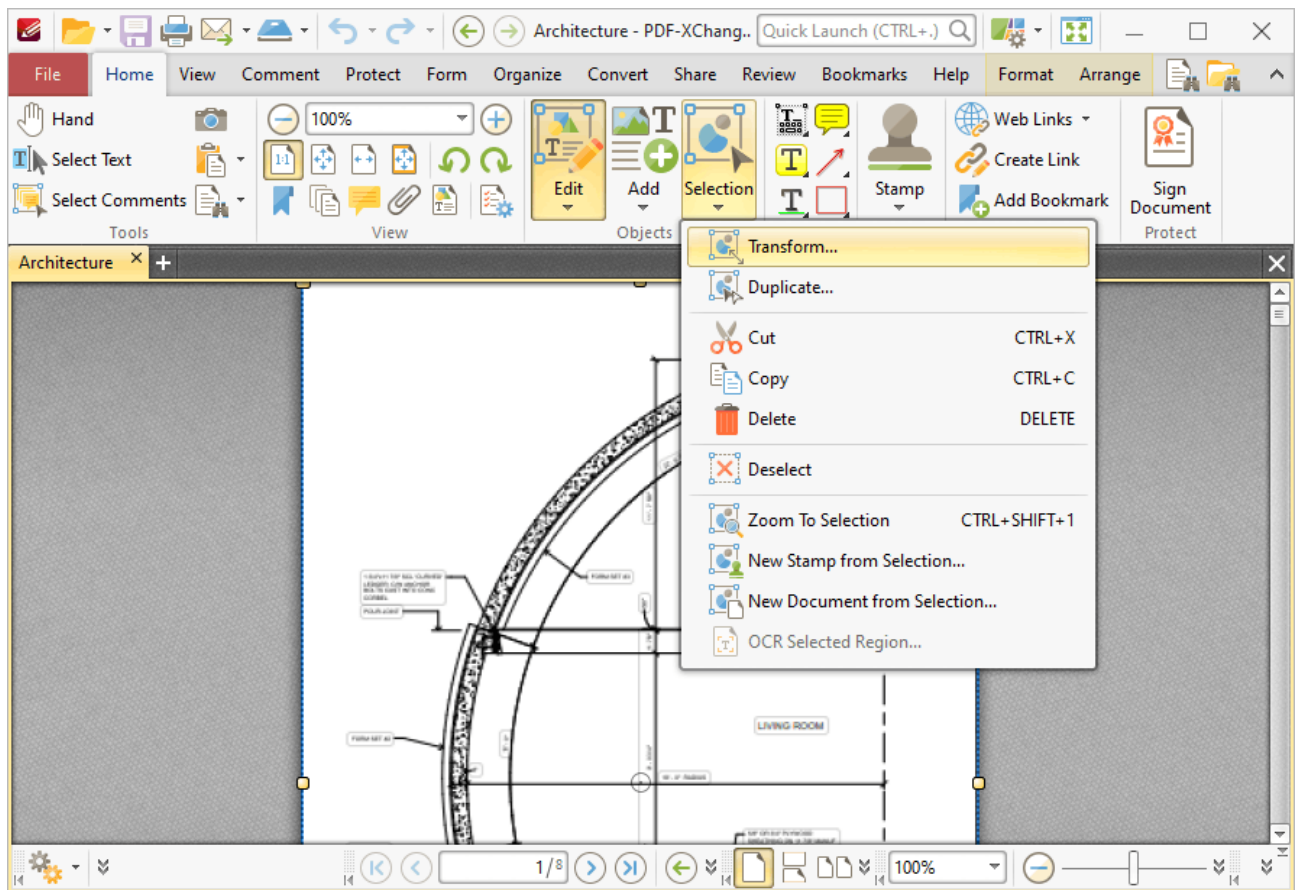

Figure 1. Selection Submenu, Transform

The following dialog box will open:

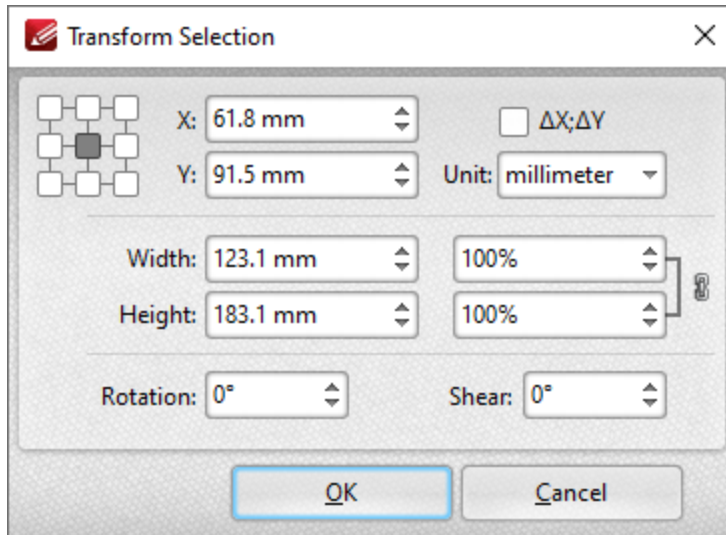

Figure 2. Transform Selection Dialog Box

- Click the boxes in the grid to view the current location of the corresponding points of the selected content.
- Use the **X** and **Y** number boxes to determine the new positioning of the selected content. The **X** value is the horizontal plane and the **Y** value is the vertical plane.
- Select the **ΔX; ΔY** box to determine offset values relative to the current position of the selected content.
- Use the **Unit** dropdown menu to select the units of measurement.
- Use the **Width** and **Height** boxes to adjust the size of the selected content.
- Use the **Rotation** box to adjust the rotation of the selected content.
- Use the **Shear** box to determine a shear angle. This will slant the selected object along a horizontal axis.

Click **OK** to transform selected content.

---

10.4.2.4 Duplicate



**Duplicate**

Click **Duplicate** to duplicate selected annotations/content items:

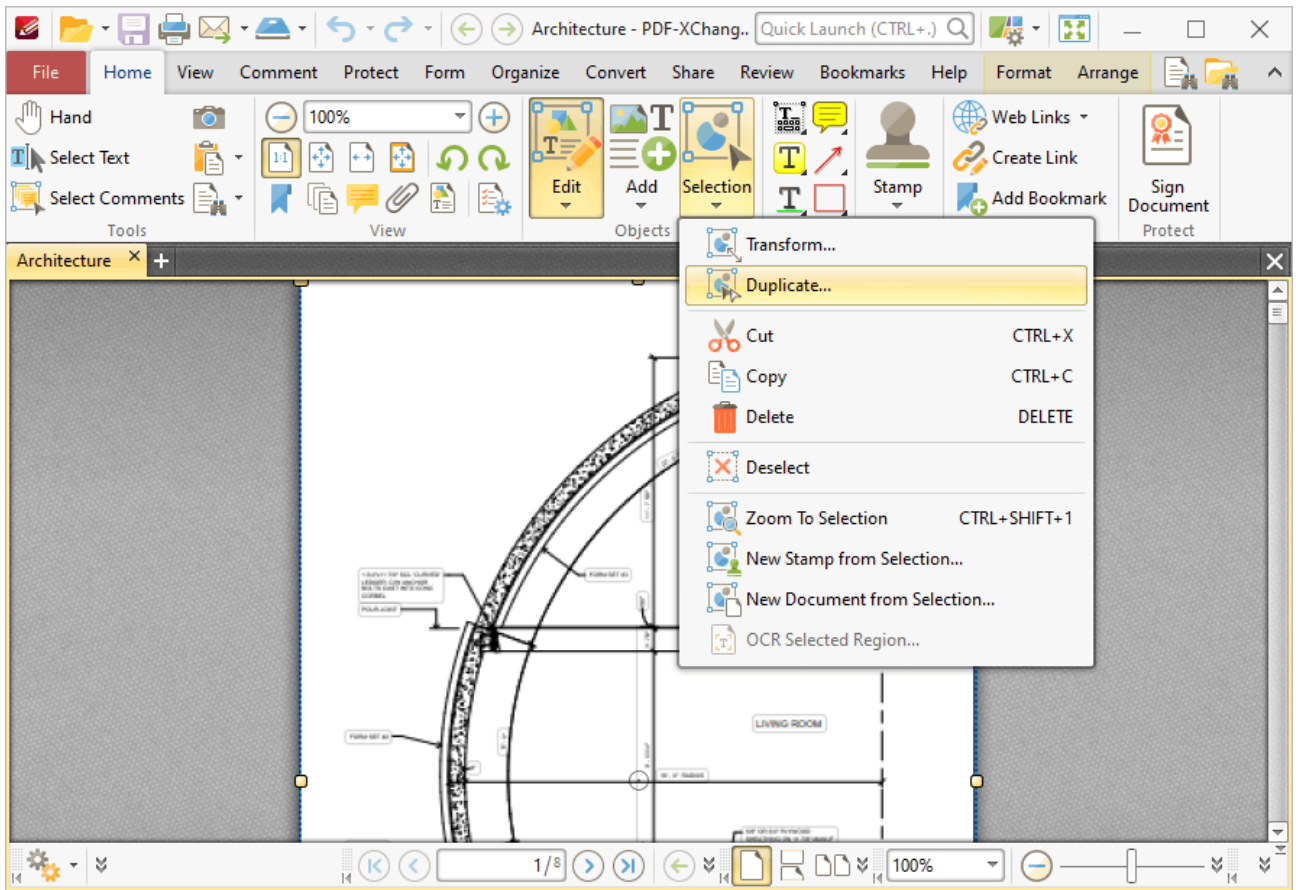

Figure 1. Selection Submenu, Duplicate

The **Duplicate Content Items** dialog box will open:

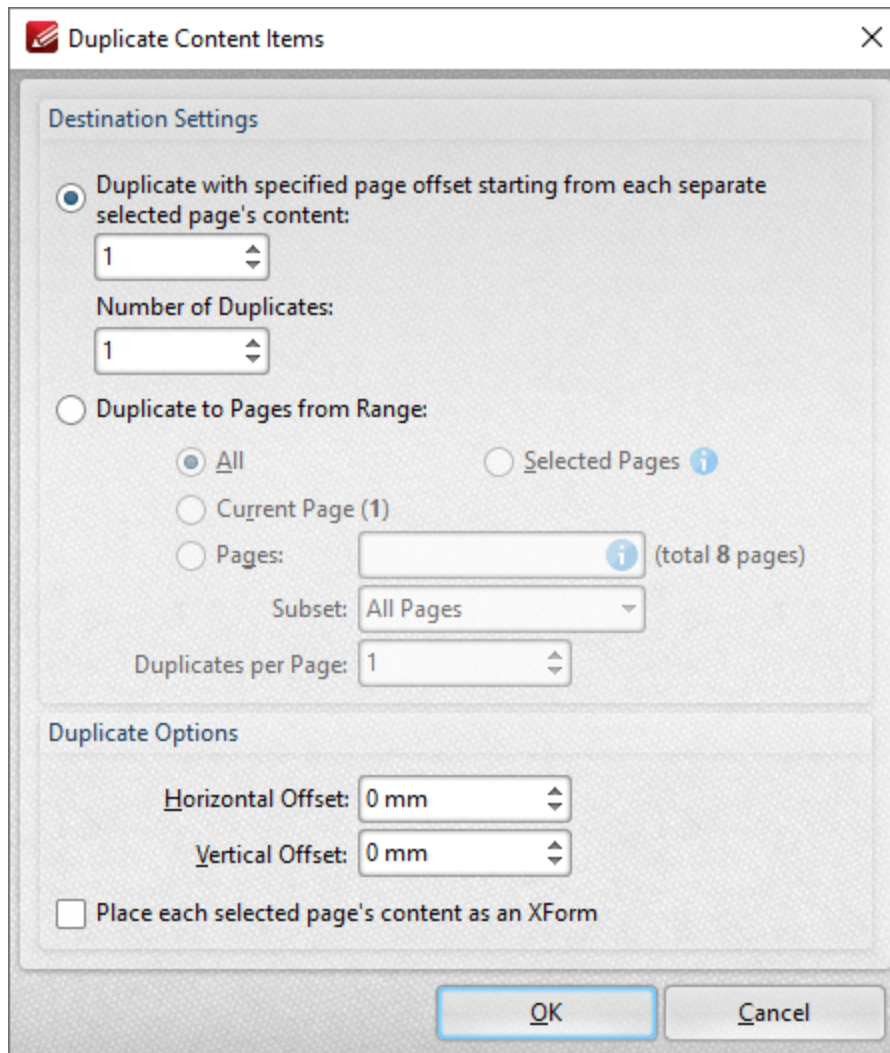



Figure 2. Duplicate Content Items Dialog Box

There are two radio button options:

The first radio button option enables the duplication of selected content items and the creation of a page offset between duplicates. The number entered in the upper number box determines the page offset between the selected content item and duplicates created through the process of duplication. The specified page offset will also be used between duplicates when more than one duplicate is created. Use the lower number box to specify the number of duplicates created.

The second radio button option enables the duplication of selected content items to a specified page range:

- Select **All** to duplicate the selected items to all pages in the document.
- Select **Current Page** to duplicate the selected items to only the current page.

- Use the **Pages** number box to specify a custom page range. The **Subset** dropdown menu can be used to specify **All Pages**, **Even Pages** or **Odd Pages** as desired. Further information on the specification of page ranges is available [here](#).
- Use the **Duplicates per Page** dropdown menu to determine the number of duplicates per page.

Use the **Duplicate Options** settings to determine duplicate parameters:

- Use the **Horizontal Offset** box to determine the horizontal offset in relation to the duplicated content.
- Use the **Vertical Offset** box to determine the vertical offset in relation to the duplicated content.
- Select the **Place each selected page's content as an XForm** box to place duplicated content as an **XForm**.

Click **OK** to duplicate content.

---



10.4.2.5 New Stamp from Selection



**New Stamp from Selection**

Click **New Stamp from Selection** to create a new stamp from selected document content:

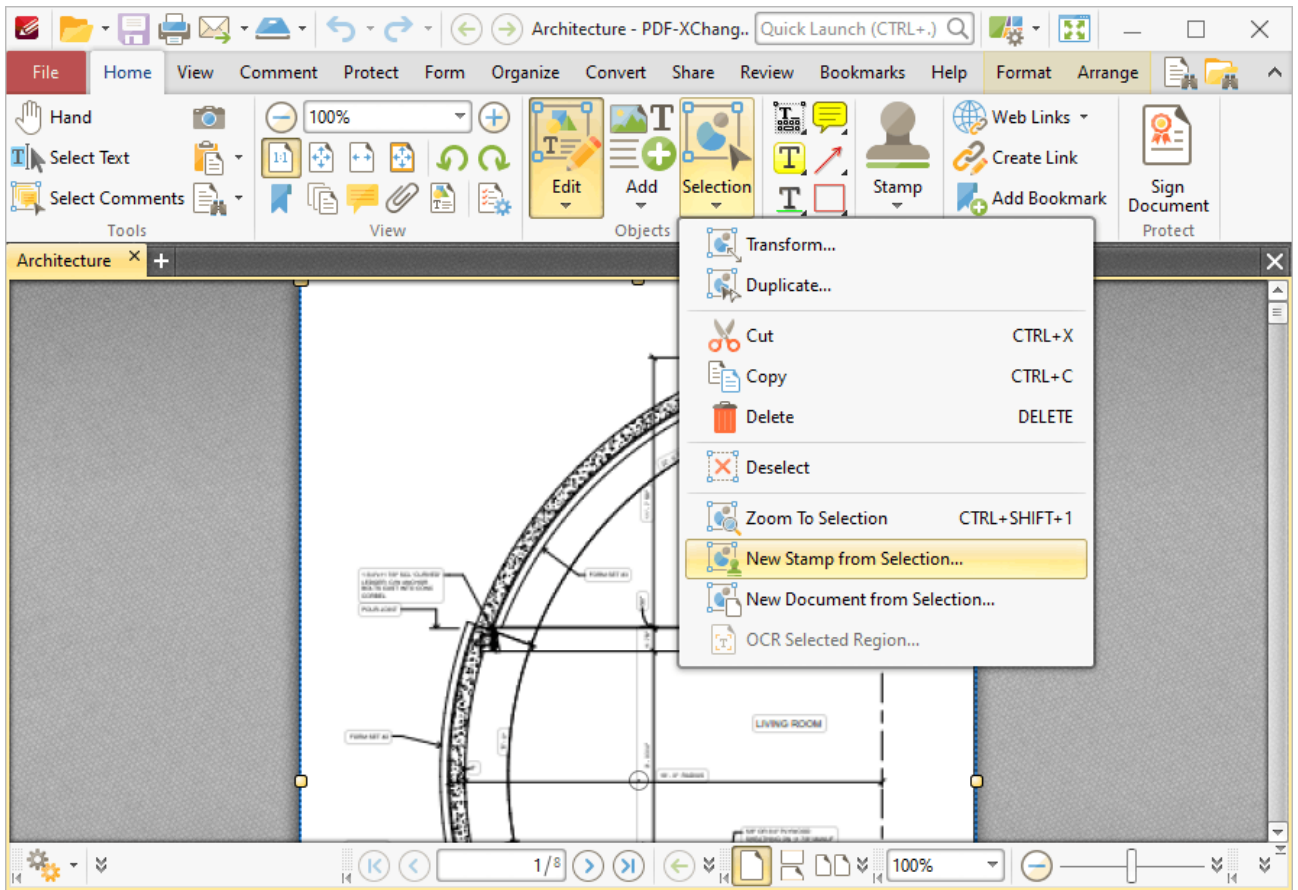

Figure 1. Selection Submenu, New Stamp from Selection

The **Add New Stamp** dialog box will open:

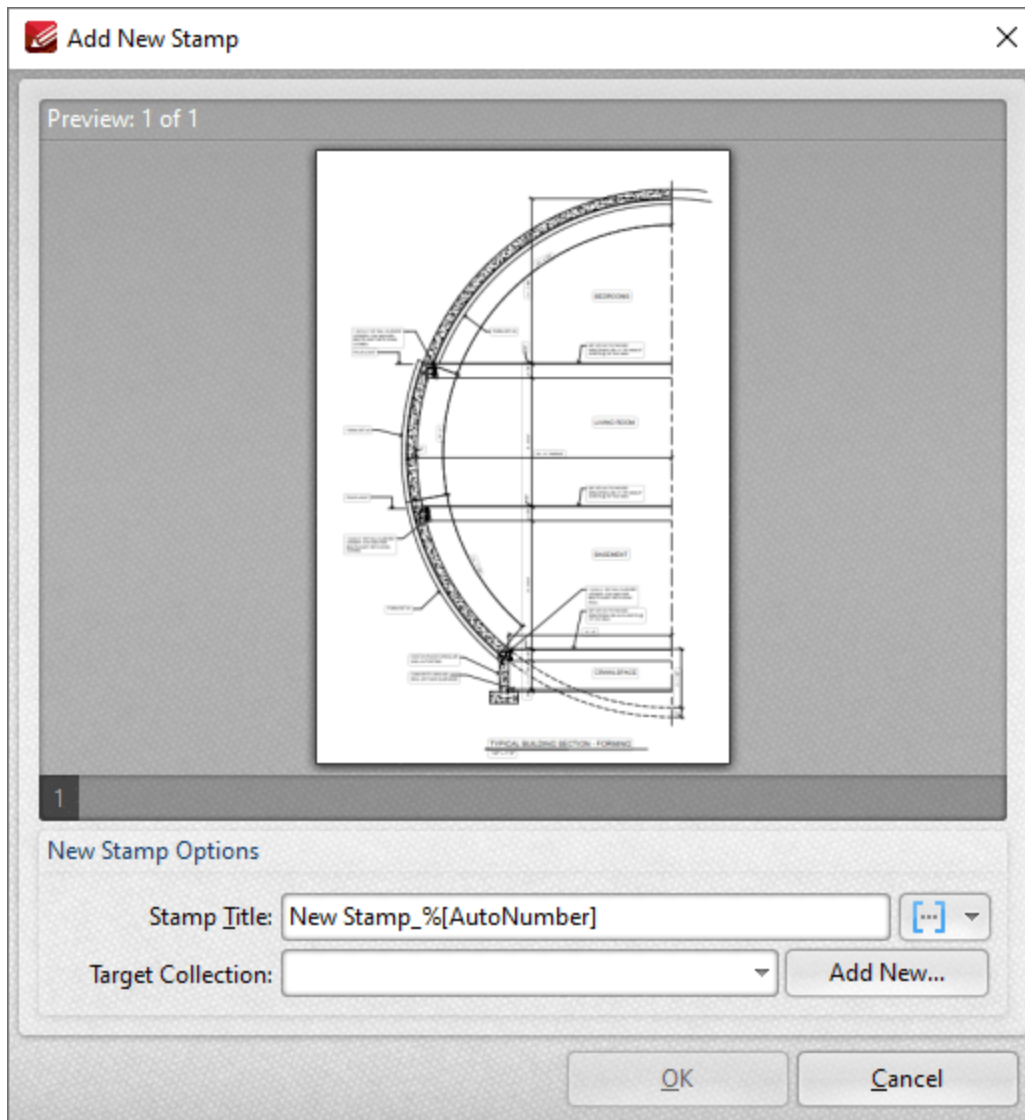

Figure 2. Add New Stamp Dialog Box

- Enter a name for the stamp in the **Stamp Title** text box. Click the blue icon to add [Macros](#)<sup>1707</sup> as desired.
- Use the **Target Collection** dropdown menu to select the stamp collection in which the new stamp will be located. Click **Add New** to create a new stamp collection.
- Created stamps can be used in conjunction with the [Stamp Tool](#).<sup>1188</sup>

Click **OK** to create the new stamp.

10.4.2.6 New Document from Selection



**New Document from Selection**

Click **New Document from Selection** to create a new document from selected document content:

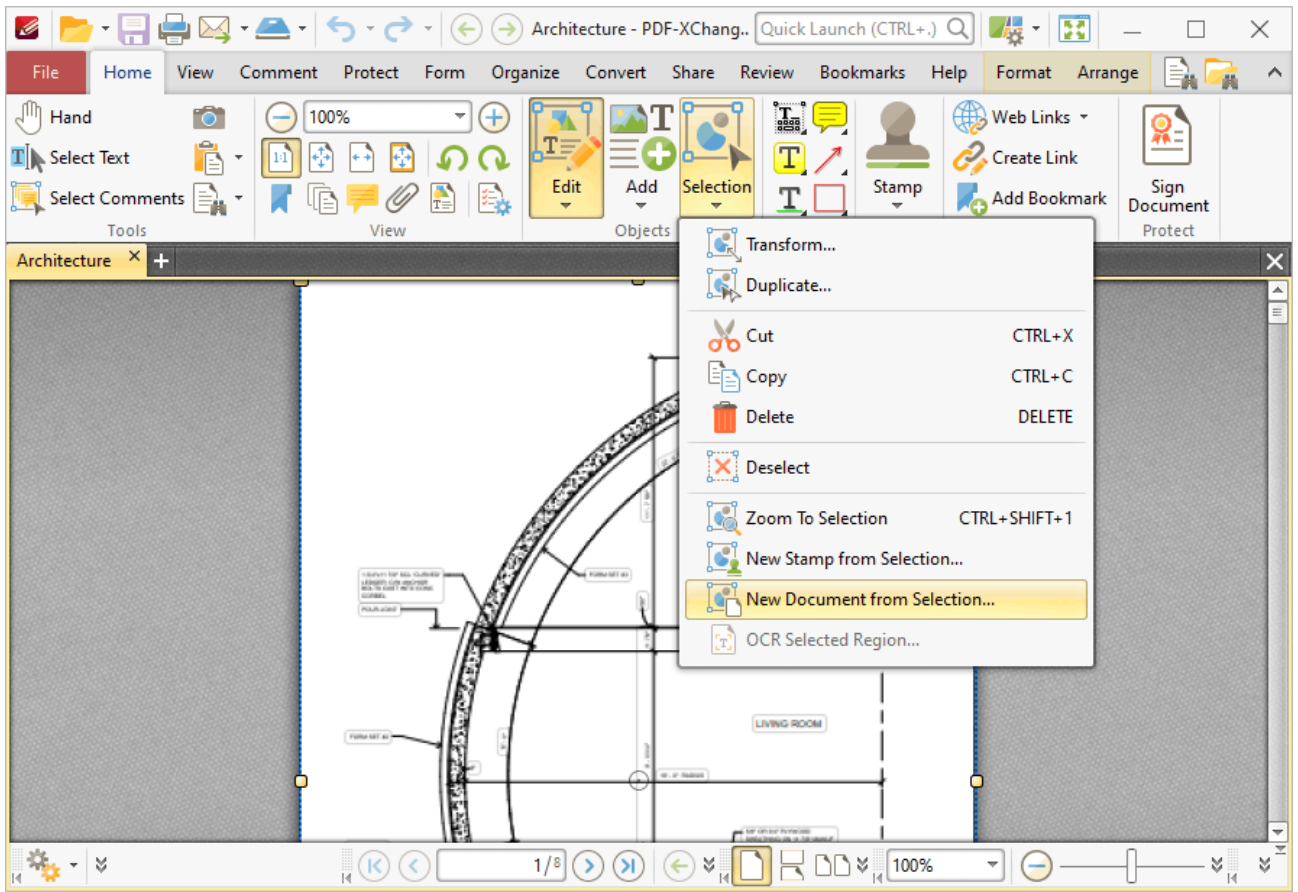

Figure 1. Edit Tab Submenu. New Document from Selection

The new document will be created automatically and then open in a new window in **PDF-XChange Editor**.

### 10.4.2.7 Link Options



## Link Options

Click the **Web Links** dropdown menu to view options for document weblinks:

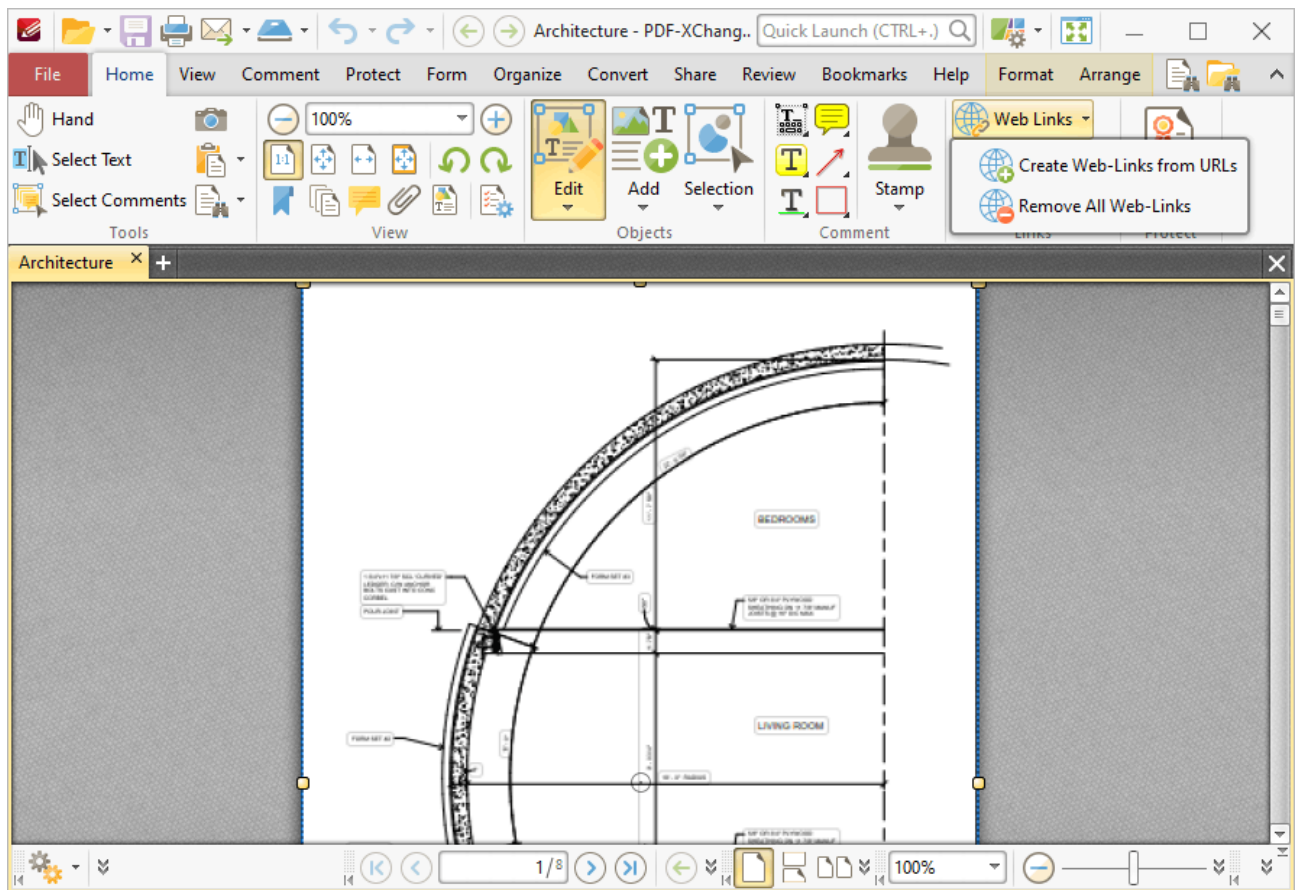

Figure 1. Home Tab, Web Links Dropdown Menu

- Click **Create Web-Links from URLs** to convert existing page text URLs into clickable hyperlinks.
- Click **Remove All Web-Links** to remove existing hyperlinks from page text URLs.

Please note that it is necessary to disable the **Create links from URLs in page text** preference in the **Page Text** preferences for these features to operate:

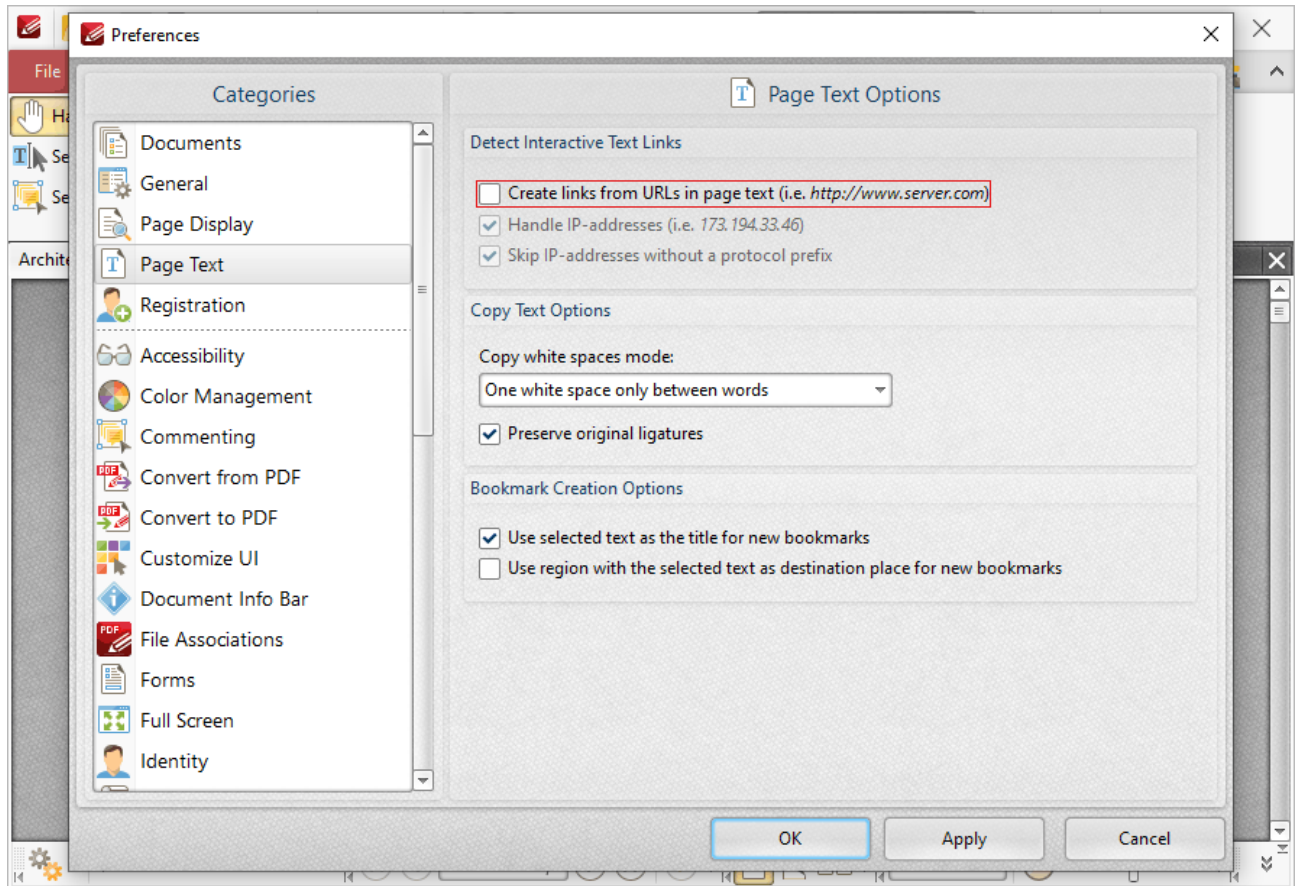

Figure 2. Create Links from URLs in Page Text Preference Disabled

## Create Links

Click **Create Link** to create links:

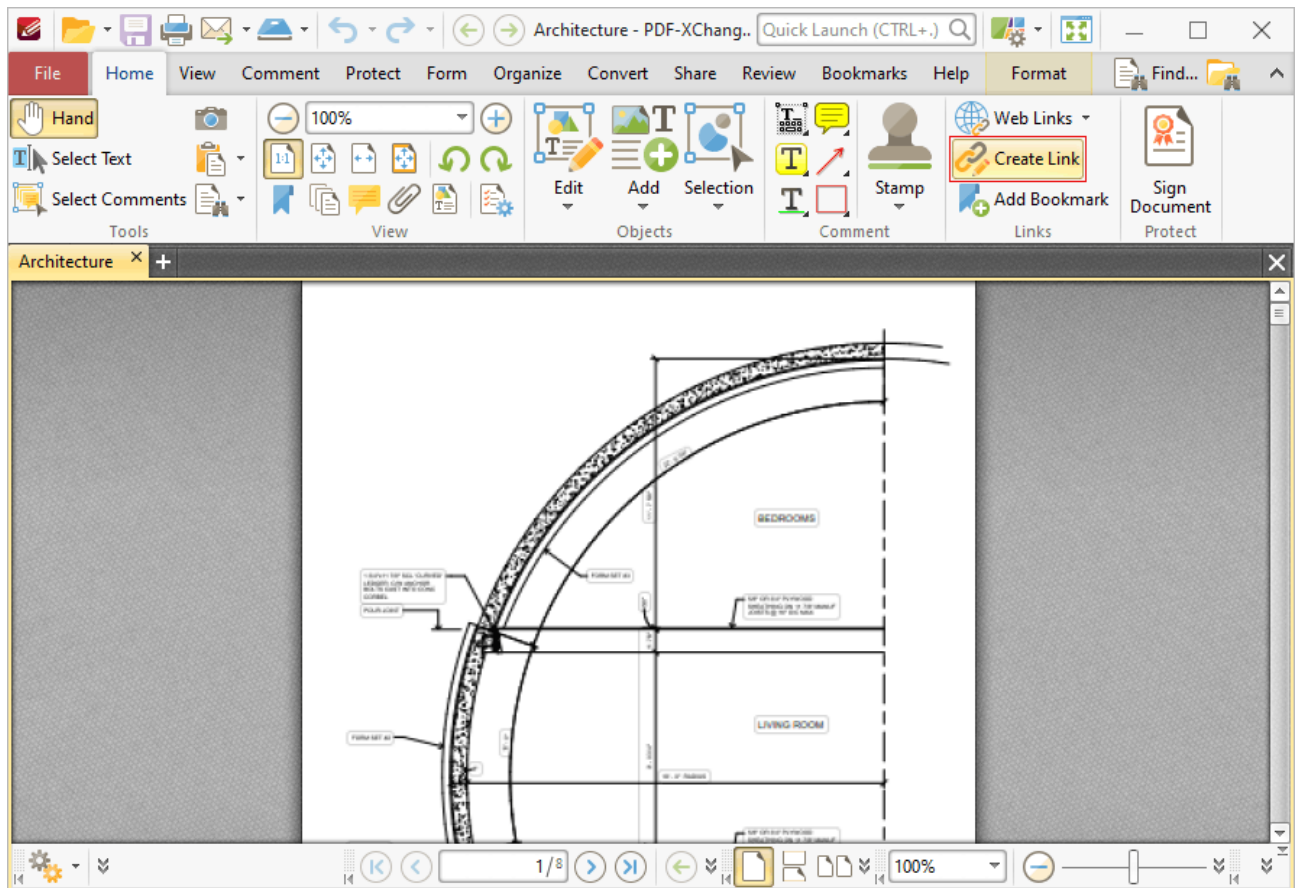

Figure 3. Home Tab, Create Link

When this feature is enabled, the pointer becomes a crosshairs icon. Click and drag to determine the size and location of the link. The **Browse for Link Target** dialog box will open:

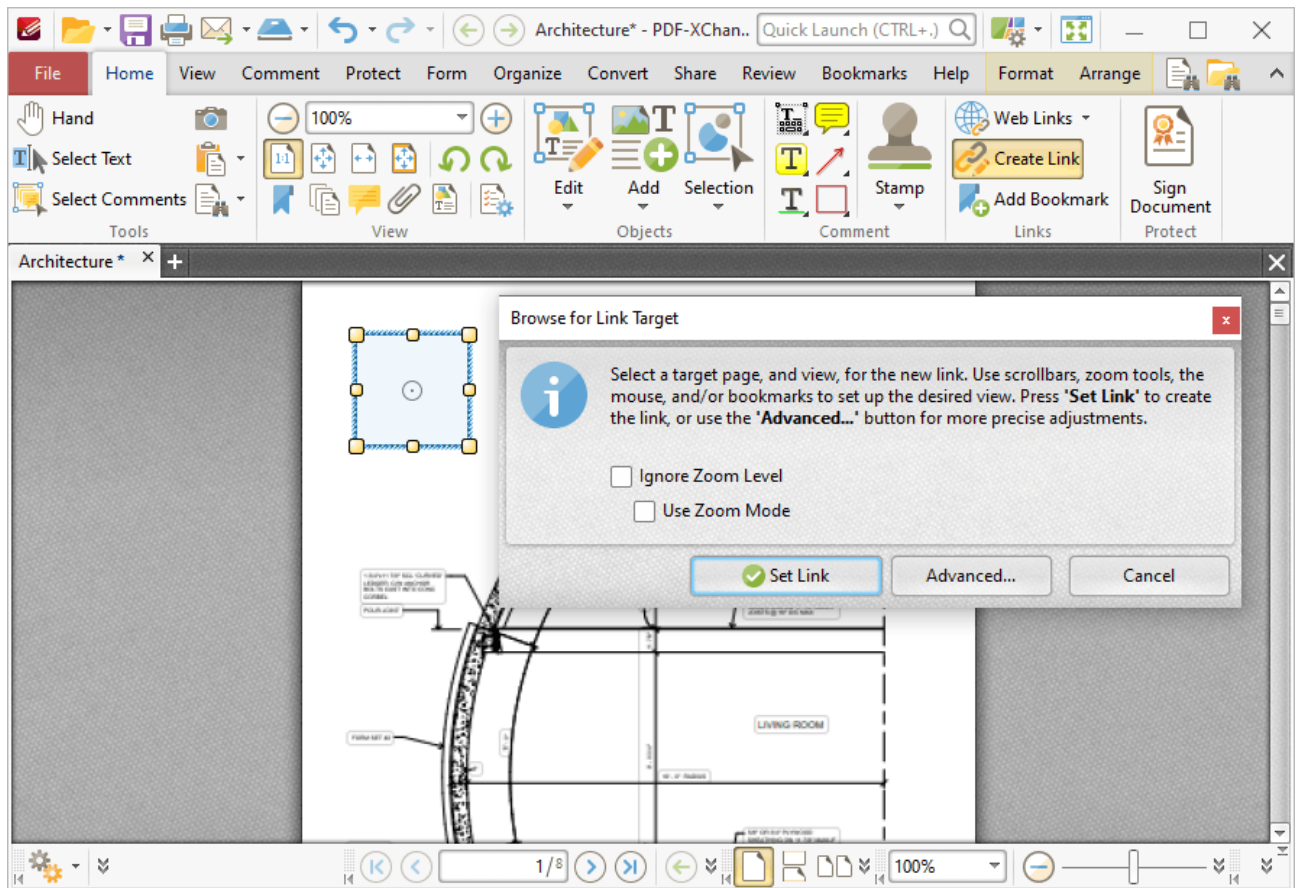

Figure 4. Link Creation Tool Example

- If the **Ignore Zoom Level** box is selected then **PDF-XChange Editor** will ignore the document zoom level when links are created. If this box is cleared then the zoom level will update to the zoom level that was present at the time of link creation when links are used.
- If the **Use Zoom Mode** box is selected then **PDF-XChange Editor** will ignore the active zoom mode when links are created. If this box is cleared then the zoom mode will update to the mode that was active at the time of link creation when links are used.
- Move to the desired link location and zoom level, then click **Set Link** to create the link.
- Click **Advanced** to determine advanced settings for links. The **Edit Action List** dialog box will open:

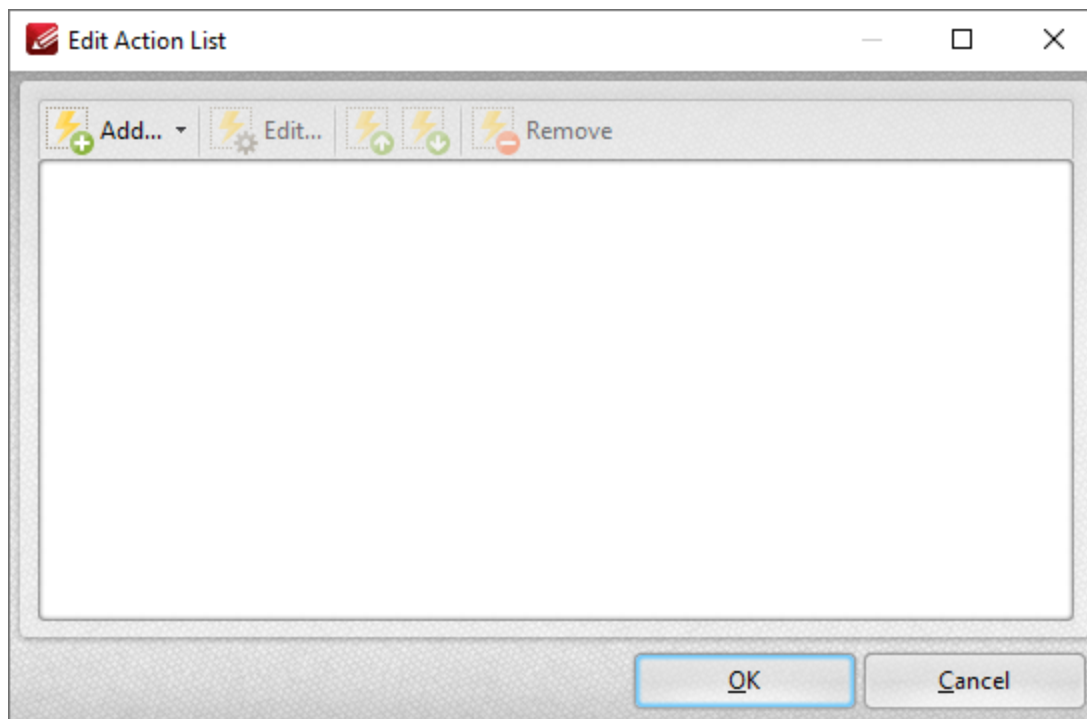

Figure 5. Edit Actions List Dialog Box

- Click **Add** to add actions to the list. Actions will be executed when the link is selected. All available actions are detailed below.
- Select actions and click **Edit** to adjust their settings.
- Click the arrow icons to move selected actions up or down in the list.
- Click **Remove** to remove selected actions from the list.
- Note that it is possible to add multiple actions to the list. The order of actions in the **Edit Action List** dialog box determines the order in which they are performed.

The following actions are available:

- [Run a JavaScript](#)<sup>[963]</sup>
- [Go to Page Options](#)<sup>[965]</sup> (**Go To a Page in the Document**, **Go To a Page in Another Document** and **Go To a Page in an Embedded Document**).
- [Open a Web Link](#)<sup>[968]</sup>
- [Open a File](#)<sup>[970]</sup>
- [Execute a Command](#)<sup>[972]</sup>
- [Reset a Form](#)<sup>[974]</sup>
- [Submit a Form](#)<sup>[976]</sup>
- [Play a Sound](#)<sup>[979]</sup>
- [Go to a 3D/Multimedia View](#)<sup>[981]</sup>
- [Show/Hide a Field](#)<sup>[983]</sup>
- [Read an Article](#)



Note that it is possible to edit links after they have been created. Click **Create Link** in the **Home** tab, then click to select the link:

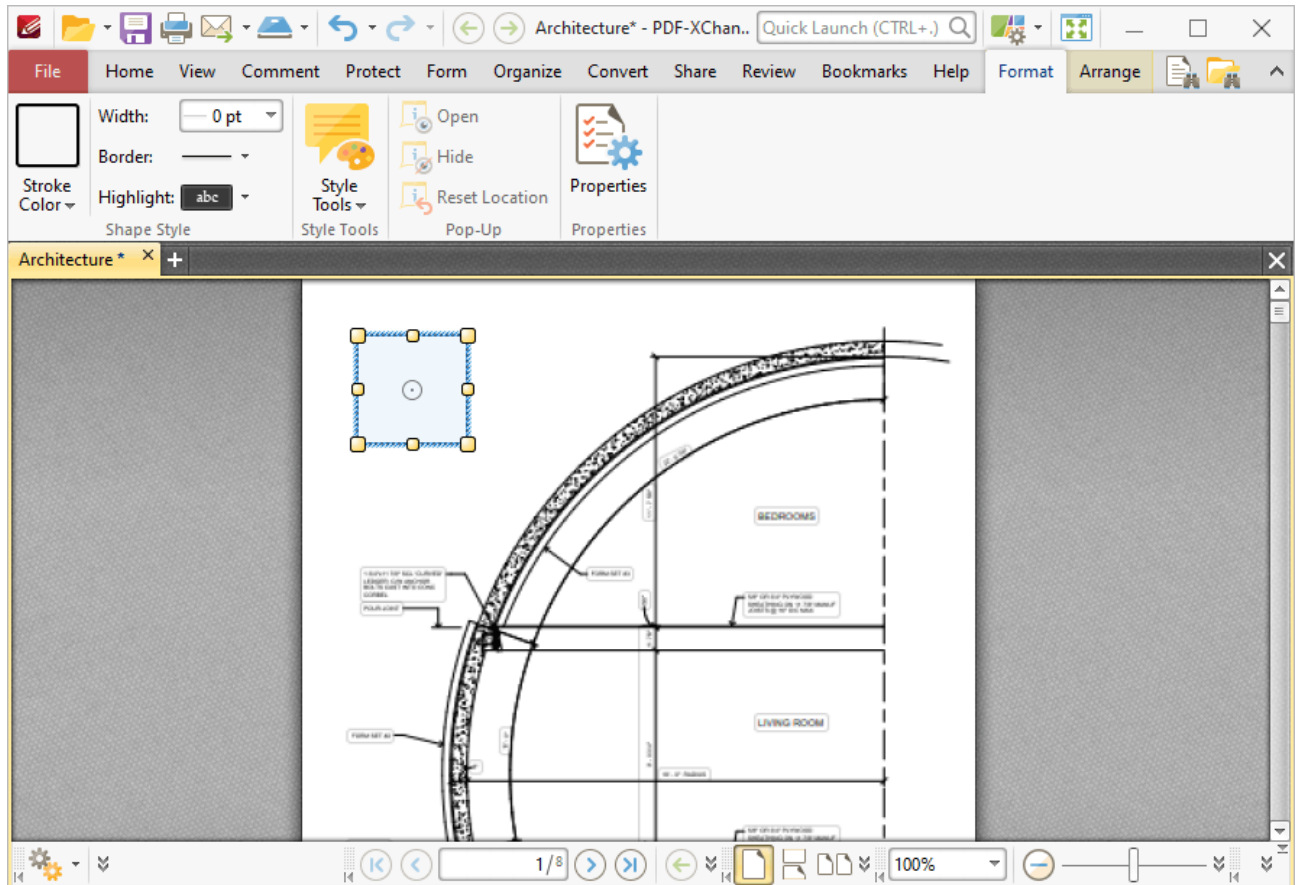



Figure 6. Selected Link

- Click and drag the yellow control points to resize links.
- Click and drag link boxes, or use the arrow keys, to reposition links. Hold down Shift to move at an increased increment when using the arrow keys.
- Use the editing aids detailed [here](#)<sup>1075</sup> to assist in the precise placement of links.
- Right-click links for further options. See [here](#)<sup>1783</sup> for an explanation of these options.
- Use the options in the **Format** tab to customize the appearance of links:
  - Click **Stroke Color** to determine the color of the link border. Note that it is necessary to adjust the width of link borders in order for the color to be visible.
  - Click **Border Width** to determine the width of the link border.
  - Click **Border Style** to determine the style of the link border.
  - Click **Highlight Mode** to determine the visual effect when the link is clicked.
- Use the **Style Tools** to copy/apply link tool styles:
  - Click **Copy Comment Style** to copy the style properties of selected link annotations.
  - Click **Apply Copied Comment Style** to apply a copied link style to the selected link annotation.

- Click **Apply Copied Comment Appearance** to apply copied comment properties to the selected content.
- Click **Make Current Properties Default** to set the properties of the selected annotation as the default properties for subsequent annotations.
- Click **Apply Default Properties** to apply the default link annotation properties to the selected link annotation.
- Click **Properties** to view/edit the **Link Creation Tool Properties** pane. See [here](#)  for information on tool properties.

Please note that the **Link Creation Tool** must be selected in order to edit/delete links. It is also possible to press Ctrl+A in order to select all links in the current document.

---

### 10.4.2.7.1 Run a JavaScript



## Run a JavaScript

This action executes JavaScript when links are clicked:

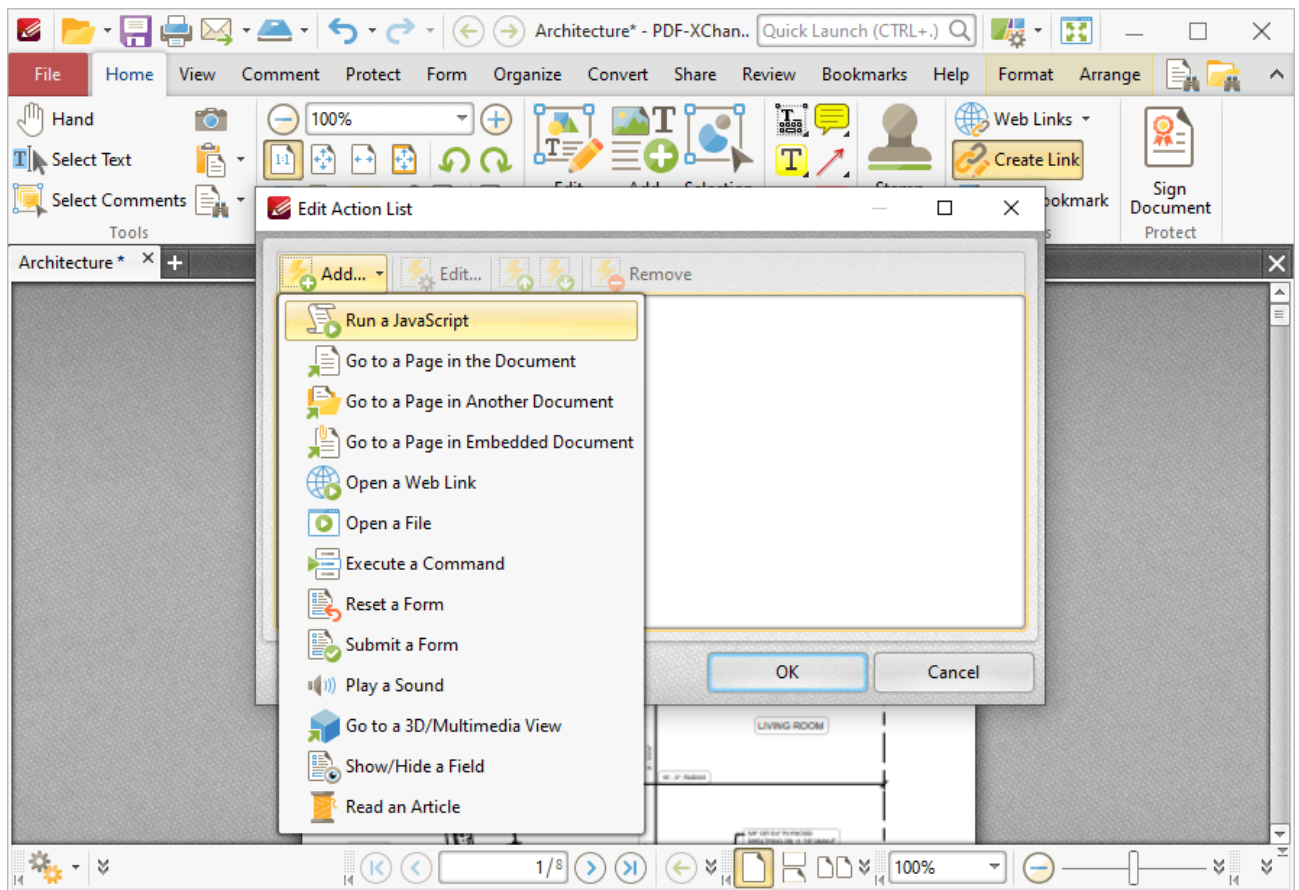

**Figure 1.** Edit Action List Dialog Box, Run a JavaScript

When it is selected the following dialog box will open:

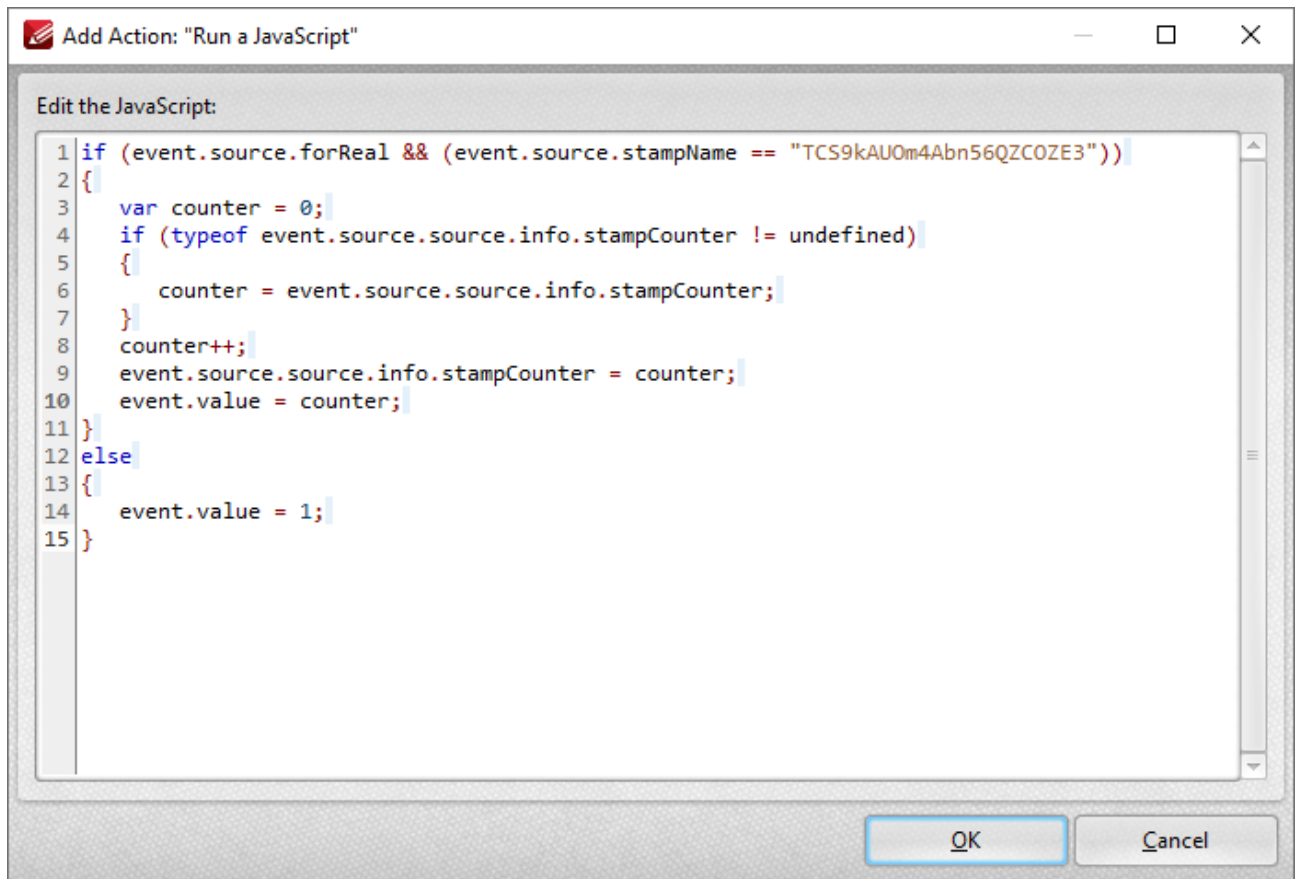

Figure 2. Add Action: "Run a JavaScript" Dialog Box

Enter the desired JavaScript and click **OK** to save.

---

### 10.4.2.7.2 Go To Page Options



## Go To Page Options

There are three **Go To Page** options available for links:

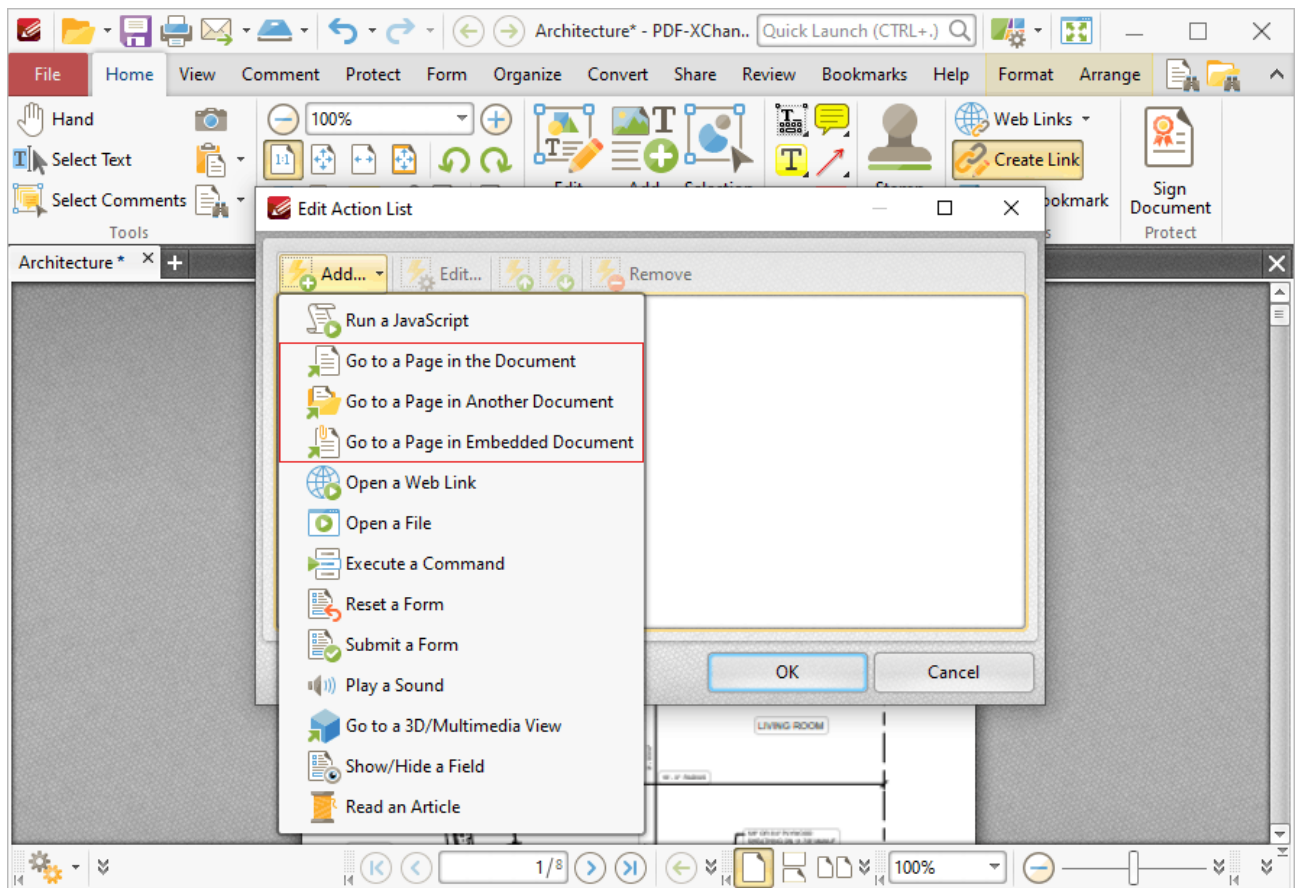

Figure 1. Edit Action List Dialog Box, Go to Page Options

### Go To a Page in the Document

This action moves the main window to a different document page when links are clicked. When it is selected the following dialog box will open:

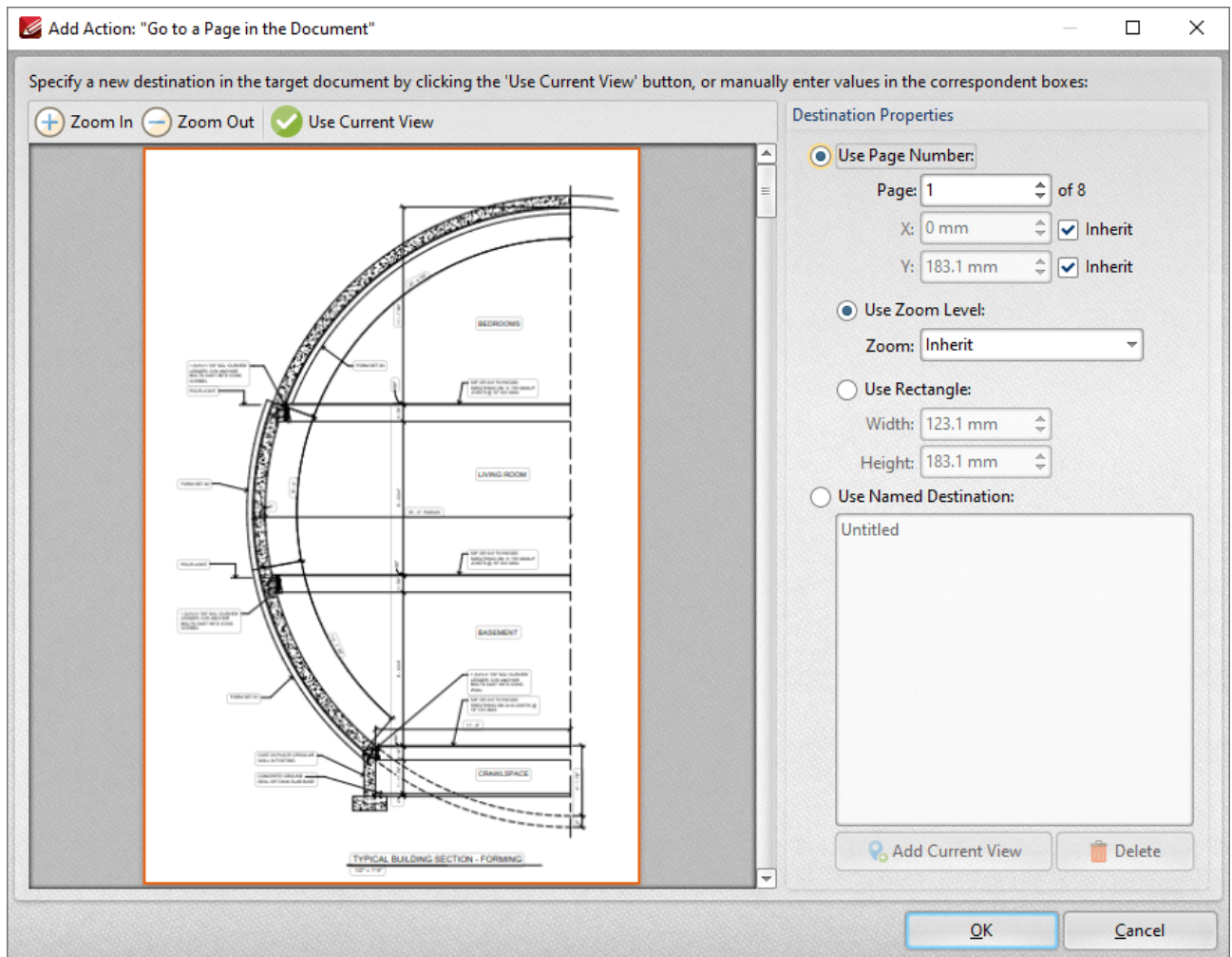

Figure 2. Add Action: "Go to a Page in the Document" Dialog Box

- Click the plus/minus icons to zoom in on/out from the current view.
- Click **Use Current View** to use the view currently displayed in the preview pane as the link destination. Note that this option can be used to link to locations on the same page as the parent link.
- Alternatively, use the **Destination Properties** options to select a page. Enter a page number or use a **Named Destination** <sup>1036</sup> to determine the destination:
- Select the **Use Page Number** option button to specify a page number as the link location. The figures entered in the **X** and **Y** boxes determine the location on the horizontal and vertical planes respectively. When this option is used it is also possible to determine the zoom level, or use a rectangle to designate the destination:
  - Select the **Use Zoom Level** option button to determine the level of zoom used in the link. Use **Inherit Zoom** to save the zoom level used when creating the link.
  - Use the **Use Rectangle** option button to use a rectangle as the link location. Enter values for the **Width** and **Height** as desired.

- Alternatively, select the **Use Named Destination** option button to select a named destination to use as the link location, or click **Add Current View** to create a new named destination from the current view.

Click **OK** to save settings.

### Go To a Page in Another Document

This action moves the main window to a page in a different document when links are clicked. When it is selected the **Open Files** dialog box will be displayed. Select the file and click **Open**. The **Add Action: "Go to a Page in Another Document"** dialog box will open. The settings are the same as those detailed in *(figure 2)*.

### Go To a Page in an Embedded Document

This action moves the main window to a different page in an embedded document when links are clicked. When it is selected the **Choose Root Document** dialog box will be displayed. Select either **This document** or **Choose external document**. (When an external document is used, enter the name of the document in the text box or click the folder icon to select a document from the local computer). The **Add Action: "Go to a Page in Embedded Document"** dialog box will open. The settings are the same as those detailed in *(figure 2)*.

---

10.4.2.7.3 Open a Web Link



Open a Web Link

This action launches a web link in the default browser when links are clicked:

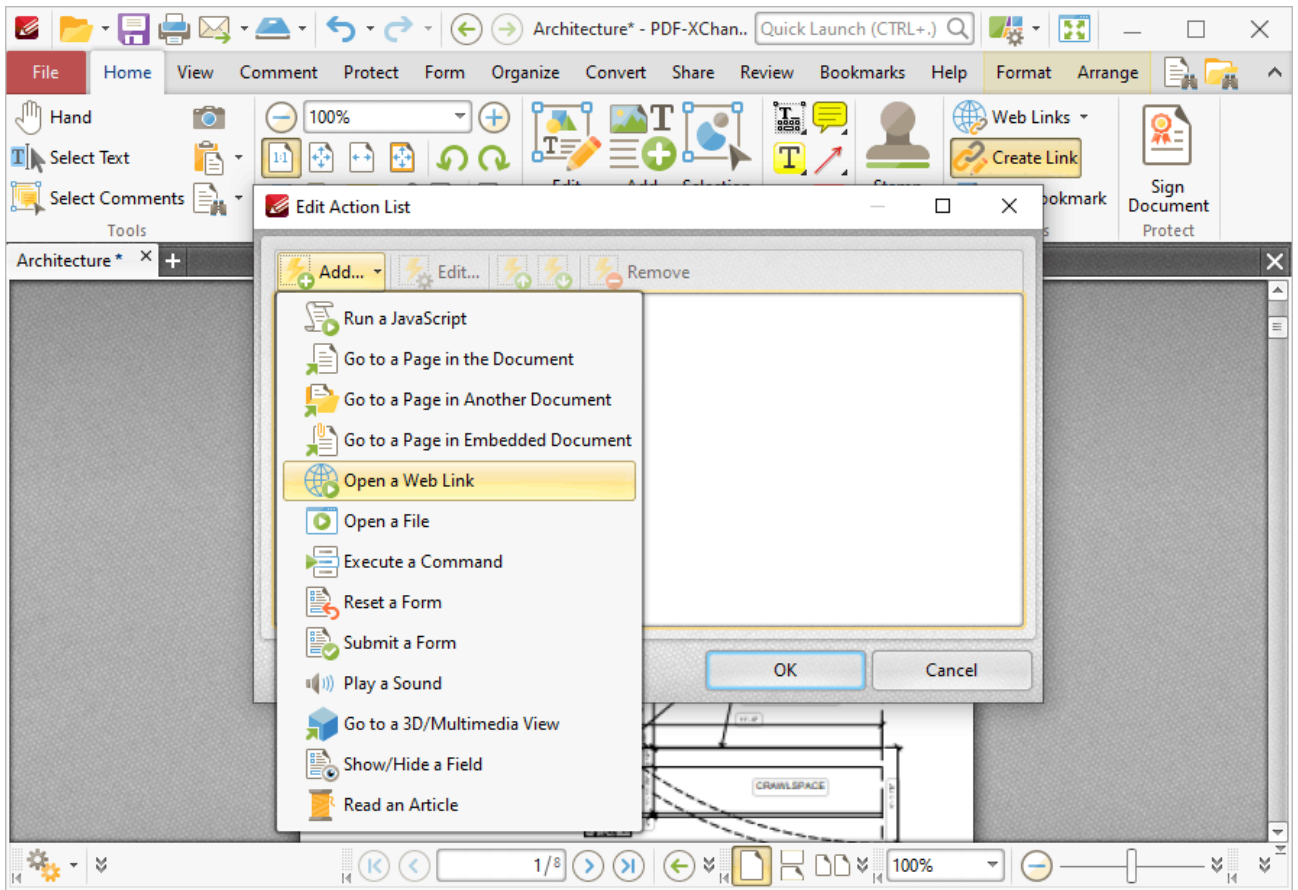
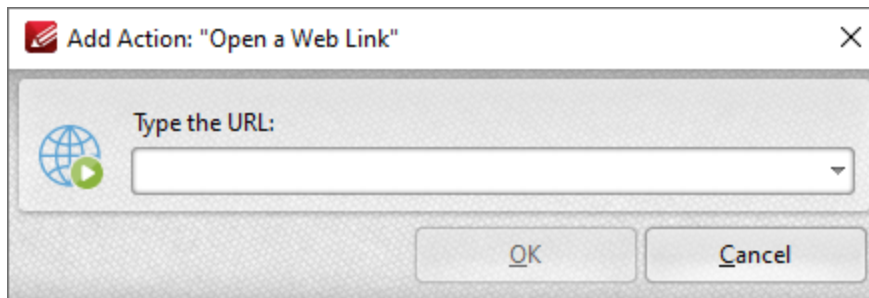

Figure 1. Edit Action List Dialog Box, Open a Web Link

When it is selected the following dialog box will open:





**Figure 2.** Add Action: "Open a Web Link" Dialog Box

Enter the desired URL in the text box and then click **OK** to save the link.

---

## 10.4.2.7.4 Open a File



### Open a File

This action opens a file when links are clicked:

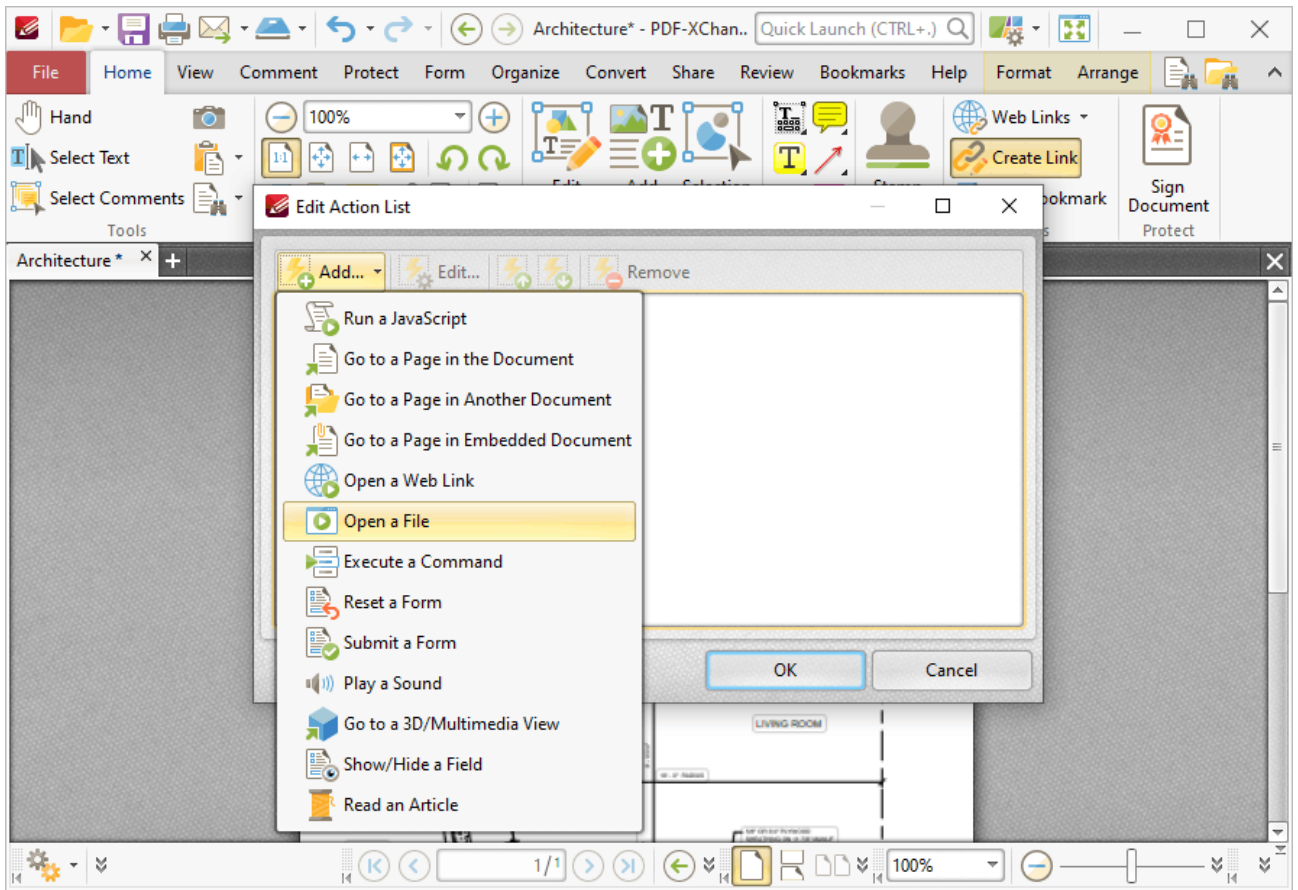

Figure 1. Edit Action List Dialog Box, Open a File

When it is selected the following dialog box will open:

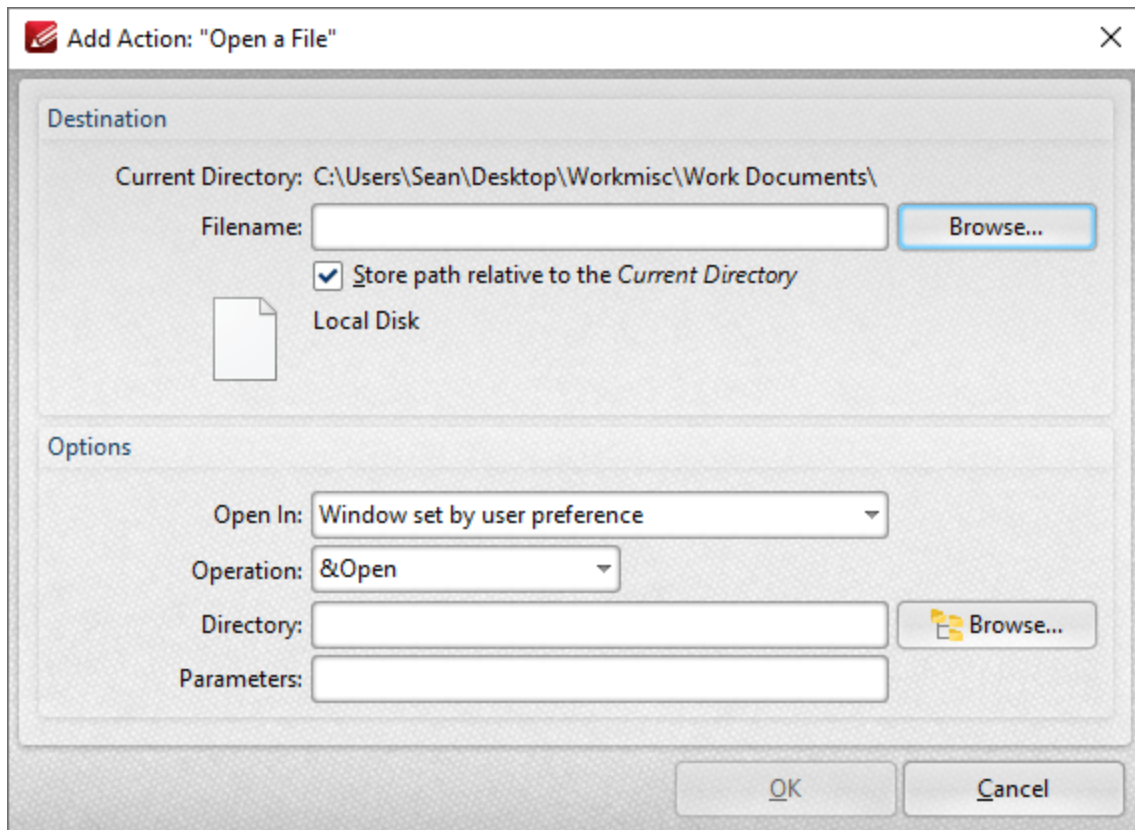

Figure 2. Add Action: "Open a File" Dialog Box

- Enter the name of the file to be opened in the **File Name** text box, or click **Browse** to select a file from the local computer.
- Use the **Open In** menu to select where the file opens.
- Select either **Open** or **Print** in the **Operation** dropdown menu to determine whether the designated file opens or prints when the link is clicked.
- Enter the directory of the file in the **Directory** text box, or click **Browse** to select a folder from the local computer.
- Use the **Parameters** text box to include further parameters of the default program used to open the file. Available parameters depend on the command line options available to the program used.

Click **OK** to save settings.

---

10.4.2.7.5 Execute a Command



**Execute a Command**

This action executes a command when links are clicked:

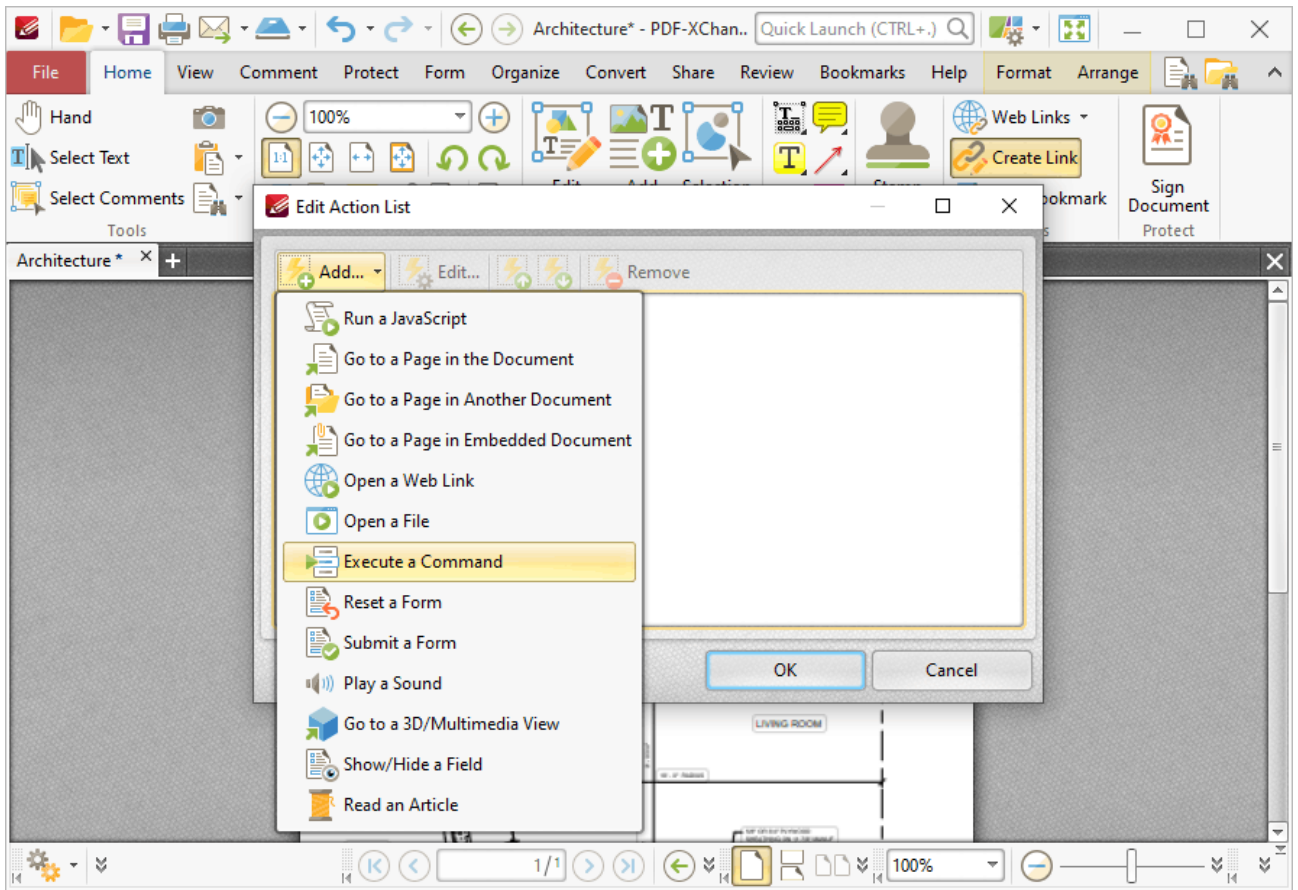

**Figure 1.** Edit Action List Dialog Box, Execute a Command

When it is selected the following dialog box will open:

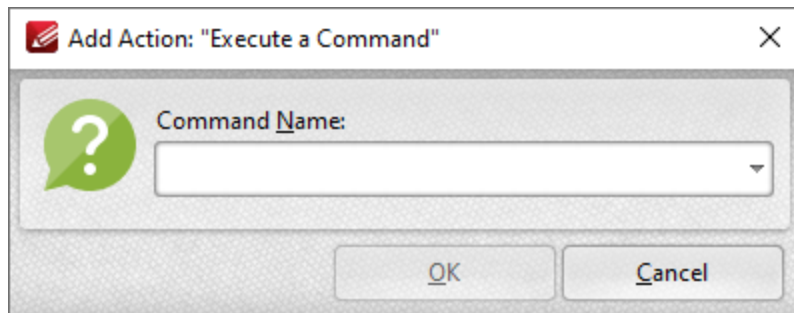

**Figure 2.** Add Action: "Execute a Command" Dialog Box

Click the dropdown arrow to view the list of available commands. Select commands and then click **OK** to add them to the link. Note that multiple commands can be added as desired.

---

### 10.4.2.7.6 Reset a Form



## Reset a Form

This action resets form data when links are clicked:

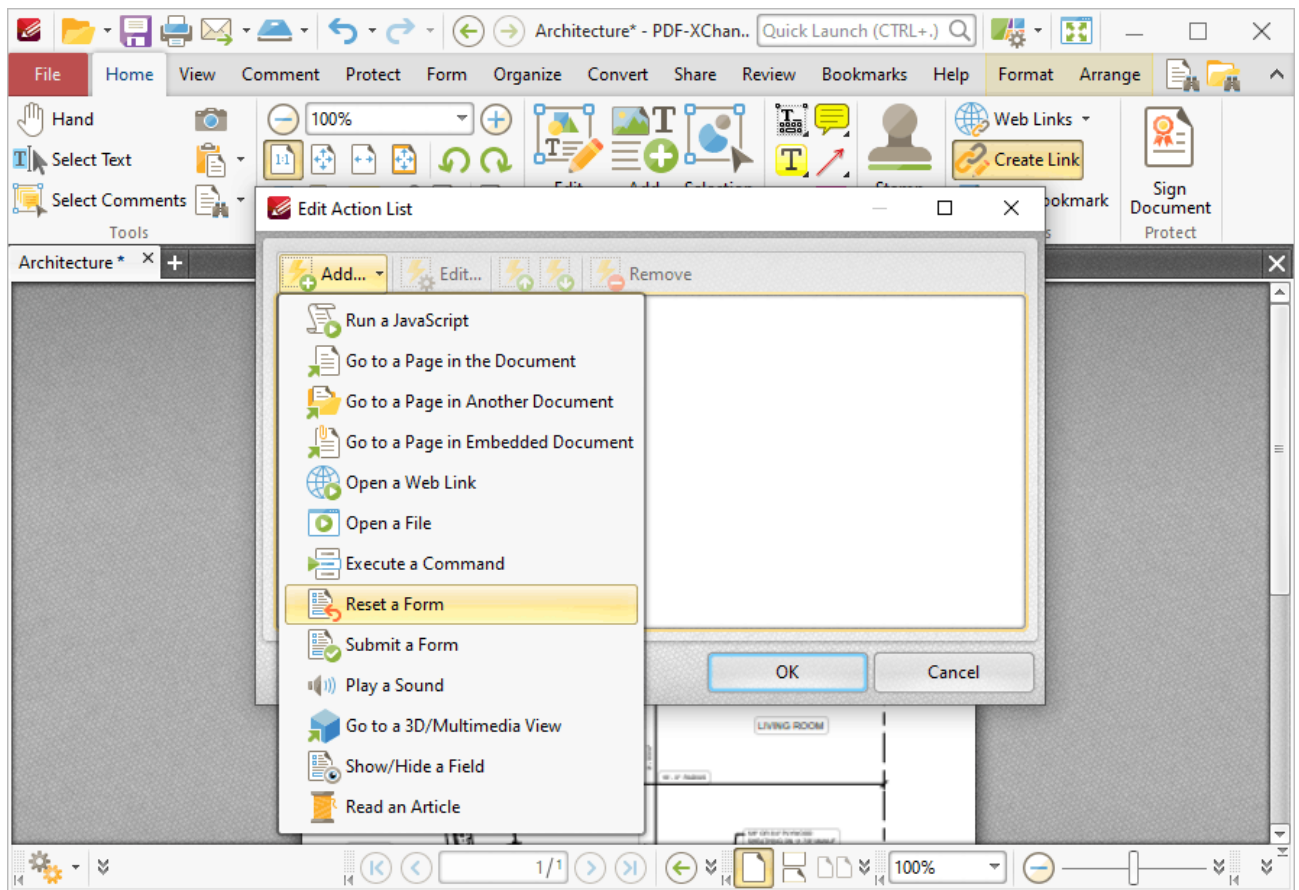

Figure 1. Edit Action List Dialog Box, Reset a Form

Form data is information entered into fillable forms, which the **Form** <sup>1265</sup> tab can be used to create in **PDF-XChange Editor**. The following dialog box will open when this action is selected:

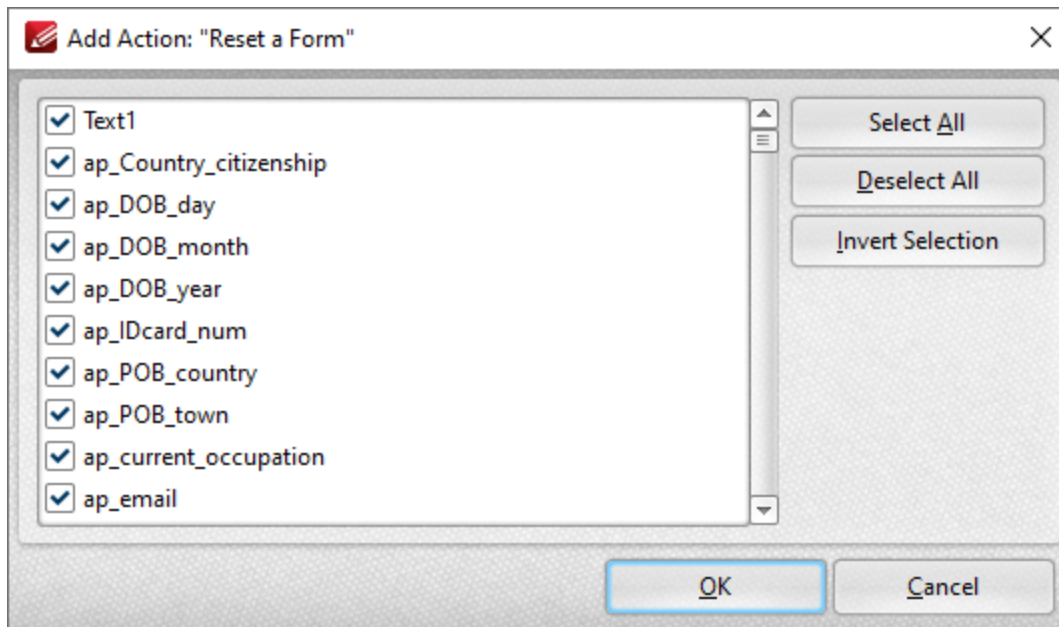

Figure 2. Add Action: "Reset a Form" Dialog Box

- Click **Select All** to select all forms.
- Click **Deselect All** to deselect all forms.
- Click **Invert Selection** to invert the current form selection.

Click **OK** to save settings.

---

### 10.4.2.7.7 Submit a Form



## Submit a Form

This action sends specified form data to a URL when links are clicked:

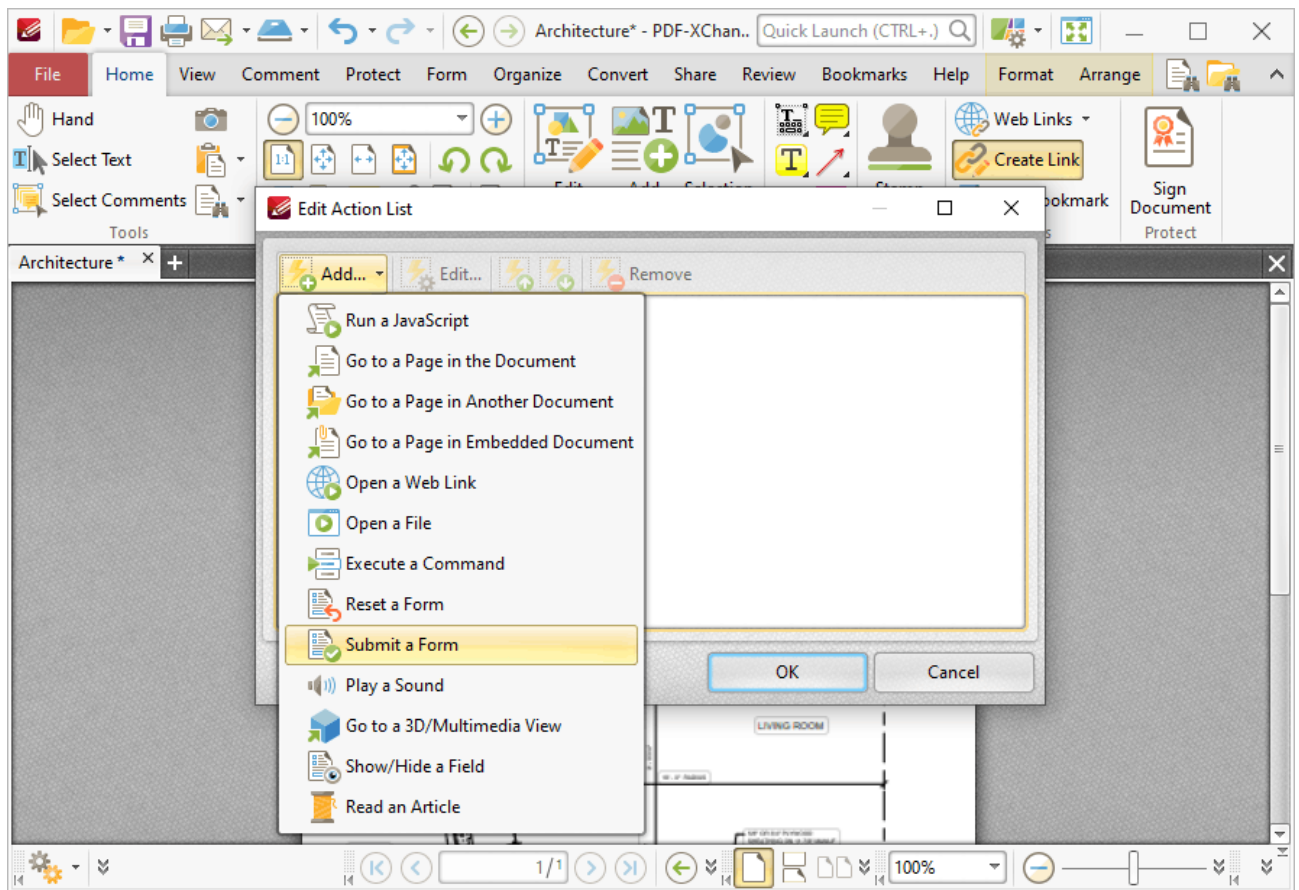

**Figure 1.** Edit Action List Dialog Box, Submit a Form

When it is selected the following dialog box will open:



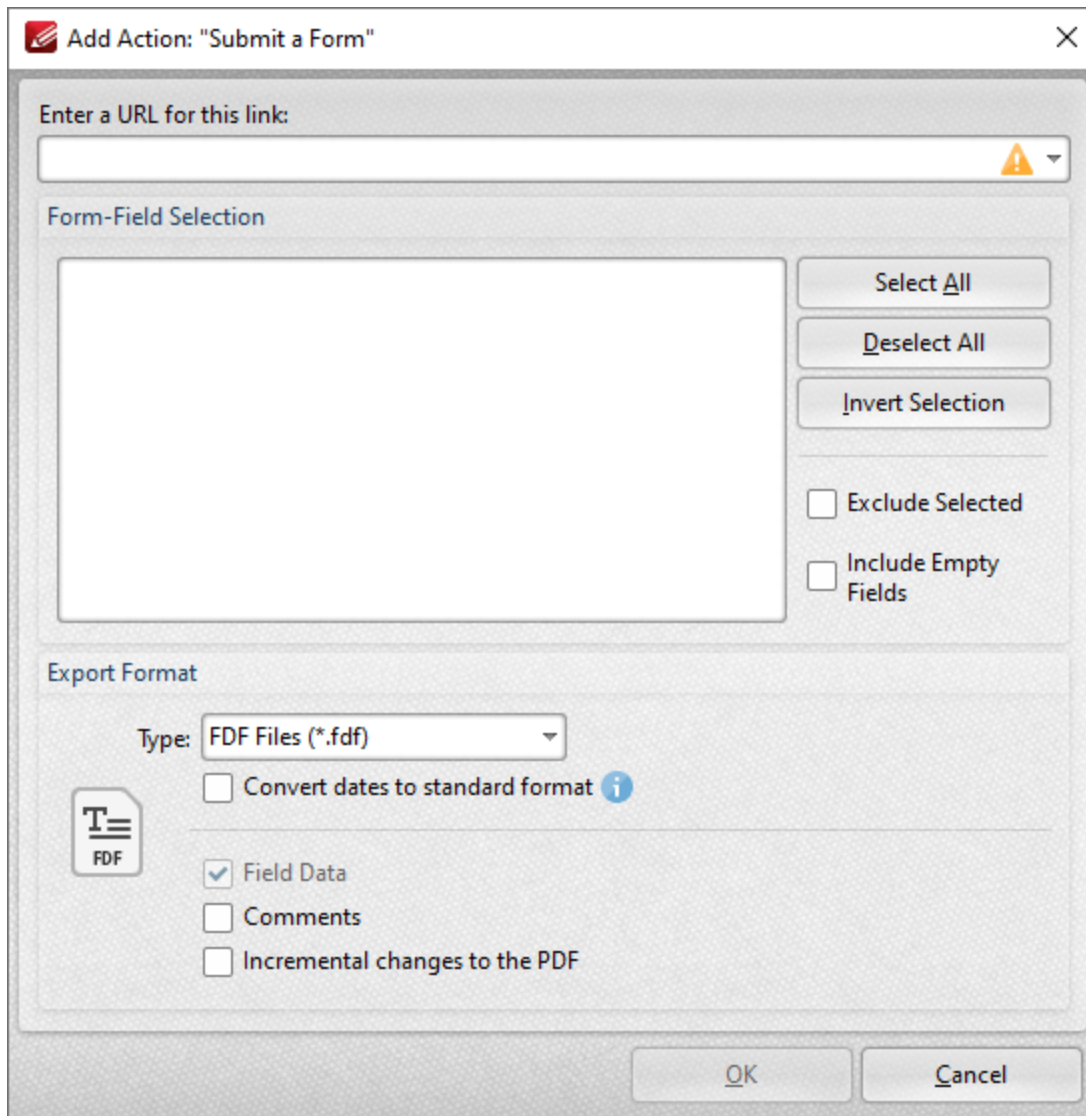



Figure 1. Add Action: "Submit a Form" Dialog Box

- Enter the desired URL in the text box. The specified form data will be sent to this address when the link is clicked.
- All document forms are detailed in the **Form-Field Selection** pane. Use the check boxes to select forms to be sent when the link is clicked.
  - Click **Select All** to select all forms.
  - Click **Deselect All** to deselect all forms.
  - Click **Invert Selection** to invert the current form selection.
  - Select the **Exclude Selected** and **Include Empty Fields** boxes as desired.
- Use the **Export Format** options to determine export format options:
  - Use the **Type** dropdown menu to determine the format of submitted content.
  - Select the **Convert dates to standard format** box as desired.
  - Select the **Field Data**, **Comments** and/or **Incremental changes** boxes as desired. Selected elements will be included in the submitted content.

Click **OK** to save settings.

Note that the **Form**  tab can be used to create/edit forms to use in conjunction with this feature.

---

10.4.2.7.8 Play a Sound



Play a Sound

This action plays a sound when links are clicked:

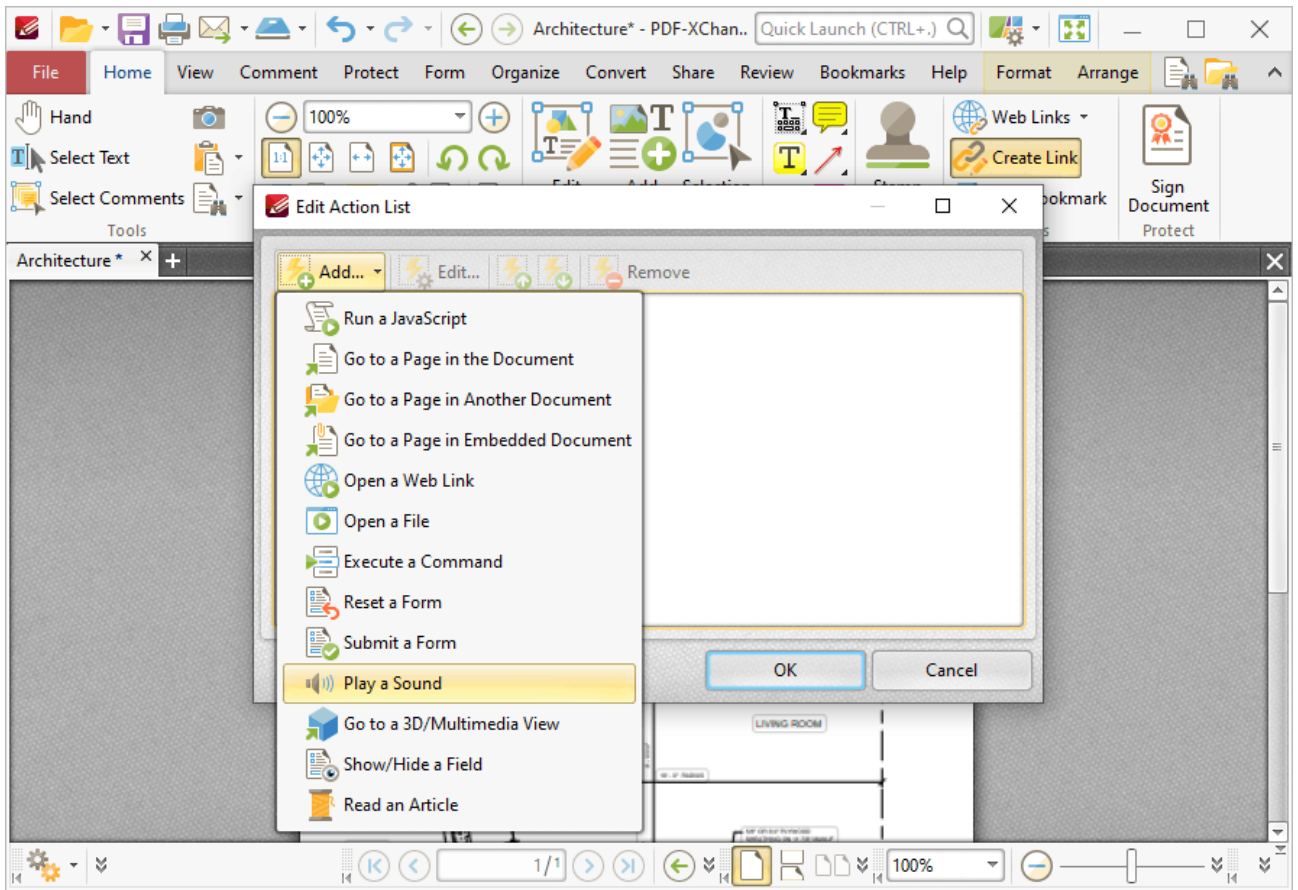
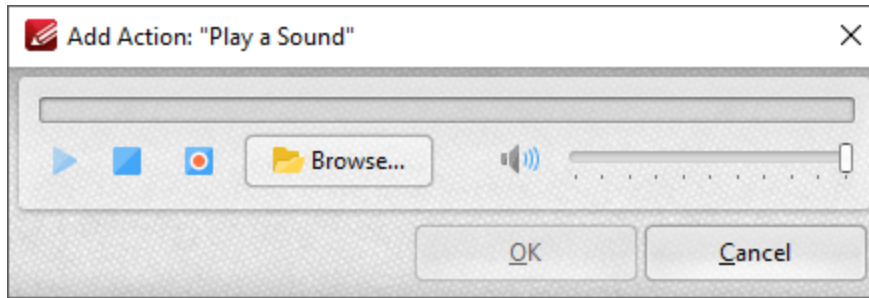

Figure 1. Edit Action List Dialog Box, Play a Sound

When it is selected the following dialog box will open:



**Figure 2.** Add Action: "Play a Sound" Dialog Box

- Click the **Browse** button to select a sound file from the local computer. The **Open Files** dialog box will open. Select the desired file and click **Open**. The selected sound file will play when the link is clicked.
- Alternatively, click the record button to record a sound. Click again to finish the recording. Click the play and stop buttons to review the sound. Use the volume slider to adjust the volume of the sound.

Click **OK** to save the file.

---

10.4.2.7.9 Go to a 3D/Multimedia View



**Go to a 3D/Multimedia View**

This action moves the main window to a specified 3D/multimedia view:

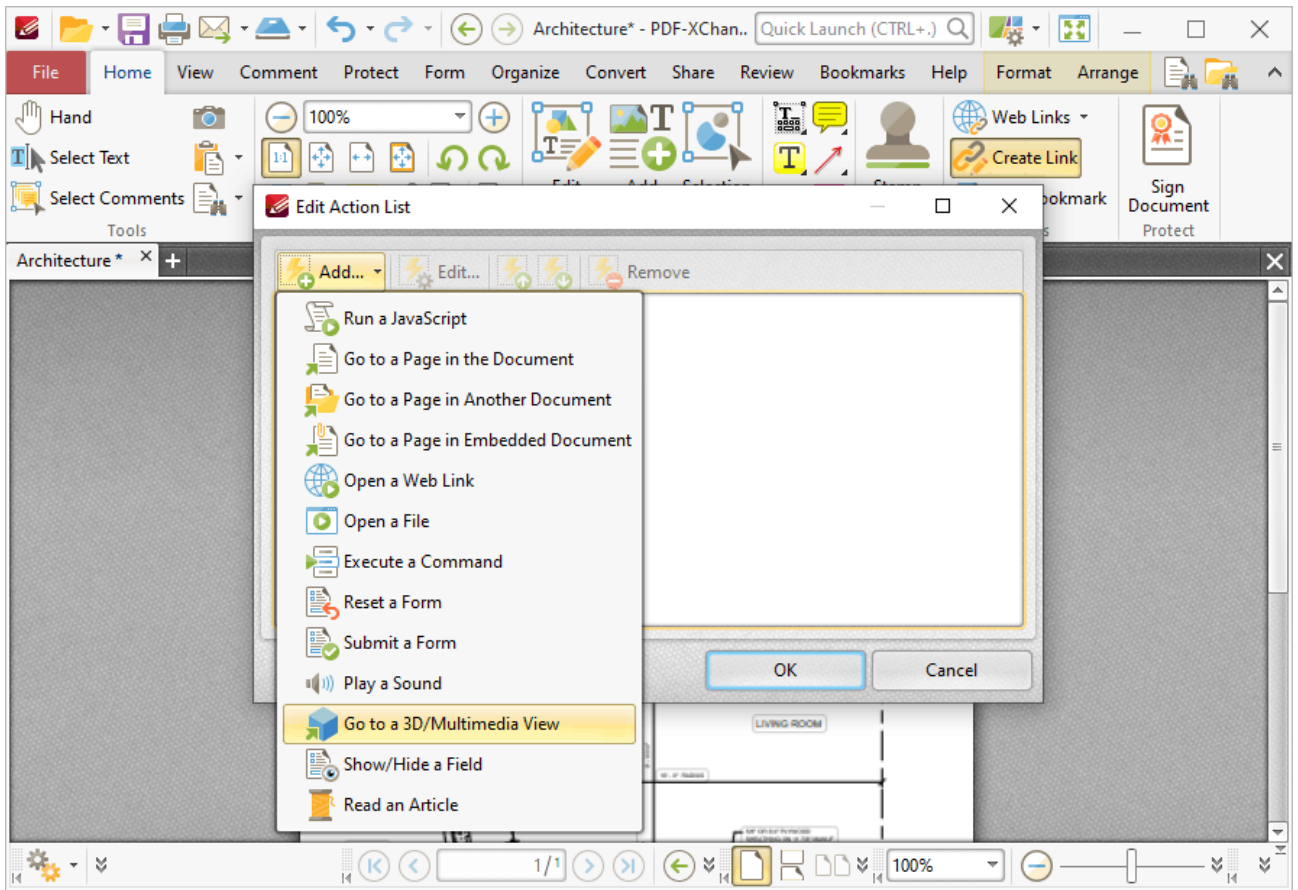

**Figure 1.** Edit Action List Dialog Box, Go to a 3D/Multimedia View

When it is selected the following dialog box will open:

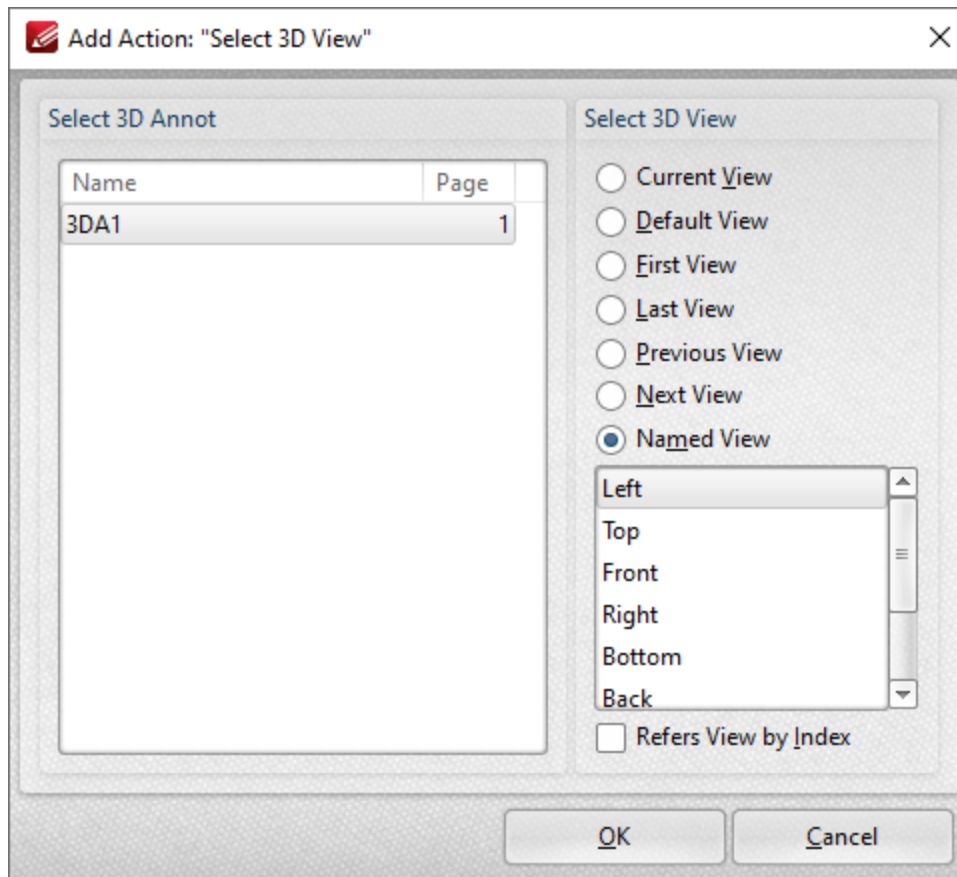

Figure 2. Add Action: "Select 3D View" Dialog Box

- Select the 3D annotation you want the link to open in the **Select 3D Annot** list.
- Select the view of the 3D annotation you want the link to open in the **Select 3D View** list.
- Select **Named View** to specify a named view for the link to open, then select the desired view in the pane.

Click **OK** to save settings.

---

## 10.4.2.7.10 Show/Hide a Field



### Show/Hide a Field

This action is used to show/hide form fields when links are clicked:

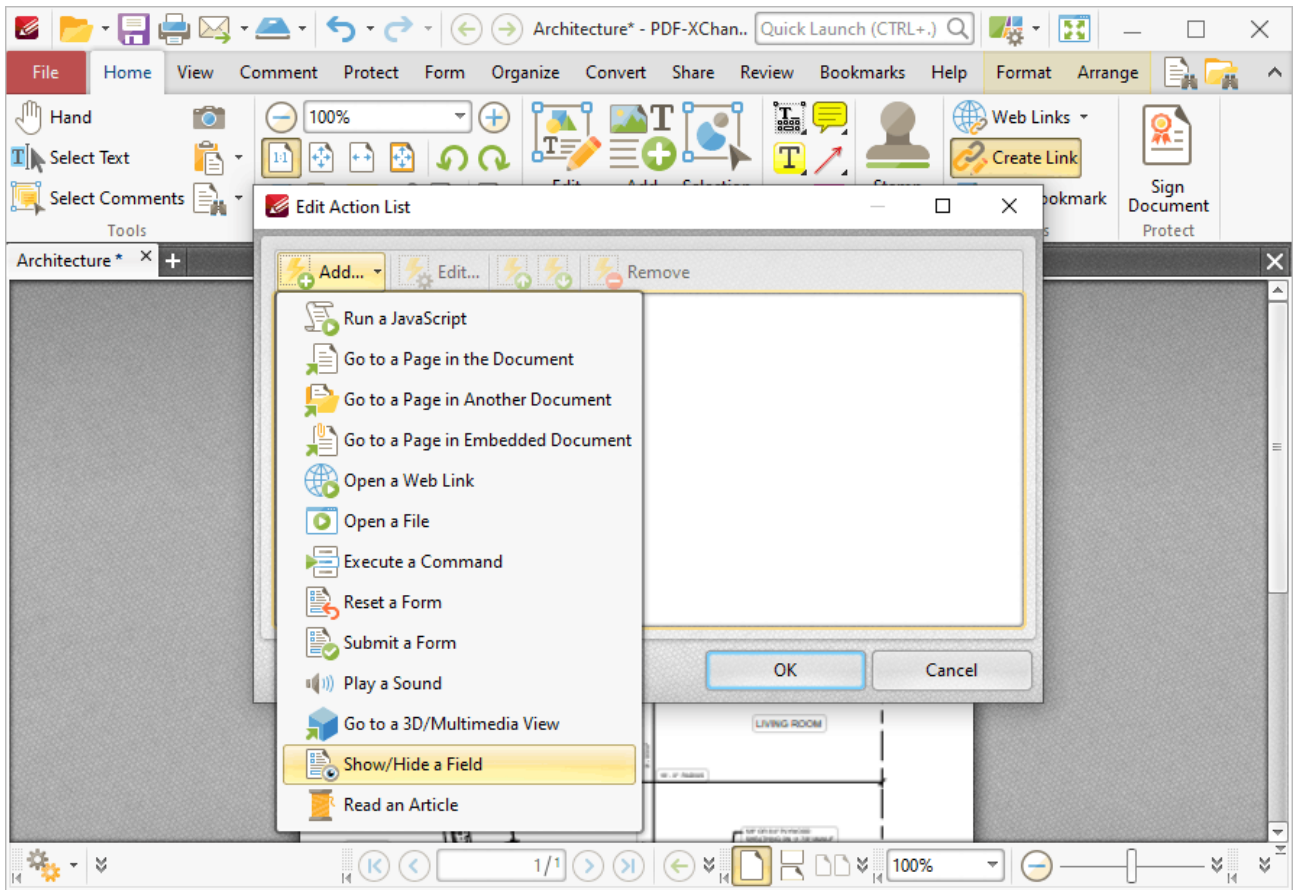

Figure 1. Edit Action List Dialog Box, Show/Hide a Field

When it is selected the following dialog box will open:

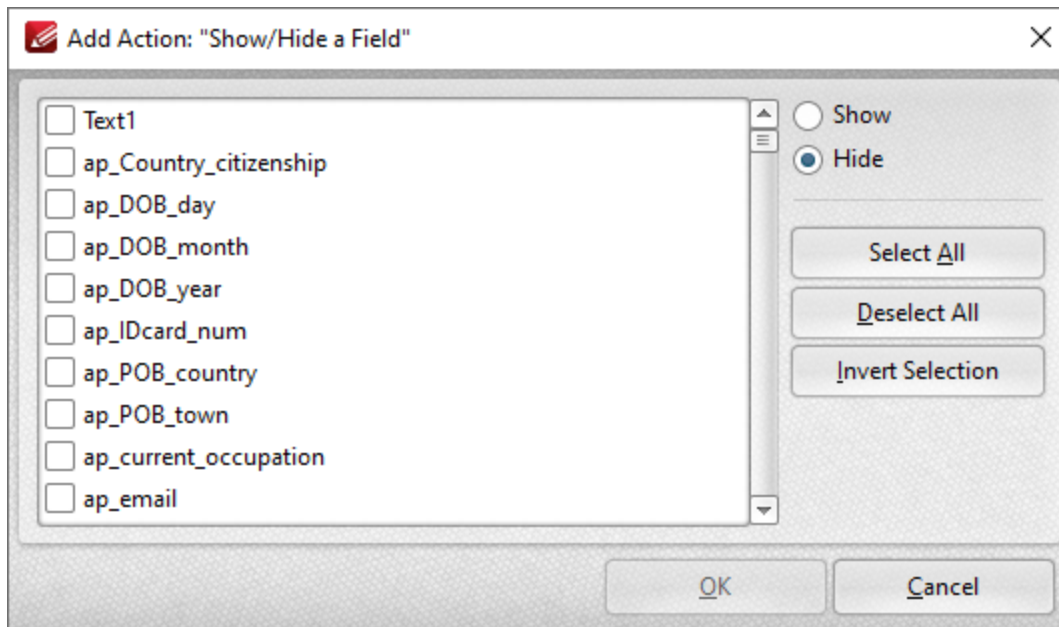

Figure 2. Add Action: "Show/Hide a Field" Dialog Box

All document forms are detailed in the dialog box.

- Select forms and then click either **Show** or **Hide** as desired.
- Click **Select All** to select all forms.
- Click **Deselect All** to deselect all forms.
- Click **Invert Selection** to invert the current form selection.

Click **OK** to save settings.

---



## 10.4.2.7.11 Read an Article

---



### Read an Article

---

This action is not currently available. It will be added in a future build.

---

10.4.3 View Tab



**View Tab**

When the **View Tab** tab is selected, the following options are available:

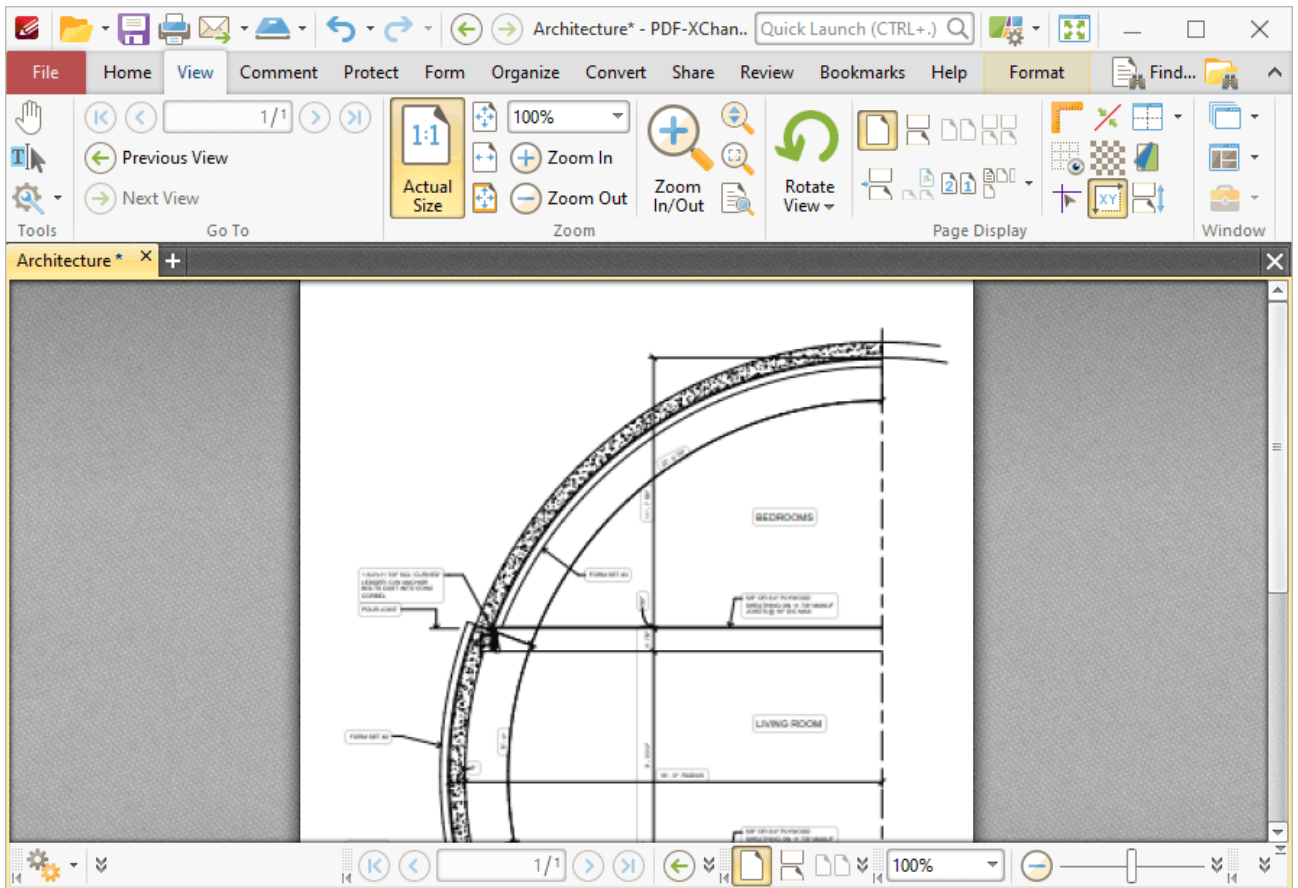
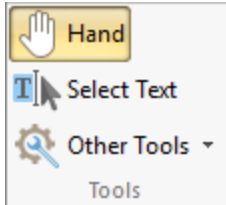

Figure 1. View Tab

The options in the **View** tab are used to navigate and manipulate documents. There are five groups in the **View** tab:

## Tools

The **Tools** group contains shortcuts to tools and other features:







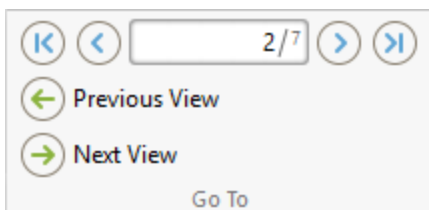

- The **Hand Tool** is used as a basic scrolling device and navigation aid when browsing through documents. Click to enable the **Hand Tool**, then click and drag the page in the desired scrolling direction in order to browse through documents. Further information about the **Hand Tool** and its settings is available [here](#).<sup>[943]</sup>
- The **Select Text Tool** is used to select base-content text. Click to enable the **Select Text Tool**, then click and drag the pointer to select text. Double-click to select words, triple-click to select paragraphs and quadruple-click to select all text on the current page. Right-click selections for editing options, as detailed [here](#).<sup>[1651]</sup>
- Click the **Other Tools** dropdown menu to view/select additional tool options:
  - The **Select Comments Tool** is used to select and edit comments. Click to enable the **Select Comments Tool**, then click to select comments. Click and drag to select multiple comments. Selected comments can be edited, as detailed [here](#).<sup>[1087]</sup>
  - The **Snapshot Tool** is used to take screenshots of pages/selected page content. Click to enable the **Snapshot Tool**, then click or click and drag to take snapshots. Further information about this tool is available [here](#).<sup>[926]</sup>
  - The options in the **Clipboard** dropdown menu is used to interact with the current content of the clipboard. Click the dropdown menu to cut/copy/paste clipboard content.
  - The **Find** feature is used to [Find](#)<sup>[1688]</sup> or [Search](#)<sup>[1776]</sup> text, or to search the internet for text selected with the **Select Text Tool** in the current document.

## Go To



The **Go To** group contains options for navigating the current document:









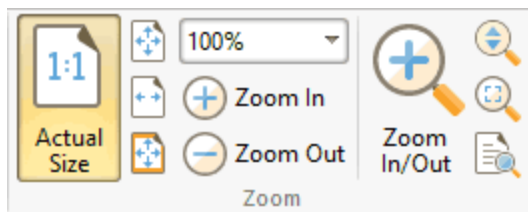

- The number box displays the current page and the total number of pages in the active document. Enter a page number and press **Enter** to move to it.

- Click  **First Page** to move to the first page of the active document.
- Click  **Previous Page** to move to the previous page.
- Click  **Next Page** to move the next page.
- Click  **Last Page** to move to the last page.
- Click  **Previous View** to move to the previous view of the current document.
- Click  **Next View** to move to the next view. This option is available when the **Previous View** option has been used.

## Zoom

The **Zoom** group contains options for adjusting the page view:



- Click  **Actual Size** to set the zoom level to 100% and view pages at their actual size.
- Click  **Fit Page** to fit the page length to the editing space of the user interface.
- Click  **Fit Width** to fit the page width to the editing space of the user interface.
- Click  **Fit Visible** to fit the page width to the editing space of the user interface and ignore white page margins.
- Click  **Zoom In** or  **Zoom Out** to zoom in on/out from the active document.
- Click  **Continuous Zoom** to enable the **Continuous Zoom Tool**, which allows you to zoom in/out continuously. When this tool is enabled, click and hold the mouse button and then move the mouse up/down to scroll in/out.
- Click  **Zoom In/Out Tool** to zoom in on/out from the active document. The pointer becomes a magnifying glass icon when this tool is enabled. Move it to the desired location and then click to zoom. Hold down Ctrl and click to zoom out.
- Click  **Loupe Tool** to enable the **Loupe Tool**, which utilizes a zoom pane that magnifies page portions to assist in document editing. Further information on this tool is available [here](#).<sup>1068</sup>
- Click  **Pan and Zoom Tool** to enable the **Pan and Zoom Tool**, which utilizes a zoom pane that enables dynamic page navigation. Further information on this tool is available [here](#).<sup>1070</sup>





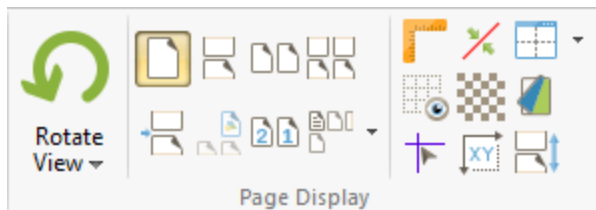





## Page Display

The **Page Display** group contains options for adjusting the page display:









- Click **Rotate View** to view rotation options:
  - Click **Rotate CCW** to rotate the current view ninety degrees counter-clockwise.
  - Click **Rotate CW** to rotate the current view ninety degrees clockwise.

Please note that rotations are intended for viewing/editing purposes only and will not be saved. (The [Thumbnails pane](#)<sup>1000</sup> can be used to rotate pages permanently).

- Click  **Single Page** to display documents one page at a time.
- Click  **Continuous** to display documents one page at a time continuously.
- Click  **Two Pages** to display documents two pages at a time.
- Click  **Two Pages Continuous** to display documents two pages at a time continuously.
- Click  **Show Gaps Between Pages** to enable/display the display of gaps between pages.
- Click  **Show Cover Page in Two Pages View** to include/exclude the first page of documents in **Two Pages/Two Pages Continuous** layout when these modes are enabled.
- Click  **Right-to-Left Page Layout** to enable/disable right-to-left page layout when the **Two Pages/Two Pages Continuous** modes are enabled.
- Click  **Page Layout** to switch between **Standard Layout**, which displays pages in top-to-bottom order, and **Ribbon Layout**, which displays pages in left-to-right order.
- Click  **Show Rulers** to show/hide rulers, which can be used to assist in measuring documents and document content. The **Rulers** feature is detailed [here](#).<sup>1075</sup>
- Click  **Thin Lines** to enable/disable the **Thin Lines** feature, which displays all annotation lines at a thickness of one pixel. This is a useful feature in cases where important document content is obscured as a result of multiple annotations/annotations with large borders. Annotation lines are those created using the annotation tools, which are detailed [here](#).<sup>1082</sup>
- Click  **Split** to split the current document into two views, which is a useful editing aid. Click the dropdown arrow to select **Horizontal Split**, **Vertical Split** or **Spreadsheet Split** as

desired. When this option is enabled the **Split** icon is highlighted in the user interface. Click the icon to disable the split.

- Click  **Show Grid** to enable/disable the editing grid. The editing grid is transposed onto documents and used to ensure that objects are aligned correctly.
- Click  **Transparency Grid** to enable/disable the transparency grid. A grid is displayed behind transparent objects when this option is enabled.
- Click  **Page Transitions** to determine how **PDF-XChange Editor** transitions between pages when fullscreen mode is enabled. The **Page Transition** settings are detailed [here](#).<sup>[1072]</sup>
- Click  **Show Guides** to show/hide guides, which are used in conjunction with rulers to simplify the process of aligning document objects. Click and drag from rulers to launch guides, as detailed [here](#).<sup>[1075]</sup>
- Click  **Show Page Size/Position** to show/hide the current page size and pointer location. These details are displayed in the **Document Options** toolbar, which is in the lower-left section of the user interface.
- Click  **Autoscroll** to enable/disable autoscroll, which scrolls automatically through documents. The keyboard shortcut to enable/disable autoscroll is Ctrl+Shift+H. Use the up and down arrows to adjust the autoscoll speed, and/or press the minus key to change the autoscroll direction.

## Window

The **Window** group contains options for adjusting document tabs and showing/hiding editing panes:

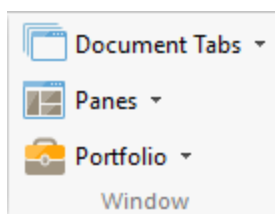

- Click **Document Tabs** to adjust document tabs:
  - Click **New Document Window** to open the current document in a new document window.
  - Click **Active Document to New Horizontal Tab Group** to move the active document to a new horizontal tab group.
  - Click **Active Document to New Vertical Tab Group** to move the active document to a new vertical tab group.
  - Click **All Documents to One Tab Group** to move all open documents to a single tab group.
  - Click **Close All** to close all open documents.

- Click **Reopen Recently Closed Document** (or press Ctrl+Shift+W) to open recently closed documents.
- Click **Panes** to view/select the **PDF-XChange Editor** panes and pane options:
  - Click **Bookmarks** to open the [Bookmarks](#)<sup>[994]</sup> pane and view/edit/create bookmarks.
  - Click **Thumbnails** to open the [Thumbnails](#)<sup>[1000]</sup> pane and view page thumbnails/edit document pages.
  - Click **Comments** to open the [Comments](#)<sup>[1007]</sup> pane and view/edit comments.
  - Click **Attachments** to open the [Attachments](#)<sup>[1014]</sup> pane and view/edit/create attachments to the current document.
  - Click **Fields** to open the [Fields](#)<sup>[1016]</sup> pane and view/edit form fields.
  - Click **Signatures** to open the [Signatures](#)<sup>[1021]</sup> pane and view/edit digital signatures.
  - Click **Layers** to open the [Layers](#)<sup>[1024]</sup> pane and view/edit layers.
  - Click **Content** to open the [Content](#)<sup>[1032]</sup> pane and view/edit base content.
  - Click **Destinations** to open the [Destinations](#)<sup>[1036]</sup> pane and view/edit named destinations.
  - Click **Pan and Zoom** to launch the [Pan and Zoom](#)<sup>[1070]</sup> tool.
  - Click **Stamps Palette** to open the [Stamps Palette](#)<sup>[1050]</sup> and view/edit/select stamps.
  - Click **Comment Styles Palette** to open the [Comment Styles Palette](#)<sup>[1242]</sup> and view/select comment styles.
  - Click **Spell Check** to open the [Spell Check](#)<sup>[1545]</sup> pane and check document spelling.
  - Click **Document Recovery** to open the [Document Recovery](#)<sup>[1059]</sup> pane, which is used to view/manipulate data recovered by the autosave feature.
  - Click **Properties** pane to open the [Properties](#)<sup>[1065]</sup> pane and view/edit the properties of document objects.
  - Click **Reset Main Panes Layout** to restore the default layout of the [Properties Pane](#)<sup>[1065]</sup>, [Search Pane](#)<sup>[1776]</sup>, [Stamps Palette](#)<sup>[1192]</sup> and [Comment Styles Palette](#)<sup>[1242]</sup>.
  - Click **Reset Document Panes Layout** to restore the default layout of the [Bookmarks Pane](#)<sup>[994]</sup>, [Thumbnails Pane](#)<sup>[1000]</sup>, [Destinations Pane](#)<sup>[1036]</sup>, [Content Pane](#)<sup>[1032]</sup>, [Signatures Pane](#)<sup>[1021]</sup>, [Layers Pane](#)<sup>[1024]</sup>, [Comments Pane](#)<sup>[1007]</sup>, [Attachments Pane](#)<sup>[1014]</sup> and [Fields Pane](#)<sup>[1016]</sup>.
- Click **Portfolio** to view/select options for PDF portfolio files:
  - Click **Navigator Layout View** or **Navigator Details View** to switch between these two viewing modes.
  - Click **Show Cover Sheet** to show/hide the cover sheet.
  - Click **Show Navigator** to show/hide the document navigator.
  - Click **Welcome Page** to show/hide the welcome page of PDF portfolio files.
  - Click **Preview File** to preview the file currently selected in the portfolio file.
  - Click **Portfolio Tools** to edit portfolio files, as detailed [here](#)<sup>[1630]</sup>.

Please see the [Document Operations Guide](#)<sup>[632]</sup> for further information and step-by-step instructions to using these features.

## 10.4.3.1 Editing Panes



## Editing Panes

The following editing panes are available in **PDF-XChange Editor**:

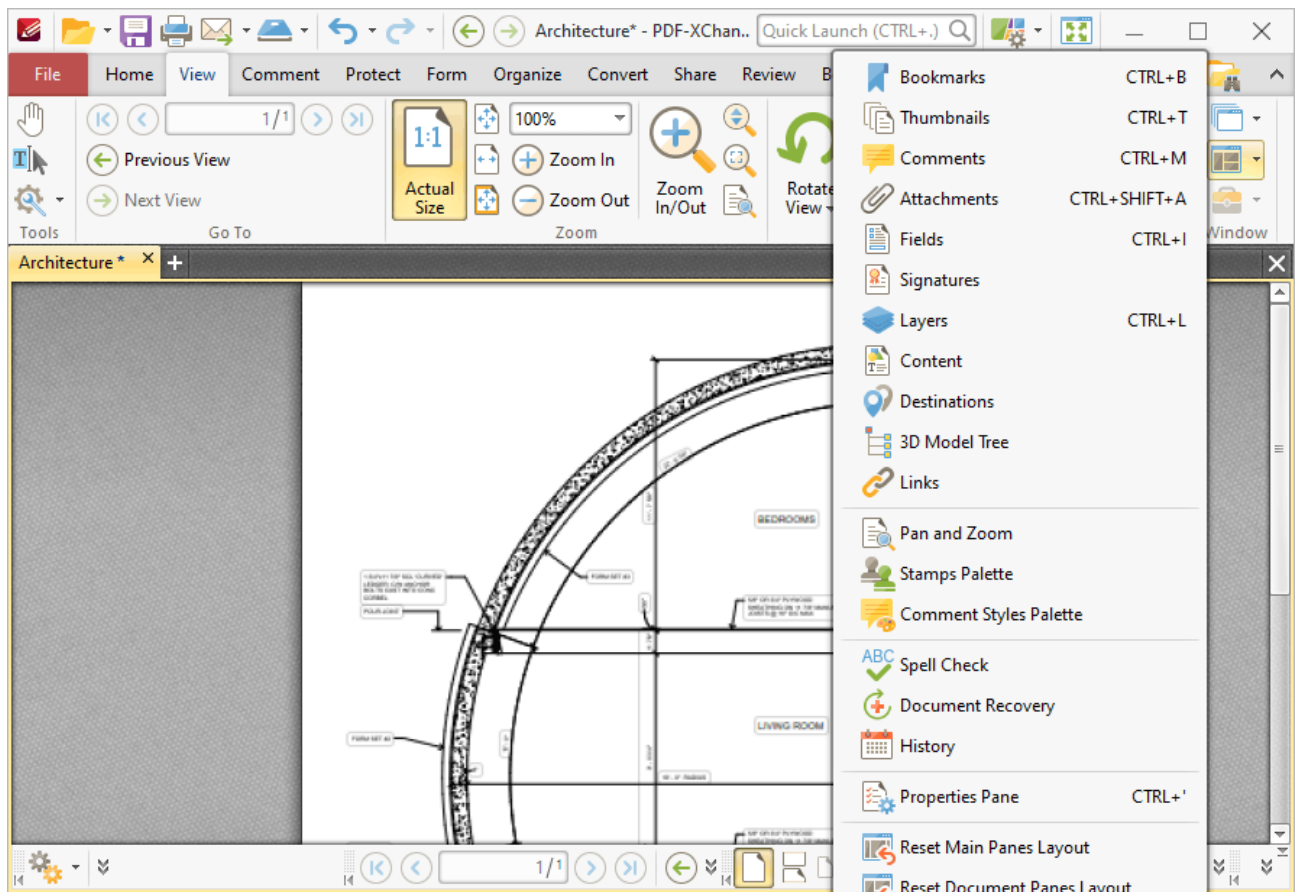

Figure 1. View Tab, Panes Dropdown Menu

- The **Bookmarks** <sup>994</sup> pane is used to create, view and manage bookmarks.
- The **Thumbnails** <sup>1000</sup> pane displays thumbnails of documents pages and can be used to edit documents on the page level.
- The **Comments** <sup>1007</sup> pane displays all comments in the active document, and can be used to create and edit comments.



- The [Attachments](#)  pane displays all document attachments, and can be used to add, delete or manage attachments.
  - The [Fields](#)  pane displays all form fields in the current document, and can be used to edit and manipulate form fields.
  - The [Signatures](#)  pane displays all signed and unsigned signature fields in the current document, and can be used to perform a range of operations that relate to digital signatures.
  - The [Layers](#)  pane displays all layers in the current document, and can be used to perform a range of operations that relate to layers.
  - The [Content](#)  pane displays all content in the current document, and can be used to edit and manipulate content as desired.
  - The [Destinations](#)  pane displays all named destinations in the current document, and can be used to create, edit and update named destinations.
  - The [3DModel Tree](#)  pane displays the hierarchy of selected 3D content in the current document.
  - The [Pan and Zoom](#)  pane is used to assist in editing documents, and displays a dynamic miniature version of the current document that can be updated to change the zoom level of the current document.
  - The [Links](#)  pane displays all links in the current document and can be used to create new or edit existing links.
  - The [Pan and Zoom](#)  pane displays a miniature version of the current page to assist in editing documents.
  - The [Stamps Palette](#)  displays all available stamps, and can be used to select, create and edit stamps.
  - The [Comment Styles Palette](#)  displays all default, preset and customized comment styles, and can be used to select and edit these styles.
  - The [Spell Check](#)  pane is used to check document spelling.
  - The [Document Recovery](#)  pane displays recovered documents when documents are closed with unsaved changes in **PDF-XChange Editor**, and can be used to recover those documents.
  - The [History](#)  pane displays the history of documents opened in **PDF-XChange Editor** and can be used to browse/open those documents.
  - The [Properties](#)  pane displays the properties of selected content and tools, and can be used to adjust those properties as desired.
-

10.4.3.1.1 Bookmarks



**Bookmarks**

Click **Bookmarks** (or press Ctrl+B) to show/hide the **Bookmarks** pane:

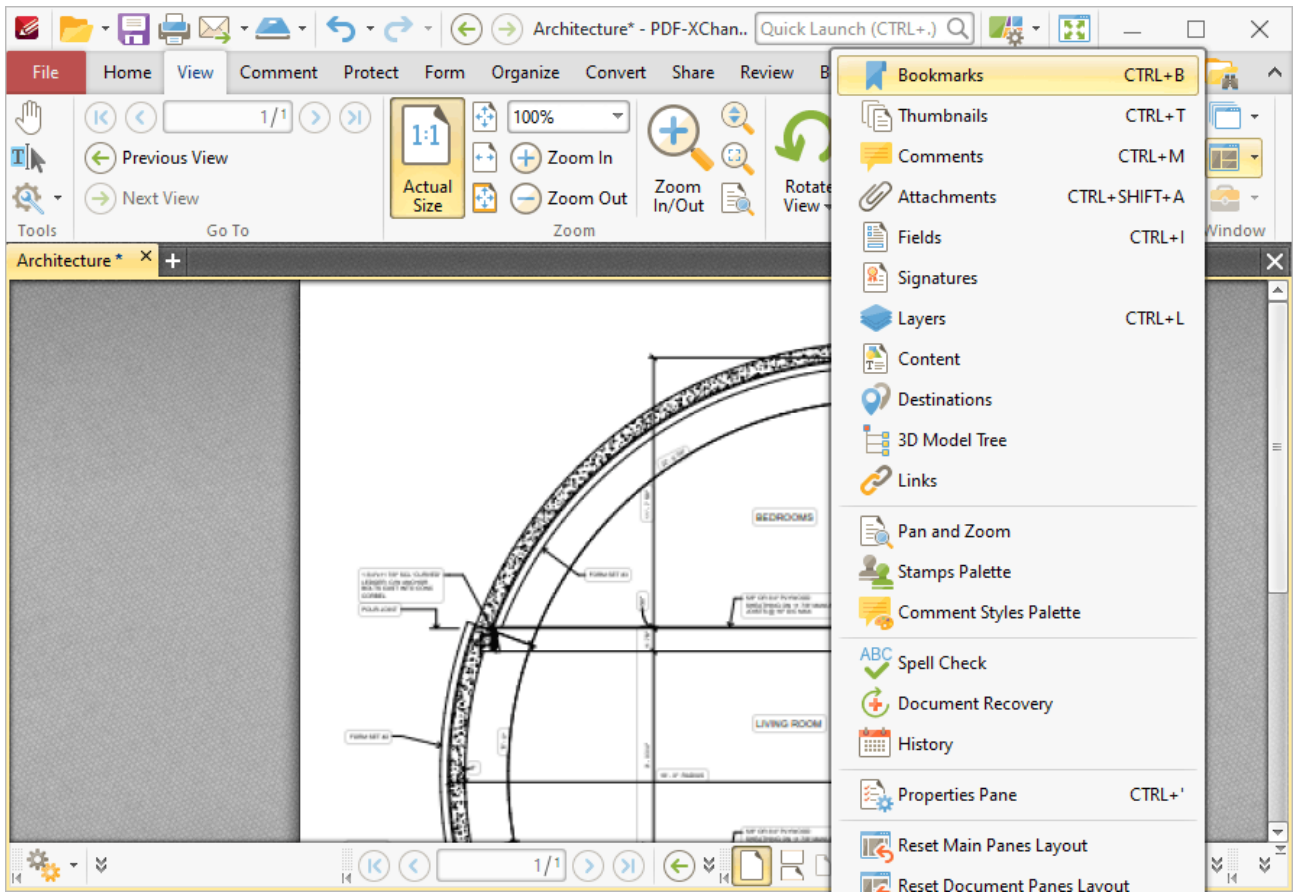

Figure 1. View Tab, Panes Dropdown Menu, Bookmarks

The **Bookmarks** pane appears as below:

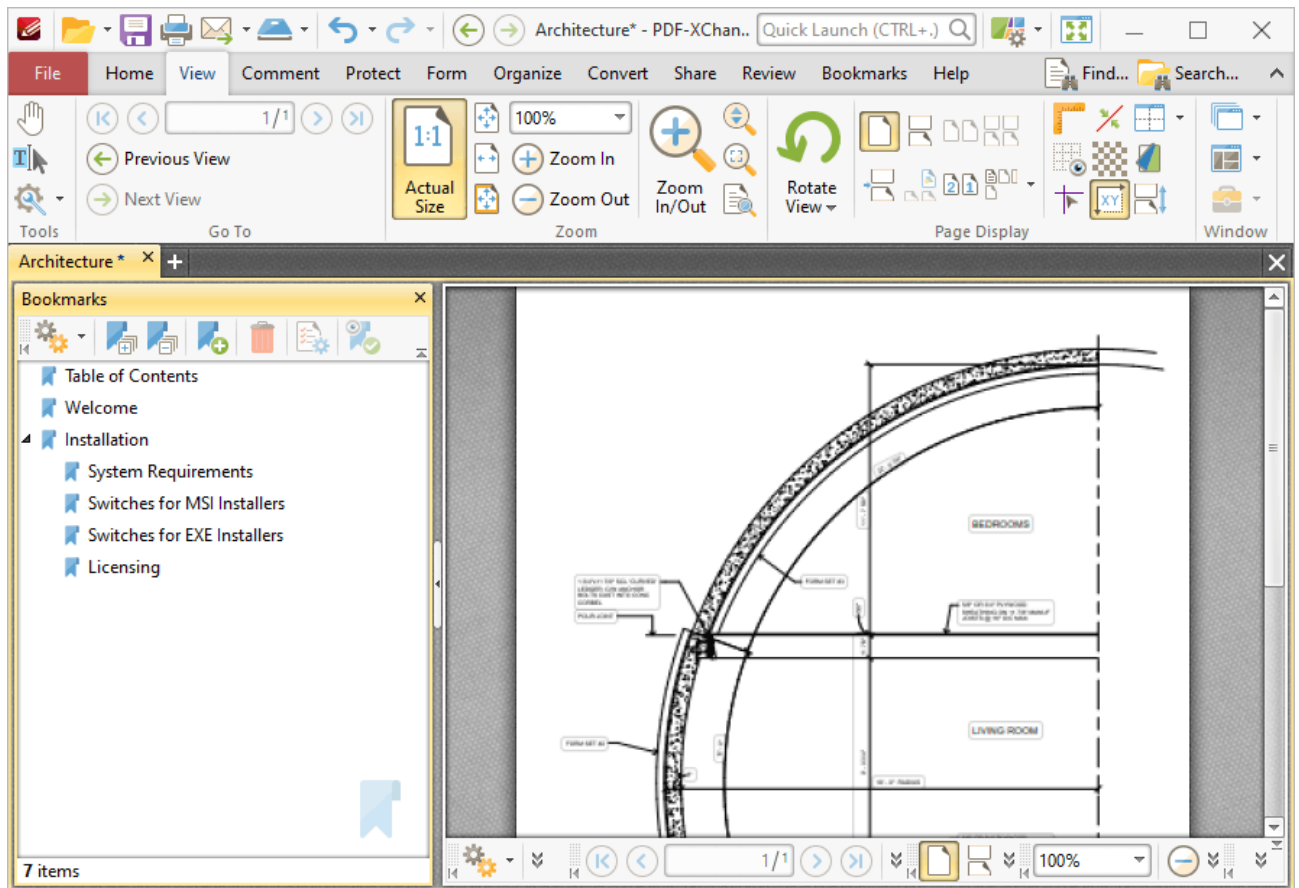







Figure 2. Bookmarks Pane

Bookmarks are used to designate specific places of importance within documents. All bookmarks contained within the active document are displayed in the **Bookmarks** pane. Use the icons in the **Bookmarks** pane to perform the following operations:

- Click  **Expand All Bookmarks** to expand all bookmarks.
- Click  **Collapse All Bookmarks** to collapse all bookmarks.
- Click  **New Bookmark** to create a new bookmark. See [Keyboard Shortcuts](#) for available keyboard shortcuts when creating new bookmarks.
- Click  **Delete** to delete selected bookmarks.
- Click  **Ensure Visibility of Corresponding Bookmark** to expand parent bookmarks in a manner that ensures the visibility of corresponding bookmarks.
- Click  **Properties** to view/edit the properties of selected bookmarks. The **Bookmark Properties** pane will open:

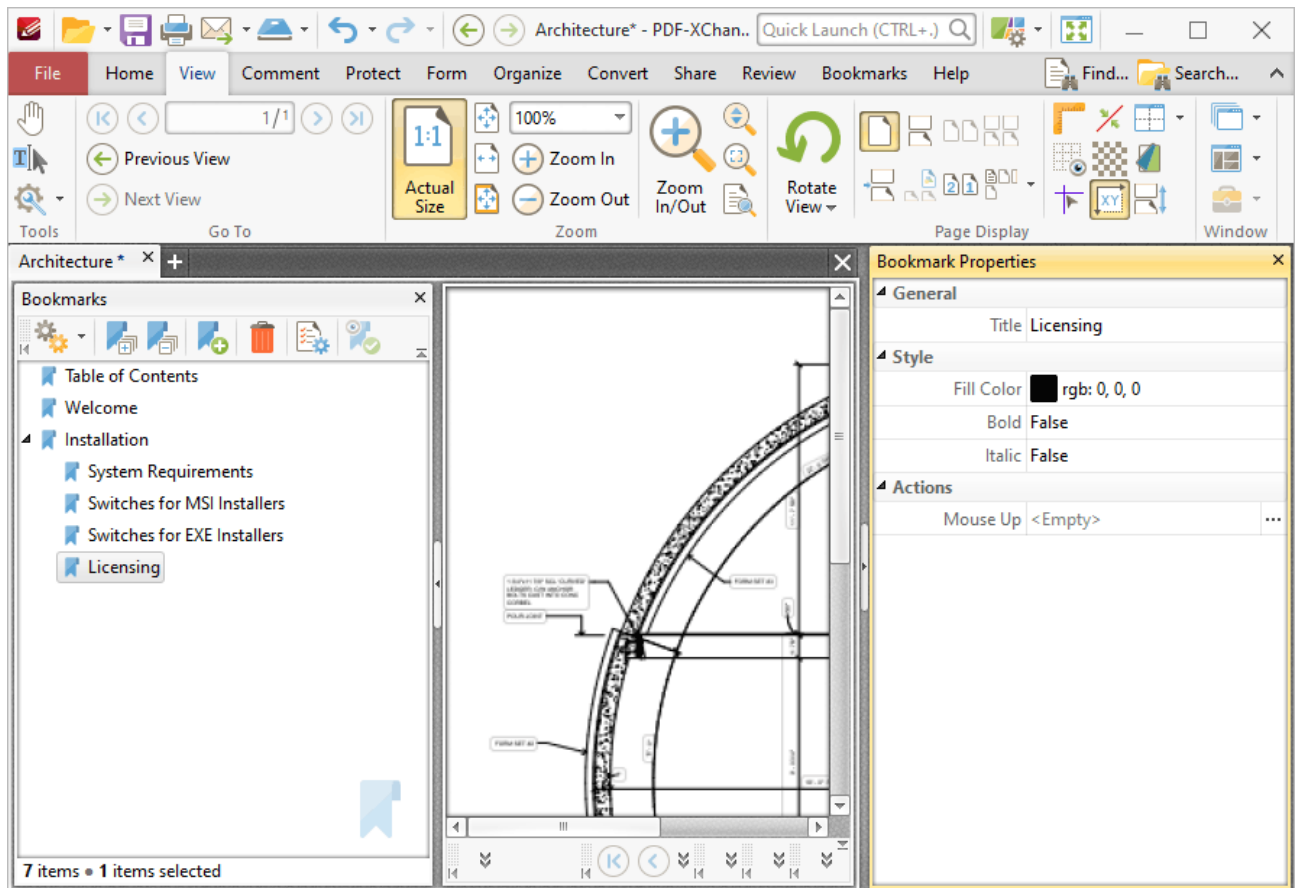



Figure 3. Bookmark Properties Pane

- The **Title** property displays the bookmark title. Click the text to edit the bookmark title.
- The **Fill Color** property displays the color of the bookmark title. Click to edit the color of the bookmark title.
- The **Bold** and **Italic** properties display the parameter values for whether or not the bookmark title is bold or italic. Click values to change the property from **False** to **True** as desired.
- The **Mouse Up** property displays the action performed when the bookmark is clicked. The default action is **Go to a Page in the Document**, which is the standard action that bookmarks perform. However, there are a range of alternative actions available, including the activation of JavaScript, opening of weblinks and execution of **PDF-XChange Editor** commands. A comprehensive list of available actions, and instructions on how to add/edit their parameters, is available [here](#).<sup>960</sup>

Click  **Options**, or right-click bookmarks, for bookmark options:



























|   |        |
|---|--------|
|  <u>G</u> o to Bookmark  | ENTER  |
|  <u>N</u> ew Bookmark...   | INSERT |
|  <u>C</u> ut   | CTRL+X |
|  <u>C</u> opy  | CTRL+C |
|  <u>P</u> aste   | CTRL+V |
|    |        |
|  <u>D</u> elete  | DELETE |
|  Expand All Bookmarks  |        |
|  Collapse All Bookmarks  |        |
|  Ensure Visibility of Corresponding Bookmark                       |        |
|  <u>R</u> ename  | F2     |
|  <u>S</u> et Destination  |        |
|  <u>M</u> ake Current Properties Default                         |        |
|  <u>A</u> pply Default Properties                                |        |
|  <u>T</u> ext Size   | ▶      |
| <input checked="" type="checkbox"/>  <u>W</u> rap Long Bookmarks |        |
| <input checked="" type="checkbox"/>  <u>S</u> how/Hide Icons     |        |
| <input checked="" type="checkbox"/>  <u>U</u> se Inherited Zoom  |        |
|  <u>A</u> utomatically Expand Bookmarks                          |        |
|  <u>P</u> age(s)   | ▶      |
|  <u>S</u> ection(s)  | ▶      |
|  <u>I</u> mport Bookmarks...                                     |        |
|  <u>E</u> xport Selected Bookmarks...                            |        |
|  <u>E</u> xport All Bookmarks...                                 |        |
| <input checked="" type="checkbox"/>  <u>S</u> how Info Bar       |        |
|  <u>P</u> roperties...   |        |

Figure 4. Bookmarks Options

- Click **Go To Bookmark** to move to the bookmark currently selected.
- Click **New Bookmark** to create a new bookmark.
- Click **Cut, Copy, Paste, Delete** to perform these actions on selected bookmarks. If you have copied text to the clipboard then you can click **Paste as plain text** to create a bookmark that uses the copied text as a bookmark title.
- Click **Expand/Collapse All Bookmarks** to expand/collapse all bookmarks.
- Click **Ensure Visibility of Corresponding Bookmark** to expand parent bookmarks in a manner that ensures the visibility of corresponding bookmarks.
- Click **Rename** to rename selected bookmarks.
- Click **Set Destination** to change the location of the selected bookmark to the current view of the active document.
- Click **Make Current Properties Default** to set the properties of the current bookmark as the default setting for subsequent bookmarks.
- Click **Apply Default Properties** to apply the default bookmark properties to selected bookmarks.
- Hover over **Text Size** to set the font size of bookmark titles, then select either **Small, Medium** or **Large** in the submenu.
- Click **Wrap Long Bookmarks** to fit bookmarks with long names to the dimensions of the **Bookmarks** pane. If this option is not enabled then bookmark titles will be a single line regardless of their length.
- Click **Show/Hide Icons** as desired.
- Click **Use Inherited Zoom** to retain the current zoom level when bookmarks are clicked. If this option is disabled then the zoom level will change to the level that was current when the bookmark was created.
- Click **Automatically Expand Bookmarks** to expand all child bookmarks by default.
- Hover over **Pages** to view options for pages:
  - Click **Print** to print the pages designated to the bookmark and its child bookmarks. The **Print**<sup>833</sup> dialog box will open with the designated pages in the **Page Range** box.
  - Click **Extract** to extract the pages designated to the bookmark and its child bookmarks to a new document. The **Extract Pages**<sup>1462</sup> dialog box will open with the designated pages in the **Page Range** box.
  - Click **Select** to select the pages designated to the bookmark and its child bookmarks in the **Thumbnails**<sup>1000</sup> pane, which will open with the designated pages selected.
- Hover over **Sections** to view options for sections:
  - Click **Print** to print the sections designated to the bookmark and its child bookmarks. The **Print**<sup>833</sup> dialog box will open with the designated sections in the **Page Range** box.
  - Click **Extract** to extract the sections designated to the bookmark and its child bookmarks to a new document. The **Extract Pages**<sup>1462</sup> dialog box will open with the designated sections in the **Page Range** box.
  - Click **Select** to select the sections designated to the bookmark and its child bookmarks in the **Thumbnails**<sup>1000</sup> pane, which will open with the designated sections selected.
- Click **Import Bookmarks** to import saved bookmarks.
- Click **Export Selected Bookmarks** to export selected bookmarks.

- Click **Export All Bookmarks** to export all bookmarks.
- Click **Show Info Bar** to show/hide the information bar at the bottom of the **Bookmarks** pane.
- Click **Properties** to view/edit the properties of selected bookmarks, as detailed in *(figure 3)*.

Further bookmark options are available in the [Bookmarks](#)<sup>1549</sup> tab. Additionally, the [Bookmarks Guide](#)<sup>624</sup> is a useful resource that contains all bookmark operations.

---

10.4.3.1.2 Thumbnails



Thumbnails

Click **Thumbnails** (or press Ctrl+T) to show/hide the **Thumbnails** pane:

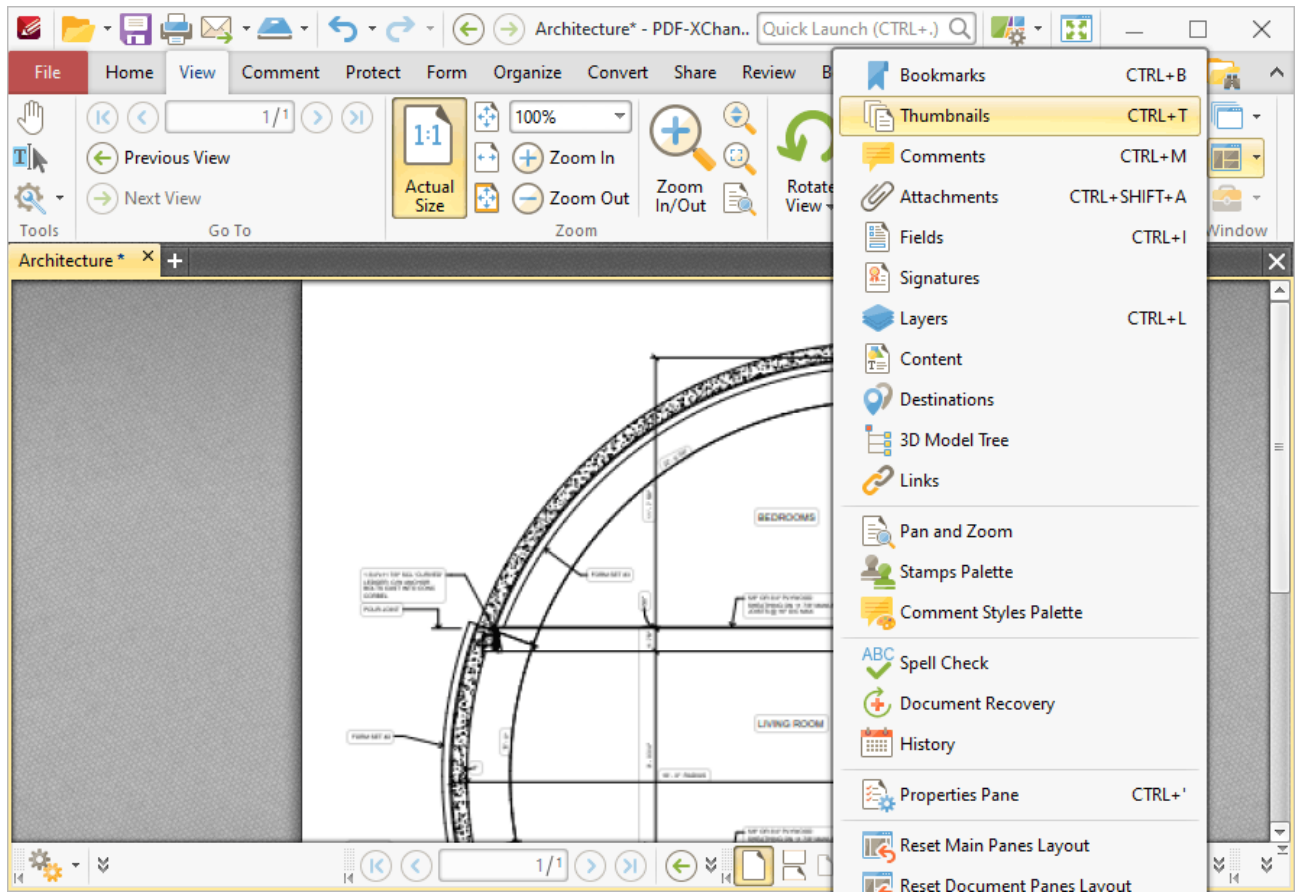

Figure 1. View Tab, Panes Dropdown Menu, Bookmarks

The **Thumbnails** pane appears as below:



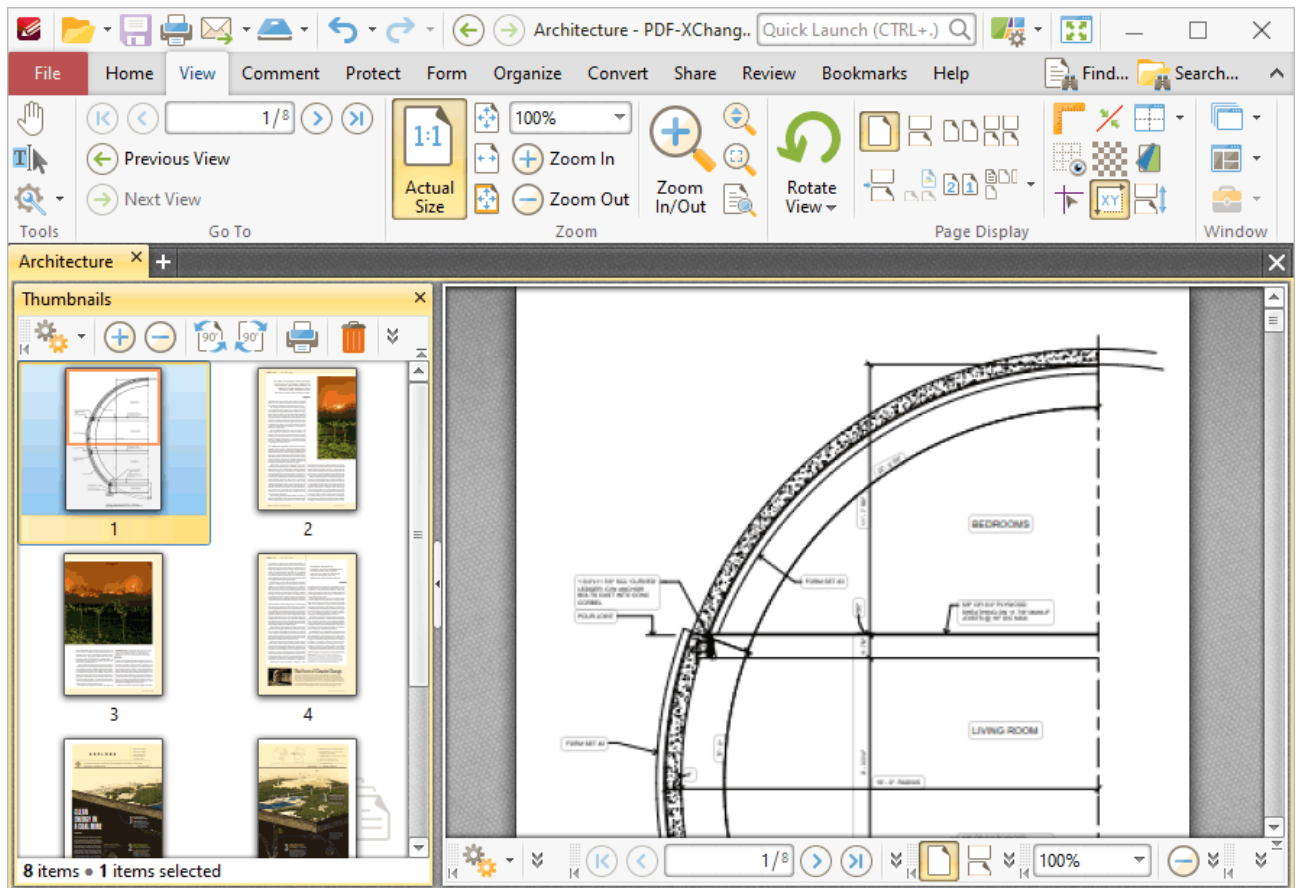









Figure 2. Thumbnails Pane

Thumbnails are a convenient method to view, manage and edit document pages. A smaller representation of document pages is displayed in the **Thumbnails** pane.

- The orange rectangle represents the current page view.
- Click on pages/page locations in the thumbnails pane to move to those locations in the active document.
- Click and drag thumbnail pages to reorder them in the active document.
- Press and hold Ctrl to select multiple pages for group-editing.
- Press Ctrl+A to select all pages in the **Thumbnails** pane.
- The **Thumbnails** pane can be used to create page ranges. Click the first page of the desired range, then press and hold Shift and click the final page of the desired range.
- The **Thumbnails** pane can also be used to copy pages between open documents. Select the desired pages, then right-click and select **Copy** in the submenu. Move to the desired location in the **Thumbnails** pane of the destination document, then right-click and select **Paste** to complete the operation.
- It is possible to paste text, (\*.rtf) files and images as new document pages via the **Thumbnails** pane.

Use the icons in the **Thumbnails** pane to perform the following operations:

- Click  **Zoom In** to zoom in on thumbnails.
- Click  **Zoom Out** to zoom out from thumbnails.
- Click  **Rotate Pages CCW 90°** to rotate selected pages ninety degrees counterclockwise.
- Click  **Rotate Pages CW 90°** to rotate selected pages ninety degrees clockwise.
- Click  **Print** to print documents.
- Click  **Delete** to delete selected pages.
- Click  **Properties** to view the properties of selected pages. The **Page Properties** pane will open:

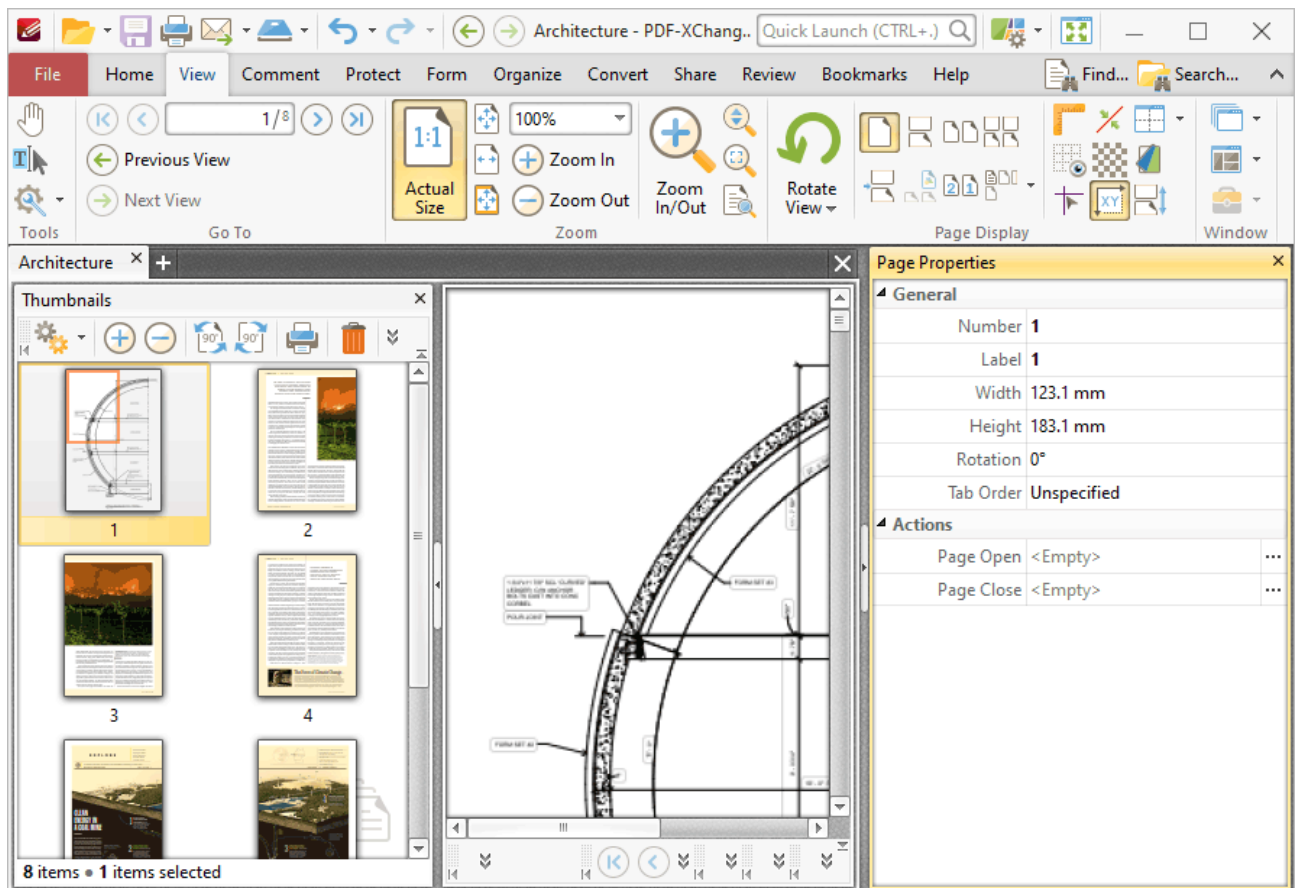



Figure 3. Page Properties Pane

- The **Number** property displays the physical page number of document pages.
- The **Label** property displays the logical page number of document pages. The [Number Pages](#)<sup>1504</sup> feature can be used to edit this property.
- The **Width** and **Height** properties display the physical size of document pages. The [Resize Pages](#)<sup>1488</sup> feature can be used to adjust the size of document pages.

- The **Rotation** property displays the current page rotation. Click the property and then use the dropdown menu to adjust the page rotation as desired.
- The **Tab Order** property displays the designated tab order of pages. This property determines the method used to scroll through page items such as comments, form fields and images. Click the property and select an option from the dropdown menu as desired.
- The **Page Open** and **Page Close** properties enable the activation of custom actions when document pages are opened/closed. Click the ellipsis icon on the right of these properties to add/edit actions. There are a range of actions available, including the activation of JavaScript, opening of weblinks and execution of **PDF-XChange Editor** commands. A comprehensive list of available actions, and instructions on how to add/edit their parameters, is available [here](#).<sup>960</sup>

Click  **Options**, or right-click thumbnails, for thumbnail options:

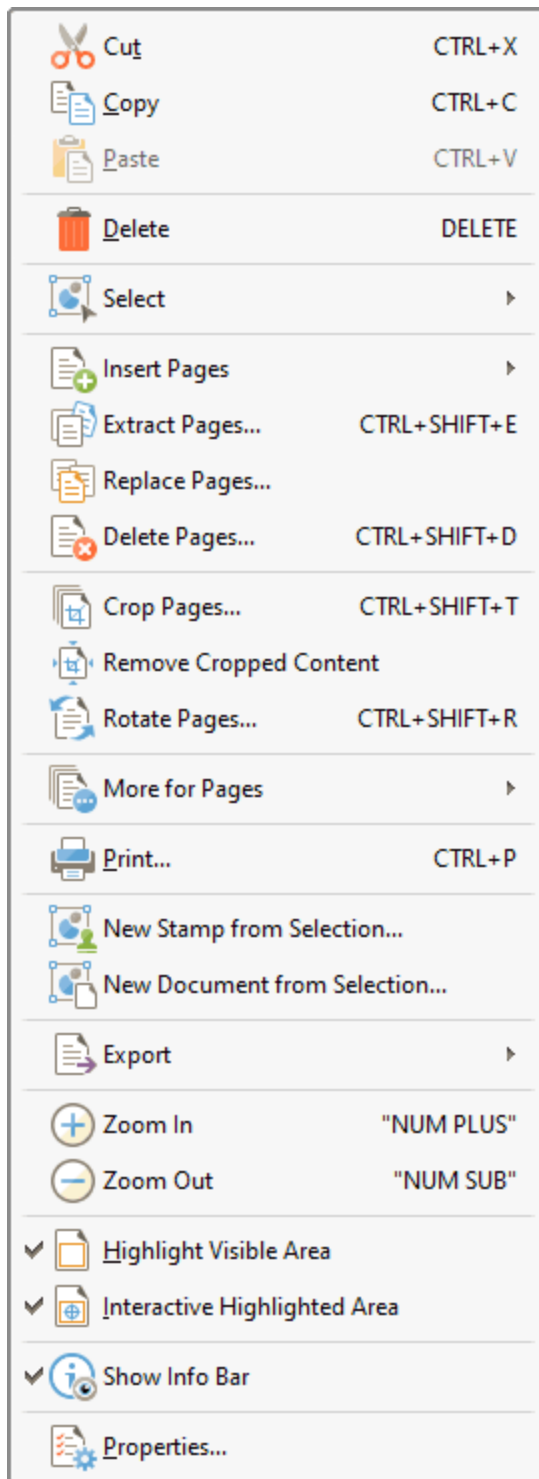



Figure 4. Thumbnails Options

- Click **Cut**, **Copy**, **Paste** or **Delete** to perform these actions on selected thumbnails.
- Click **Select** to select a subset of pages in the **Thumbnails** pane, then select the desired option in the shortcut menu:
  - Click **Select All** to select all pages.

- Click **Pages with Comments** to select all pages that contain comments.
- Click **Pages with Links** to select all pages that contain links.
- Click **Pages with Form Fields** to select all pages that contain form fields.
- Click **Pages with Bookmarks** to select all pages that contain bookmarks.
- Click **Pages with Text** to select all pages that contain text.
- Click **Pages with Images** to select all pages that contain images.
- Click **Pages with Path Items** to select all pages that contain path items.
- Click **Pages with Search Results** to select all pages that contain search results returned via the [Search](#)<sup>1776</sup> feature.
- Click **Pages with...** to select all pages that contain a combination of the options detailed in the **Select** dropdown menu. The **Select Pages With** dialog box will open. Select the boxes of the desired items and then click **OK** to select the corresponding pages.
- Click **Empty Pages** to select all empty pages.
- Click **Invert Selection** to invert the current selection of pages in the **Thumbnails** pane.
- Click **Insert Pages** to insert pages at the selected location in the **Thumbnails** pane, as detailed [here](#).<sup>1451</sup>
- Click **Extract Pages** to copy and save selected pages, as detailed [here](#).<sup>1462</sup>
- Click **Replace Pages** to replace selected pages, as detailed [here](#).<sup>1470</sup>
- Click **Delete Pages** to delete selected pages, as detailed [here](#).<sup>1459</sup>
- Click **Crop Pages** to crop selected pages, as detailed [here](#).<sup>1484</sup>
- Click **Remove Cropped Content** to remove cropped content from documents. This feature is intended for use in conjunction with the **Crop Pages** feature. Cropping pages reduces the visible page area, but cropped content remains available (and takes up memory) unless this option is also used.
- Click **Rotate Pages** to view the **Rotate Pages** options, which are explained [here](#).<sup>1482</sup>
- Click **More for Pages** to view/select further options for pages:
  - Click [Duplicate Pages](#)<sup>1465</sup> to duplicate pages.
  - Click [Resize Pages](#)<sup>1468</sup> to resize pages.
  - Click [Split Pages](#)<sup>1473</sup> to split pages.
  - Click [Merge Pages](#)<sup>1479</sup> to merge pages
  - Click [Swap Pages](#)<sup>1477</sup> to swap the location of two pages.
  - Click [Move Pages](#)<sup>1468</sup> to move the location of pages.
  - Click [Page Transitions](#)<sup>1072</sup> to change the manner in which documents browse between pages in fullscreen mode.
  - Click [Number Pages](#)<sup>1504</sup> to number document pages and create number ranges.
- Click **Print** to print documents, as detailed [here](#).<sup>833</sup>
- Click **New Stamp from Selection** to create a new stamp from selected thumbnails, as detailed [here](#).<sup>1192</sup>
- Click **New Document from Selection** to create a new document from selected thumbnails.
- Click **Export** to view export options:
  - Click **Export to Image(s)** to convert selected thumbnails into images. The **Export to Image(s)** dialog box will open. See [here](#)<sup>838</sup> for further information.

- Click **Export selection to Microsoft Word Document** to convert and save selected thumbnails in (**\*.docx**) format.
  - Click **Export selection to Microsoft Excel** to convert and save selected thumbnails in (**\*.xlsx**) format.
  - Click **Export selection to Microsoft Powerpoint Presentation** to convert and save selected thumbnails in (**\*.pptx**) format.
  - Click **Zoom In** to zoom in on the thumbnails pane.
  - Click **Zoom Out** to zoom out from the thumbnails pane.
  - **Highlight Visible Area** is selected by default. This means the area of the document currently visible in the main window is highlighted in the corresponding page of the **Thumbnails** pane. Disable this option to remove the highlight box.
  - **Interactive Highlighted Area** is selected by default. This means it is possible to click and drag the **Highlight Visible Area** detailed above to adjust the page view in the main window. Click and drag the  icon to adjust the page view.
  - Click **Show Info Bar** to show/hide the information bar at the bottom of the **Thumbnails** pane.
  - Click **Properties** to launch the **Properties** pane for selected pages. This pane is detailed beneath (**figure 3**) above.
-

10.4.3.1.3 Comments



Comments

Click **Comments** (or press Ctrl+M) to open the **Comments** pane:

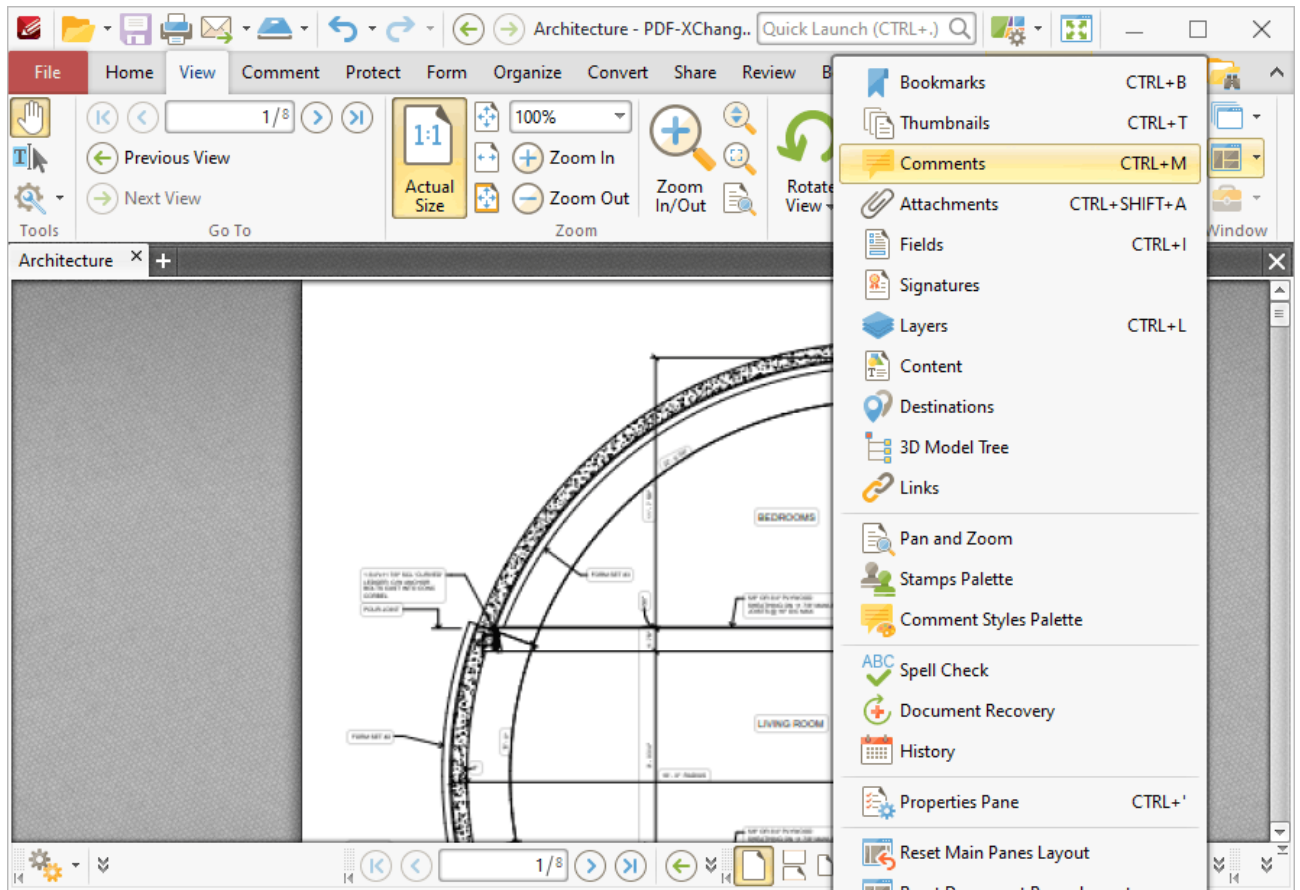

Figure 1. View Tab, Panes Dropdown Menu, Comments

The **Comments** pane displays a list of comments, annotations and markups in the current document:

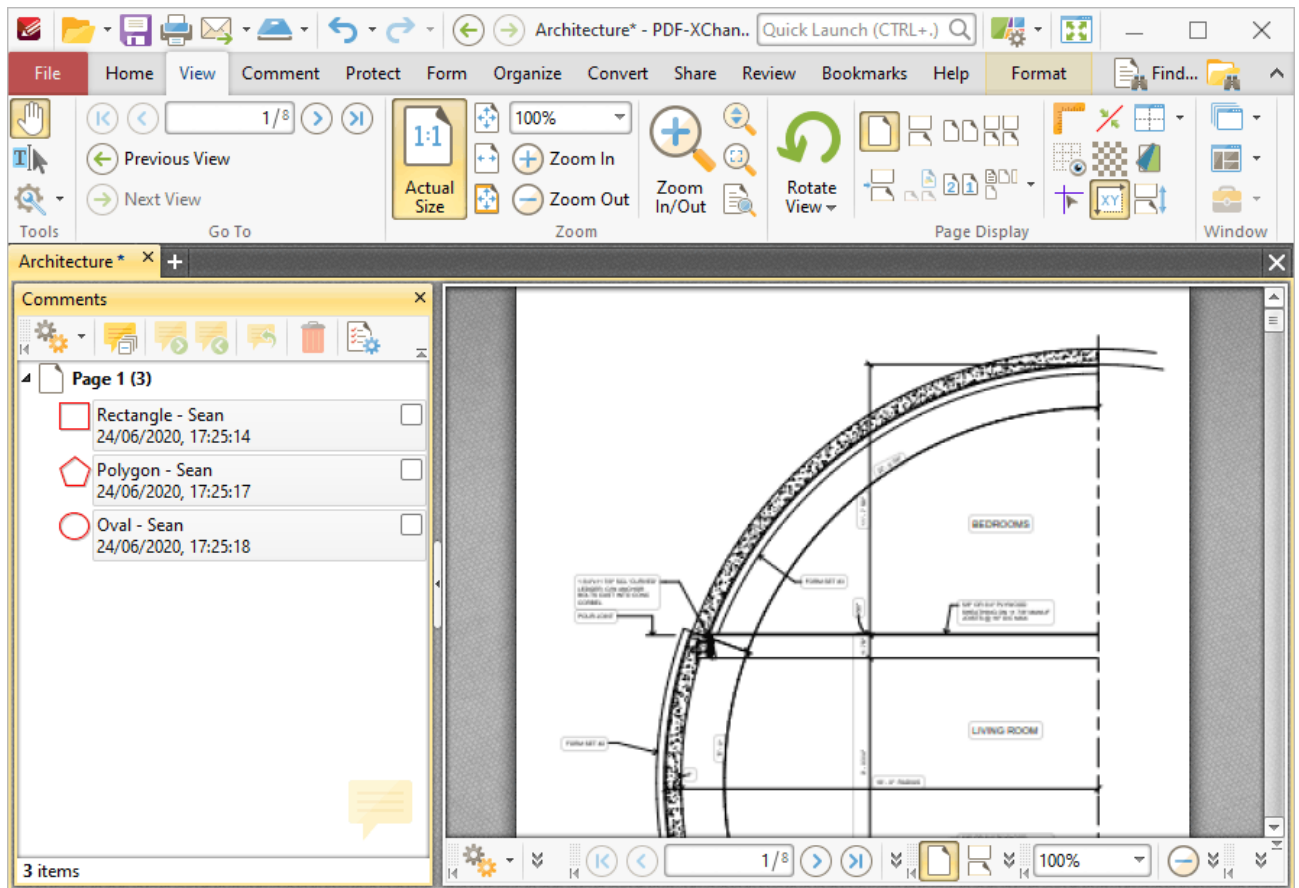







Figure 2. Comments Pane

Click items in the **Comments** pane to move to their location in the document. Note that each entry in the **Comments** pane features a check box. These check boxes are used to determine display options for comments, as detailed in the **Show Comments** section below. Use the icons in the **Comments** pane to perform the following operations:

- Click  **Next Comment** to move to the next comment.
- Click  **Previous Comment** to move to the previous comment.
- Click  **Add Reply** to add a reply to the selected comment. Replies appear in the pop-up note of annotations, and are useful for the editing process of documents.
- Click  **Summarize Comments** to create a summary of comments in the document, as detailed [here](#).
- Click  **Delete** to delete selected comments.
- Click  **Properties** to view/edit the properties of selected comments. The **Properties** pane will open:



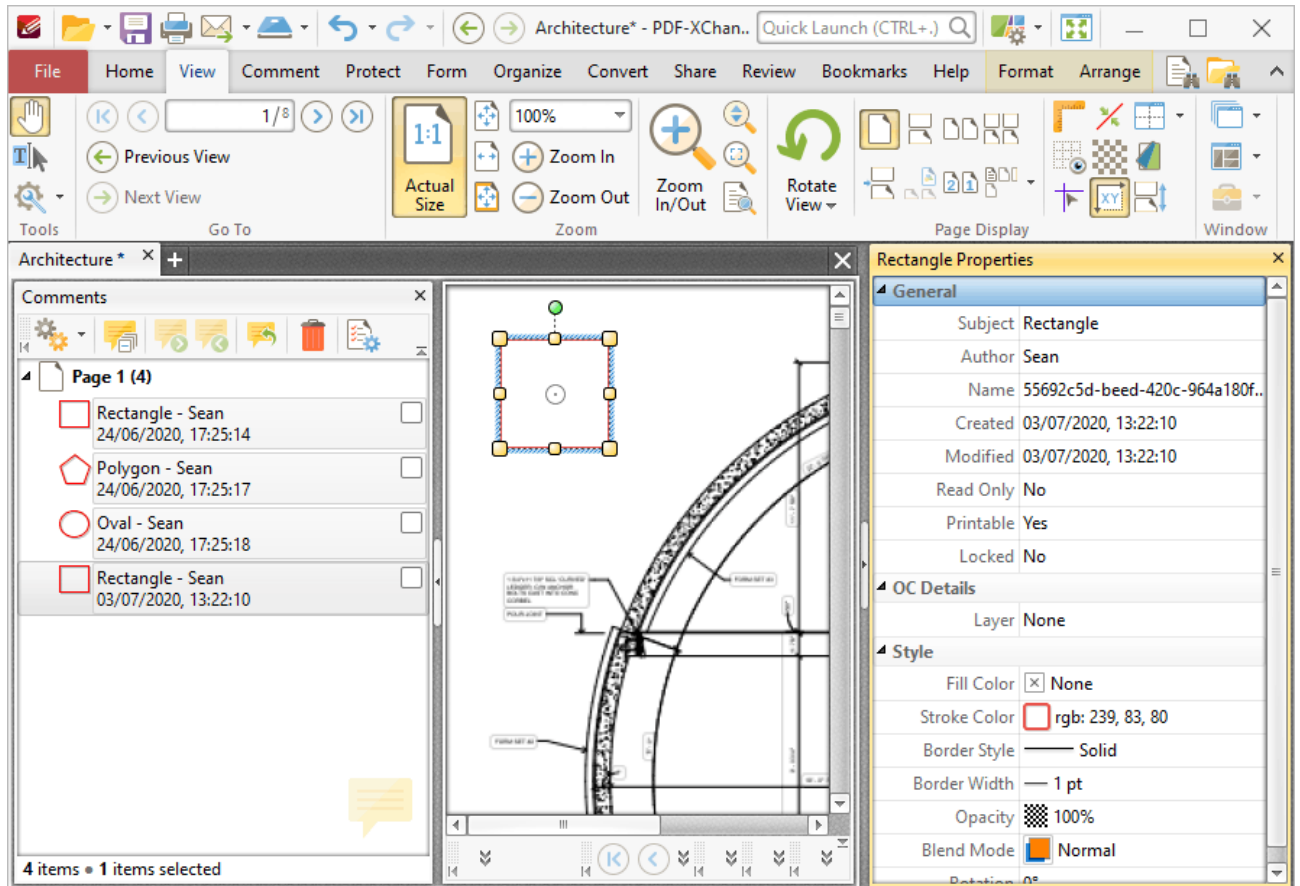

Figure 3. Properties Pane

Click to edit properties as desired. Please note that the properties available depend on the the type of annotation selected, and not all properties are editable. Comment properties are detailed [here](#).

Click  **Options** for comment options:

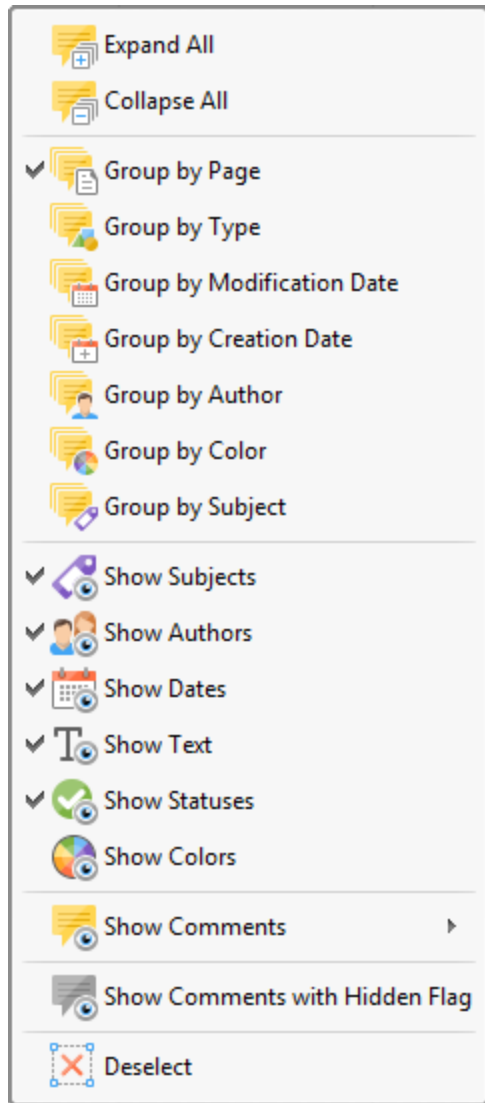

Figure 4. Comments Options

- Click **Expand All/Collapse All** to expand/collapse all comments.
- Click a **Group by** option to determine how comments are grouped.
- Use the **Show** options to determine the information displayed with comments in the **Comments** pane.
- Click **Show Comments with Hidden Flag** to display comments that feature hidden flags.
- Click **Deselect** to deselect selected comments.
- Hover over **Show Comments** to view additional display options:

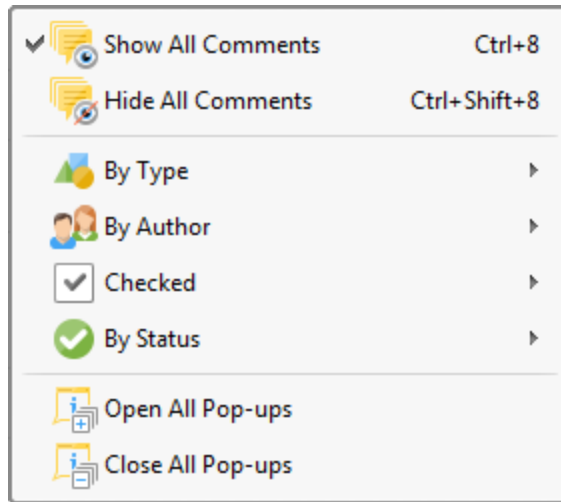

Figure 5. Show Comments Options

- Click **Show All Comments** to display all comments, in both the **Comments** pane and the active document.
- Click **Hide All Comments** to hide all comments, in both the **Comments** pane and the active document.
- Hover over **By Type**, **By Author**, **Checked** or **By Status** to determine the display status of comments according to their type, author, checked/unchecked value in the **Comments** pane, or status. A submenu will be displayed that details all available options for the selected method. Select an option from the list as desired.
- Click **Open/Close All Pop-ups** to open/close all comment pop-ups.

Additional options are available when comments are right-clicked:

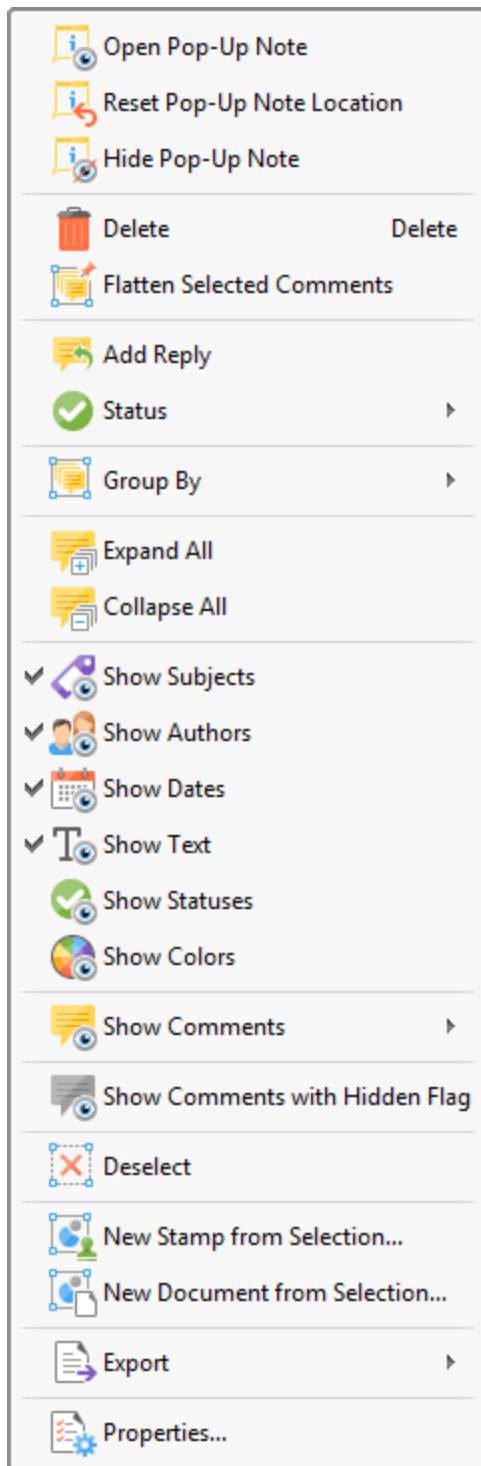



Figure 6. Comments Shortcut Menu

- Click **Open Pop-Up Note** to open the comment pop-up note.
- Click **Reset Pop-Up Note Location** to reset the location of the comment pop-up note.
- Click **Hide Pop-Up Note** to close the comment pop-up note.
- Click **Delete** to delete selected comments.
- Click **Flatten Selected Comments** to convert selected comments into document base-content.

- Click **Add Reply** to add a reply to select comments. A new **Sticky Note** annotation will be created for the reply.
  - Hover over **Status** to set a status for comments. Statuses are used to assist in the editing process. The status options are **Accepted, Cancelled, Completed** and **Rejected**.
  - Hover over **Group by** to set an option for how comments are grouped in the **Comments** pane. The grouping options are by **Page, Type, Modification Date, Creation Date, Author, Color** and **Subject**.
  - Click **Expand All/Collapse All** to expand/collapse all comments.
  - Use the **Show** options to determine the information displayed with comments in the **Comments** pane, as detailed above.
  - Click **Show Comments with Hidden Flag** to show comments that feature hidden flags.
  - Click **Deselect** to deselect selected comments.
  - Click **New Stamp from Selection** to create a new stamp from selected comments, as detailed [here](#).
  - Click **New Document from Selection** to create a new document from selected comments.
  - Hover over **Export** to view export options for comments. Click **Export to Images, Export Selection to Microsoft Word Document** or **Export Selection to Microsoft Powerpoint Presentation** as desired.
  - Click **Properties** to view/edit the properties of selected annotations, as detailed above.
-

10.4.3.1.4 Attachments



**Attachments**

Click **Attachments** (or press Ctrl+Shift+A) to open the **Attachments** pane:

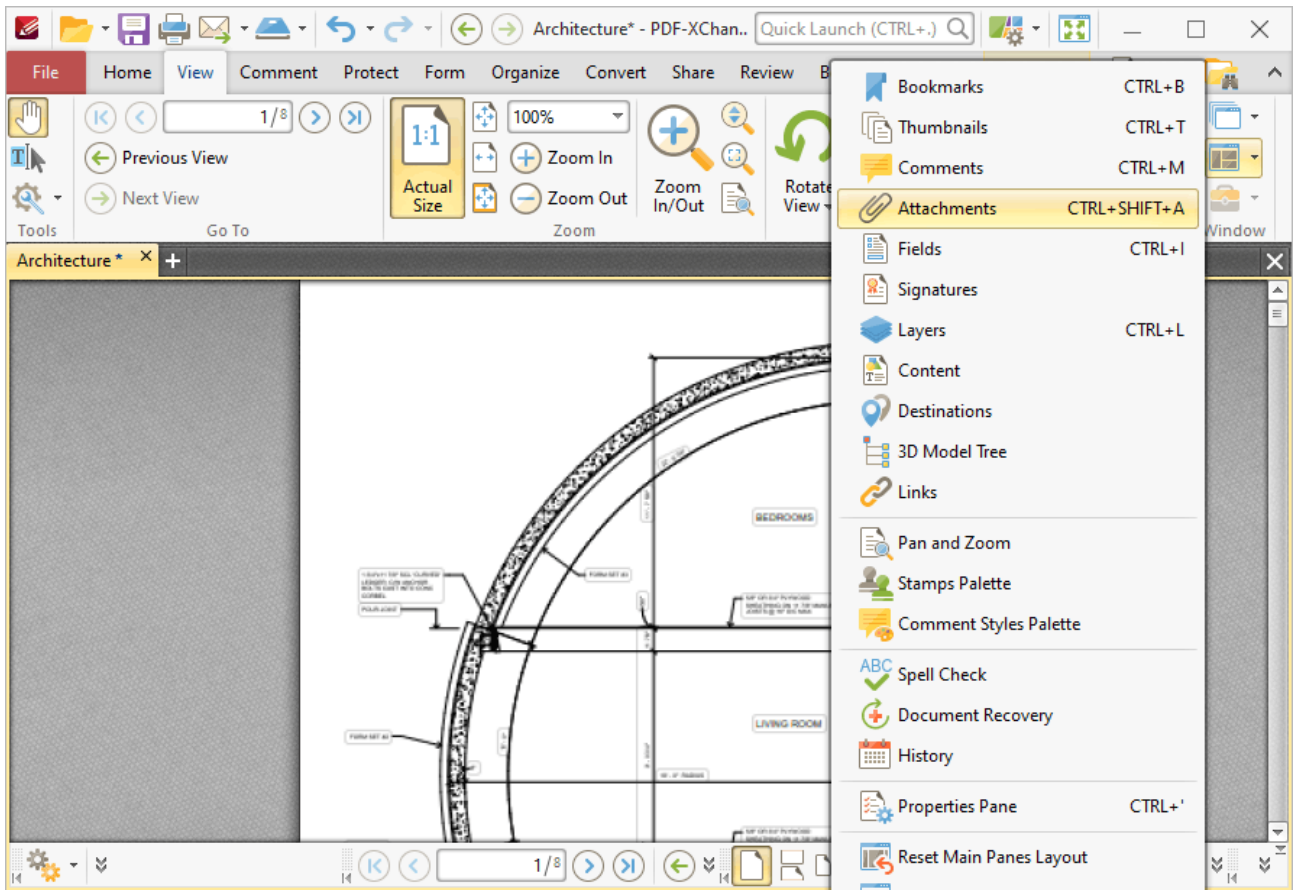

Figure 1. View Tab, Panels Dropdown Menu, Attachments

The **Attachments** pane details attachments to the current document:

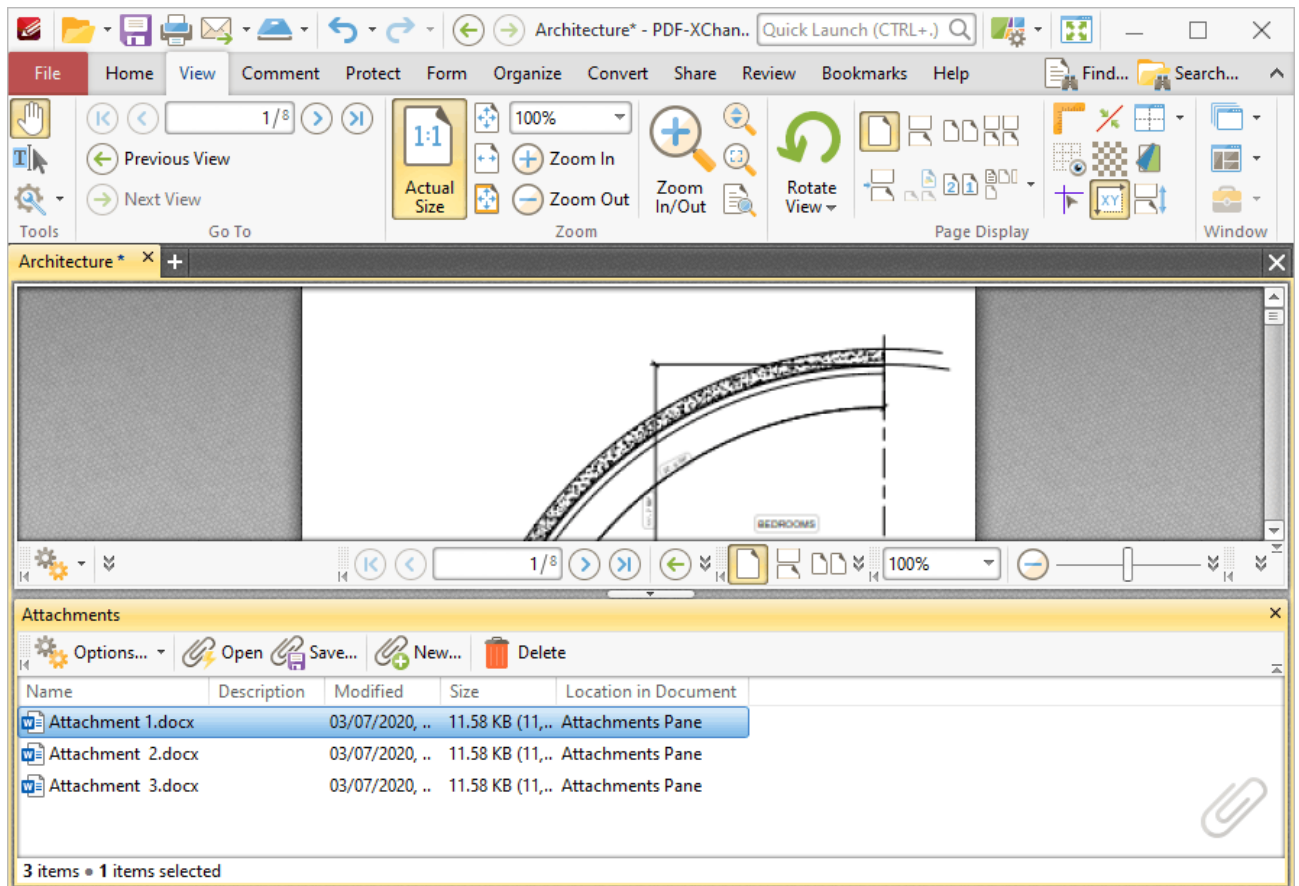
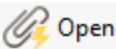
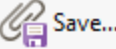



Figure 2. Attachments Pane

Double-click to open attachments. Use the icons in the **Attachments** pane to perform the following operations:

- Click  **Open** to open attachments in their default applications.
- Click  **Save...** to save selected attachments.
- Click  **New...** to add new attachments to documents. The **Open Files** dialog box will open. Select the desired files and click **Open** to add them as attachments. Alternatively, click and drag documents into the **Attachments** pane.
- Click  **Delete** to delete selected attachments.

If you have copied content to the clipboard, then it can be used to create a new attachment. Right-click in the **Attachments** pane, then click the special paste options **Paste as plain text**, **Paste as Rich Text** or **Paste as Image** as desired. Note that the available paste options depend on the format of the content in the clipboard.

## 10.4.3.1.5 Fields



### Fields

Click **Fields** (or press Ctrl+I) to open the **Fields** pane:

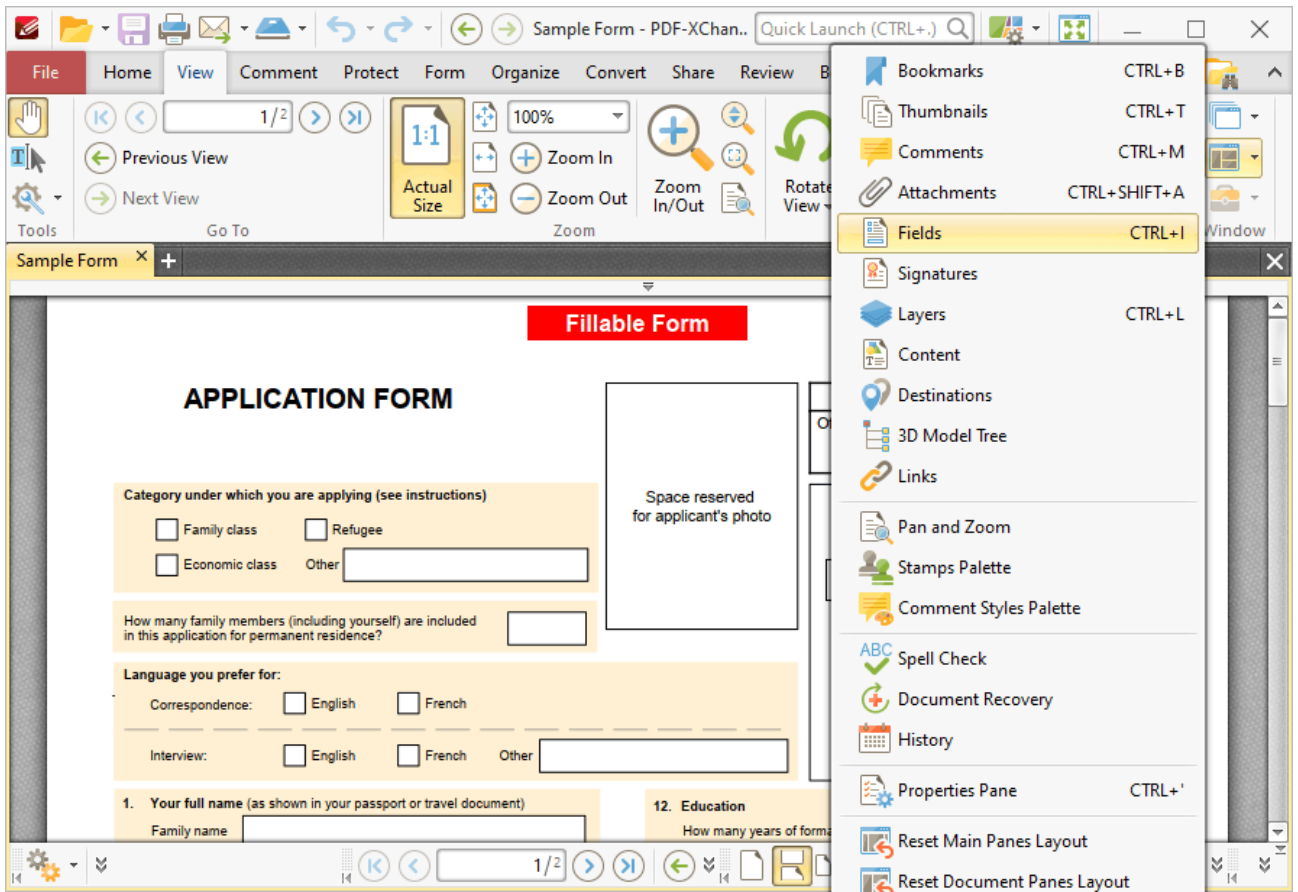

Figure 1. View Tab, Panes Dropdown Menu, Fields

The **Fields** pane details form fields in the current document:



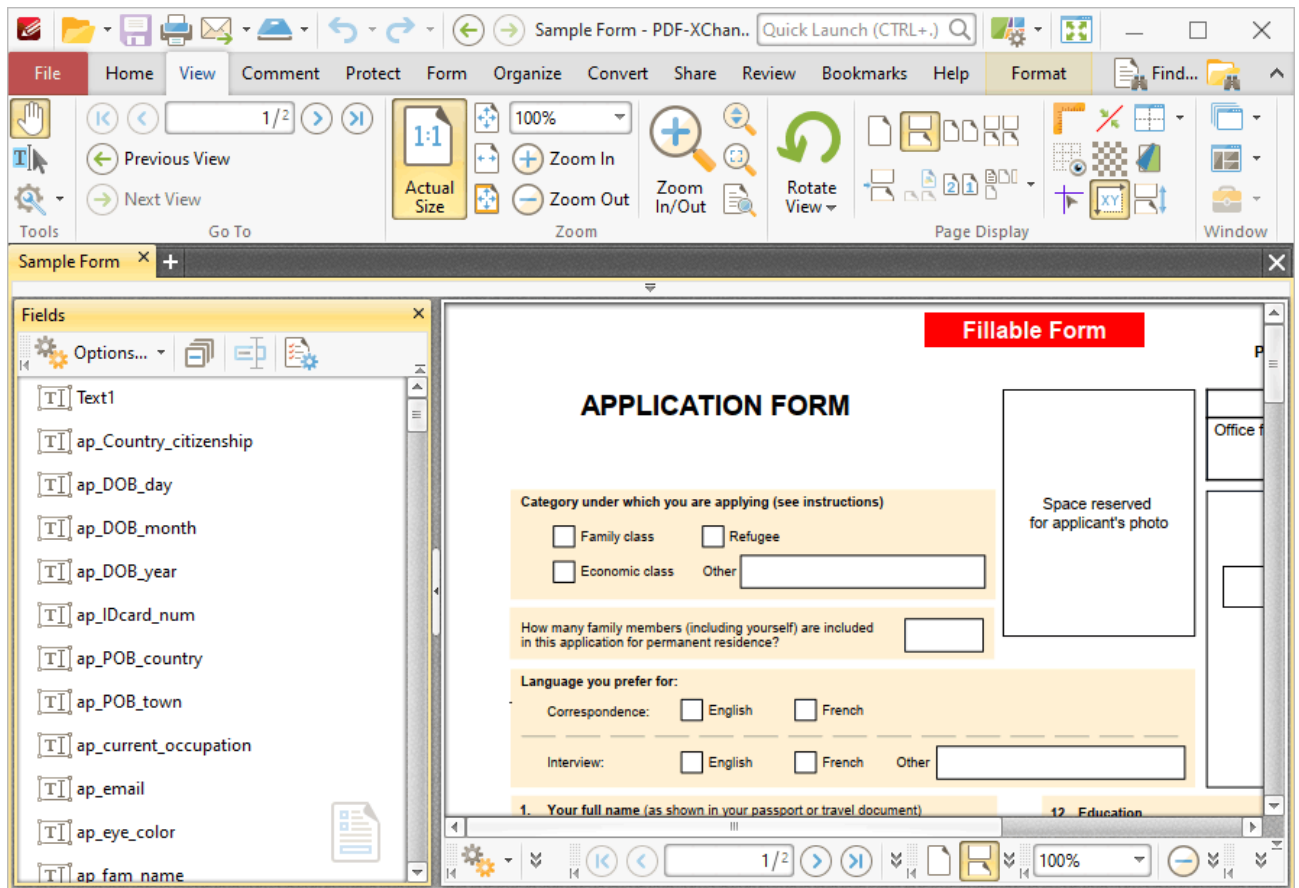





Figure 2. Fields Pane

Click **Select Fields** in the form tab, as detailed in *(figure 2)*, then click fields in the **Fields** pane to select them in the document. Use the icons in the **Fields** pane to perform the following operations:

- Click  **Rename** to rename selected fields.
- Click  **Properties** to view/edit properties of selected fields. The **Properties** pane will open. This pane details the status of properties for selected form fields. The properties detailed depend on the format of selected fields. Further information on form fields and their properties is available [here](#).
- Click  **Options** for fields options:

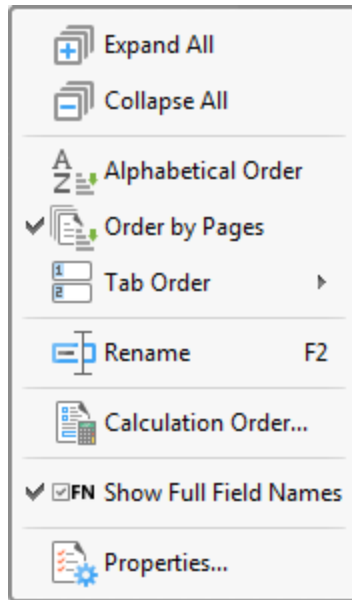

Figure 3. Forms Options

- Click **Expand All/Collapse All** to expand/collapse all fields.
- Select either **Alphabetical Order** or **Order by Pages** as desired.
- Select an options from the **Tab Order** submenu to determine the order in which fields are tabbed through with when the Tab key is used.
- Click **Rename** to rename selected fields.
- Click **Calculation Order** to determine the order of calculation when more than one form field in the document contains value calculation properties. See [here](#)<sup>1284</sup> for further information.
- Click **Properties** to view/edit form properties. Note that the **Select Fields** feature must be enabled to view form properties, as detailed in **(figure 2)**. Form properties are detailed [here](#).<sup>1285</sup>
- Click **Show Full Fields Name** to show/hide the full names of child fields in cases where fields are grouped according to name. The shared section of names is displayed when this option is enabled and hidden when it is disabled, as detailed below:

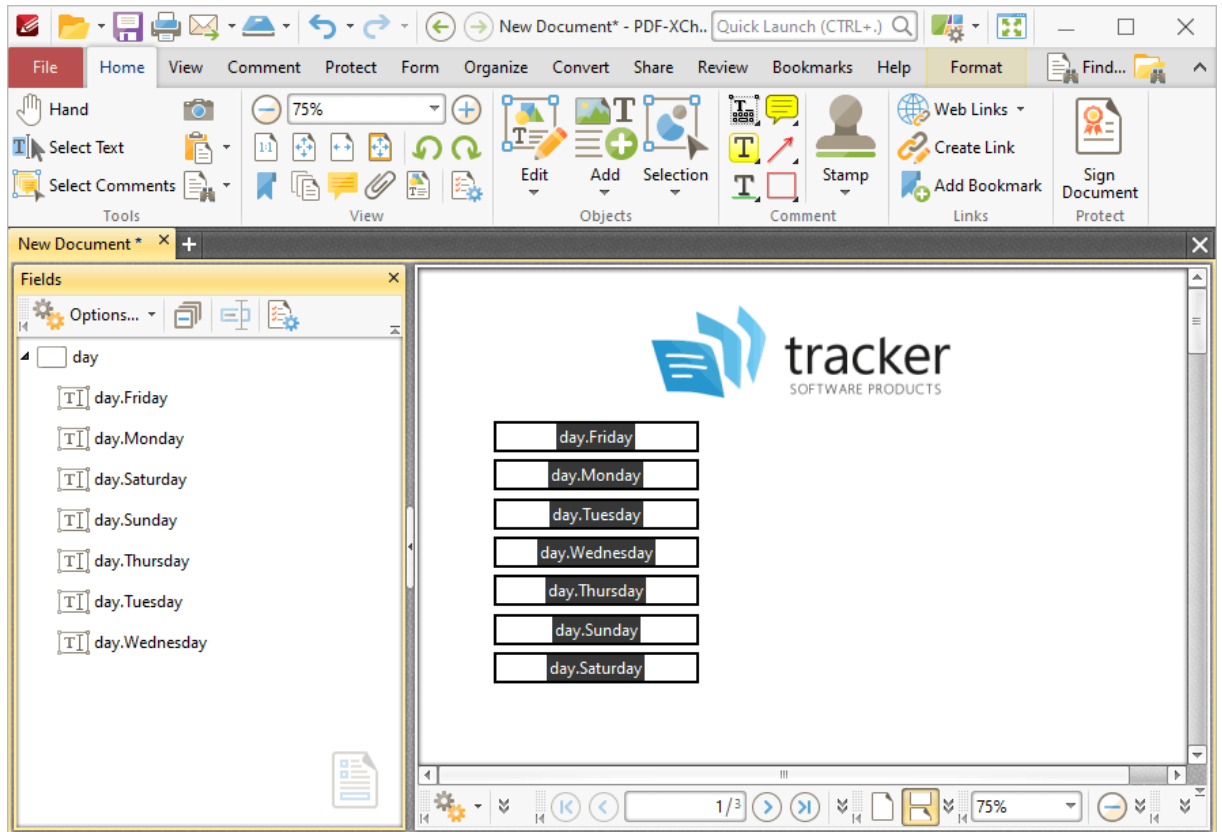
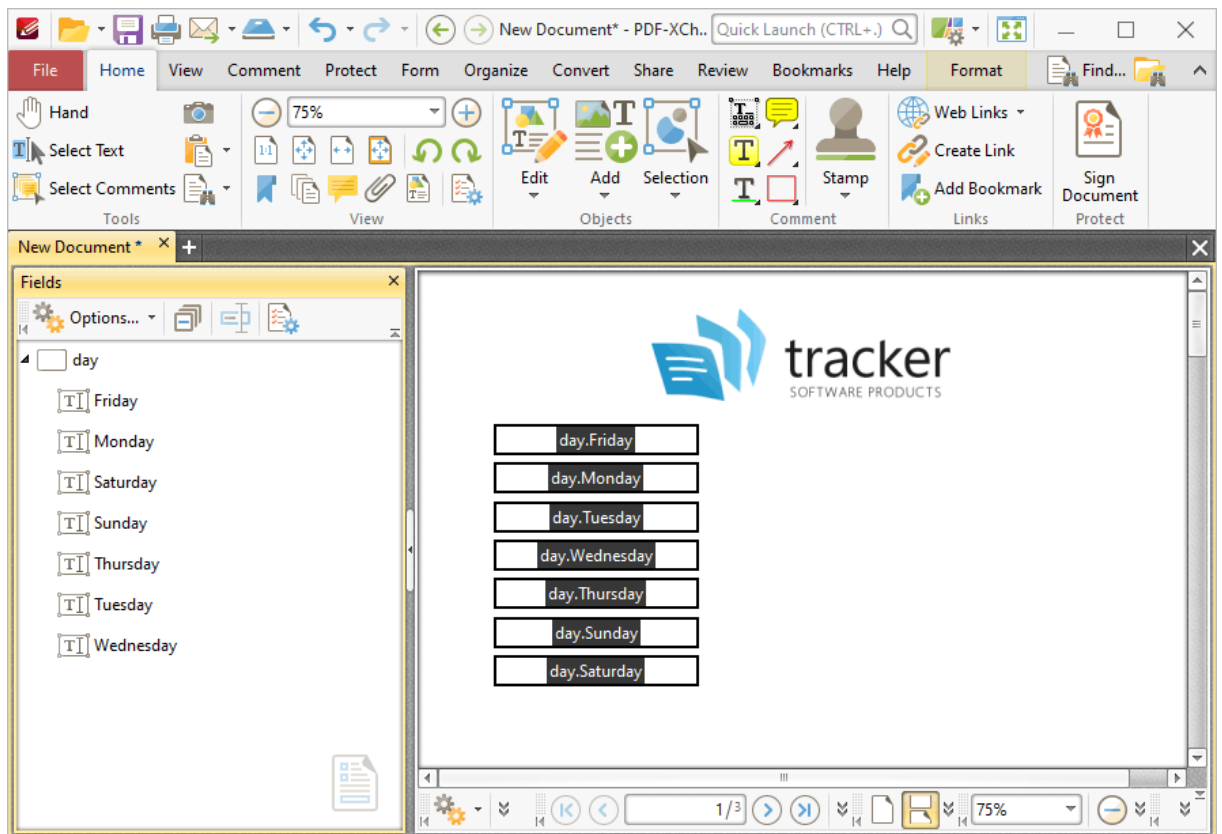



Figure 4. Fields Pane, Show Full Fields Name Enabled



**Figure 5.** Fields Pane, Show Full Fields Name Disabled

Additional editing options for forms are detailed [here](#). 

---

## 10.4.3.1.6 Signatures



### Signatures

Click **Signatures** to open the **Signatures** pane:

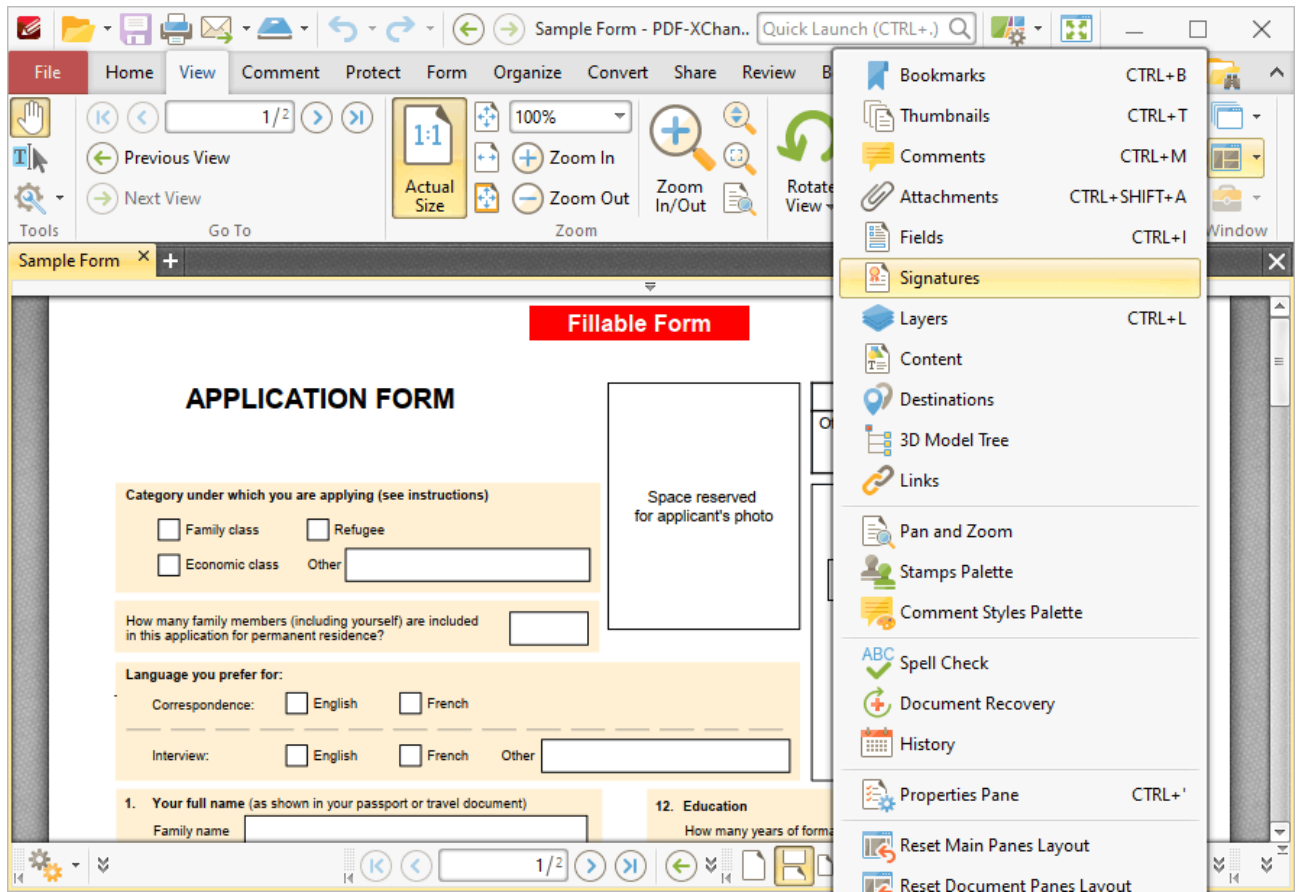

Figure 1. View Tab, Panes Dropdown Menu, Signatures

The **Signatures** pane displays information about digital signatures in the current document:

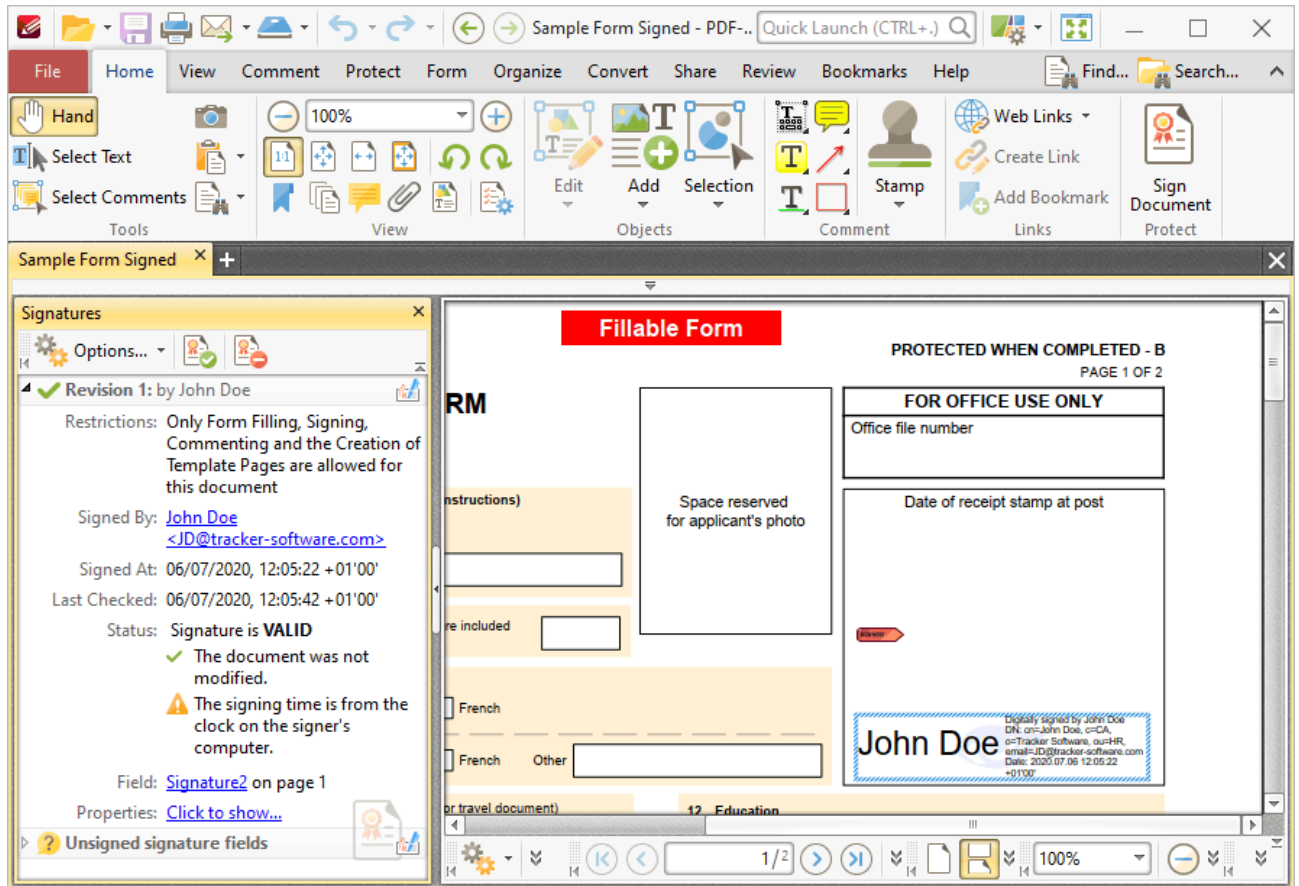



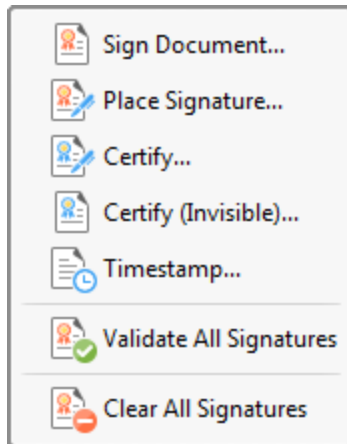

Figure 2. Signatures Pane

Digital signatures are used to demonstrate the authenticity of documents and increase their security. They can also be used to determine editing permissions for documents and/or utilize timestamp servers in order to further increase document security and integrity. The **Signatures** pane displays details about digital signatures in the current document, such as the restrictions that the signature imposes, the name of the person who added the digital signature, the time at which the document was signed and whether or not the signature conforms to the EU 910/2014 standard. Information and instructions about adding/editing digital signatures is available [here](#).<sup>1248</sup> Use the icons in the **Signatures** pane to perform the following operations:

- Click  to validate all document signatures.
- Click  to clear all digital signature fields in the document.
- Click  for signature options:



**Figure 3.** Signatures Options Submenu

These options are detailed [here](#).<sup>1248</sup>

---

## 10.4.3.1.7 Layers

**Layers**

Click **Layers** (or press Ctrl+L) to open the **Layers** pane:

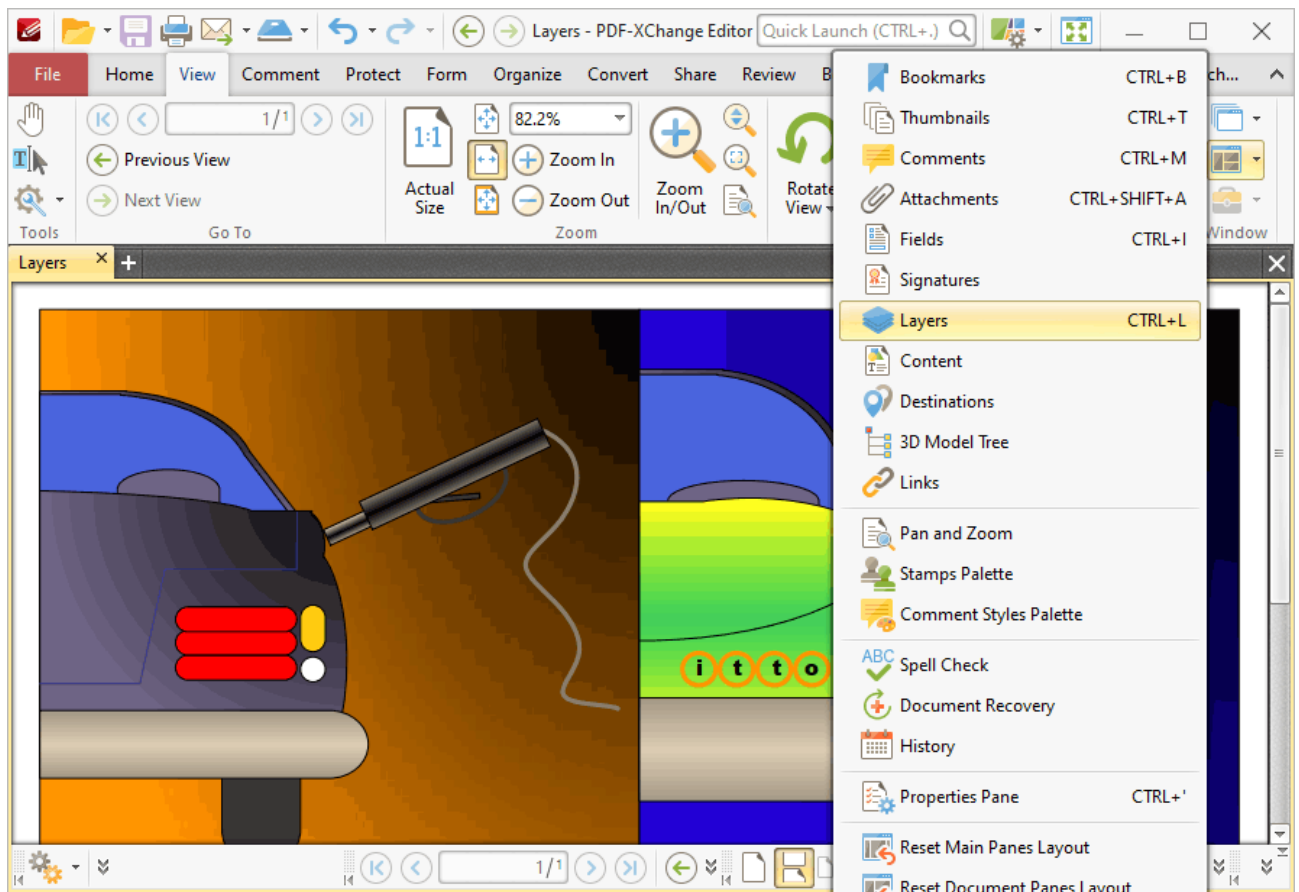

**Figure 1.** View Tab, Panes Dropdown Menu, Layers

The **Layers** pane displays information about document layers:



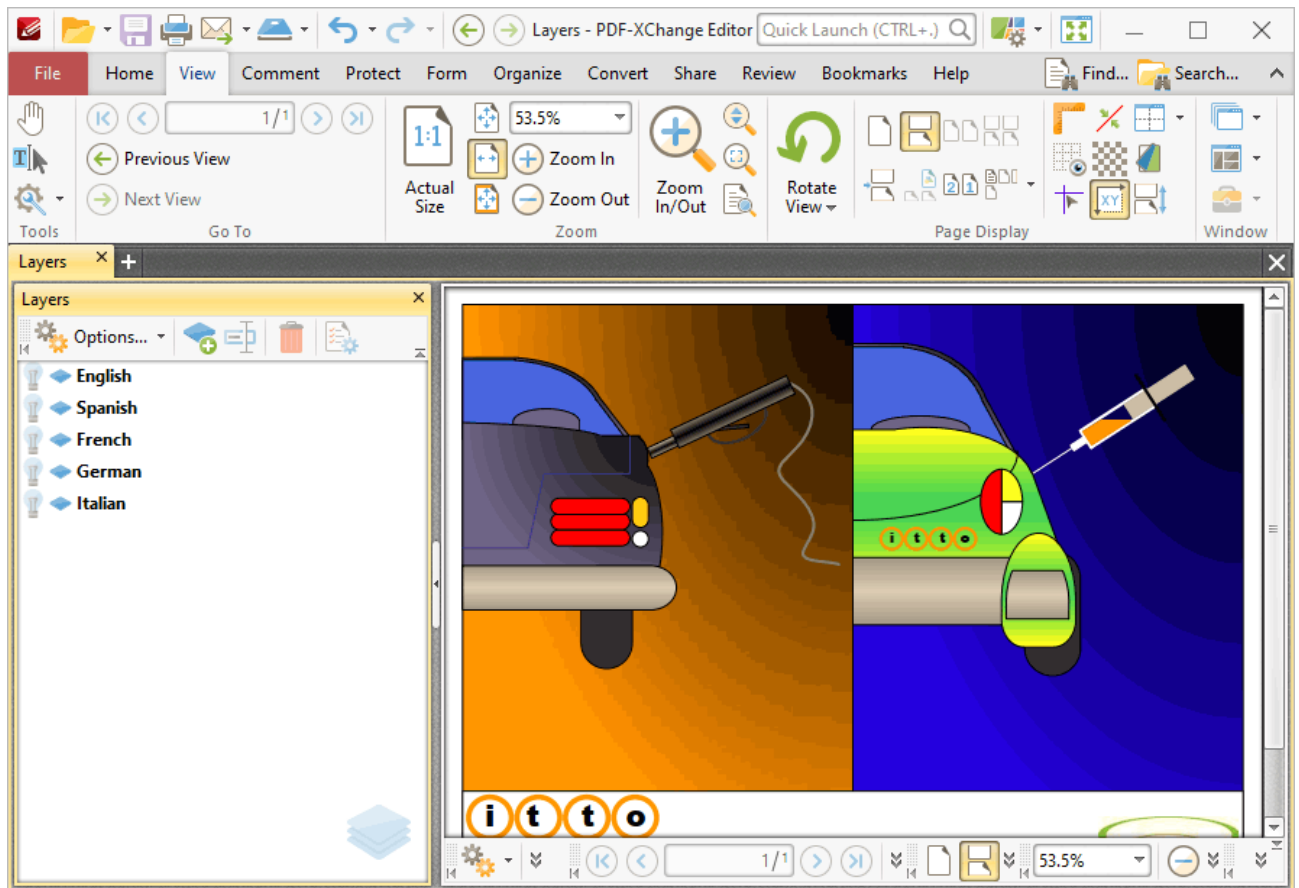

**Figure 2.** Layers Pane

Layers contain page content that can be displayed/hidden as desired. They are a useful feature in cases where documents need to feature a varying appearance depending on the intended audience. For example it is possible to create text-based layers that each feature a different language and fit over image-based content. The desired layer can then be enabled in order to match the language of the target audience:

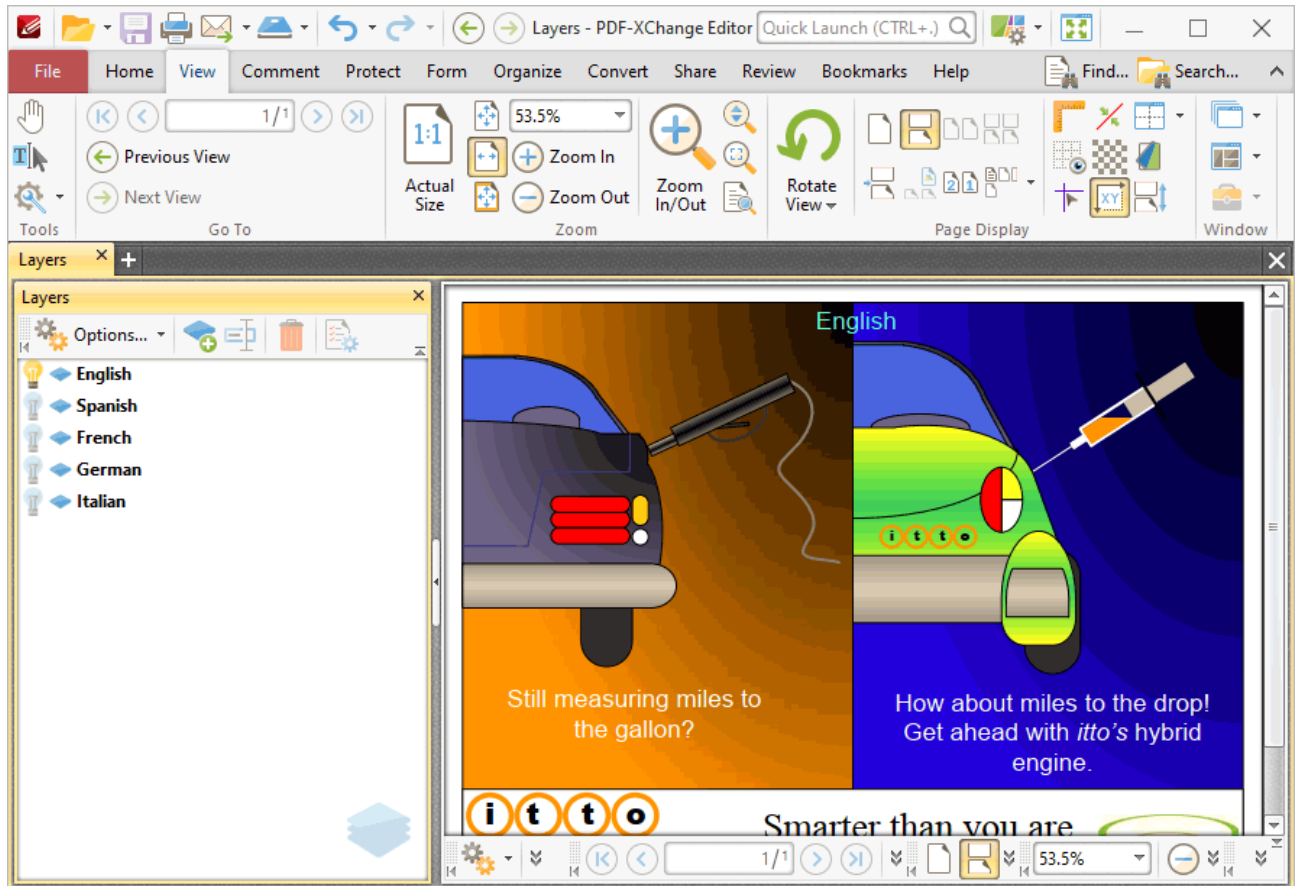

Figure 3. Sample Layers Document, English Layer Enabled

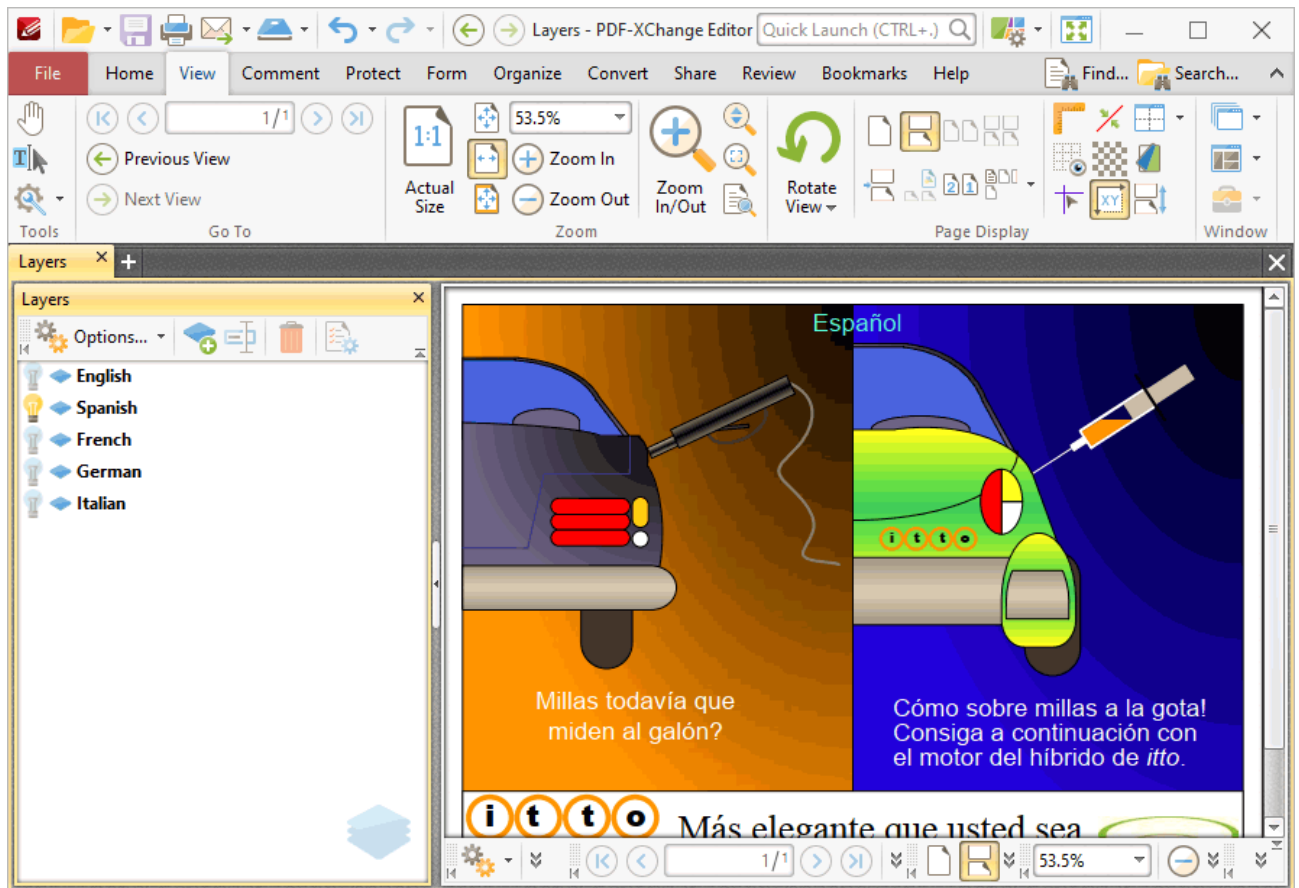







Figure 4. Sample Layers Document, Spanish Layer Enabled

Use the icons in the **Layers** pane to perform the following operations:

- Click  **Options** to view options for layers, as detailed below.
- Click  **Add New Layer** to add a new layer to the current document, as detailed below.
- Click  **Rename** to rename selected layers.
- Click  **Delete** to delete selected layers.
- Click  to show/hide layers.
- Click  **Properties** to view/edit the properties of selected layers. The **Layer Properties** pane will open:

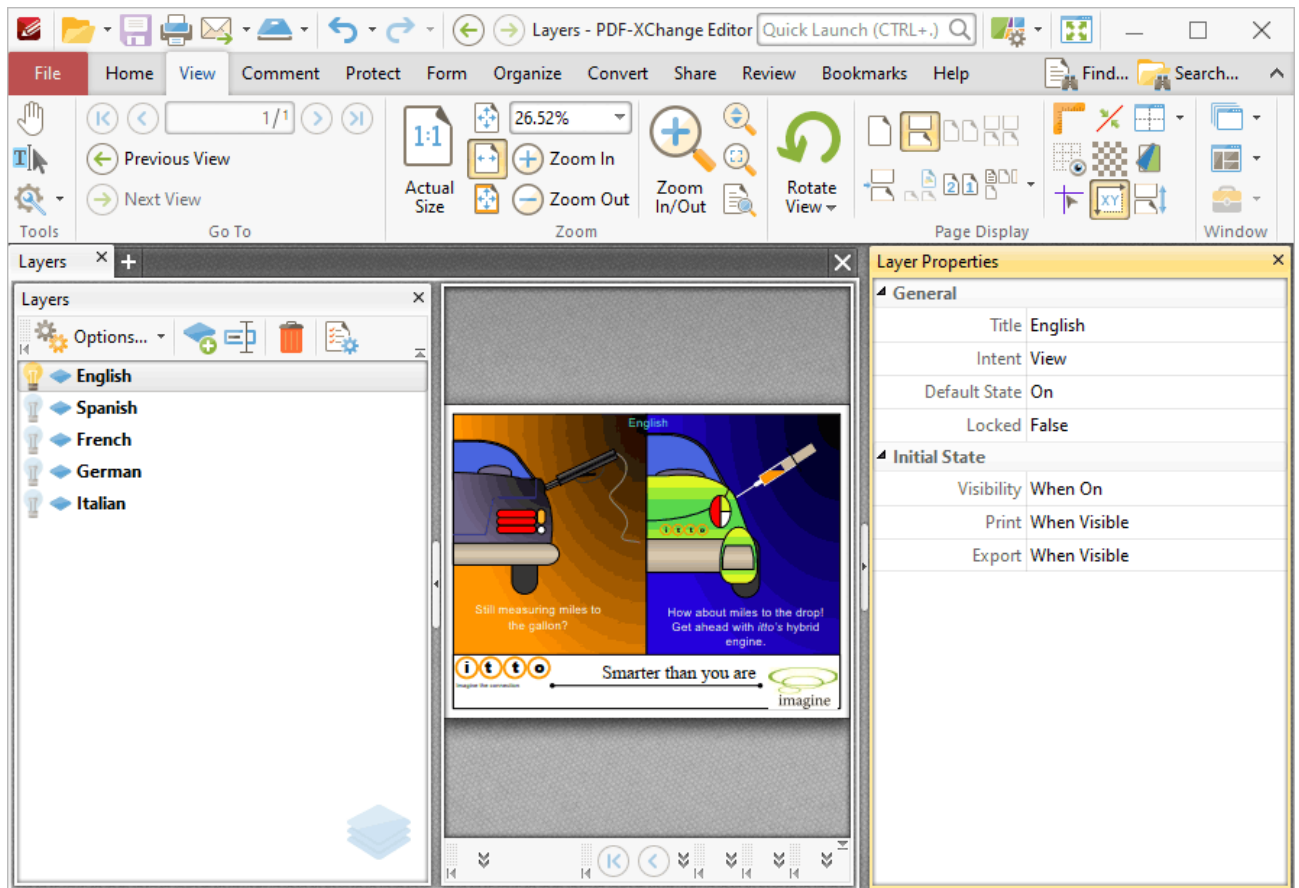

Figure 5. Sample Layers Document. Layer Properties Pane

- The **Title** property displays the title of layers as they appear in the **Layers** pane.
- The **Intent** property displays the intended use for layers:
  - **None** means there is no specified intent.
  - **View** means that the layer is intended for use as a viewing aid.
  - **Design** means the layer is intended for use in understanding the design of the document.
  - **Design and View** means both **Design** and **View**.
  - Please note that PDF applications may use the **Intent** property to determine whether or not layers are displayed.
- The **Default State** property displays the default state of layers when the document that contains them is opened.
- The **Locked** property displays the editable status of layers.
- The **Visibility** property displays the visibility status of layers.
- The **Print** property displays the printing status of layers.
- The **Export** property displays the export status of layers. This property determines whether or not layers appear in resulting documents when the file is exported to an application/file format that supports layers.

Click  **Options** for layers options:

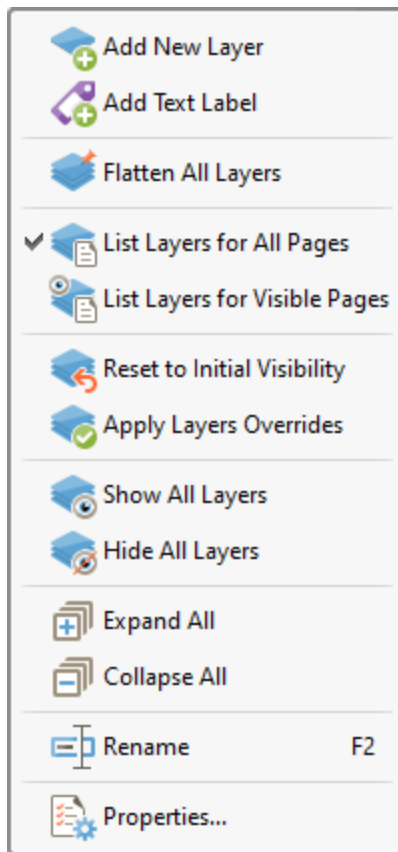

Figure 6. Layers Options

- Click **Add New Layer** to add a new layer to the current document. The **Add New Layer** dialog box will open, as detailed below.
- Click **Add Text Label** to add a text label to selected layers.
- Click **Flatten All Layers** to convert all layers into base content. Layers converted in this manner can then be edited using the [Edit Content Tool](#).<sup>1638</sup>
- Click **List Layers for All Pages** to display layers on every page of the document.
- Click **List Layers for Visible Pages** to display layers on the pages currently visible in the document.
- Click **Reset to Initial Visibility** to revert all layers to their default state.
- Click **Apply Layers Overrides** to display all layers. This option includes layers not listed in the layers pane.
- Click **Show All Layers/Hide All Layers** to show/hide all layers in the document.
- Click **Expand All** to expand all layers in the **Layers** pane.
- Click **Collapse All** to collapse all layers in the **Layers** pane.
- Click **Rename** to rename selected layers.
- Click **Properties** to view/edit the properties of the selected layer, as detailed above.

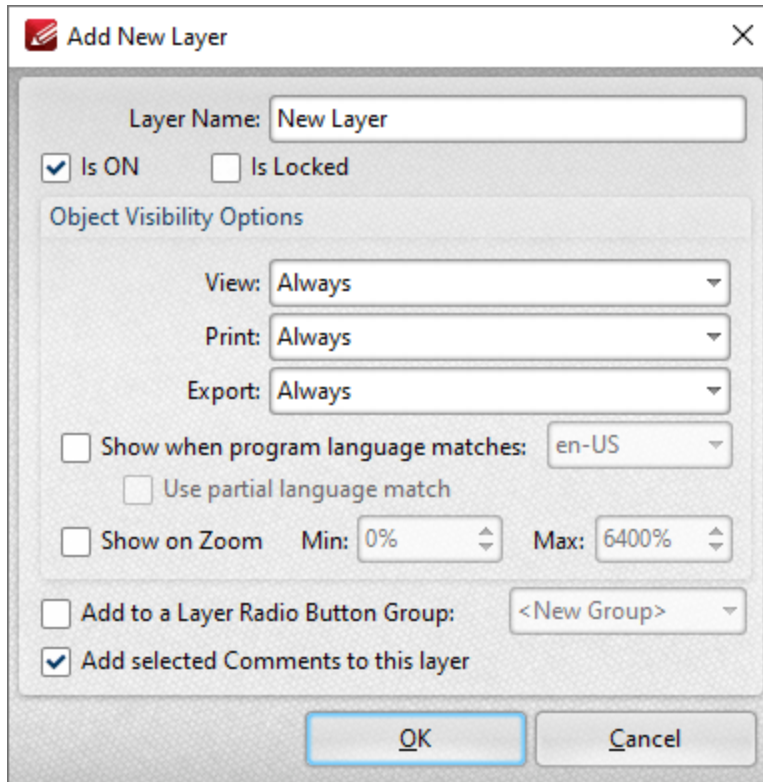

Figure 7. Add New Layer Dialog Box

- Enter the name of the new layer in the **Layer Name** text box.
- Select/clear the **is ON** box to set the default state of the layer to on/off.
- Select the **Add to Layers Pane** box to add the new layer to the **Layers** pane.
- Select/clear the **Is Locked** box to disable/enable subsequent users from changing the state of the layer.
- Use the **Object Visibility Options** dropdown menus to determine the visibility of the layer when the documents that contains it is viewed/printed/exported.
- Select the **Show when system language matches** box to show the layer when the application language matches a given language, then select the desired language in the adjacent dropdown menu.
- Select the **Use partial language match** to display the layer when there is a partial language match with the language specified. A partial language match occurs when the region of the language is the same as in the language specified but the locale is different. For example, if **US English** is specified in the **Show when system language matches** dropdown menu and the **Use partial language match** box is selected, then the layer will be displayed when the application language is identified as **US English, United Kingdom English, South African English** and all other derivatives of English listed in the dropdown menu.
- Select the **Show on Zoom** box to display the layer when the zoom function is used. Use the adjacent number boxes to specify the minimum and maximum levels of zoom at which the layer is displayed.

- Select the **Add to a Layer Radio Button Group** to add the layer to a **Layer Radio Button Group**. Layers contained in a radio button group are mutually exclusive - if one layer is enabled then the rest are disabled.
- Select the **Add selected Comments to this layer** box to add selected comments to the layer.

Click **OK** to save changes.

Please note that it is necessary to save, close and reopen documents in order for some of the settings detailed above to be displayed.

---

10.4.3.1.8 Content



**Content**

Click **Content** to open the **Content** pane:

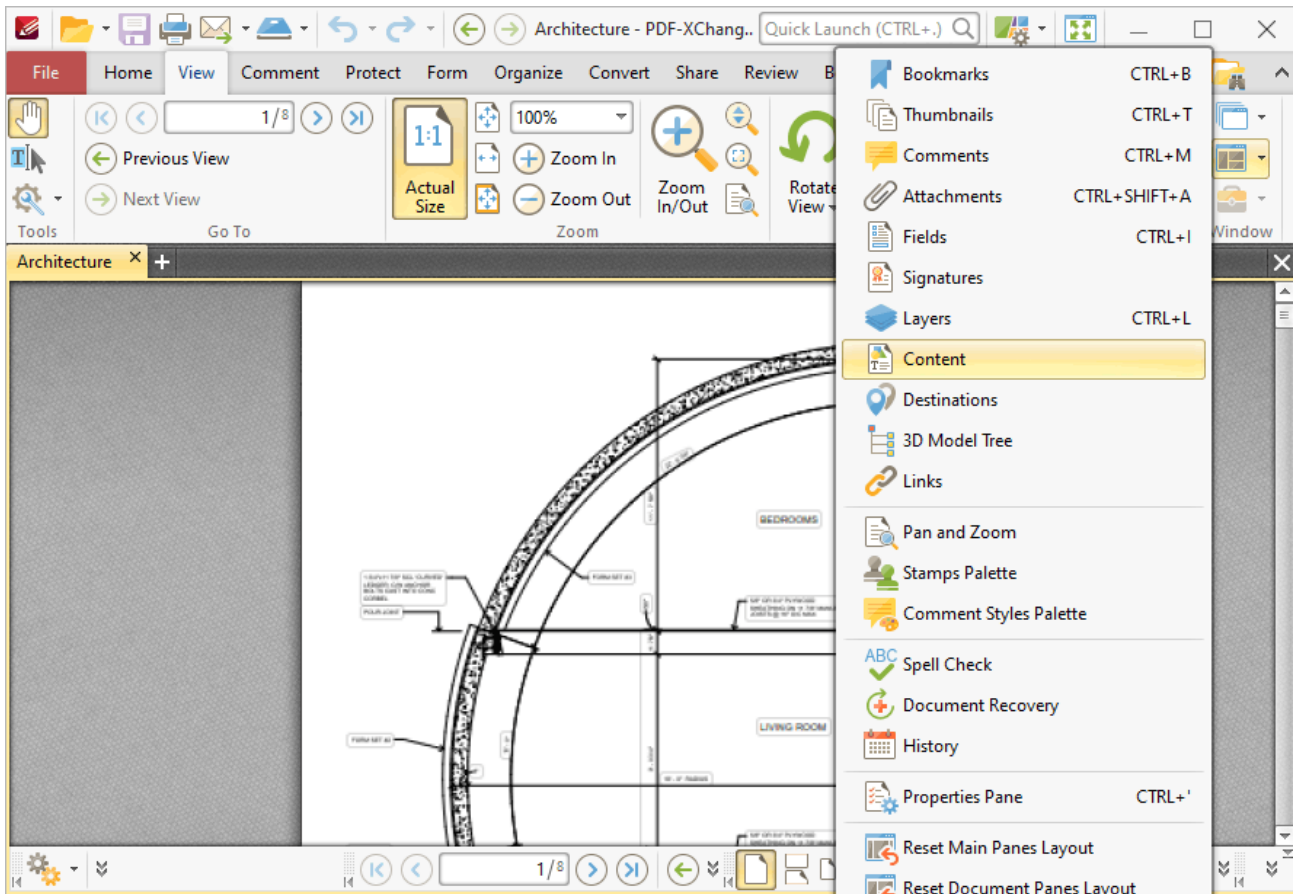

Figure 1. View Tab, Panes Dropdown Menu, Content

The **Content** pane displays a list of the document pages and the content that they contain:



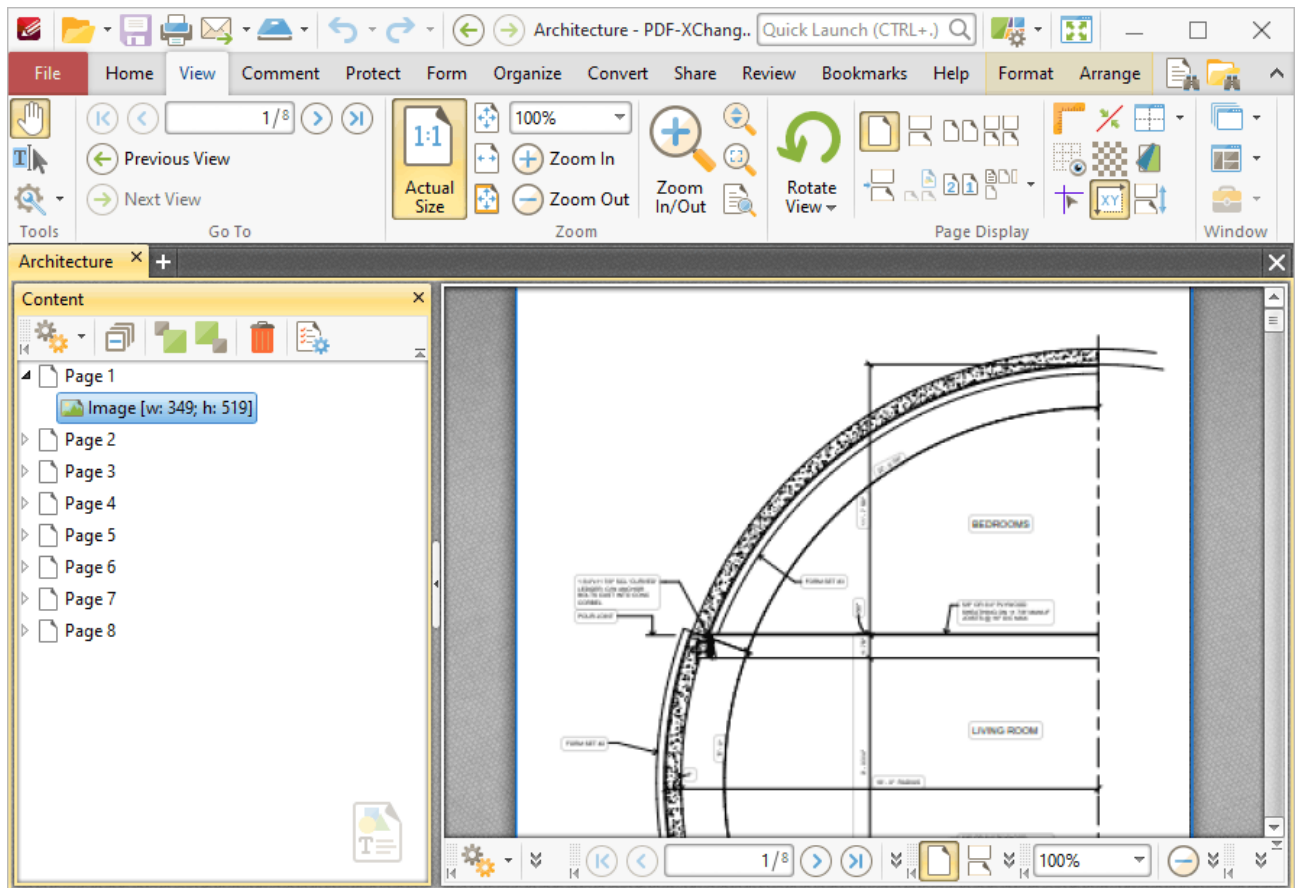









Figure 2. Content Pane

Click items in the **Content** pane to select them in the document. They can then be edited as detailed [here](#). Use the icons in the **Content** pane to perform the following operations:

- Click  **Cut** to cut selected content from the document.
- Click  **Copy** to copy selected content to the clipboard.
- Click  **Delete** to delete selected content.
- Click  **Bring Forward** to bring selected content forward in cases where multiple content items overlap.
- Click  **Send Backward** to send selected content backward in cases where multiple content items overlap.
- Click  **Expand** to select and expand content items in the **Content** pane when they are selected in the document.
- Click  **Properties** to view/edit the properties of selected content. The **Page Content Properties** pane will open. This pane details the status of properties for selected content:

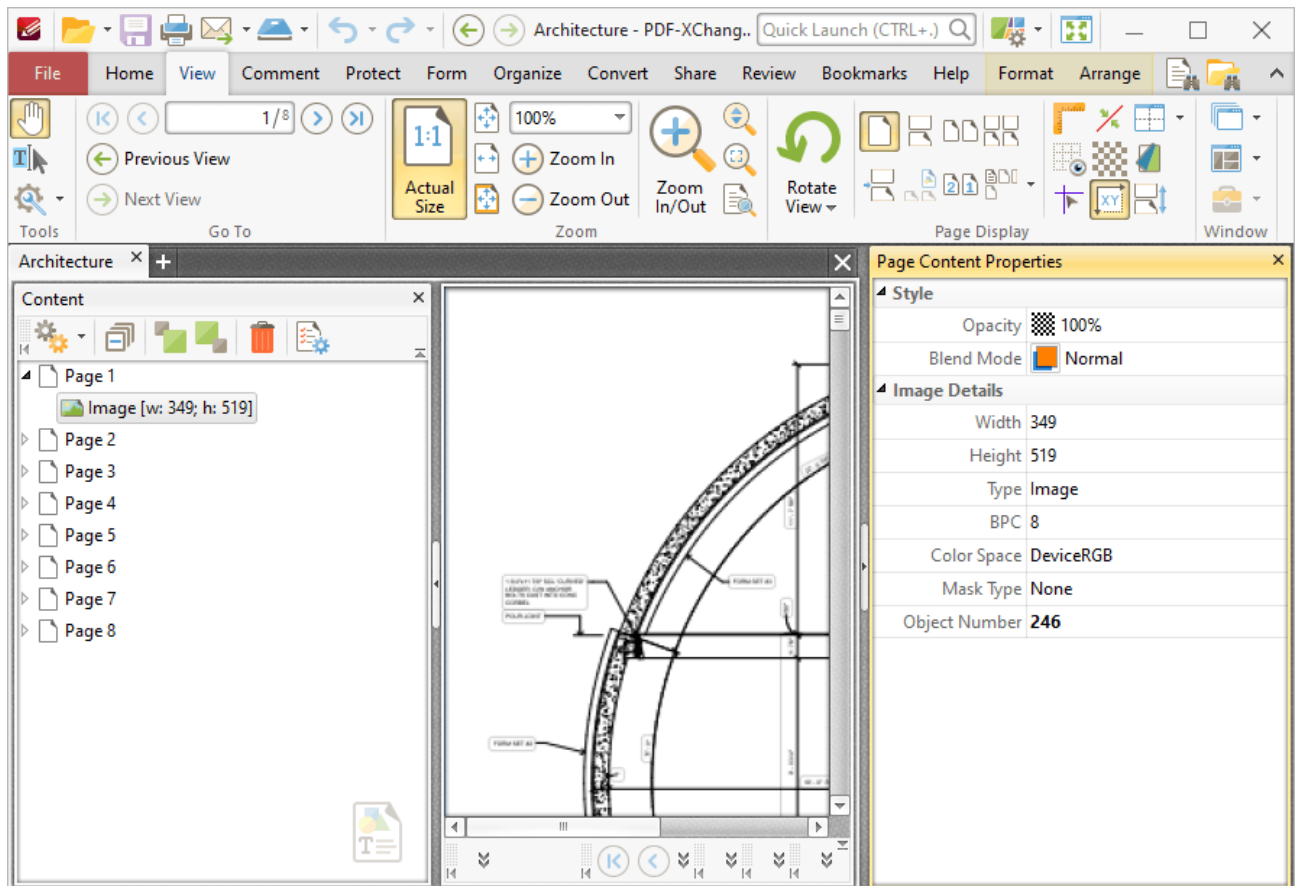

Figure 3. Page Content Properties Pane

Click to edit properties as desired. Please note that not all properties are editable. The following properties are available for content items:

- **Fill Color** displays the fill color.
- **Opacity** displays the level of transparency.
- **Stroke Color** displays the border color.
- **Stroke Opacity** displays the border transparency level.
- **Border Width** displays the border width.
- **Blend Mode** displays the blend mode when items overlap. Further information on blend modes is available [here](#).
- **Width** displays the width of images.
- **Height** displays the height of images.
- **Type** displays the format of images.
- **BPC** displays the color depth.
- **Color Space** displays the color model.
- **Mask Type** displays the mask type.
- **Object Number** displays the object number of selected content items.
- **Font** displays the font.
- **Font Size** displays font size.

- **Bold** displays the bold status.
- **Italic** displays the italic status.

Click  **Options...** for content item options:

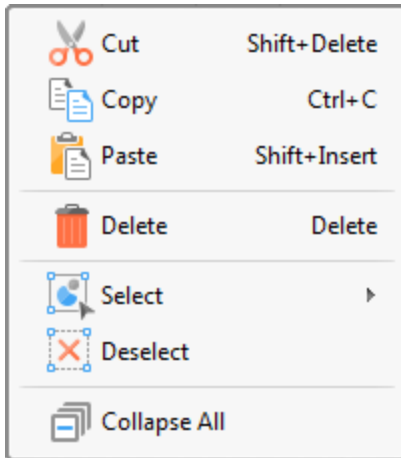



Figure 4. Content Options

- Click **Cut**, **Copy**, **Paste** or **Delete** to perform these operations on selected content items
- Hover over **Select** to view selection options:
  - Click **All** to select all content items.
  - Click **Text** to select all textual content items.
  - Click **Images** to select all image items.
  - Click **Shapes** to select all shape items.
- Editing options such as **Cut**, **Copy**, **Paste**, **Delete** - and changes made to properties in the **Page Content Properties** pane - will apply to all content selected via the choice made in the **Select** submenu.
- Click **Deselect** to deselect all selected content items.
- Click **Select** to **Select All** content within the active document. Then select either **Text**, **Images** or **Shapes** as desired. When editing commands are selected subsequently they will relate to all selected content.
- Click **Deselect** to deselect content currently selected.
- Click **Collapse All** to collapse all items in the **Content** pane.

Right-click items in the **Content** pane for additional editing options, as detailed [here](#). 

10.4.3.1.9 Destinations



**Destinations**

Click **Destinations** to open the **Named Destinations** pane:

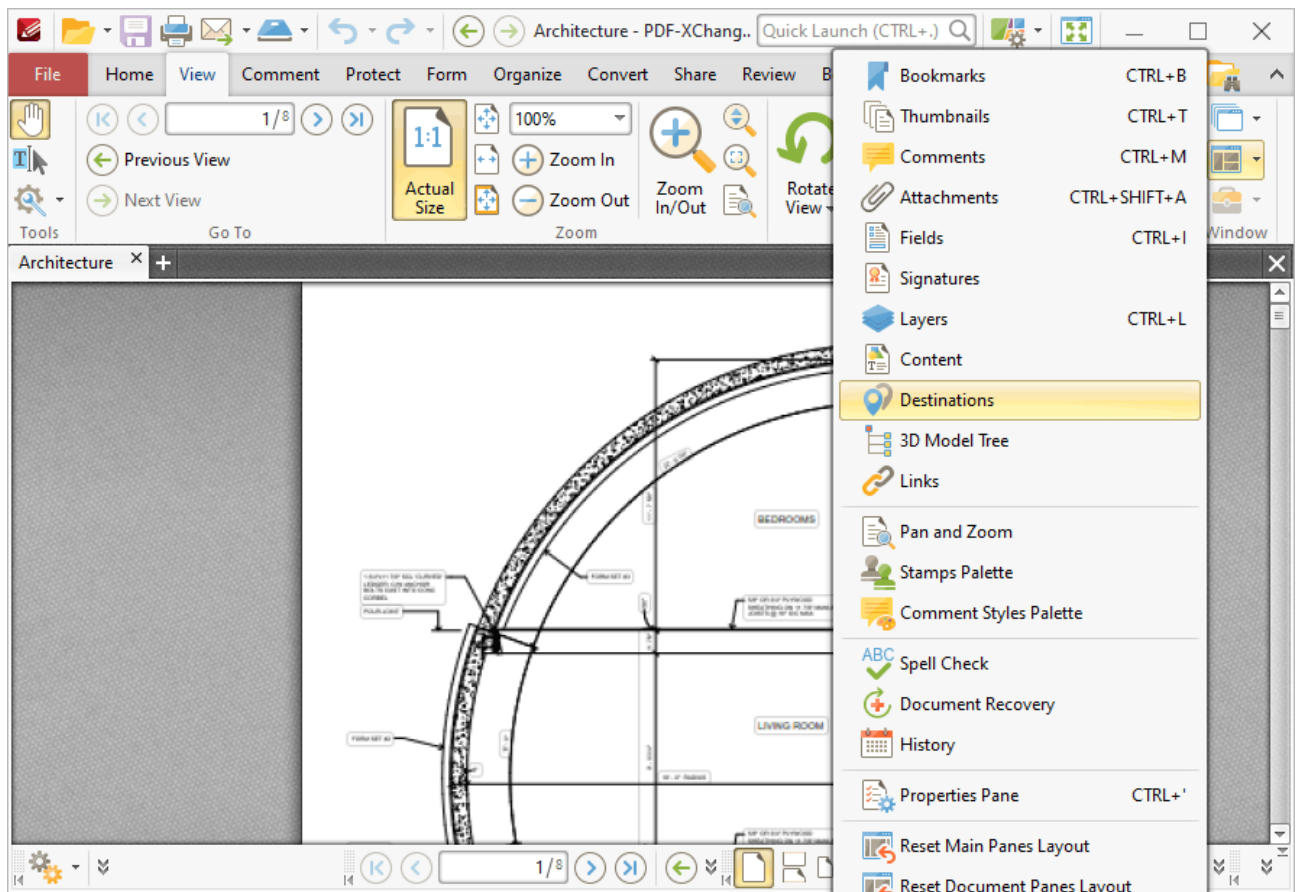

Figure 1. View Tab, Panes Dropdown Menu, Destinations

The **Named Destinations** pane is used to view/edit named destinations:

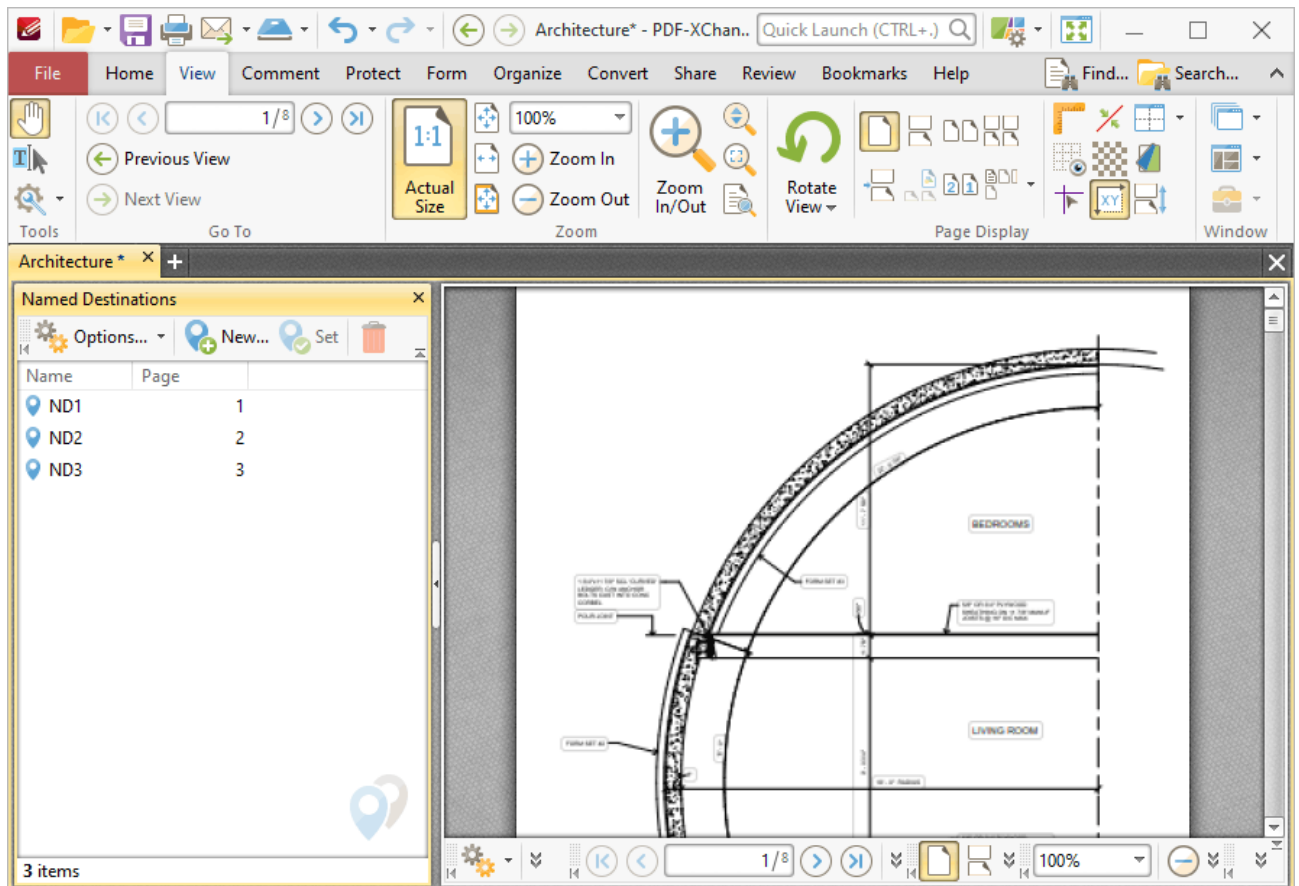





Figure 2. Named Destinations Pane

Named destinations are user-defined locations in documents. They can be used in conjunction with [Bookmarks](#), [Go To Page](#) actions and the `/Open` command line to navigate to specified locations. Double-click named destinations to move to their location in the document. Use the icons in the **Named Destinations** pane to perform the following operations:

- Click  **New Destination** to create a new named destination from the current view.
- Click  **Set** to set the current view as the new view for the selected named destination.
- Click  **Delete** to delete selected named destinations.
- Click  **Options...** for named destination options:

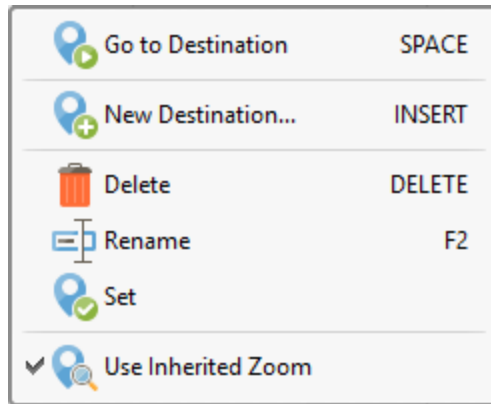

Figure 3. Named Destination Options

- Click **Go to Destination** to move to selected destinations.
  - Click **New Destination** (or press Insert) to create a new named destination from the current view.
  - Click **Delete** to delete selected named destinations.
  - Click **Rename** to rename selected named destinations.
  - Click **Set** to set the current view as the new view for the selected named destination.
  - Click **Use Inherited Zoom** to enable/disable inherited zoom in the creation of named destinations.
-

10.4.3.1.10 3D Model Tree



3D Model Tree

Click **3D Model Tree** to open the **3D Model Tree** pane:

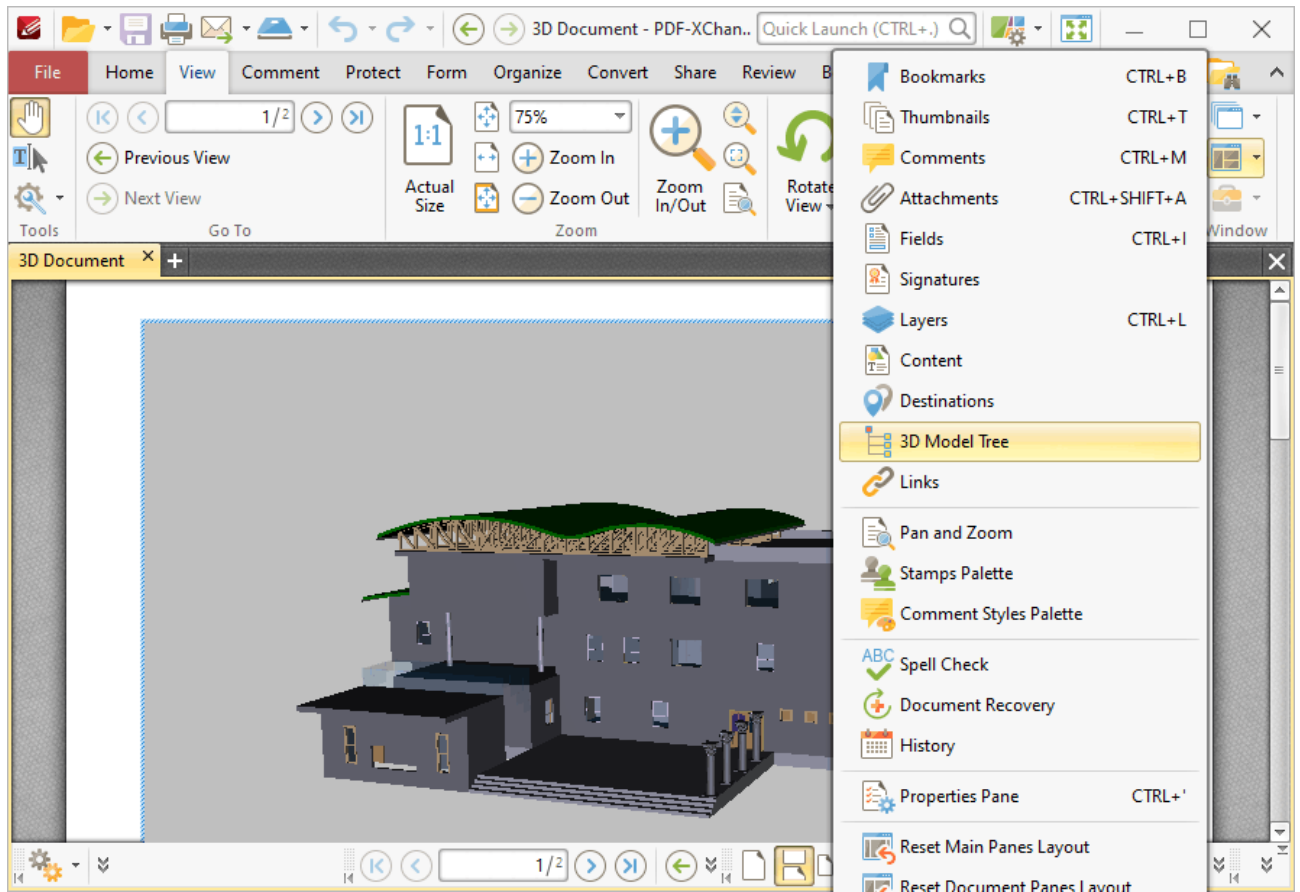

Figure 1. View Tab, Panes Dropdown Menu, 3D Model

The **3D Model Tree** pane displays the hierarchy of selected 3D content in documents:

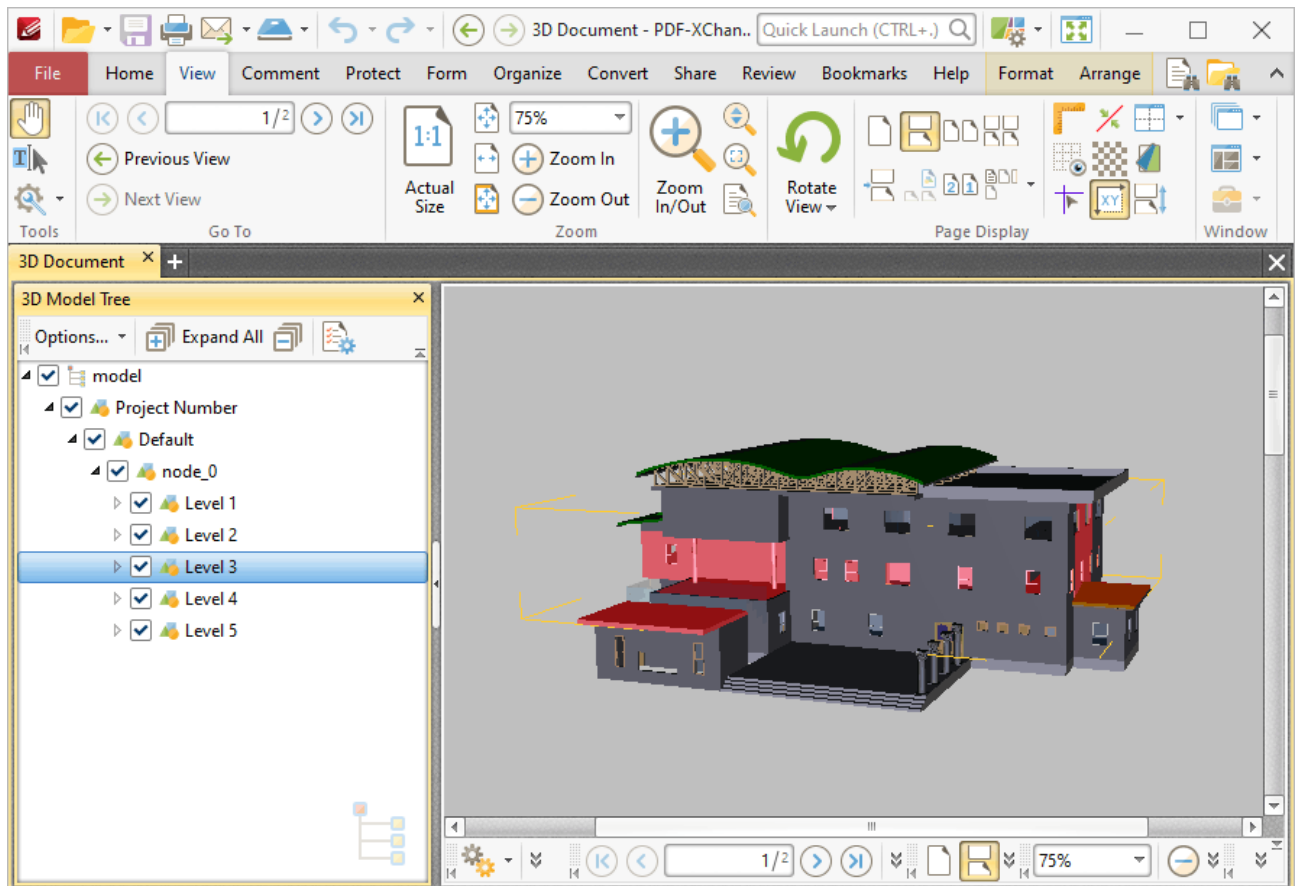





Figure 2. 3D Model Tree Pane

Note that it is necessary to click 3D content in order to select/activate them in documents. If 3D content is not selected then the **3D Model Tree** pane will be empty.

Click items in the **3D Model Tree** pane to select them in the document. Use the icons in the **3D Model Tree** pane to perform the following operations:

- Click  **Expand All** to expand all branches in the **3D Model Tree** hierarchy.
- Click  **Collapse All** to collapse all branches in the **3D Model Tree** hierarchy.
- Click  **Properties** to view/edit the properties of selected content. The **3D Properties** pane will open. This pane details the status of properties for selected content:



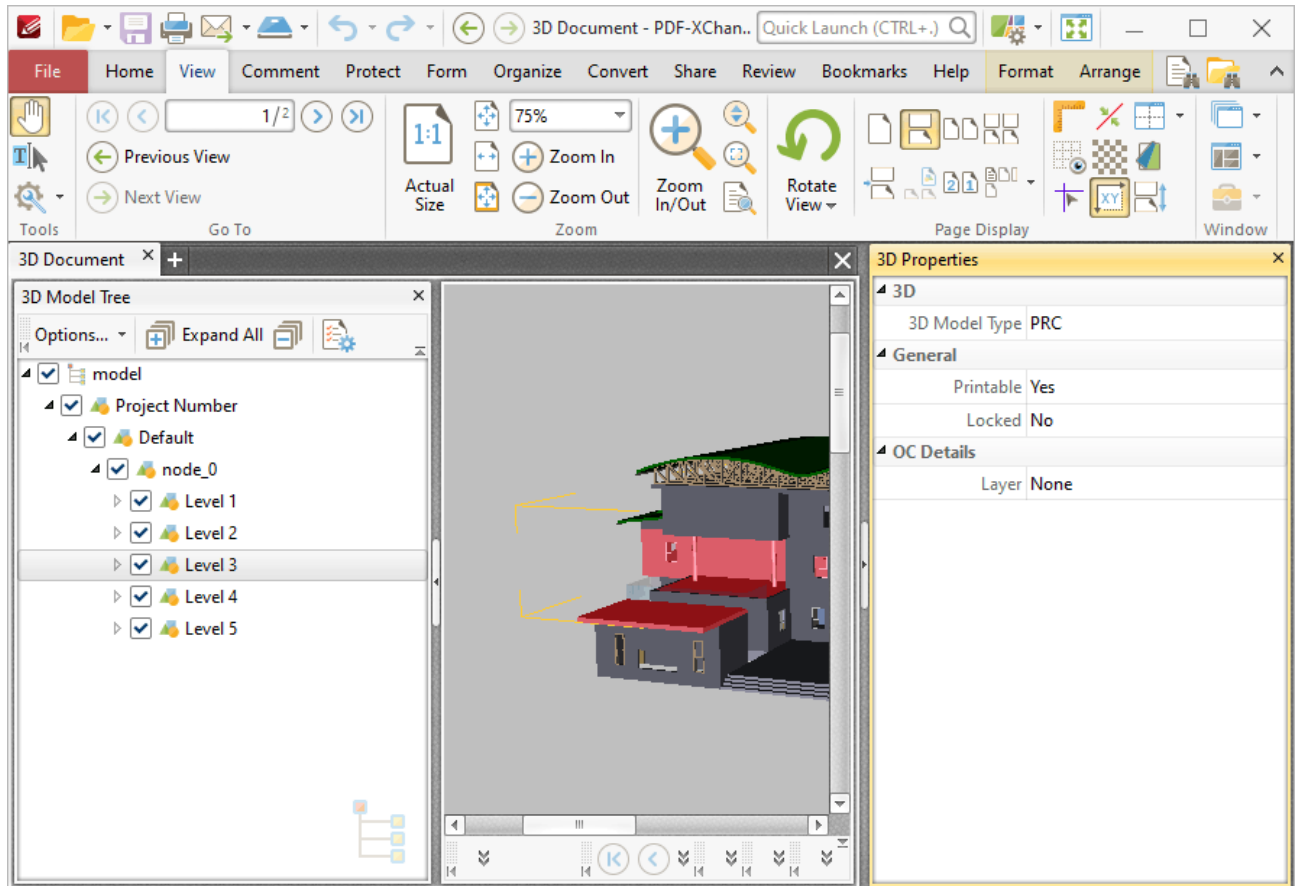

Figure 3. 3D Properties Pane

Click to edit properties as desired. Please note that not all properties are editable. The following properties are available for 3D content:

- **3D Model Type** displays the file format of the 3D content.
- **Printable** displays the print status of the 3D content. If this property is enabled then the comment is printed with the document. If this property is not enabled then it is not printed.
- **Locked** determines the locked status of the 3D content. If this property is enabled then the content cannot be deleted and its properties (including its position and size) cannot be modified by users.
- **Layer** determines the optional content layer to which the 3D content belongs. Further information about layers is available [here](#).<sup>1024</sup>

Click  for 3D content item options:

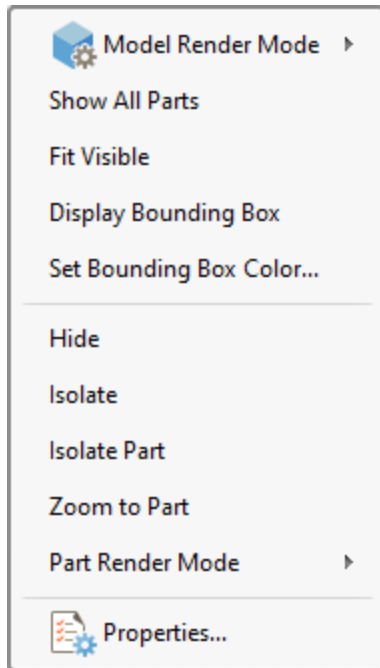

Figure 4. 3D Content Options

- Hover over **Model Render Mode** to view/select alternative rendering modes for the 3D content.
- Click **Show All Parts** to display all parts of the 3D content in the document.
- Click **Fit Visible** to zoom the view in order to display all 3D content.
- Click **Display Bounding Box** to display a bounding box around the 3D node selected in the **3D Model Tree** pane.
- Click **Set Bounding Box Color** to change the color of the bounding box around the 3D content.
- Click **Hide** to hide the node of the 3D content selected in the **3D Model Tree** pane.
- Click **Isolate** to display only the node of the 3D content selected in the **3D Model Tree** pane.
- Click **Isolate Part** to display only the part of the 3D content selected in the **3D Model Tree** pane. Note that parts are the parents of nodes in the **3D Model Tree** pane.
- Click **Zoom to Part** to zoom to the part selected in the **3D Model Tree** pane.
- Hover over **Part Render Mode** to view/select alternative rendering modes for the part of 3D content selected in the **3D Model Tree** pane.
- Click **Properties** to open the **3D Properties** pane, as detailed above.

## 10.4.3.1.11 Links



**Links**

Click **Links** to open the **Links** pane:

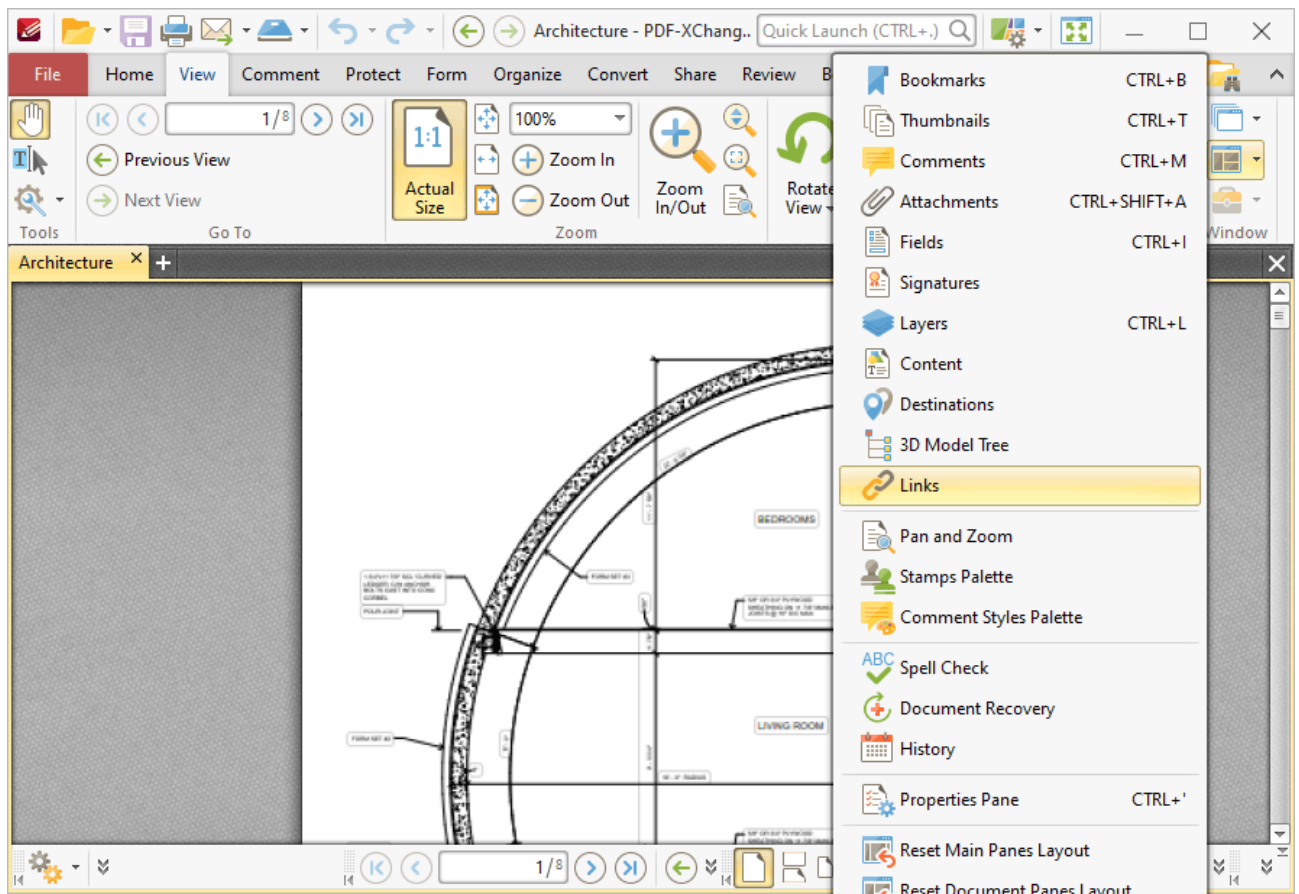

**Figure 1.** View Tab, Panes Dropdown Menu, Links

The **Links** pane displays links in documents:

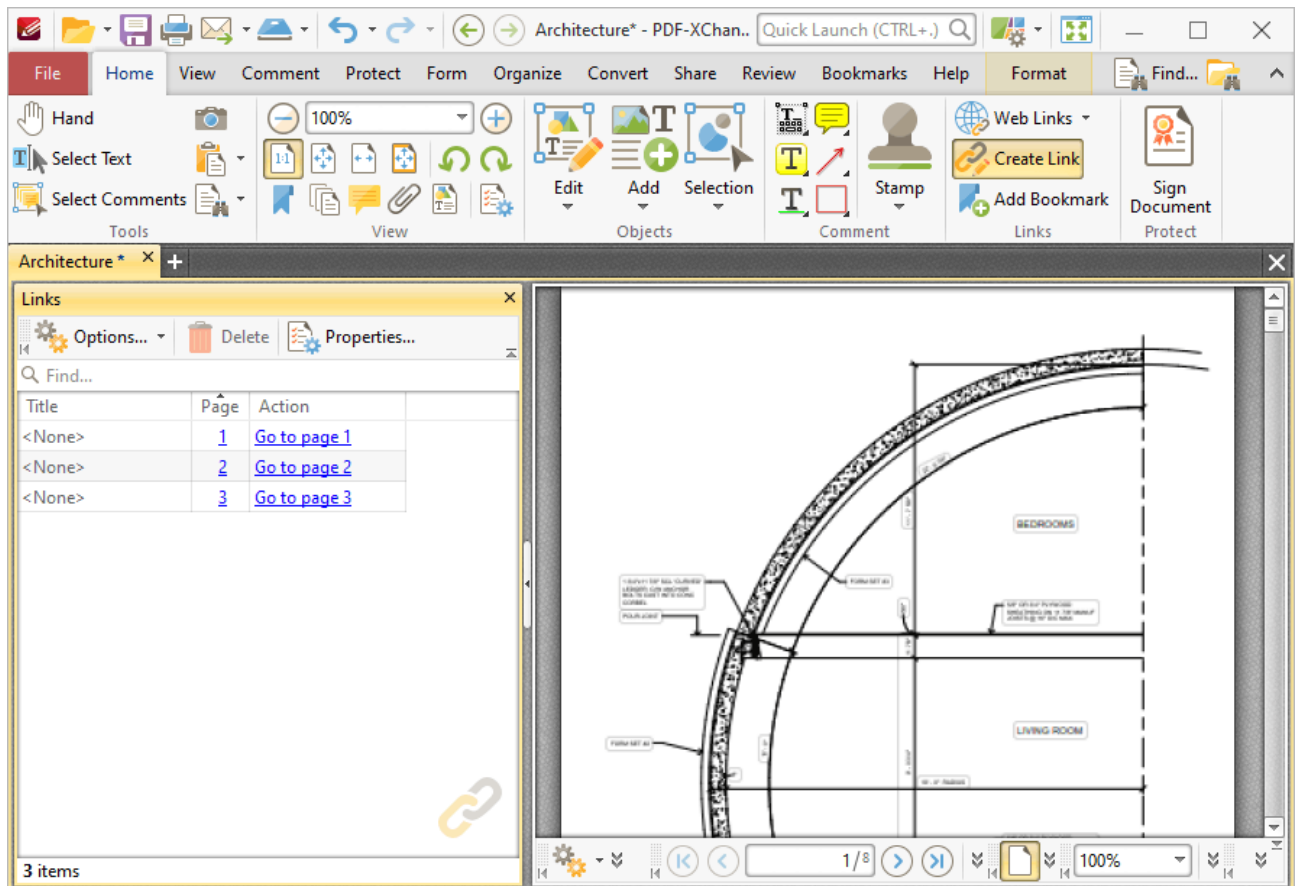





Figure 2. Links Pane

Click items in the **Links** pane to select them in the document. Use the icons in the **Links** pane to perform the following operations:

- Click  **Delete** to delete selected links.
- Click  **Web Links** to view options for weblinks, then click **Create Web-Links from URLs** or **Remove All Web-Links** as desired.
- Click  **Wrap Long Titles** to spread the title of links over multiple lines in cases where links have long names.
- Click  **Properties** to view/edit the properties of selected links. The **Links** pane will open. This pane details the status of properties for links:

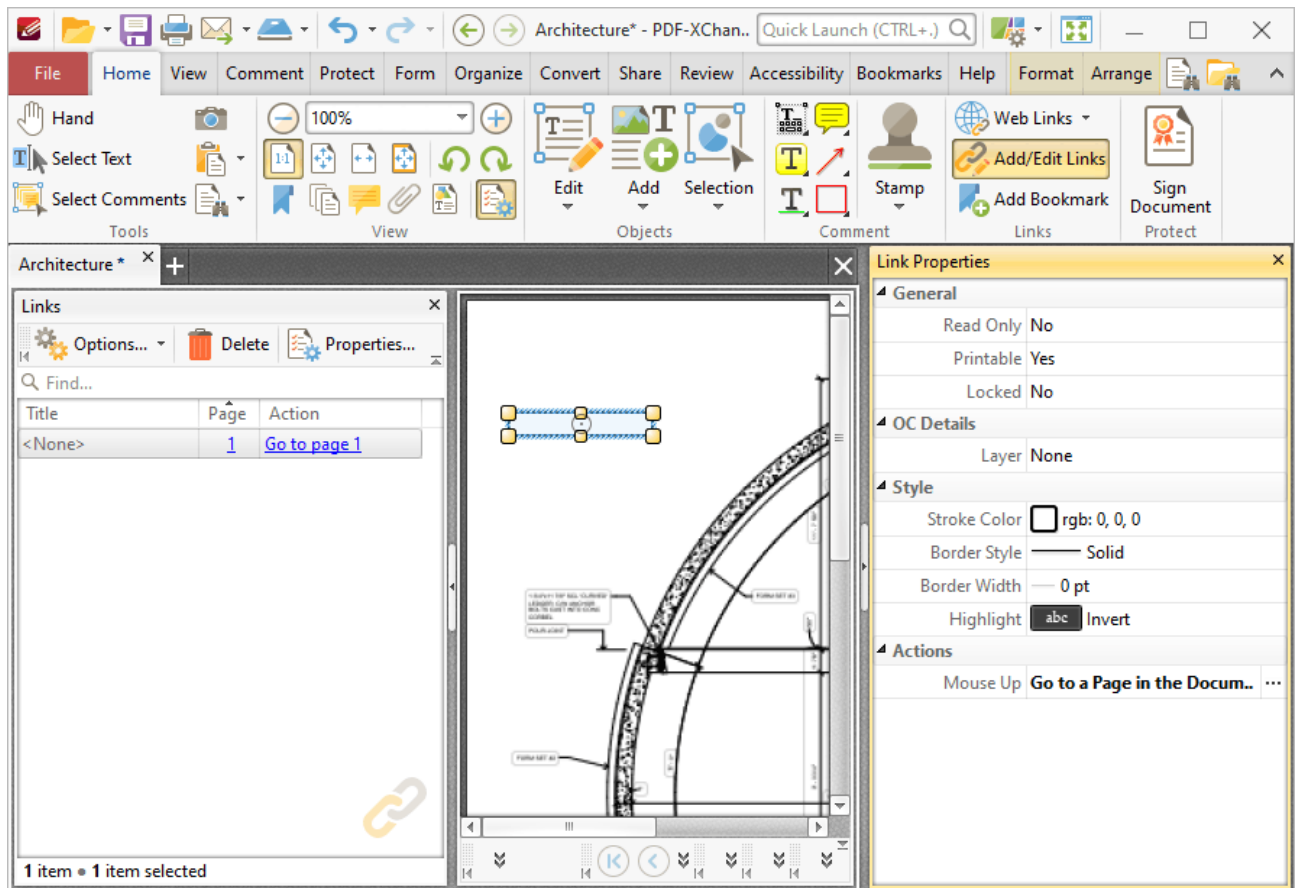
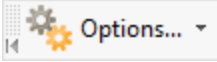

Figure 3. Link Properties Pane

Click to edit properties as desired. Please note that not all properties are editable. The following properties are available for links:

- **Read Only** is the read only status of the link. If this property is enabled then users cannot interact with the link.
- **Printable** is the print status of the link. If this property is enabled then the link is printed with the document. If this property is not enabled then the link is not printed.
- **Locked** is the locked status of the link. If this property is enabled then the link cannot be deleted and its properties (including its position and size) cannot be modified by users.
- **Layer** specifies the optional content layer to which the link belongs. Further information about layers is available [here](#).<sup>1024</sup>
- **Stroke Color** determines the border color of the link.
- **Border Style** determines the border style of the link
- **Border Width** determines the border width of the link.
- **Highlight** determines the visual effect when the link is clicked.
- **Mouse Up** determines the action taken when the link is clicked. Click the ellipsis icon on the right of the action to view/edit/add actions, as detailed [here](#).<sup>959</sup>

Click  for link options:

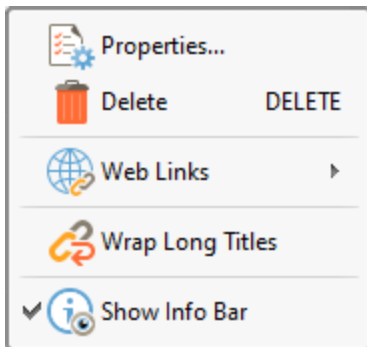

Figure 4. Link Options

- Click **Properties** to open the **Link Properties** pane, as detailed above.
  - Click **Delete** to delete selected links.
  - Hover over **Web Links** to view options for weblinks, then click either **Create Web-Links from URLs** or **Remove All Web-Links** as desired.
  - Click **Wrap Long Titles** to spread the title of links over multiple lines in cases where links have long names.
  - Click **Show Info Bar** to show/hide the info bar at the bottom of the pane.
-

10.4.3.1.12 Pan and Zoom



**Pan and Zoom**

Click **Pan and Zoom** to open the **Pan and Zoom** pane:

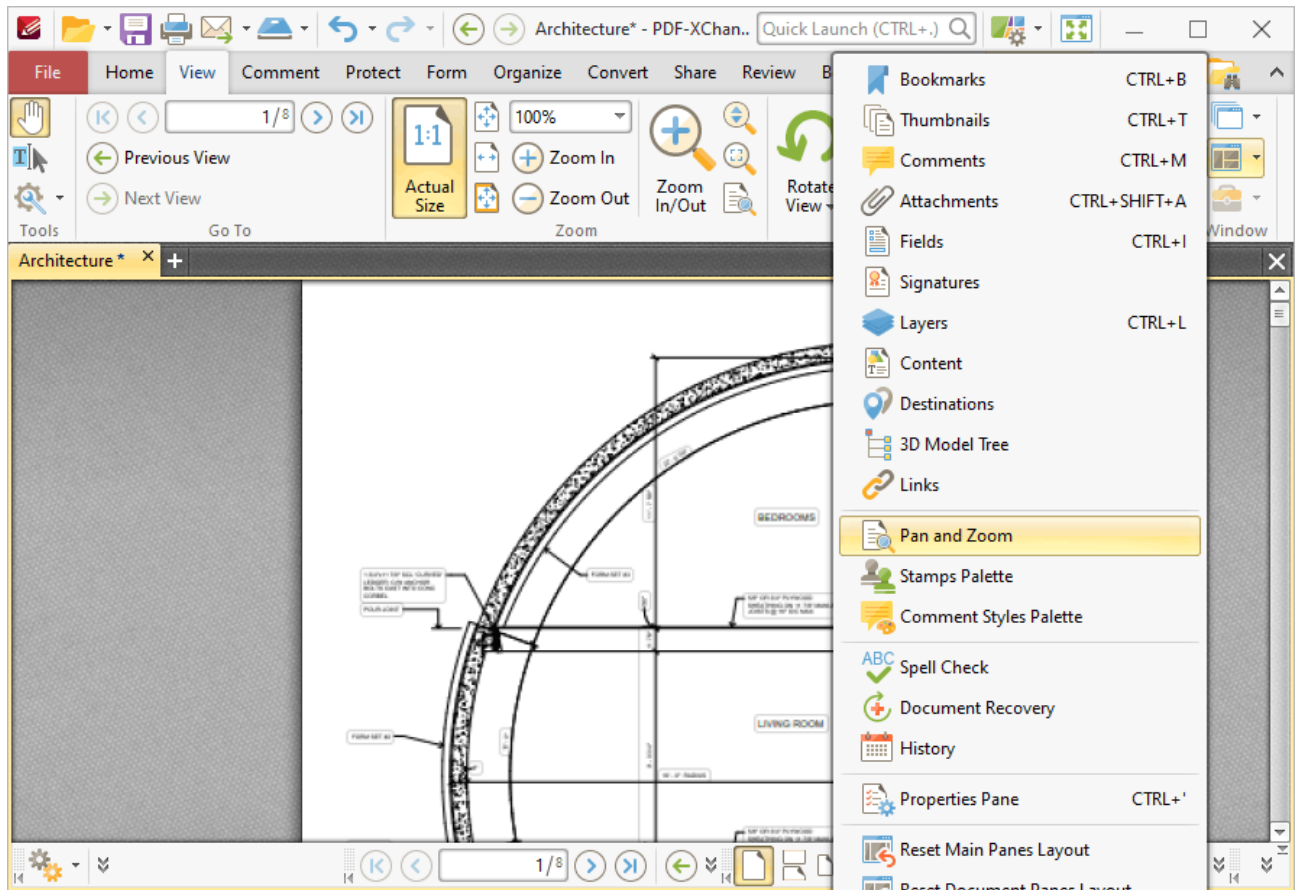
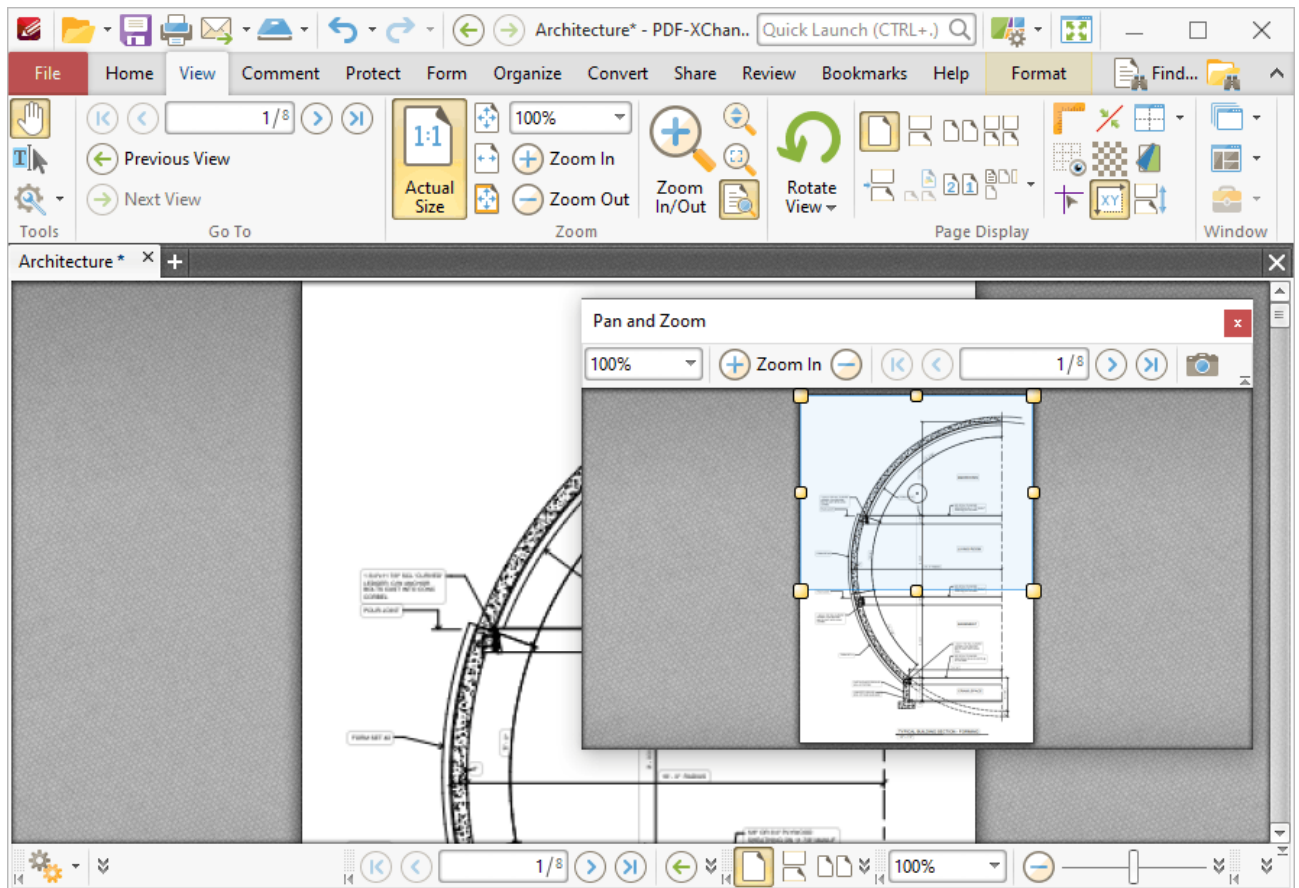

Figure 1. View Tab, Panes Dropdown Menu, Pan and Zoom

The **Pan and Zoom** pane displays a miniature version of the current page to assist in editing documents:



**Figure 2.** Active Pan and Zoom Pane

The blue rectangle in the **Pan and Zoom** pane determines the current view in the main window.

- Click and drag the rectangle to adjust the current view.
- Click and drag the yellow control points to manipulate the pan and zoom in the main window.
- Click and drag the **Pan and Zoom** pane to reposition it on the screen. When it is selected, four icons will appear in the center of the borders of the main window:



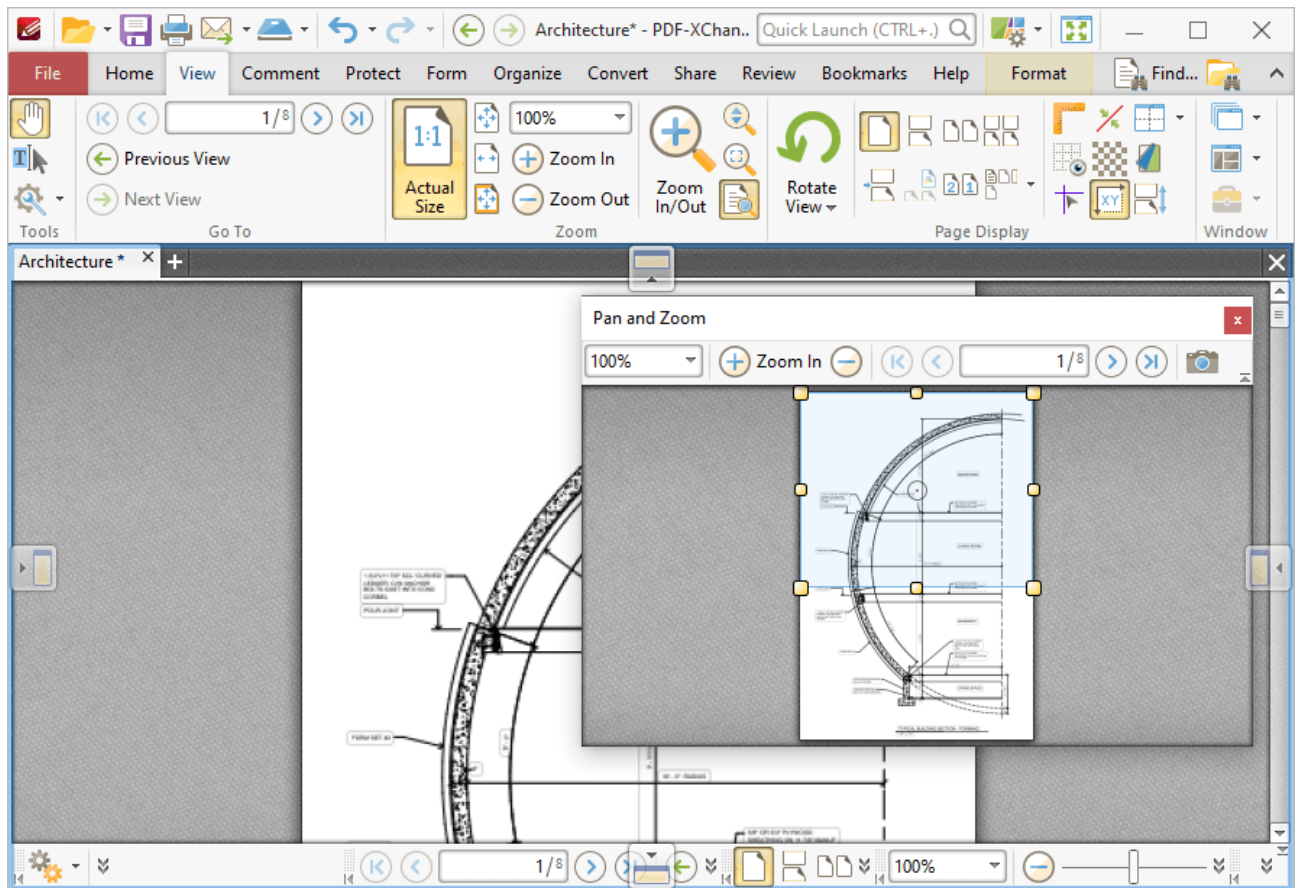

Figure 3. Pan and Zoom Pane Docking Options

Move the pointer to these icons and then release the mouse button to dock the **Pan and Zoom** pane. Use the icons in the **Pan and Zoom** pane to perform the following operations:

Use the  zoom dropdown menu, or enter a value manually, to adjust the zoom level of the view in the pan and zoom pane.

Use the   **Zoom in/Zoom Out** buttons to zoom in/out to predefined levels of zoom.

Use the   **First Page/Last Page** buttons to move to the first/last page of documents.

Use the   **Previous Page/Next Page** buttons to move to the previous/next page of documents.

Use the  **Page** box to browse to document pages. Enter page numbers and press enter

Use the  **Snapshot** icon to copy the current view to the clipboard.

## 10.4.3.1.13 Stamps Palette



### Stamps Palette

Click **Stamps Palette** to open the **Stamps Palette**:

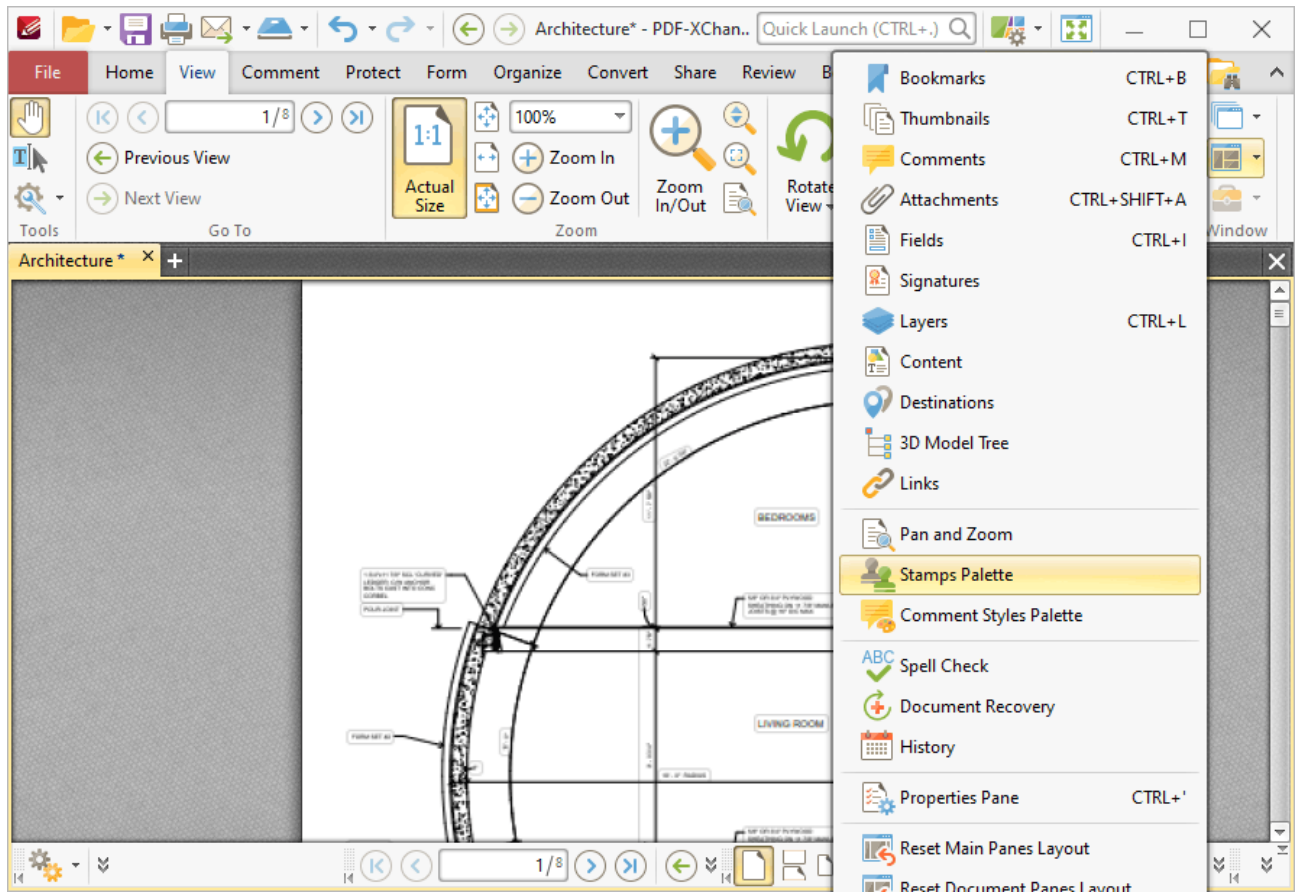

Figure 1. View Tab, Panes Dropdown Menu, Stamps Palette

The **Stamps Palette** contains all default and custom stamps:

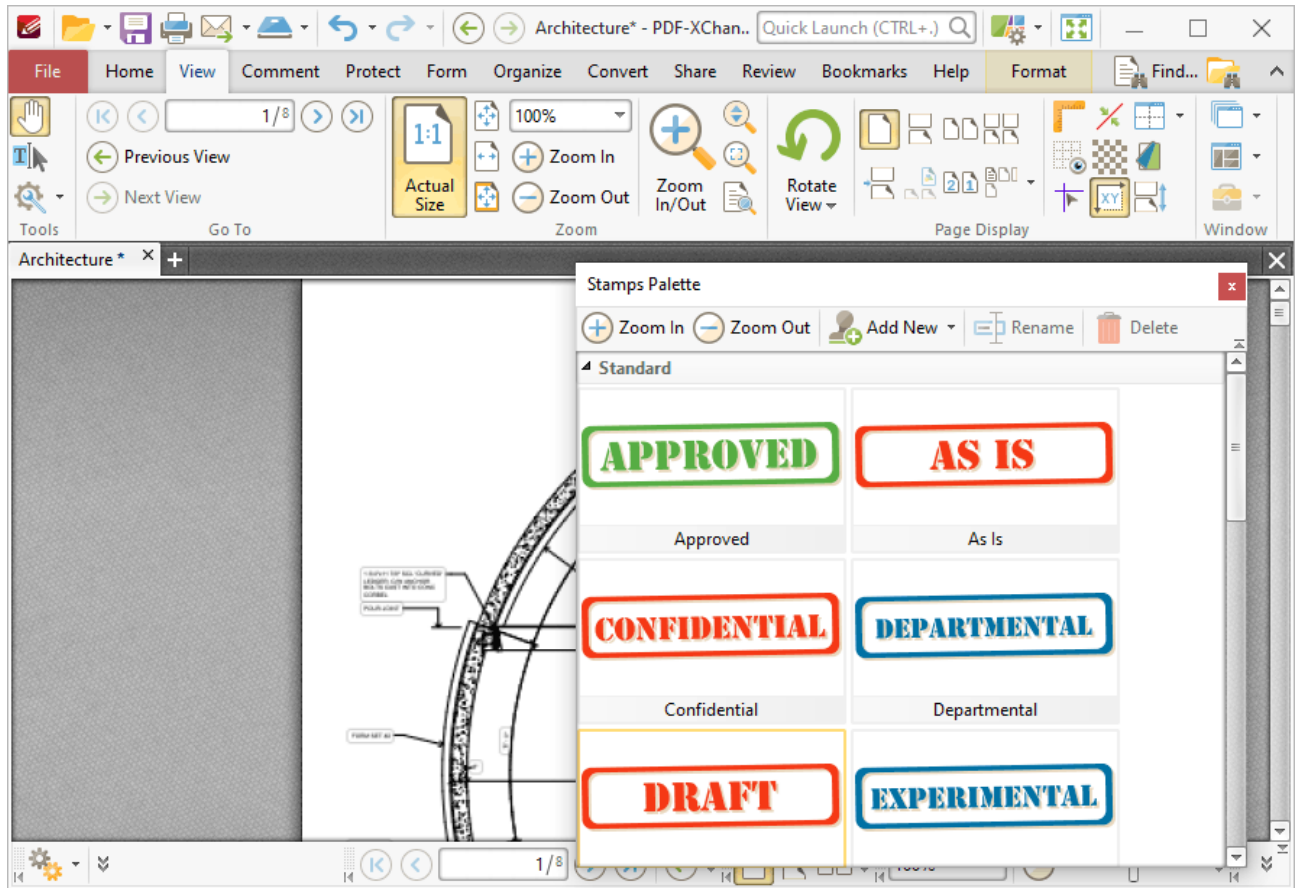

Figure 2. Stamps Palette

Stamps are used to give documents specific designations, as detailed in *(figure 2)*. Click to select stamps, then click to add them to documents. Use the icons in the **Stamps Palette** to perform the following operations:

- Use the **Zoom in/Zoom Out** buttons to adjust the zoom level.
- Click **Rename** to rename selected stamps.
- Click **Delete** to delete selected stamps.
- Click **Add New** to view stamp creation options:

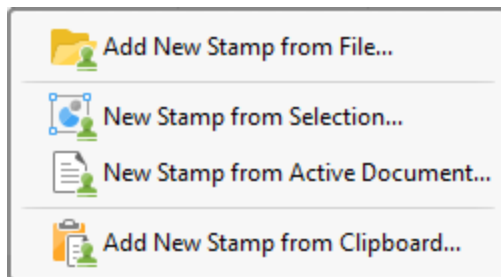

Figure 3. Stamp Creation Options

- Click **Add New Stamp from File** to create a stamp from an existing file.
- Click **New Stamp from Selection** to create a stamp from selected document content.
- Click **New Stamp from Active Document** to create a stamp from the active document.
- Click **Add New Stamp from Clipboard** to create a new stamp from the current clipboard content.
- Click and drag the **Stamps Palette** to reposition it on the screen. When it is selected, four icons will appear in the center of the borders of the main window:

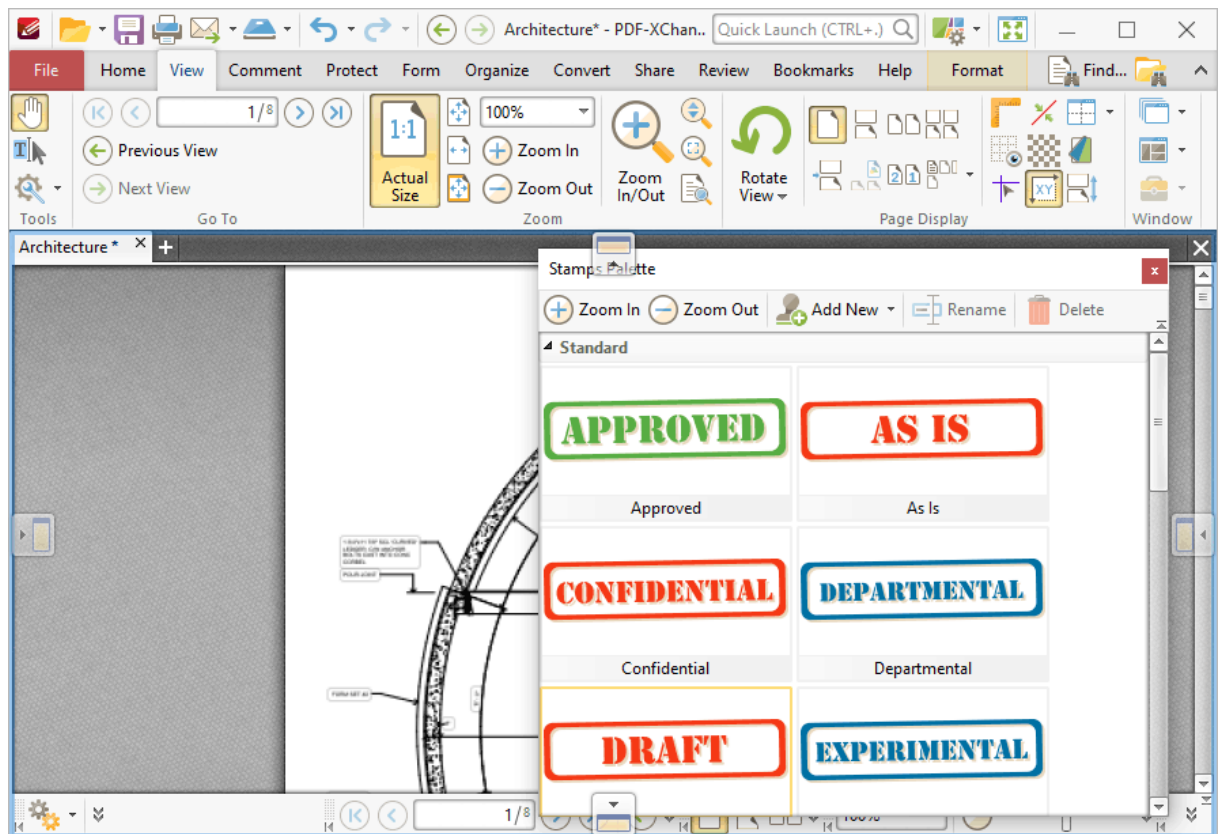

Figure 4. Stamps Palette Docking Options

Move the pointer to these icons and then release the mouse button to dock the **Stamps Palette**.

Further information about stamps and the creation of stamps is available [here](#).<sup>1192</sup>

10.4.3.1.14 Comment Styles Palette



**Comment Styles Palette**

Click **Comment Styles Palette** to open the **Comment Styles Palette**:

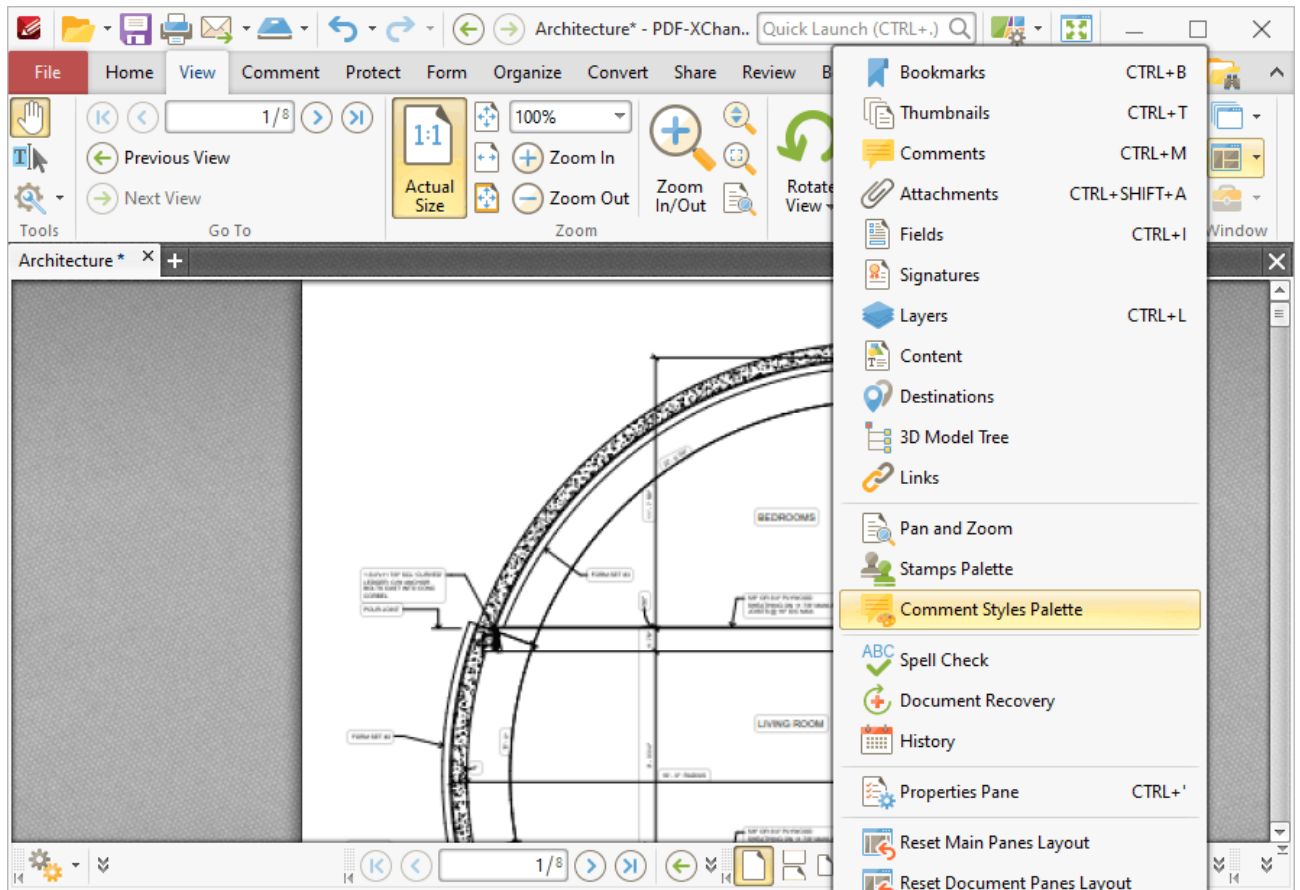

**Figure 1.** View Tab, Panes Dropdown Menu, Comment Styles Palette

The **Comment Styles Palette** contains all default and customized comment styles:

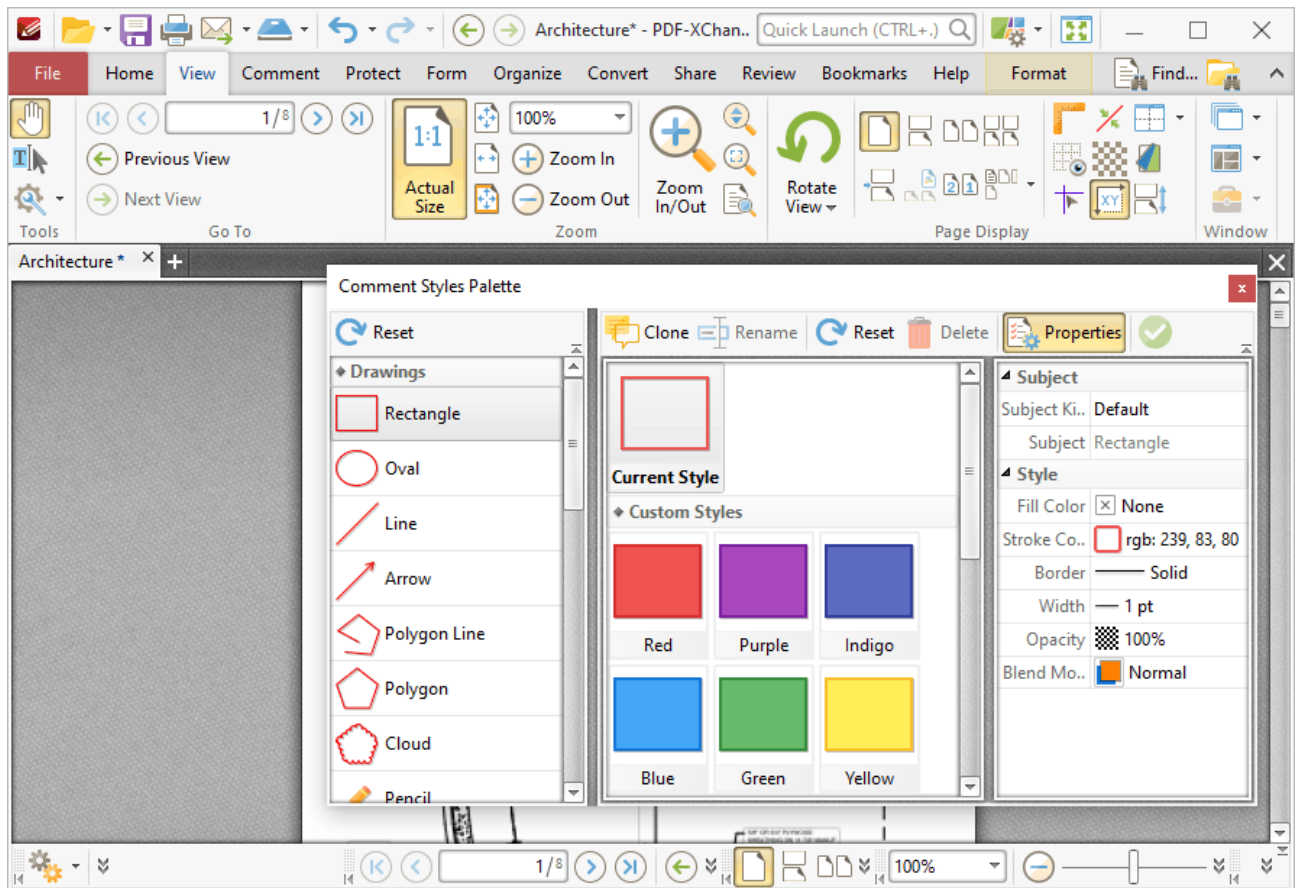

Figure 2. Comment Styles Palette

Comments are used to markup and annotate documents. The **Comment Styles Palette** facilitates the creation, saving and selection of custom comment styles. Select comment formats in the **Drawings** list and then click **Properties** to view/edit the properties of the comment style. All comment properties are detailed [here](#).<sup>1788</sup> Double-click to enable comment styles for use in **PDF-XChange Editor**. Click and drag the **Comment Styles Palette** to reposition it on the screen. When it is selected, four icons will appear in the center of the borders of the main window:

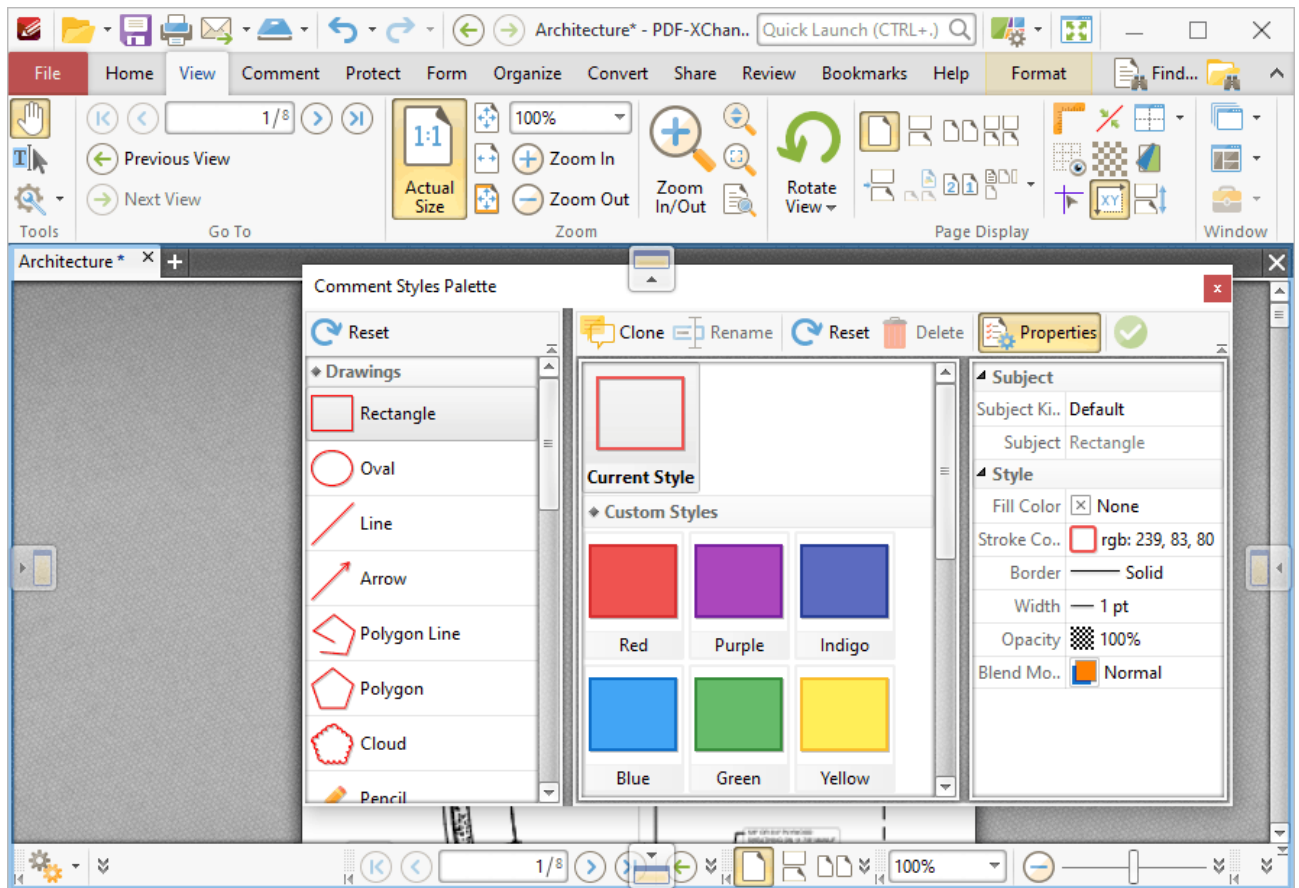









Figure 3. Comment Styles Palette Docking Options

Move the pointer to these icons and then release the mouse button to dock the **Comment Styles Palette** pane. Use the icons in the **Comment Styles Palette** to perform the following operations:

- Click  **Reset** to reset all comment styles.
- Click  **Clone** to clone the selected style. The feature creates a clone of an existing style, which is useful when it is desired to edit the properties of a style without losing the original customization.
- Click  **Rename** to rename selected comment styles.
- Click  **Reset** to reset selected comment styles.
- Click  **Delete** to delete selected comment styles. Please note that it is not possible to delete the default comment styles.
- Click  **Properties** to view/edit the properties of selected comment styles, as detailed above.
- Click  **Set Current** to set the selected comment style as the current style for the selected comment format.





10.4.3.1.15 Spell Check Pane



Spell Check Pane

Click **Spell Check** to open the **Spell Check** pane:

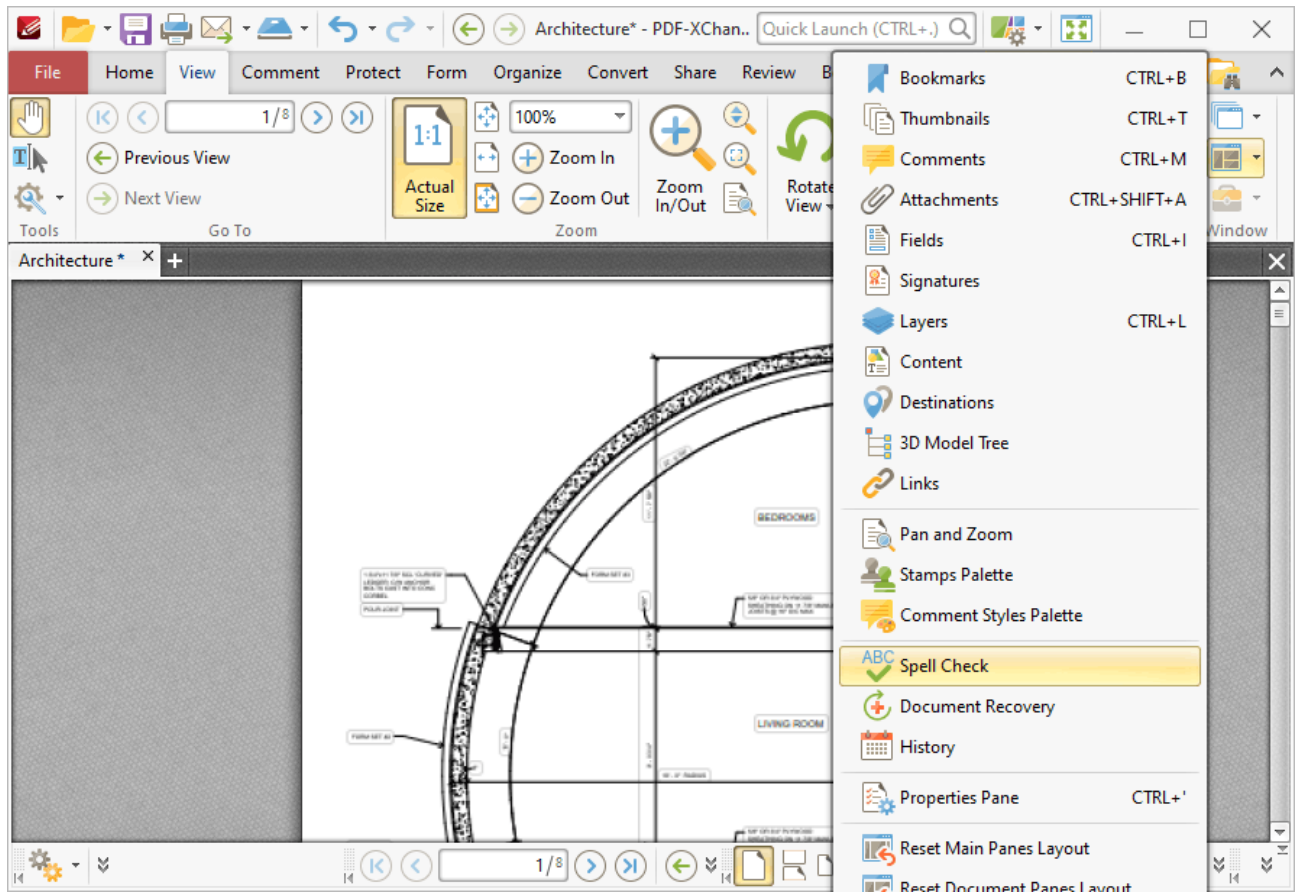

Figure 1. View Tab, Panes Dropdown Menu, Spell Check

The **Spell Check** pane is used to perform spell checks on documents:

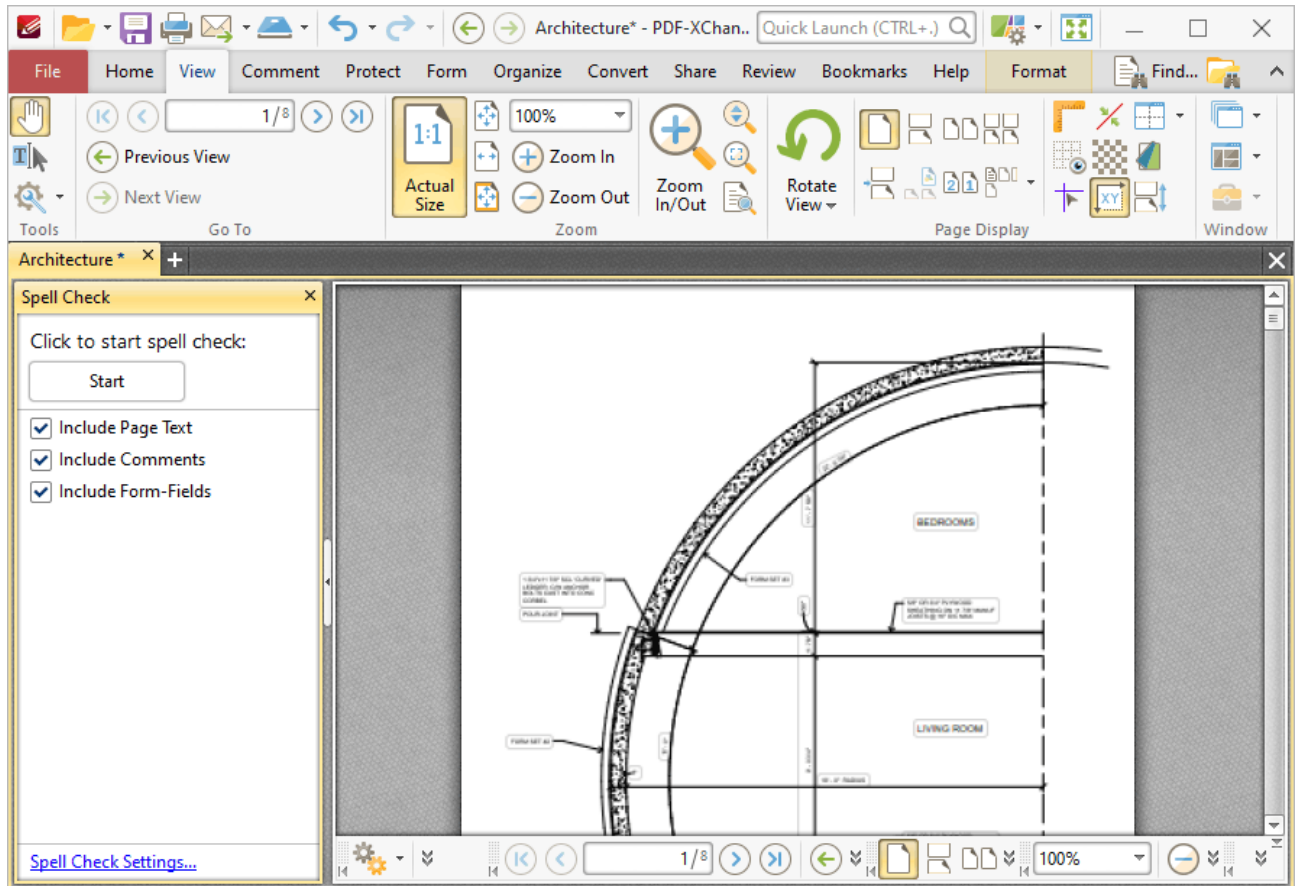

Figure 2. Spell Check Pane

Click **Start** to initiate spell checks. Further information on the **Spell Check** feature and its settings are available [here](#).

10.4.3.1.16 Document Recovery Pane



Document Recovery Pane

Click **Document Recovery** to open the **Document Recovery** pane:

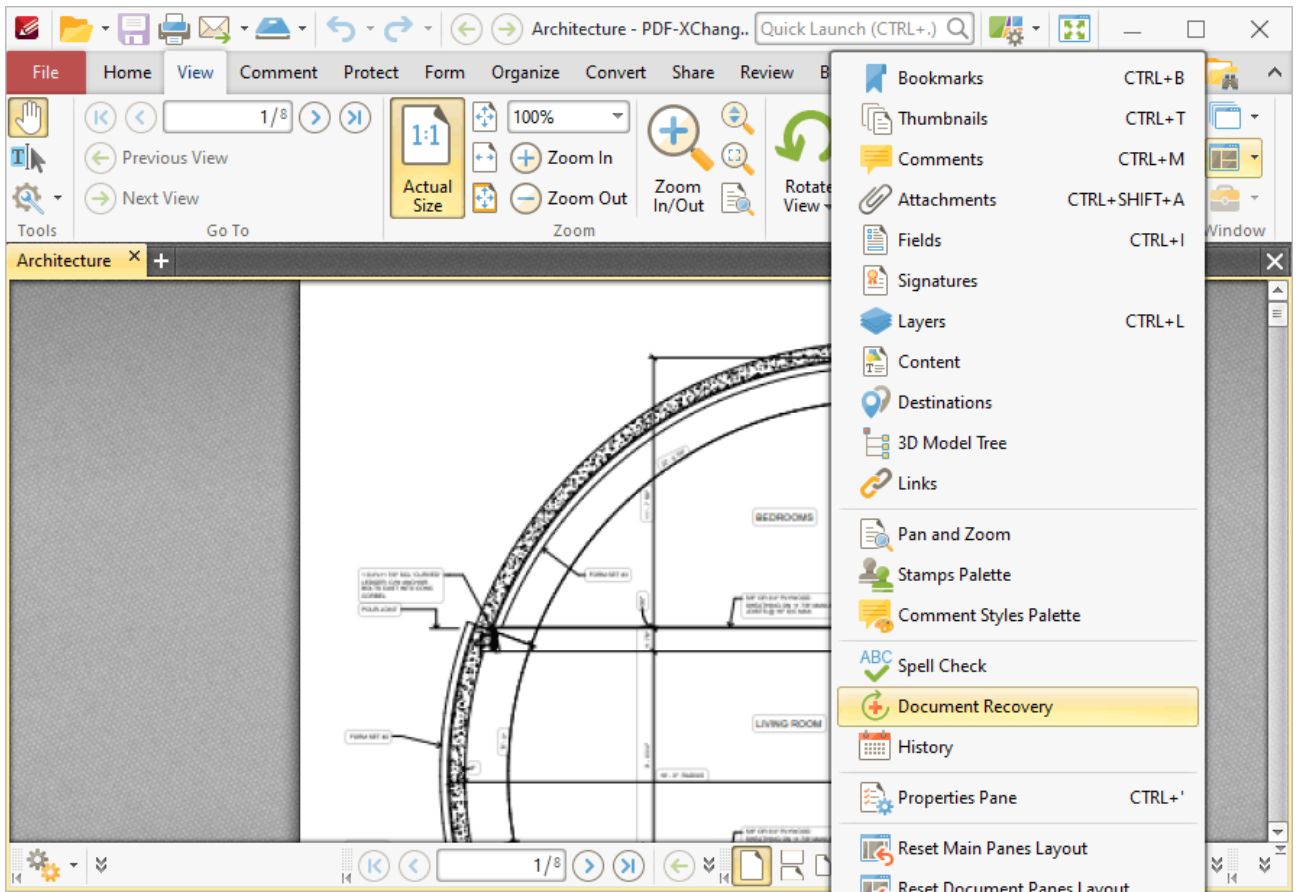

Figure 1. View Tab, Panes Dropdown Menu, Document Recovery

The **Document Recovery** pane details documents recovered when **PDF-XChange Editor** is closed and unsaved changes are present:

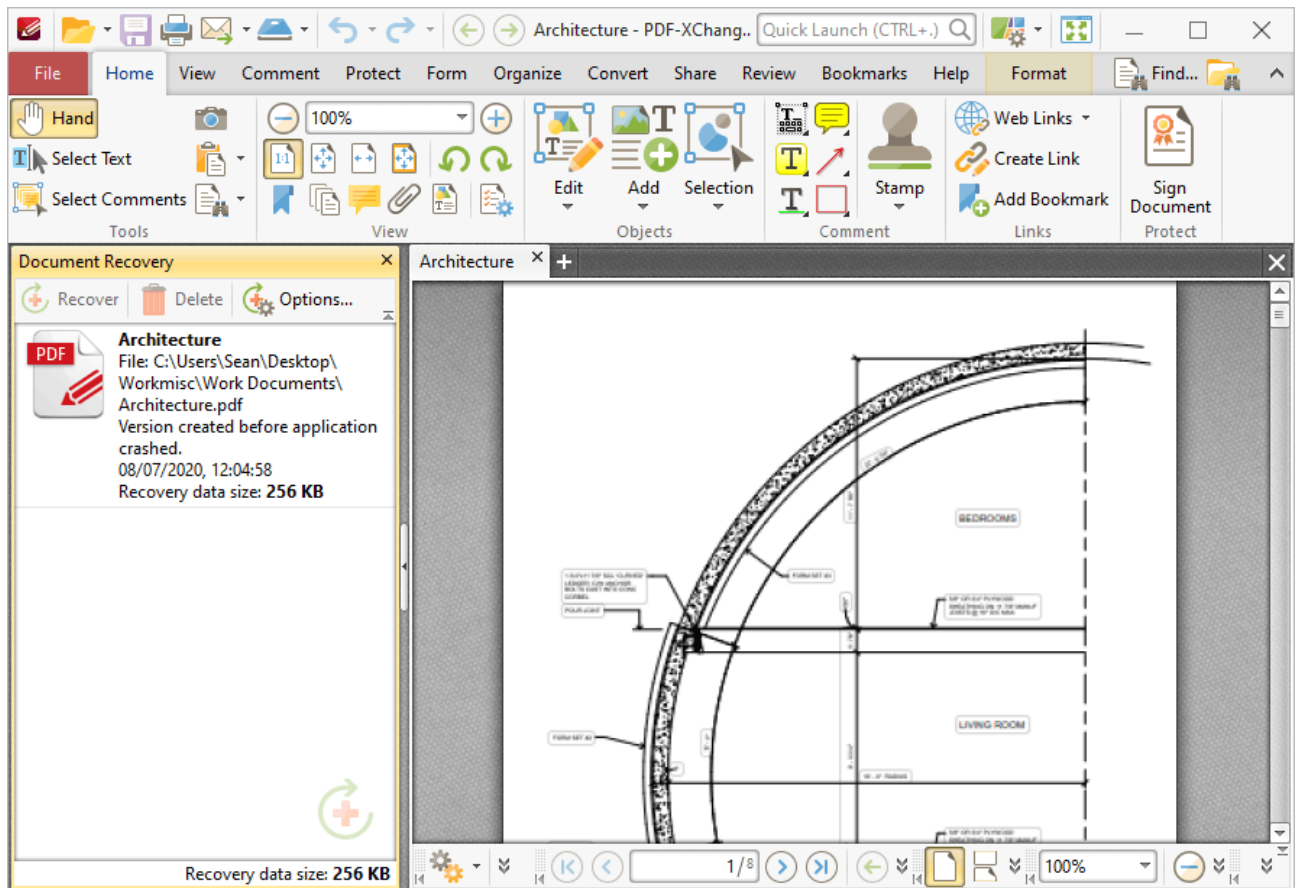





Figure 2. Document Recovery Pane

Recovered documents are detailed in the pane. Use the icons in the **Recovery** pane to perform the following operations:

- Click  **Recover** to recover selected documents. Recovered documents will be displayed in the main window.
- Click  **Delete** to delete selected documents.
- Click  **Options** to view/determine recovery options. The **Documents** preferences will open. These preferences are detailed [here](#).<sup>857</sup>

10.4.3.1.17 History



**History**

Click **History** to open the **History** pane:

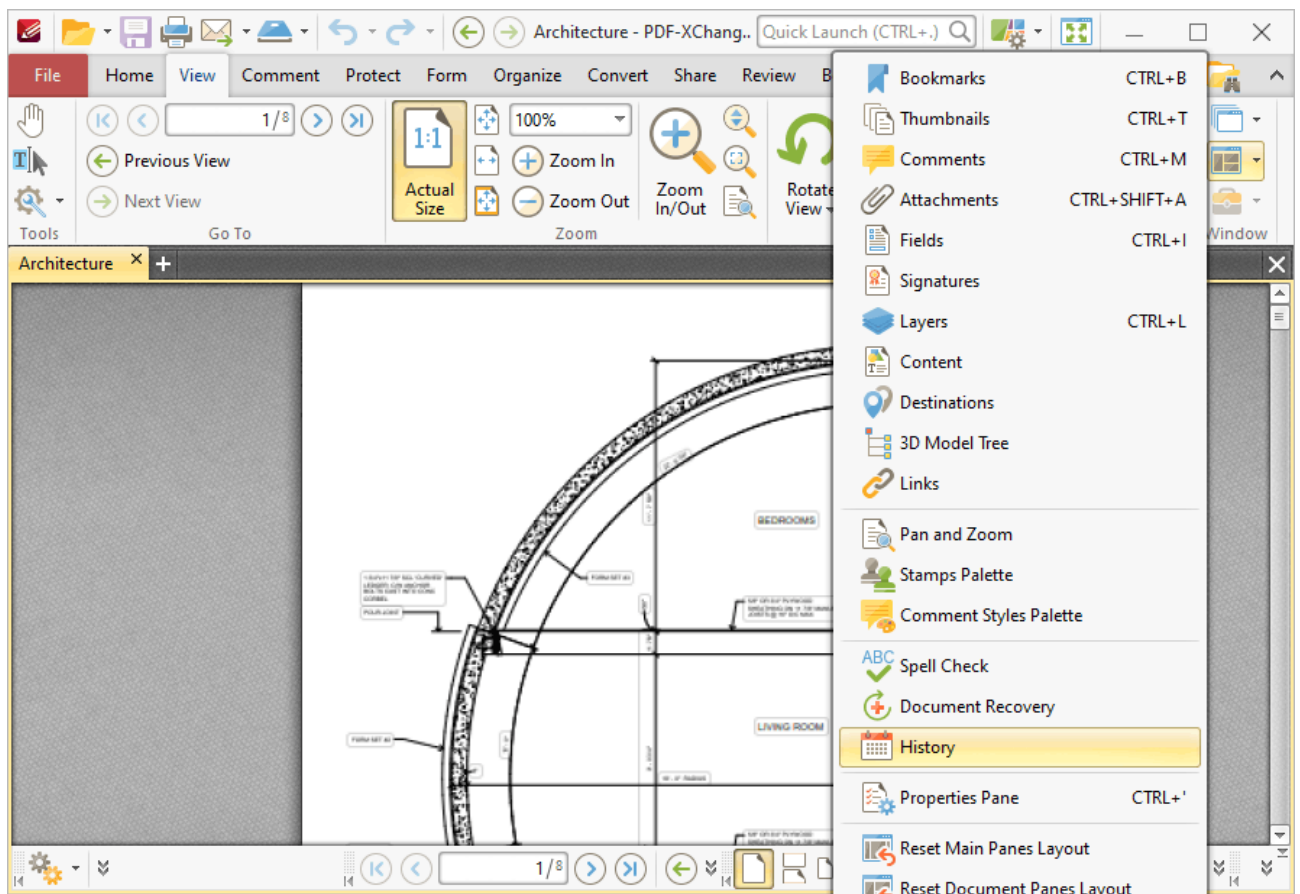

**Figure 1.** View Tab, Panes Dropdown Menu, History

The **History** pane details the history of documents opened in **PDF-XChange Editor**:

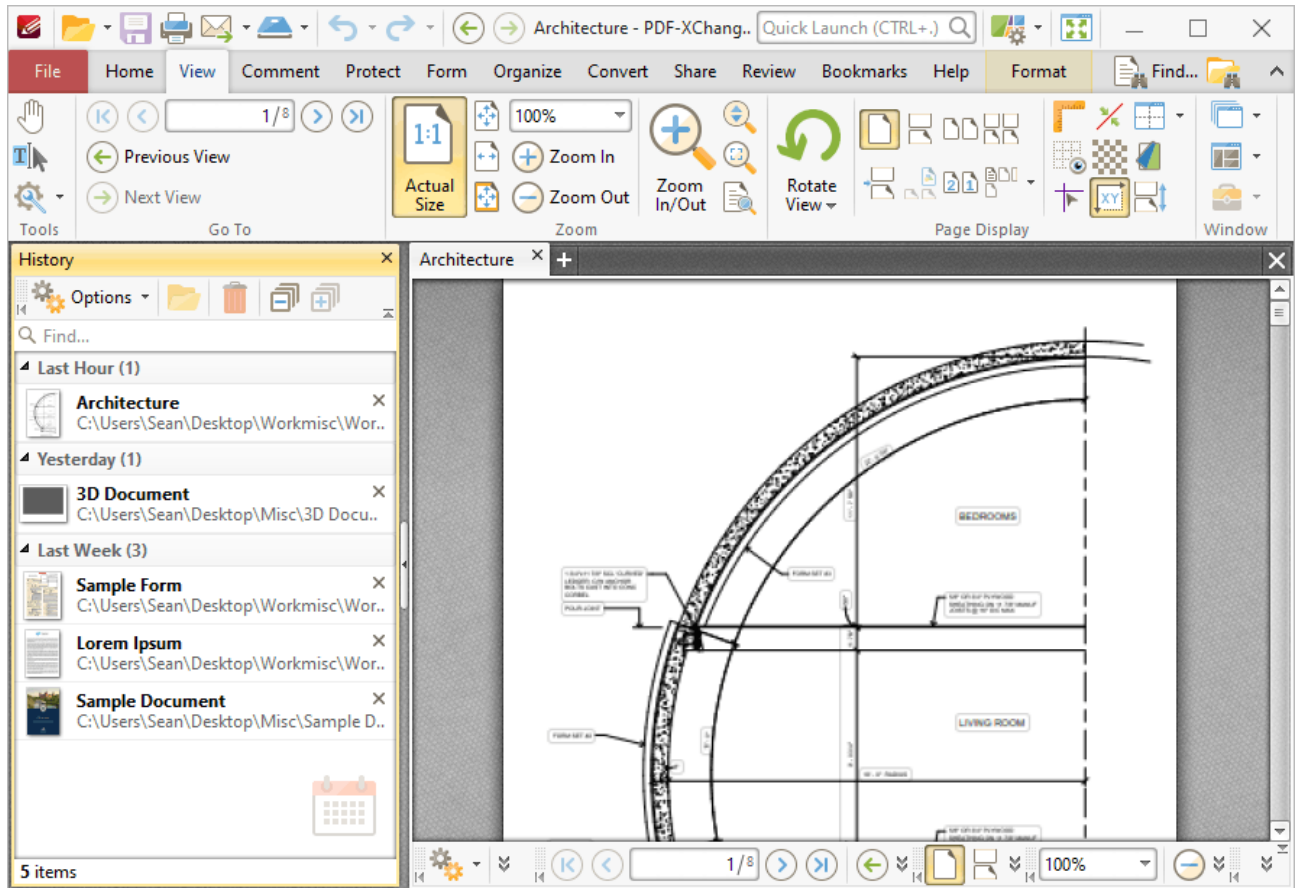







Figure 2. History Pane

The history of opened documents is detailed in the pane. Click the dropdown menus to view documents opened in the last hour/yesterday/last week/last month, and double-click to open documents. Use the **Find** search box to search for/open documents. Use the icons in the pane to perform the following operations:

- Click  **Open** to open selected documents.
- Click  **Remove** to remove selected documents from the pane.
- Click  **Collapse** to collapse all groups in the pane.
- Click  **Expand** to expand all groups in the pane.
- Click  **Options** for additional options:

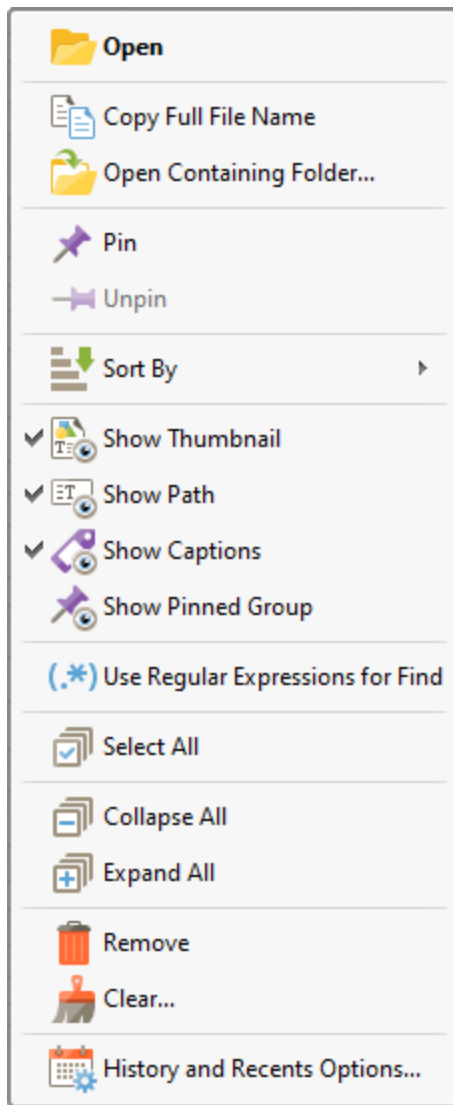

Figure 3. History Options

- Click **Open** to open selected documents.
- Click **Copy Full File Name** to copy the full name of selected documents to the clipboard.
- Click **Open Containing Folder** to open the containing folder of selected documents.
- Click **Pin/Unpin** to pin/unpin selected documents. Pinned documents remain at the top of the [Recent Files](#) <sup>777</sup> list, which makes them easier to locate and open. You can use the **Show Pinned Group** option detailed below to show/hide pinned documents in the **History** pane.
- Hover over **Sort by** to determine how files in the **History** pane are sorted, then select **Opened time, Modified time, Closed time** or **Alphabetical** as desired. Click **Show Groups** to enable/disable the grouping of documents in the **History** pane.
- Click **Show Thumbnail** to show/hide document thumbnails in the **History** pane.
- Click **Show Path** to show/hide document paths in the **History** pane.
- Click **Show Captions** to show/hide document names in the **History** pane.
- Click **Show Pinned Group** to show/hide the pinned documents in the **History** pane.

- Click **Use Regular Expressions for Find** to enable the use of ECMAScript syntax-based regular expressions in the **Find** search box of the **History** pane.
  - Click **Select All** to select all documents in the **History** pane.
  - Click **Collapse All/Expand All** to collapse/expand all groups of documents in the **History** pane.
  - Click **Remove** to remove selected documents from the **History** pane.
  - Click **Clear** to remove specified documents from the **History** pane.
  - Click **History and Recents Options** to manage options for the document history and recent documents. The **Manage History and Recents** dialog box will open, as detailed [here](#).<sup>777</sup>
-



10.4.3.1.18 Properties Pane



Properties Pane

Click **Properties Pane** (or press Ctrl+') to open the **Properties** pane:

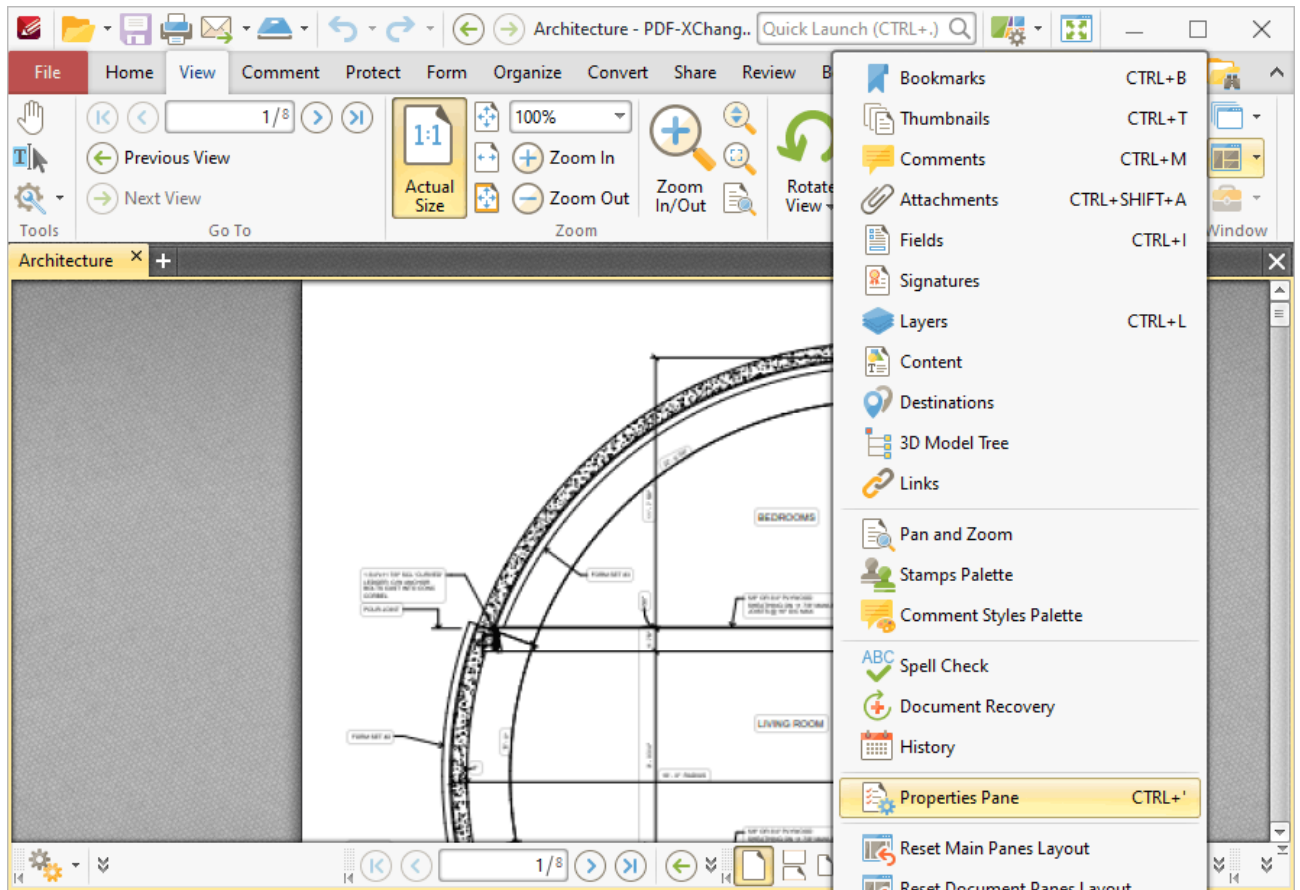

Figure 1. Edit Tab Submenu. Properties

This pane displays the properties of selected document content:

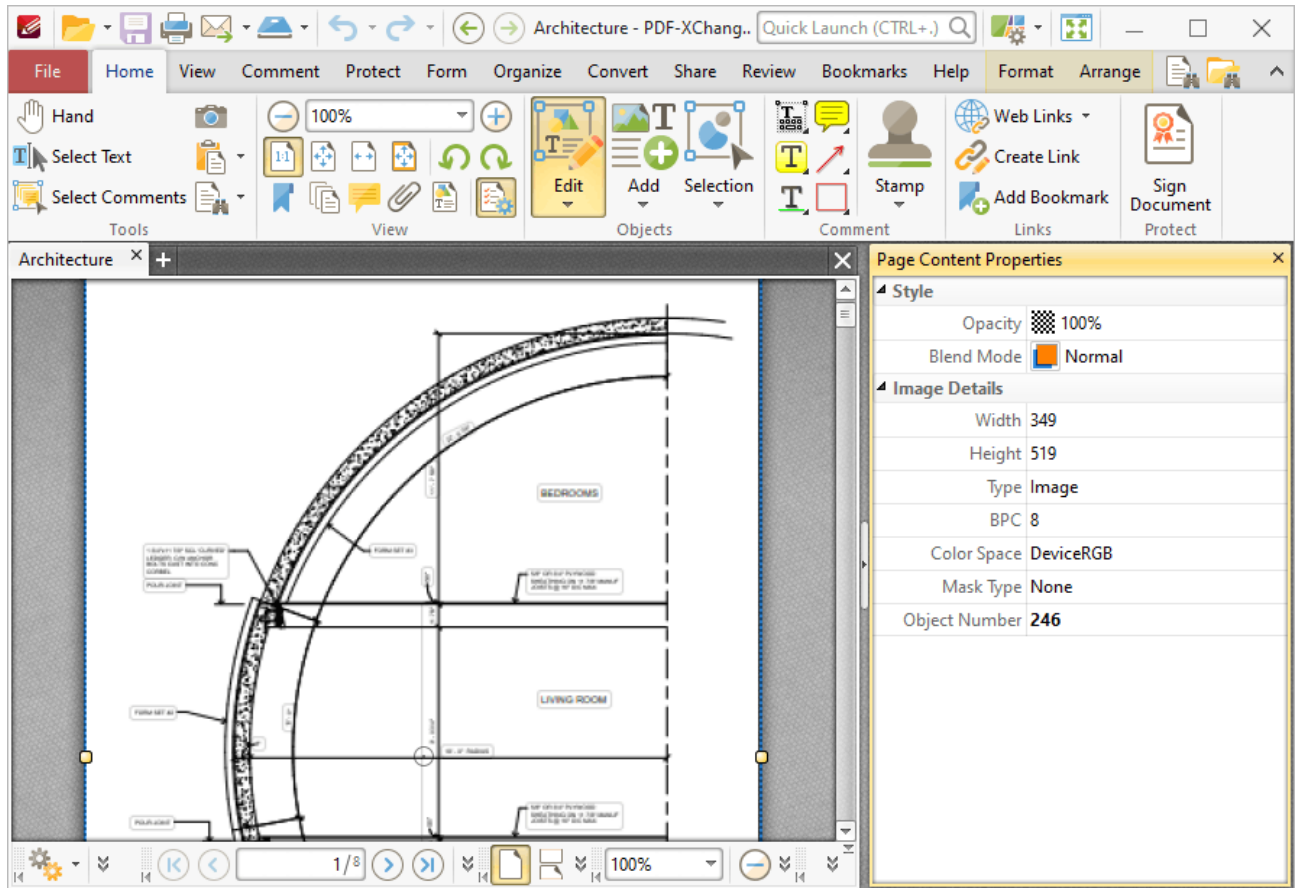

Figure 2. Properties Pane

Click properties in the **Properties** pane to edit them as desired. (Please note that not all properties can be edited). Definitions of tool and comment properties are detailed [here](#).

### 10.4.3.2 Zoom In/Out Tool



## Zoom In/Out Tool

Click **Zoom In/Out Tool** to enable this tool:

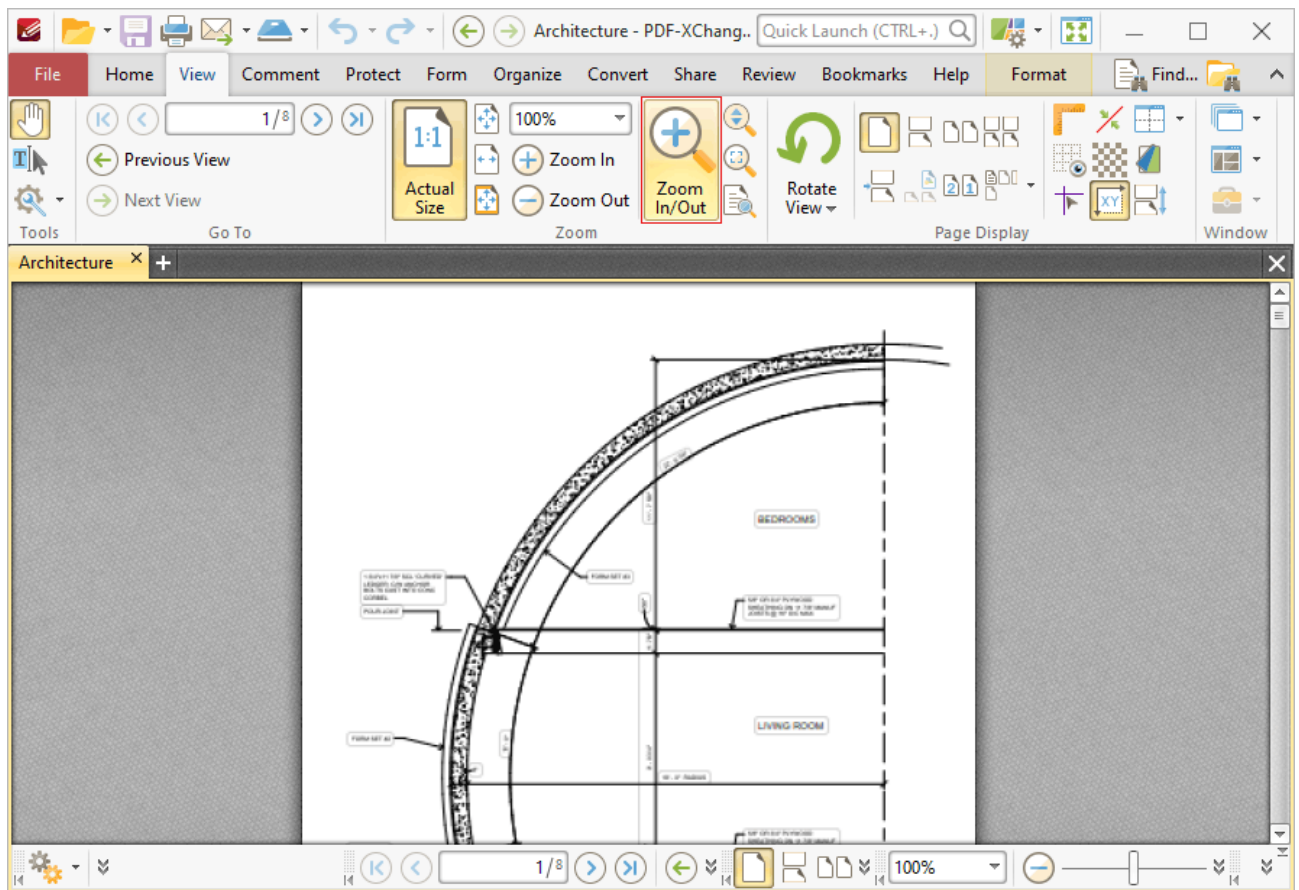

Figure 1. Tools Tab Submenu. Zoom In/Out Tool

The **Zoom In/Out Tool** is used to adjust the zoom level. When it is selected the pointer becomes a magnifying glass icon. Click to zoom to the location at which the icon is located. Hold Ctrl and click to zoom out. Alternatively, click and drag the pointer to determine an area. The **Zoom In/Out Tool** will move the current view to the area specified when the mouse button is released.

10.4.3.3 Loupe Tool



**Loupe Tool**

Click **Loupe Tool** to enable this tool:

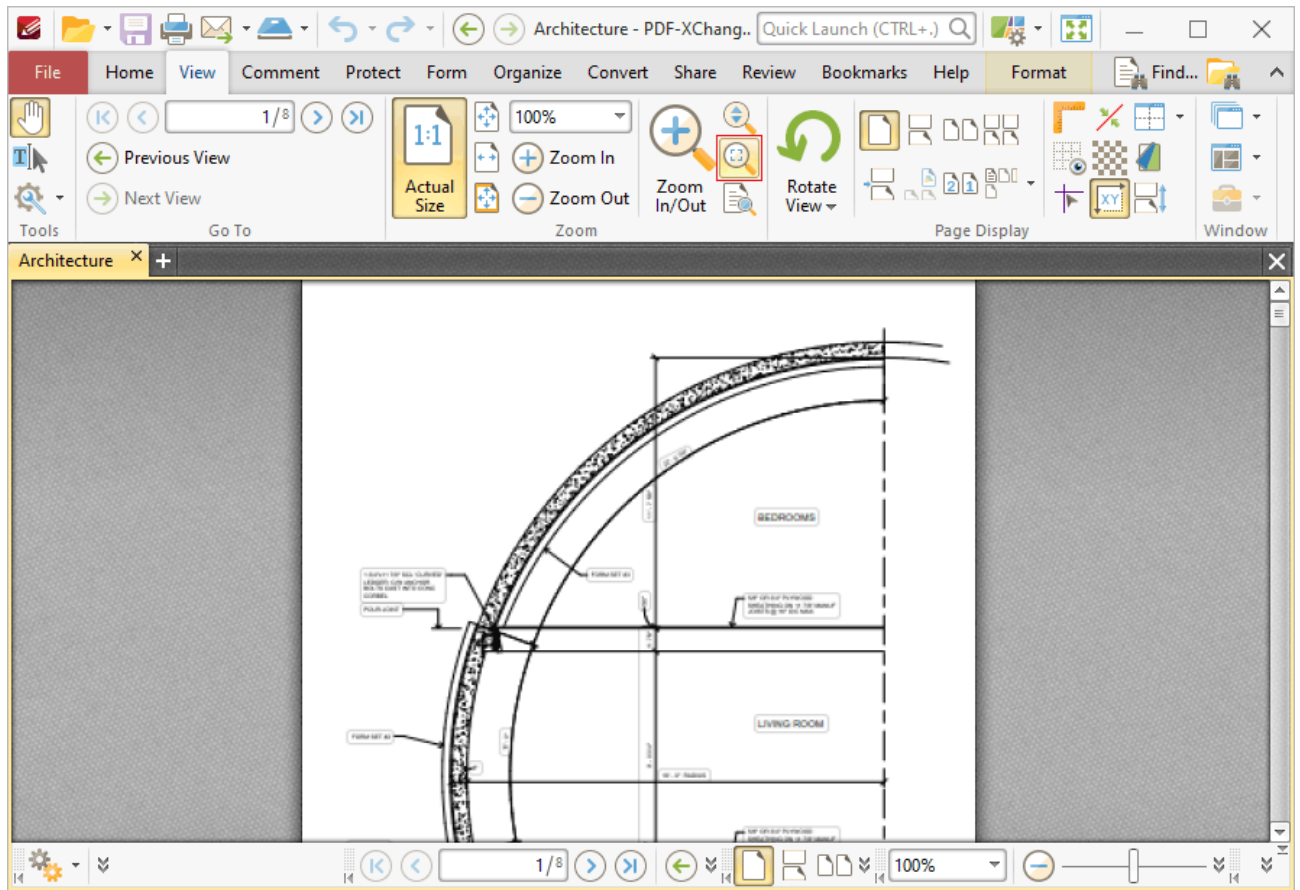

Figure 1. View Tab, Loupe Tool

The **Loupe Tool** is used to assist in the editing of PDF documents and to examine documents in closer detail. When the **Loupe Tool** is enabled, the **Loupe** box is displayed in the current document. The content of the **Loupe** box determines the content of the **Loupe** window:

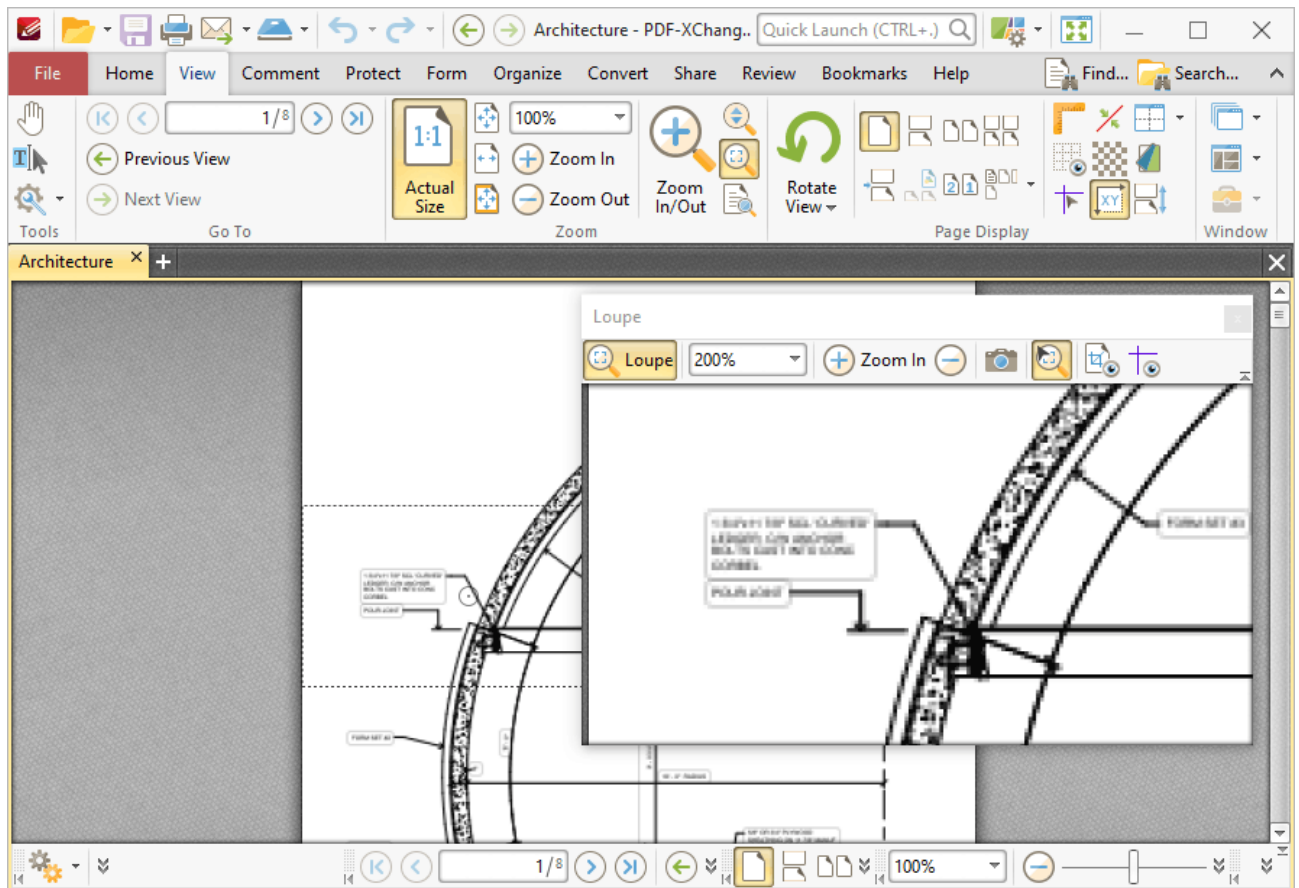

Figure 2. Active Loupe Tool

- Adjust the size of the **Loupe** window to determine the proportions of the **Loupe** box.
- Use the zoom number box in the **Loupe** window toolbar, or the plus and minus icons, to determine the level of zoom displayed in the window.
- Click the camera icon in the loupe window toolbar to take a snapshot of the current view. A bitmap copy of the selection will be pasted to the clipboard.
- Click the track mouse icon in the loupe window toolbar to enable/disable the **Track Mouse** feature. When this feature is enabled the **Loupe Tool** will follow the pointer. Disable this feature to adjust the size of the **Loupe** box as a standard content item.
- Click the **Show Page Boxes** icon to show/hide page boxes. Page boxes determine the content and appearance of PDF documents, especially with regards to printing. Further information on page boxes is available [here](#).<sup>1770</sup>
- Click and drag the loupe window to reposition it on the screen. When the mouse button is clicked, four icons will appear in the center of the borders of the main window. Move the pointer onto these icons and release the mouse button to dock the loupe window.

10.4.3.4 Pan and Zoom



Pan and Zoom

Click **Pan and Zoom** to enable the **Pan and Zoom** window:

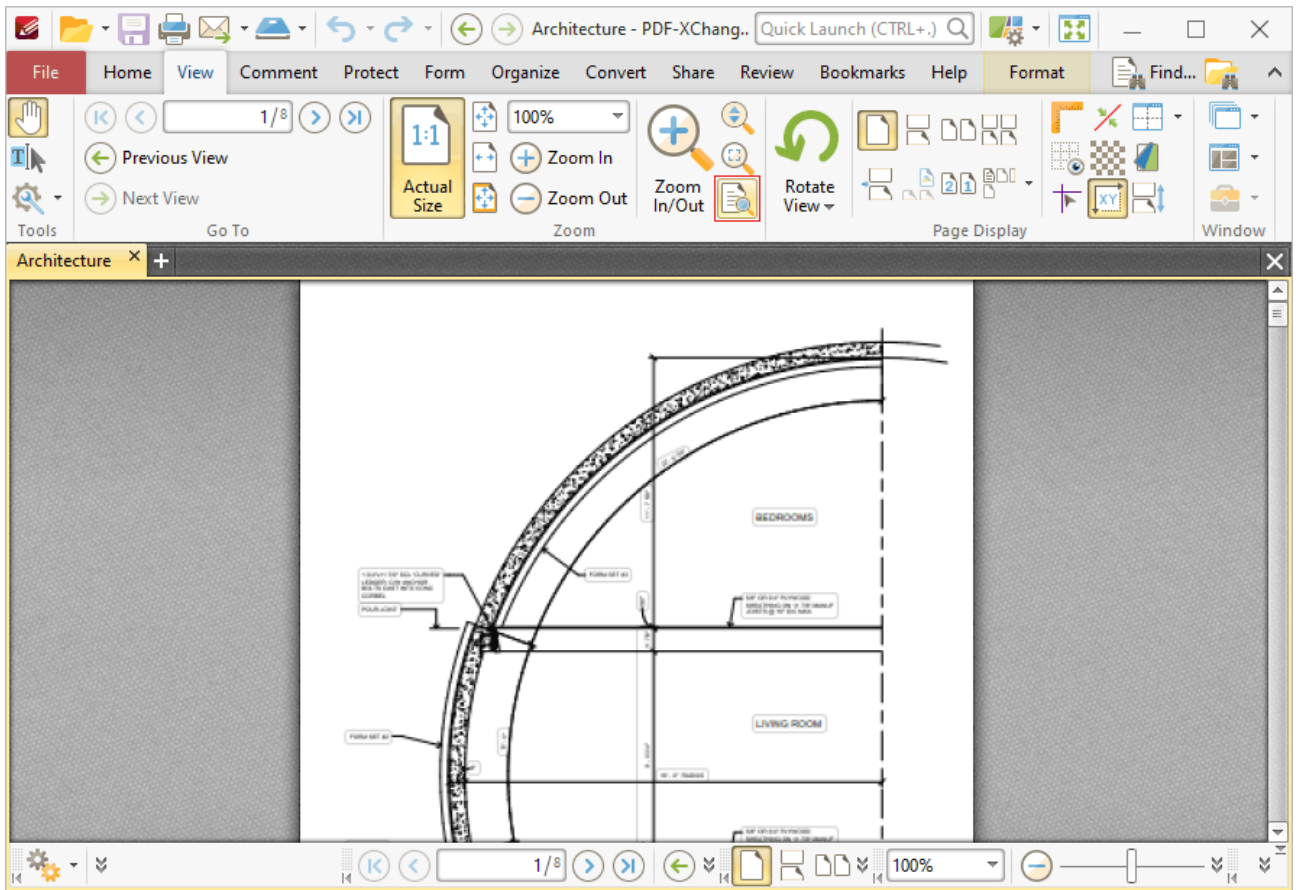
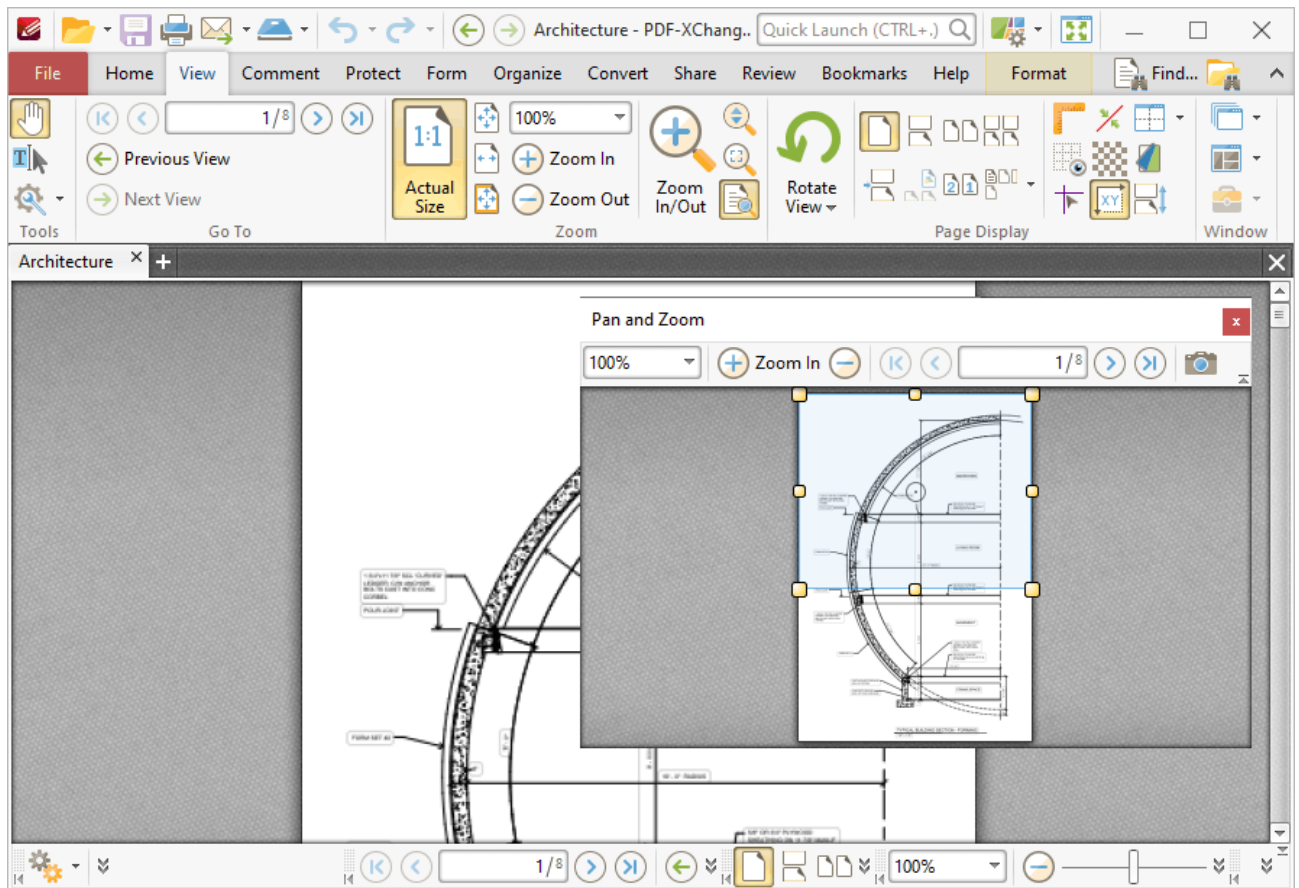

Figure 1. View Tab, Pan and Zoom

The **Pan and Zoom** window is used to navigate and zoom in on/out from documents:



**Figure 2.** Pan and Zoom Window

- The blue rectangle determines the current view in the main window. Click and drag the rectangle to adjust the current view.
- Adjust the yellow control points to manipulate the pan and zoom. Alternatively, use the plus and minus icons in the toolbar to zoom incrementally, or enter a zoom level in the number box.
- Use the arrow icons in the **Pan and Zoom** toolbar to move between document pages.
- Click the camera icon in the **Pan and Zoom** toolbar to take a snapshot of the current view. A bitmap copy of the selection will be pasted to the clipboard.
- Click and drag the **Pan and Zoom** window to reposition it on the screen. When it is selected, four icons will appear in the center of the borders of the main window. Move the pointer onto these icons and release the mouse button to dock the **Pan and Zoom** window.

10.4.3.5 Page Transitions



Page Transitions

Click **Page Transitions** to determine how **PDF-XChange Editor** moves through pages in full screen mode:

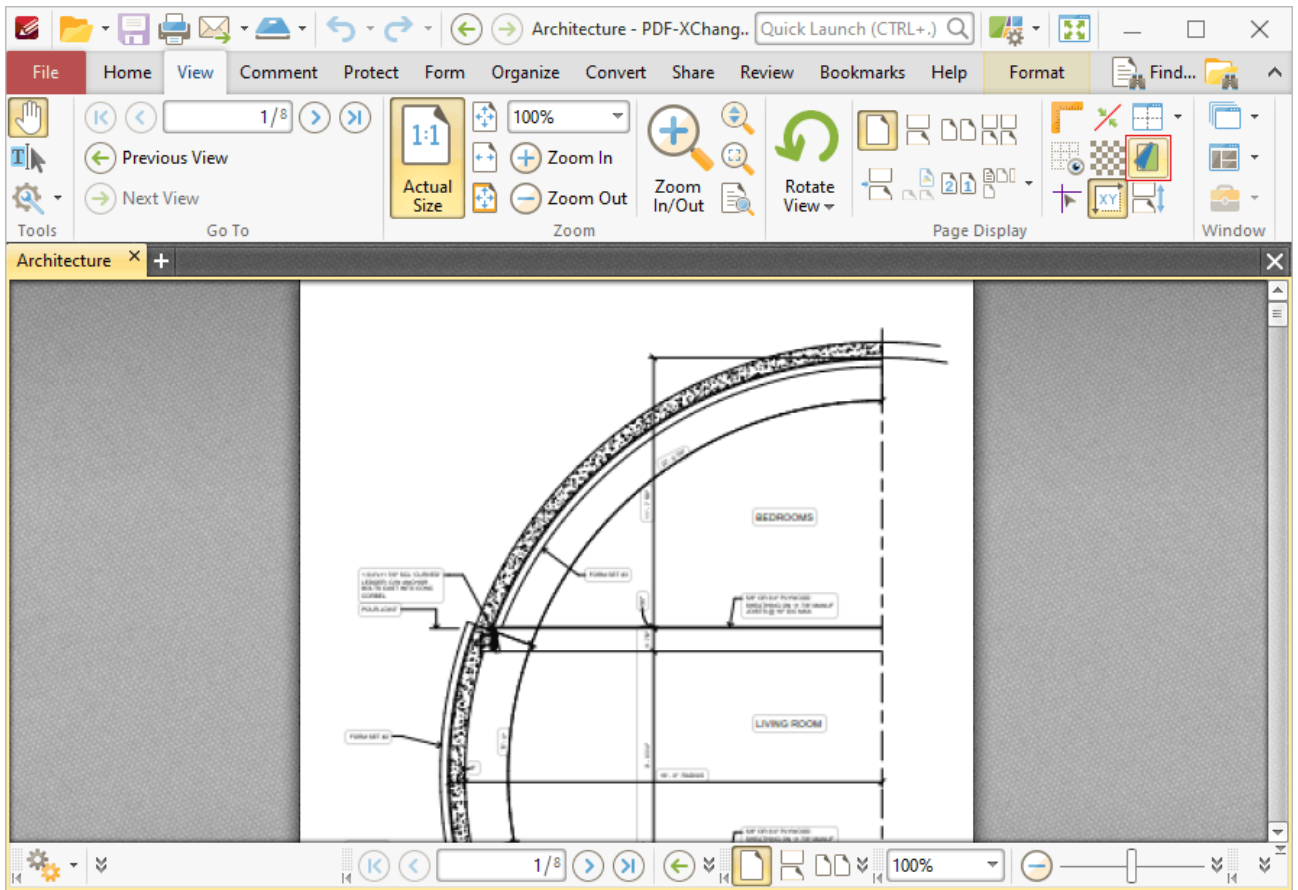

Figure 1. View Tab, Page Transitions

The **Page Transitions** dialog box will open:



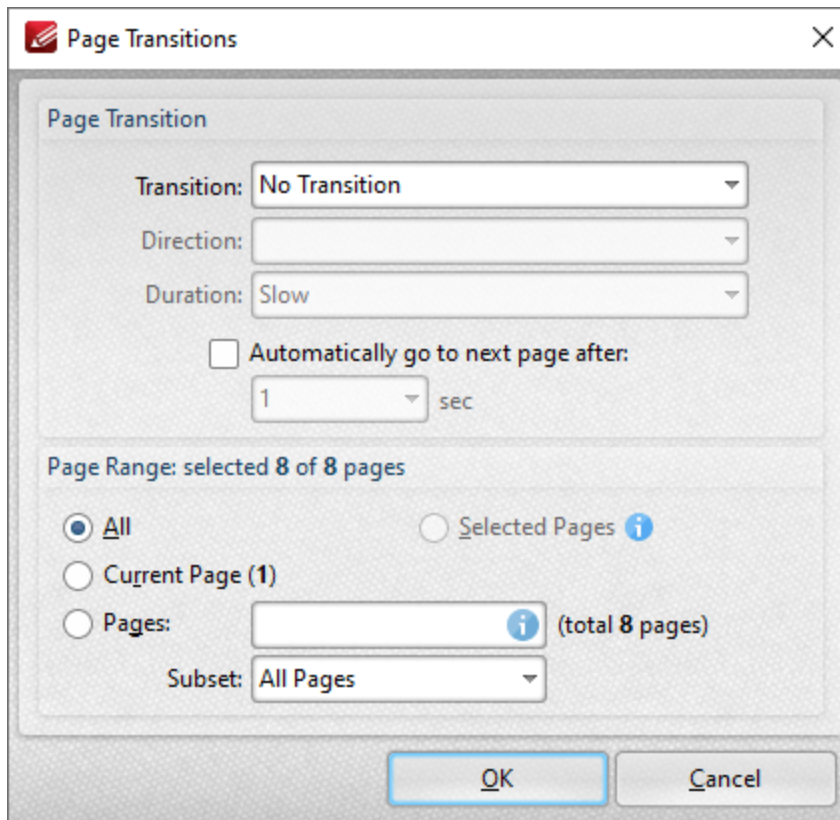

Figure 2. Page Transitions Dialog Box

Use the **Page Transition** settings to determine transition parameters:

- Use the **Transition** dropdown menu to determine the transition style.
- Use the **Direction** dropdown menu to determine the direction of transitions.
- Use the **Duration** dropdown menu to determine the rate of transitions.
- Select the check box to move automatically through pages, then select an option from the dropdown menu to set an automatic scrolling rate.

Use the **Page Range** settings to determine the page range to which the specified transition settings apply:

- Select **All** to specify all pages.
- Select **Current Page** to specify the current page.
- Select **Selected Pages** to specify the pages selected in the [Thumbnails](#) pane.
- Select **Pages** to specify a custom page range. Further information on the specification of page ranges is available [here](#). Use the **Subset** dropdown menu to specify a subset of page ranges. Select **All Pages**, **Odd Pages Only** or **Even Pages Only** as desired.

Click **OK** to save settings.



10.4.3.6 Rulers, Guides and Grid



**Rulers, Guides and Grid**

These features are used to assist in the accurate placement and measurement of document content.

**Rulers**

Click the **View** tab, then click **Show Rulers** to enable/disable rulers:

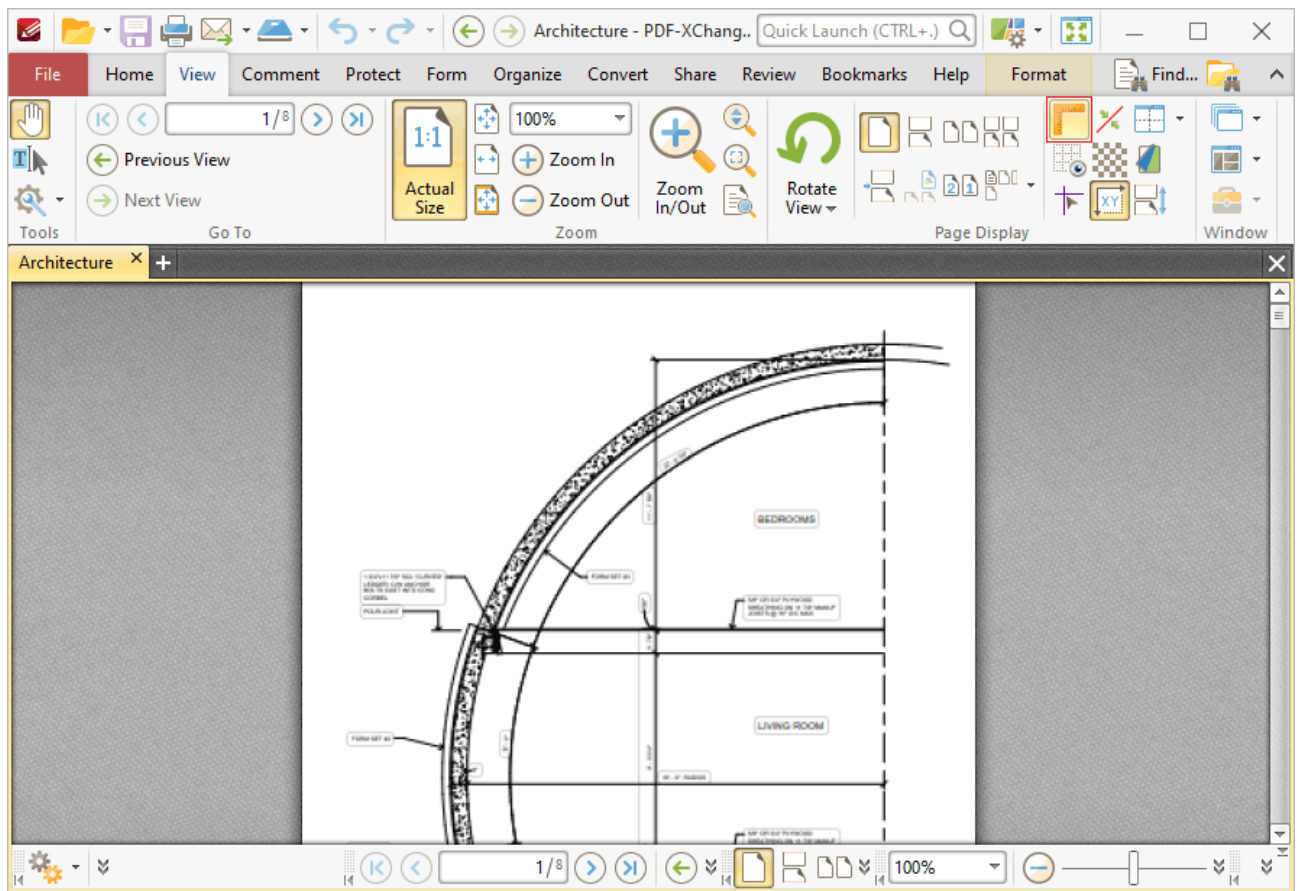

Figure 1. View Tab, Show Rulers

Rulers will then be displayed in the main window:

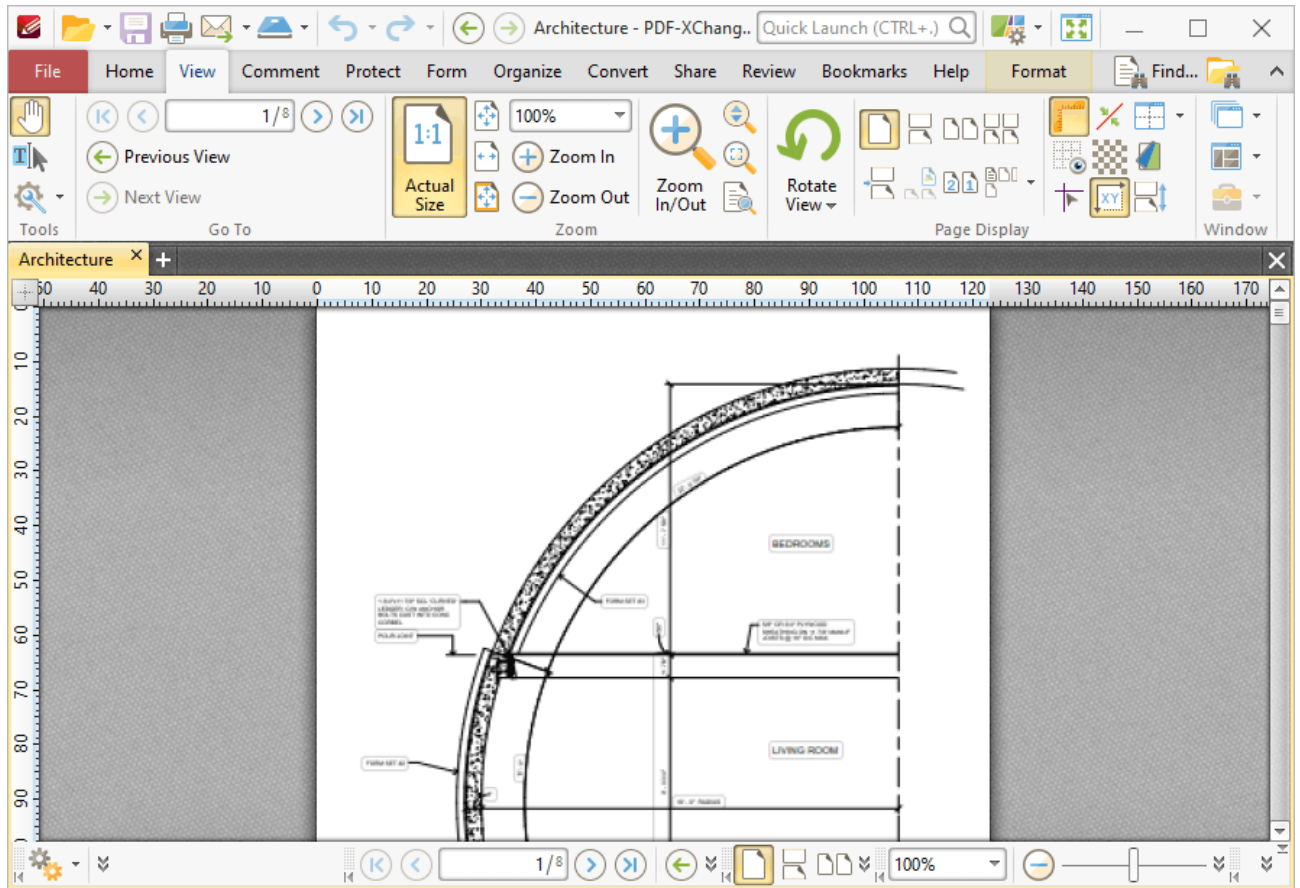

Figure 2. View Tab, Show Page Size/Position Feature and Output Highlighted

Note that the units of measurement used for rulers can be specified in the [Measurement](#) preferences.

## Guides

Guides are used to assist in the accurate placement of document content.

Click the **View Tab**, then click **Show Guides** to enable/disable guides:

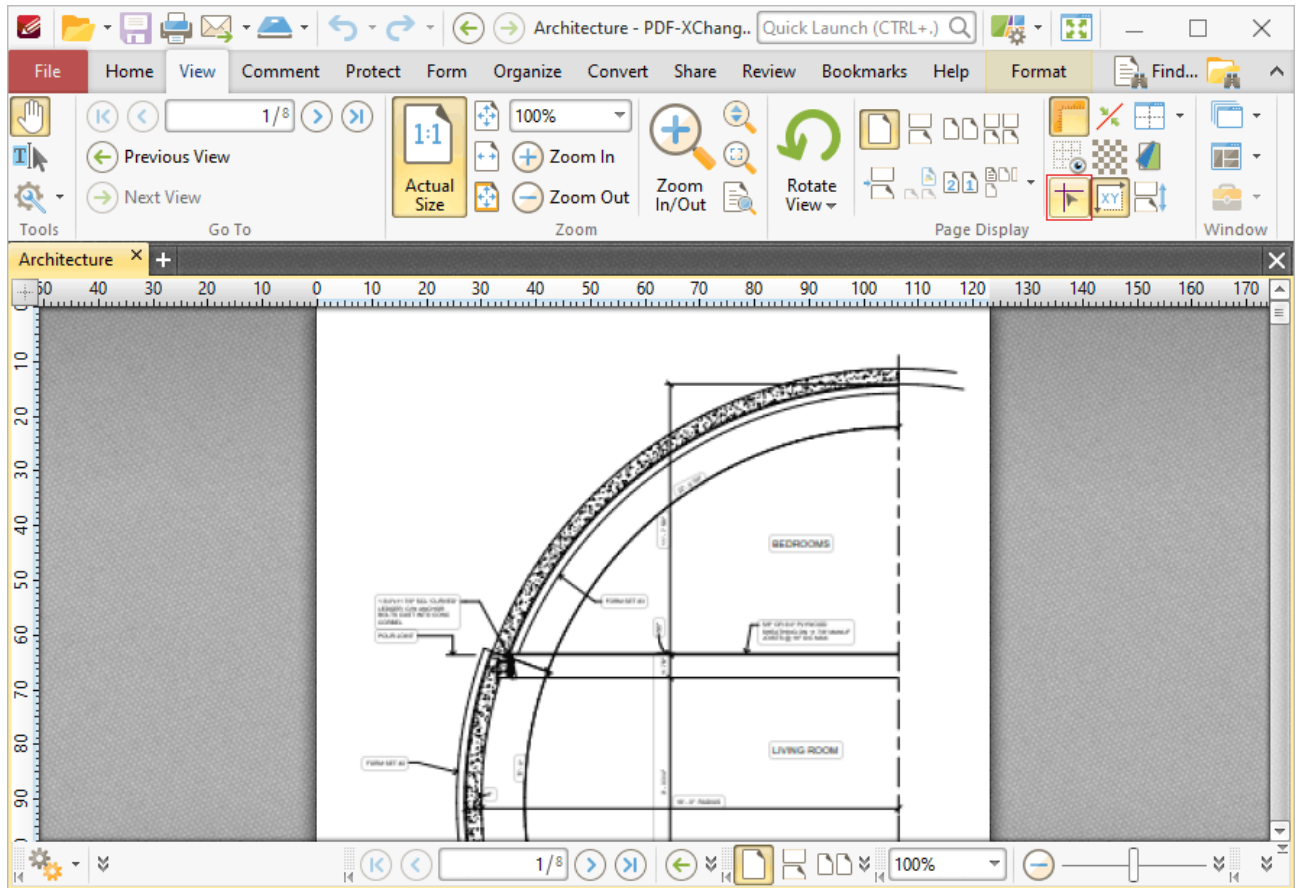

Figure 3. View Tab, Show Guides

When guides are enabled, click and drag from rulers to add guide lines to the document:

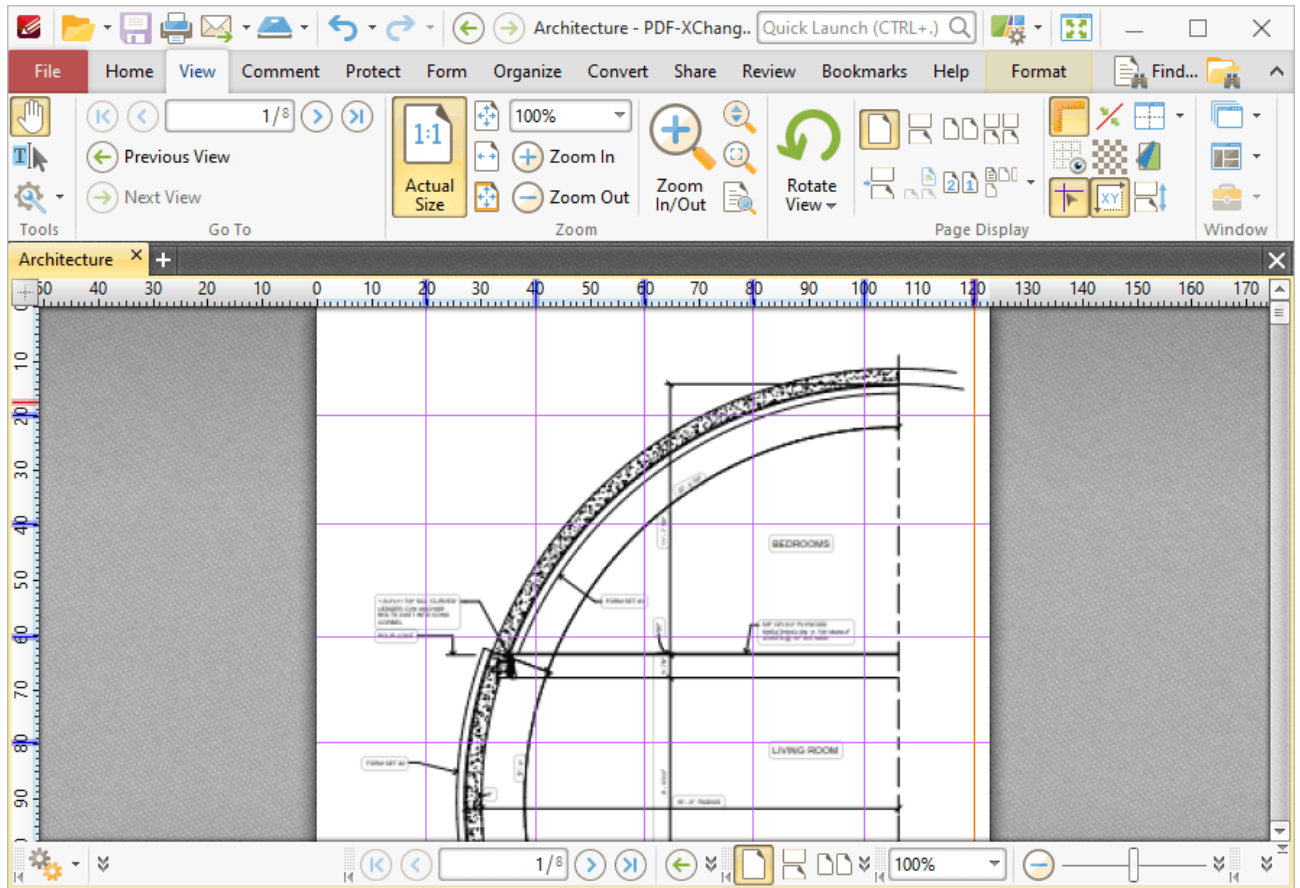

Figure 4. View Tab, Guides Added

Right-click rulers for additional options:

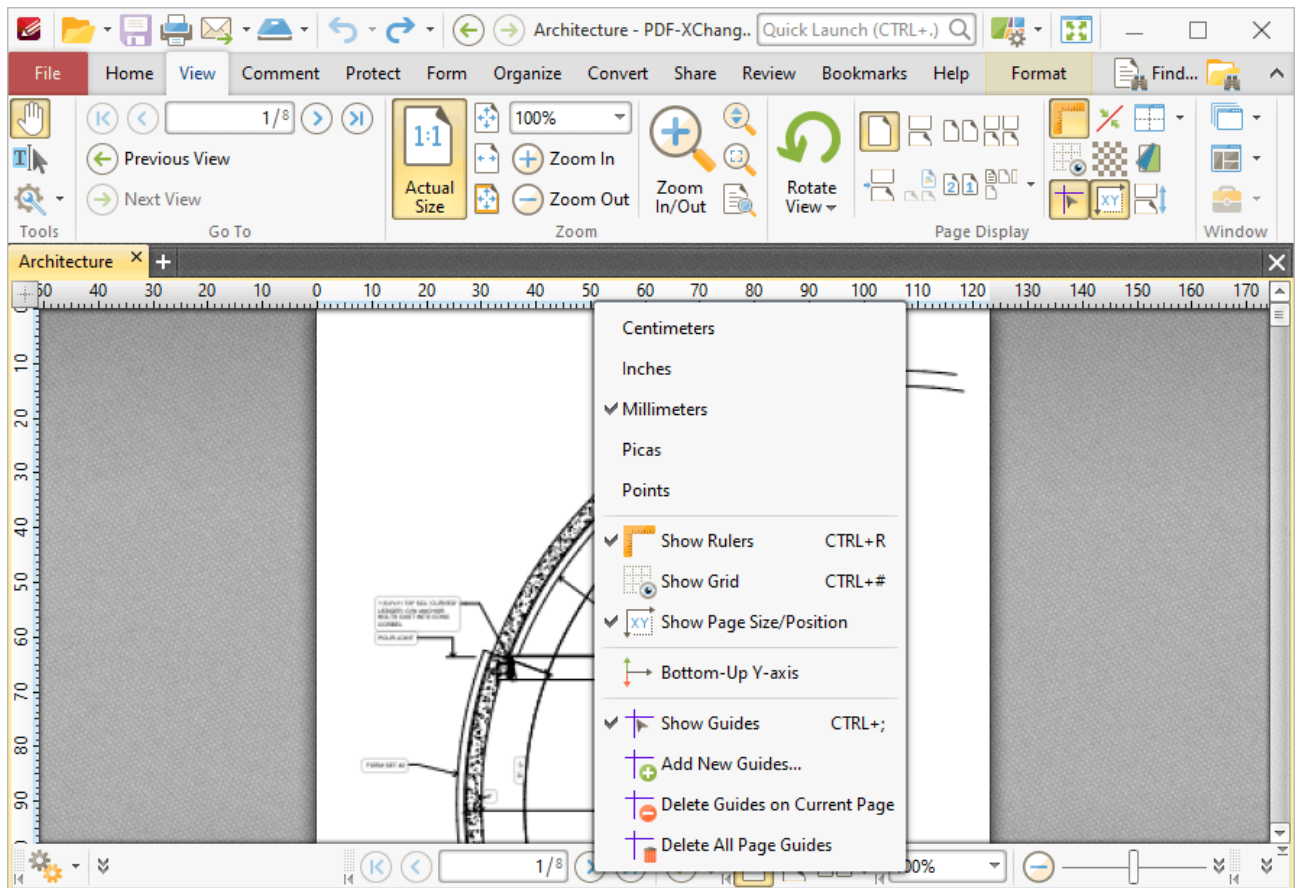

Figure 5. Rulers Right-Click Shortcut Menu

- Click **Centimeters**, **Inches**, **Millimeters**, **Picas** or **Points** to determine the units of measurement that rulers use.
- Click **Show Rulers** to show/hide rulers.
- Click **Show Grid** to show/hide the grid, as detailed below.
- Click **Show Page Size/Position** to show/hide the current page size and pointer location. These details are displayed in the **Document Options** toolbar, which is in the lower-left section of the user interface.
- Click **Bottom Up Y-axis** to enable/disable the displaying of units in the y-axis from the bottom of the UI.
- Click **Show Guides** to show/hide guides that have been created as detailed above.
- Click **Add New Guides** to add new guides to documents. This feature allows you to add guides to multiple pages of documents. When it is selected, the **Add Page Guides** dialog box will open, as detailed below.
- Click **Delete Guides on Current Page** to delete guides from the current page.
- Click **Delete All Page Guides** to delete all page guides from the current document.

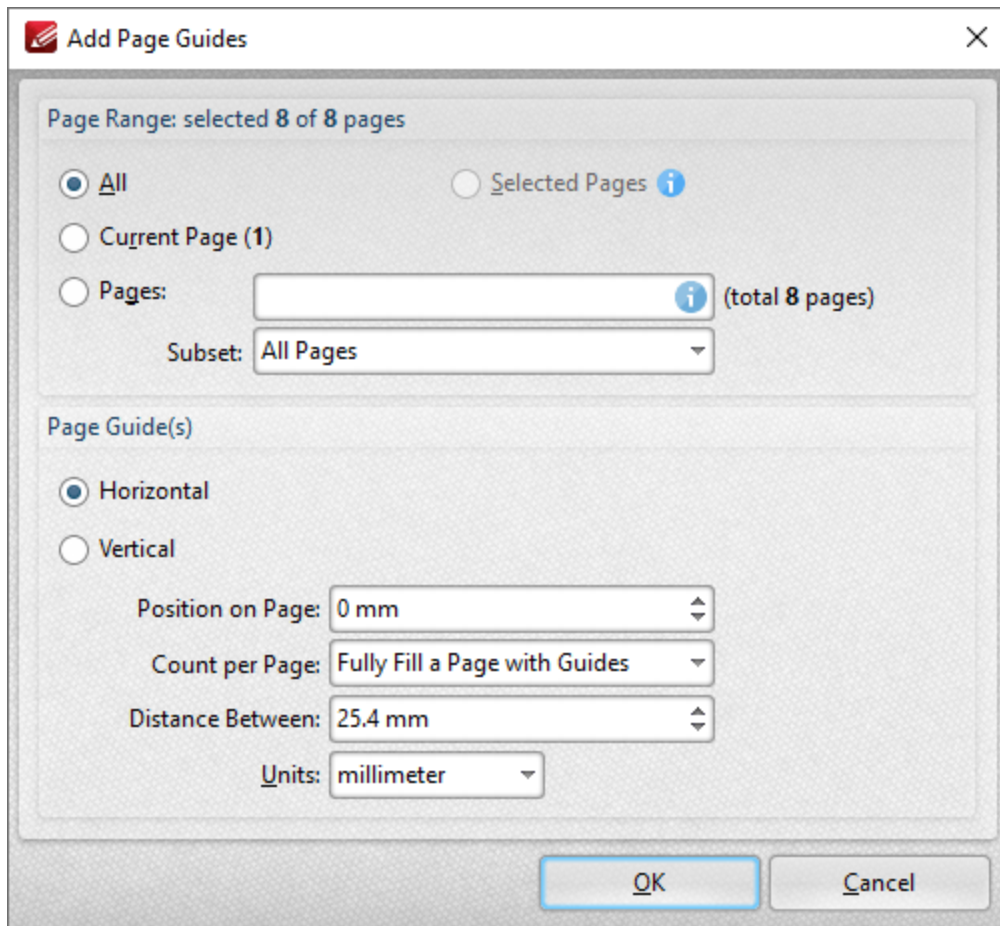

Figure 6. Add Page Guides Dialog Box

- Use the **Page Range** options to determine the pages to which new guides are added, as detailed [here](#).
- Select **Horizontal** or **Vertical** to specify the type of guides you want to add to the document.
- Use the **Position on Page** dropdown menu to determine the position at which the guides are added.
- Use the **Count per Page** dropdown menu to determine how many guides are added to each page.
- Use the **Distance Between** dropdown menu to determine the distance between each guide.
- Use the **Units** dropdown menu to determine the units used in the **Distance Between** dropdown menu.

Click **OK** to add page guides to the document.

## Grid

When the grid is enabled it is interposed on the current document and can be used to ensure that content is placed on the same horizontal/vertical plane. Click the **View Tab**, then click **Show Grid** to enable/disable the grid:



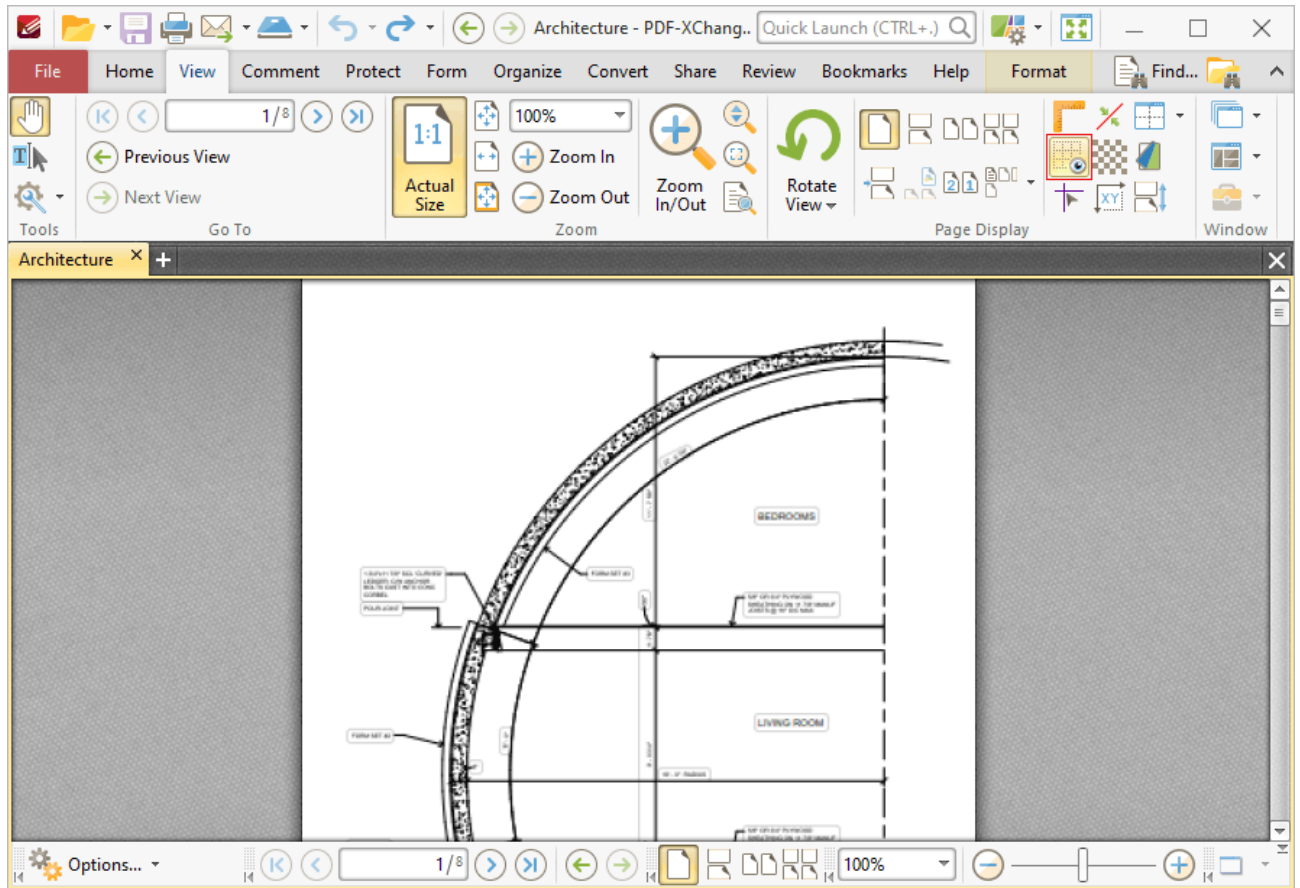

Figure 7. View Tab, Show Grid Highlighted and Grid Enabled

### 10.4.4 Comment Tab



## Comment Tab

When the **Comment** tab is selected, the following options are available:

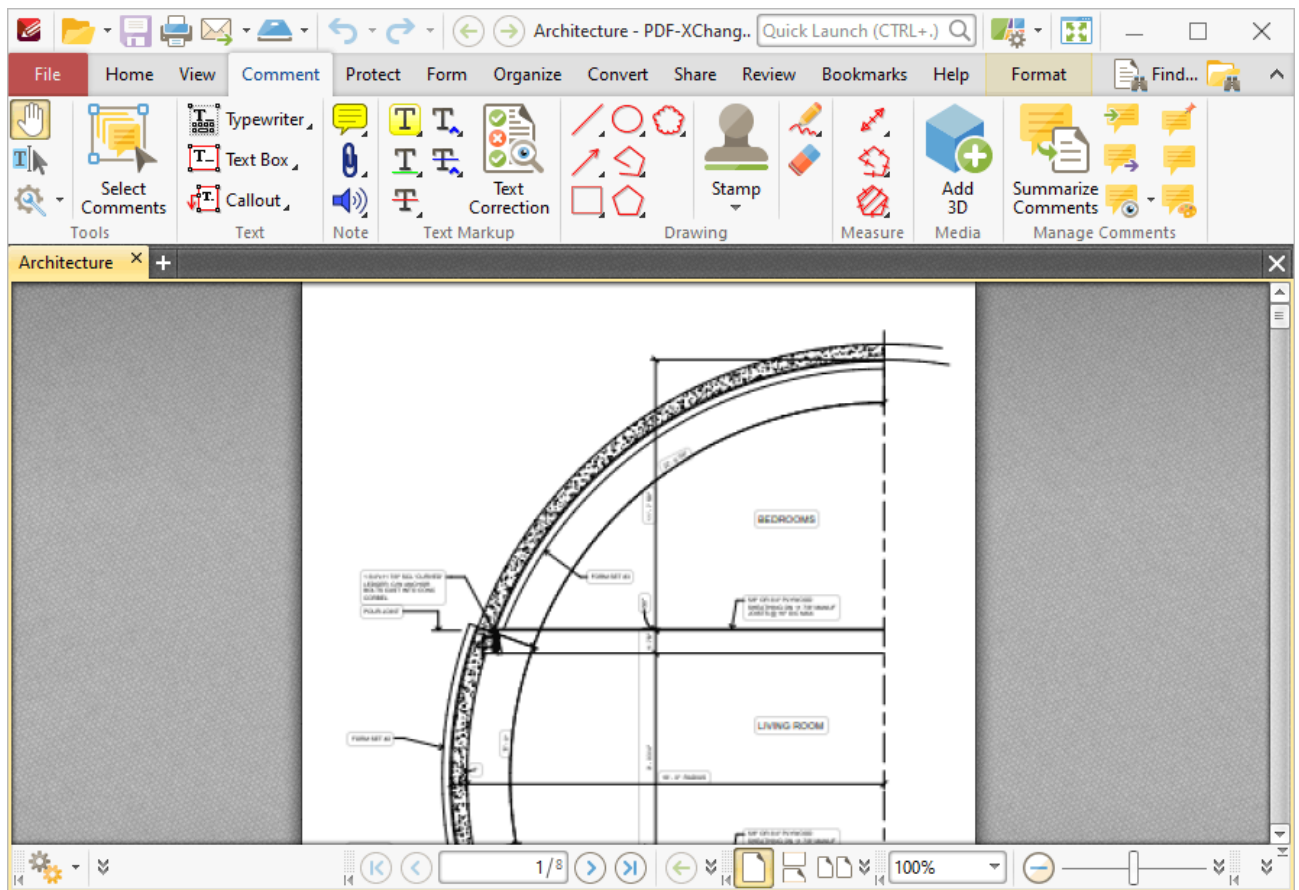
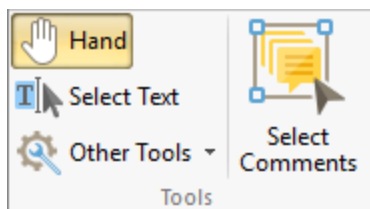

Figure 1. Comment Tab

Comments are a convenient and customizable way to markup and annotate documents. There are seven groups in the **Comments** tab:

### Tools

The **Tools** group contains shortcuts to tools and other features:



- The **Hand Tool** is used as a basic scrolling device and navigation aid when browsing through documents. Click to enable the **Hand Tool**, then click and drag the page in the desired scrolling direction in order to browse through documents. Further information about the **Hand Tool** and its settings is available [here](#).<sup>[943]</sup>
- The **Select Text Tool** is used to select base-content text. Click to enable the **Select Text Tool**, then click and drag the pointer to select text. Double-click to select words, triple-click to select paragraphs and quadruple-click to select all text on the current page. Right-click selections for editing options, as detailed [here](#).<sup>[1651]</sup> Please note that when text is copied from PDF documents and pasted into applications/locations outside of **PDF-XChange Editor** (such as **Microsoft Word**) additional page breaks may appear. This is a recognized issue with PDF documents. The [Edit Content Tool](#).<sup>[1638]</sup> should be used instead of the **Select Text Tool** in order to avoid this issue when copying text. When the **Edit Content Tool** is enabled, select text and then press Ctrl+C to copy it.
- Click the **Other Tools** dropdown menu to view/select additional tool options:
  - The **Select Comments Tool** is used to select and edit comments. Click to enable the **Select Comments Tool**, then click to select comments. Click and drag to select multiple comments. Selected comments can be edited, as detailed [here](#).<sup>[1087]</sup>
  - The **Snapshot Tool** is used to take screenshots of pages/selected page content. Click to enable the **Snapshot Tool**, then click or click and drag to take snapshots. Customizable options are available for the **Snapshot Tool** in the **Snapshot Tool** preferences, which are detailed [here](#).<sup>[926]</sup> Instructions on how to print snapshots are available [here](#).<sup>[728]</sup>
  - The options in the **Clipboard** dropdown menu is used to interact with the current content of the clipboard. Click the dropdown menu to cut/copy/paste clipboard content.
  - The **Find** feature is used to [Find](#).<sup>[1688]</sup> or [Search](#).<sup>[1776]</sup> text, or to search the internet for text selected with the **Select Text Tool** in the current document.
- Click **Select Comments** to select comments for editing purposes. Further information on this tool is available [here](#).<sup>[1087]</sup>

## Text

The **Text** group contains options for adding annotations that include text to documents:

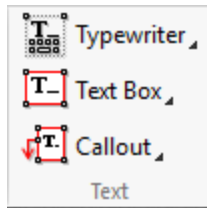

- Click **Typewriter Tool** to add typewriter-style annotations to documents. Further information about this tool is available [here.](#)<sup>1089</sup>
- Click **Text Box Tool** to add text boxes to documents. Further information about this tool is available [here.](#)<sup>1094</sup>
- Click **Callout Tool** to add callout annotations to documents. These annotations are similar to text box annotations, but they also include an arrow that can be used to highlight a specific location documents. Further information about this tool is available [here.](#)<sup>1099</sup>

## Note

The **Note** group contains options for adding note-style annotations to documents:

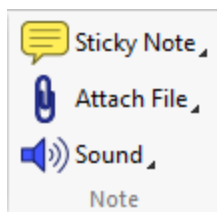

- Click **Sticky Note Tool** to add sticky note annotations to documents, as detailed [here.](#)<sup>1105</sup>
- Click **Attach File Tool** to attach files to documents and add an icon that can be clicked to open the attachment, as detailed [here.](#)<sup>1110</sup>
- Click **Sound Tool** to add audio content to documents, as detailed [here.](#)<sup>1115</sup>

## Text Markup

The **Text Markup** group contains options for updating document text:



- Click **Highlight Text Tool** to highlight text, as detailed [here.](#)<sup>1120</sup>
- Click **Underline Text Tool** to underline text, as detailed [here.](#)<sup>1125</sup>
- Click **Strikeout Text Tool** to strikeout text, as detailed [here.](#)<sup>1130</sup>

- Click **Insert Text Tool** to add a caret annotation that indicates text should be inserted, as detailed [here.](#)<sup>1135</sup>
- Click **Replace Text Tool** to add a caret annotation that indicates text should be replaced, as detailed [here.](#)<sup>1141</sup>
- Click **Text Correction** to perform text correction on documents, as detailed [here.](#)<sup>1147</sup>

## Drawing

The **Drawing** group contains options for adding annotations to documents:

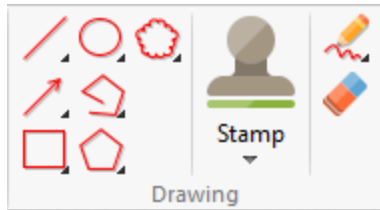

- Click the **Line** tool to add line annotations to documents, as detailed [here.](#)<sup>1149</sup>
- Click the **Arrow** tool to add arrow annotations to documents, as detailed [here.](#)<sup>1149</sup>
- Click the **Rectangle** tool to add rectangle annotations to documents, as detailed [here.](#)<sup>1162</sup>
- Click the **Oval** tool to add oval annotations to documents, as detailed [here.](#)<sup>1167</sup>
- Click the **Polygon Line** tool to add polygon line annotations to documents, as detailed [here.](#)<sup>1172</sup>
- Click the **Polygon** tool to add polygon annotations to documents, as detailed [here.](#)<sup>1178</sup>
- Click the **Stamp** tool to add stamps to documents, as detailed [here.](#)<sup>1188</sup>
- Click the **Pencil** tool to add freehand annotations to documents, as detailed [here.](#)<sup>1201</sup>
- Click the **Eraser** tool and then click and drag to erase pencil tool annotations.

## Measure

The **Measure** group contains options for measuring documents:

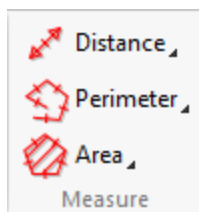

- Click the **Distance** tool to measure the distance between two points in documents and insert annotations that display the distance measured, as detailed [here.](#)<sup>1208</sup>
- Click the **Perimeter** tool to measure the distance between multiple points and insert annotations that display the distance measured, as detailed [here.](#)<sup>1214</sup>
- Click the **Area** tool to measure the area within user-specified polygons, as detailed [here.](#)<sup>1219</sup>

## Media

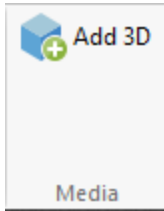

Click **Add 3D** to add 3D annotations to documents, as detailed [here](#).<sup>1228</sup>

## Manage Comments

The **Manage Comments** group contains editing options for comments:

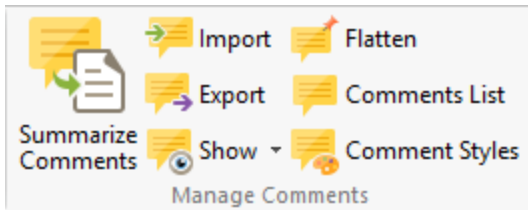

- Click **Summarize Comments** to create a comment summary, as detailed [here](#).<sup>1231</sup>
- Click **Import** to import comments from file, as detailed [here](#).<sup>1234</sup>
- Click **Export** to export comments to file, as detailed [here](#).<sup>1236</sup>
- Click the **Show** dropdown menu to determine which comments are shown/hidden, as detailed [here](#).<sup>1237</sup>
- Click **Flatten** to flatten comments to base content, as detailed [here](#).<sup>1239</sup>
- Click **Comments List** to open/close the [Comments](#)<sup>1007</sup> pane.
- Click **Comment Styles** to open the **Comment Styles Palette** and edit comment styles, as detailed [here](#).<sup>1242</sup>

Additionally, please note that several of the keyboard shortcuts relate to comments. See [here](#)<sup>1691</sup> for a comprehensive list of available shortcuts.

---

10.4.4.1 Select Comments



Select Comments

Click **Select Comments** to enable the **Select Comments** tool:

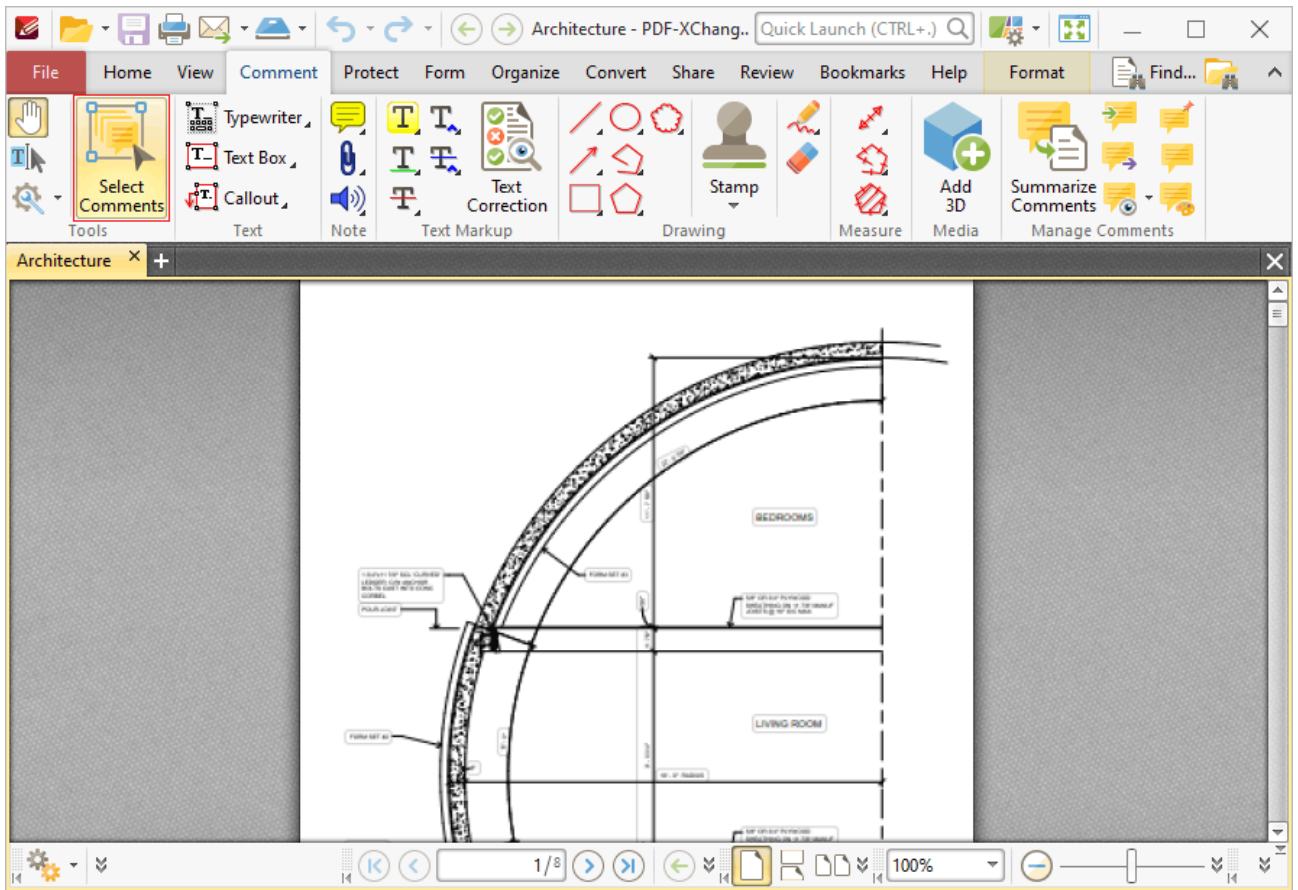

Figure 1. Comment Tab, Select Comments

This tool is used to select comments for editing. Click to select comments, or click and drag to select multiple comments:

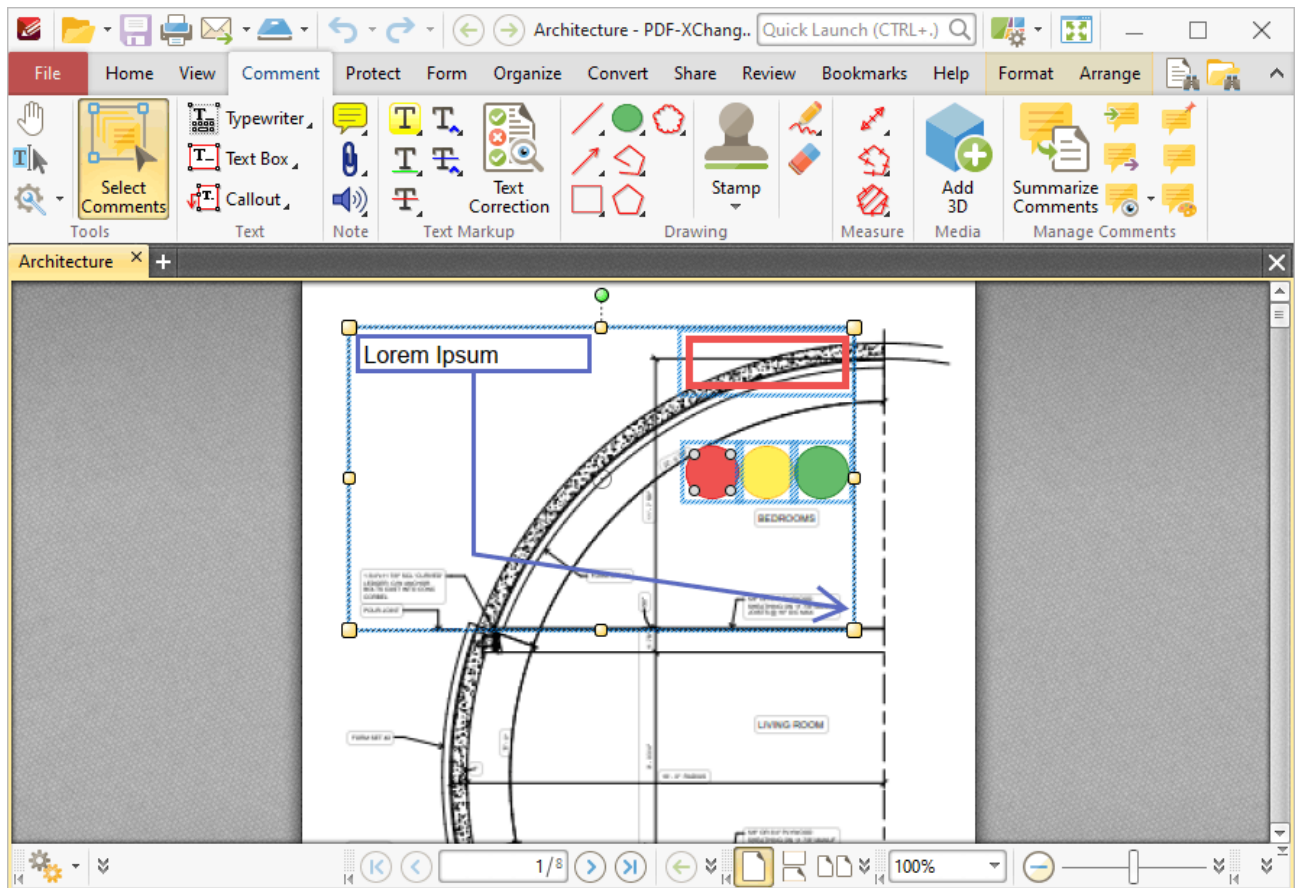

Figure 2. Select Comments, Group Select

- Click and drag control points to resize comments.
- Click and drag comments to reposition them. The circle at the center can also be used for this purpose.
- Click and drag the green control point at the top to rotate comments. Hold down Shift to rotate at increments of fifteen degrees.
- Use the arrow keys to reposition comments.
- Use the editing aids detailed [here](#)<sup>1075</sup> to assist in the precise placement of comments.
- Press Ctrl+' to open the [Properties](#)<sup>1065</sup> pane and view/edit the properties of selected comments. Note that the subject and author properties can be updated for multiple selected comments simultaneously.
- Right-click comments to enable further options. See [here](#)<sup>1783</sup> for an explanation of these options.
- The [Commenting](#)<sup>875</sup> preferences can be used to view/edit preferences for comments.
- When customized [Comment Styles](#)<sup>1242</sup> have been created it is possible to switch between styles when comments are selected.



10.4.4.2 Typewriter Tool



**Typewriter Tool**

Click **Typewriter** to add typewriter-style text comments to documents:

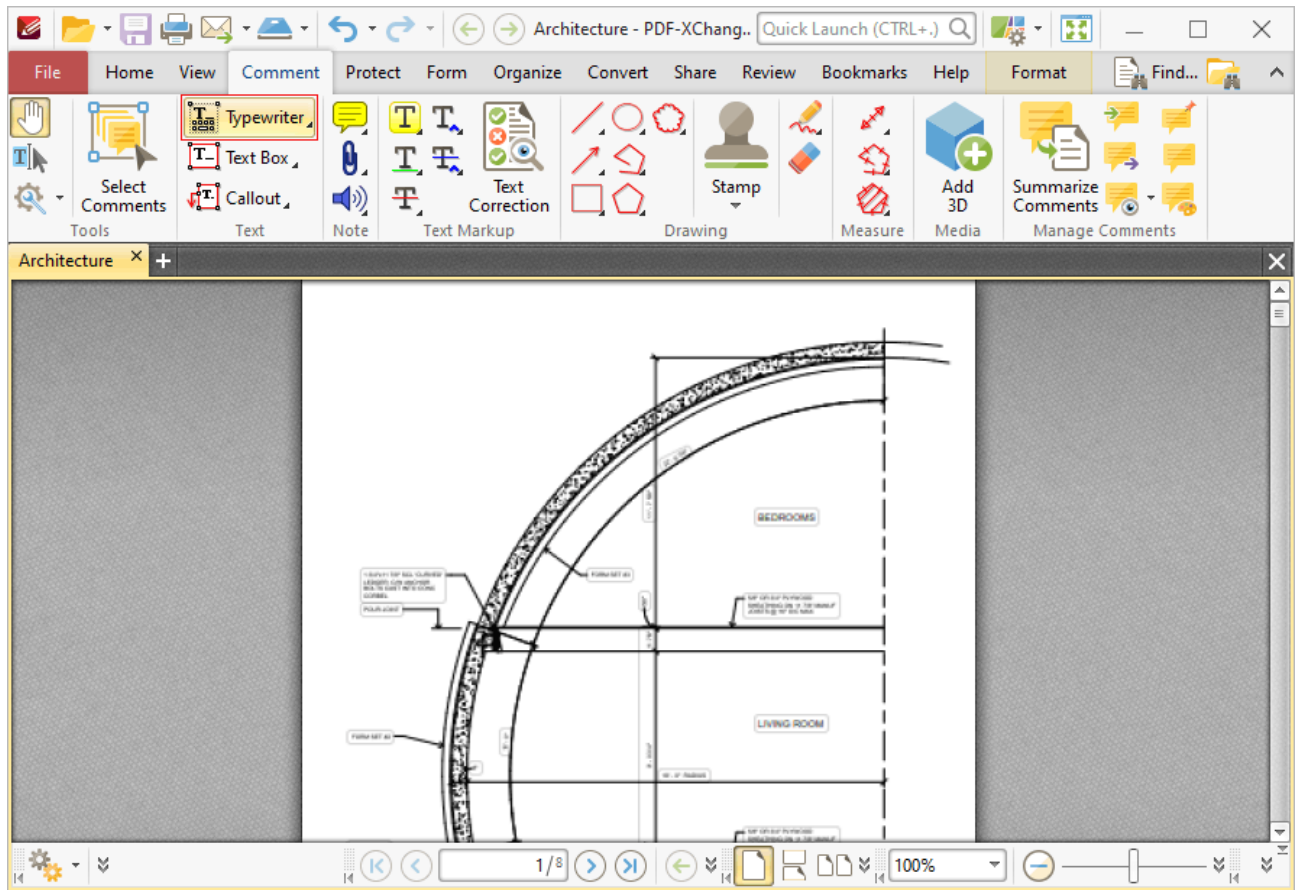

**Figure 1.** Comment Tab, Typewriter Tool

When the **Typewriter Tool** is enabled, the text 'Typewriter' will appear beneath the pointer, as detailed in the upper example in the image below. This text displays at the location where text will be located if the comment is created at the current location. Click to add typewriter comments:

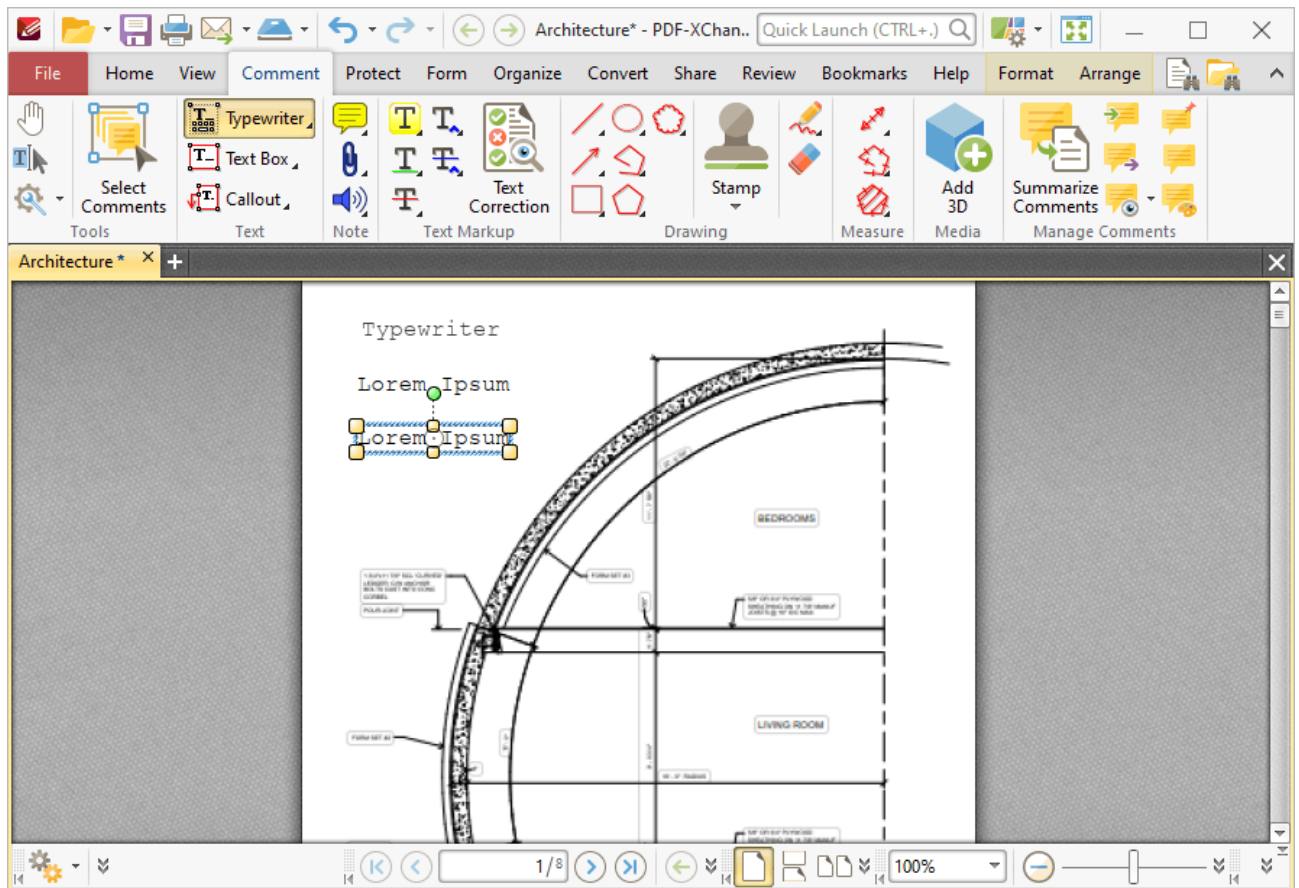

Figure 2. Typewriter Tool Examples

- The upper image is how a typewriter note appears before it is first inserted into a document. Click to add a typewriter note at the current location.
- The central image is how a typewriter note appears when text is being entered. Right-click typewriter notes to customize text and paragraph options, as explained [here](#).<sup>1649</sup>
- The lower image is how a typewriter note appears when it is completed and subsequently selected.
  - Click and drag the control points to resize typewriter text boxes.
  - Click and drag to reposition typewriter text boxes.
  - Click and drag the green control point to rotate typewriter text boxes. Hold down Shift to rotate at increments of fifteen degrees.
  - Use the arrow keys to reposition typewriter text boxes. Hold down Shift to move at an increased increment.
  - Use the editing aids detailed [here](#).<sup>1075</sup> to assist in the precise placement of typewriter text boxes.
  - Right-click typewriter text boxes for further options. See [here](#).<sup>1783</sup> for an explanation of these options.
  - Press Ctrl+' to open the **Properties** pane for selected typewriter comments and view/edit properties:

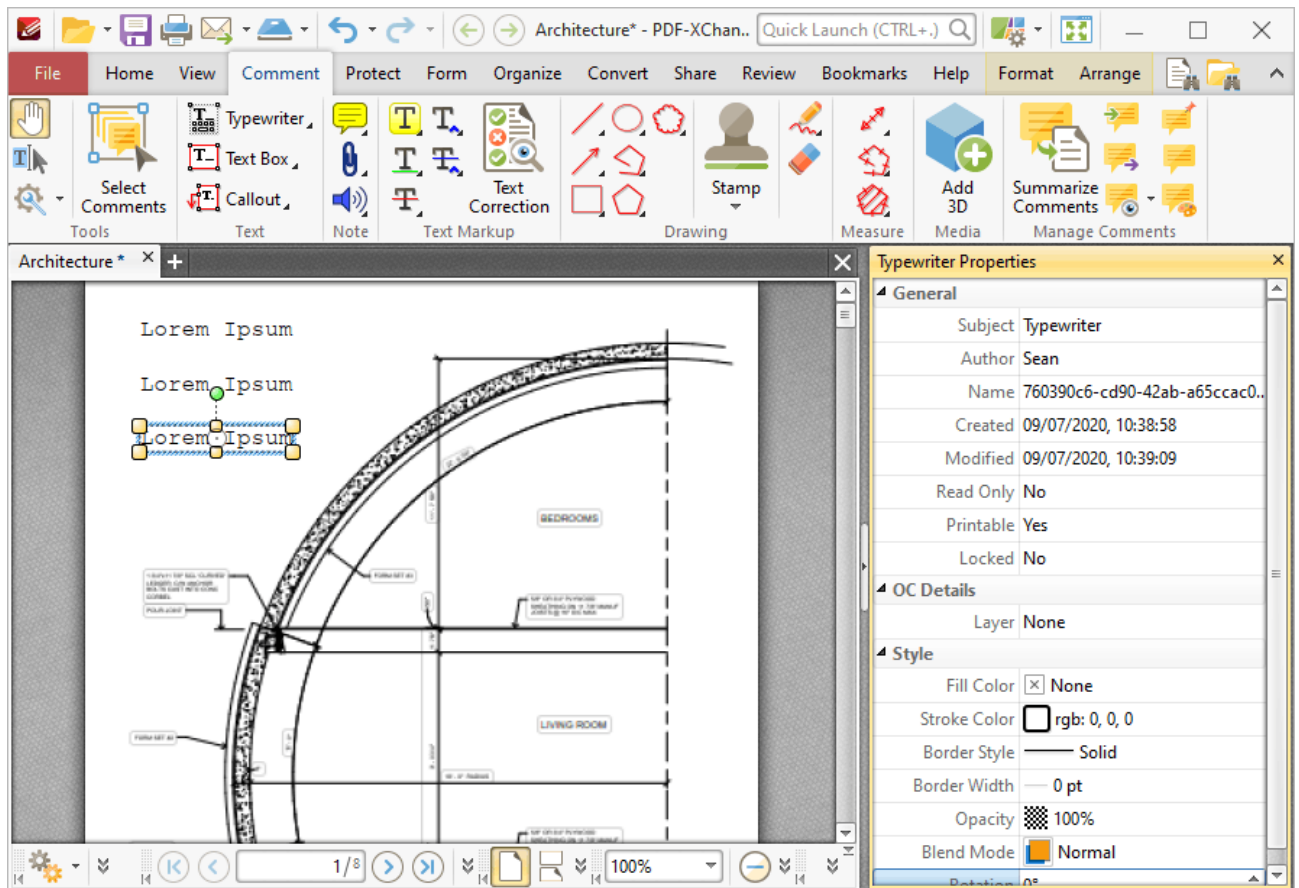

Figure 3. Typewriter Tool, Typewriter Properties Pane Enabled

- **Subject** is the name of the typewriter note comment, as referenced in the [Comments](#)<sup>1007</sup> pane.
- **Author** is the name of the user that created the typewriter note comment.
- **Name** is the unique name of the typewriter note comment, as referenced within the application.
- **Created** is the date and time at which the typewriter note comment was created.
- **Modified** is the date and time at which the typewriter note comment was last modified.
- **Read Only** is the read only status of the typewriter note comment. If this property is enabled then users cannot interact with the comment. Please note that it is necessary to use JavaScript to change the value of this property.
- **Printable** is the print status of the typewriter note comment. If this property is enabled then the comment is printed with the document. If this property is not enabled then the comment is not printed.
- **Locked** determines the locked status of the typewriter note comment. If this property is enabled then the comment cannot be deleted and its properties (including its position and size) cannot be modified by users.
- **Layer** determines the optional content layer to which the typewriter note comment belongs. Further information about layers is available [here](#).<sup>1024</sup>
- **Fill Color** determines the color of the typewriter note comment.
- **Stroke Color** determines the border color of the typewriter note comment.

- **Border Width** determines the border width of the typewriter note comment.
- **Opacity** determines the level of transparency in the typewriter note comment.
- **Blend Mode** determines how the typewriter note comment blends with overlapping content, as detailed [here](#).

Note that when the **Typewriter Tool** is enabled, the **Format** tab is available and can be used to customize the default properties of typewriter notes:

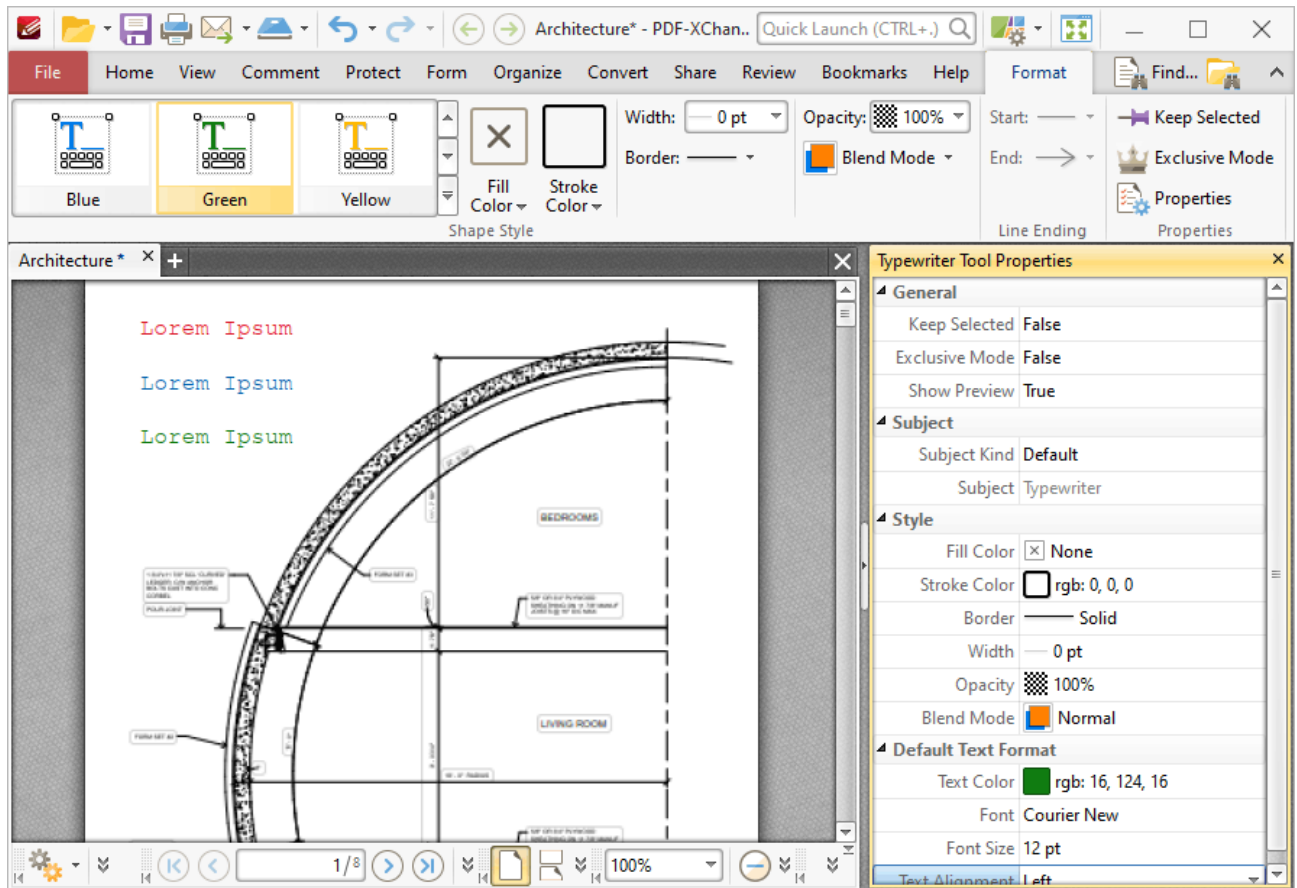

Figure 4. Format Tab, Typewriter Tool

- Click options in the **Shape Style** group to select alternative default typewriter note styles.
- Click **Keep Selected** to keep the **Typewriter Tool** enabled and add multiple typewriter notes to the document. If this option is not enabled then **PDF-XChange Editor** will revert to the designated default tool immediately after creating one typewriter note.
- Click **Exclusive Mode** to enable exclusive mode, which simplifies the process of using the **Typewriter Tool**. When **Exclusive Mode** is enabled, the pointer ignores all interactive elements of documents other than base content. This makes it possible to create typewriter notes on areas that overlap with other content without the risk of accidentally selecting undesired items. When **Exclusive Mode** is disabled, the pointer recognizes and interacts with all underlying elements in the usual manner.

- Click **Properties** to open the **Properties** pane and view/edit typewriter tool properties, as detailed above. Note that when the tool is enabled but no comments are selected, there are additional options available in the **Properties** pane:
  - **Text Color** determines the default text color for typewriter comments.
  - **Font** determines the default font for typewriter comments.
  - **Font Size** determines the default font size for typewriter comments.
  - **Text Alignment** determines the default text alignment for typewriter comments.
- When typewriter notes are selected, the **Style Tools** dropdown menu is available in the **Format** tab. It contains the following options:
  - Click **Copy Comment Style** to copy the style properties of comments.
  - Click **Apply Copied Comment Style** to apply a copied comment style to selected comments, including the text properties.
  - Click **Apply Copied Comment Appearance** to apply copied comment styles to selected comments.
  - Click **Apply Copied Text Style** to apply copied text styles to selected comments.
  - Click **Make Current Properties Default** to set the properties of the selected comment as the default properties for subsequent comments.
  - Click **Apply Default Properties** to apply the default comment properties to selected comments.
  - Click **Make Current Text Format Default** to set the text format of selected comments as the default format for subsequent comments.
  - Click **Apply Default Text Format** to apply the default text format to the text of selected comments.
- When typewriter notes are selected, the **Arrange** tab is also available and can be used to manipulate comments as detailed [here](#).<sup>1626</sup>

Note that the the [Comment Styles Palette](#)<sup>1242</sup> can be used to edit and save customized typewriter note styles for subsequent use, and the [Commenting](#)<sup>875</sup> preferences can be used to view/edit preferences for all comments.

Note that to select text in an annotation after it has been completed, it is necessary to click to select the annotation and then click again to select the text. This is because **PDF-XChange Editor** must recognize annotations and the text that annotations contain as separate items as they feature different editing options. Text editing options are detailed [here](#).<sup>1683</sup>

---

10.4.4.3 Text Box Tool



**Text Box Tool**

Click **Text Box** to add text box comments to documents:

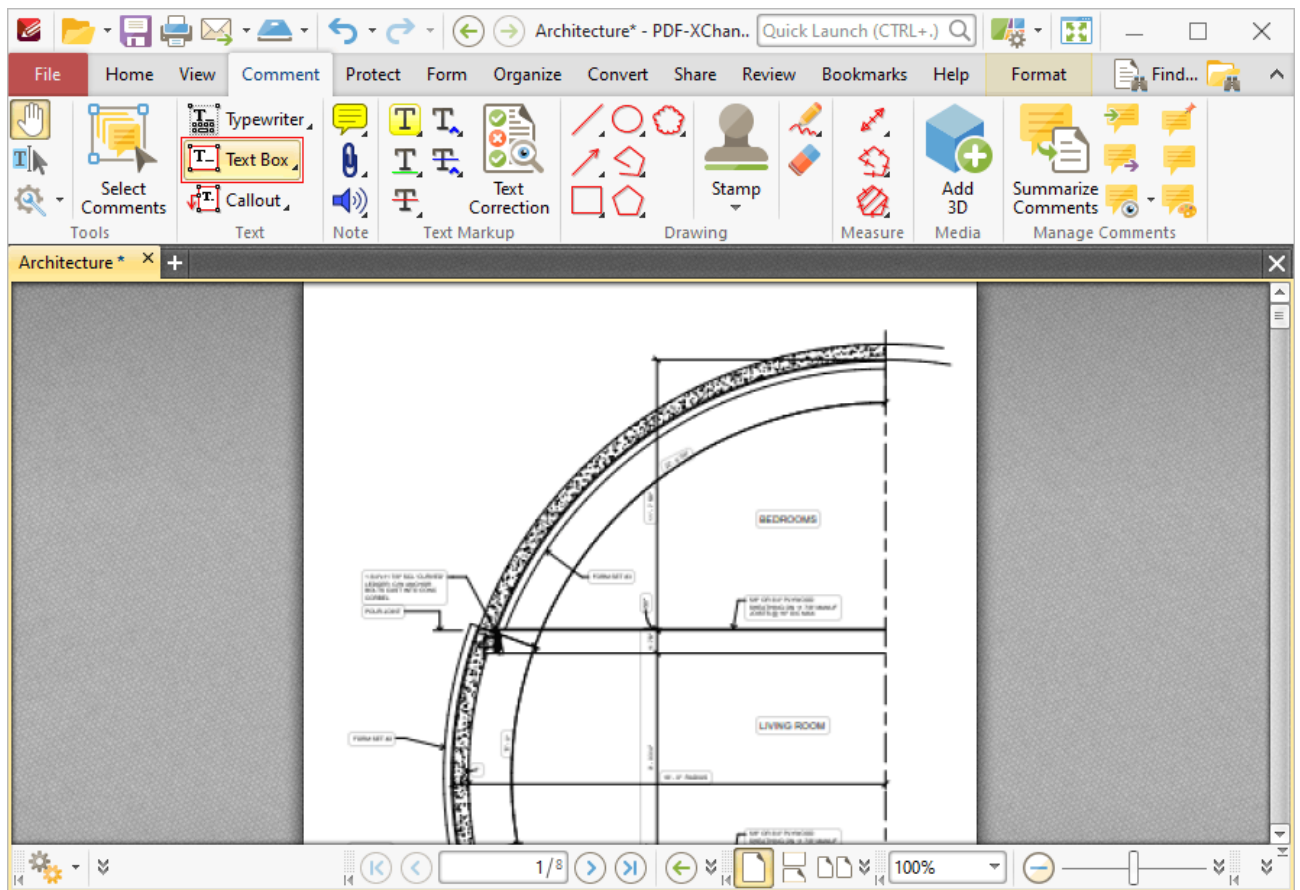

Figure 1. Comment Tab, Text Box Tool

When the **Text Box Tool** is enabled, click and drag the pointer to determine the size of text boxes:

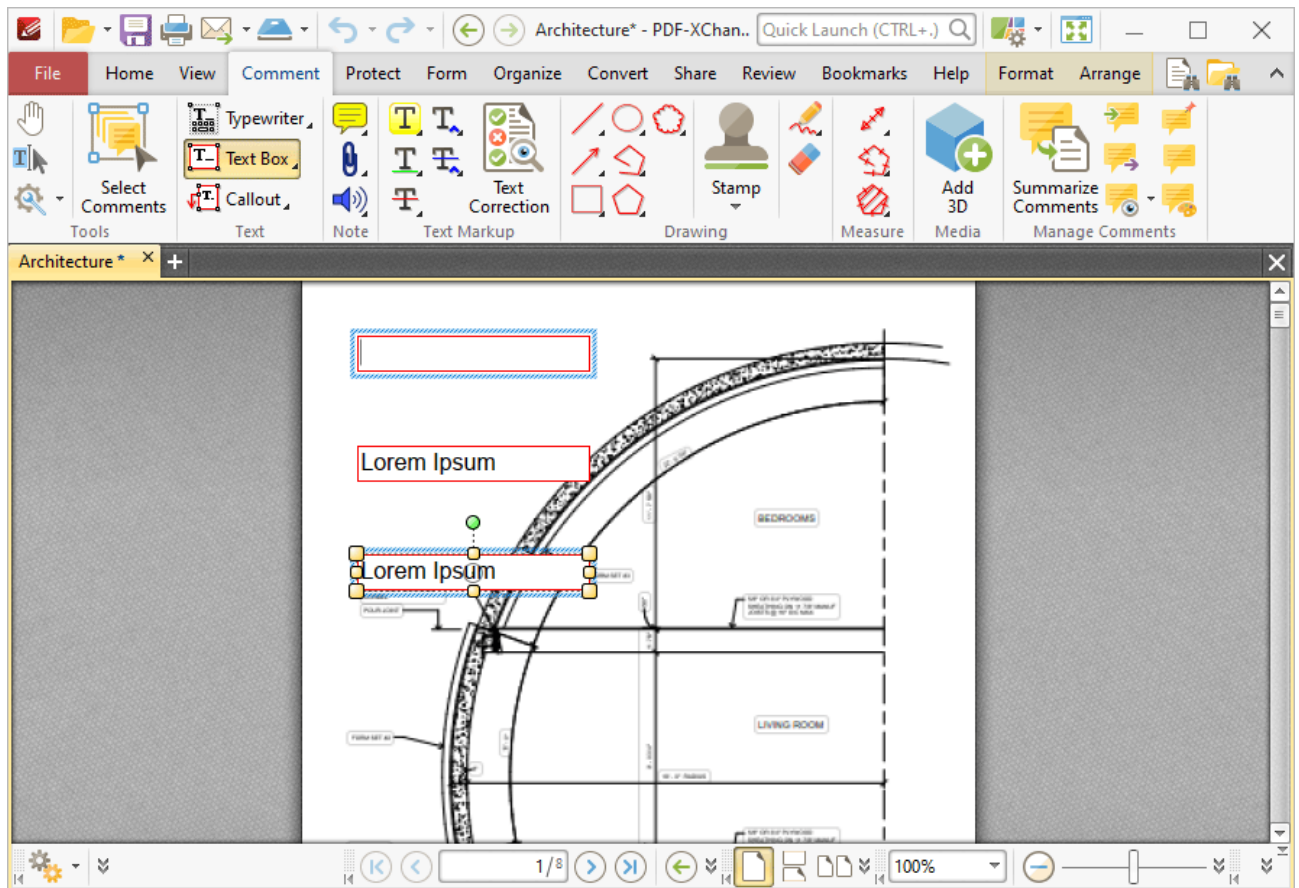

Figure 2. Text Box Tool Examples

- The upper image is how a text box appears when it is first inserted into a document. Enter the desired text using the keyboard. Press **Enter** to start new lines. Note that text style options are enabled in the **Format Tab** when text is being entered.
- The central image is how a text box appears when text is being entered. Right-click text boxes to view/select text editing options, as detailed [here](#).<sup>1651</sup>
- The lower image is how a text box appears when it is completed and subsequently selected.
  - Click and drag the control points to resize text boxes.
  - Click and drag to reposition text boxes.
  - Click and drag the green control point to rotate text boxes. Hold down Shift to rotate at increments of fifteen degrees.
  - Use the arrow keys to reposition text boxes. Hold down Shift to move at an increased increment.
  - Use the editing aids detailed [here](#)<sup>1076</sup> to assist in the precise placement of text boxes.
  - Right-click text boxes for further options. See [here](#)<sup>1783</sup> for an explanation of these options.
  - Press Ctrl+' to open the **Properties** pane for selected text box comments and view/edit properties:

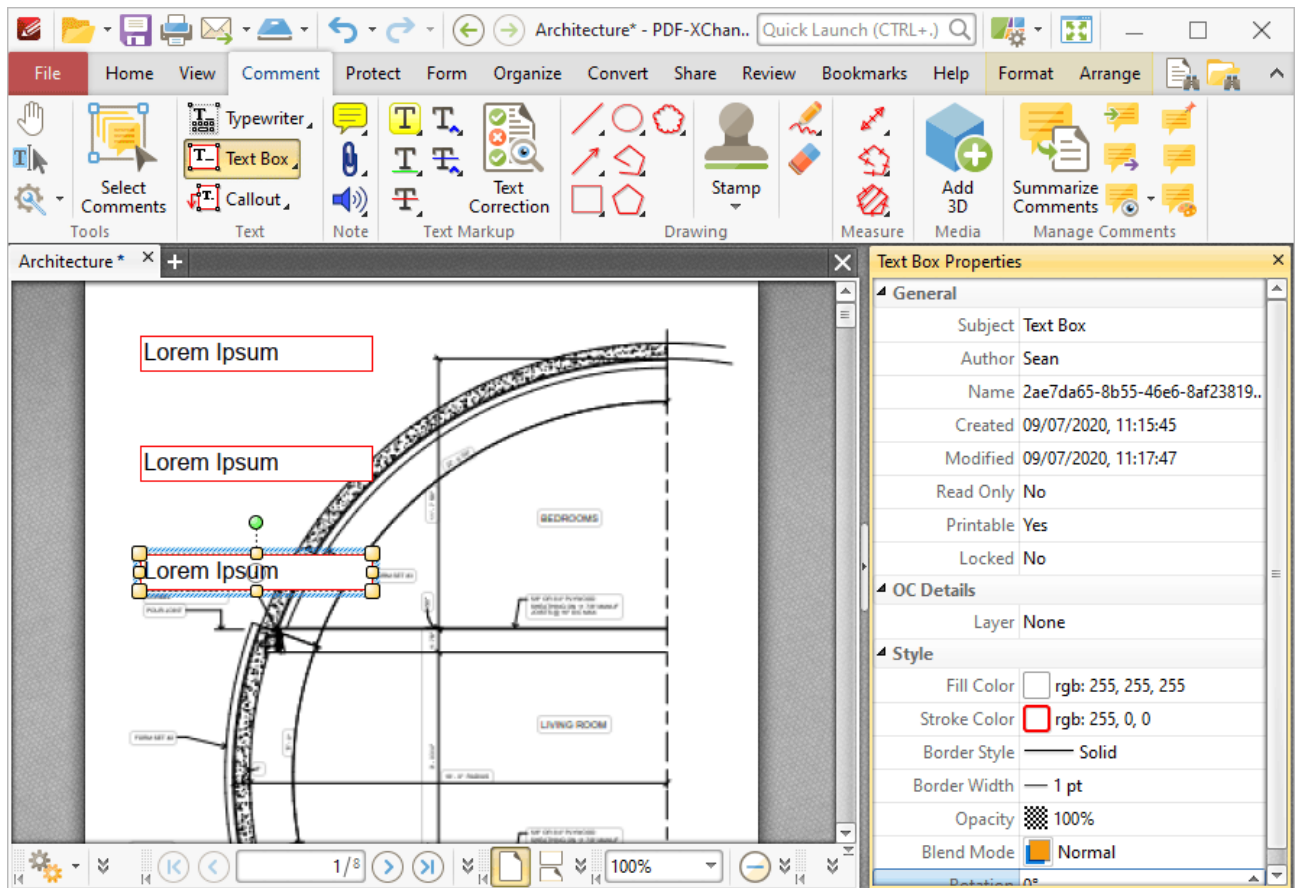

Figure 3. Text Box Tool, Text Box Properties Pane Enabled

- **Subject** is the name of the text box comment, as referenced in the [Comments](#) <sup>1007</sup> pane.
- **Author** is the name of the user that created the text box comment.
- **Name** is the unique name of the text box comment, as referenced within the application.
- **Created** is the date and time at which the text box comment was created.
- **Modified** is the date and time at which the text box comment was last modified.
- **Read Only** is the read only status of the text box comment. If this property is enabled then users cannot interact with the comment. Please note that it is necessary to use JavaScript to change the value of this property.
- **Printable** is the print status of the text box comment. If this property is enabled then the comment is printed with the document. If this property is not enabled then the comment is not printed.
- **Locked** is the locked status of the text box comment. If this property is enabled then the comment cannot be deleted and its properties (including its position and size) cannot be modified by users.
- **Layer** is the optional content layer to which the text box comment belongs. Further information about layers is available [here](#). <sup>1024</sup>
- **Fill Color** determines the color of the text box comment.
- **Stroke Color** determines the border color of the text box comment.
- **Border Style** determines the border style of the text box comment



- **Border Width** determines the border width of the text box comment.
- **Opacity** determines the level of transparency in the text box comment.
- **Blend Mode** determines how the text box comment blends with overlapping content, as detailed [here](#).
- **Rotation** determines the degrees of rotation of the text box comment.

Note that when the **Text Box Tool** is enabled, the **Format** tab is available and can be used to customize the default properties of text boxes:

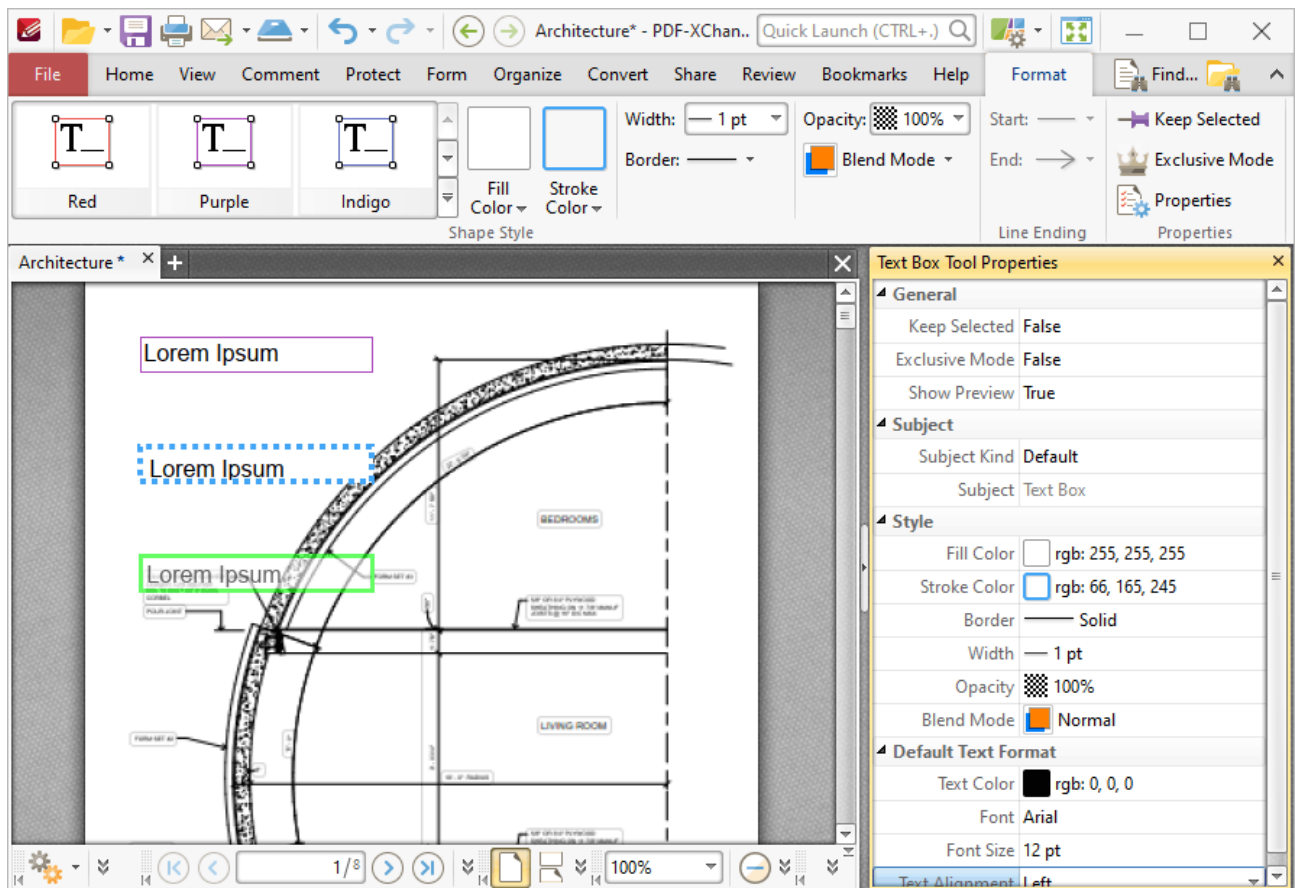

Figure 4. Format Tab, Text Box Tool

- Click options in the **Shape Style** group to select alternative default text box styles.
- Click **Keep Selected** to keep the **Text Box Tool** enabled and add multiple text boxes to the document. If this option is not enabled then **PDF-XChange Editor** will revert to the designated default tool immediately after creating one text box.
- Click **Exclusive Mode** to enable exclusive mode, which simplifies the process of using the **Text Box Tool**. When **Exclusive Mode** is enabled, the pointer ignores all interactive elements of documents other than base content. This makes it possible to create text boxes on areas that overlap with other content without the risk of accidentally selecting undesired items. When **Exclusive Mode** is disabled, the pointer recognizes and interacts with all underlying elements in the usual manner.

- Click **Properties** to open the **Properties** pane and view/edit **Text Box Tool** properties, as detailed above. Note that when the tool is enabled but no comments are selected, there are additional options available in the **Properties** pane:
  - **Text Color** determines the default text color for text box comments.
  - **Font** determines the default font for text box comments.
  - **Font Size** determines the default font size for text box comments.
  - **Text Alignment** determines the default text alignment for text box comments.
- When text box comments are selected, the **Style Tools** dropdown menu is available in the **Format** tab. It contains the following options:
  - Click **Copy Comment Style** to copy the style properties of comments.
  - Click **Apply Copied Comment Style** to apply a copied comment style to selected comments, including the text properties.
  - Click **Apply Copied Comment Appearance** to apply copied comment styles to selected comments.
  - Click **Apply Copied Text Style** to apply copied text styles to selected comments.
  - Click **Make Current Properties Default** to set the properties of the selected comment as the default properties for subsequent comments.
  - Click **Apply Default Properties** to apply the default comment properties to selected comments.
  - Click **Make Current Text Format Default** to set the text format of selected comments as the default format for subsequent comments.
  - Click **Apply Default Text Format** to apply the default text format to the text of selected comments.
- When text box comments are selected, the **Arrange** tab is also available and can be used to manipulate comments as detailed [here](#).<sup>1626</sup>

Note that the the [Comment Styles Palette](#)<sup>1242</sup> can be used to edit and save customized text box styles for subsequent use, and the [Commenting](#)<sup>875</sup> preferences can be used to view/edit preferences for all comments.

Note that to select text in an annotation after it has been completed, it is necessary to click to select the annotation and then click again to select the text. This is because **PDF-XChange Editor** must recognize annotations and the text that annotations contain as separate items as they feature different editing options. Text editing options are detailed [here](#).<sup>1683</sup>

---

10.4.4.4 Callout Tool



**Callout Tool**

Click **Callout** to add callout annotations to documents:

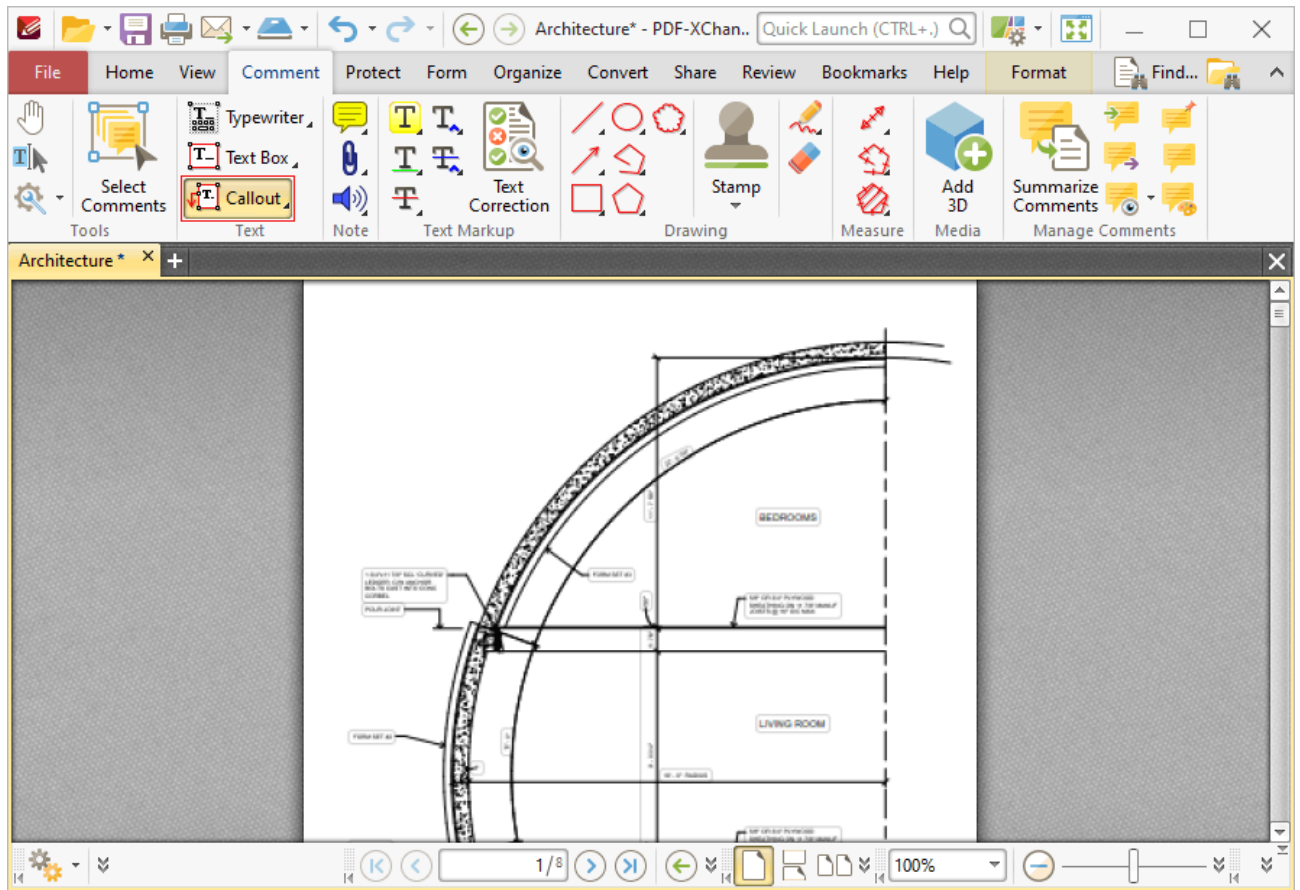

**Figure 1.** Comment Tab, Callout Tool

Callout annotations are used to highlight specific location in documents. They are composed of a text box that features a linked arrow annotation, which is used to highlight areas of importance in the document.

When the **Callout Tool** is enabled, click to add callout annotations. The position of the pointer when the mouse is clicked determines the initial position of the arrowhead in the callout arm. The image below details callout annotations at three stages of editing:

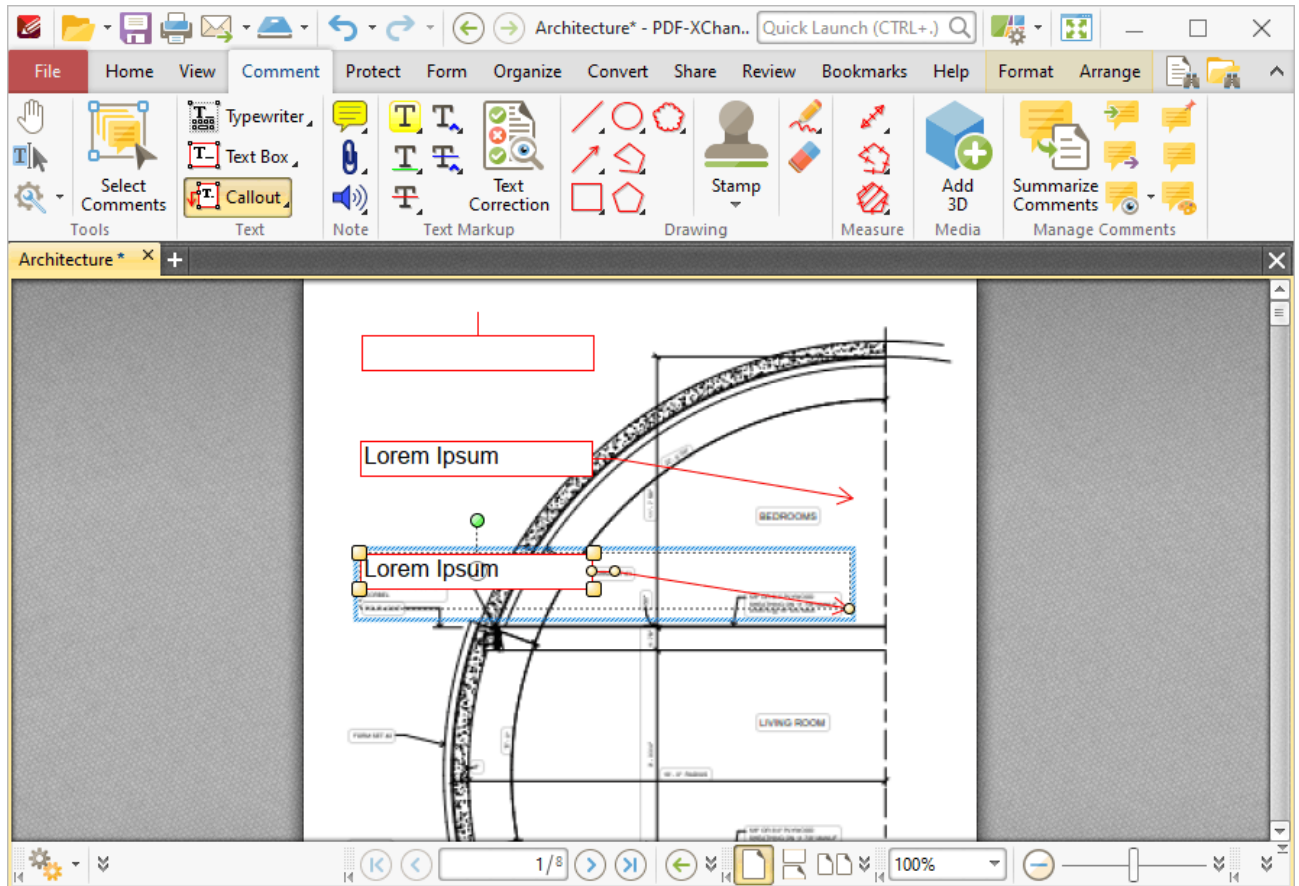

**Figure 2.** Callout Tool Examples

- The upper image is how a callout annotation appears when it is first inserted into a document. Enter the desired text using the keyboard. Press **Enter** to start new lines. Note that text style options are enabled in the **Format Tab** when text is being entered.
- The central image is how a callout annotation appears when text is being entered. Right-click text boxes to view/select text editing options, as detailed [here](#).
- The lower image is how a callout annotation appears when it is completed and subsequently selected.
  - Click and drag the control points to resize callout annotations and/or reposition the callout arrow.
  - Click and drag callout annotations to reposition them.
  - Click and drag the green control point to rotate callout annotations. Hold down Shift to rotate at increments of fifteen degrees.
  - Use the arrow keys to reposition callout annotations. Hold down Shift to move at an increased increment.

- Use the editing aids detailed [here](#)<sup>1075</sup> to assist in the precise placement of callout annotations.
- Right-click callout annotations for further options. See [here](#)<sup>1783</sup> for an explanation of these options.
- Press Ctrl+' to open the **Properties** pane for selected callout comments and view/edit properties:

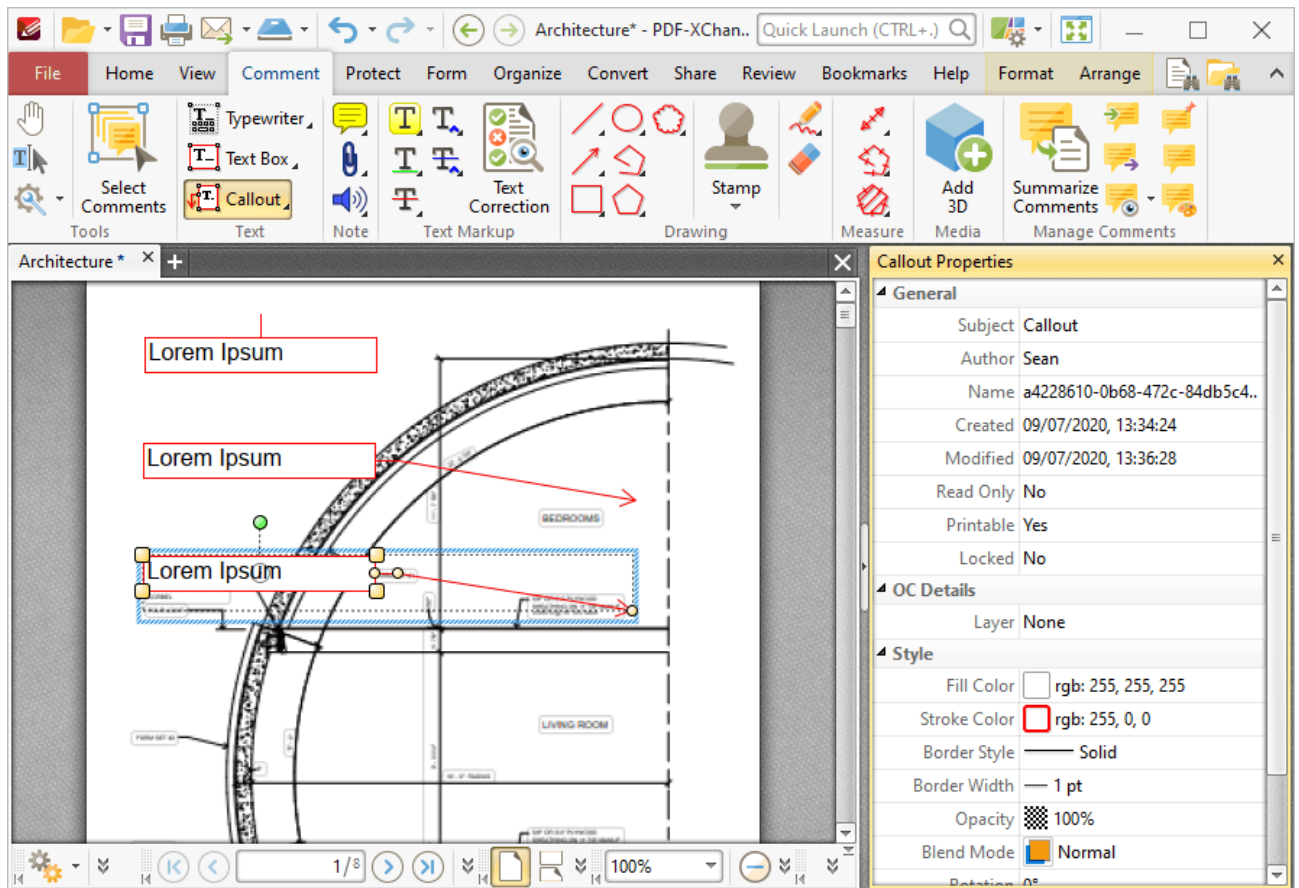

Figure 3. Callout Tool, Callout Properties Pane Enabled

- **Subject** is the name of the callout comment, as referenced in the [Comments](#)<sup>1007</sup> pane.
- **Author** is the name of the user that created the callout comment.
- **Name** is the unique name of the callout comment, as referenced within the application.
- **Created** is the date and time at which the callout comment was created.
- **Modified** is the date and time at which the callout annotation was last modified.
- **Read Only** is the read only status of the callout annotation. If this property is enabled then users cannot interact with the comment. Please note that it is necessary to use JavaScript to change the value of this property.
- **Printable** is the print status of the callout annotation. If this property is enabled then the comment is printed with the document. If this property is not enabled then the comment is not printed.

- **Locked** is the locked status of the callout annotation. If this property is enabled then the comment cannot be deleted and its properties (including its position and size) cannot be modified by users.
- **Layer** is the optional content layer to which the callout annotation belongs. Further information about layers is available [here](#).
- **Fill Color** determines the color of the callout annotation.
- **Stroke Color** determines the border color of the callout annotation.
- **Border Style** determines the border style of the callout annotation
- **Border Width** determines the border width of the callout annotation.
- **Opacity** determines the level of transparency in the callout annotation.
- **Blend Mode** determines how the callout annotation blends with overlapping content, as detailed [here](#).
- **Rotation** determines the degrees of rotation of the callout annotation.
- **End** determines the line ending used for the arm of the callout annotation.
- **End Scale** determines the size of the line ending in relation to the rest of the callout annotation.

Note that when the **Callout Tool** is enabled, the **Format** tab is available and can be used to customize the default properties of callout annotations:

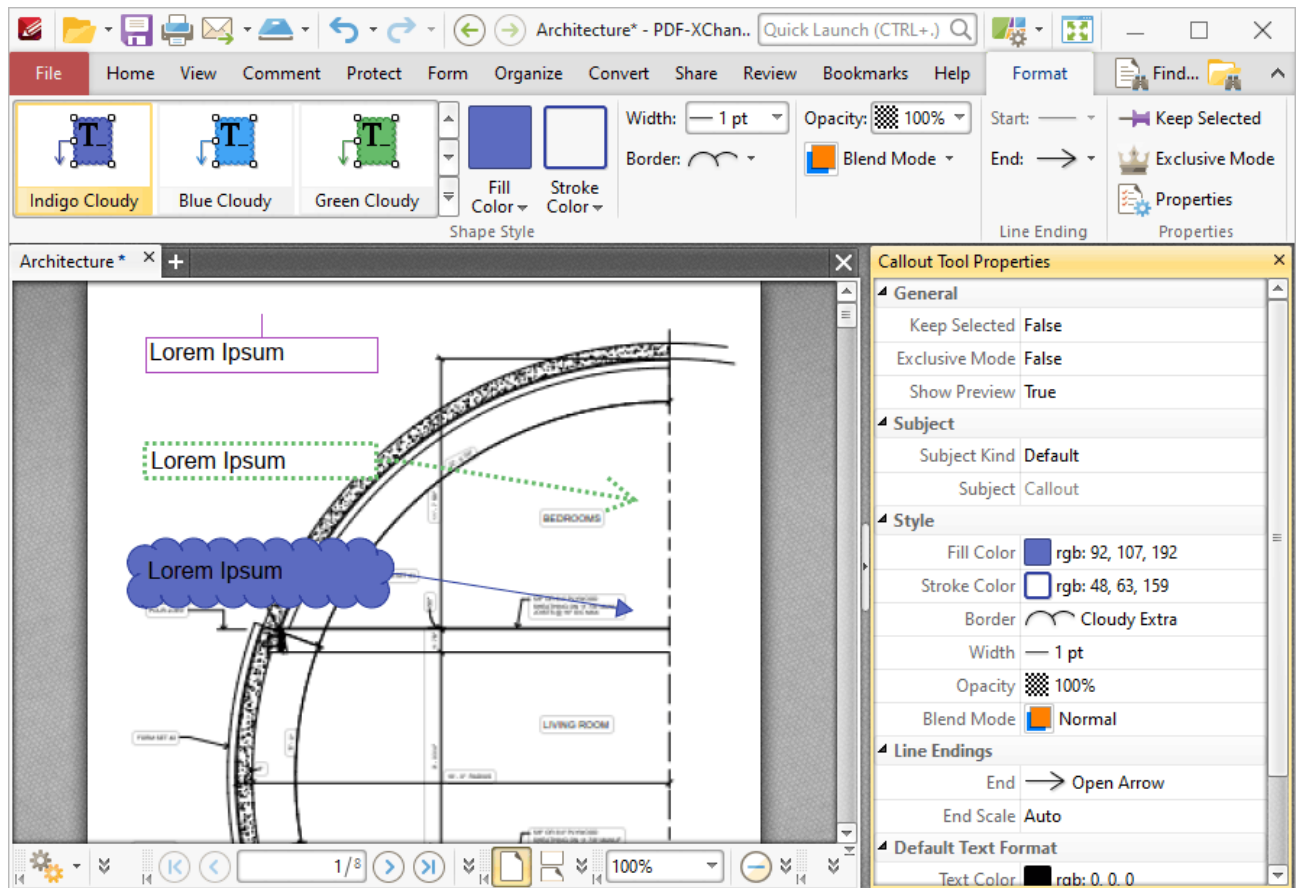



Figure 4. Format Tab, Callout Tool

- Click options in the **Shape Style** group to select alternative default callout box styles.
- Click **Keep Selected** to keep the **Callout Tool** enabled and add multiple callout annotations to the document. If this option is not enabled then **PDF-XChange Editor** will revert to the designated default tool immediately after creating one callout annotation.
- Click **Exclusive Mode** to enable exclusive mode, which simplifies the process of using the **Callout Tool**. When **Exclusive Mode** is enabled, the pointer ignores all interactive elements of documents other than base content. This makes it possible to create callout annotations on areas that overlap with other content without the risk of accidentally selecting undesired items. When **Exclusive Mode** is disabled, the pointer recognizes and interacts with all underlying elements in the usual manner.
- Click **Properties** to open the **Properties** pane and view/edit **Callout Tool** properties, as detailed above. Note that when the tool is enabled but no comments are selected, there are additional options available in the **Properties** pane:
  - **Text Color** determines the default text color for callout annotations.
  - **Font** determines the default font for callout annotations.
  - **Font Size** determines the default font size for callout annotations.
  - **Text Alignment** determines the default text alignment for callout annotations.
- When callout annotations are selected, the **Style Tools** dropdown menu is available in the **Format** tab. It contains the following options:
  - Click **Copy Comment Style** to copy the style properties of comments.
  - Click **Apply Copied Comment Style** to apply a copied comment style to selected comments, including the text properties.
  - Click **Apply Copied Comment Appearance** to apply copied comment styles to selected comments.
  - Click **Apply Copied Text Style** to apply copied text styles to selected comments.
  - Click **Make Current Properties Default** to set the properties of the selected comment as the default properties for subsequent comments.
  - Click **Apply Default Properties** to apply the default comment properties to selected comments.
  - Click **Make Current Text Format Default** to set the text format of selected comments as the default format for subsequent comments.
  - Click **Apply Default Text Format** to apply the default text format to the text of selected comments.
- When callout annotations are selected, the **Arrange** tab is also available and can be used to manipulate comments as detailed [here](#).<sup>[1626]</sup>

Note that the [Comment Styles Palette](#)<sup>[1242]</sup> can be used to edit and save customized callout annotation styles for subsequent use, and the [Commenting](#)<sup>[875]</sup> preferences can be used to view/edit preferences for all comments.

Note that to select text in an annotation after it has been completed, it is necessary to click to select the annotation and then click again to select the text. This is because **PDF-XChange Editor** must

recognize annotations and the text that annotations contain as separate items as they feature different editing options. Text editing options are detailed [here](#).

---



### 10.4.4.5 Sticky Note Tool



## Sticky Note Tool

Click **Sticky Note** to add sticky note comments to documents:

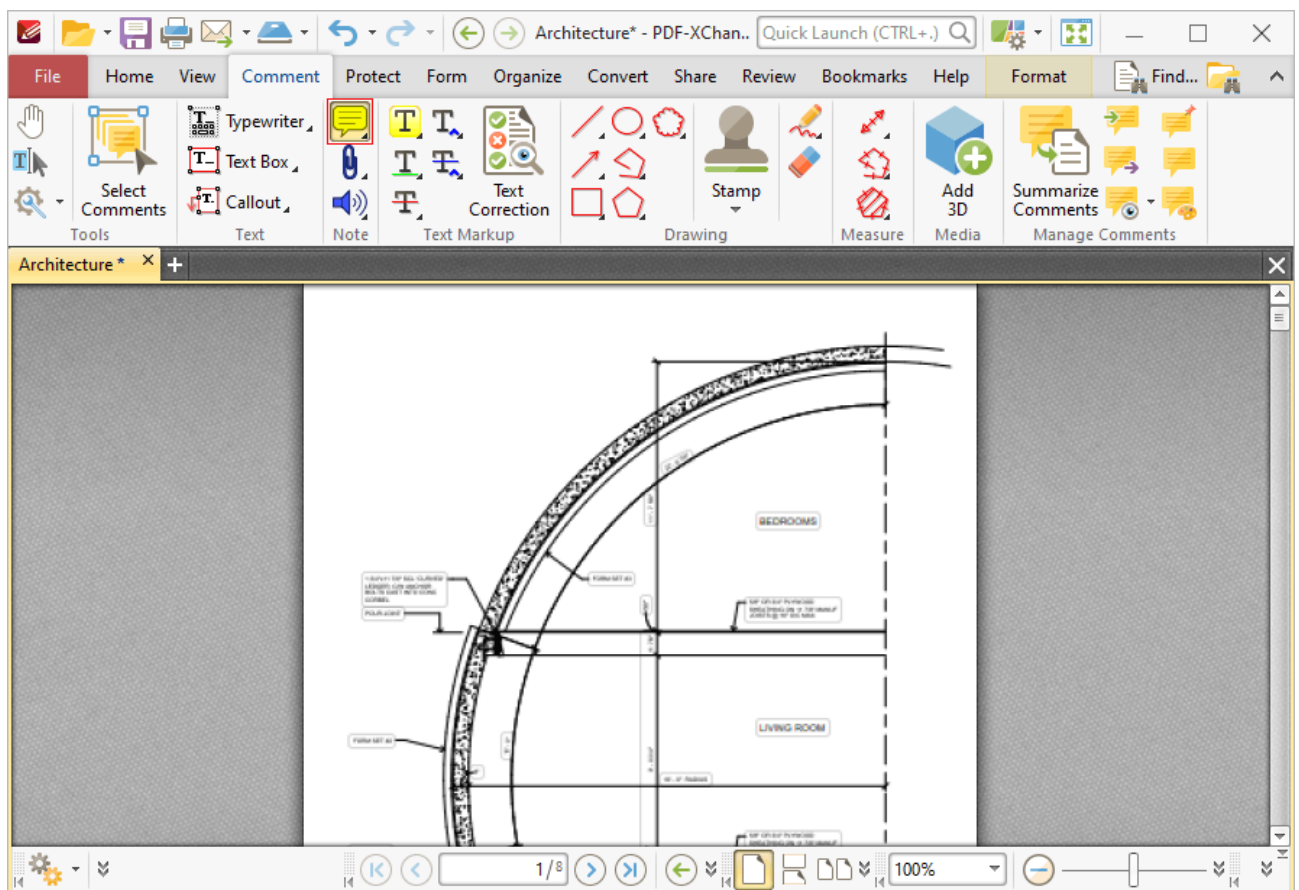

**Figure 1.** Comment Pane, Sticky Note Tool

Sticky note comments enable the storage of text notes. The text in sticky note comments is contained in a collapsible text box that can be expanded as required. When the text box is collapsed, only the sticky note icon remains in the document. This means that large text notes can be stored in documents without taking up excessive space. If the pointer is hovered over the sticky note icon subsequently, then the note content will be displayed in the same manner as a tooltip.

When the **Sticky Note Tool** is enabled, click to add sticky notes:

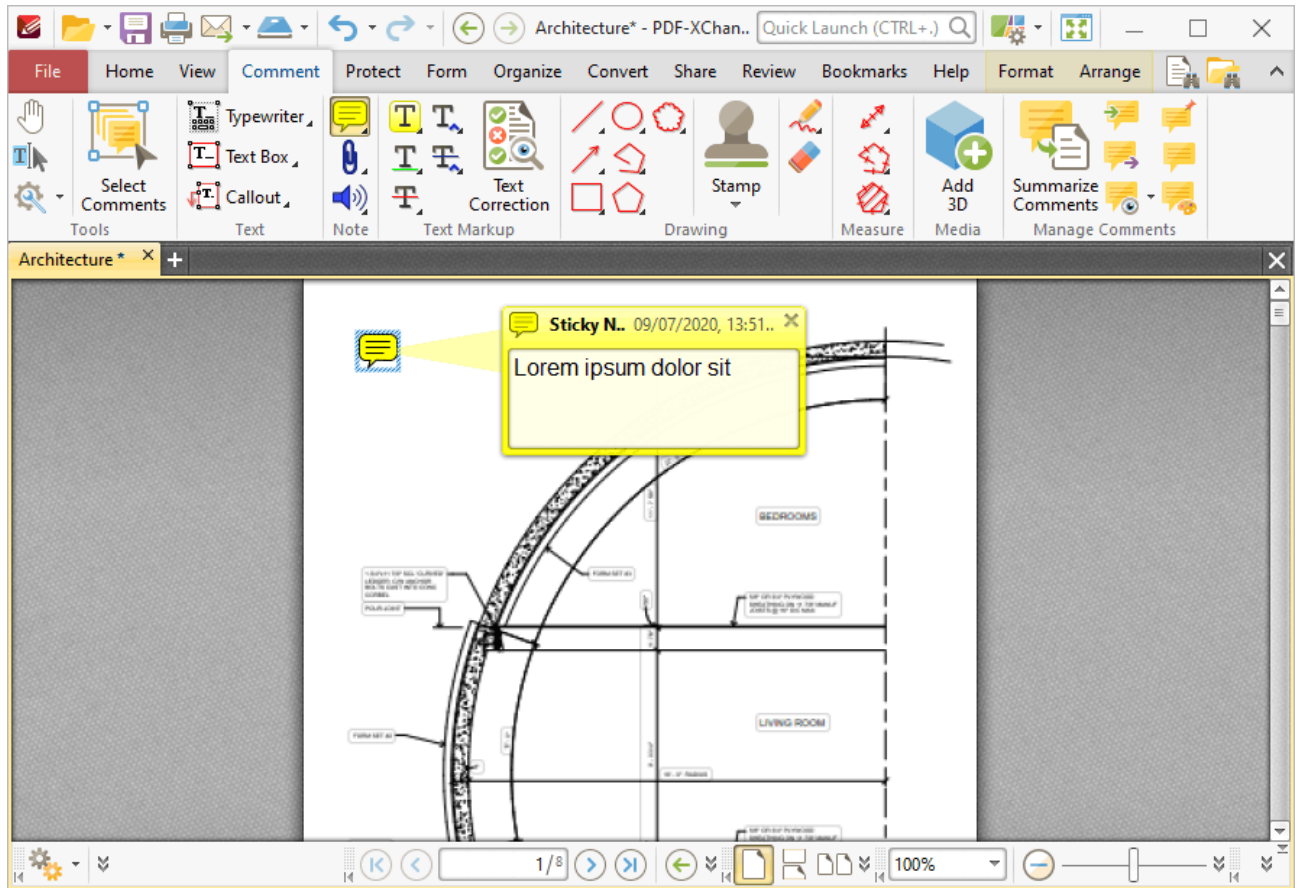

Figure 2. Sticky Note Tool Example

- Click and drag the sticky note to reposition it.
- Enter the desired note content within the associated pop-up note text box. This content will be displayed when the pointer is hovered over the icon subsequently. Right-click when entering/editing text to launch the text editing options menu. These options are explained [here](#).<sup>1649</sup>
- Use the arrow keys to reposition sticky notes. Hold down Shift to move at an increased increment.
- Right-click sticky notes for further options. See [here](#).<sup>1783</sup> for an explanation of these options.
- Press Ctrl+' to open the **Properties** pane for selected sticky note comments and view/edit properties:

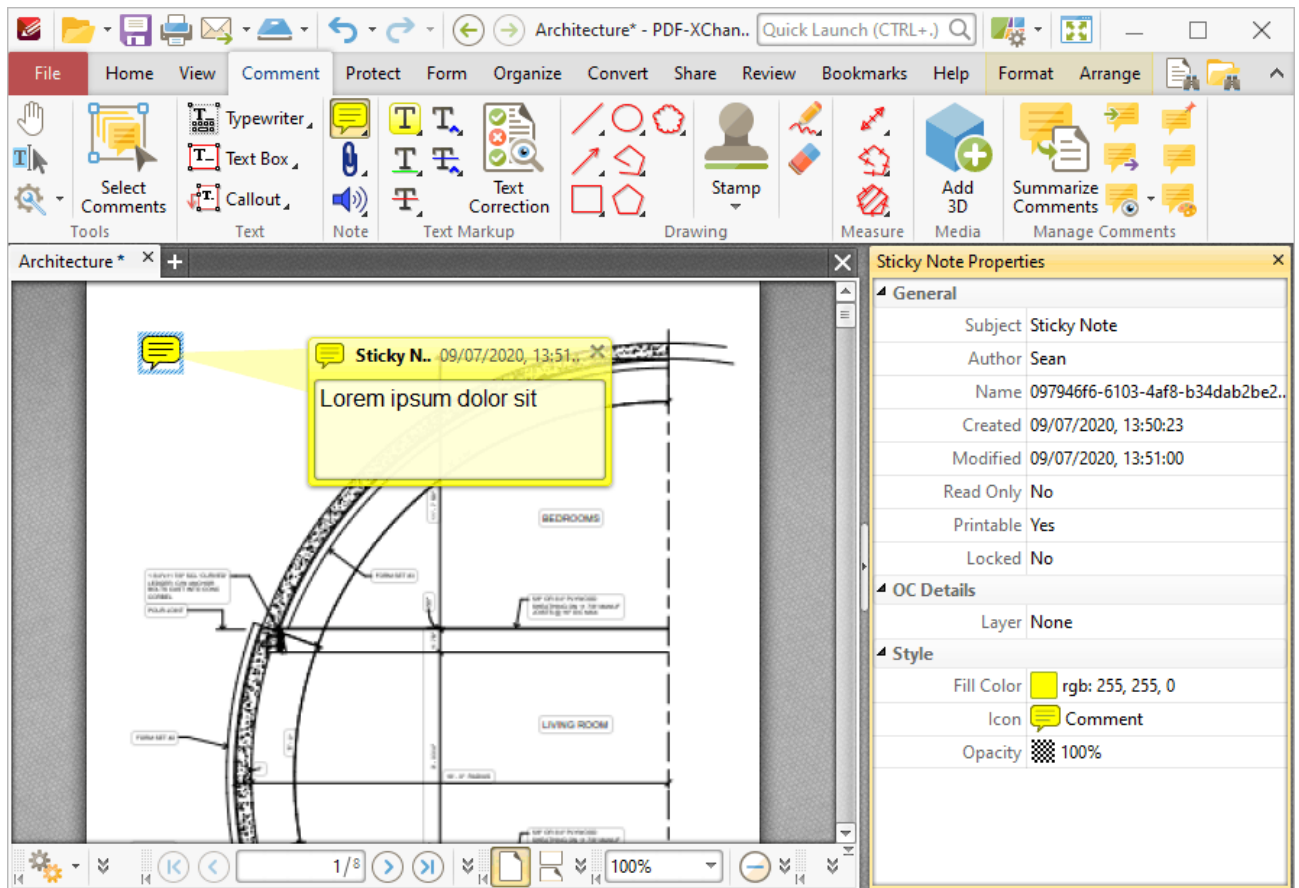

Figure 3. Sticky Note Tool, Sticky Note Properties Pane

- **Subject** is the name of the sticky note comment, as referenced in the [Comments](#) <sup>1007</sup> pane.
- **Author** is the name of the user that created the sticky note comment.
- **Name** is the unique name of the sticky note comment, as referenced within the application.
- **Created** is the date and time at which the sticky note comment was created.
- **Modified** is the date and time at which the sticky note comment was last modified.
- **Read Only** is the read only status of the sticky note comment. If this property is enabled then users cannot interact with the comment. Please note that it is necessary to use JavaScript to change the value of this property.
- **Printable** is the print status of the sticky note comment. If this property is enabled then the comment is printed with the document. If this property is not enabled then the comment is not printed.
- **Locked** is the locked status of the sticky note comment. If this property is enabled then the comment cannot be deleted and its properties (including its position and size) cannot be modified by users.
- **Layer** specifies the optional content layer to which the sticky note comment belongs. Further information about layers is available [here](#). <sup>1024</sup>
- **Fill Color** determines the color of the sticky note comment.
- **Icon** determines the icon used for the sticky note comment.
- **Opacity** determines the level of transparency in the sticky note comment.

Note that when the **Sticky Note Tool** is enabled, the **Format** tab is available and can be used to customize the default properties of sticky notes:

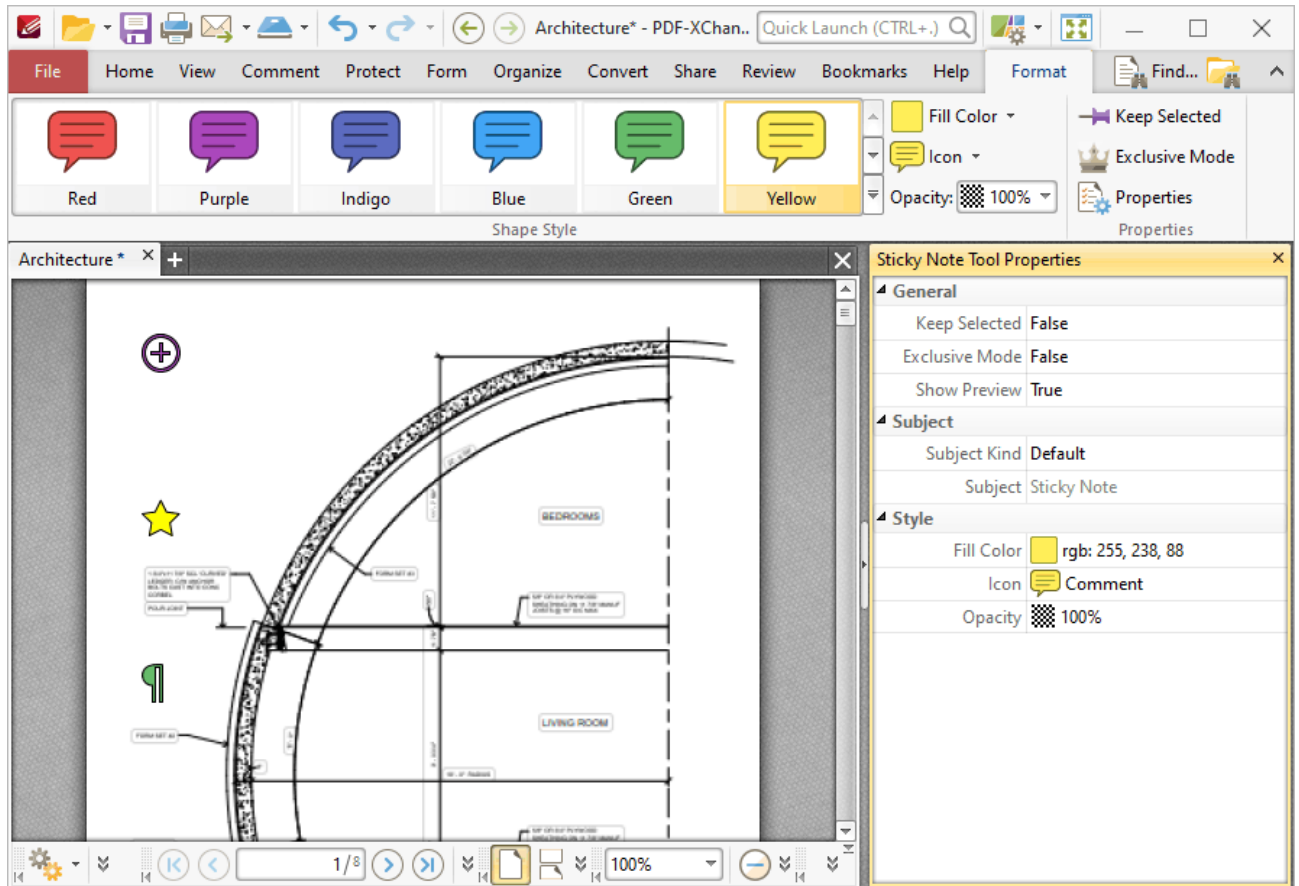

Figure 4. Format Tab, Sticky Note Tool

- Click options in the **Shape Style** group to select alternative default sticky note styles.
- Click **Keep Selected** to keep the **Sticky Note Tool** enabled and add multiple sticky notes to the document. If this option is not enabled then **PDF-XChange Editor** will revert to the designated default tool immediately after creating one sticky note.
- Click **Exclusive Mode** to enable exclusive mode, which simplifies the process of using the **Sticky Note Tool**. When **Exclusive Mode** is enabled, the pointer ignores all interactive elements of documents other than base content. This makes it possible to create sticky notes on areas that overlap with other content without the risk of accidentally selecting undesired items. When **Exclusive Mode** is disabled, the pointer recognizes and interacts with all underlying elements in the usual manner.
- Click **Properties** to open the **Properties** pane and view/edit sticky note properties, as detailed above.
- When sticky note comments are selected, the **Style Tools** dropdown menu is available in the **Format** tab. It contains the following options:
  - Click **Copy Comment Style** to copy the style properties of comments.

- Click **Apply Copied Comment Style** to apply a copied comment style to selected comments, including the text properties.
- Click **Apply Copied Comment Appearance** to apply copied comment styles to selected comments.
- Click **Apply Copied Text Style** to apply copied text styles to selected comments.
- Click **Make Current Properties Default** to set the properties of the selected comment as the default properties for subsequent comments.
- Click **Apply Default Properties** to apply the default comment properties to selected comments.
- Click **Make Current Text Format Default** to set the text format of selected comments as the default format for subsequent comments.
- Click **Apply Default Text Format** to apply the default text format to the text of selected comments.
- When sticky note comments are selected, the **Pop-up** group is available in the **Format** tab and can be used to interact with the pop-up note of the comment:
  - Click **Open** to open the pop-up note.
  - Click **Hide** to hide the pop-up note.
  - Click **Reset Location** to reset the location of the pop-up note.
- When sticky note comments are selected, the **Arrange** tab is also available and can be used to manipulate comments as detailed [here](#).<sup>1626</sup>

Note that the [Comment Styles Palette](#)<sup>1242</sup> can be used to edit and save customized sticky note styles for subsequent use, and the [Commenting](#)<sup>875</sup> preferences can be used to view/edit preferences for all comments.

Note that to select text in an annotation after it has been completed, it is necessary to click to select the annotation and then click again to select the text. This is because **PDF-XChange Editor** must recognize annotations and the text that annotations contain as separate items as they feature different editing options. Text editing options are detailed [here](#).<sup>1683</sup>

---

#### 10.4.4.6 File Attachment Tool



### File Attachment Tool

Click the **File Attachment Tool** to embed files into documents:

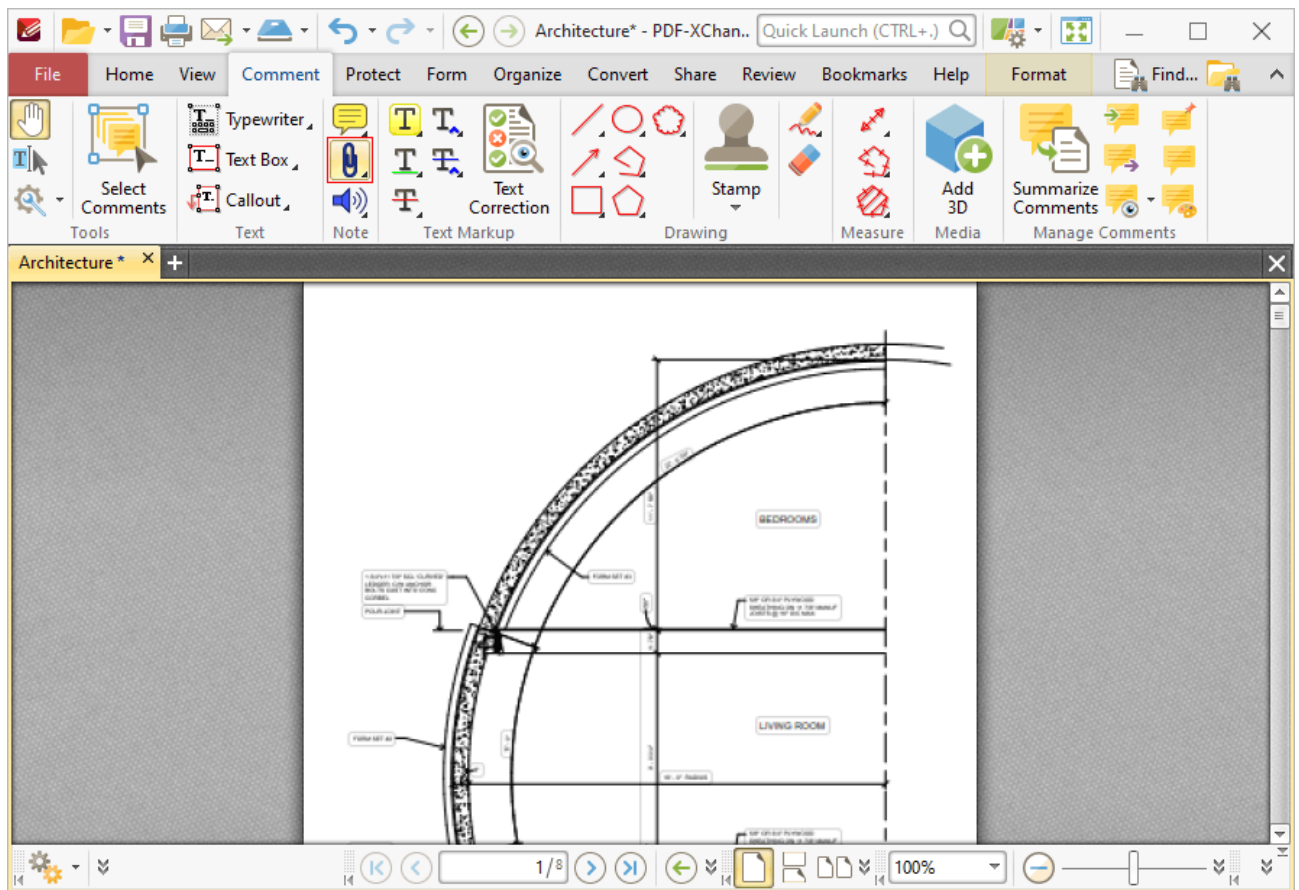

Figure 1. Comment Tab, File Attachment Tool

When the **File Attachment Tool** is enabled, the pointer becomes a crosshairs icon. Move the crosshairs to the desired location and click to embed a file. The **Open Files** dialog box will open. Select the desired file and click **Open**. The link to the embedded file will then appear in the document:

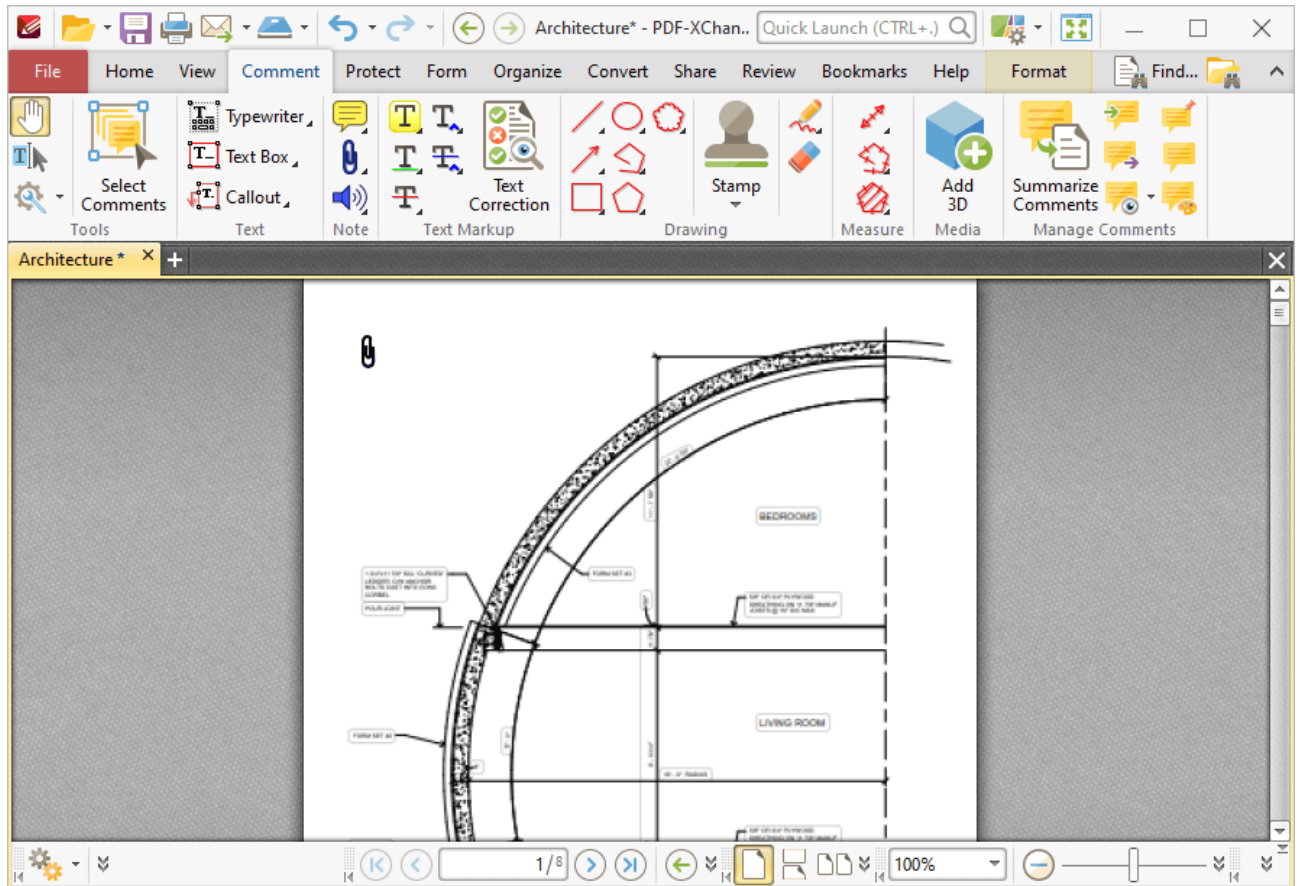

Figure 2. File Attachment Tool Examples

- Click and drag the file attachment icon, or use the arrow keys, to reposition it. Hold down Shift to move at an increased increment when using the arrow keys.
- Double-click the file attachment icon to open the attached file.
- Right-click file attachment icons for further options. See [here](#)<sup>1783</sup> for an explanation of those options.
- Press Ctrl+' to open the **Properties** pane for selected file attachment comments and view/edit properties:

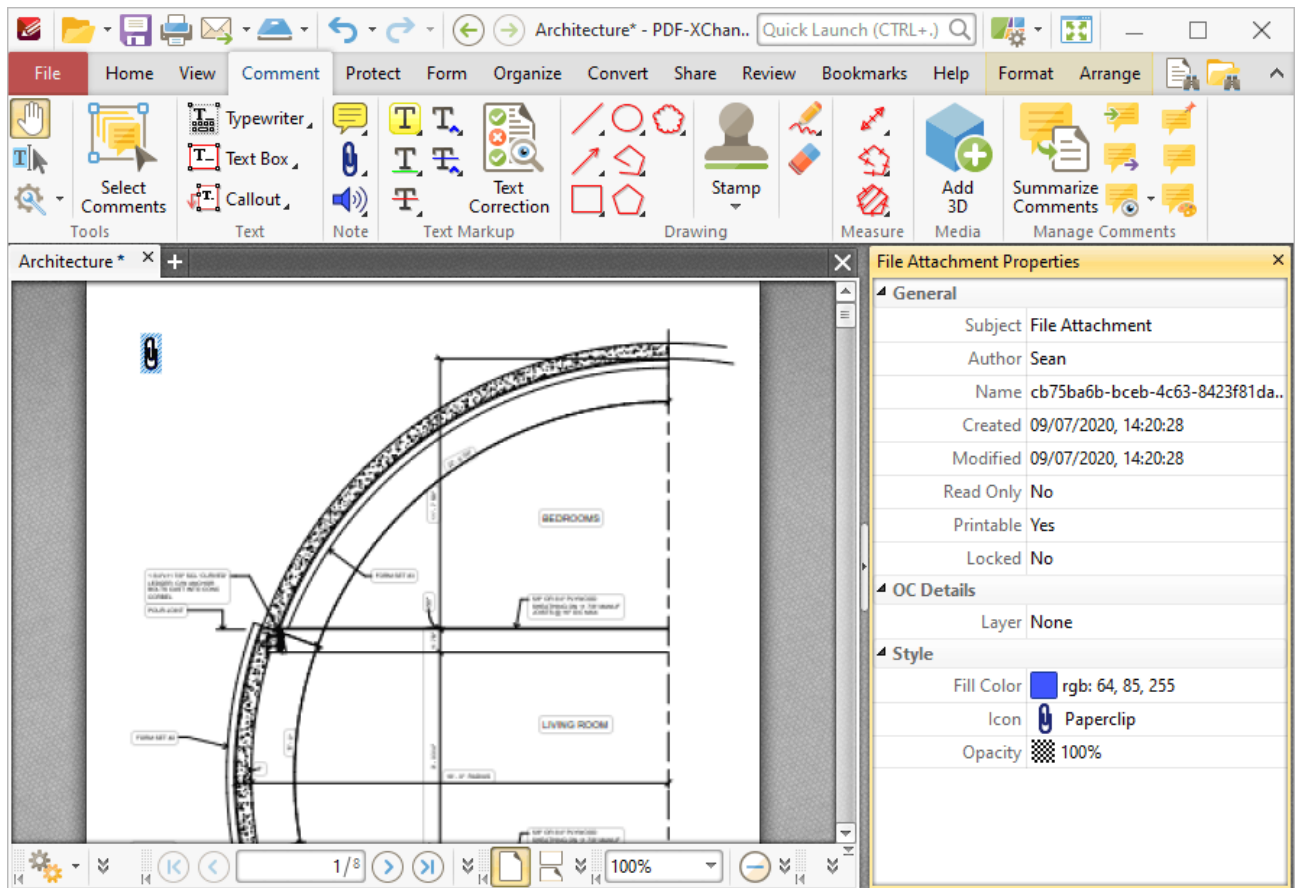

Figure 3. File Attachment Tool, File Attachment Properties Pane

- **Subject** is the name of the file attachment comment, as referenced in the [Comments](#)<sup>1007</sup> pane.
- **Author** is the name of the user that created the file attachment comment.
- **Name** is the unique name of the file attachment comment, as referenced within the application.
- **Created** is the date and time at which the file attachment comment was created.
- **Modified** is the date and time at which the file attachment comment was last modified.
- **Read Only** is the read only status of the file attachment comment. If this property is enabled then users cannot interact with the comment. Please note that it is necessary to use JavaScript to change the value of this property.
- **Printable** is the print status of the file attachment comment. If this property is enabled then the comment is printed with the document. If this property is not enabled then the comment is not printed.
- **Locked** is the locked status of the file attachment comment. If this property is enabled then the comment cannot be deleted and its properties (including its position and size) cannot be modified by users.
- **Layer** specifies the optional content layer to which the file attachment comment belongs. Further information about layers is available [here](#).<sup>1024</sup>
- **Fill Color** determines the color of the file attachment comment.
- **Icon** determines the icon used for the file attachment comment.



- **Opacity** determines the level of transparency in the file attachment comment.

Note that when the **File Attachment Tool** is enabled, the **Format** tab is available and can be used to customize the default properties of file attachments:

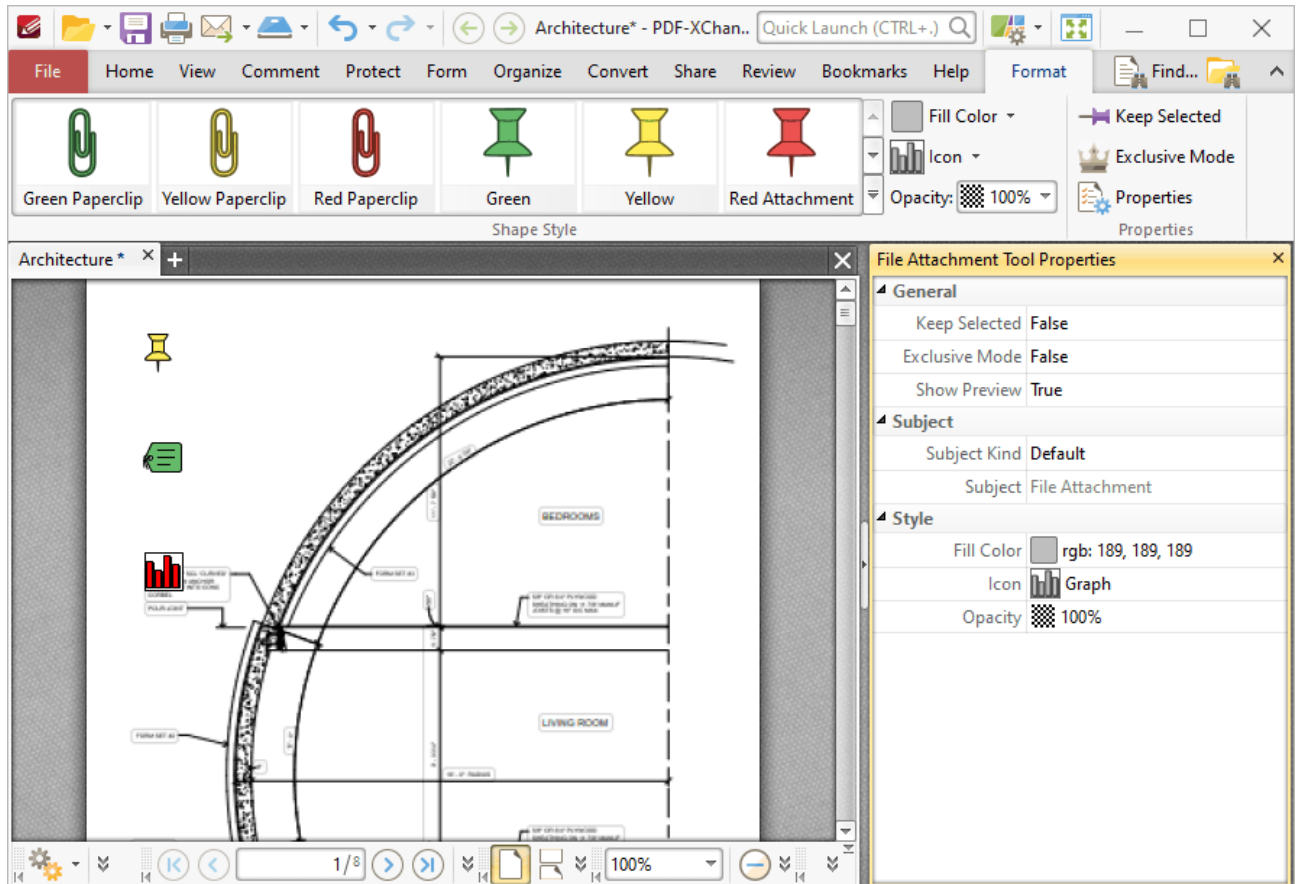

Figure 4. Format Tab, File attachment Tool

- Click options in the **Shape Style** group to select alternative default file attachment annotation styles.
- Click **Keep Selected** to keep the **File Attachment Tool** enabled and add multiple file attachment annotations to the document. If this option is not enabled then **PDF-XChange Editor** will revert to the designated default tool immediately after creating one file attachment annotation.
- Click **Exclusive Mode** to enable exclusive mode, which simplifies the process of using the **File Attachment Tool**. When **Exclusive Mode** is enabled, the pointer ignores all interactive elements of documents other than base content. This makes it possible to create file attachment annotations on areas that overlap with other content without the risk of accidentally selecting undesired items. When **Exclusive Mode** is disabled, the pointer recognizes and interacts with all underlying elements in the usual manner.
- Click **Properties** to open the **Properties** pane and view/edit **File Attachment Tool** properties, as detailed above.

- When file attachment comments are selected, the **Style Tools** dropdown menu is available in the **Format** tab. It contains the following options:
  - Click **Copy Comment Style** to copy the style properties of comments.
  - Click **Apply Copied Comment Style** to apply a copied comment style to selected comments, including the text properties.
  - Click **Apply Copied Comment Appearance** to apply copied comment styles to selected comments.
  - Click **Apply Copied Text Style** to apply copied text styles to selected comments.
  - Click **Make Current Properties Default** to set the properties of the selected comment as the default properties for subsequent comments.
  - Click **Apply Default Properties** to apply the default comment properties to selected comments.
  - Click **Make Current Text Format Default** to set the text format of selected comments as the default format for subsequent comments.
  - Click **Apply Default Text Format** to apply the default text format to the text of selected comments.
- When file attachment comments are selected, the **Pop-up** group is available in the **Format** tab and can be used to interact with the pop-up note of the comment:
  - Click **Open** to open the pop-up note.
  - Click **Hide** to hide the pop-up note.
  - Click **Reset Location** to reset the location of the pop-up note.
- When file attachment comments are selected, the **Arrange** tab is also available and can be used to manipulate comments as detailed [here](#).<sup>1626</sup>

Note that the [Comment Styles Palette](#)<sup>1242</sup> can be used to edit and save customized file attachment annotation styles for subsequent use, and the [Commenting](#)<sup>875</sup> preferences can be used to view/edit preferences for all comments.

---

10.4.4.7 Sound Tool



**Sound Tool**

Click the **Sound Tool** to add audio content to documents:

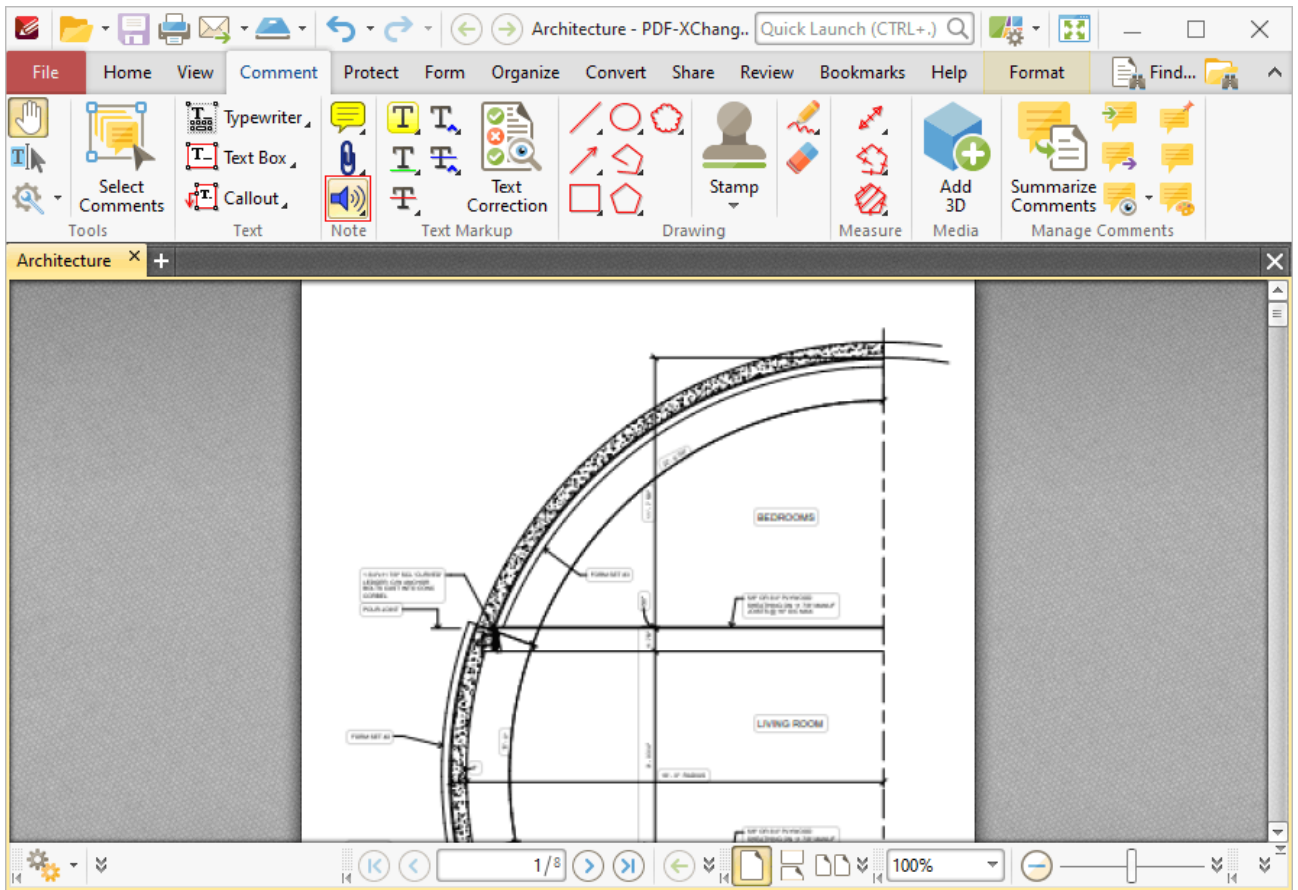

Figure 1. Comment Tab, Sound Tool

When the **Sound Tool** is selected, the pointer becomes a crosshairs icon. Move the icon to the desired location and click the mouse. The **Edit Action: "Play a Sound"** dialog box will open:

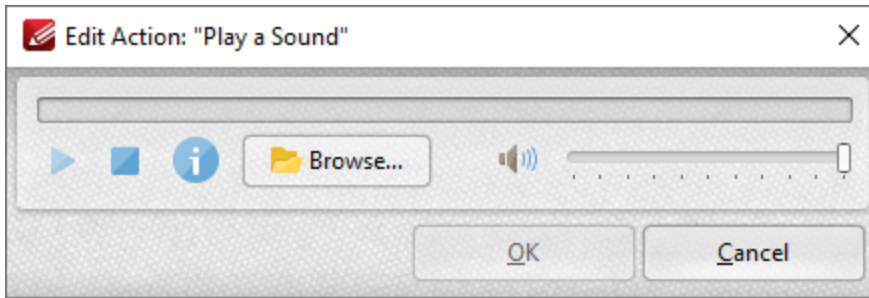

Figure 2. Edit Action: "Play a Sound" Dialog Box

- Click the **Browse** button to select a sound file from the local computer. The **Open Files** dialog box will open. Select the desired file and click **Open**. An icon will appear in the document as detailed in (figure 3). The selected sound file will play when the icon is clicked.
- Alternatively, click the record button to record a sound with a microphone. Click again to finish the recording. Click the play/stop buttons to review the sound, and use the slider to adjust the volume. Click **OK** when the desired sound has been recorded. The icon will then appear in the document:

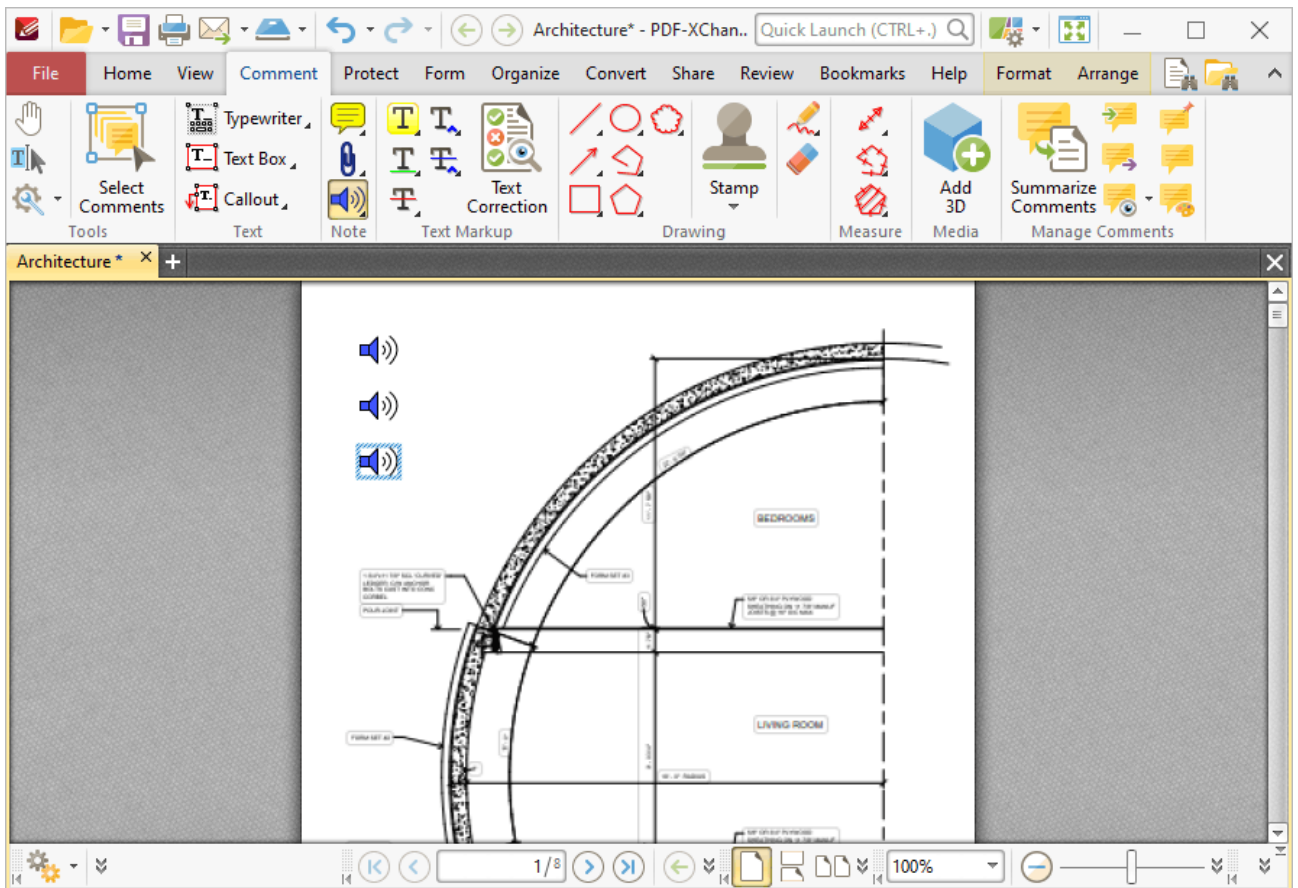

Figure 3. Sound Tool Examples

- Click and drag the icon, or use the arrow keys, to reposition it. Hold down Shift to move at an increased increment when using the arrow keys.

- Double-click icons to open the associated sound file.
- Right-click icons for further options. See [here](#)<sup>1783</sup> for an explanation of those options.
- Press Ctrl+' to open the **Properties** pane for selected sound comments and view/edit properties:

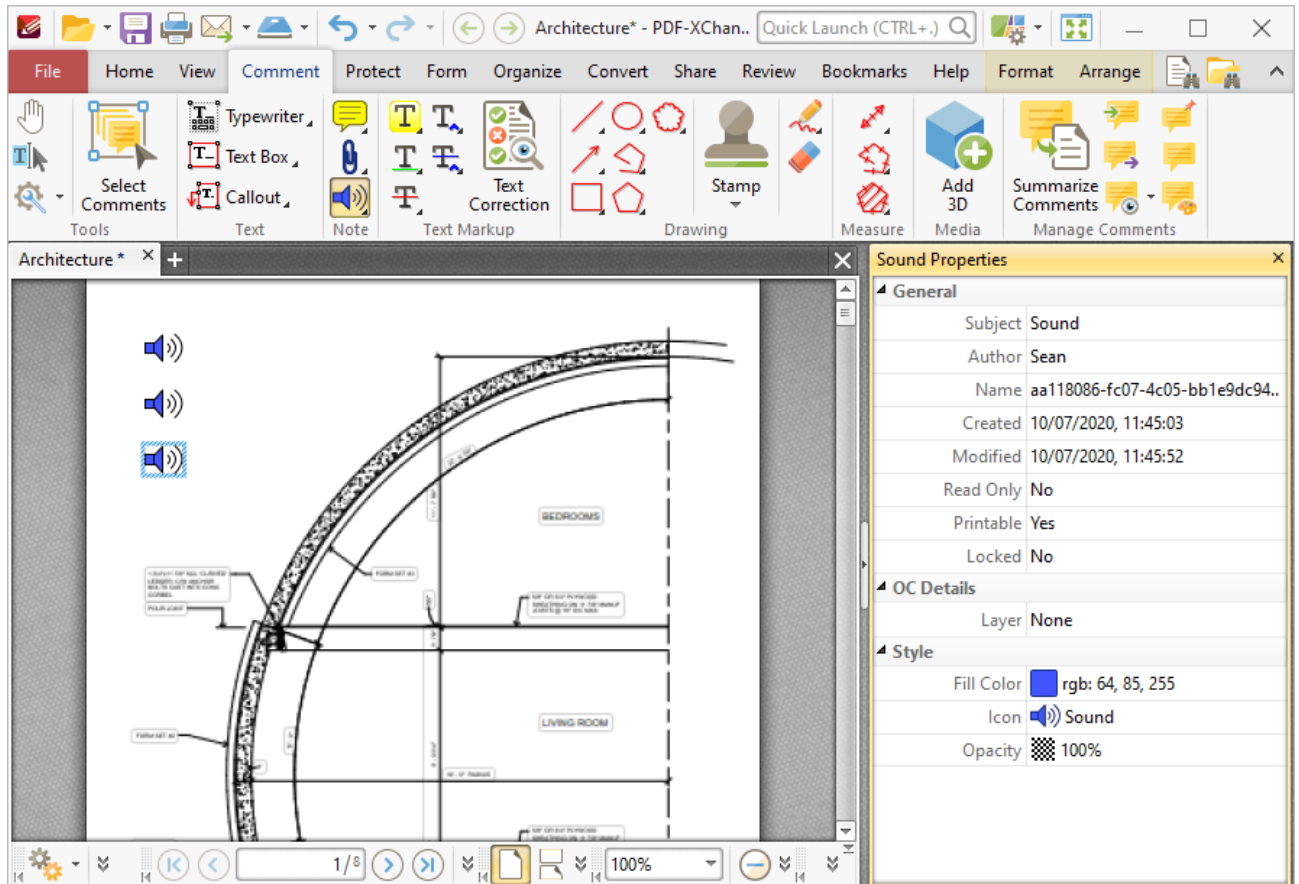

Figure 4. Sound Tool, Sound Properties Pane

- **Subject** is the name of the sound comment, as referenced in the [Comments](#)<sup>1007</sup> pane.
- **Author** is the name of the user that created the sound comment.
- **Name** is the unique name of the sound comment, as referenced within the application.
- **Created** is the date and time at which the sound comment was created.
- **Modified** is the date and time at which the sound comment was last modified.
- **Read Only** is the read only status of the sound comment. If this property is enabled then users cannot interact with the comment. Please note that it is necessary to use JavaScript to change the value of this property.
- **Printable** is the print status of the sound comment. If this property is enabled then the comment is printed with the document. If this property is not enabled then the comment is not printed.
- **Locked** is the locked status of the sound comment. If this property is enabled then the comment cannot be deleted and its properties (including its position and size) cannot be modified by users.

- **Layer** specifies the optional content layer to which the sound comment belongs. Further information about layers is available [here](#).
- **Fill Color** determines the color of the sound comment.
- **Icon** determines the icon used for the sound comment.
- **Opacity** determines the level of transparency in the sound comment.

Note that when the **Sound Tool** is enabled, the **Format** tab is available and can be used to customize the default properties of sound comments:

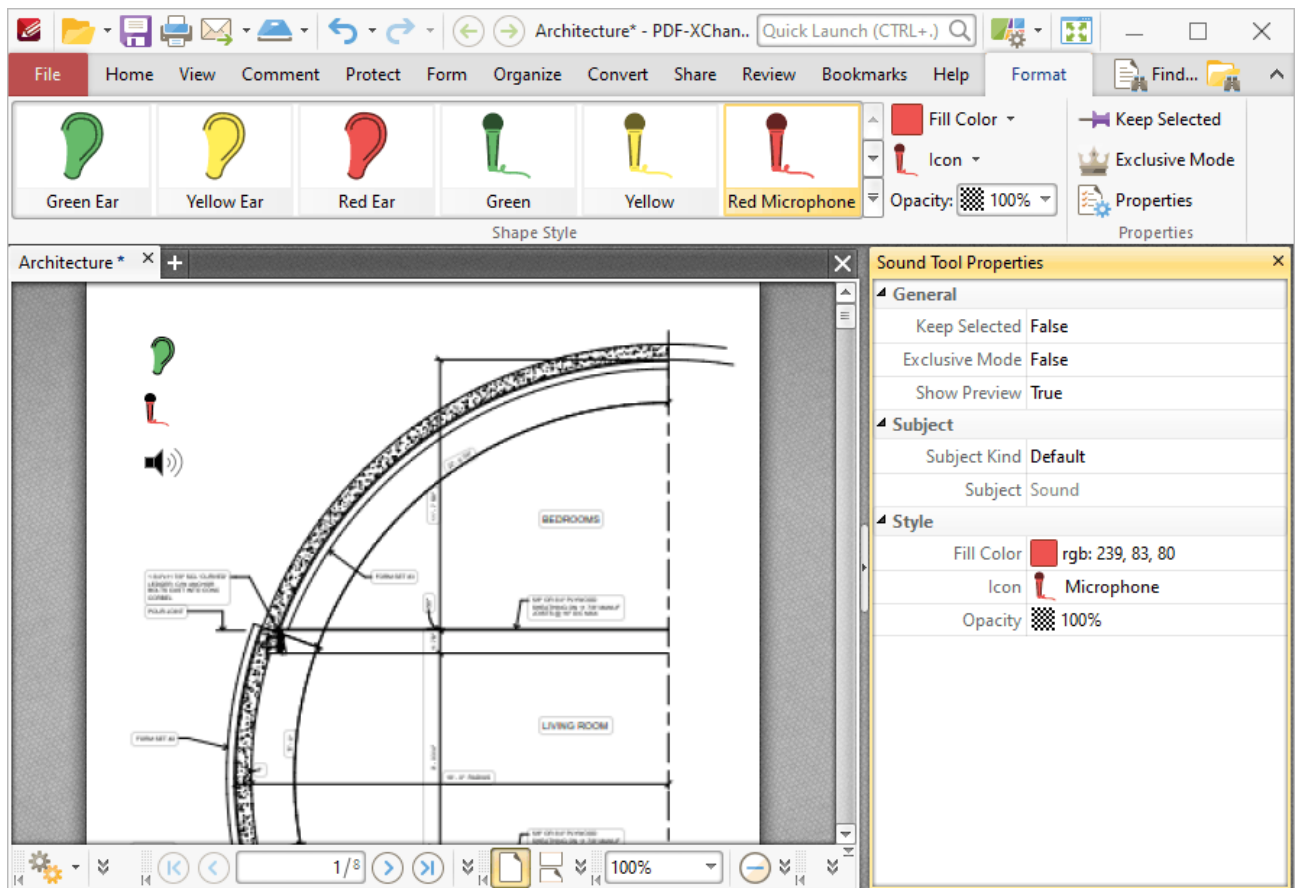

Figure 5. Format Tab, Sound Tool

- Click options in the **Shape Style** group to select alternative default sound annotation styles.
- Click **Keep Selected** to keep the **Sound Tool** enabled and add multiple sound annotations to the document. If this option is not enabled then **PDF-XChange Editor** will revert to the designated default tool immediately after creating one sound annotation.
- Click **Exclusive Mode** to enable exclusive mode, which simplifies the process of using the **Sound Tool**. When **Exclusive Mode** is enabled, the pointer ignores all interactive elements of documents other than base content. This makes it possible to create sound annotations on areas that overlap with other content without the risk of accidentally selecting undesired items. When **Exclusive Mode** is disabled, the pointer recognizes and interacts with all underlying elements in the usual manner.

- Click **Properties** to open the **Properties** pane and view/edit **Sound Tool** properties, as detailed above.
- When sound comments are selected, the **Style Tools** dropdown menu is available in the **Format** tab. It contains the following options:
  - Click **Copy Comment Style** to copy the style properties of comments.
  - Click **Apply Copied Comment Style** to apply a copied comment style to selected comments, including the text properties.
  - Click **Apply Copied Comment Appearance** to apply copied comment styles to selected comments.
  - Click **Apply Copied Text Style** to apply copied text styles to selected comments.
  - Click **Make Current Properties Default** to set the properties of the selected comment as the default properties for subsequent comments.
  - Click **Apply Default Properties** to apply the default comment properties to selected comments.
  - Click **Make Current Text Format Default** to set the text format of selected comments as the default format for subsequent comments.
  - Click **Apply Default Text Format** to apply the default text format to the text of selected comments.
- When sound comments are selected, the **Pop-up** group is available in the **Format** tab and can be used to interact with the pop-up note of the comment:
  - Click **Open** to open the pop-up note.
  - Click **Hide** to hide the pop-up note.
  - Click **Reset Location** to reset the location of the pop-up note.
- When sound comments are selected, the **Arrange** tab is also available and can be used to manipulate comments as detailed [here](#).<sup>1626</sup>

Note that the [Comment Styles Palette](#)<sup>1242</sup> can be used to edit and save customized sound annotation styles for subsequent use, and the [Commenting](#)<sup>875</sup> preferences can be used to view/edit preferences for all comments.

---

10.4.4.8 Highlight Text Tool



Highlight Text Tool

Click **Highlight** to add highlight annotations to document text:

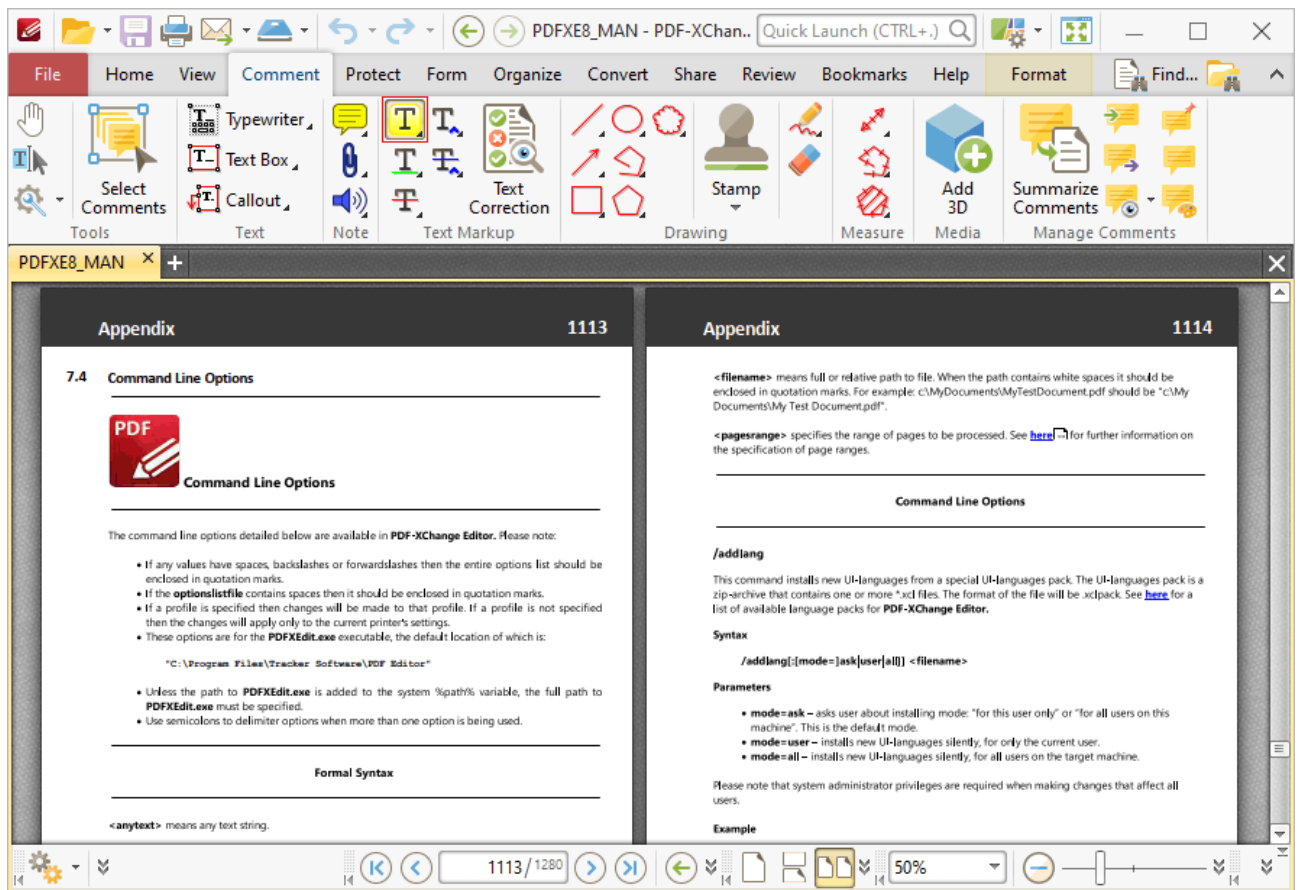

Figure 1. Comment Tab, Highlight Text Tool

When the **Highlight Text Tool** is enabled, the pointer icon changes when it is hovered over text. Click and drag to highlight text:



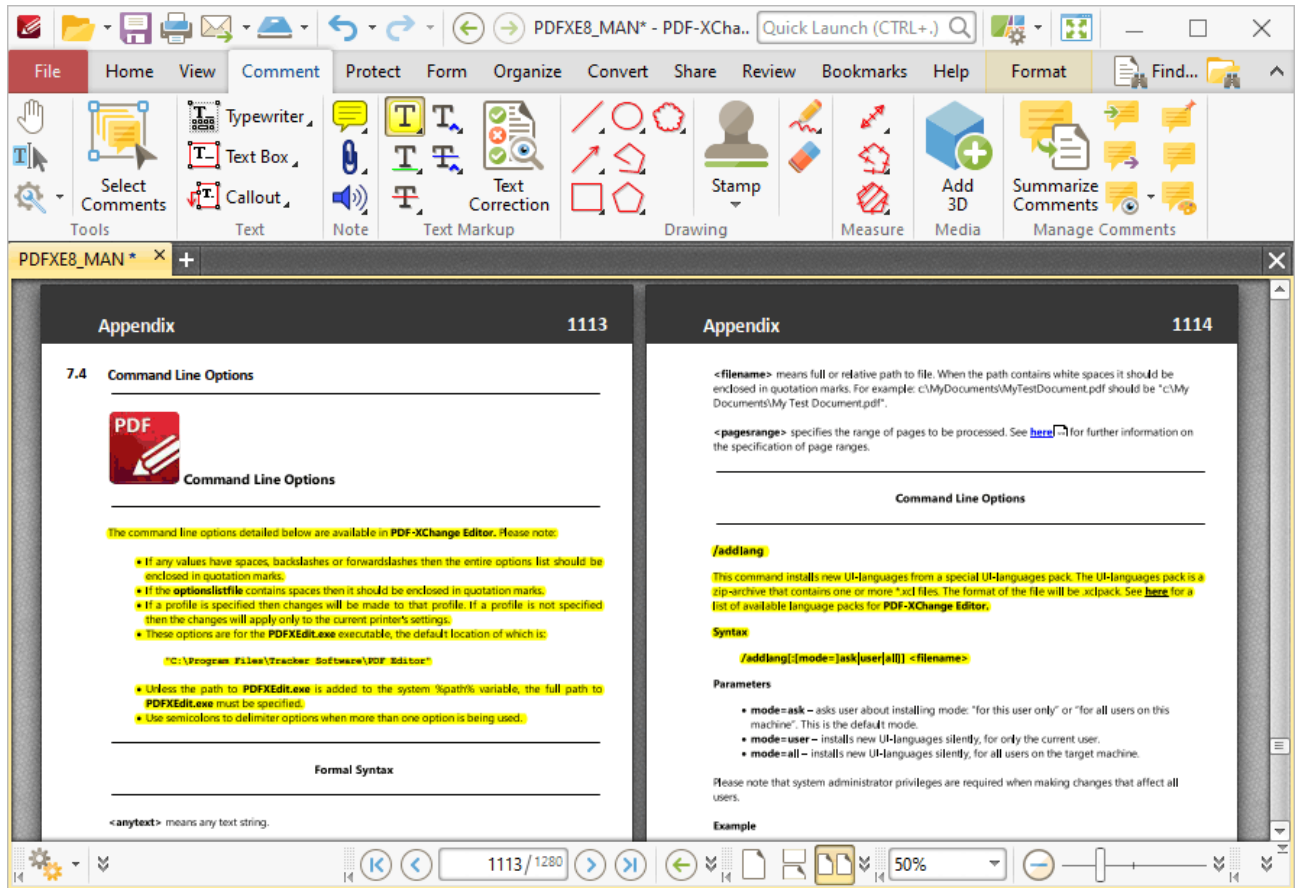

Figure 2. Highlight Text Tool Example

Press Ctrl+' to open the **Properties** pane for selected highlight annotations and view/edit properties:

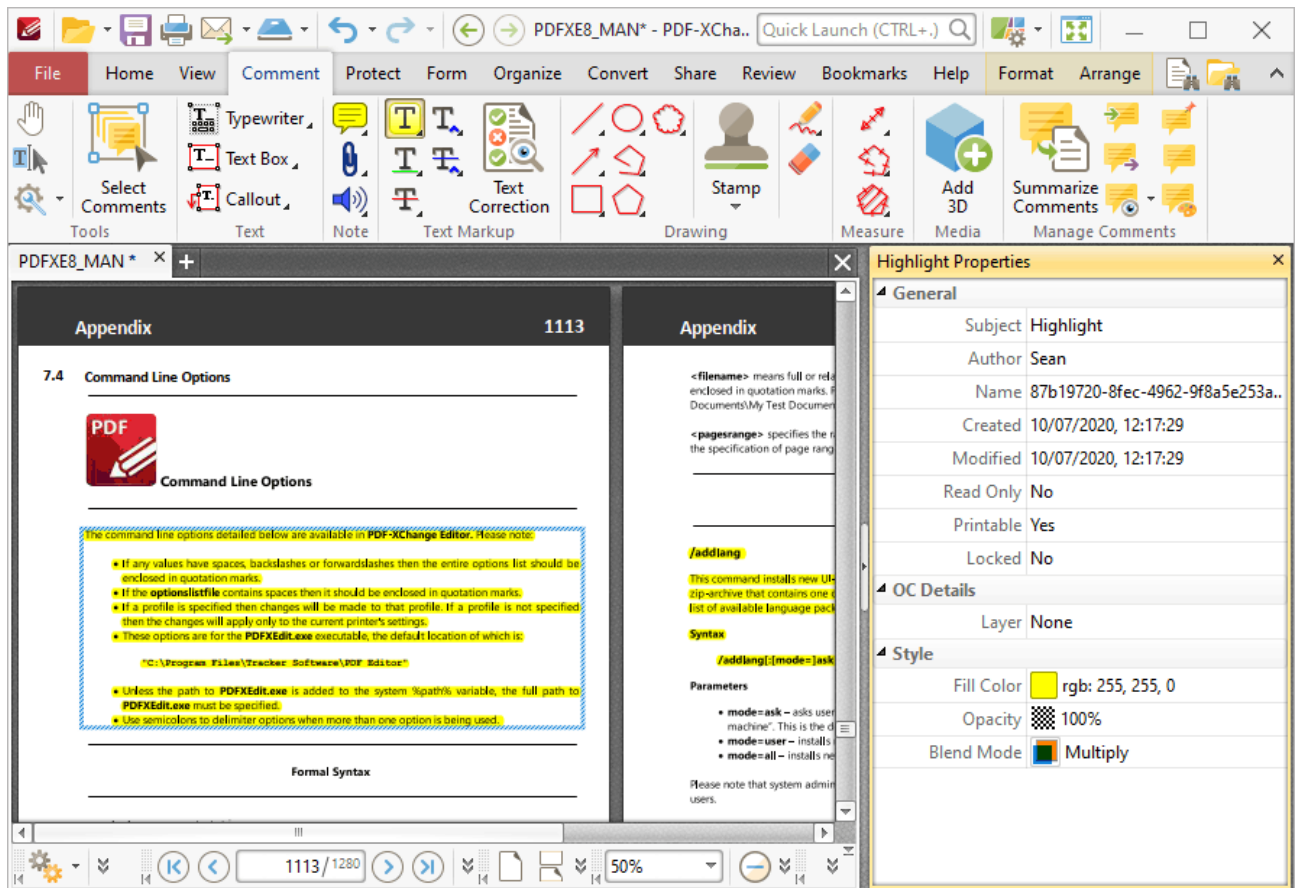

Figure 3. Highlight Text Tool, Highlight Properties Pane

- **Subject** is the name of the highlight annotation, as referenced in the [Comments](#)<sup>1007</sup> pane.
- **Author** is the name of the user that created the highlight annotation.
- **Name** is the unique name of the highlight annotation, as referenced within the application.
- **Created** is the date and time at which the highlight annotation was created.
- **Modified** is the date and time at which the highlight annotation was last modified.
- **Read Only** is the read only status of the highlight annotation. If this property is enabled then users cannot interact with the annotation. Please note that it is necessary to use JavaScript to change the value of this property.
- **Printable** is the print status of the highlight annotation. If this property is enabled then the annotation is printed with the document. If this property is not enabled then the annotation is not printed.
- **Locked** is the locked status of the highlight annotation. If this property is enabled then the annotation cannot be deleted and its properties (including its position and size) cannot be modified by users.
- **Layer** specifies the optional content layer to which the highlight annotation belongs. Further information about layers is available [here](#).<sup>1024</sup>
- **Fill Color** determines the color of the highlight annotation.
- **Opacity** determines the level of transparency in the highlight annotation.

- **Blend Mode** determines how highlight annotations blend with overlapping content. These options are explained [here](#).

Note that when the **Highlight Text Tool** is enabled, the **Format** tab is available and can be used to customize the default properties of highlight annotations:

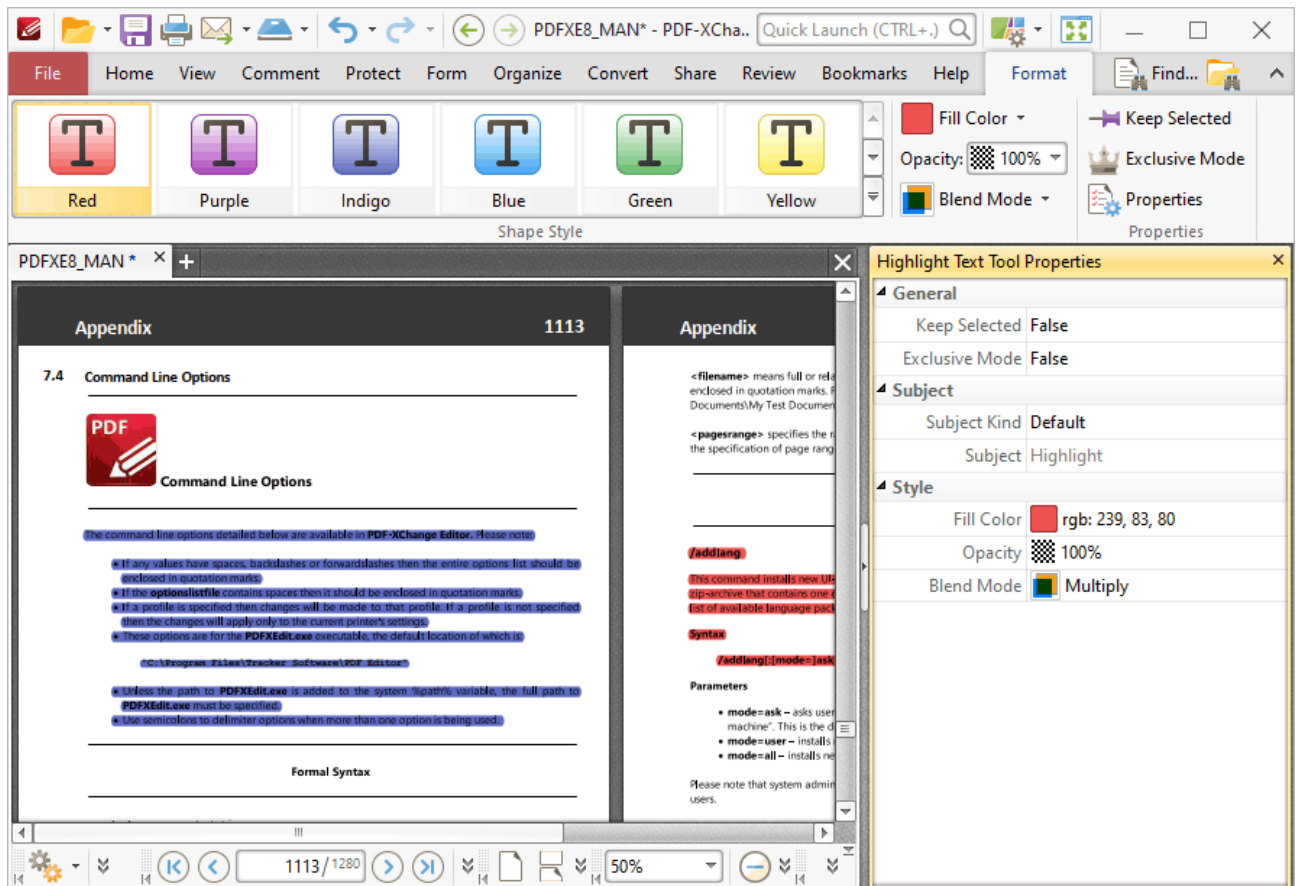

Figure 4. Format Tab, Highlight Text Tool

- Click options in the **Shape Style** group to select alternative default highlight annotation styles.
- Click **Fill Color** to determine the color of the highlight annotation.
- Use the **Opacity** dropdown menu to determine the level of transparency for the highlight annotation.
- Use the **Blend Mode** dropdown menu to determine how highlight annotations blend with overlapping content. These options are explained [here](#).
- Click **Keep Selected** to keep the **Highlight Tool** enabled and add multiple highlight annotations to the document. If this option is not enabled then **PDF-XChange Editor** will revert to the designated default tool immediately after creating one highlight annotation.
- Click **Exclusive Mode** to enable exclusive mode, which simplifies the process of using the **Highlight Tool**. When **Exclusive Mode** is enabled, the pointer ignores all interactive elements of documents other than base content. This makes it possible to create highlight annotations on areas that overlap with other content without the risk of accidentally selecting undesired

items. When **Exclusive Mode** is disabled, the pointer recognizes and interacts with all underlying elements in the usual manner.

- Click **Properties** to open the **Properties** pane and view/edit **Highlight Tool** properties, as detailed above.
- When highlight annotations are selected, the **Style Tools** dropdown menu is available in the **Format** tab. It contains the following options:
  - Click **Copy Comment Style** to copy the style properties of highlight annotations.
  - Click **Apply Copied Comment Style** to apply a copied highlight annotation style to selected annotations.
  - Click **Apply Copied Comment Appearance** to apply a copied highlight annotation style to selected annotations.
  - Click **Make Current Properties Default** to set the properties of the highlight annotation as the default properties for subsequent annotations.
  - Click **Apply Default Properties** to apply the default highlight annotation properties to selected highlight annotations.
- When highlight annotations are selected, the **Pop-up** group is available in the **Format** tab and can be used to interact with the pop-up note of the annotation:
  - Click **Open** to open the pop-up note.
  - Click **Hide** to hide the pop-up note.
  - Click **Reset Location** to reset the location of the pop-up note.
- When highlight annotations are selected, the **Arrange** tab is also available and can be used to manipulate comments as detailed [here](#).

Note that the [Comment Styles Palette](#) can be used to edit and save customized highlight annotation styles for subsequent use, and the [Commenting](#) preferences can be used to view/edit preferences for all comments.

---

10.4.4.9 Underline Text Tool



**Underline Text Tool**

Click **Underline** to add underline annotations to document text:

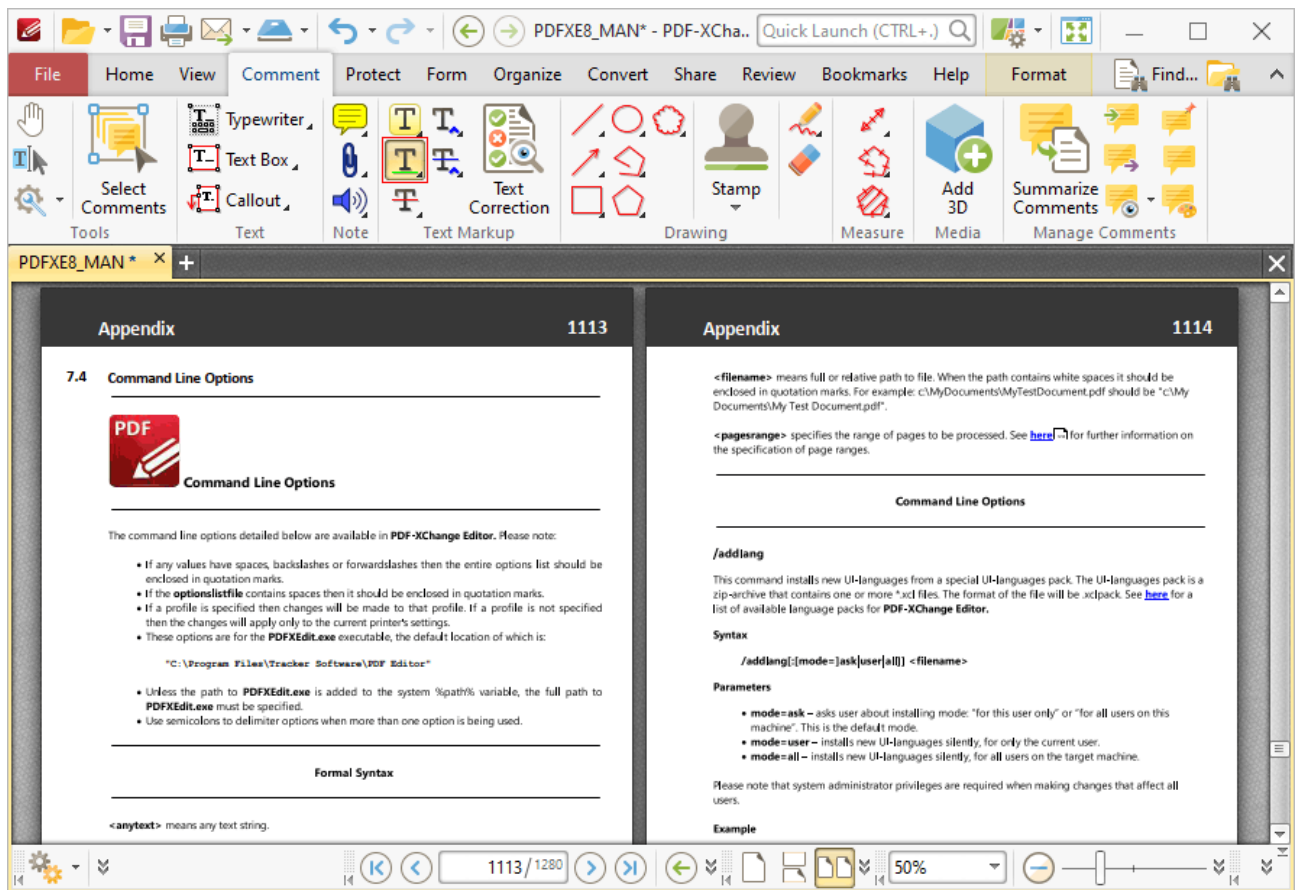

Figure 1. Comment Tab, Underline Text Tool

When the **Underline Text Tool** is enabled, the pointer icon changes when it is hovered over text. Click and drag to underline text:

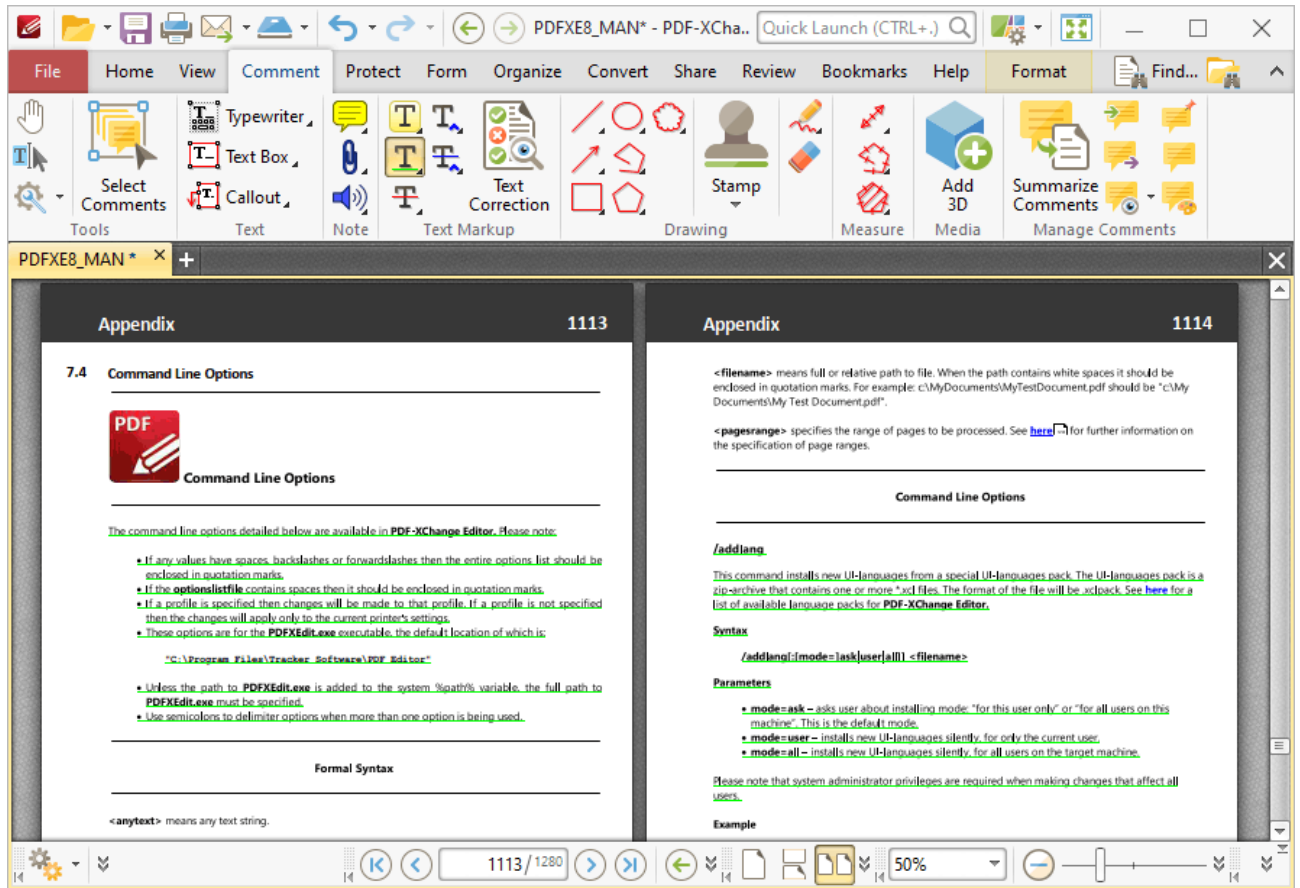

Figure 2. Underline Text Tool Example

Press Ctrl+' to open the **Properties** pane for selected underline annotations and view/edit properties:

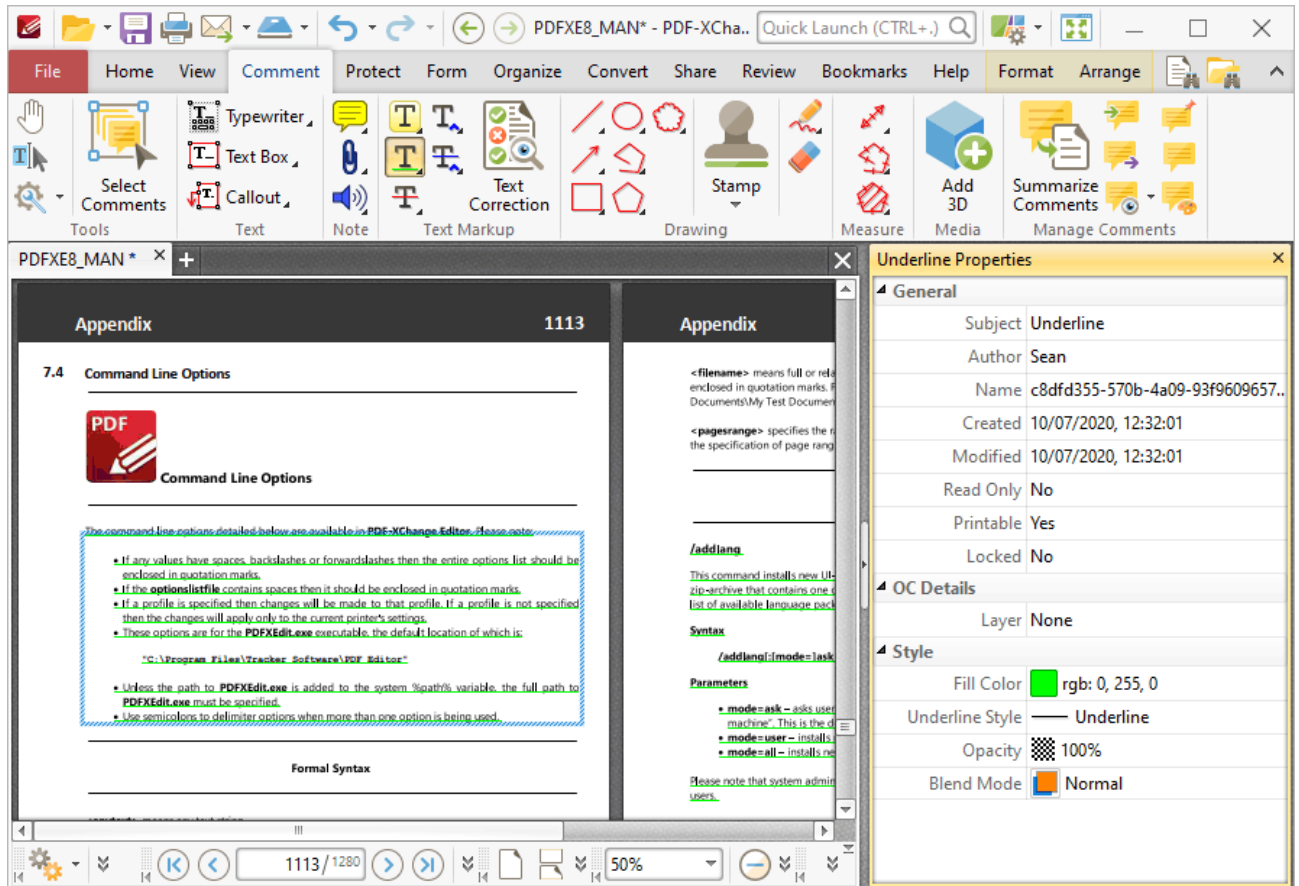

Figure 3. Underline Text Tool, Underline Properties Pane

- **Subject** is the name of the underline annotation, as referenced in the [Comments](#)<sup>1007</sup> pane.
- **Author** is the name of the user that created the underline annotation.
- **Name** is the unique name of the underline annotation, as referenced within the application.
- **Created** is the date and time at which the underline annotation was created.
- **Modified** is the date and time at which the underline annotation was last modified.
- **Read Only** is the read only status of the underline annotation. If this property is enabled then users cannot interact with the annotation. Please note that it is necessary to use JavaScript to change the value of this property.
- **Printable** is the print status of the underline annotation. If this property is enabled then the annotation is printed with the document. If this property is not enabled then the annotation is not printed.
- **Locked** is the locked status of the underline annotation. If this property is enabled then the annotation cannot be deleted and its properties (including its position and size) cannot be modified by users.
- **Layer** specifies the optional content layer to which the underline annotation belongs. Further information about layers is available [here](#).<sup>1024</sup>
- **Fill Color** determines the color of the underline annotation.
- **Opacity** determines the level of transparency in the underline annotation.

- **Blend Mode** determines how underline annotations blend with overlapping content. These options are explained [here](#).

Note that when the **Underline Text Tool** is enabled, the **Format** tab is available and can be used to customize the default properties of underline annotations:

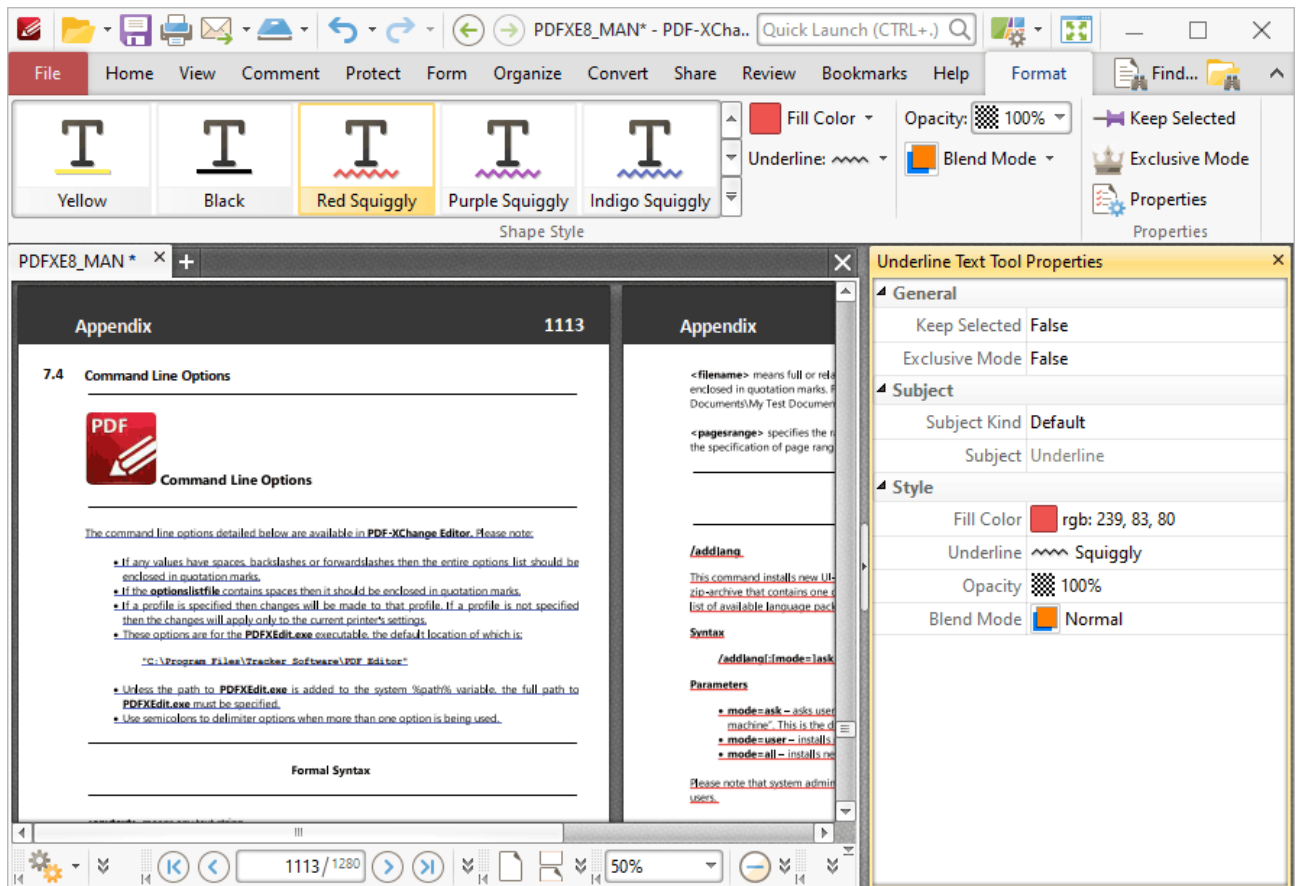

Figure 4. Format Tab, Underline Text Tool

- Click options in the **Shape Style** group to select alternative default underline annotation styles.
- Click **Keep Selected** to keep the **Underline Tool** enabled and add multiple underline annotations to the document. If this option is not enabled then **PDF-XChange Editor** will revert to the designated default tool immediately after creating one underline annotation.
- Click **Exclusive Mode** to enable exclusive mode, which simplifies the process of using the **Underline Tool**. When **Exclusive Mode** is enabled, the pointer ignores all interactive elements of documents other than base content. This makes it possible to create underline annotations on areas that overlap with other content without the risk of accidentally selecting undesired items. When **Exclusive Mode** is disabled, the pointer recognizes and interacts with all underlying elements in the usual manner.
- Click **Properties** to open the **Properties** pane and view/edit **Underline Tool** properties, as detailed above.



- When underline annotations are selected, the **Style Tools** dropdown menu is available in the **Format** tab. It contains the following options:
  - Click **Copy Comment Style** to copy the style properties of underline annotations.
  - Click **Apply Copied Comment Style** to apply a copied underline annotation style to selected annotations.
  - Click **Apply Copied Comment Appearance** to apply a copied underline annotation style to selected annotations.
  - Click **Make Current Properties Default** to set the properties of the underline annotation as the default properties for subsequent annotations.
  - Click **Apply Default Properties** to apply the default underline annotation properties to selected underline annotations.
- When underline annotations are selected, the **Pop-up** group is available in the **Format** tab and can be used to interact with the pop-up note of the annotation:
  - Click **Open** to open the pop-up note.
  - Click **Hide** to hide the pop-up note.
  - Click **Reset Location** to reset the location of the pop-up note.
- When underline annotations are selected, the **Arrange** tab is also available and can be used to manipulate comments as detailed [here](#).<sup>1626</sup>

Note that the [Comment Styles Palette](#)<sup>1242</sup> can be used to edit and save customized underline annotation styles for subsequent use, and the [Commenting](#)<sup>875</sup> preferences can be used to view/edit preferences for all comments.

---

10.4.4.10 Strikeout Text Tool



Strikeout Text Tool

Click **Strikeout** to add strikeout annotations to document text:

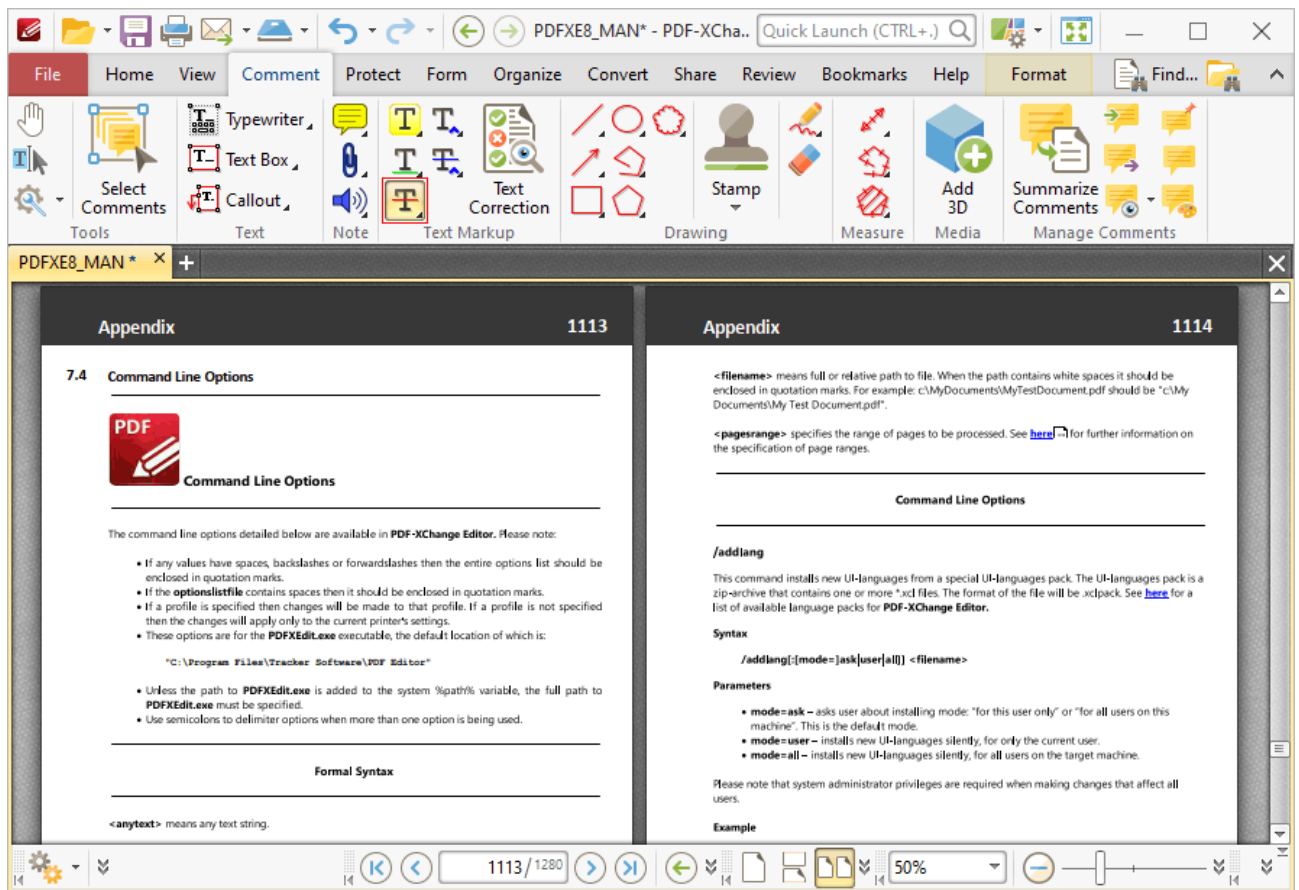

Figure 1. Comment Tab, Strikeout Text Tool

When the **Strikeout Text Tool** is enabled, the pointer icon changes when it is hovered over text. Click and drag to strikeout text:

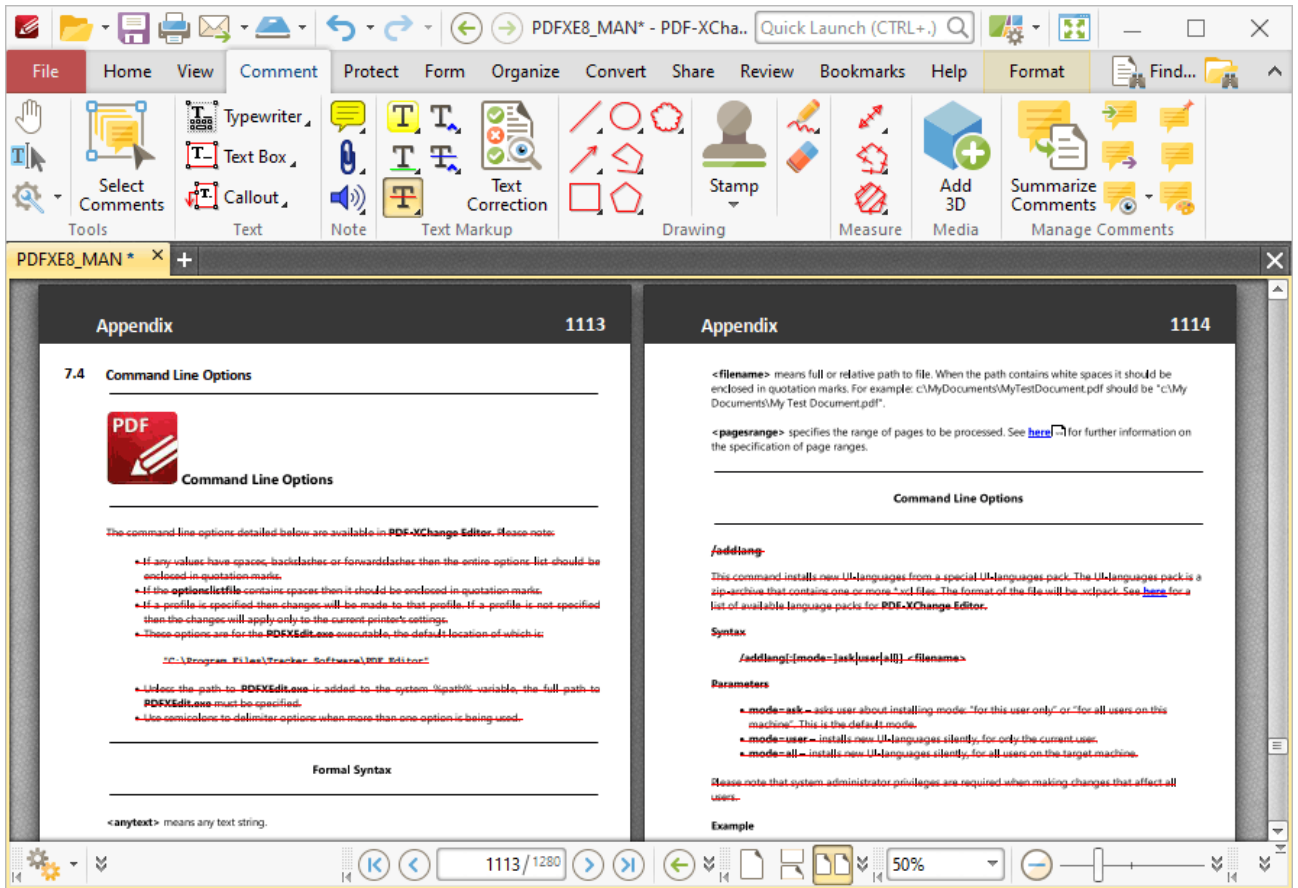

Figure 2. Strikeout Text Tool Example

Press Ctrl+' to open the **Properties** pane for selected strikeout annotations and view/edit properties:

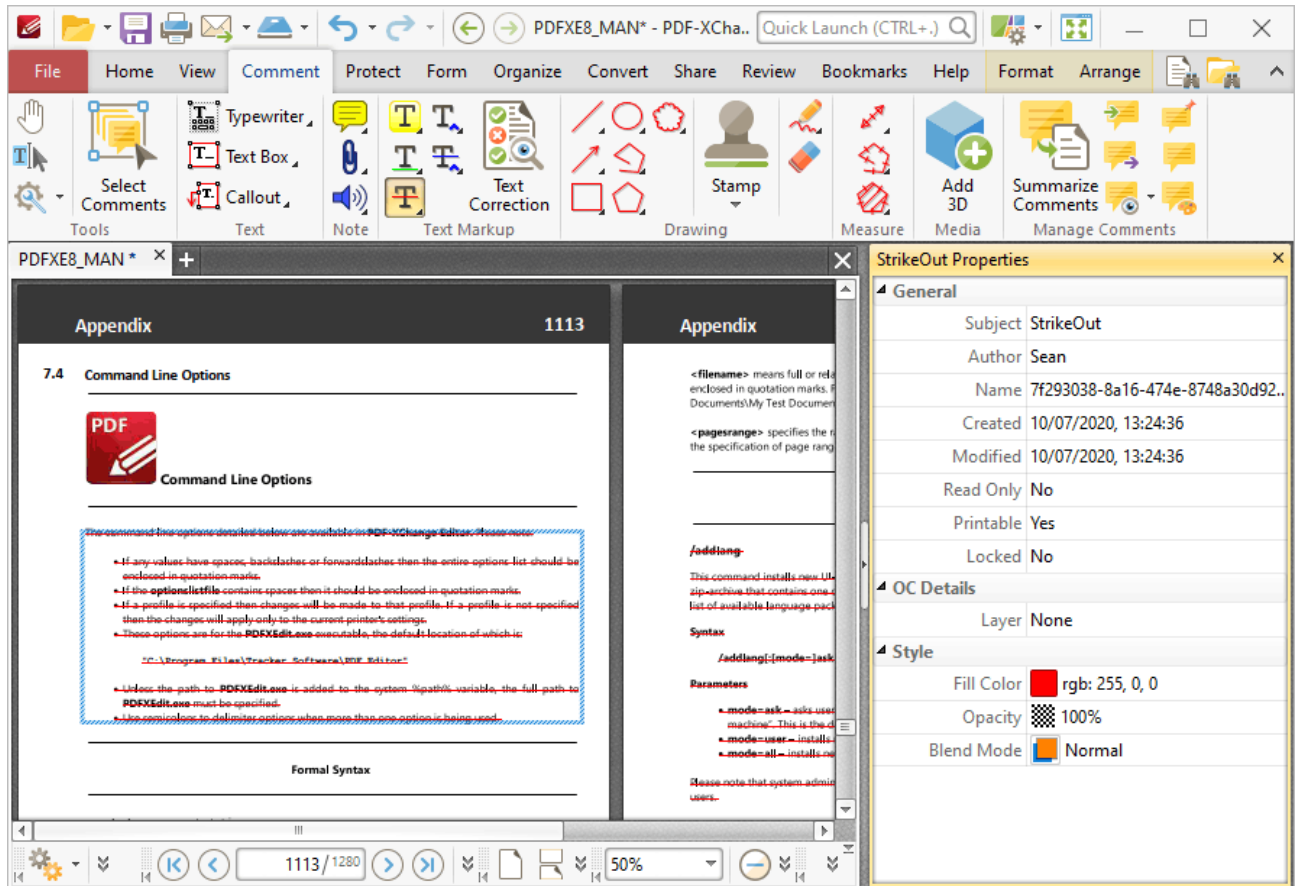

Figure 3. Strikeout Text Tool, StrikeOut Properties Pane

- **Subject** is the name of the strikeout annotation, as referenced in the [Comments](#) <sup>1007</sup> pane.
- **Author** is the name of the user that created the strikeout annotation.
- **Name** is the unique name of the strikeout annotation, as referenced within the application.
- **Created** is the date and time at which the strikeout annotation was created.
- **Modified** is the date and time at which the strikeout annotation was last modified.
- **Read Only** is the read only status of the strikeout annotation. If this property is enabled then users cannot interact with the annotation. Please note that it is necessary to use JavaScript to change the value of this property.
- **Printable** is the print status of the strikeout annotation. If this property is enabled then the annotation is printed with the document. If this property is not enabled then the annotation is not printed.
- **Locked** is the locked status of the strikeout annotation. If this property is enabled then the annotation cannot be deleted and its properties (including its position and size) cannot be modified by users.
- **Layer** specifies the optional content layer to which the strikeout annotation belongs. Further information about layers is available [here](#). <sup>1024</sup>
- **Fill Color** determines the color of the strikeout annotation.
- **Opacity** determines the level of transparency in the strikeout annotation.

- **Blend Mode** determines how strikeout annotations blend with overlapping content. These options are explained [here](#).

Note that when the **Strikeout Text Tool** is enabled, the **Format** tab is available and can be used to customize the default properties of strikeout annotations:

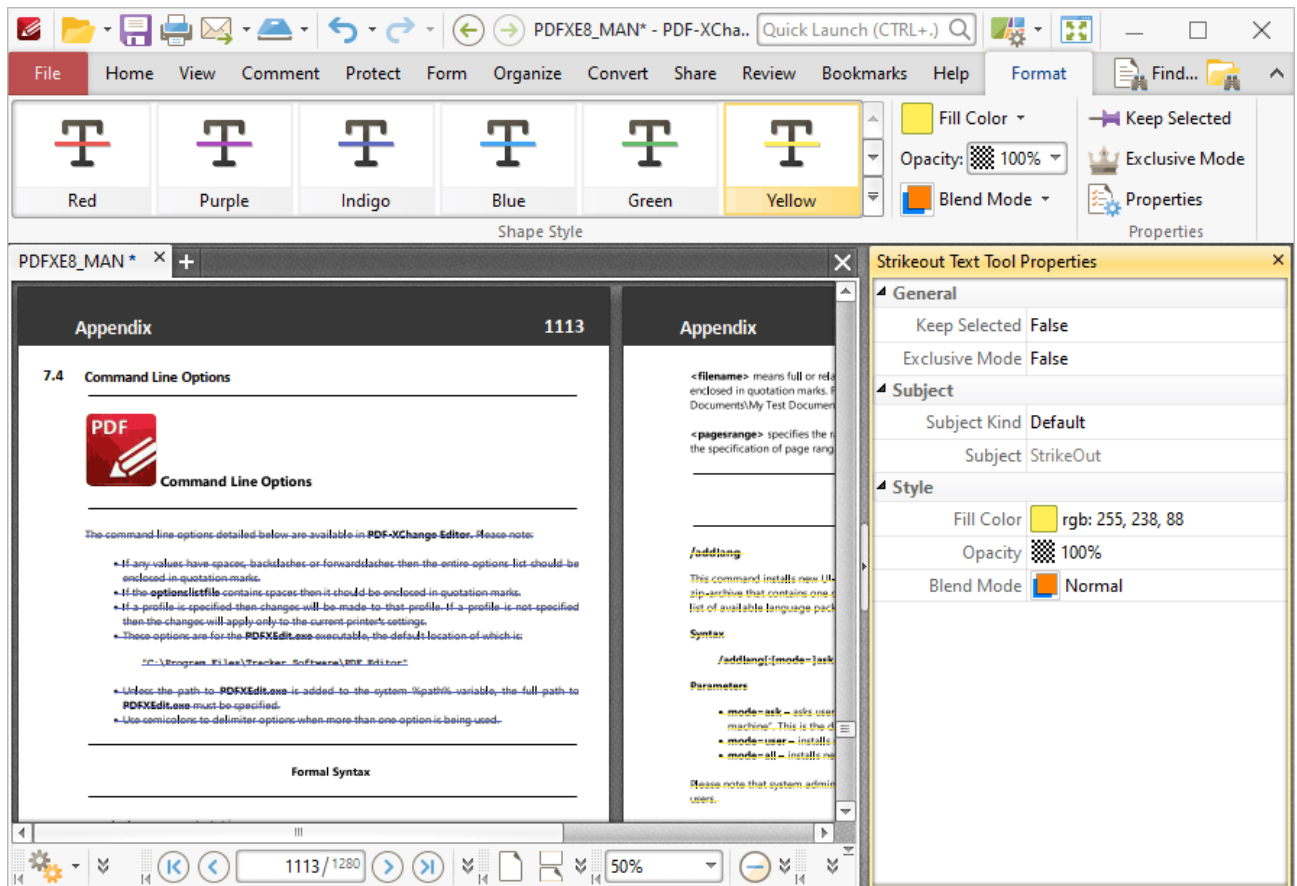

Figure 4. Format Tab, Strikeout Text Tool

- Click options in the **Shape Style** group to select alternative default strikeout annotation styles.
- Click **Keep Selected** to keep the **Strikeout Tool** enabled and add multiple strikeout annotations to the document. If this option is not enabled then **PDF-XChange Editor** will revert to the designated default tool immediately after creating one strikeout annotation.
- Click **Exclusive Mode** to enable exclusive mode, which simplifies the process of using the **Strikeout Tool**. When **Exclusive Mode** is enabled, the pointer ignores all interactive elements of documents other than base content. This makes it possible to create strikeout annotations on areas that overlap with other content without the risk of accidentally selecting undesired items. When **Exclusive Mode** is disabled, the pointer recognizes and interacts with all underlying elements in the usual manner.
- Click **Properties** to open the **Properties** pane and view/edit **Strikeout Tool** properties, as detailed above.

- When strikethrough annotations are selected, the **Style Tools** dropdown menu is available in the **Format** tab. It contains the following options:
  - Click **Copy Comment Style** to copy the style properties of strikethrough annotations.
  - Click **Apply Copied Comment Style** to apply a copied strikethrough annotation style to selected annotations.
  - Click **Apply Copied Comment Appearance** to apply a copied strikethrough annotation style to selected annotations.
  - Click **Make Current Properties Default** to set the properties of the strikethrough annotation as the default properties for subsequent annotations.
  - Click **Apply Default Properties** to apply the default strikethrough annotation properties to selected strikethrough annotations.
- When strikethrough annotations are selected, the **Pop-up** group is available in the **Format** tab and can be used to interact with the pop-up note of the annotation:
  - Click **Open** to open the pop-up note.
  - Click **Hide** to hide the pop-up note.
  - Click **Reset Location** to reset the location of the pop-up note.
- When strikethrough annotations are selected, the **Arrange** tab is also available and can be used to manipulate comments as detailed [here](#).<sup>1626</sup>

Note that the [Comment Styles Palette](#)<sup>1242</sup> can be used to edit and save customized strikethrough annotation styles for subsequent use, and the [Commenting](#)<sup>875</sup> preferences can be used to view/edit preferences for all comments.

---

10.4.4.11 Insert Text Tool



Insert Text Tool

The **Insert Text** tool is used when editing documents that contain text. The tool inserts caret annotations that contain pop-up notes. The creator of the annotation can add their suggestions to the pop-up note for text that should be inserted at the location of the caret annotation. Subsequent users of the document can double-click the caret annotation in order to view its pop-up note and the suggested changes that it contains.

Click **Insert Text Tool** to use this tool:

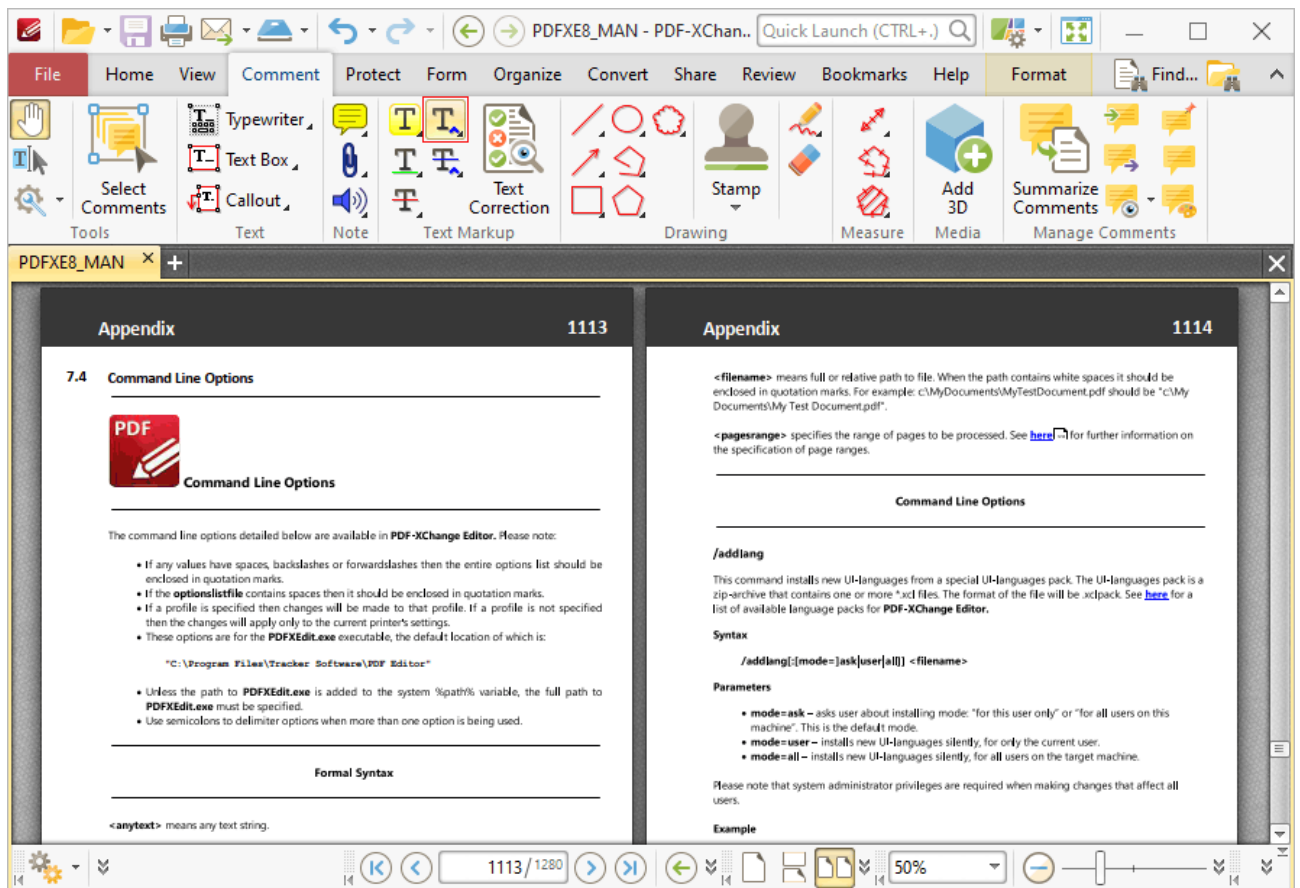

Figure 1. Comment Tab, Insert Text Tool

When the **Insert Text Tool** is enabled, click and drag over the text that you want to annotate:

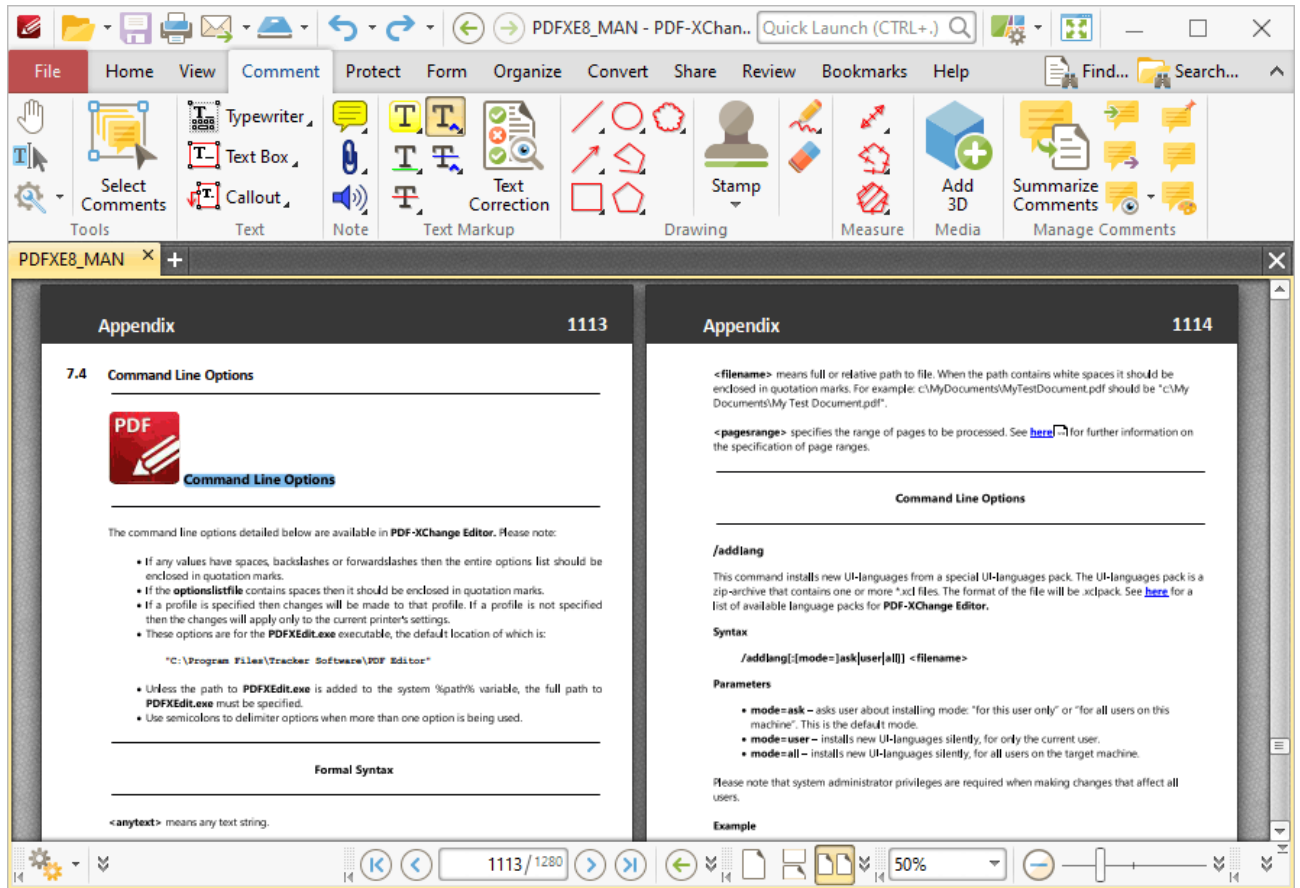

Figure 2. Insert Text Tool Active

When you release the mouse button, a caret annotation will be added on the right side of the selected text. Double click the annotation to open its pop-up note, then enter the desired text:



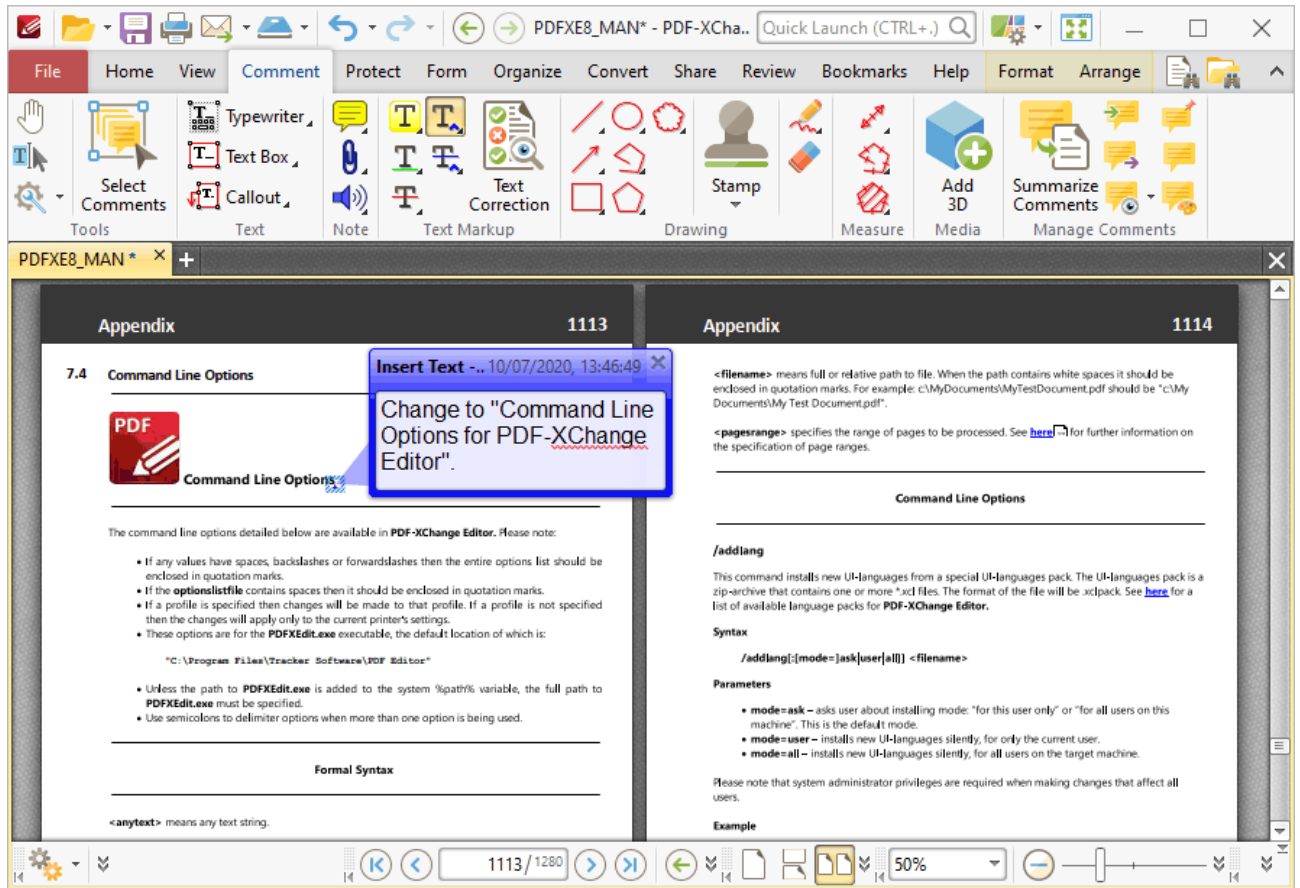

Figure 3. Insert Text Pop-up Note Expanded and Edited

Press Ctrl+' to open the **Properties** pane for selected annotations and view/edit properties:

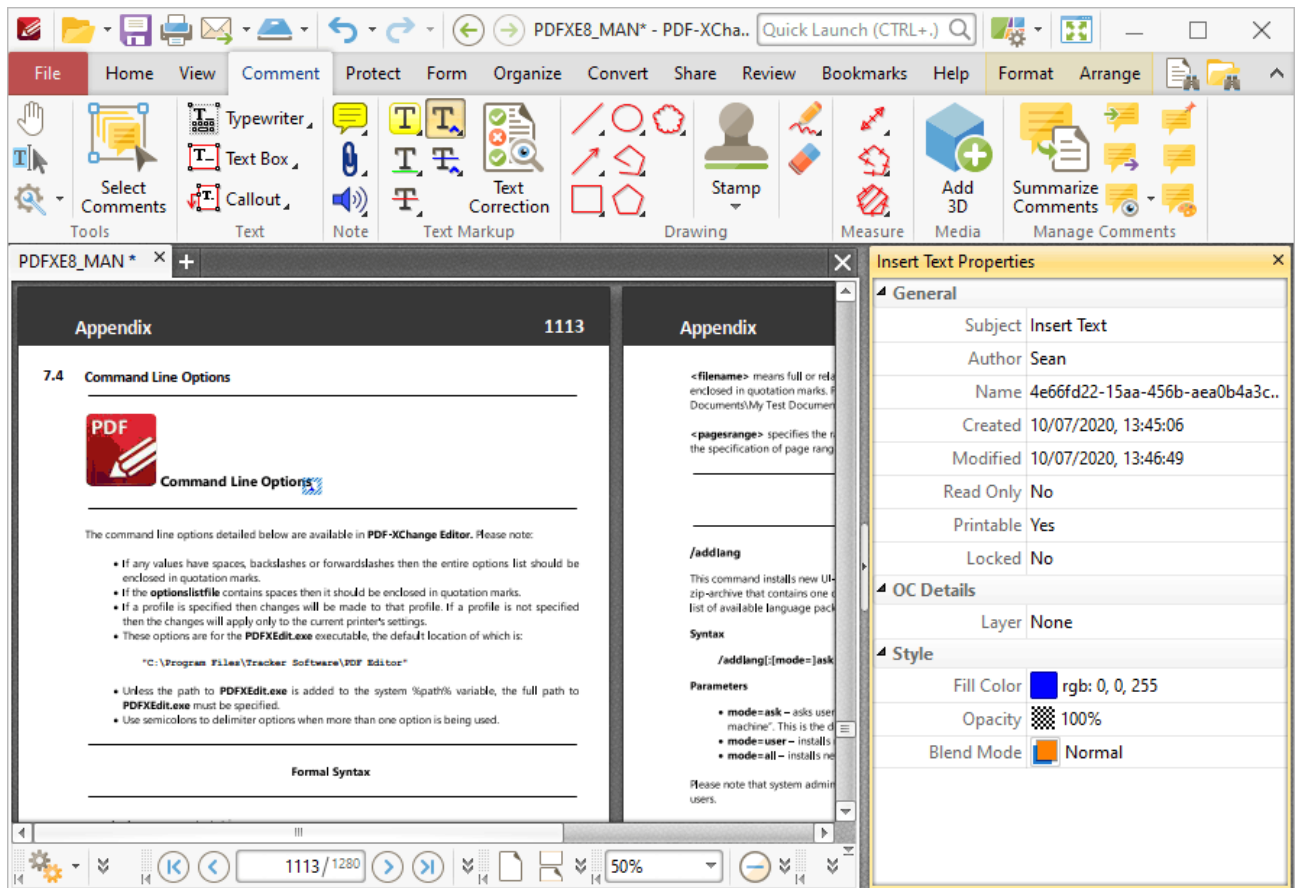

Figure 3. Insert Text Tool, Insert Text Properties Pane

- **Subject** is the name of the caret annotation, as referenced in the [Comments](#) <sup>1007</sup> pane.
- **Author** is the name of the user that created the caret annotation.
- **Name** is the unique name of the caret annotation, as referenced within the application.
- **Created** is the date and time at which the caret annotation was created.
- **Modified** is the date and time at which the caret annotation was last modified.
- **Read Only** is the read only status of the caret annotation. If this property is enabled then users cannot interact with the annotation. Please note that it is necessary to use JavaScript to change the value of this property.
- **Printable** is the print status of the caret annotation. If this property is enabled then the annotation is printed with the document. If this property is not enabled then the annotation is not printed.
- **Locked** is the locked status of the caret annotation. If this property is enabled then the annotation cannot be deleted and its properties (including its position and size) cannot be modified by users.
- **Layer** specifies the optional content layer to which the caret annotation belongs. Further information about layers is available [here](#). <sup>1024</sup>
- **Fill Color** determines the color of the caret annotation.
- **Opacity** determines the level of transparency in the caret annotation.

- **Blend Mode** determines how caret annotations blend with overlapping content. These options are explained [here](#).

Note that when the **Insert Text Tool** is enabled, the **Format** tab is available and can be used to customize the default properties of caret annotations:

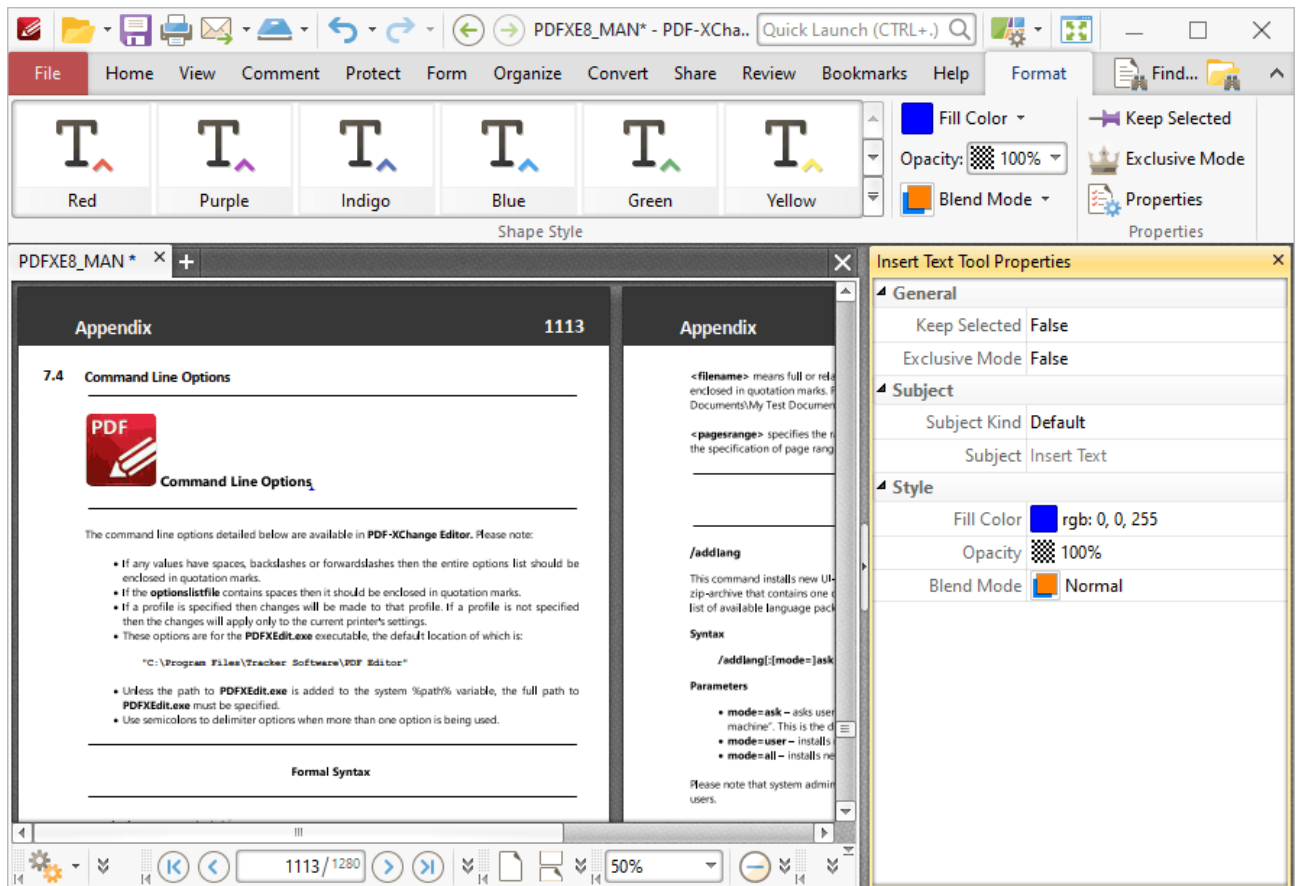

Figure 4. Format Tab, Insert Text Tool

- Click options in the **Shape Style** group to select alternative default caret annotation styles.
- Click **Keep Selected** to keep the **Insert Text Tool** enabled and add multiple caret annotations to the document. If this option is not enabled then **PDF-XChange Editor** will revert to the designated default tool immediately after creating one caret annotation.
- Click **Exclusive Mode** to enable exclusive mode, which simplifies the process of using the **Insert Text Tool**. When **Exclusive Mode** is enabled, the pointer ignores all interactive elements of documents other than base content. This makes it possible to create caret annotations on areas that overlap with other content without the risk of accidentally selecting undesired items. When **Exclusive Mode** is disabled, the pointer recognizes and interacts with all underlying elements in the usual manner.
- Click **Properties** to open the **Properties** pane and view/edit caret properties, as detailed above.

- When caret annotations are selected, the **Style Tools** dropdown menu is available in the **Format** tab. It contains the following options:
  - Click **Copy Comment Style** to copy the style properties of caret annotations.
  - Click **Apply Copied Comment Style** to apply a copied caret annotation style to selected annotations.
  - Click **Apply Copied Comment Appearance** to apply a copied caret annotation style to selected annotations.
  - Click **Make Current Properties Default** to set the properties of the caret annotation as the default properties for subsequent annotations.
  - Click **Apply Default Properties** to apply the default caret annotation properties to selected caret annotations.
- When caret annotations are selected, the **Pop-up** group is available in the **Format** tab and can be used to interact with the pop-up note of the annotation:
  - Click **Open** to open the pop-up note.
  - Click **Hide** to hide the pop-up note.
  - Click **Reset Location** to reset the location of the pop-up note.
- When caret annotations are selected, the **Arrange** tab is also available and can be used to manipulate comments as detailed [here](#).<sup>1626</sup>

Note that the [Comment Styles Palette](#)<sup>1242</sup> can be used to edit and save customized caret annotation styles for subsequent use, and the [Commenting](#)<sup>875</sup> preferences can be used to view/edit preferences for all comments.

---

10.4.4.12 Replace Text Tool



Replace Text Tool

The **Replace Text** tool is used when editing documents that contain text. The tool inserts caret annotations that contain pop-up notes. The creator of the annotation can add their suggestions to the pop-up note for text that should be inserted to replace existing text at the location of the caret annotation. A strikethrough is added to the existing text in order to indicate that it should be removed. Subsequent users of the document can double-click the annotation in order to view its pop-up note and the suggested changes that it contains.

Click **Replace Text Tool** to use this tool:

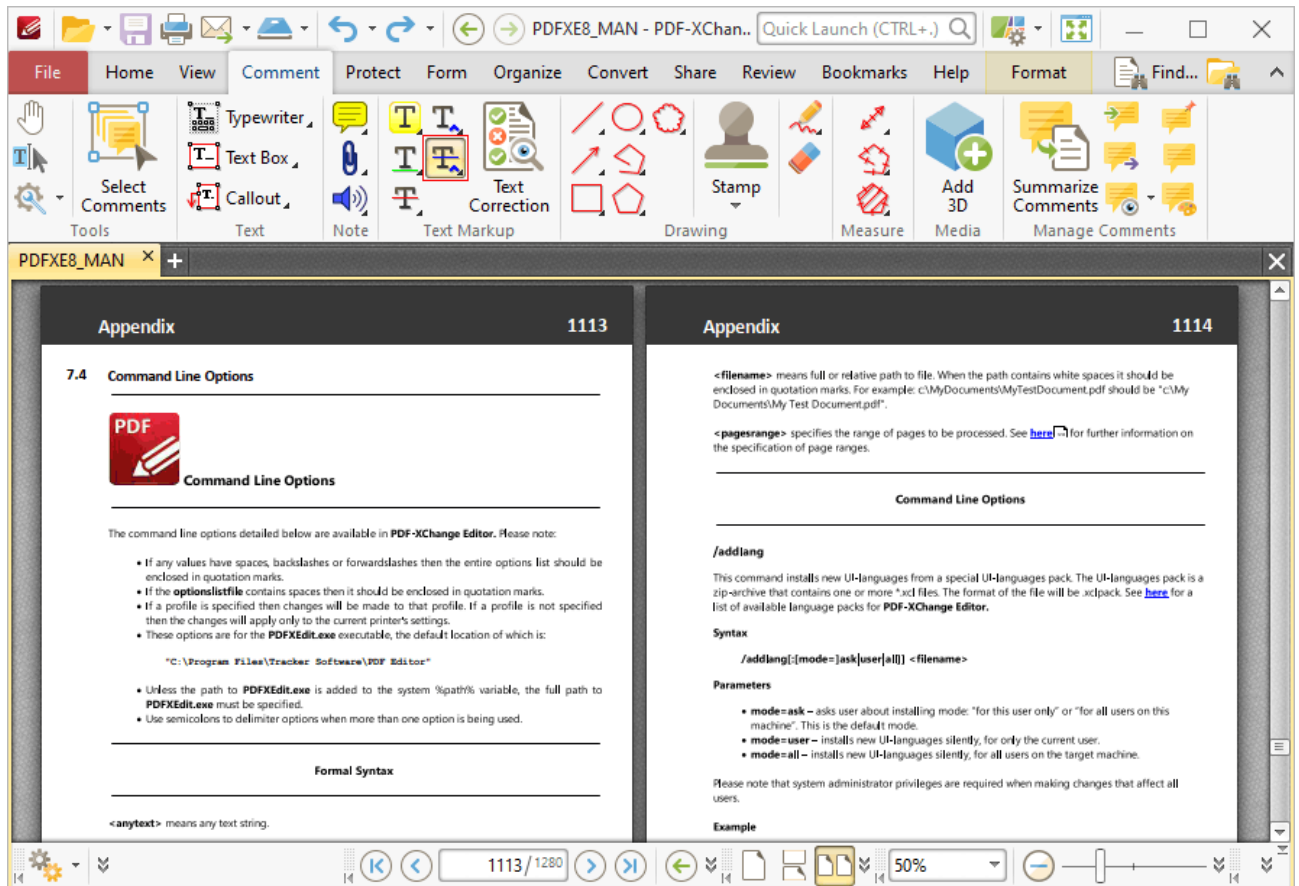

Figure 1. Comment Tab, Replace Text Tool

When the **Replace Text Tool** is enabled, click and drag over the text that you want to annotate:

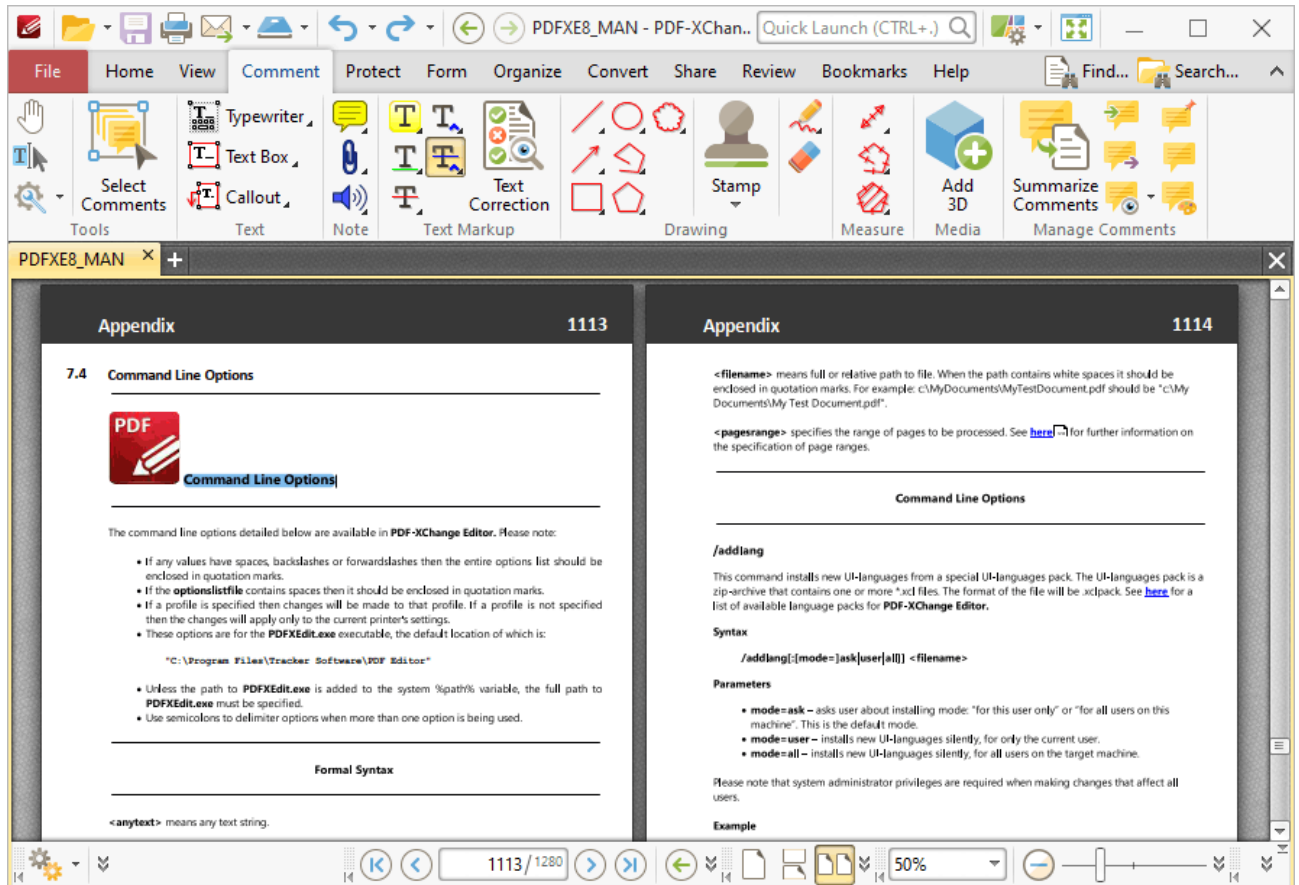

Figure 2. Replace Text Tool Active

When you release the mouse button, a strikethrough annotation will be added to the text and a caret annotation will be added on the right side of it. Double click the annotation to open its pop-up note, then enter the desired text:

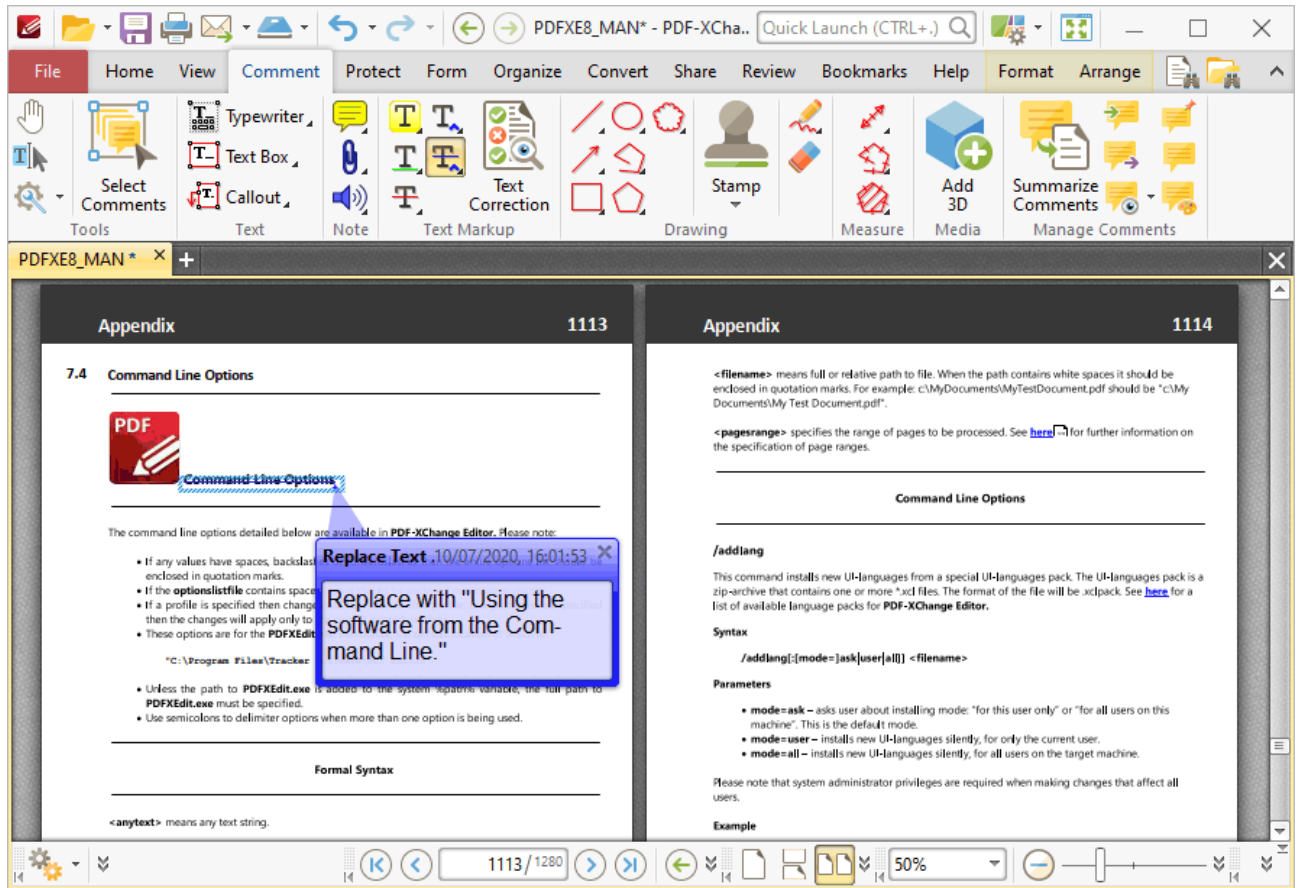

Figure 3. Replace Text Pop-up Note Expanded and Edited

Press Ctrl+' to open the **Properties** pane for selected annotations and view/edit properties:

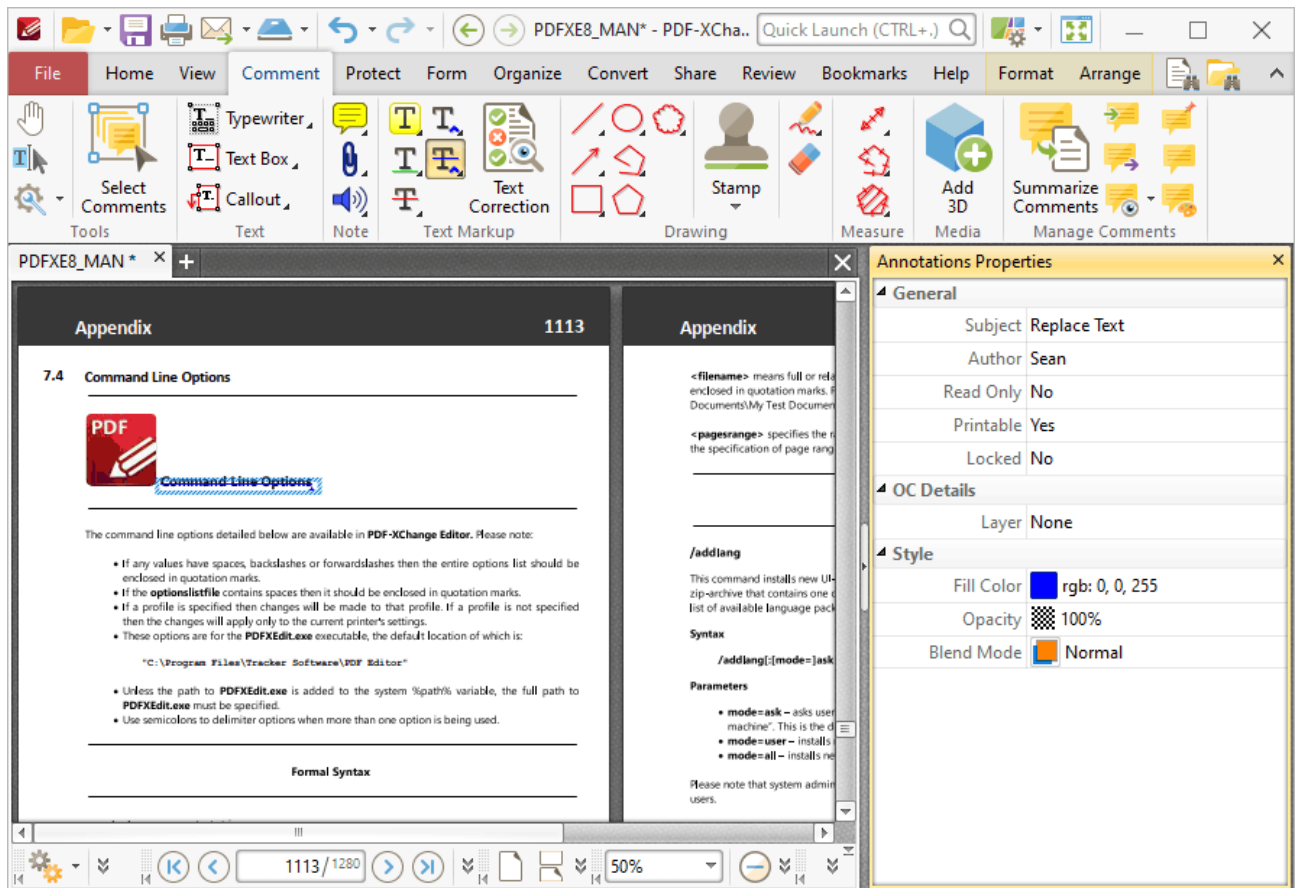

Figure 3. Replace Text Tool, Replace Text Properties Pane

- **Subject** is the name of the annotation, as referenced in the [Comments](#)<sup>1007</sup> pane.
- **Author** is the name of the user that created the annotation.
- **Name** is the unique name of the annotation, as referenced within the application.
- **Created** is the date and time at which the annotation was created.
- **Modified** is the date and time at which the annotation was last modified.
- **Read Only** is the read only status of the annotation. If this property is enabled then users cannot interact with the annotation. Please note that it is necessary to use JavaScript to change the value of this property.
- **Printable** is the print status of the annotation. If this property is enabled then the annotation is printed with the document. If this property is not enabled then the annotation is not printed.
- **Locked** is the locked status of the annotation. If this property is enabled then the annotation cannot be deleted and its properties (including its position and size) cannot be modified by users.
- **Layer** specifies the optional content layer to which the annotation belongs. Further information about layers is available [here](#).<sup>1024</sup>
- **Fill Color** determines the color of the annotation.
- **Opacity** determines the level of transparency in the annotation.
- **Blend Mode** determines how annotations blend with overlapping content. These options are explained [here](#).<sup>1650</sup>



Note that when the **Replace Text Tool** is enabled, the **Format** tab is available and can be used to customize the default properties of annotations:

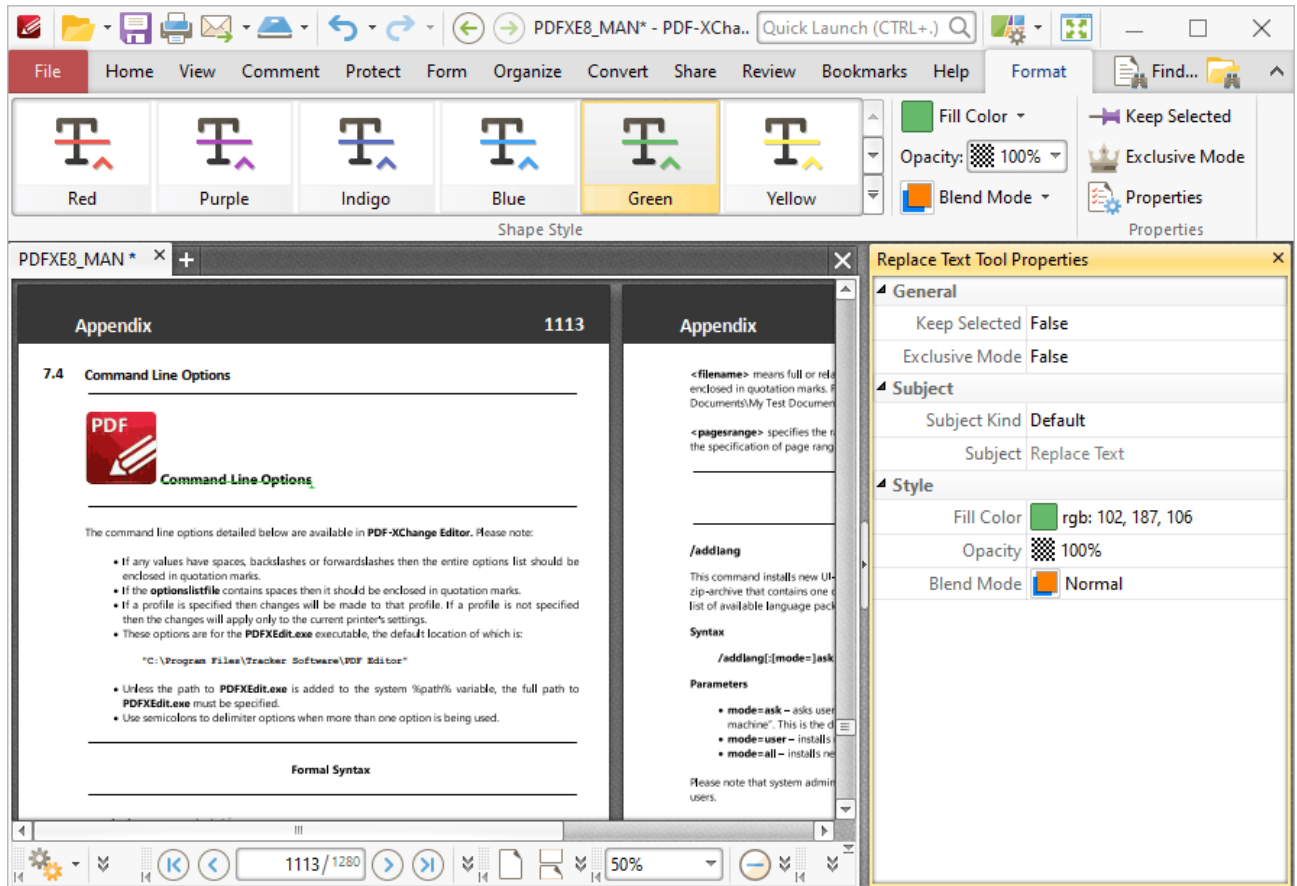

Figure 4. Format Tab, Replace Text Tool

- Click options in the **Shape Style** group to select alternative default annotation styles.
- Click **Keep Selected** to keep the **Replace Text Tool** enabled and add multiple annotations to the document. If this option is not enabled then **PDF-XChange Editor** will revert to the designated default tool immediately after creating one annotation.
- Click **Exclusive Mode** to enable exclusive mode, which simplifies the process of using the **Replace Text Tool**. When **Exclusive Mode** is enabled, the pointer ignores all interactive elements of documents other than base content. This makes it possible to create annotations on areas that overlap with other content without the risk of accidentally selecting undesired items. When **Exclusive Mode** is disabled, the pointer recognizes and interacts with all underlying elements in the usual manner.
- Click **Properties** to open the **Properties** pane and view/edit properties, as detailed above.
- When annotations are selected, the **Style Tools** dropdown menu is available in the **Format** tab. It contains the following options:
  - Click **Copy Comment Style** to copy the style properties of annotations.

- Click **Apply Copied Comment Style** to apply a copied annotation style to selected annotations.
- Click **Apply Copied Comment Appearance** to apply a copied annotation style to selected annotations.
- Click **Make Current Properties Default** to set the properties of the annotation as the default properties for subsequent annotations.
- Click **Apply Default Properties** to apply the default annotation properties to selected annotations.
- When annotations are selected, the **Pop-up** group is available in the **Format** tab and can be used to interact with the pop-up note of the annotation:
  - Click **Open** to open the pop-up note.
  - Click **Hide** to hide the pop-up note.
  - Click **Reset Location** to reset the location of the pop-up note.
- When annotations are selected, the **Arrange** tab is also available and can be used to manipulate comments as detailed [here](#).<sup>1626</sup>

Note that the [Comment Styles Palette](#)<sup>1242</sup> can be used to edit and save customized annotation styles for subsequent use, and the [Commenting](#)<sup>875</sup> preferences can be used to view/edit preferences for all comments.

---

10.4.4.13 Text Correction Tool



**Text Correction Tool**

The **Text Correction** tool is used when editing documents that contain text. It inserts annotations that indicate text should be removed from documents or replaced with different text.

Click **Text Correction Tool** to use this tool:

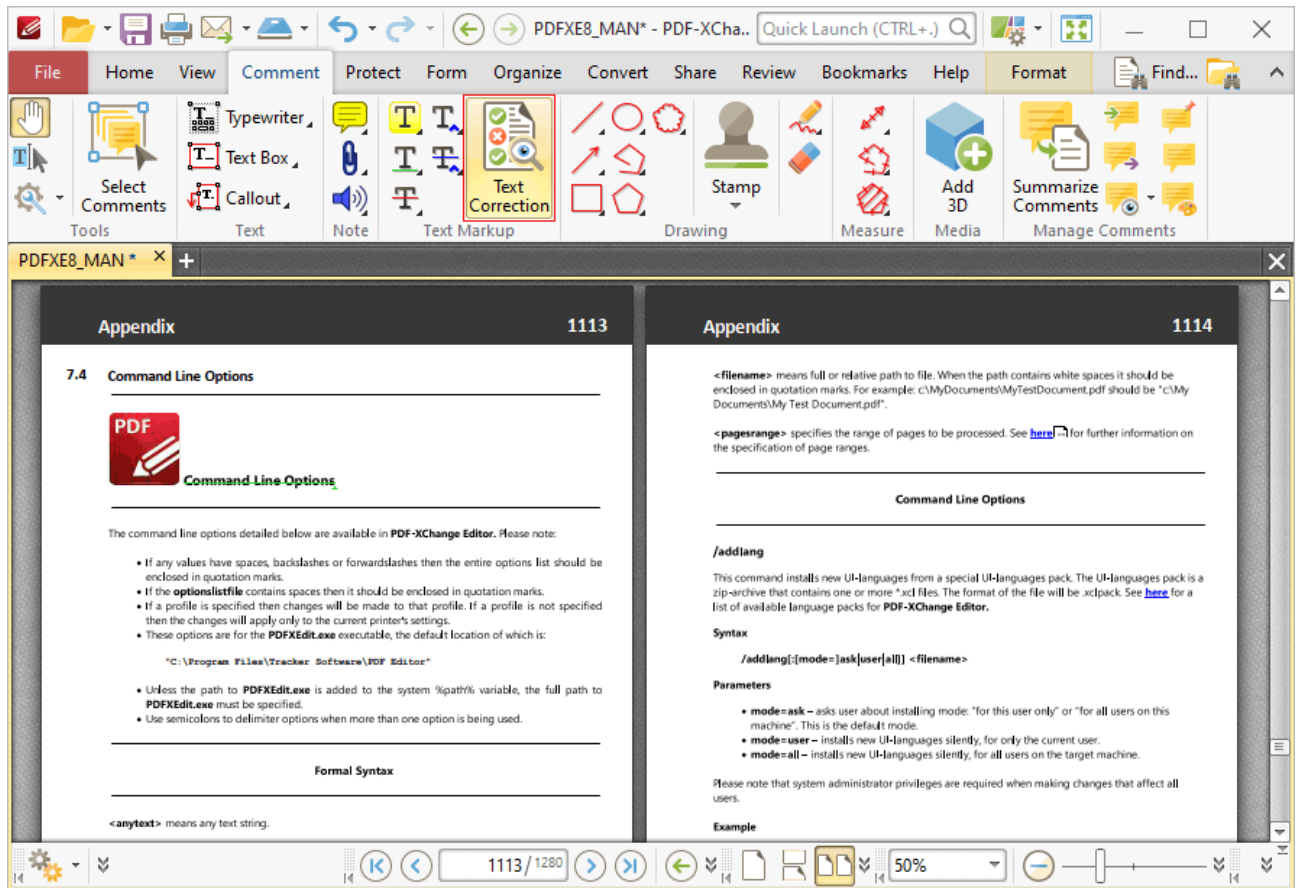

Figure 1. Comment Tab, Text Correction Tool

When the **Text Correction Tool** is enabled, click and drag over the text that you want to annotate:

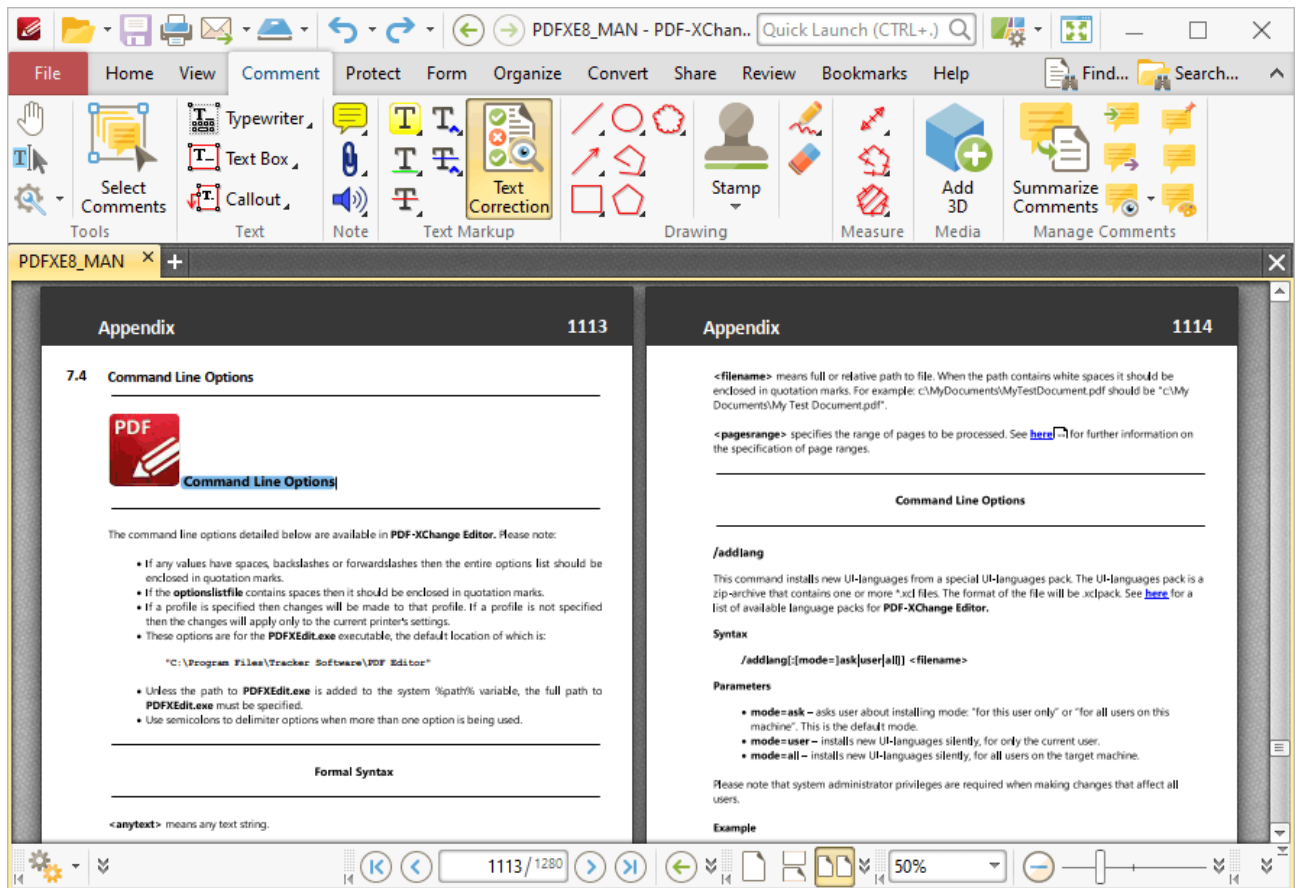

Figure 2. Text Correction Tool Active

Selected text can be edited as follows:

- Press **Delete** to add a strikeout annotation to selected text. Strikeout annotations indicate that text should be deleted and can be edited as detailed [here.](#)<sup>1130</sup>
- Press **Insert** to add a caret annotation to selected text. Caret annotations indicate that text should be replaced and can be edited as detailed [here.](#)<sup>1141</sup>
- Press **Ctrl+V** to add a caret annotation to selected text, as with the **Insert** option, and paste the content of the clipboard in the annotation's pop-up note.
- Use the keyboard to enter text. A caret annotation will be added to selected text, as with the **Insert** option, and the text entered will be added to the annotation's pop-up note.
- Press **Insert** when the **Text Correction Tool** is enabled, but no text is selected, to add caret annotations at the location of the pointer. Caret annotations indicate that text should be replaced and can be edited as detailed [here.](#)<sup>1141</sup>

## 10.4.4.14 Line Tool

**Line Tool**

Click the **Line Tool** to add line annotations to documents:

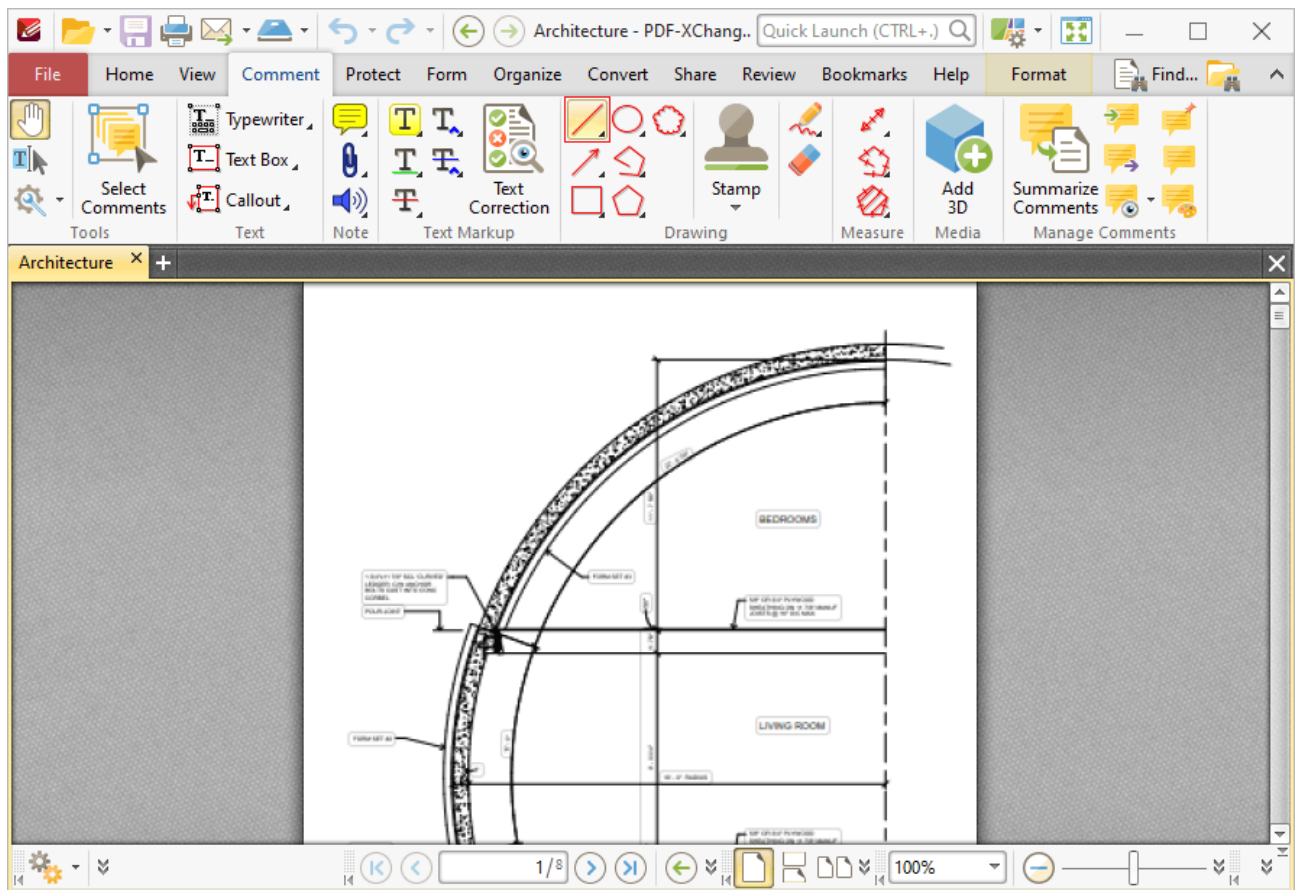

**Figure 1.** Comment Tab, Line Tool

When the **Line Tool** is enabled, the pointer becomes a crosshairs icon. Click to initiate a line annotation, then drag the pointer to the desired location and click again to complete the line annotation:

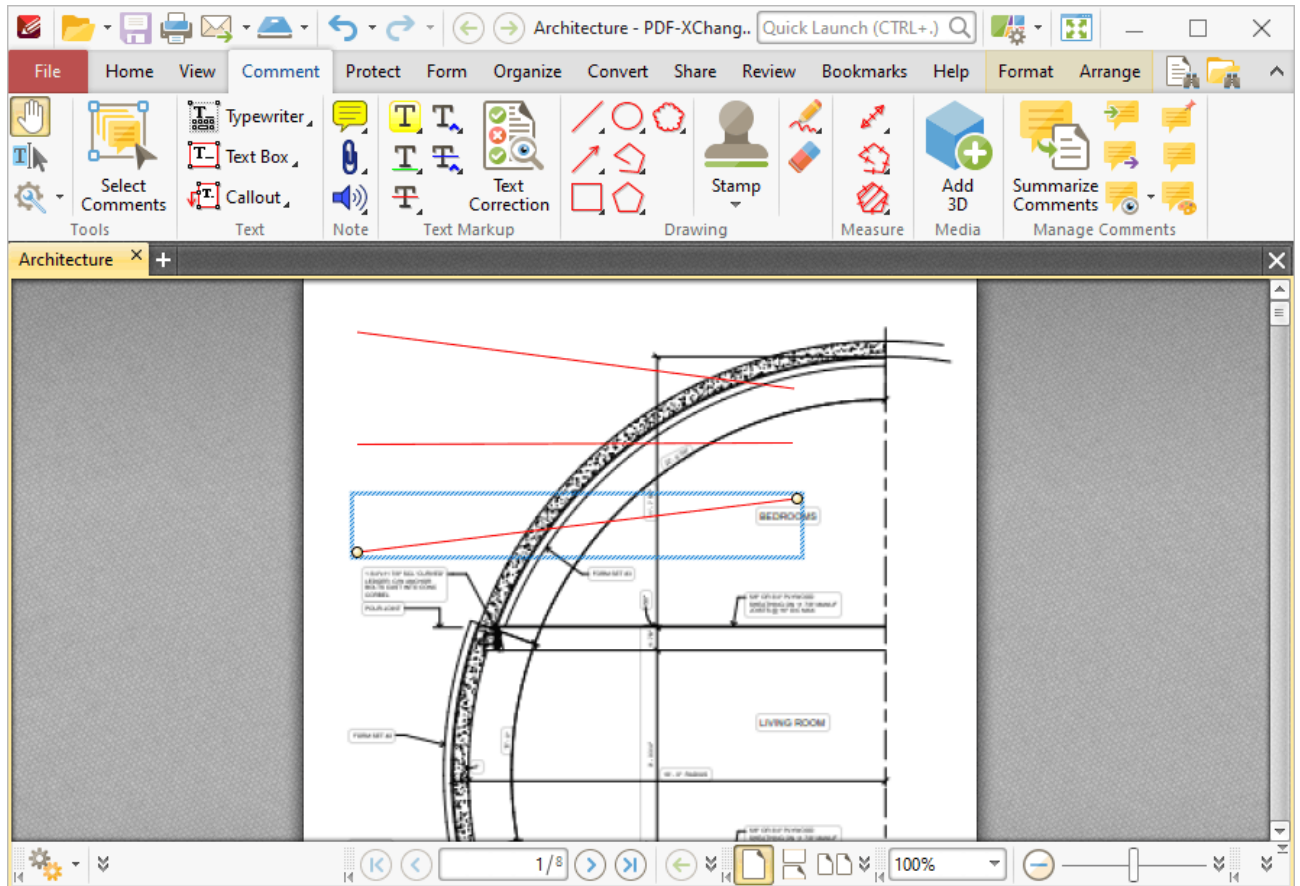

Figure 2. Line Tool Examples

Click to select line annotations, as detailed in the lower annotation in the image above. Selected annotations can be edited as follows:

- Click and drag the yellow control points to reposition line endings. Hold down Shift to reposition annotations at increments of fifteen degrees.
- Click and drag, or use the arrow keys, to reposition annotations. Hold down Shift to move at an increased increment when using the arrow keys.
- Use the editing aids detailed [here](#)<sup>1075</sup> to assist in the precise placement of line annotations.
- Right-click annotations for further options, as detailed [here](#).<sup>1783</sup>
- Press Ctrl+' to open the **Properties** pane for selected annotations and view/edit properties:

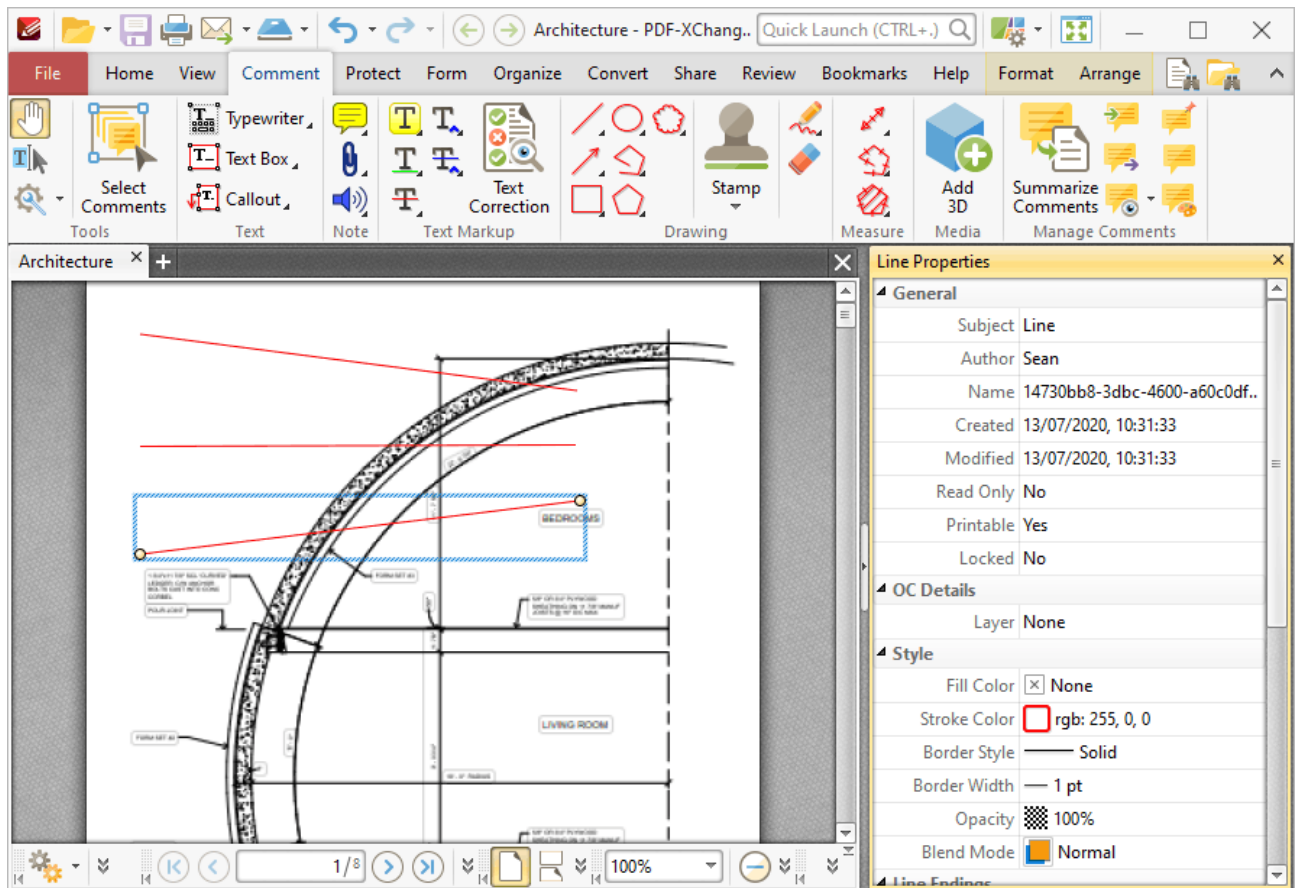



Figure 3. Line Tool, Line Properties Pane

- **Subject** is the name of the line annotation, as referenced in the [Comments](#) pane.
- **Author** is the name of the user that created the line annotation.
- **Name** is the unique name of the line annotation, as referenced within the application.
- **Created** is the date and time at which the line annotation was created.
- **Modified** is the date and time at which the line annotation was last modified.
- **Read Only** is the read only status of the line annotation. If this property is enabled then users cannot interact with the annotation. Please note that it is necessary to use JavaScript to change the value of this property.
- **Printable** is the print status of the line annotation. If this property is enabled then the annotation is printed with the document. If this property is not enabled then the annotation is not printed.
- **Locked** is the locked status of the line annotation. If this property is enabled then the annotation cannot be deleted and its properties (including its position and size) cannot be modified by users.
- **Layer** specifies the optional content layer to which the line annotation belongs. Further information about layers is available [here](#).
- **Fill Color** determines the color of the line ending style used at the start of the line annotation. The line ending property is detailed below.
- **Stroke Color** determines the color of the line annotation.

- **Opacity** determines the level of transparency in the line annotation.
- **Blend Mode** determines how line annotations blend with overlapping content. These options are explained [here](#).
- **Start** determines the line ending style used at the start of the line annotation.
- **End** determines the line ending style used at the end of the line annotation.
- **Start Scale** determines the size of the line ending used at the start of the line annotation.
- **End Scale** determines the size of the line ending used at the end of the line annotation.
- **Leader Length** determines the length of the leader lines used for the line annotation. Leader lines extend from each endpoint of the line annotation, perpendicular to the annotation itself.
- **Leader Extension** determines the length of leader line extensions that extend from the line annotation.
- **Leader Offset** determines the length of the leader line offset, which is the amount of empty space between the endpoints of the line annotation and the beginning of the leader lines.
- **Show Caption** determines whether or not the text contained in the pop-up note of the annotation is displayed.
- **Inline Caption** determines whether or not the caption is an inline caption. If this option is enabled then captions are placed inside the line annotation instead of on top of the line annotation.
- **Length** determines the length of the line annotation.

Note that when the **Line Tool** is enabled, the **Format** tab is available and can be used to customize the default properties of line annotations:



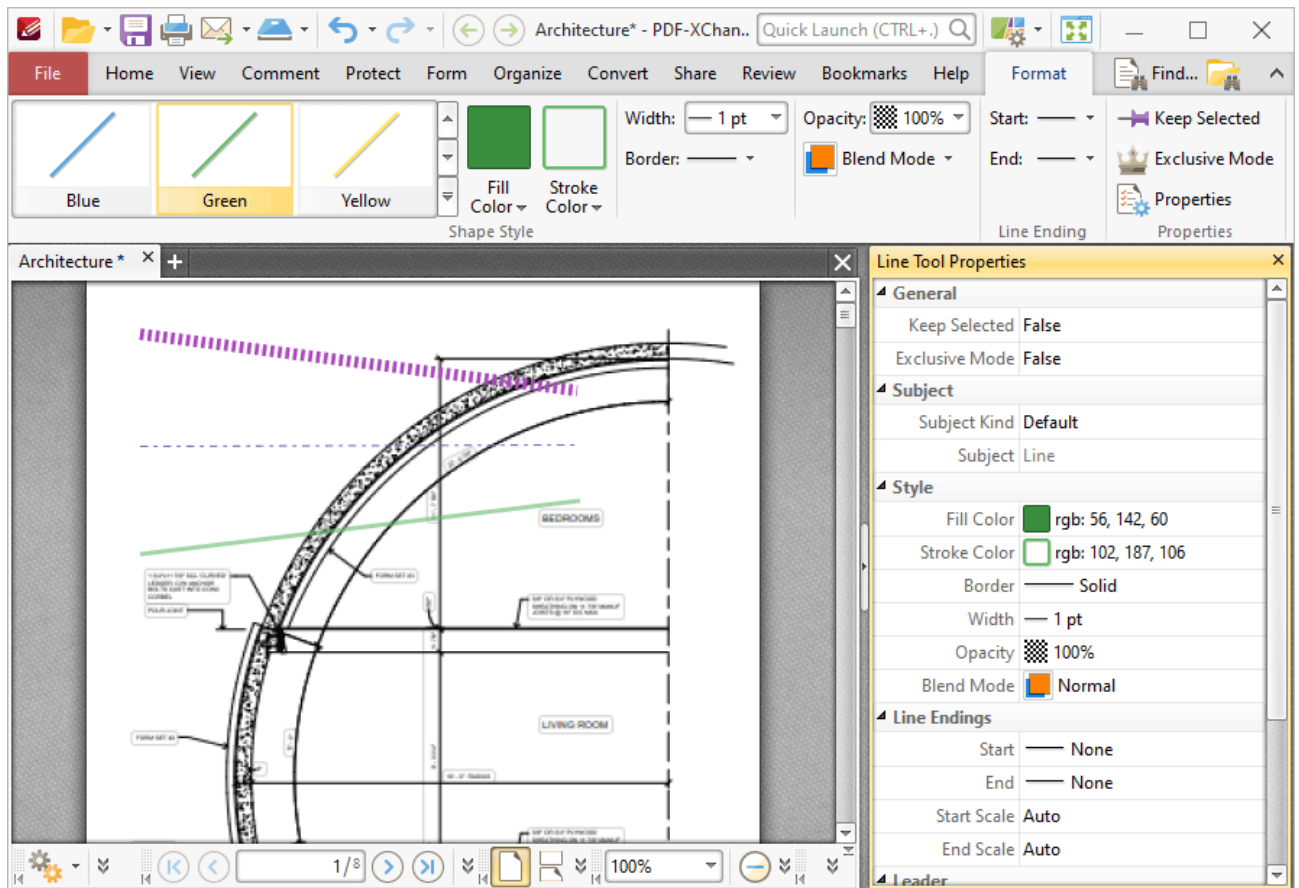

Figure 4. Format Tab, Line Tool

- Click options in the **Shape Style** group to select alternative default line annotation styles.
- Click **Keep Selected** to keep the **Line Tool** enabled and add multiple line annotations to the document. If this option is not enabled then **PDF-XChange Editor** will revert to the designated default tool immediately after creating one line annotation.
- Click **Exclusive Mode** to enable exclusive mode, which simplifies the process of using the **Line Tool**. When **Exclusive Mode** is enabled, the pointer ignores all interactive elements of documents other than base content. This makes it possible to create line annotations on areas that overlap with other content without the risk of accidentally selecting undesired items. When **Exclusive Mode** is disabled, the pointer recognizes and interacts with all underlying elements in the usual manner.
- Click **Properties** to open the **Properties** pane and view/edit **Line Tool** properties, as detailed above.
- When line annotations are selected, the **Style Tools** dropdown menu is available in the **Format** tab. It contains the following options:
  - Click **Copy Comment Style** to copy the style properties of line annotations.
  - Click **Apply Copied Comment Style** to apply a copied line annotation style to selected annotations.
  - Click **Apply Copied Comment Appearance** to apply a copied line annotation style to selected annotations.

- Click **Make Current Properties Default** to set the properties of the line annotation as the default properties for subsequent annotations.
- Click **Apply Default Properties** to apply the default line annotation properties to selected line annotations.
- When line annotations are selected, the **Pop-up** group is available in the **Format** tab and can be used to interact with the pop-up note of the annotation:
  - Click **Open** to open the pop-up note.
  - Click **Hide** to hide the pop-up note.
  - Click **Reset Location** to reset the location of the pop-up note.
- When line annotations are selected, the **Arrange** tab is also available and can be used to manipulate comments as detailed [here](#).<sup>1626</sup>

Note that the [Comment Styles Palette](#)<sup>1242</sup> can be used to edit and save customized line annotation styles for subsequent use, and the [Commenting](#)<sup>876</sup> preferences can be used to view/edit preferences for all comments.

## Convert Line Annotations to Distance Annotations

If you want to convert line annotations to distance annotations, then right-click the line annotation and click **Convert to Distance**:

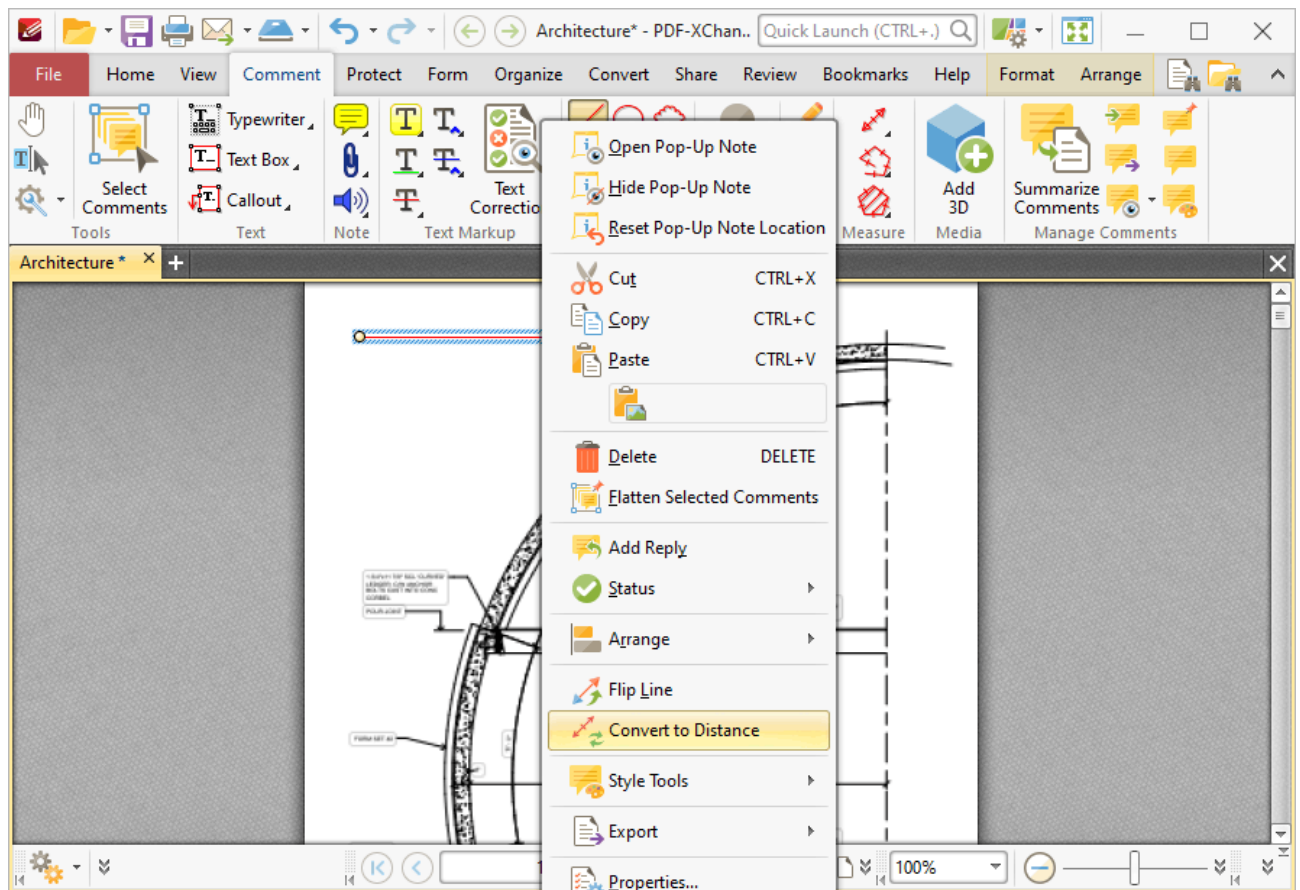

**Figure 5.** Right-Click Shortcut Menu, Convert to Distance Highlighted

The line annotation will then convert into a distance annotation. Note that it is possible to convert multiple annotations at the same time.

---

10.4.4.15 Arrow Tool



**Arrow Tool**

Click the **Arrow Tool** to add arrow annotations to documents:

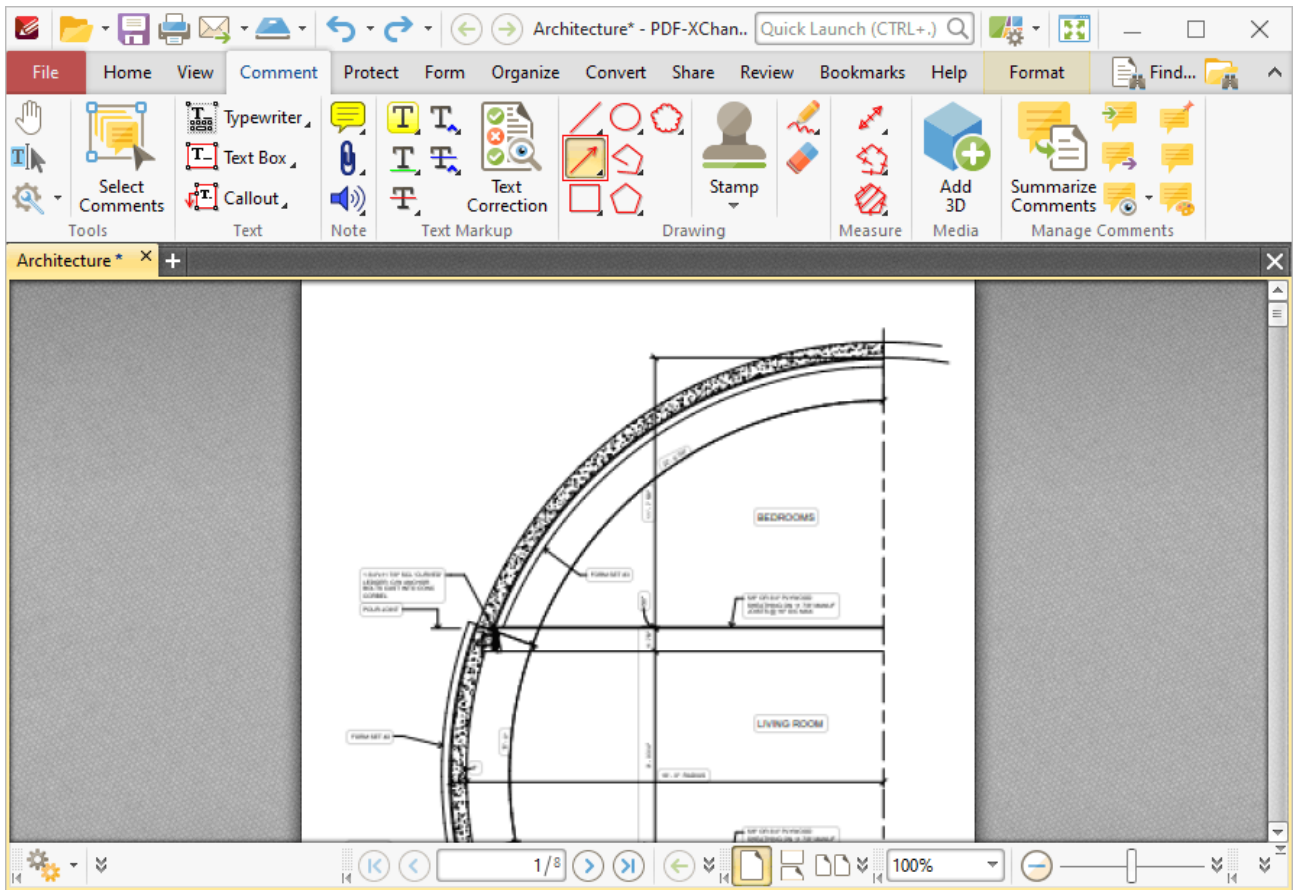

**Figure 1.** Comment Tab, Arrow Tool

When the **Arrow Tool** is enabled, the pointer becomes a crosshairs icon. Click to initiate an arrow annotation, then drag the pointer to the desired location and click again to complete the annotation:

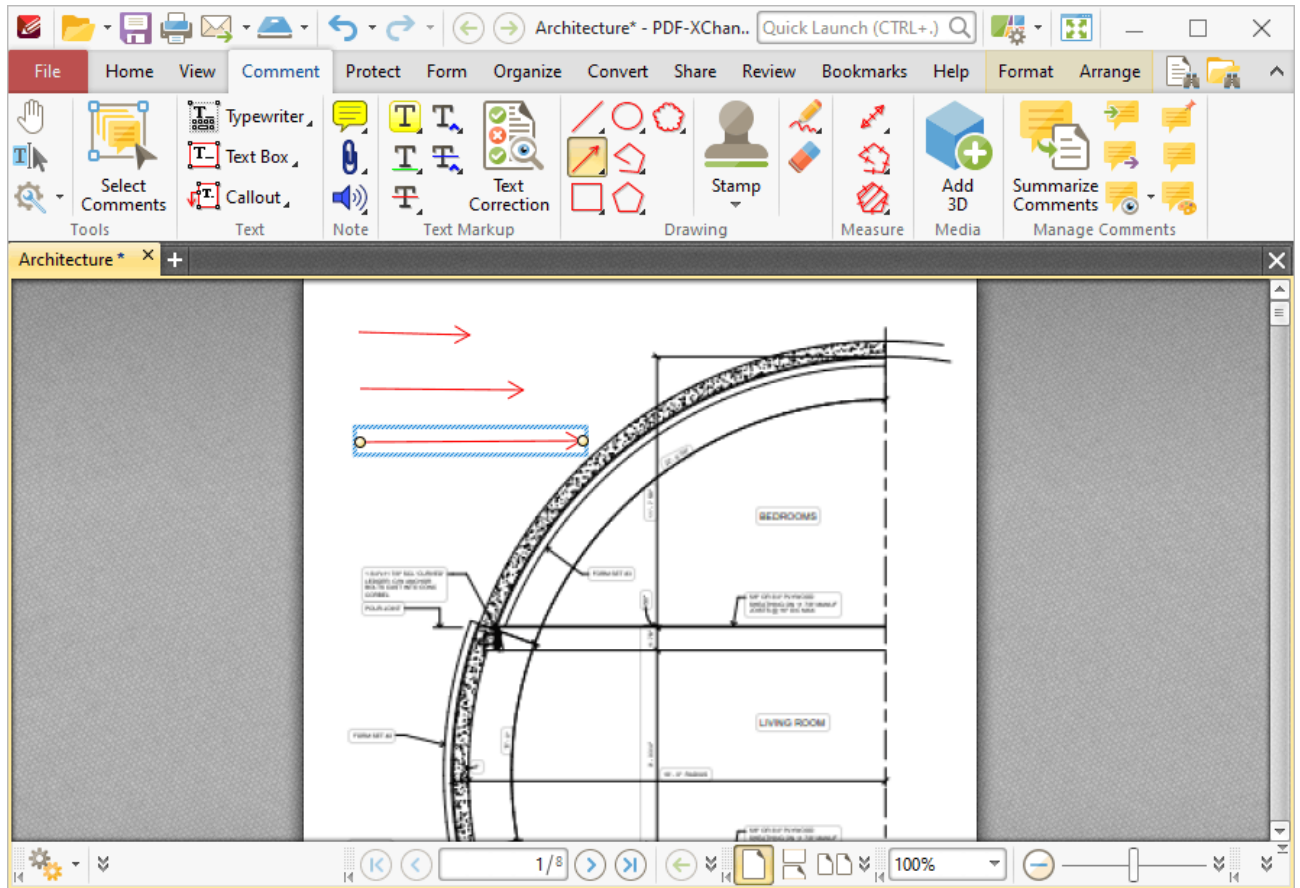

Figure 2. Arrow Examples

Click to select arrow annotations, as detailed in the lower annotation in the image above. Selected annotations can be edited as follows:

- Click and drag the yellow control points to reposition arrow endings. Hold down Shift to reposition annotations at increments of fifteen degrees.
- Click and drag, or use the arrow keys, to reposition annotations. Hold down Shift to move at an increased increment when using the arrow keys.
- Use the editing aids detailed [here](#)<sup>1075</sup> to assist in the precise placement of arrow annotations.
- Right-click annotations for further options, as detailed [here](#).<sup>1783</sup>
- Press Ctrl+' to open the **Properties** pane for selected annotations and view/edit properties:

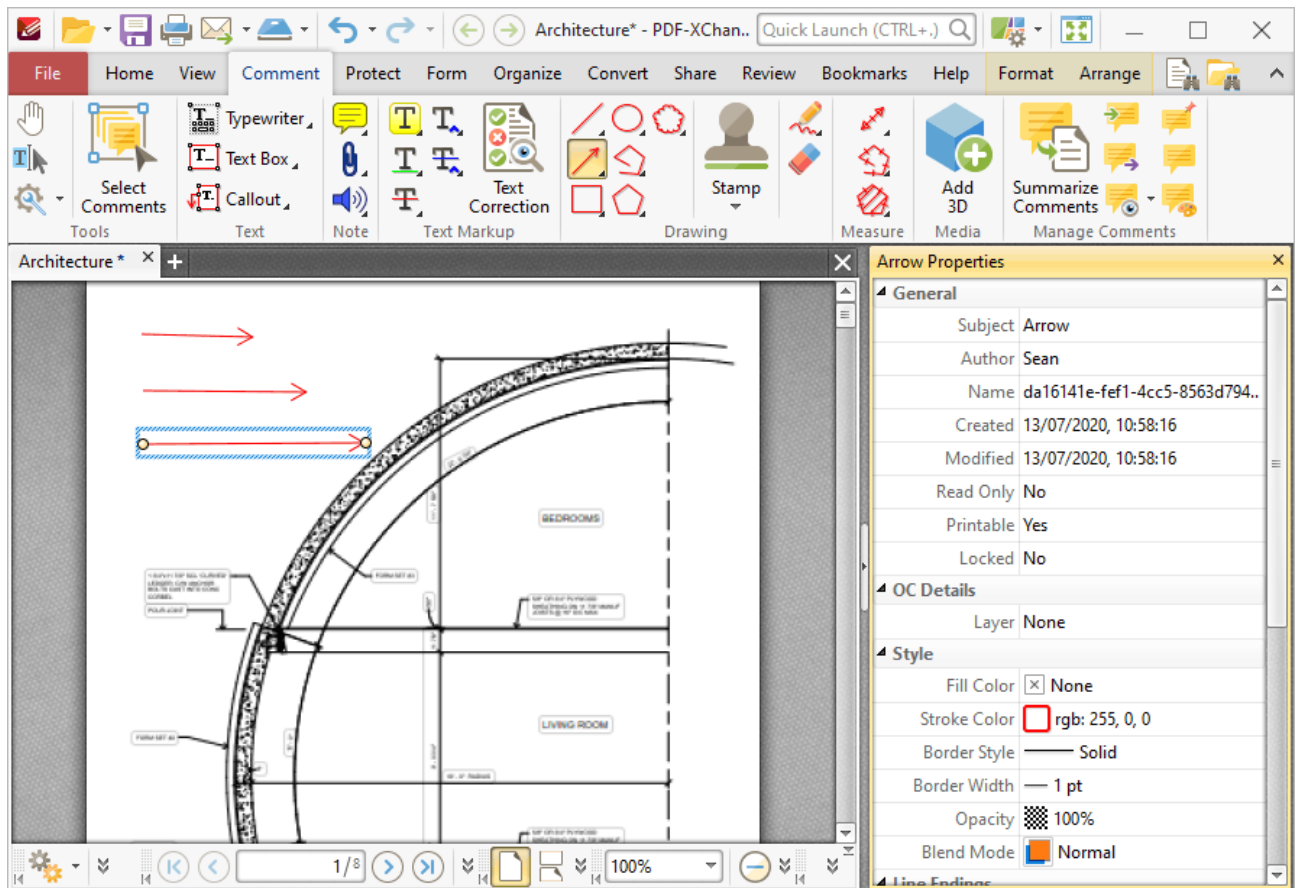

Figure 3. Arrow Tool, Arrow Properties Pane

- **Subject** is the name of the arrow annotation, as referenced in the [Comments](#)<sup>1007</sup> pane.
- **Author** is the name of the user that created the arrow annotation.
- **Name** is the unique name of the arrow annotation, as referenced within the application.
- **Created** is the date and time at which the arrow annotation was created.
- **Modified** is the date and time at which the arrow annotation was last modified.
- **Read Only** is the read only status of the arrow annotation. If this property is enabled then users cannot interact with the annotation. Please note that it is necessary to use JavaScript to change the value of this property.
- **Printable** is the print status of the arrow annotation. If this property is enabled then the annotation is printed with the document. If this property is not enabled then the annotation is not printed.
- **Locked** is the locked status of the arrow annotation. If this property is enabled then the annotation cannot be deleted and its properties (including its position and size) cannot be modified by users.
- **Layer** specifies the optional content layer to which the arrow annotation belongs. Further information about layers is available [here](#).<sup>1024</sup>
- **Fill Color** determines the color of the line ending style used at the start of the arrow annotation. The line ending property is detailed below.
- **Stroke Color** determines the color of the arrow annotation.

- **Border Style** determines the style of the annotation.
- **Border Width** determines the width of the annotation.
- **Opacity** determines the level of transparency in the arrow annotation.
- **Blend Mode** determines how arrow annotations blend with overlapping content. These options are explained [here](#).
- **Start** determines the line ending style used at the start of the arrow annotation.
- **End** determines the line ending style used at the end of the arrow annotation.
- **Start Scale** determines the size of the line ending used at the start of the arrow annotation.
- **End Scale** determines the size of the line ending used at the end of the arrow annotation.
- **Leader Length** determines the length of the leader lines used for the arrow annotation. Leader lines extend from each endpoint of the arrow annotation, perpendicular to the arrow annotation itself.
- **Leader Extension** determines the length of leader line extensions that extend from the arrow annotation.
- **Leader Offset** determines the length of the leader line offset, which is the amount of empty space between the endpoints of the arrow annotation and the beginning of the leader lines.
- **Show Caption** determines whether or not the text contained in the pop-up note of the annotation is displayed.
- **Inline Caption** determines whether or not the caption is an inline caption. If this option is enabled then captions are placed inside the arrow annotation instead of on top of the arrow annotation.
- **Length** determines the length of the arrow annotation.

Note that when the **Arrow Tool** is enabled, the **Format** tab is available and can be used to customize the default properties of arrow annotations:

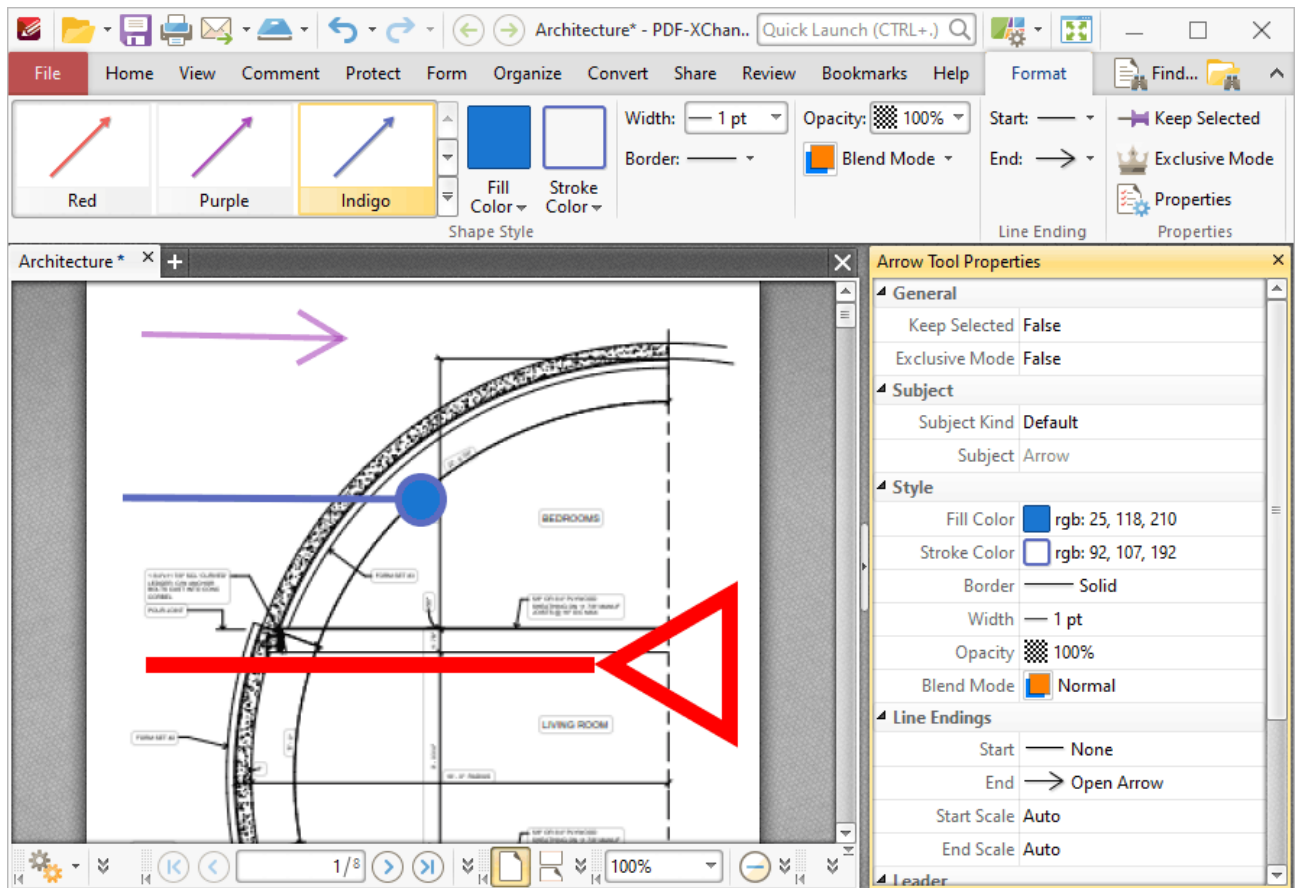

Figure 3. Format Tab, Arrow Tool

- Click options in the **Shape Style** group to select alternative default arrow annotation styles.
- Click **Keep Selected** to keep the **Arrow Tool** enabled and add multiple arrow annotations to the document. If this option is not enabled then **PDF-XChange Editor** will revert to the designated default tool immediately after creating one arrow annotation.
- Click **Exclusive Mode** to enable exclusive mode, which simplifies the process of using the **Arrow Tool**. When **Exclusive Mode** is enabled, the pointer ignores all interactive elements of documents other than base content. This makes it possible to create arrow annotations on areas that overlap with other content without the risk of accidentally selecting undesired items. When **Exclusive Mode** is disabled, the pointer recognizes and interacts with all underlying elements in the usual manner.
- Click **Properties** to open the **Properties** pane and view/edit **Arrow Tool** properties, as detailed above.
- When arrow annotations are selected, the **Style Tools** dropdown menu is available in the **Format** tab. It contains the following options:
  - Click **Copy Comment Style** to copy the style properties of arrow annotations.
  - Click **Apply Copied Comment Style** to apply a copied arrow annotation style to selected annotations.
  - Click **Apply Copied Comment Appearance** to apply a copied arrow annotation style to selected annotations.



- Click **Make Current Properties Default** to set the properties of the arrow annotation as the default properties for subsequent annotations.
- Click **Apply Default Properties** to apply the default arrow annotation properties to selected arrow annotations.
- When arrow annotations are selected, the **Pop-up** group is available in the **Format** tab and can be used to interact with the pop-up note of the annotation:
  - Click **Open** to open the pop-up note.
  - Click **Hide** to hide the pop-up note.
  - Click **Reset Location** to reset the location of the pop-up note.
- When arrow annotations are selected, the **Arrange** tab is also available and can be used to manipulate comments as detailed [here](#).<sup>1626</sup>

Note that the [Comment Styles Palette](#)<sup>1242</sup> can be used to edit and save customized arrow annotation styles for subsequent use, and the [Commenting](#)<sup>875</sup> preferences can be used to view/edit preferences for all comments.

---

10.4.4.16 Rectangle Tool



**Rectangle Tool**

Click the **Rectangle Tool** to add rectangle annotations to documents:

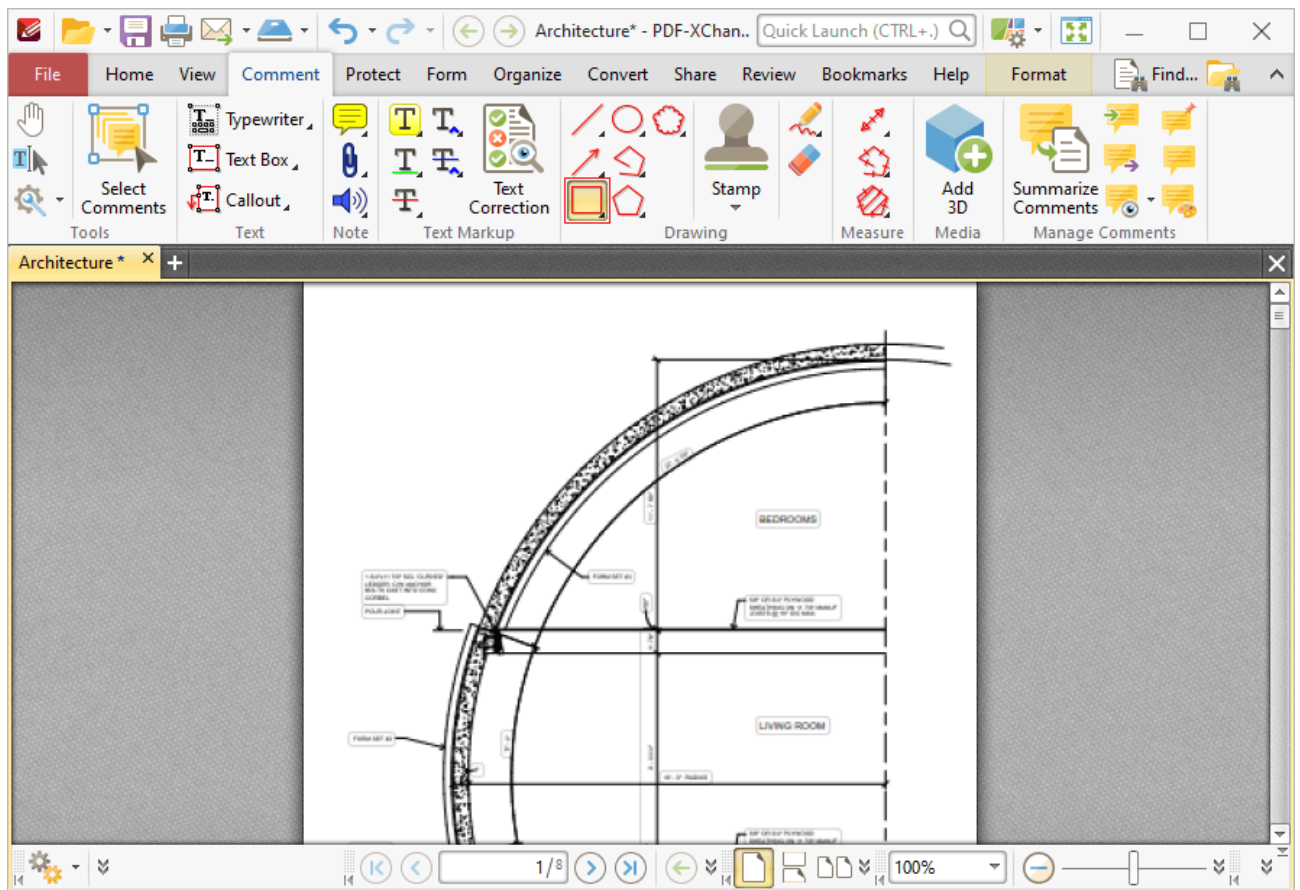

**Figure 1.** Comment Tab, Rectangle Tool

When the **Rectangle Tool** is enabled, click and drag the pointer to define rectangle annotations:

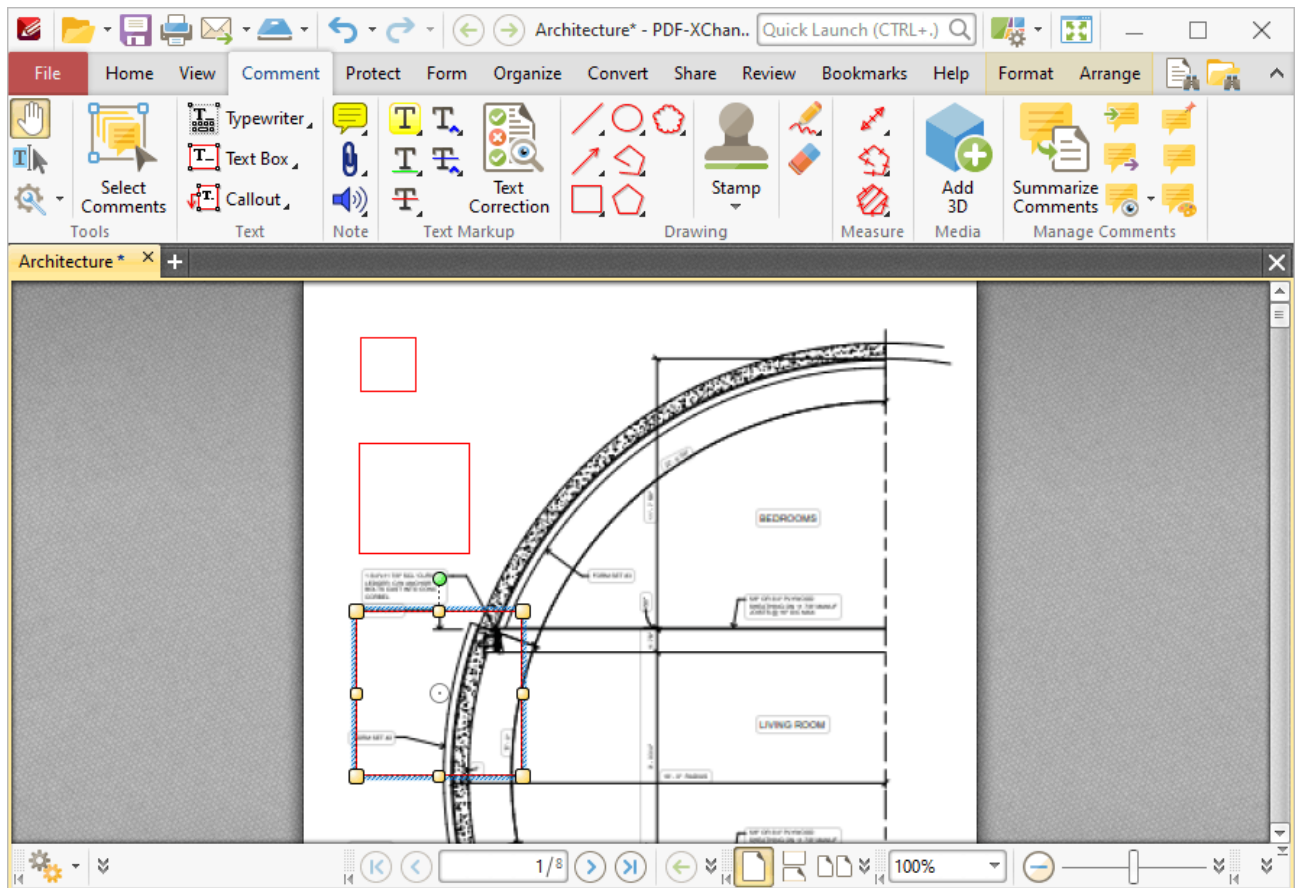

Figure 2. Rectangle Tool Examples

Click to select rectangle annotations, as detailed in the lower annotation in the image above. Selected annotations can be edited as follows:

- Click and drag the control points to resize rectangles.
- Click and drag to reposition rectangles. The circle at the center can also be used for this purpose.
- Click and drag the green control point at the top to rotate rectangles. Hold down Shift to rotate at increments of fifteen degrees.
- Use the arrow keys to reposition rectangles. Hold down Shift to move at an increased increment.
- Use the editing aids detailed [here](#)<sup>1075</sup> to assist in the precise placement of rectangles.
- Right-click rectangles for further options. See [here](#)<sup>1783</sup> for an explanation of these options.
- Hold down Ctrl to create rectangles from their center.
- Hold down Alt to constrain rectangle proportions.
- Press Ctrl+' to open the **Properties** pane for selected annotations and view/edit properties:

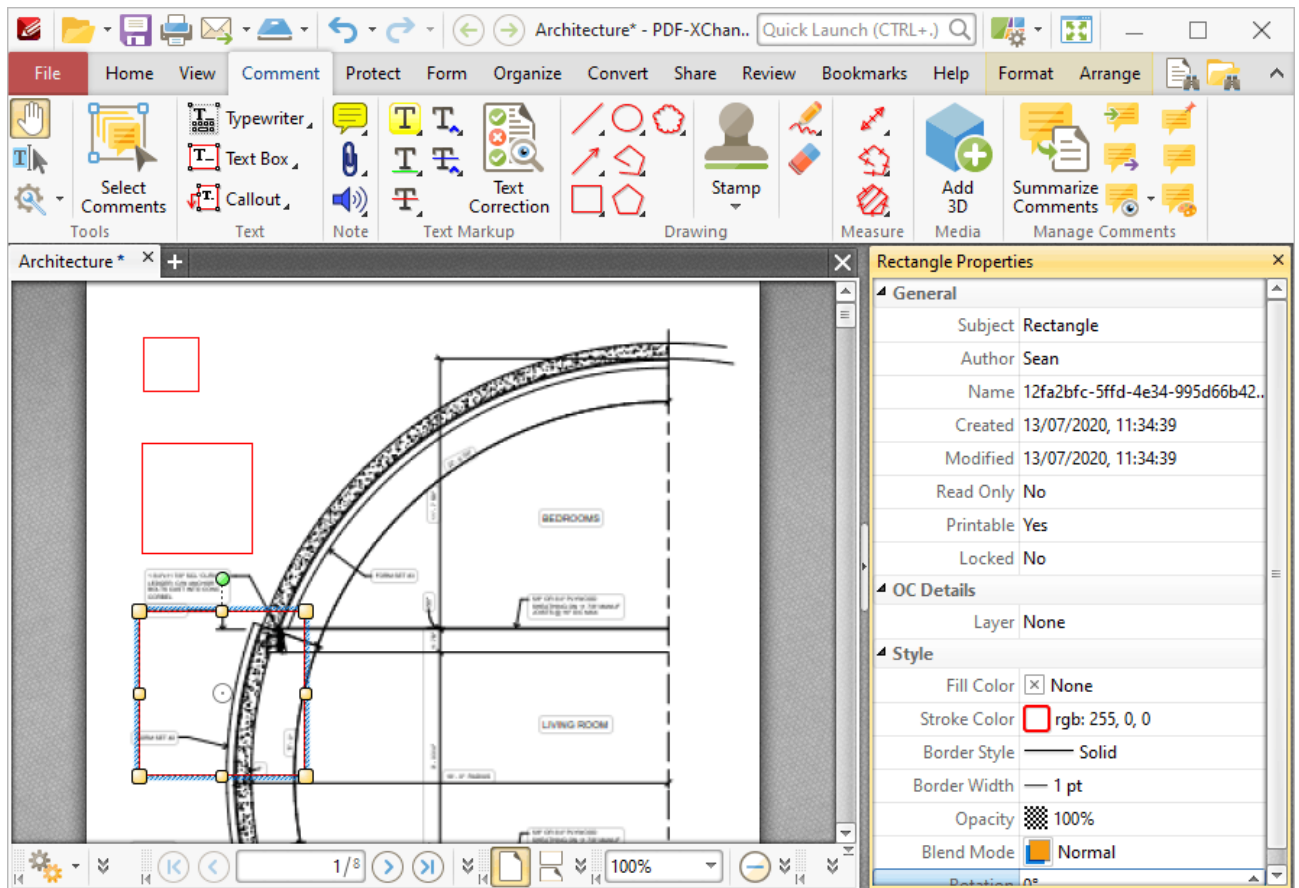

Figure 3. Rectangle Tool, Rectangle Properties Pane

- **Subject** is the name of the rectangle annotation, as referenced in the [Comments](#) <sup>1007</sup> pane.
- **Author** is the name of the user that created the rectangle annotation.
- **Name** is the unique name of the rectangle annotation, as referenced within the application.
- **Created** is the date and time at which the rectangle annotation was created.
- **Modified** is the date and time at which the rectangle annotation was last modified.
- **Read Only** is the read only status of the rectangle annotation. If this property is enabled then users cannot interact with the annotation. Please note that it is necessary to use JavaScript to change the value of this property.
- **Printable** is the print status of the rectangle annotation. If this property is enabled then the annotation is printed with the document. If this property is not enabled then the annotation is not printed.
- **Locked** is the locked status of the rectangle annotation. If this property is enabled then the annotation cannot be deleted and its properties (including its position and size) cannot be modified by users.
- **Layer** specifies the optional content layer to which the rectangle annotation belongs. Further information about layers is available [here](#). <sup>1024</sup>
- **Fill Color** determines the color of the line ending style used at the start of the rectangle annotation. The line ending property is detailed below.
- **Stroke Color** determines the color of the rectangle annotation.

- **Border Style** determines the style of the annotation.
- **Border Width** determines the width of the annotation.
- **Opacity** determines the level of transparency in the rectangle annotation.
- **Blend Mode** determines how rectangle annotations blend with overlapping content. These options are explained [here](#).
- **Rotation** determines the degrees of rotation of the rectangle annotation.

Note that when the **Rectangle Tool** is enabled, the **Format** tab is available and can be used to customize the default properties of rectangle annotations:

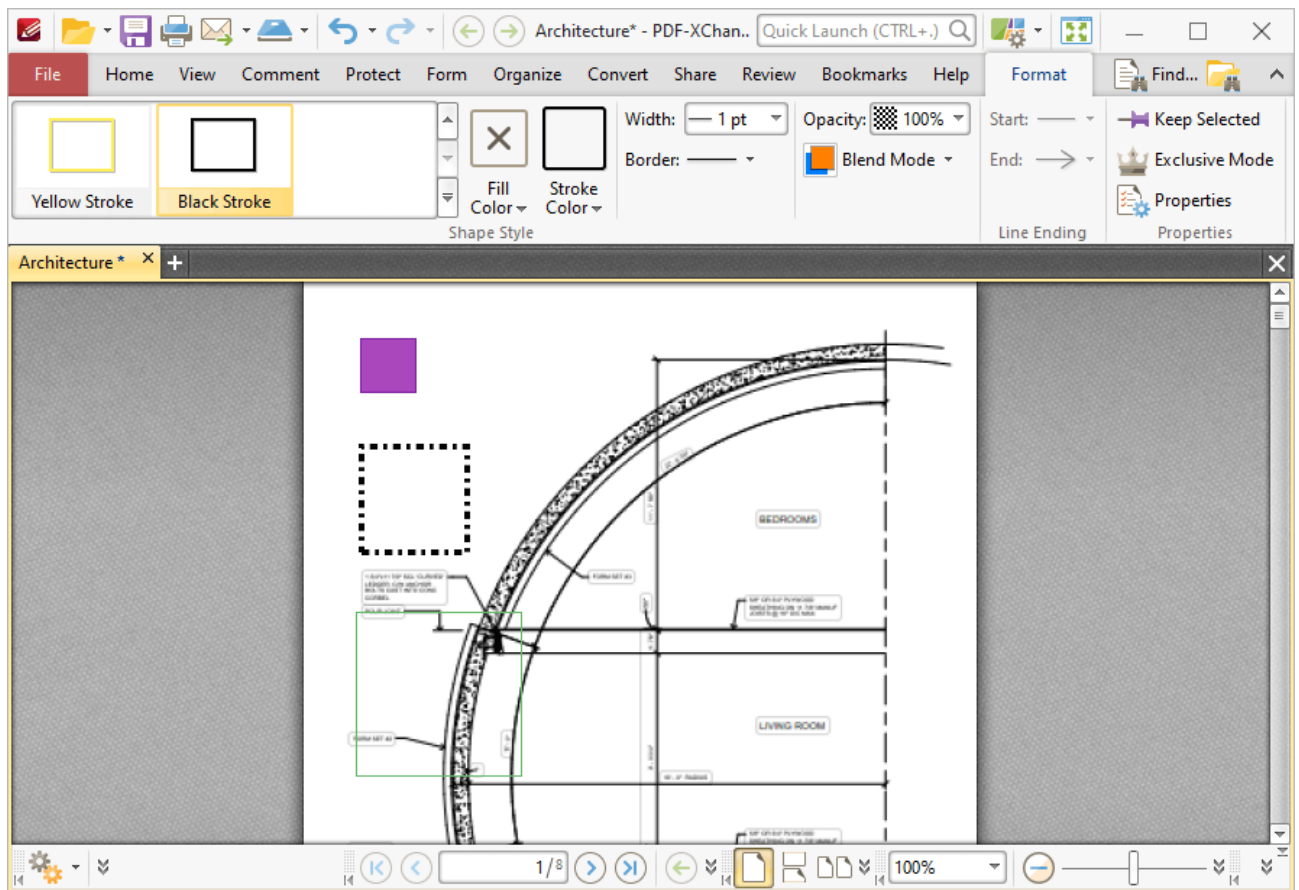

Figure 4. Format Tab, Rectangle Tool

- Click options in the **Shape Style** group to select alternative default rectangle annotation styles.
- Click **Keep Selected** to keep the **Rectangle Tool** enabled and add multiple rectangle annotations to the document. If this option is not enabled then **PDF-XChange Editor** will revert to the designated default tool immediately after creating one rectangle annotation.
- Click **Exclusive Mode** to enable exclusive mode, which simplifies the process of using the **Rectangle Tool**. When **Exclusive Mode** is enabled, the pointer ignores all interactive elements of documents other than base content. This makes it possible to create rectangle annotations on areas that overlap with other content without the risk of accidentally selecting undesired

items. When **Exclusive Mode** is disabled, the pointer recognizes and interacts with all underlying elements in the usual manner.

- Click **Properties** to open the **Properties** pane and view/edit **Rectangle Tool** properties, as detailed above.
- When rectangle annotations are selected, the **Style Tools** dropdown menu is available in the **Format** tab. It contains the following options:
  - Click **Copy Comment Style** to copy the style properties of rectangle annotations.
  - Click **Apply Copied Comment Style** to apply a copied rectangle annotation style to selected annotations.
  - Click **Apply Copied Comment Appearance** to apply a copied rectangle annotation style to selected annotations.
  - Click **Make Current Properties Default** to set the properties of the rectangle annotation as the default properties for subsequent annotations.
  - Click **Apply Default Properties** to apply the default rectangle annotation properties to selected rectangle annotations.
- When rectangle annotations are selected, the **Pop-up** group is available in the **Format** tab and can be used to interact with the pop-up note of the annotation:
  - Click **Open** to open the pop-up note.
  - Click **Hide** to hide the pop-up note.
  - Click **Reset Location** to reset the location of the pop-up note.
- When rectangle annotations are selected, the **Arrange** tab is also available and can be used to manipulate comments as detailed [here](#).

Note that the [Comment Styles Palette](#) can be used to edit and save customized rectangle annotation styles for subsequent use, and the [Commenting](#) preferences can be used to view/edit preferences for all comments.

---

10.4.4.17 Oval Tool



Oval Tool

Click the **Oval Tool** to add oval annotations to documents:

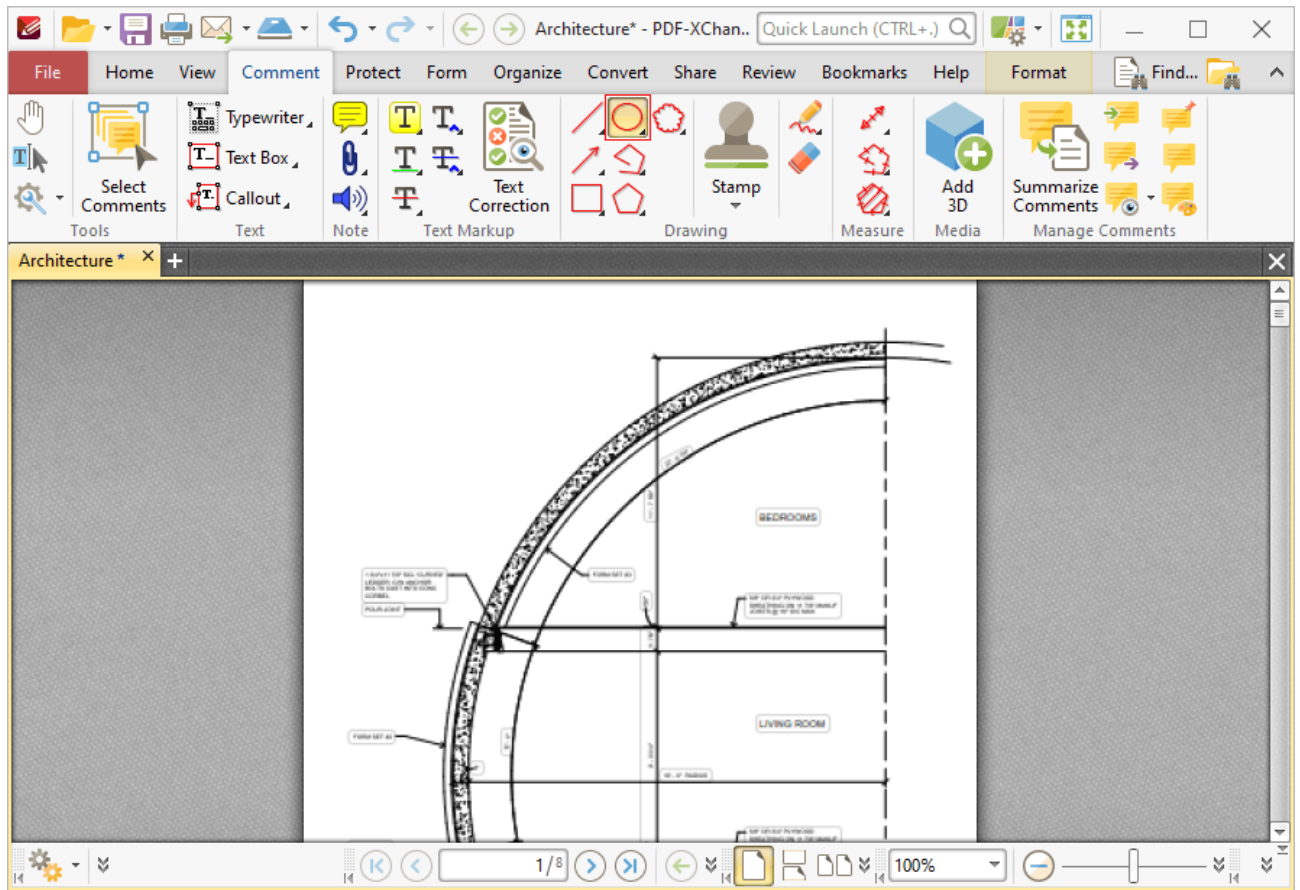

Figure 1. Comment Tab, Oval Tool

When the **Oval Tool** is enabled, click and drag the pointer to define oval annotations:

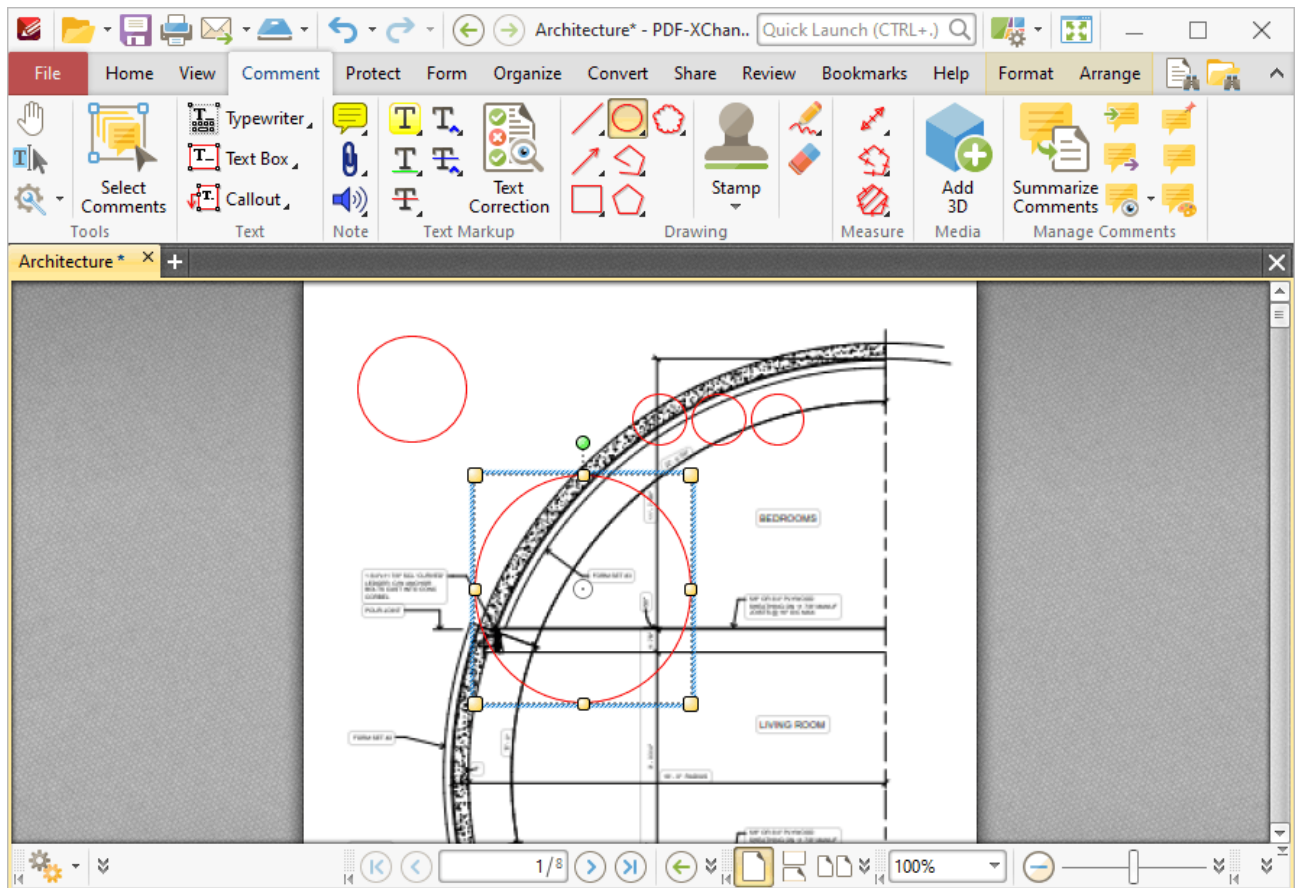

Figure 2. Oval Tool Examples

Click to select oval annotations, as detailed in the lower annotation in the image above. Selected annotations can be edited as follows:

- Click and drag the control points to resize ovals.
- Click and drag ovals to reposition them. The circle at the center can also be used for this purpose.
- Click and drag the green control point at the top to rotate ovals. Hold down Shift to rotate at increments of fifteen degrees.
- Use the arrow keys to reposition ovals. Hold down Shift to move at an increased increment.
- Use the editing aids detailed [here](#)<sup>1075</sup> to assist in the precise placement of ovals.
- Hold down Ctrl to create ovals from their center.
- Right-click ovals for further options. See [here](#)<sup>1783</sup> for an explanation of these options.
- Press Ctrl+' to open the **Properties** pane for selected annotations and view/edit properties:



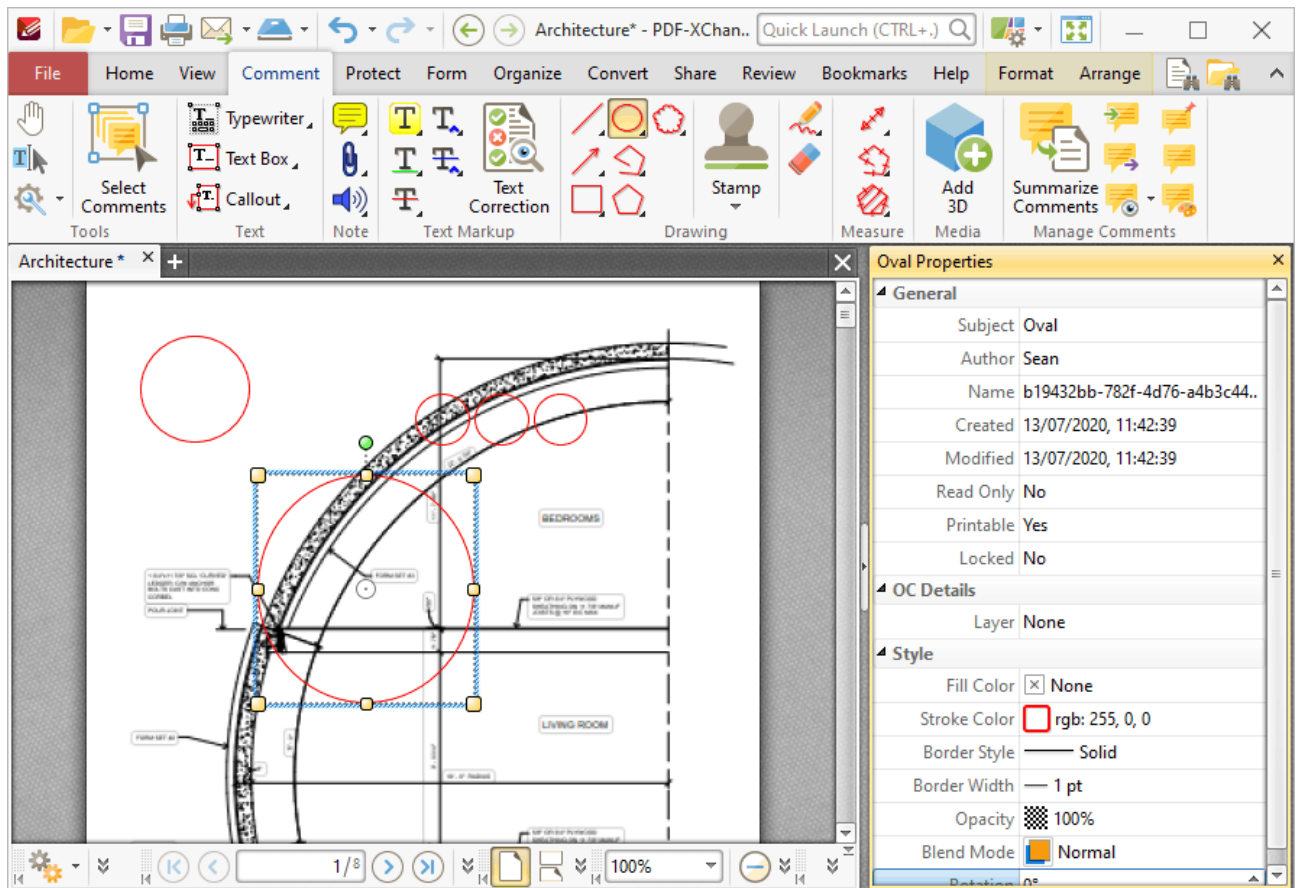

Figure 3. Oval Tool, Oval Properties Pane

- **Subject** is the name of the oval annotation, as referenced in the [Comments](#)<sup>1007</sup> pane.
- **Author** is the name of the user that created the oval annotation.
- **Name** is the unique name of the oval annotation, as referenced within the application.
- **Created** is the date and time at which the oval annotation was created.
- **Modified** is the date and time at which the oval annotation was last modified.
- **Read Only** is the read only status of the oval annotation. If this property is enabled then users cannot interact with the annotation. Please note that it is necessary to use JavaScript to change the value of this property.
- **Printable** is the print status of the oval annotation. If this property is enabled then the annotation is printed with the document. If this property is not enabled then the annotation is not printed.
- **Locked** is the locked status of the oval annotation. If this property is enabled then the annotation cannot be deleted and its properties (including its position and size) cannot be modified by users.
- **Layer** specifies the optional content layer to which the oval annotation belongs. Further information about layers is available [here](#).<sup>1024</sup>
- **Fill Color** determines the color of the line ending style used at the start of the oval annotation. The line ending property is detailed below.
- **Stroke Color** determines the color of the oval annotation.

- **Border Style** determines the style of the annotation.
- **Border Width** determines the width of the annotation.
- **Opacity** determines the level of transparency in the oval annotation.
- **Blend Mode** determines how oval annotations blend with overlapping content. These options are explained [here](#).
- **Rotation** determines the degrees of rotation of the oval annotation.

Note that when the **Oval Tool** is enabled, the **Format** tab is available and can be used to customize the default properties of oval annotations:

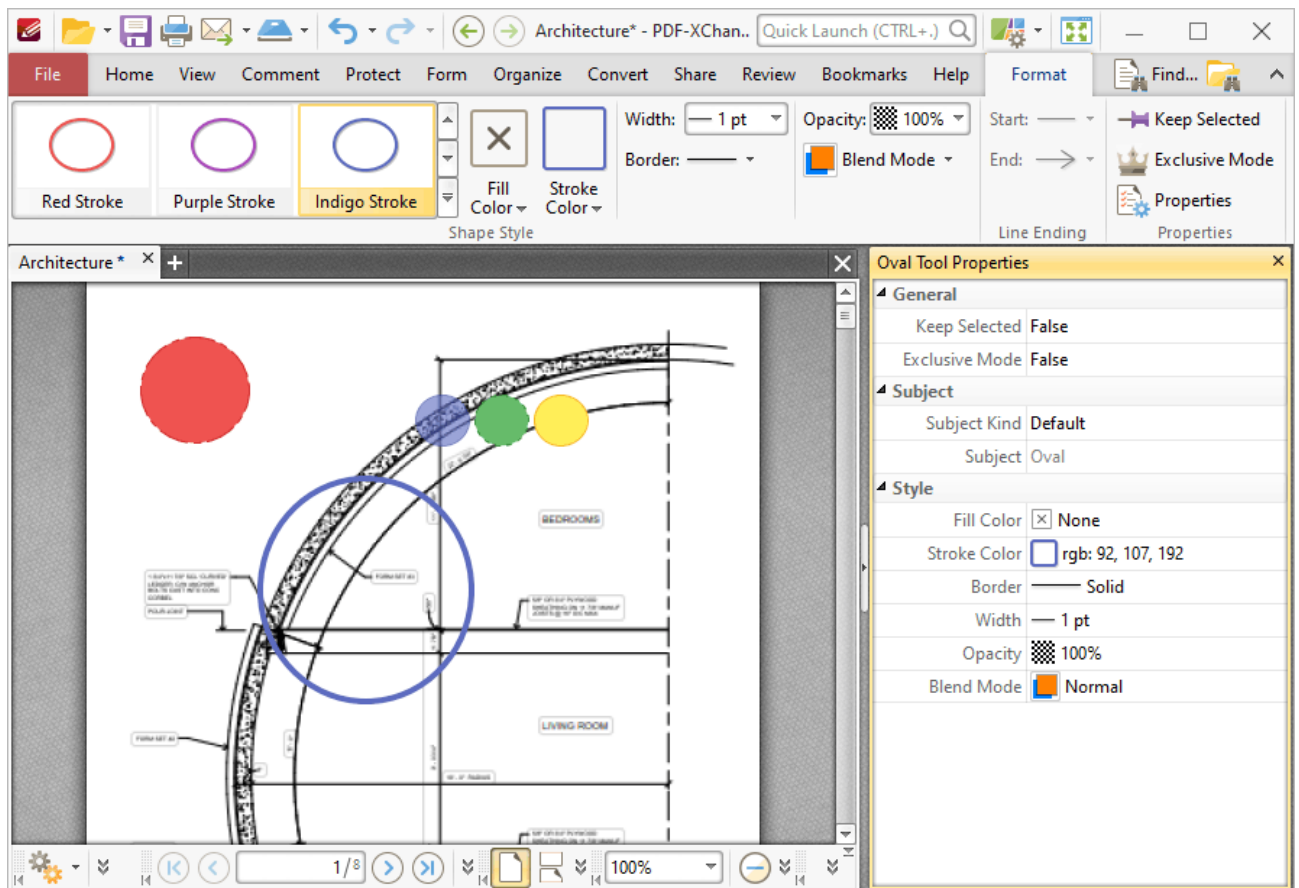

Figure 4. Format Tab, Oval Tool

- Click options in the **Shape Style** group to select alternative default oval annotation styles.
- Click **Keep Selected** to keep the **Oval Tool** enabled and add multiple oval annotations to the document. If this option is not enabled then **PDF-XChange Editor** will revert to the designated default tool immediately after creating one oval annotation.
- Click **Exclusive Mode** to enable exclusive mode, which simplifies the process of using the **Oval Tool**. When **Exclusive Mode** is enabled, the pointer ignores all interactive elements of documents other than base content. This makes it possible to create oval annotations on areas that overlap with other content without the risk of accidentally selecting undesired items. When

**Exclusive Mode** is disabled, the pointer recognizes and interacts with all underlying elements in the usual manner.

- Click **Properties** to open the **Properties** pane and view/edit **Oval Tool** properties, as detailed above.
- When oval annotations are selected, the **Style Tools** dropdown menu is available in the **Format** tab. It contains the following options:
  - Click **Copy Comment Style** to copy the style properties of oval annotations.
  - Click **Apply Copied Comment Style** to apply a copied oval annotation style to selected annotations.
  - Click **Apply Copied Comment Appearance** to apply a copied oval annotation style to selected annotations.
  - Click **Make Current Properties Default** to set the properties of the oval annotation as the default properties for subsequent annotations.
  - Click **Apply Default Properties** to apply the default oval annotation properties to selected oval annotations.
- When oval annotations are selected, the **Pop-up** group is available in the **Format** tab and can be used to interact with the pop-up note of the annotation:
  - Click **Open** to open the pop-up note.
  - Click **Hide** to hide the pop-up note.
  - Click **Reset Location** to reset the location of the pop-up note.
- When oval annotations are selected, the **Arrange** tab is also available and can be used to manipulate comments as detailed [here](#).

Note that the [Comment Styles Palette](#) can be used to edit and save customized oval annotation styles for subsequent use, and the [Commenting](#) preferences can be used to view/edit preferences for all comments.

---

10.4.4.18 Polygon Line Tool



**Polygon Line Tool**

Click the **Polygon Line Tool** to add polygon line annotations to documents:

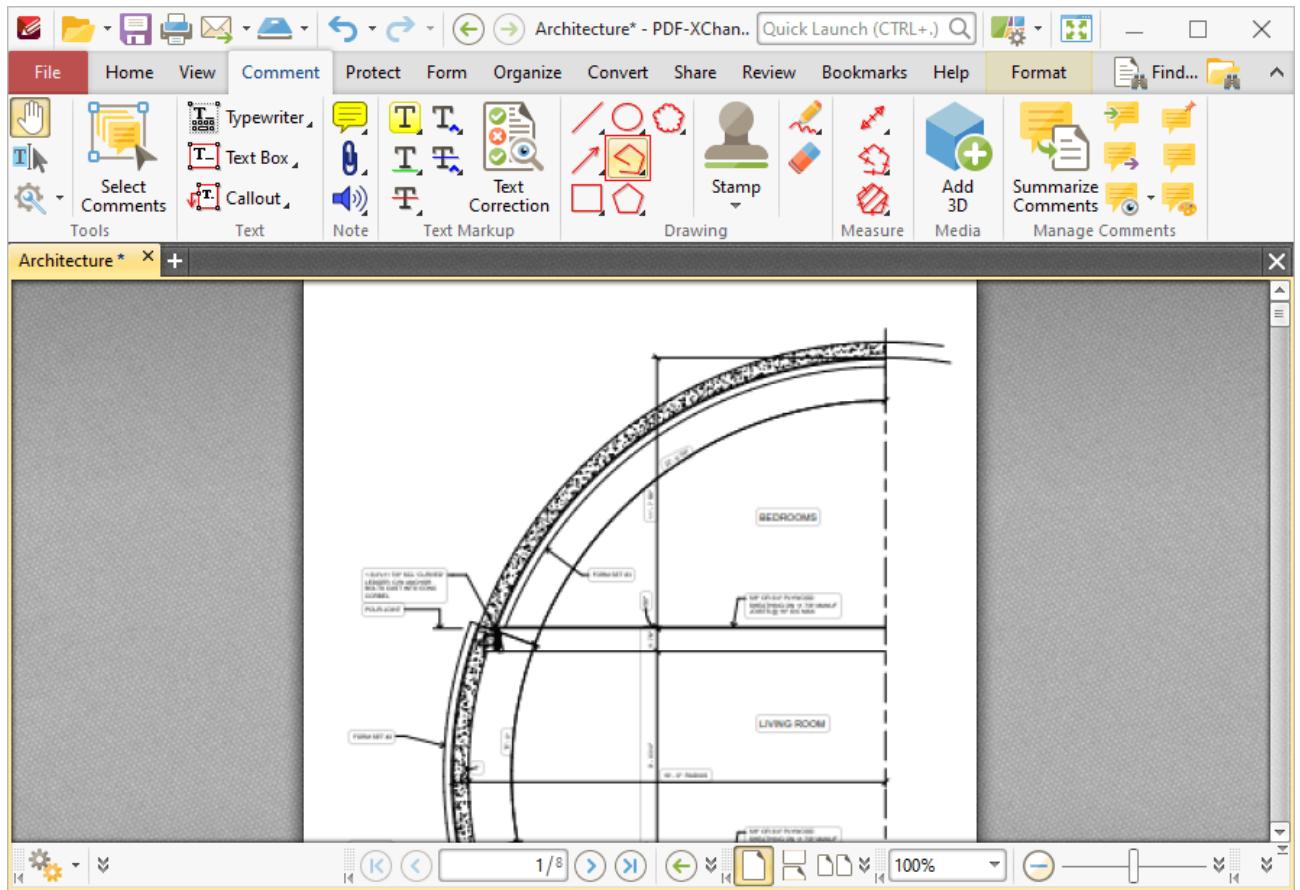

Figure 1. Comment Tab, Polygon Line Tool

When the **Polygon Line Tool** is enabled, click to designate the starting point of the first line. Move the pointer to the next desired location, then click to designate the end of the first line and the beginning of the next line. Repeat this process until the final point of the desired shape is reached, then double-click to complete the annotation, as detailed in the examples below:

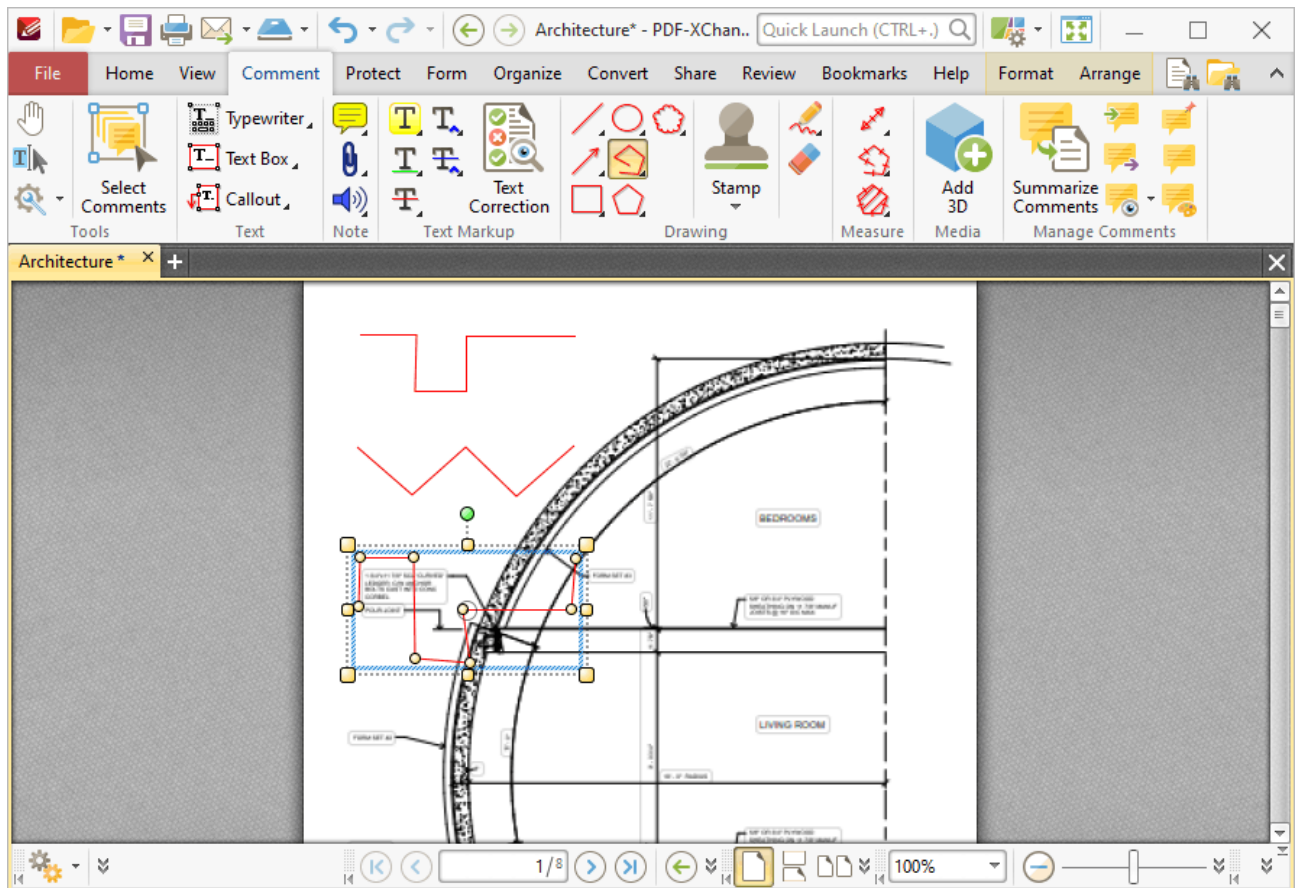

Figure 2. Polygon Line Tool Examples

Click to select polygon line annotations, as detailed in the central annotation in the image above. Selected annotations can be edited as follows:

- Click and drag the outer control points to resize polygon line annotations.
- Click and drag the inner control points to reposition polygon line annotations.
- Click and drag polygon line annotations to reposition them. The circle at the center can also be used for this purpose.
- Click and drag the green control point at the top to rotate polygon line annotations. Hold down Shift to rotate at increments of fifteen degrees.
- Use the arrow keys to reposition polygon line annotations. Hold down Shift to move at an increased increment.
- Use the editing aids detailed [here](#)<sup>1075</sup> to assist in the precise placement of polygon line annotations.
- Right-click polygon line annotations for further options. See [here](#)<sup>1783</sup> for an explanation of these options.
- Press Ctrl+' to open the **Properties** pane for selected annotations and view/edit properties:

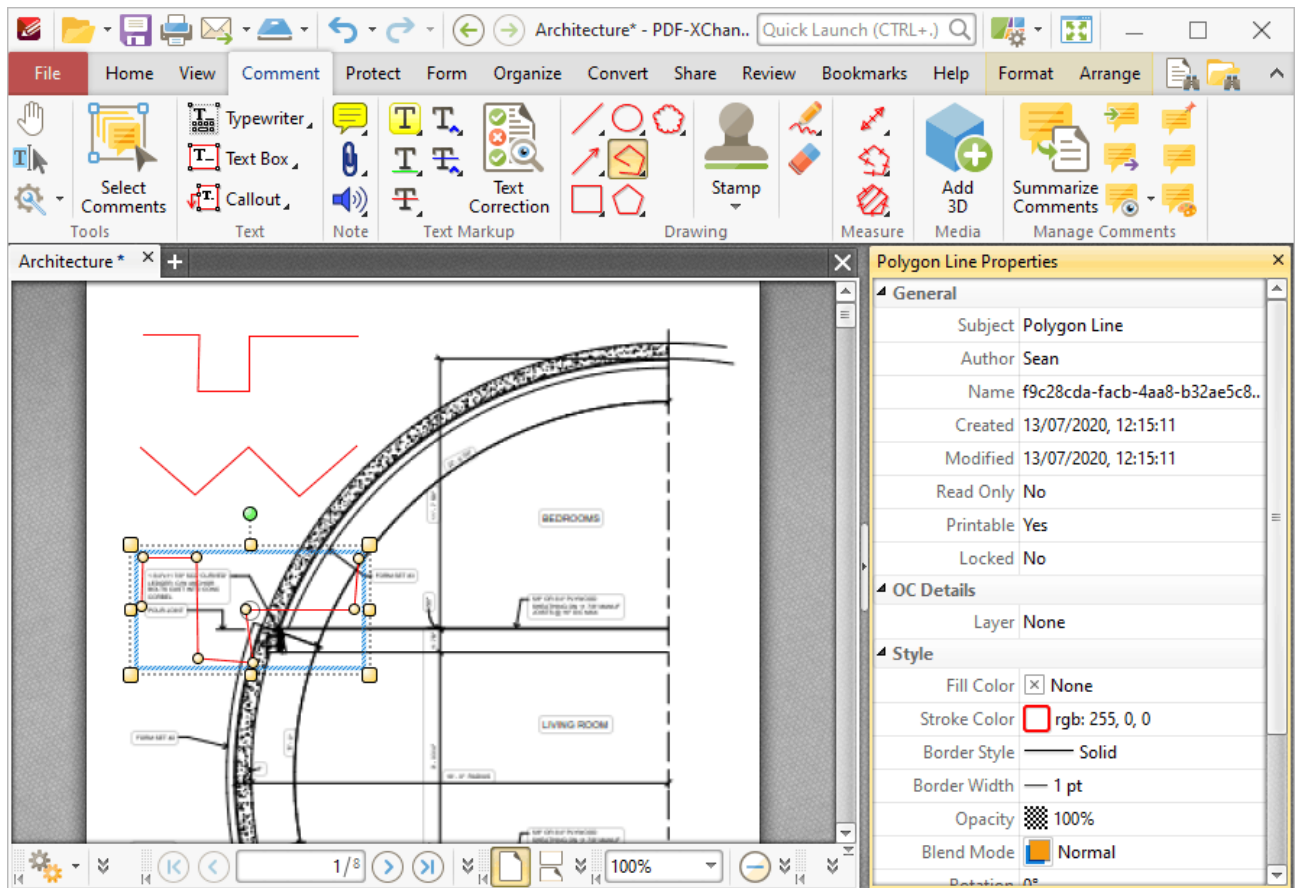

Figure 3. Polygon Line Tool, Polygon Line Properties Pane

- **Subject** is the name of the polygon line annotation, as referenced in the [Comments](#)<sup>1007</sup> pane.
- **Author** is the name of the user that created the polygon line annotation.
- **Name** is the unique name of the polygon line annotation, as referenced within the application.
- **Created** is the date and time at which the polygon line annotation was created.
- **Modified** is the date and time at which the polygon line annotation was last modified.
- **Read Only** is the read only status of the polygon line annotation. If this property is enabled then users cannot interact with the annotation. Please note that it is necessary to use JavaScript to change the value of this property.
- **Printable** is the print status of the polygon line annotation. If this property is enabled then the annotation is printed with the document. If this property is not enabled then the annotation is not printed.
- **Locked** is the locked status of the polygon line annotation. If this property is enabled then the annotation cannot be deleted and its properties (including its position and size) cannot be modified by users.
- **Layer** specifies the optional content layer to which the polygon line annotation belongs. Further information about layers is available [here](#).<sup>1024</sup>
- **Fill Color** determines the color of the line ending style used at the start of the polygon line annotation. The line ending property is detailed below.
- **Stroke Color** determines the color of the polygon line annotation.

- **Border Style** determines the style of the annotation.
- **Border Width** determines the width of the annotation.
- **Opacity** determines the level of transparency in the polygon line annotation.
- **Blend Mode** determines how polygon line annotations blend with overlapping content. These options are explained [here](#).
- **Rotation** determines the degrees of rotation of the polygon line annotation.
- **Start** determines the line ending style used at the start of the polygon line annotation.
- **End** determines the line ending style used at the end of the polygon line annotation.
- **Start Scale** determines the size of the line ending used at the start of the polygon line annotation.
- **End Scale** determines the size of the line ending used at the end of the polygon line annotation.

Note that when the **Polygon Line Tool** is enabled, the **Format** tab is available and can be used to customize the default properties of polygon line annotations:

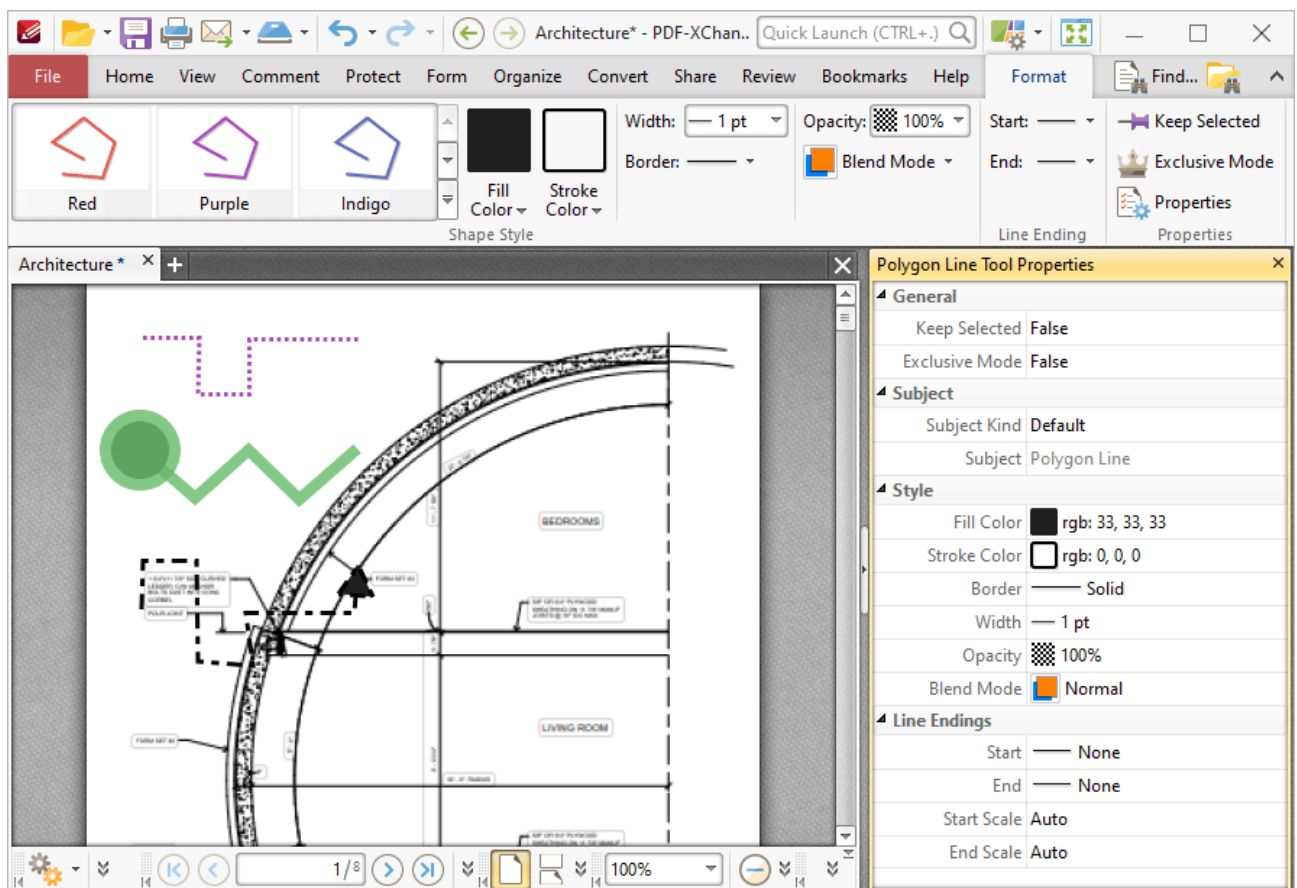

Figure 4. Format Tab, Polygon Line Tool

- Click options in the **Shape Style** group to select alternative default polygon line annotation styles.

- Click **Keep Selected** to keep the **Polygon Line Tool** enabled and add multiple polygon line annotations to the document. If this option is not enabled then **PDF-XChange Editor** will revert to the designated default tool immediately after creating one polygon line annotation.
- Click **Exclusive Mode** to enable exclusive mode, which simplifies the process of using the **Polygon Line Tool**. When **Exclusive Mode** is enabled, the pointer ignores all interactive elements of documents other than base content. This makes it possible to create polygon line annotations on areas that overlap with other content without the risk of accidentally selecting undesired items. When **Exclusive Mode** is disabled, the pointer recognizes and interacts with all underlying elements in the usual manner.
- Click **Properties** to open the **Properties** pane and view/edit **Polygon Line Tool** properties, as detailed above.
- When polygon line annotations are selected, the **Style Tools** dropdown menu is available in the **Format** tab. It contains the following options:
  - Click **Copy Comment Style** to copy the style properties of polygon line annotations.
  - Click **Apply Copied Comment Style** to apply a copied polygon line annotation style to selected annotations.
  - Click **Apply Copied Comment Appearance** to apply a copied polygon line annotation style to selected annotations.
  - Click **Make Current Properties Default** to set the properties of the polygon line annotation as the default properties for subsequent annotations.
  - Click **Apply Default Properties** to apply the default polygon line annotation properties to selected polygon line annotations.
- When polygon line annotations are selected, the **Pop-up** group is available in the **Format** tab and can be used to interact with the pop-up note of the annotation:
  - Click **Open** to open the pop-up note.
  - Click **Hide** to hide the pop-up note.
  - Click **Reset Location** to reset the location of the pop-up note.
- When polygon line annotations are selected, the **Arrange** tab is also available and can be used to manipulate comments as detailed [here](#).<sup>1626</sup>

Note that the [Comment Styles Palette](#)<sup>1242</sup> can be used to edit and save customized polygon line annotation styles for subsequent use, and the [Commenting](#)<sup>875</sup> preferences can be used to view/edit preferences for all comments.

## Convert Polygon Line Annotations to Perimeter Annotations

If you want to convert polygon line annotations to perimeter annotations, then right-click the polygon line annotation and click **Convert to Perimeter**:



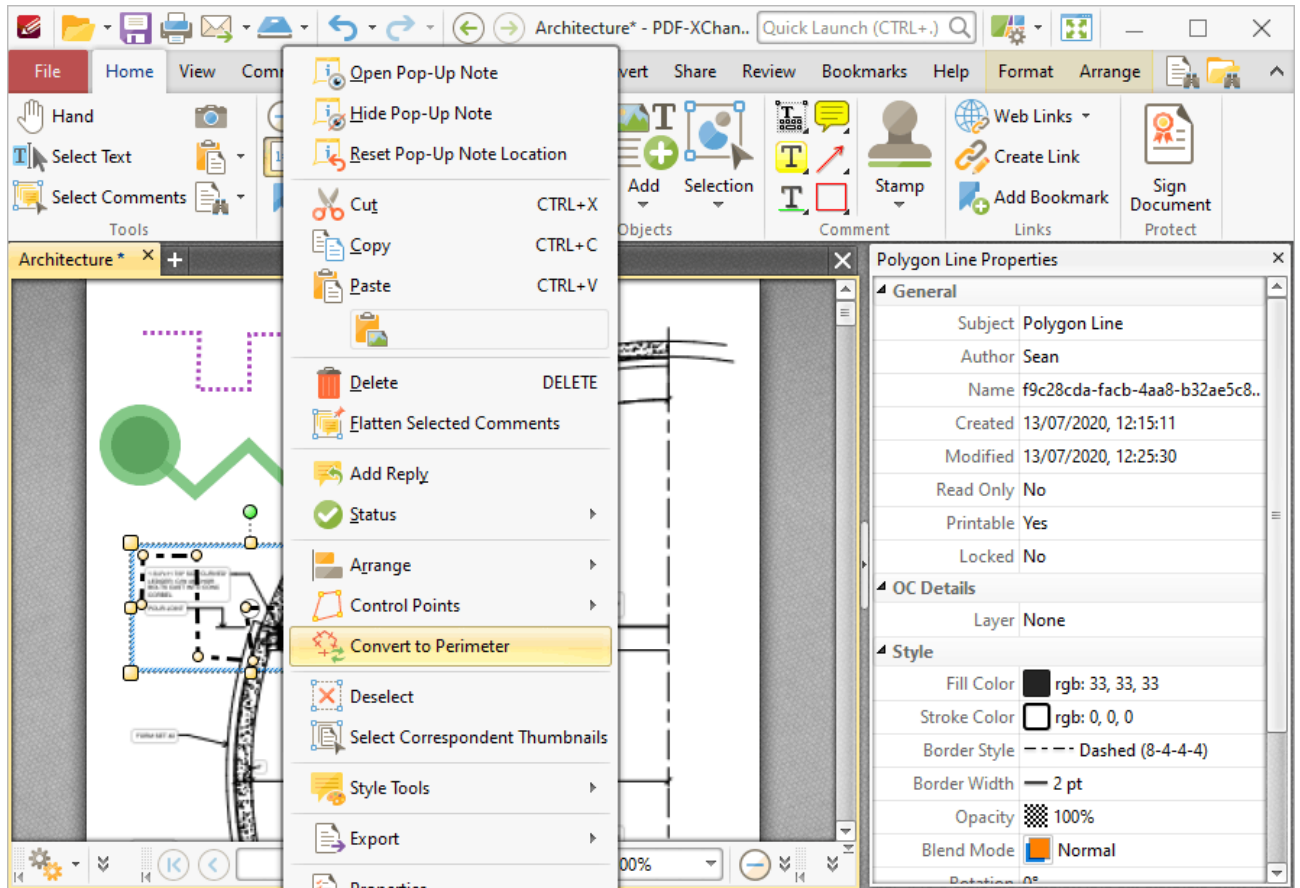

Figure 5. Right-Click Shortcut Menu, Convert to Perimeter Highlighted

The polygon line annotation will then convert into a perimeter annotation. Note that it is possible to convert multiple annotations at the same time.

## 10.4.4.19 Polygon Tool

**Polygon Tool**

Click the **Polygon Tool** to add polygon annotations to documents:

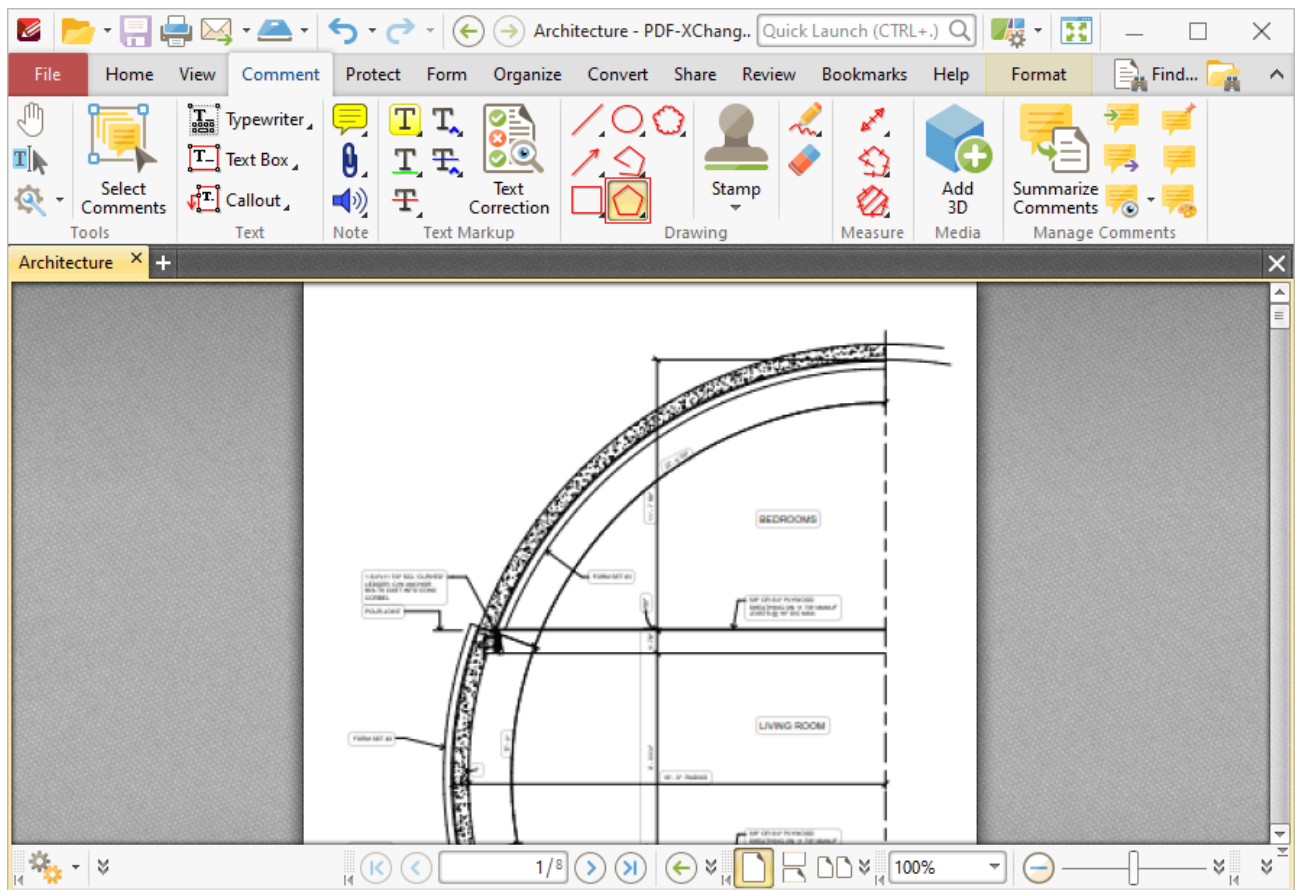

**Figure 1.** Comment Tab, Polygon Tool

When the **Polygon Tool** is enabled, click to designate the first point of the polygon, then move the pointer to the next location and click to designate the second point. Repeat this process until the final point of the desired shape is reached and then double-click to complete the polygon:

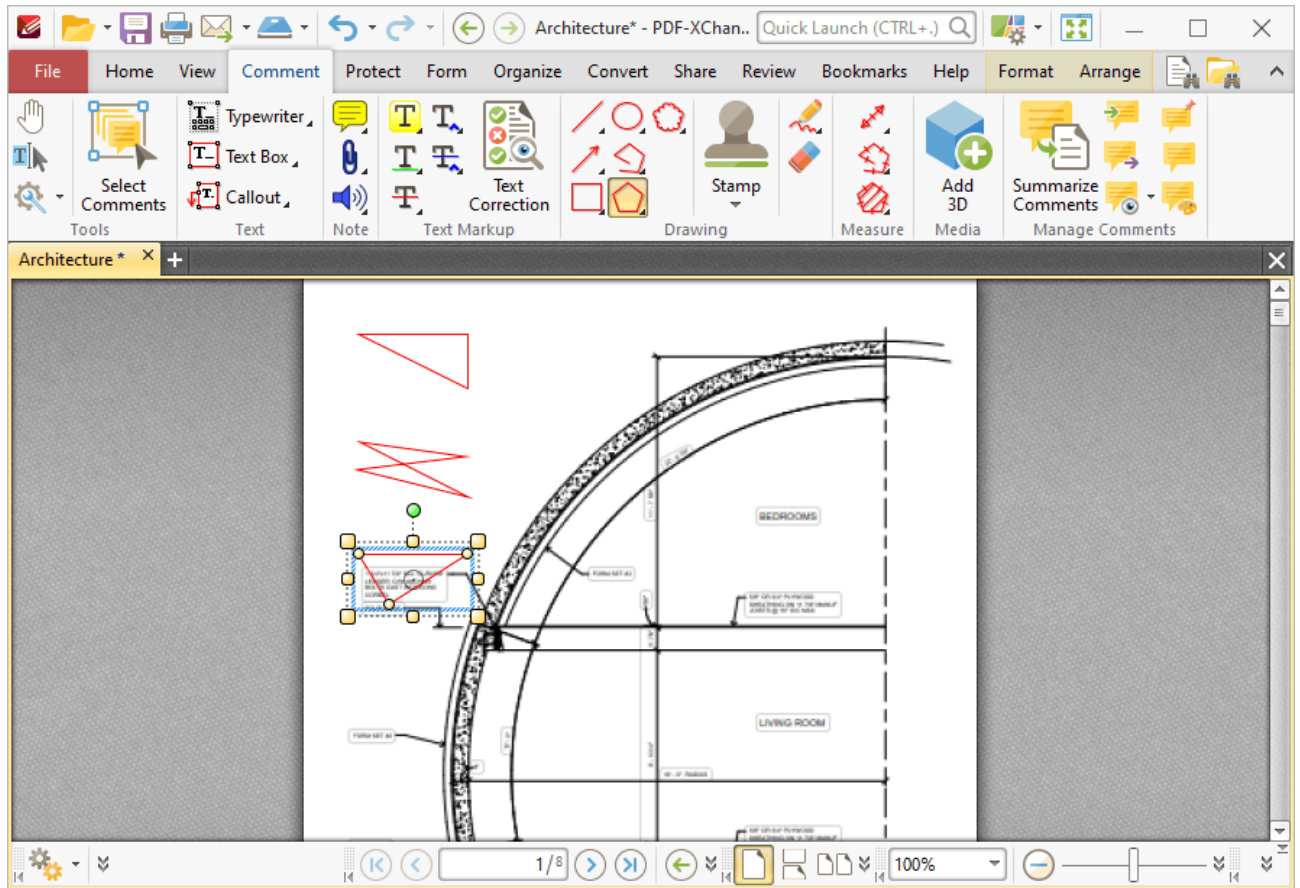

Figure 2. Polygon Tool Examples

Click to select polygon annotations, as detailed in the lower annotation in the image above. Selected annotations can be edited as follows:

- Click and drag the outer control points to resize polygons.
- Click and drag the inner control points to reposition polygons.
- Click and drag to reposition polygons. The circle at the center can also be used for this purpose.
- Click and drag the green control point at the top to rotate polygons. Hold down Shift to rotate at increments of fifteen degrees.
- Use the arrow keys to reposition polygons. Hold down Shift to move at an increased increment.
- Use the editing aids detailed [here](#)<sup>1075</sup> to assist in the precise placement of polygons.
- Right-click polygons for further options. See [here](#)<sup>1783</sup> for an explanation of these options.
- Press Ctrl+' to open the **Properties** pane for selected annotations and view/edit properties:

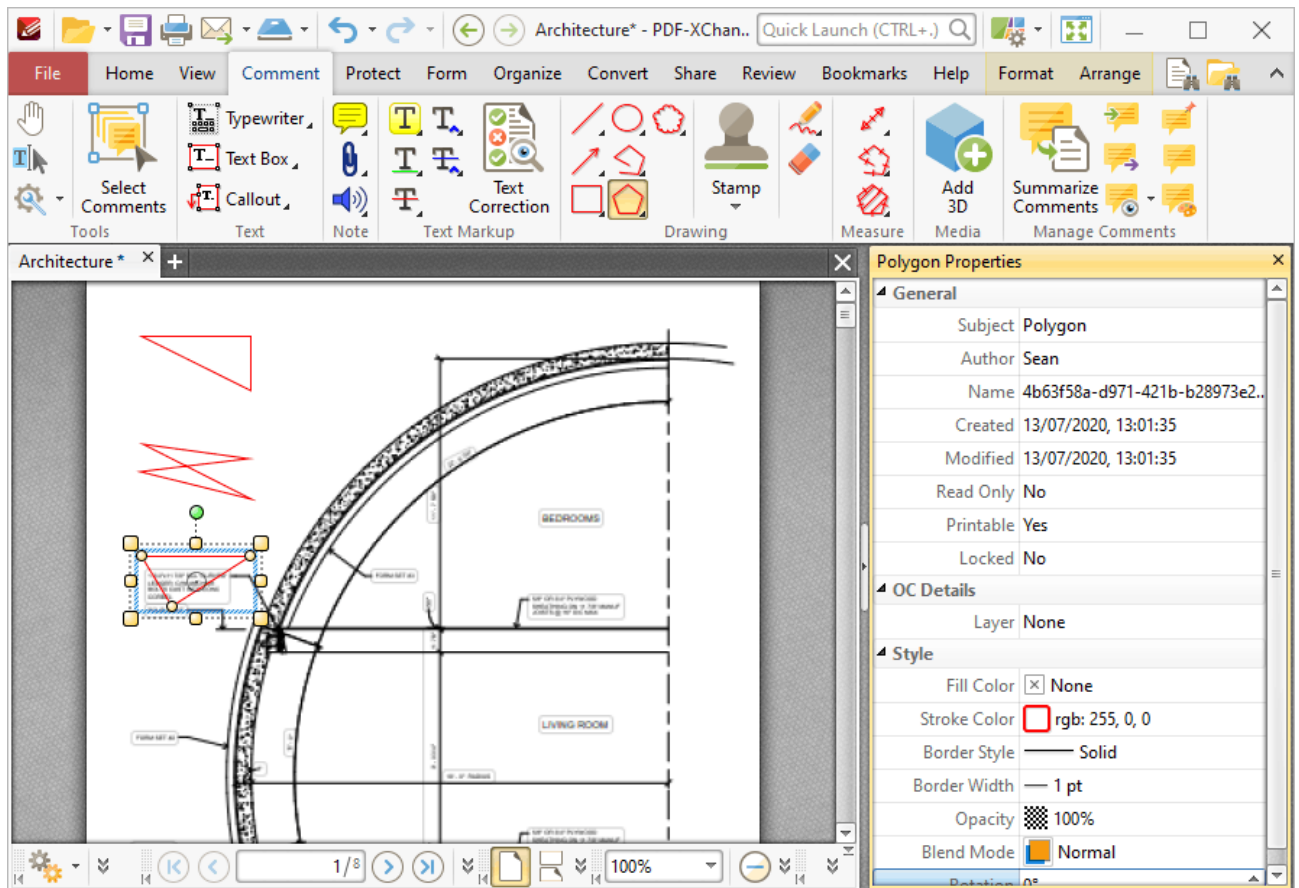

Figure 3. Polygon Tool, Polygon Properties Pane

- **Subject** is the name of the polygon annotation, as referenced in the [Comments](#) <sup>1007</sup> pane.
- **Author** is the name of the user that created the polygon annotation.
- **Name** is the unique name of the polygon annotation, as referenced within the application.
- **Created** is the date and time at which the polygon annotation was created.
- **Modified** is the date and time at which the polygon annotation was last modified.
- **Read Only** is the read only status of the polygon annotation. If this property is enabled then users cannot interact with the annotation. Please note that it is necessary to use JavaScript to change the value of this property.
- **Printable** is the print status of the polygon annotation. If this property is enabled then the annotation is printed with the document. If this property is not enabled then the annotation is not printed.
- **Locked** is the locked status of the polygon annotation. If this property is enabled then the annotation cannot be deleted and its properties (including its position and size) cannot be modified by users.
- **Layer** specifies the optional content layer to which the polygon annotation belongs. Further information about layers is available [here](#). <sup>1024</sup>
- **Fill Color** determines the color of the line ending style used at the start of the polygon annotation. The line ending property is detailed below.
- **Stroke Color** determines the color of the polygon annotation.

- **Border Style** determines the style of the annotation.
- **Border Width** determines the width of the annotation.
- **Opacity** determines the level of transparency in the polygon annotation.
- **Blend Mode** determines how polygon annotations blend with overlapping content. These options are explained [here](#).
- **Rotation** determines the degrees of rotation of the polygon annotation.

Note that when the **Polygon Tool** is enabled, the **Format** tab is available and can be used to customize the default properties of polygon annotations:

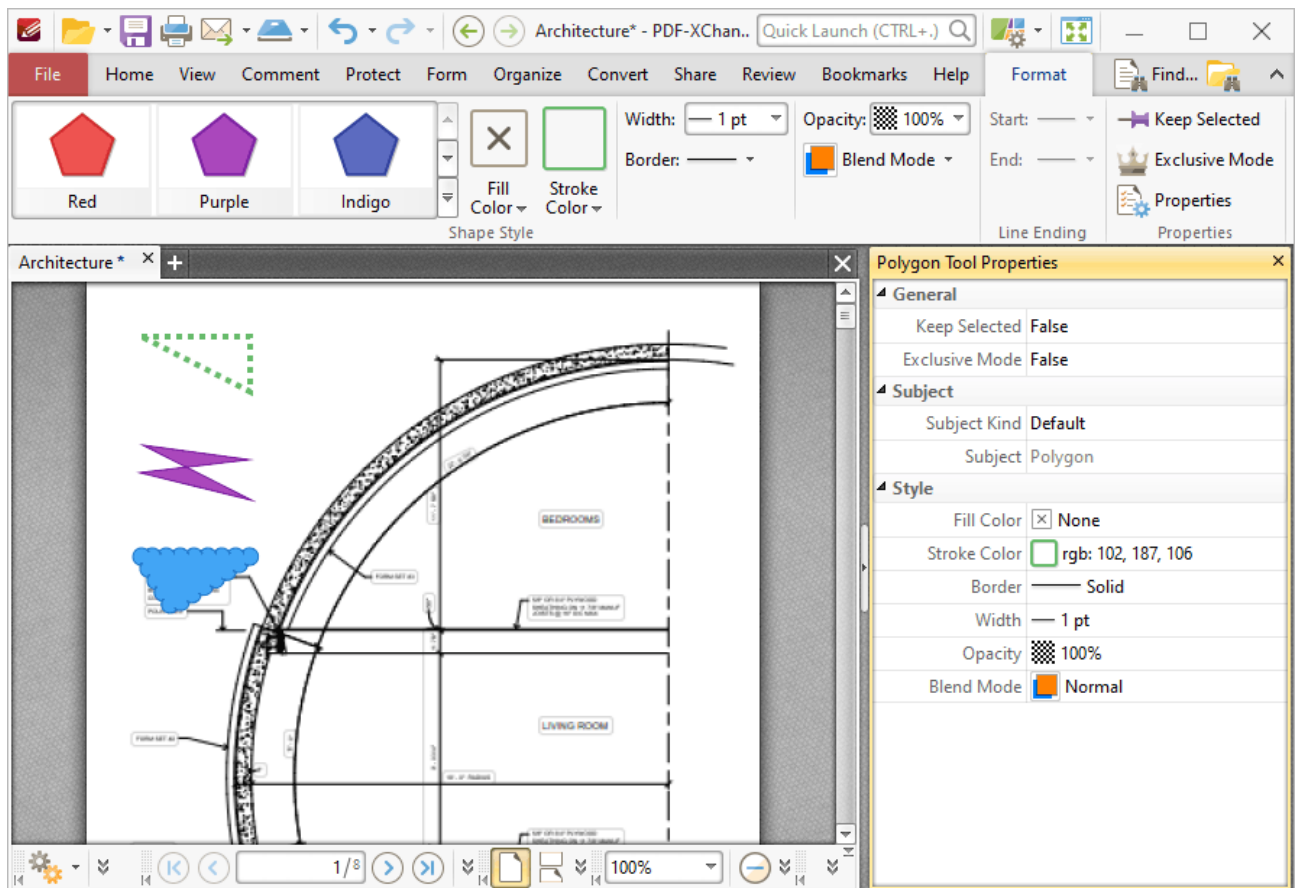

Figure 4. Format Tab, Polygon Tool

- Click options in the **Shape Style** group to select alternative default polygon annotation styles.
- Click **Keep Selected** to keep the **Polygon Tool** enabled and add multiple polygon annotations to the document. If this option is not enabled then **PDF-XChange Editor** will revert to the designated default tool immediately after creating one polygon annotation.
- Click **Exclusive Mode** to enable exclusive mode, which simplifies the process of using the **Polygon Tool**. When **Exclusive Mode** is enabled, the pointer ignores all interactive elements of documents other than base content. This makes it possible to create polygon annotations on areas that overlap with other content without the risk of accidentally selecting undesired items.

When **Exclusive Mode** is disabled, the pointer recognizes and interacts with all underlying elements in the usual manner.

- Click **Properties** to open the **Properties** pane and view/edit **Polygon Tool** properties, as detailed above.
- When polygon annotations are selected, the **Style Tools** dropdown menu is available in the **Format** tab. It contains the following options:
  - Click **Copy Comment Style** to copy the style properties of polygon annotations.
  - Click **Apply Copied Comment Style** to apply a copied polygon annotation style to selected annotations.
  - Click **Apply Copied Comment Appearance** to apply a copied polygon annotation style to selected annotations.
  - Click **Make Current Properties Default** to set the properties of the polygon annotation as the default properties for subsequent annotations.
  - Click **Apply Default Properties** to apply the default polygon annotation properties to selected polygon annotations.
- When polygon annotations are selected, the **Pop-up** group is available in the **Format** tab and can be used to interact with the pop-up note of the annotation:
  - Click **Open** to open the pop-up note.
  - Click **Hide** to hide the pop-up note.
  - Click **Reset Location** to reset the location of the pop-up note.
- When polygon annotations are selected, the **Arrange** tab is also available and can be used to manipulate comments as detailed [here](#).

Note that the [Comment Styles Palette](#) can be used to edit and save customized polygon annotation styles for subsequent use, and the [Commenting](#) preferences can be used to view/edit preferences for all comments.

---

10.4.4.20 Cloud Tool



**Cloud Tool**

Click **Cloud Tool** to add cloud annotations to documents:

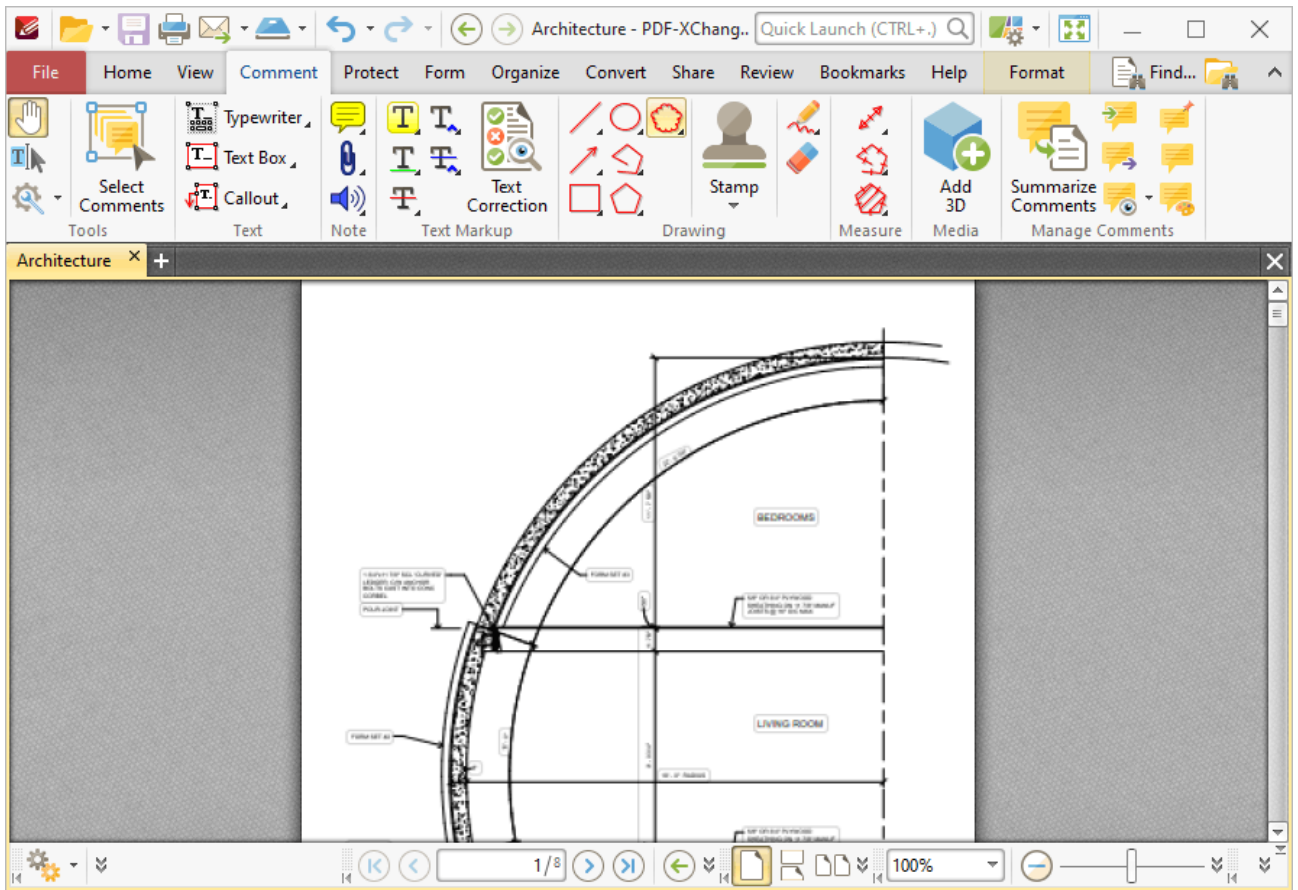

Figure 1. Comment Tab, Cloud Tool

When the **Cloud Tool** is enabled, the pointer becomes a crosshairs icon. Click to designate the starting point of the cloud annotation. Drag the crosshairs to the location at which the first line is to be made. Click again to define the first line of the annotation. Repeat the process until the desired shape is complete and then double-click to define the final point:

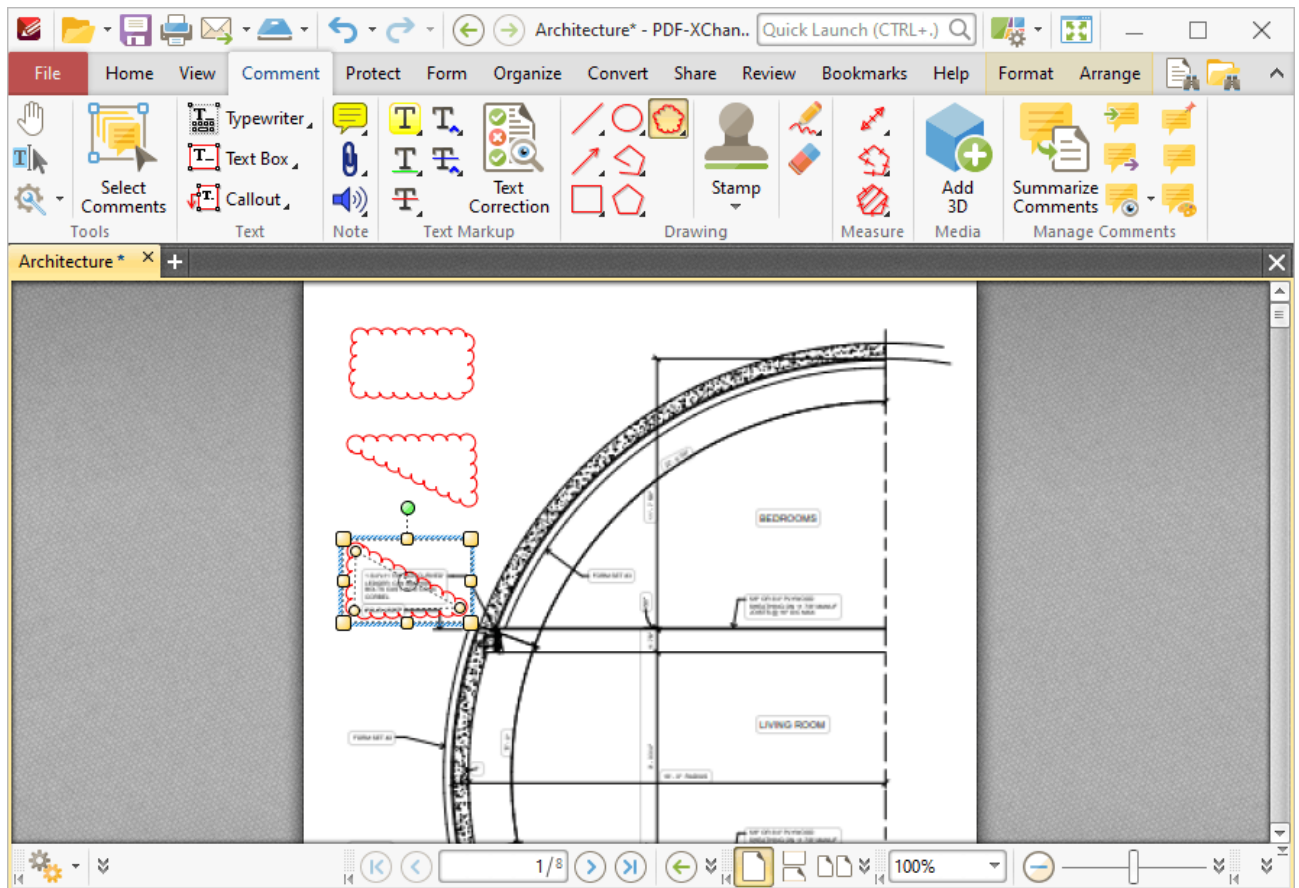

Figure 2. Cloud Tool Examples

Click to select cloud annotations, as detailed in the lower annotation in the image above. Selected annotations can be edited as follows:

- Click and drag the outer control points to resize cloud annotations.
- Click and drag the inner control points to reposition cloud annotations.
- Click and drag cloud annotations to reposition them. The circle at the center can also be used for this purpose.
- Click and drag the green control point at the top to rotate cloud annotations. Hold down Shift to rotate at increments of fifteen degrees.
- Use the arrow keys to reposition cloud annotations. Hold down Shift to move at an increased increment.
- Use the editing aids detailed [here](#)<sup>1075</sup> to assist in the precise placement of cloud annotations.
- Right-click cloud annotations for further options. See [here](#)<sup>1783</sup> for an explanation of these options.
- Press Ctrl+' to open the **Properties** pane for selected annotations and view/edit properties:



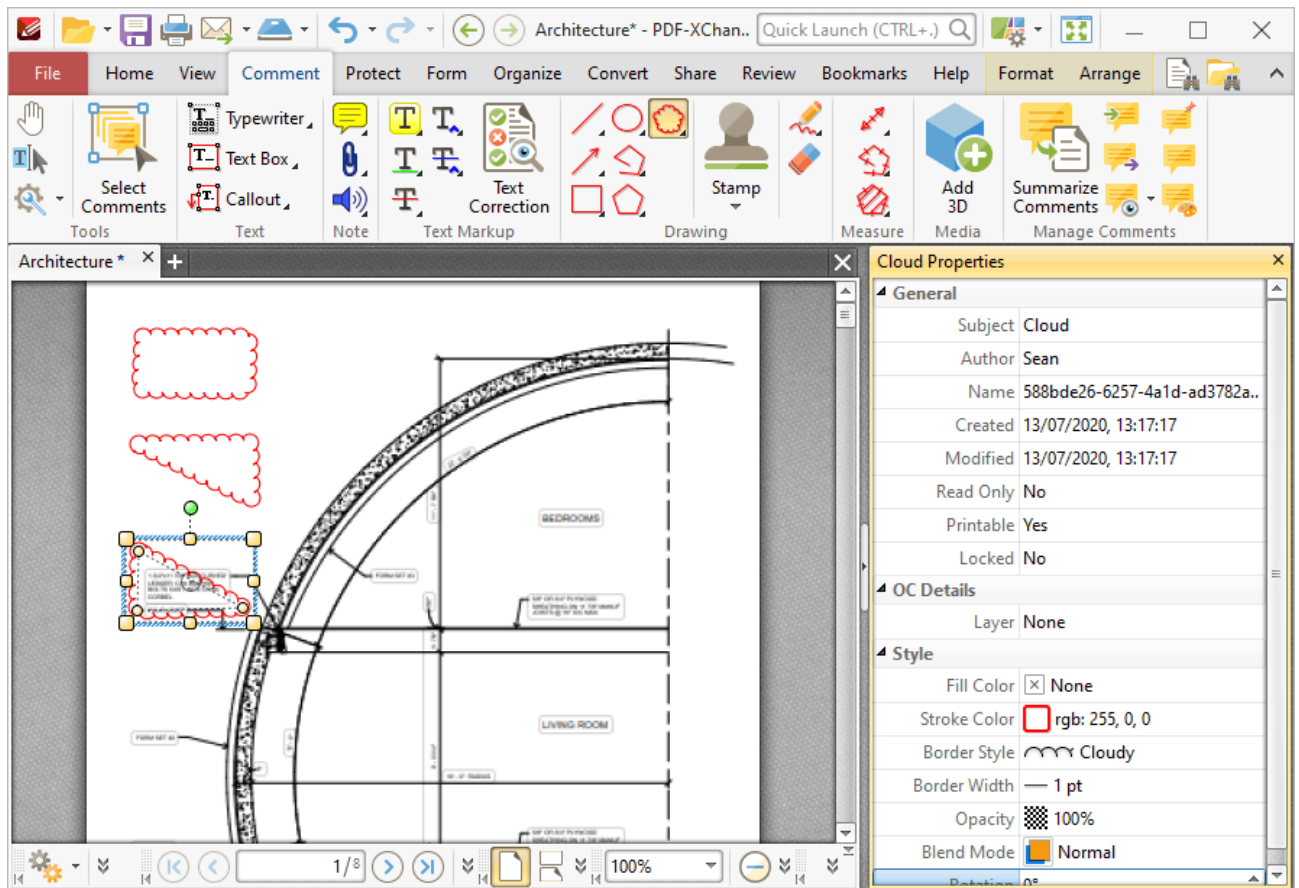

Figure 3. Cloud Tool, Cloud Properties Pane

- **Subject** is the name of the cloud annotation, as referenced in the [Comments](#)<sup>1007</sup> pane.
- **Author** is the name of the user that created the cloud annotation.
- **Name** is the unique name of the cloud annotation, as referenced within the application.
- **Created** is the date and time at which the cloud annotation was created.
- **Modified** is the date and time at which the cloud annotation was last modified.
- **Read Only** is the read only status of the cloud annotation. If this property is enabled then users cannot interact with the annotation. Please note that it is necessary to use JavaScript to change the value of this property.
- **Printable** is the print status of the cloud annotation. If this property is enabled then the annotation is printed with the document. If this property is not enabled then the annotation is not printed.
- **Locked** is the locked status of the cloud annotation. If this property is enabled then the annotation cannot be deleted and its properties (including its position and size) cannot be modified by users.
- **Layer** specifies the optional content layer to which the cloud annotation belongs. Further information about layers is available [here](#).<sup>1024</sup>
- **Fill Color** determines the color of the line ending style used at the start of the cloud annotation. The line ending property is detailed below.
- **Stroke Color** determines the color of the cloud annotation.

- **Border Style** determines the style of the annotation.
- **Border Width** determines the width of the annotation.
- **Opacity** determines the level of transparency in the cloud annotation.
- **Blend Mode** determines how cloud annotations blend with overlapping content. These options are explained [here](#).
- **Rotation** determines the degrees of rotation of the cloud annotation.

Note that when the **Cloud Tool** is enabled, the **Format** tab is available and can be used to customize the default properties of cloud annotations:

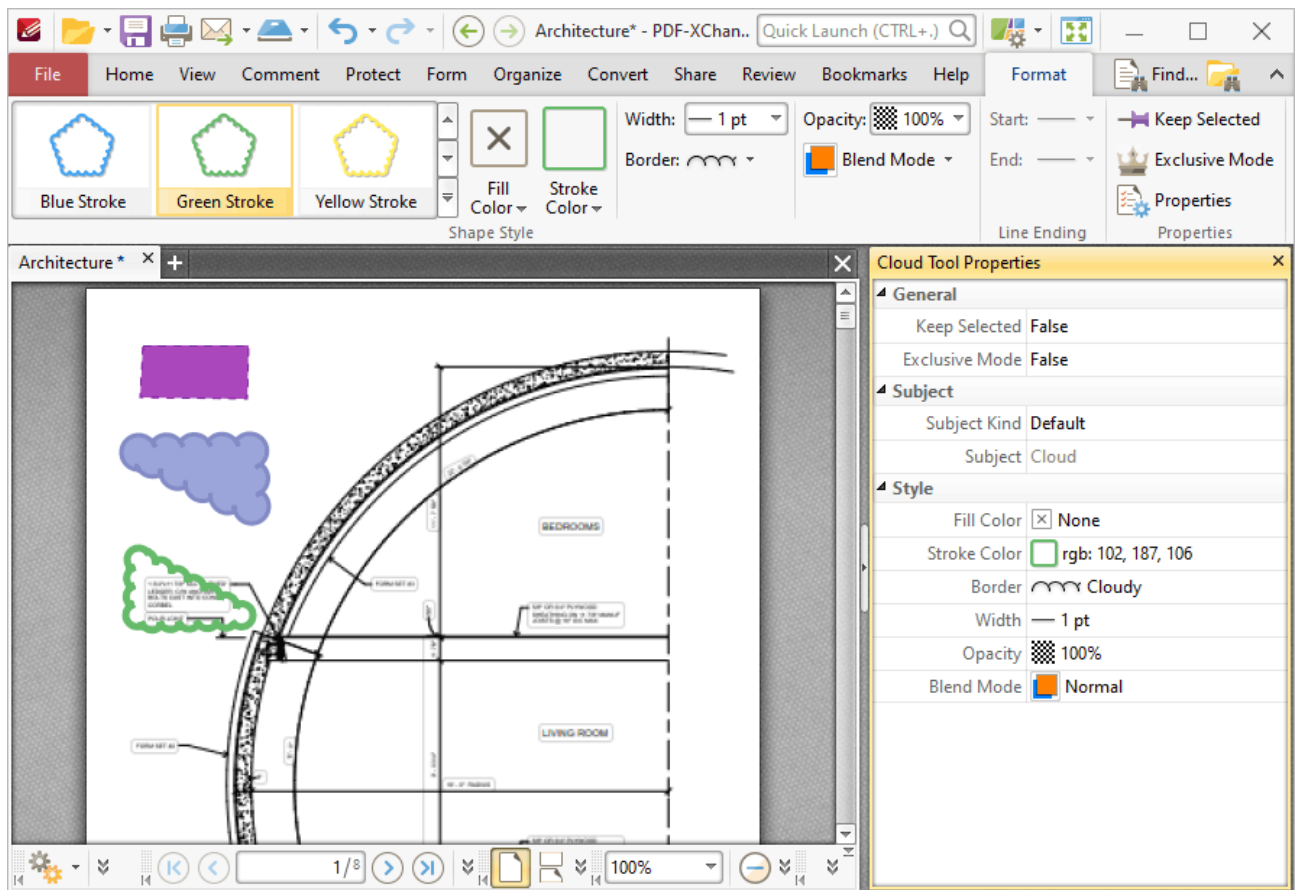

Figure 4. Format Tab, Cloud Tool

- Click options in the **Shape Style** group to select alternative default cloud annotation styles.
- Click **Keep Selected** to keep the **Cloud Tool** enabled and add multiple cloud annotations to the document. If this option is not enabled then **PDF-XChange Editor** will revert to the designated default tool immediately after creating one cloud annotation.
- Click **Exclusive Mode** to enable exclusive mode, which simplifies the process of using the **Cloud Tool**. When **Exclusive Mode** is enabled, the pointer ignores all interactive elements of documents other than base content. This makes it possible to create cloud annotations on areas that overlap with other content without the risk of accidentally selecting undesired items. When

**Exclusive Mode** is disabled, the pointer recognizes and interacts with all underlying elements in the usual manner.

- Click **Properties** to open the **Properties** pane and view/edit **Cloud Tool** properties, as detailed above.
- When cloud annotations are selected, the **Style Tools** dropdown menu is available in the **Format** tab. It contains the following options:
  - Click **Copy Comment Style** to copy the style properties of cloud annotations.
  - Click **Apply Copied Comment Style** to apply a copied cloud annotation style to selected annotations.
  - Click **Apply Copied Comment Appearance** to apply a copied cloud annotation style to selected annotations.
  - Click **Make Current Properties Default** to set the properties of the cloud annotation as the default properties for subsequent annotations.
  - Click **Apply Default Properties** to apply the default cloud annotation properties to selected cloud annotations.
- When cloud annotations are selected, the **Pop-up** group is available in the **Format** tab and can be used to interact with the pop-up note of the annotation:
  - Click **Open** to open the pop-up note.
  - Click **Hide** to hide the pop-up note.
  - Click **Reset Location** to reset the location of the pop-up note.
- When cloud annotations are selected, the **Arrange** tab is also available and can be used to manipulate comments as detailed [here](#).<sup>1626</sup>

Note that the [Comment Styles Palette](#)<sup>1242</sup> can be used to edit and save customized cloud annotation styles for subsequent use, and the [Commenting](#)<sup>875</sup> preferences can be used to view/edit preferences for all comments.

---

## 10.4.4.21 Stamp Tool

**Stamp Tool**

Click **Stamp Tool** to add stamps to documents:

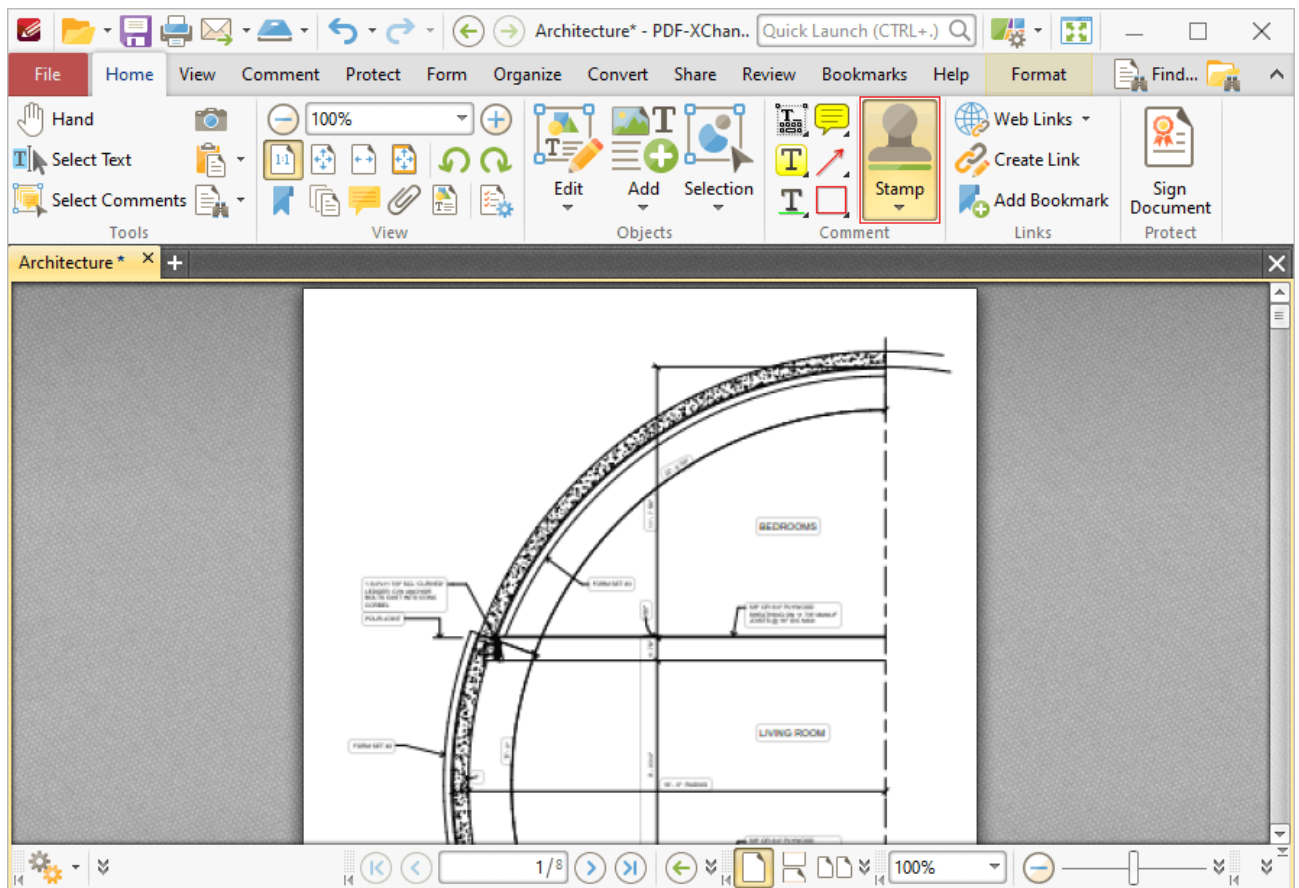

**Figure 1.** Comment Tab, Stamp Tool

Note that this button is divided into two sections. Click the dropdown menu arrow to view/select available stamps, as detailed in **(figure 6)** below. Click the image to enable the **Stamp Tool**. When the **Stamp Tool** is enabled, the active stamp will be displayed beneath the pointer. Move the pointer to the desired location and then click to add stamps:

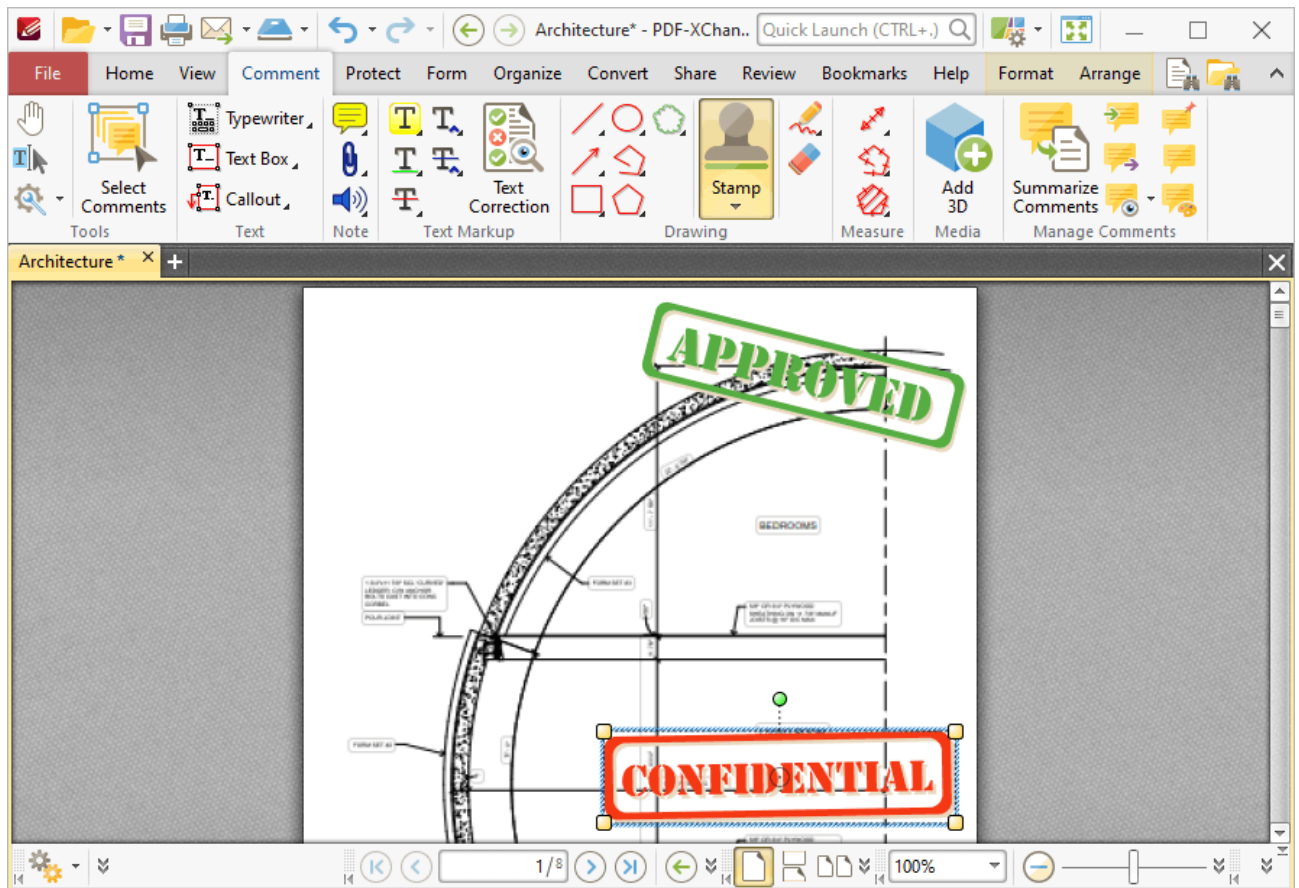

Figure 2. Stamp Tool Example

Click to select stamps, as detailed in the lower stamp in the image above. Selected stamps can be edited as follows:

- Click and drag the yellow control points to resize stamps. Please note that stamp proportions are constrained.
- Click and drag to reposition stamps.
- Click and drag the green control point to rotate stamps. Hold down Shift to rotate at increments of fifteen degrees.
- Use the arrow keys to reposition stamps. Hold down Shift to move at an increased increment.
- Use the editing aids detailed [here](#)<sup>1075</sup> to assist in the precise placement of stamps.
- Right-click stamps for further options. See [here](#)<sup>1785</sup> for an explanation of these options.
- Press Ctrl+' to open the **Properties** pane for selected annotations and view/edit properties:

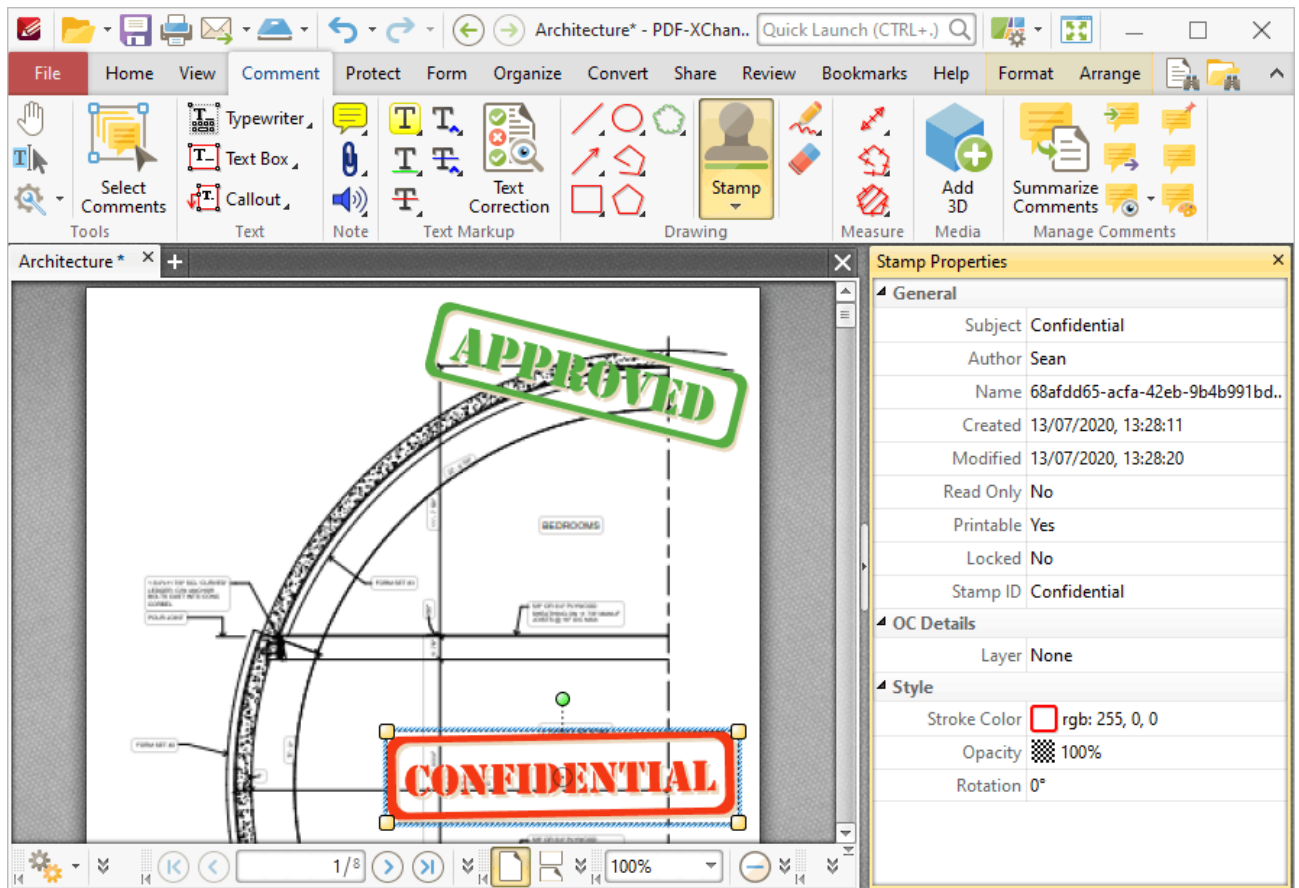

Figure 3. Stamp Tool, Stamp Properties Pane

- **Subject** is the name of the stamp annotation, as referenced in the [Comments](#) pane.
- **Author** is the name of the user that created the stamp annotation.
- **Name** is the unique name of the stamp annotation, as referenced within the application.
- **Created** is the date and time at which the stamp annotation was created.
- **Modified** is the date and time at which the stamp annotation was last modified.
- **Read Only** is the read only status of the stamp annotation. If this property is enabled then users cannot interact with the annotation. Please note that it is necessary to use JavaScript to change the value of this property.
- **Printable** is the print status of the stamp annotation. If this property is enabled then the annotation is printed with the document. If this property is not enabled then the annotation is not printed.
- **Locked** is the locked status of the stamp annotation. If this property is enabled then the annotation cannot be deleted and its properties (including its position and size) cannot be modified by users.
- **Stamp ID** is the name of the icon used to display the stamp.
- **Layer** specifies the optional content layer to which the stamp annotation belongs. Further information about layers is available [here](#).
- **Stroke Color** determines the stroke color of the stamp annotation.
- **Border Style** determines the style of the stamp annotation.

- **Border Width** determines the width of the stamp annotation.
- **Opacity** determines the level of transparency in the stamp annotation.
- **Blend Mode** determines how stamp annotations blend with overlapping content. These options are explained [here](#).
- **Rotation** determines the degrees of rotation of the stamp annotation.

Note that when the **Stamp Tool** is enabled, the **Format** tab is available and can be used to customize the default properties of stamp annotations:

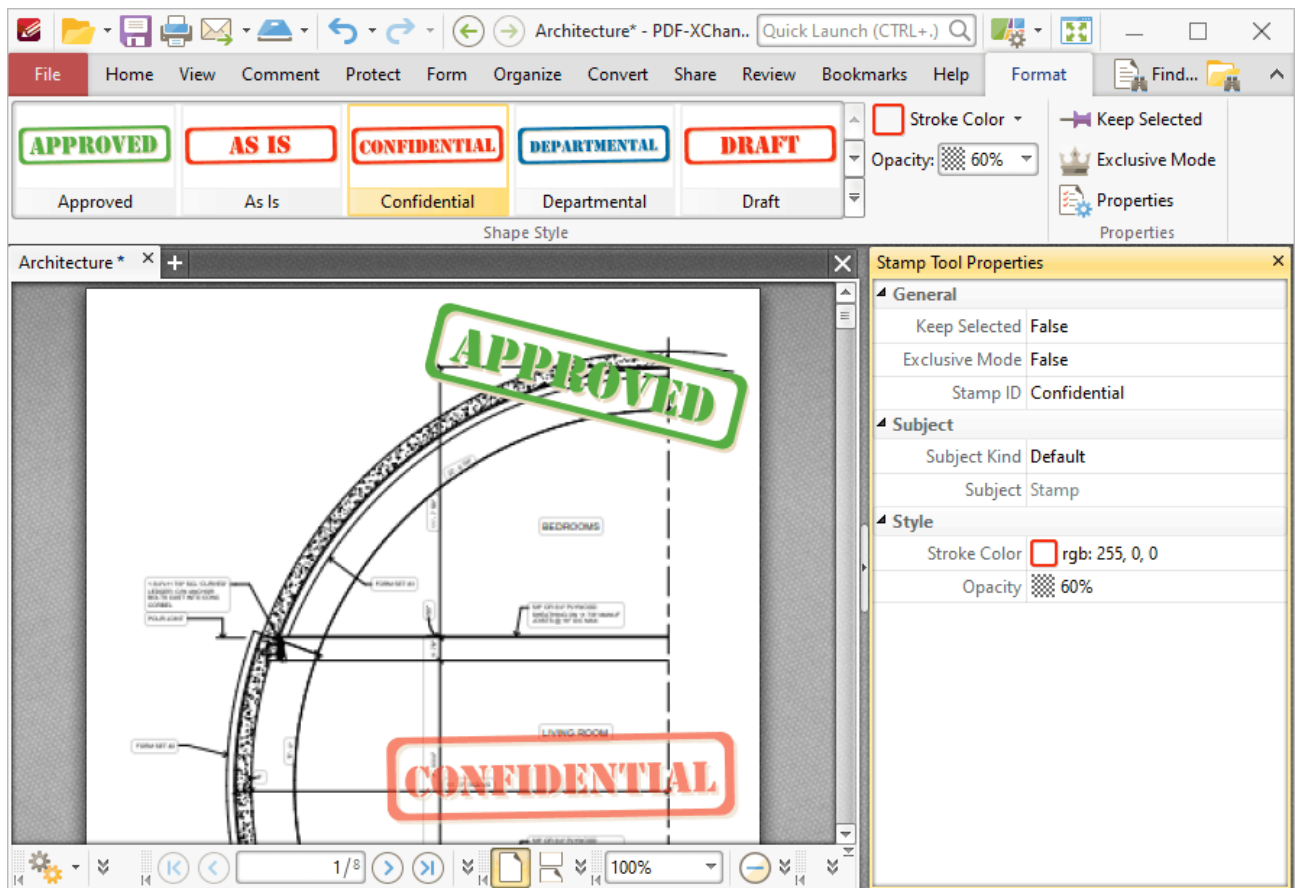

Figure 4. Format Tab, Stamp Tool

- Click options in the **Shape Style** group to select alternative default stamp annotation styles.
- Click **Keep Selected** to keep the **Stamp Tool** enabled and add multiple stamp annotations to the document. If this option is not enabled then **PDF-XChange Editor** will revert to the designated default tool immediately after creating one stamp annotation.
- Click **Exclusive Mode** to enable exclusive mode, which simplifies the process of using the **Stamp Tool**. When **Exclusive Mode** is enabled, the pointer ignores all interactive elements of documents other than base content. This makes it possible to create stamp annotations on areas that overlap with other content without the risk of accidentally selecting undesired items. When **Exclusive Mode** is disabled, the pointer recognizes and interacts with all underlying elements in the usual manner.

- Click **Properties** to open the **Properties** pane and view/edit **Stamp Tool** properties, as detailed above. Property definitions are detailed [here](#).<sup>[1786]</sup>
- When stamp annotations are selected, the **Pop-up** group is available in the **Format** tab and can be used to interact with the pop-up note of the annotation:
  - Click **Open** to open the pop-up note.
  - Click **Hide** to hide the pop-up note.
  - Click **Reset Location** to reset the location of the pop-up note.
- When stamp annotations are selected, the **Arrange** tab is also available and can be used to manipulate comments as detailed [here](#).<sup>[1626]</sup>

Note that the [Comment Styles Palette](#)<sup>[1242]</sup> can be used to edit and save customized stamp annotation styles for subsequent use, and the [Commenting](#)<sup>[875]</sup> preferences can be used to view/edit preferences for all comments.

### Stamps Pane

Click the **Stamp** dropdown menu to view/select available stamps:

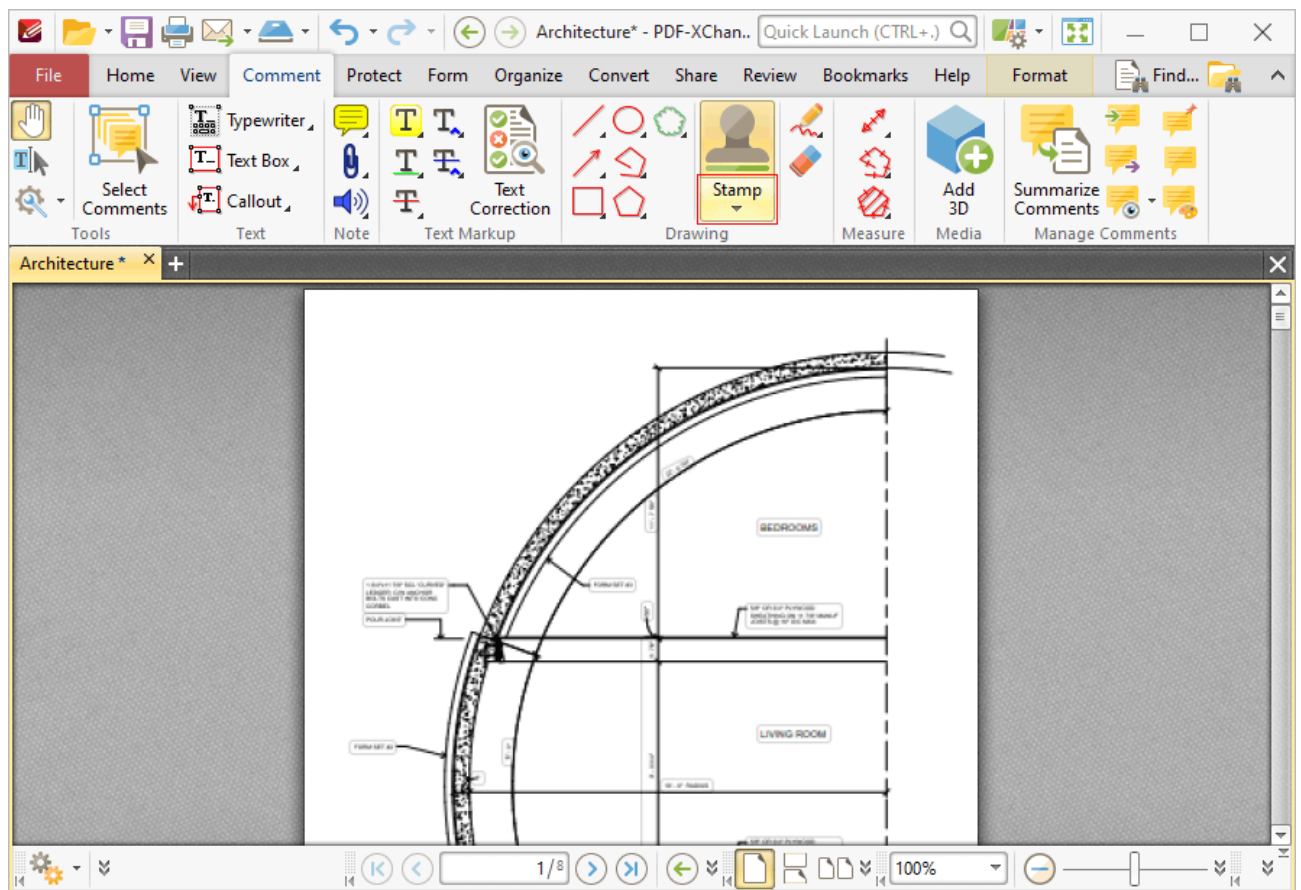

Figure 5. Comment Tab, Stamp Dropdown Menu

The **Stamp Pane** will open:



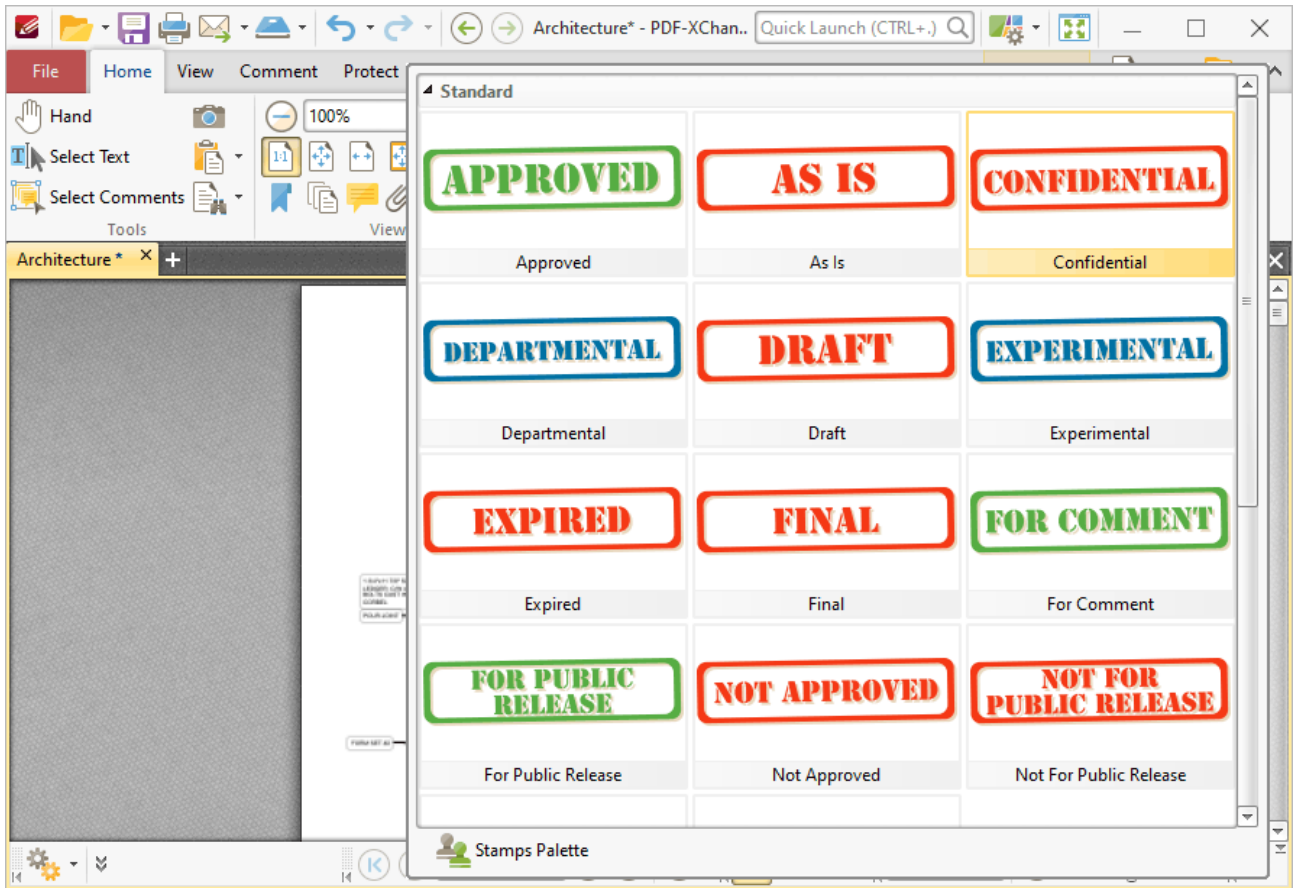

Figure 6. Stamps Pane

- Click to select stamps. They will then be displayed with the pointer. Click again to add stamps to the active document.
- Click **Stamps Palette** to open the **Stamps Palette**, which is a detached version of the **Stamps** pane that contains editing options:

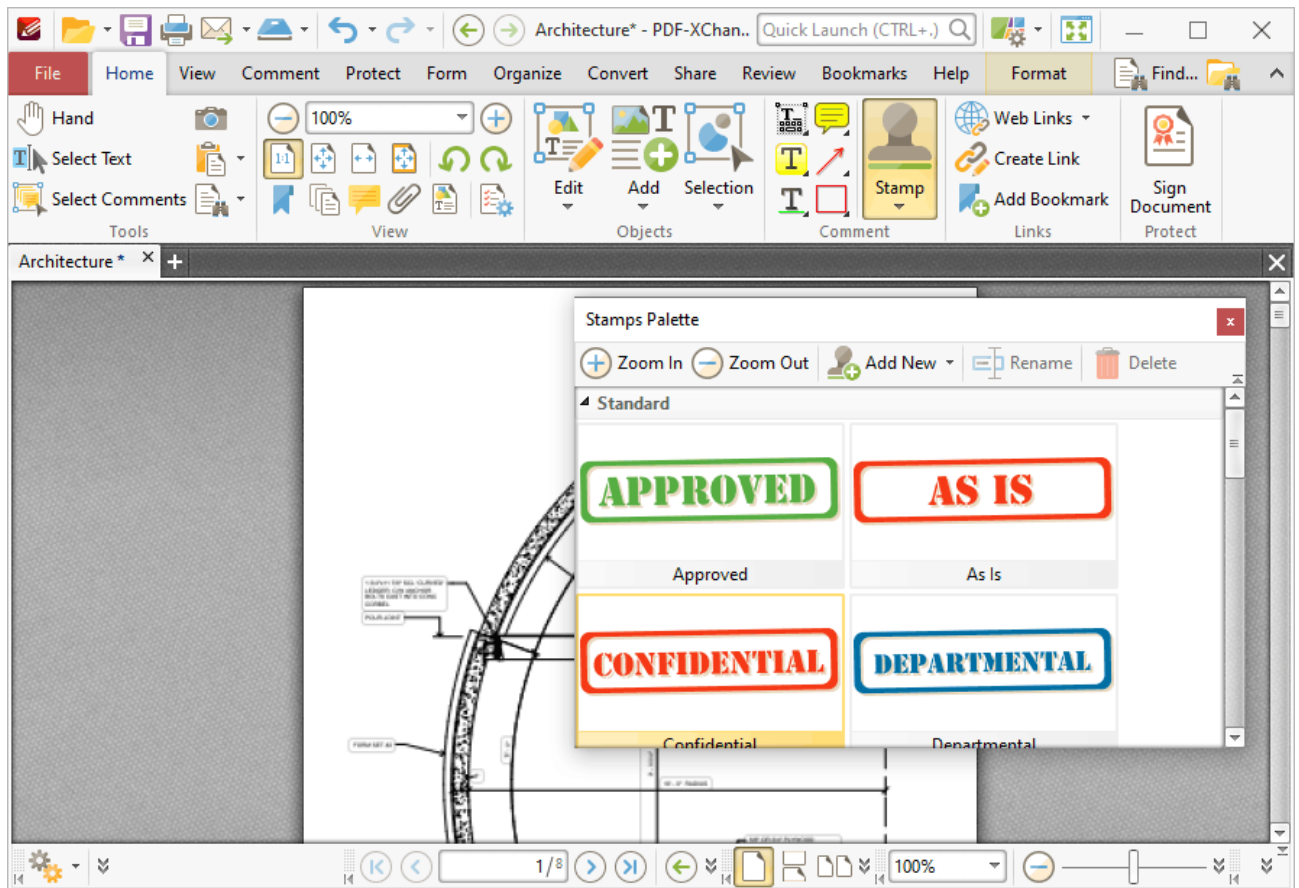

Figure 7. Stamps Palette

- Click the **Zoom In** and **Zoom Out** icons to zoom in on/out from available stamps.
- Click **Add New** for stamp creation options:
  - Click **Add New Stamp from File** to create a stamp from a document saved on the local computer. The **Open Files** dialog box will open. Select a file and click **Open**. The file will be displayed in the **Add New Stamp** dialog box, as detailed in *(figure 8)*.
  - Click **New Stamp from Selection** to create a stamp from selected content in the active document.
  - Click **New Stamp from Active Document** to create a new stamp from the active document.
- Click **New Stamp from Clipboard** to create a new stamp from the current clipboard content.
- Click **Rename/Delete** to rename/delete selected stamps. Note that the default stamps cannot be renamed/deleted.



Figure 8. Add New Stamp Dialog Box

- Use the **Name** text box, or click the folder icon, to select a file to use as the stamp.
- The **Page Range** options determine the pages of the file that will be used for the stamp:
  - Select **All** to use all the pages of the file.

- Select **Current Page** to use only the current page.
- Select **Pages** to specify pages from the file. Page range options are detailed [here](#).  
Note that if more than one page is selected then a new stamp will be created for each page.
- Enter a name in the **Stamp Title** text box. Click the blue icon to include [macros](#) as desired.
- Use the **Target Collection** menu to determine the collection in which the new stamp will be located.
- Click **Add New** to create a new stamp collection.

Click **OK** to create new stamps.

Please note the following:

- Images are usually in raster format and will pixellate with high levels of zoom. Therefore it is advisable to create stamps from presized images. Note that vector-based images do not experience this issue.
- If a transparent background is desired for stamps then a suitable image format must be used. The formats **\*.gif** and **\*.png** support transparency but **\*.jpg** and **\*.pdf** do not. N.b. **Microsoft Paint** does not handle **\*.png** transparency well, but most modern graphics programs are compatible with **\*.png** transparency. **GIMP** is one such program, and a free download of **GIMP** is available [here](#).
- PDF files that contain transparent images/objects without backgrounds (such as scanned signatures) can also be used to create transparent stamps. Empty space on the page will be ignored in these cases.

If **PDF-XChange Editor Plus** has been purchased, then the additional features below are also available:

### Add Dynamic Elements to Stamps

Follow the steps below to add JavaScript to stamps:

1. Move to the **Stamps Palette**.
2. Click **Add New Stamp from File**:

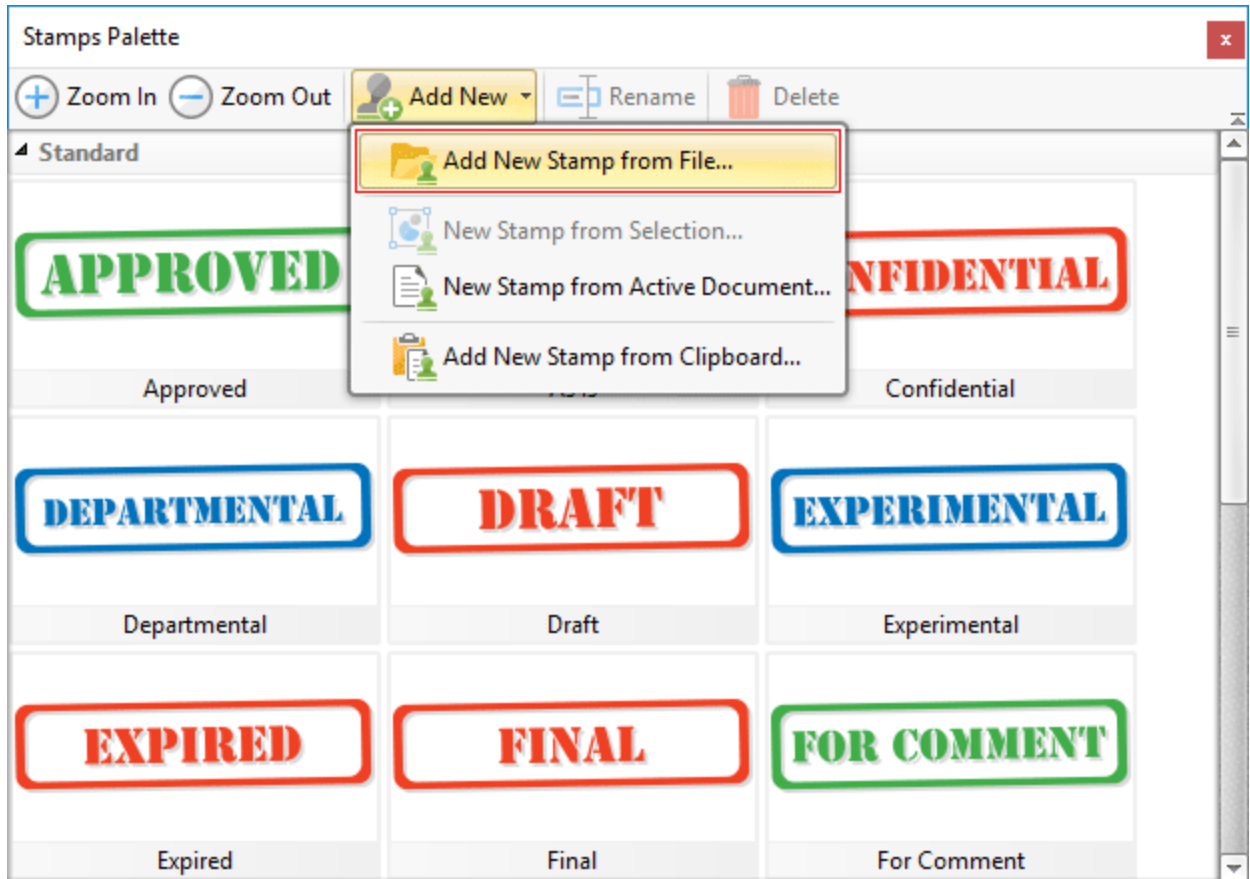

Figure 9. Stamps Palette, Add New Stamp from File

3. Select the desired file, then follow the steps outlined beneath (**figure 8**) to create and save a new stamp.
4. Close **PDF-XChange Editor**.
5. Open the file that contains the stamp. Note that the default folder is **%appdata%\Tracker Software\PDFXEditor\3.0** and all custom stamps are stored in the same file.
6. Move the file to the desktop. (This is a necessary step due to encoding parameters - if it is not included then the changes cannot be saved).
7. Open the file in **PDF-XChange Editor**.
8. Use the **Form** <sup>1265</sup> tab to add a text field to the stamp. (If you want the borders of the text field to be invisible then set the stroke color to **None**. The stroke color property can be edited in the **Properties** <sup>1065</sup> pane when the text field is selected).
9. Click **Select Fields** in the **Form** <sup>1265</sup> tab then right-click the text field and click **Properties** in the submenu. The **Properties** pane will open.

10. Scroll down to the **Value Calculation** property, then select **Custom Action** in the **Calculation** dropdown menu. The entry '**Calculate action / Run a JavaScript**' will appear at the bottom of the **Properties** pane:

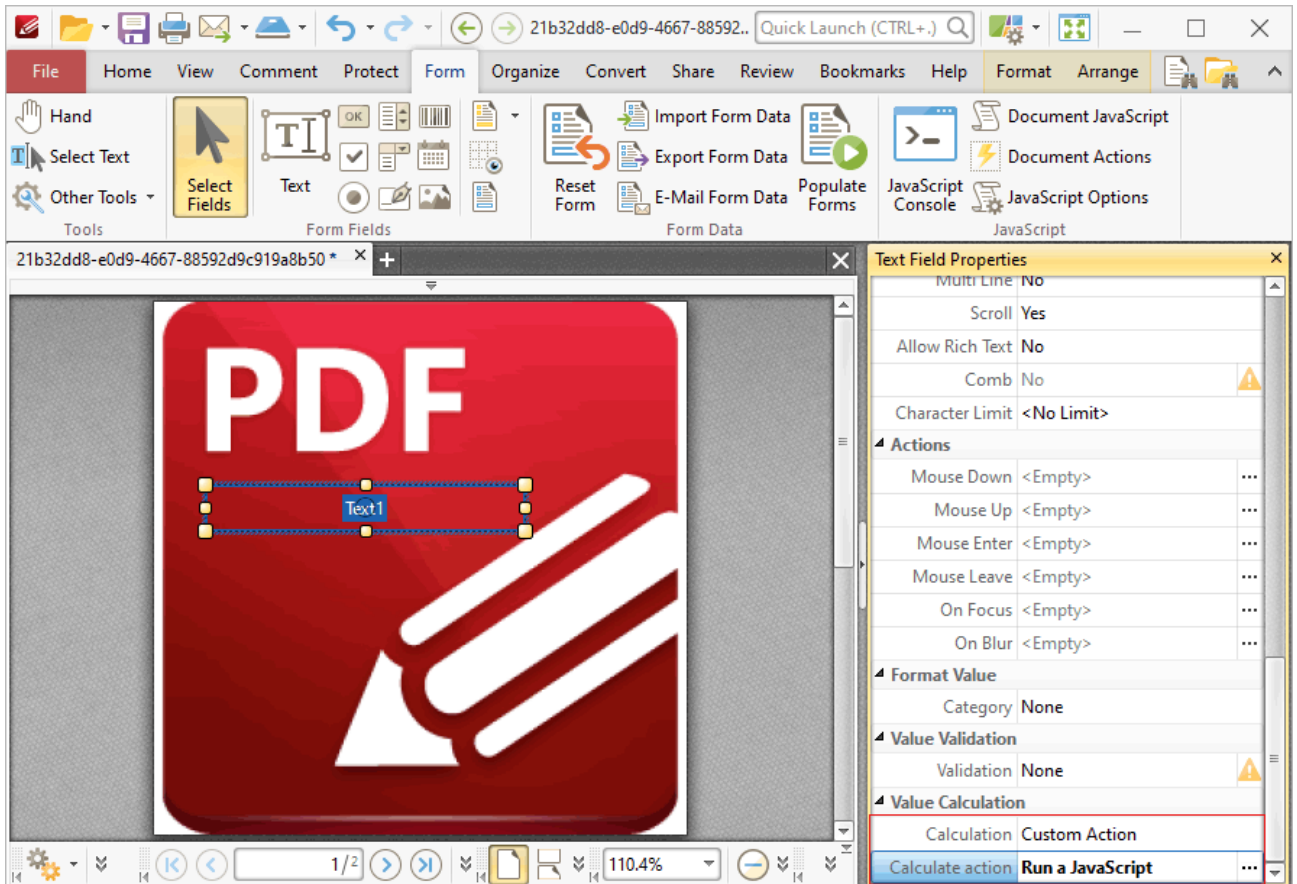

Figure 10. Dynamic Stamp Creation

11. Click the ellipsis icon (three dots) on the right of the '**Calculate action / Run a JavaScript**' property. The **Edit Action: "Run a JavaScript"** dialog box will open.

12. Enter the desired JavaScript and click **OK**.

13. Save the file and close **PDF-XChange Editor**.

14. Return the stamp file to its original destination folder. The updated stamp will then be available in the specified stamp collection.

For example, entering the following JavaScript returns the time and date when the stamp is added to the document:

```
var d = new Date;
```

```
event.value = util.printd("yyyy/mm/dd/ HH:MM:ss", d);
```

Please note that form content is evaluated immediately before stamps are placed and flattened immediately after they are placed. The software will recognize it as a stamp, as opposed to a form field, despite the fact that it includes form field elements. Note that only the text field and barcode form fields are compatible with this process.

## Add Numbering to Stamps

Follow the steps below to add numbering to stamps:

1. Use the steps detailed above to create a dynamic stamp and enter the following JavaScript at step twelve:

```
if (event.source.forReal && (event.source.stampName == "TCS9kAUOm4Abn56QZCOZE3"))
{
    var counter = 0;
    if (typeof event.source.source.info.stampCounter != undefined)
    {
        counter = event.source.source.info.stampCounter;
    }
    counter++;
    event.source.source.info.stampCounter = counter;
    event.value = counter;
}
else
{
    event.value = 1;
}
```

2. Save the file and close **PDF-XChange Editor**.



3. Return the stamp to its destination folder. (It should have been moved to the desktop at step six of the process - see steps for adding dynamic elements to stamps, above).

4. Open **PDF-XChange Editor** and create a new document.

5. Place the stamp in the new document and select it.

6. Press Ctrl+J. The **JavaScript Console** will open. Enter the following JavaScript:

```
this.selectedAnnots[0].AP
```

7. Click **Run** in the **JavaScript Console**.
8. An alphanumeric string will appear in the lower section of the **JavaScript Console**. Copy this string to the clipboard.
9. Close **PDF-XChange Editor**.
10. Move the stamp from its destination folder to the desktop.
11. Open **PDF-XChange Editor** and open the stamp.
12. Click **Select Fields** in the **Form**  tab, then select the text field of the stamp.
13. Press Ctrl+' to open the **Properties**  pane.
14. Under the **Value Calculation** property, use the menu to select **Custom Action**. The entry **Calculate action / Run a JavaScript** will appear at the bottom of the **Properties** pane.
15. Click the ellipsis icon on the right of the **Calculate action / Run a JavaScript** property. The **Edit Action: "Run a JavaScript"** dialog box will open.
16. Replace the alphanumeric string on line one of the **JavaScript Console** with the alphanumeric string in the clipboard.
17. Save the file and close **PDF-XChange Editor**.
18. Move the file from the desktop to its original folder. The stamp will then feature incremental numbering when it is placed into documents.

A complete list of JavaScript-supported actions is available [here](#).

---



## 10.4.4.22 Pencil Tool

**Pencil Tool**

Click the **Pencil Tool** to add pencil annotations to documents:

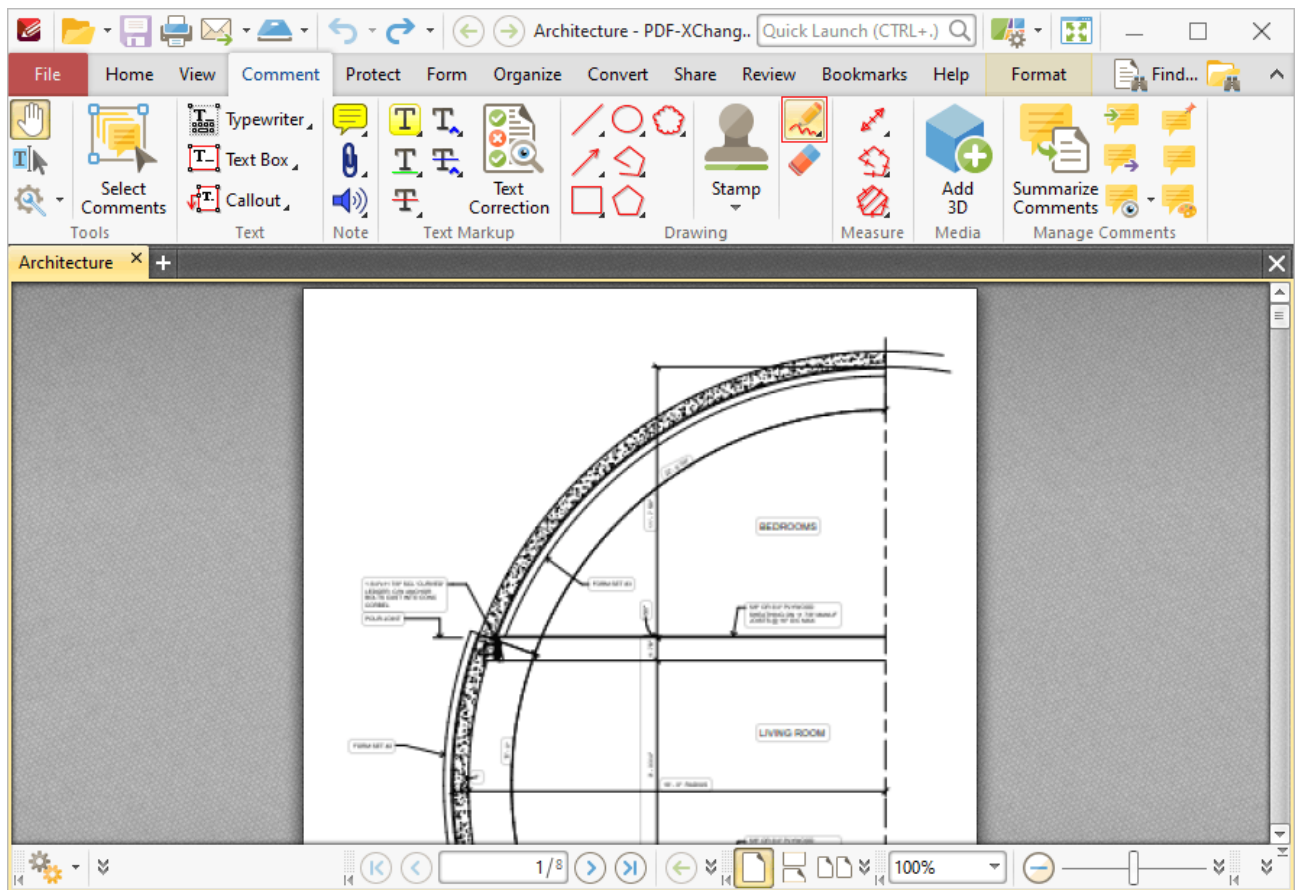

Figure 1. Comment Tab, Pencil Tool

When the **Pencil Tool** is enabled, click and drag the pointer to create pencil annotations:

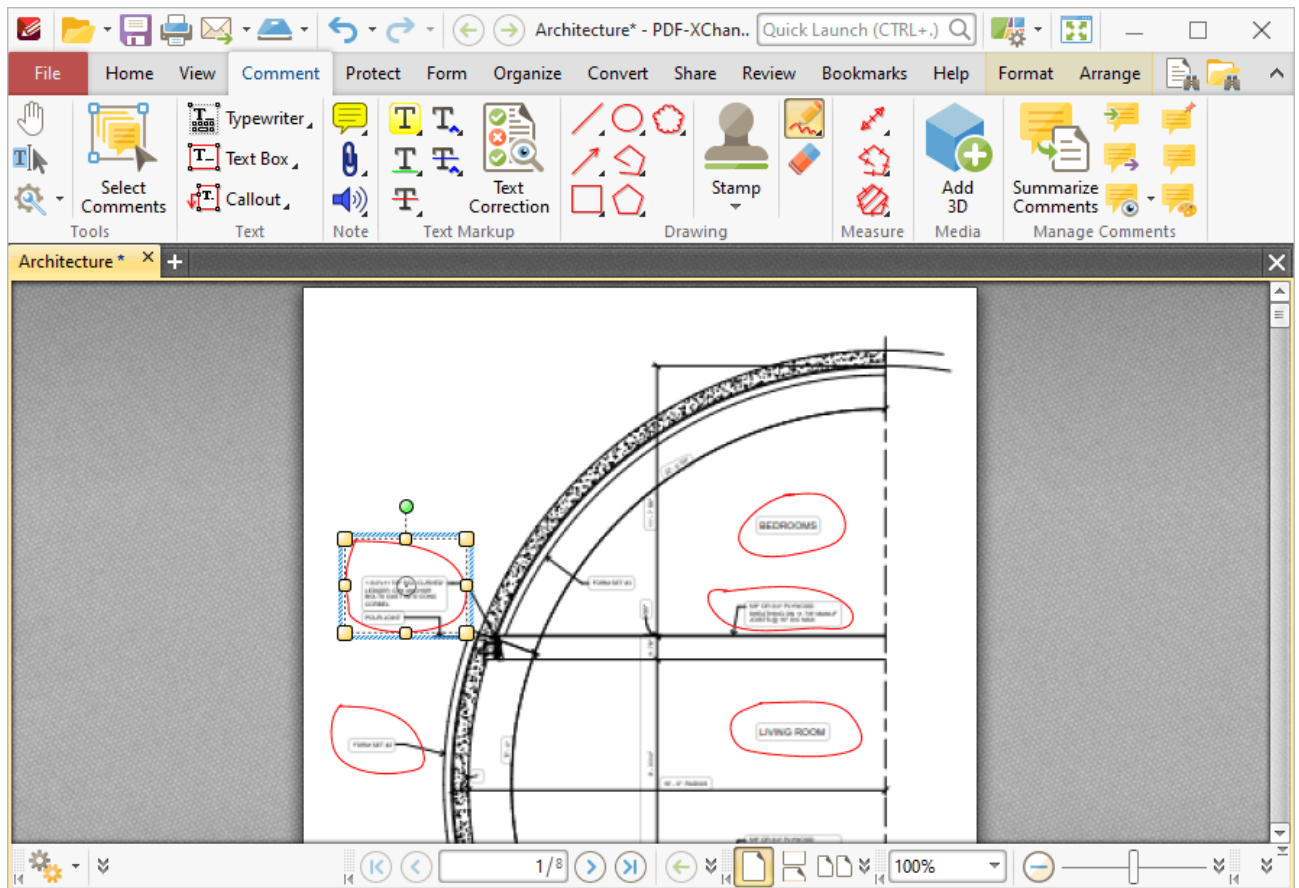

Figure 2. Pencil Tool Examples

Click to select pencil annotations, as detailed in the upper-left annotation in the image above. Selected annotations can be edited as follows:

- Click and drag the yellow control points to resize pencil annotations.
- Click and drag pencil annotations to reposition them.
- Click and drag the green control point to rotate pencil annotations. Hold down Shift to rotate at increments of fifteen degrees.
- Use the arrow keys to reposition pencil annotations. Hold down Shift to move at an increased increment.
- Use the editing aids detailed [here](#)<sup>1075</sup> to assist in the precise placement of pencil annotations.
- Right-click pencil annotations for further options. See [here](#)<sup>1783</sup> for an explanation of these options.
- Press Ctrl+' to open the **Properties** pane for selected annotations and view/edit properties:

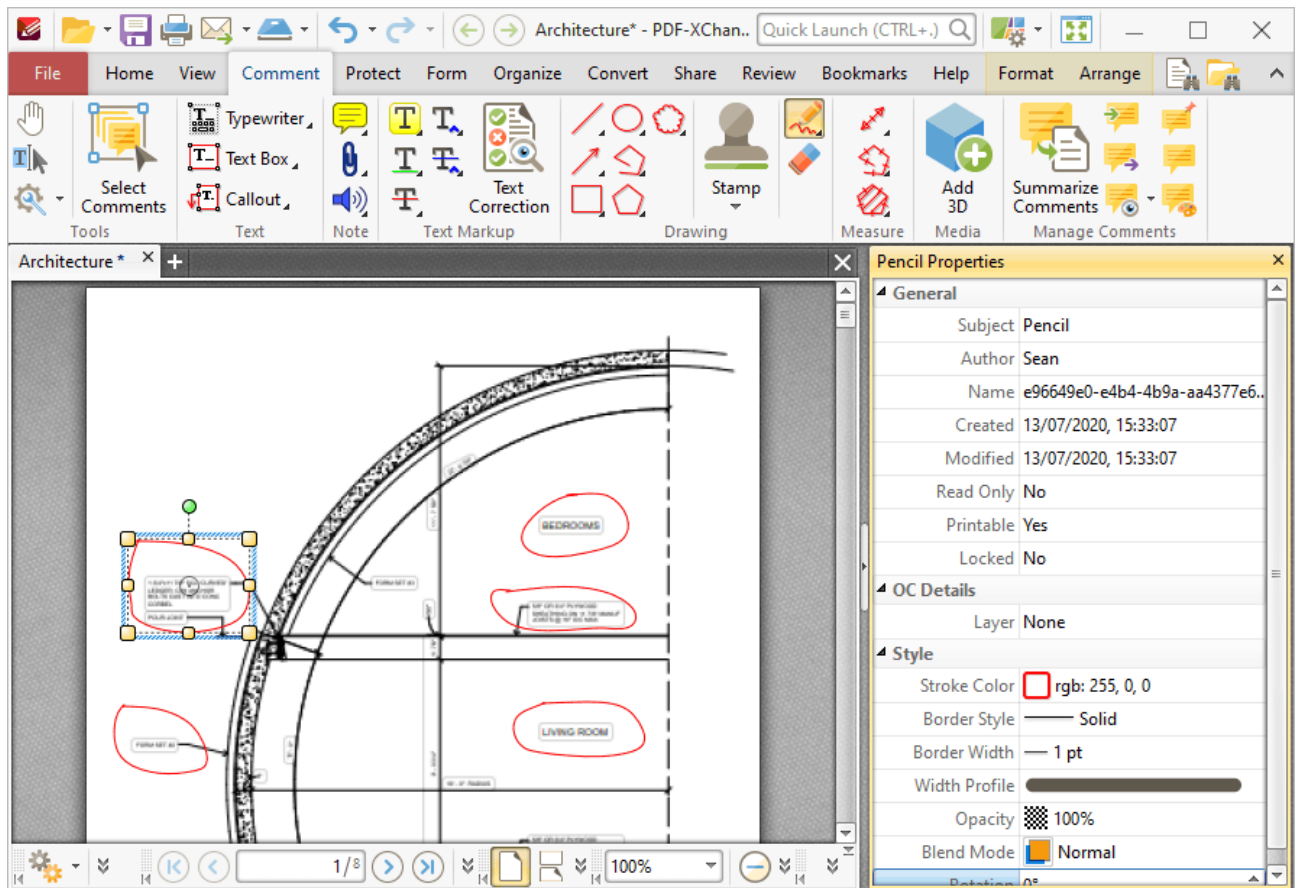

Figure 3. Pencil Tool, Pencil Properties Pane

- **Subject** is the name of the pencil annotation, as referenced in the [Comments](#)<sup>1007</sup> pane.
- **Author** is the name of the user that created the pencil annotation.
- **Name** is the unique name of the pencil annotation, as referenced within the application.
- **Created** is the date and time at which the pencil annotation was created.
- **Modified** is the date and time at which the pencil annotation was last modified.
- **Read Only** is the read only status of the pencil annotation. If this property is enabled then users cannot interact with the annotation. Please note that it is necessary to use JavaScript to change the value of this property.
- **Printable** is the print status of the pencil annotation. If this property is enabled then the annotation is printed with the document. If this property is not enabled then the annotation is not printed.
- **Locked** is the locked status of the pencil annotation. If this property is enabled then the annotation cannot be deleted and its properties (including its position and size) cannot be modified by users.
- **Layer** specifies the optional content layer to which the pencil annotation belongs. Further information about layers is available [here](#).<sup>1024</sup>
- **Stroke Color** determines the color of the pencil annotation.
- **Border Style** determines the style of the annotation.
- **Border Width** determines the width of the annotation.

- **Width Profile** determines the profile used for the annotation.
- **Opacity** determines the level of transparency in the pencil annotation.
- **Blend Mode** determines how pencil annotations blend with overlapping content. These options are explained [here](#).
- **Rotation** determines the degrees of rotation of the pencil annotation.

Note that when the **Pencil Tool** is enabled, the **Format** tab is available and can be used to customize the default properties of pencil annotations:

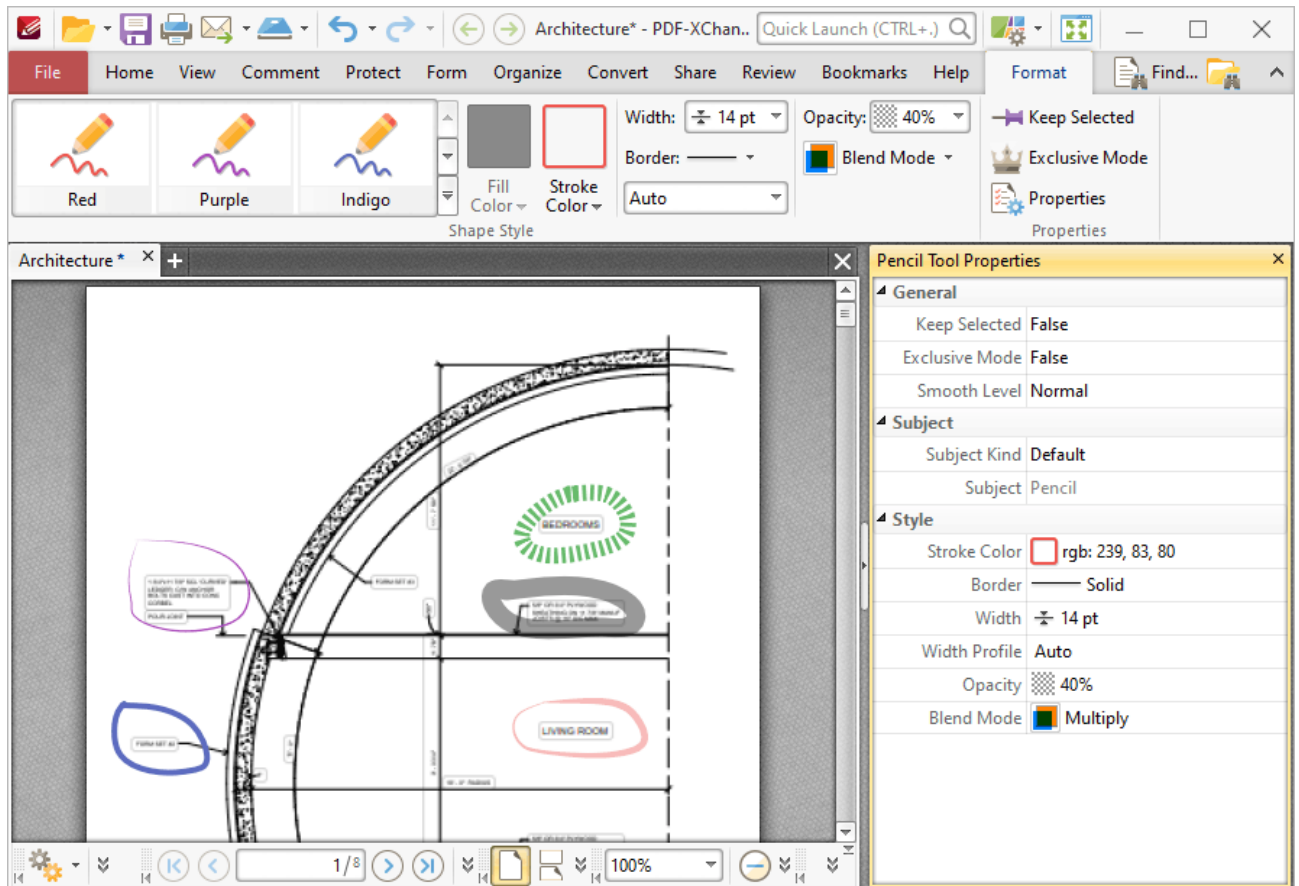

Figure 4. Format Tab, Pencil Tool

- Click options in the **Shape Style** group to select alternative default pencil annotation styles.
- Click **Keep Selected** to keep the **Pencil Tool** enabled and add multiple pencil annotations to the document. If this option is not enabled then **PDF-XChange Editor** will revert to the designated default tool immediately after creating one pencil annotation.
- Click **Exclusive Mode** to enable exclusive mode, which simplifies the process of using the **Pencil Tool**. When **Exclusive Mode** is enabled, the pointer ignores all interactive elements of documents other than base content. This makes it possible to create pencil annotations on areas that overlap with other content without the risk of accidentally selecting undesired items. When **Exclusive Mode** is disabled, the pointer recognizes and interacts with all underlying elements in the usual manner.

- Click **Properties** to open the **Properties** pane and view/edit **Pencil Tool** properties, as detailed above.
- When pencil annotations are selected, the **Style Tools** dropdown menu is available in the **Format** tab. It contains the following options:
  - Click **Copy Comment Style** to copy the style properties of pencil annotations.
  - Click **Apply Copied Comment Style** to apply a copied pencil annotation style to selected annotations.
  - Click **Apply Copied Comment Appearance** to apply a copied pencil annotation style to selected annotations.
  - Click **Make Current Properties Default** to set the properties of the pencil annotation as the default properties for subsequent annotations.
  - Click **Apply Default Properties** to apply the default pencil annotation properties to selected pencil annotations.
- When pencil annotations are selected, the **Pop-up** group is available in the **Format** tab and can be used to interact with the pop-up note of the annotation:
  - Click **Open** to open the pop-up note.
  - Click **Hide** to hide the pop-up note.
  - Click **Reset Location** to reset the location of the pop-up note.
- When pencil annotations are selected, the **Arrange** tab is also available and can be used to manipulate comments as detailed [here](#).

Note that the [Comment Styles Palette](#) can be used to edit and save customized annotation styles for subsequent use, and the [Commenting](#) preferences can be used to view/edit preferences for all comments.

## Eraser Tool

The **Eraser Tool** is used to erase pencil annotations. When it is enabled the pointer becomes a white circle. Click and drag to erase pencil annotations. Click the **Format** tab to customize the **Eraser Tool**:

- **Diameter** determines the diameter of the eraser.
  - **Keep Selected** determines whether or not the **Eraser Tool** remains selected after a single use. If this option is enabled then the tool will remain selected and can be used several times consecutively. If this option is not enabled then **PDF-XChange Editor** will revert to the designated default tool immediately after a single use of the **Eraser Tool**.
-

## 10.4.4.23 Measuring Tools



## Measuring Tools

Click the **Measuring Tools** to measure distances, perimeters and areas in documents:

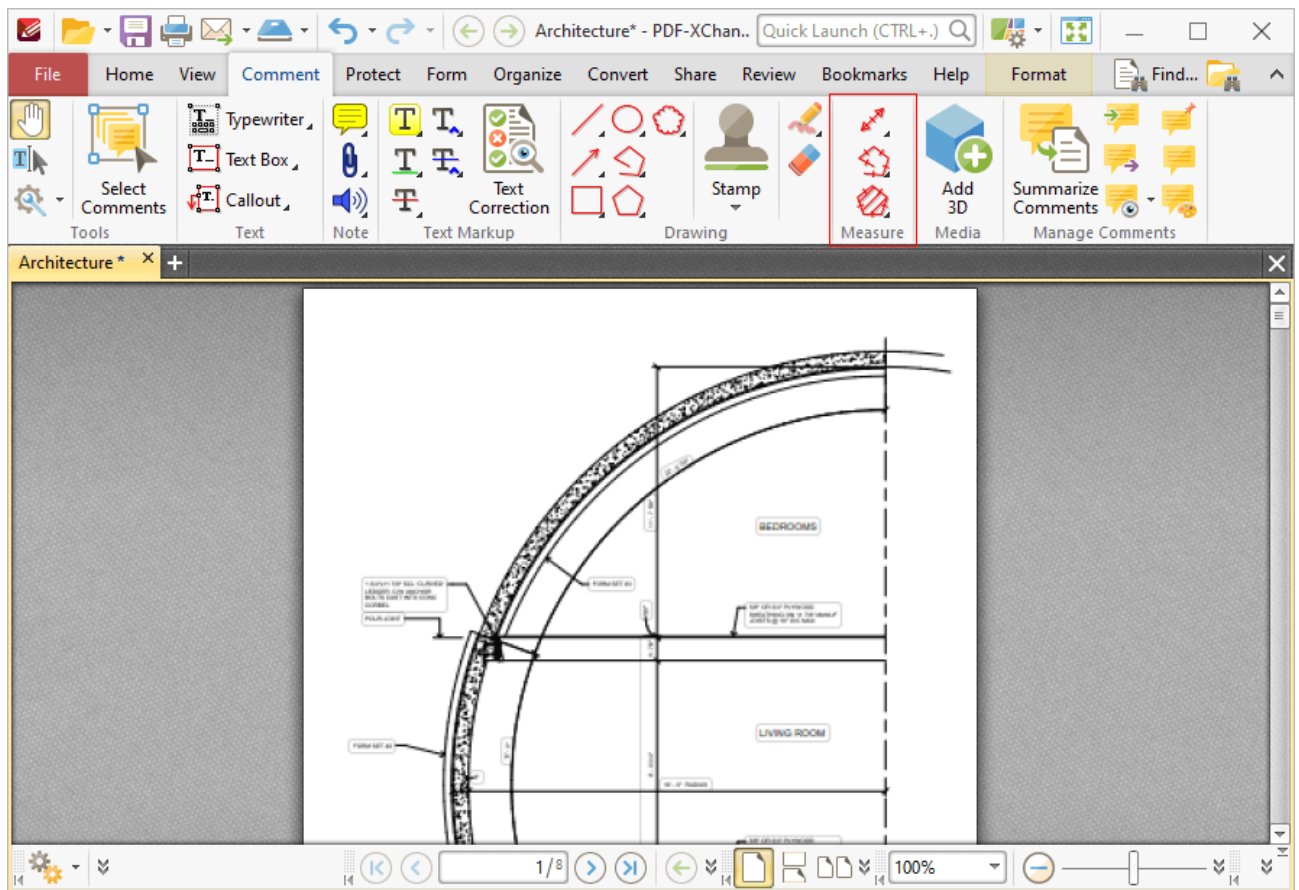

Figure 1. Comment Tab, Measuring Tools

The measuring tools are used to measure specific document dimensions:

- The [Distance Tool](#)<sup>1208</sup> is used to measure the distance between two points.
- The [Perimeter Tool](#)<sup>1214</sup> is used to measure the distance between multiple points.
- The [Area Tool](#)<sup>1219</sup> is used to measure the area within designated borders.



## 10.4.4.23.1 Distance Tool

**Distance Tool**

Click **Distance Tool** to measure the distance between two points:

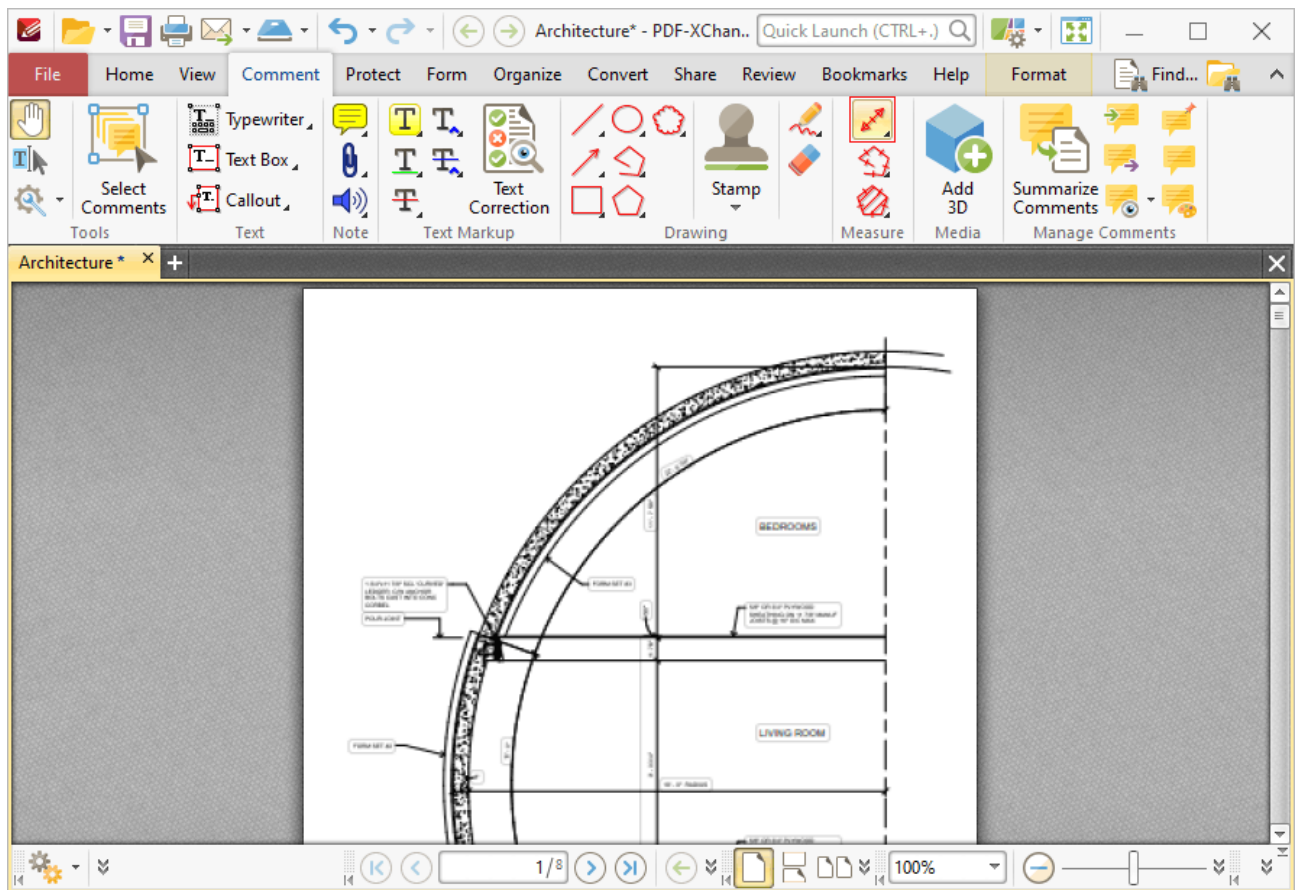

**Figure 1.** Comment Tab, Distance Tool

When the **Distance Tool** is selected the pointer becomes a crosshairs icon. Click to start a measurement line. A red arrow will appear and the **Distance Tool** information box will be displayed in the lower right corner of the active window. Drag the crosshairs to the desired point, then click to determine the distance measured. The baseline is then established. The distance from the start point will be displayed as the pointer is moved, and further details will be displayed in the information box. Click again to set the baseline as the final measured distance. Alternatively, move the pointer up/down to reposition the



baseline at a parallel position within the document and create perpendicular leader lines at either end. Click to complete the process:

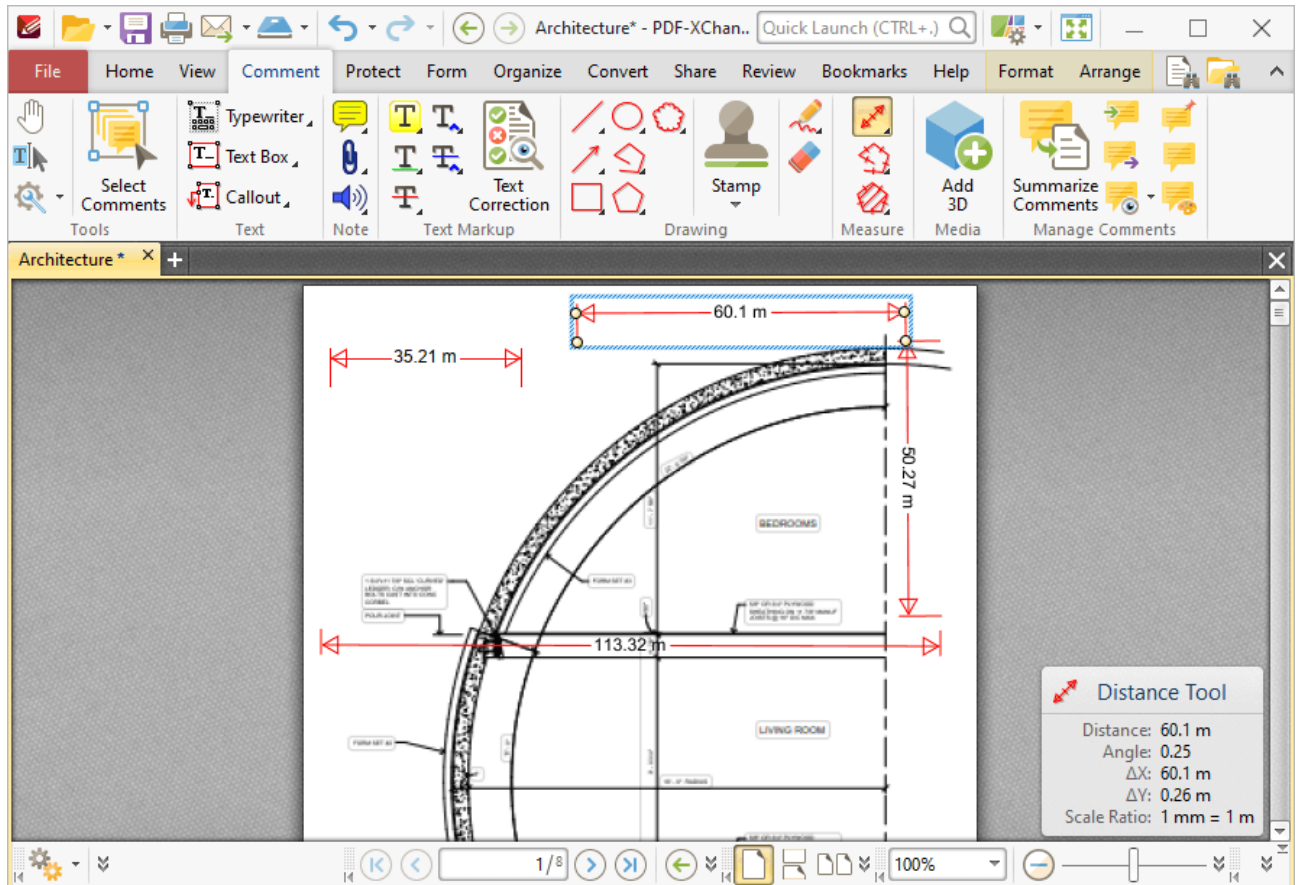

Figure 2. Distance Tool Examples

- The **Distance Tool** calculates and displays distances measured according to the active scale, which can be determined in the **Format** tab, as detailed below.
- Right-click lines and select **Open Pop-Up Note** to customize the appearance of the scale reference figure.
- Click and drag the control points at either end of the baseline to adjust the length of the adjoining perpendicular lines.
- Click and drag the second pair of control points to adjust the length of the baseline and the angle of the annotation.
- Click and drag to reposition lines.
- Use the arrow keys to reposition lines. Hold down Shift to move at an increased increment.
- Use the editing aids detailed [here](#)<sup>1075</sup> to assist in the precise placement of lines.
- Hold down Shift to create lines at increments of fifteen degrees.
- Right-click lines for further editing options. See [here](#)<sup>1783</sup> for an explanation of these options.
- Press Ctrl+' to open the **Properties** pane for selected lines and view/edit properties:

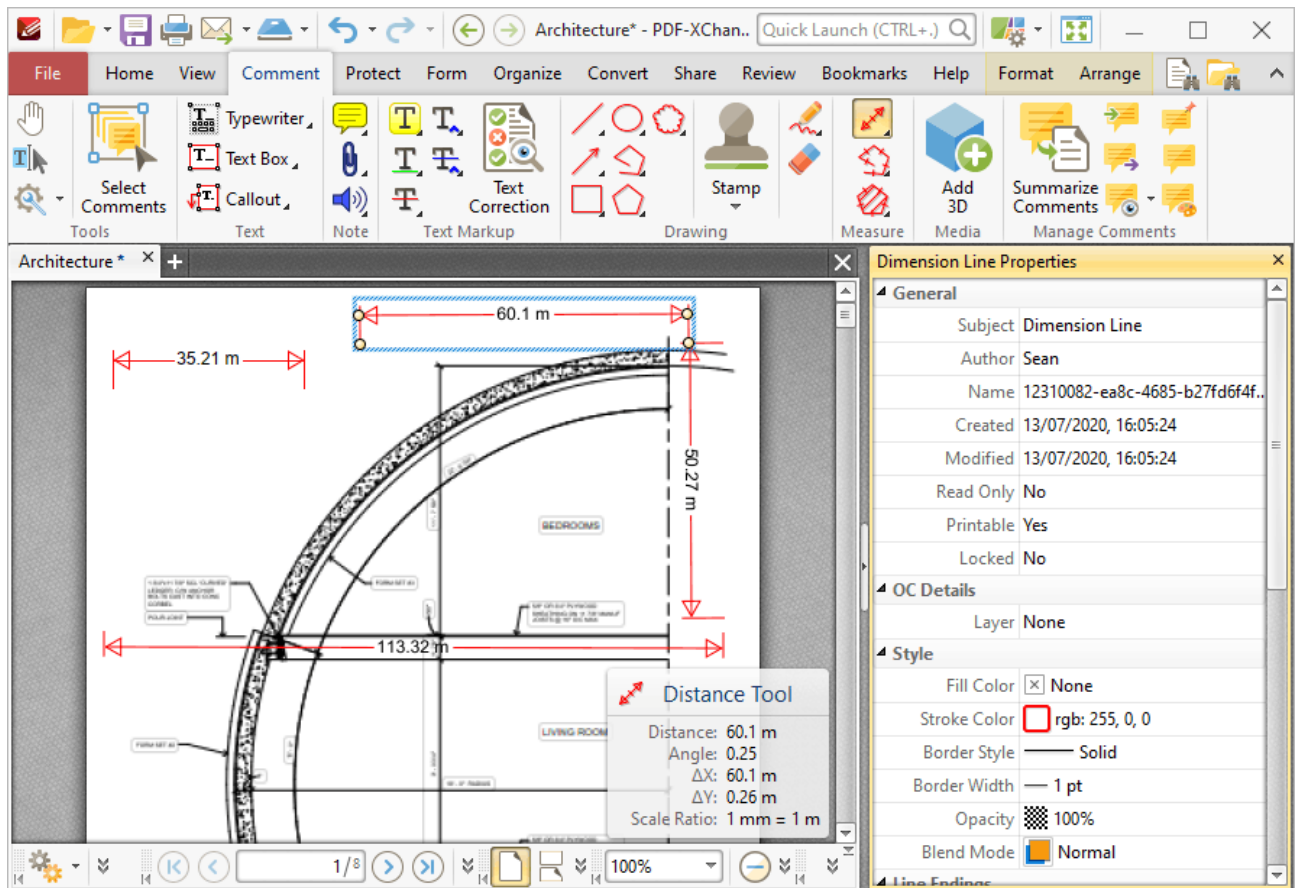

Figure 3. Distance Tool, Distance Line Properties Pane

- **Subject** is the name of the distance annotation, as referenced in the [Comments](#) <sup>1007</sup> pane.
- **Author** is the name of the user that created the distance annotation.
- **Name** is the unique name of the distance annotation, as referenced within the application.
- **Created** is the date and time at which the distance annotation was created.
- **Modified** is the date and time at which the distance annotation was last modified.
- **Read Only** is the read only status of the distance annotation. If this property is enabled then users cannot interact with the annotation. Please note that it is necessary to use JavaScript to change the value of this property.
- **Printable** is the print status of the distance annotation. If this property is enabled then the annotation is printed with the document. If this property is not enabled then the annotation is not printed.
- **Locked** is the locked status of the distance annotation. If this property is enabled then the annotation cannot be deleted and its properties (including its position and size) cannot be modified by users.
- **Layer** specifies the optional content layer to which the distance annotation belongs. Further information about layers is available [here](#). <sup>1024</sup>
- **Fill Color** determines the color of the line ending style used at the start of the distance annotation. The line ending property is detailed below.
- **Stroke Color** determines the color of the distance annotation.

- **Border Style** determines the style of the annotation.
- **Border Width** determines the width of the annotation.
- **Opacity** determines the level of transparency in the distance annotation.
- **Blend Mode** determines how distance annotations blend with overlapping content. These options are explained [here](#).<sup>1659</sup>
- **Start** determines the line ending style used at the start of the distance annotation.
- **End** determines the line ending style used at the end of the distance annotation.
- **Start Scale** determines the size of the line ending used at the start of the distance annotation.
- **End Scale** determines the size of the line ending used at the end of the distance annotation.
- **Leader Length** determines the length of the leader lines used for the distance annotation. Leader lines extend from each endpoint of the distance annotation, perpendicular to the annotation itself.
- **Leader Extension** determines the length of leader line extensions that extend from the distance annotation.
- **Leader Offset** determines the length of the leader line offset, which is the amount of empty space between the endpoints of the distance annotation and the beginning of the leader lines.
- **Show Caption** determines whether or not the text contained in the pop-up note of the annotation is displayed.
- **Inline Caption** determines whether or not the caption is an inline caption. If this option is enabled then captions are placed inside the distance annotation instead of on top of the distance annotation.
- **Length** determines the length of the distance annotation.
- **Scale** determines the scale used for the distance annotation. Further information about scales is available [here](#).<sup>1224</sup>
- **Precision** determines the precision with which scale conversions are displayed.
- **Decimal** determines the symbol used as the decimal separator.
- **Group** determines the symbol used as the group separator.

Note that when the **Distance Tool** is enabled, the **Format** tab is available and can be used to customize the default properties of distance annotations:

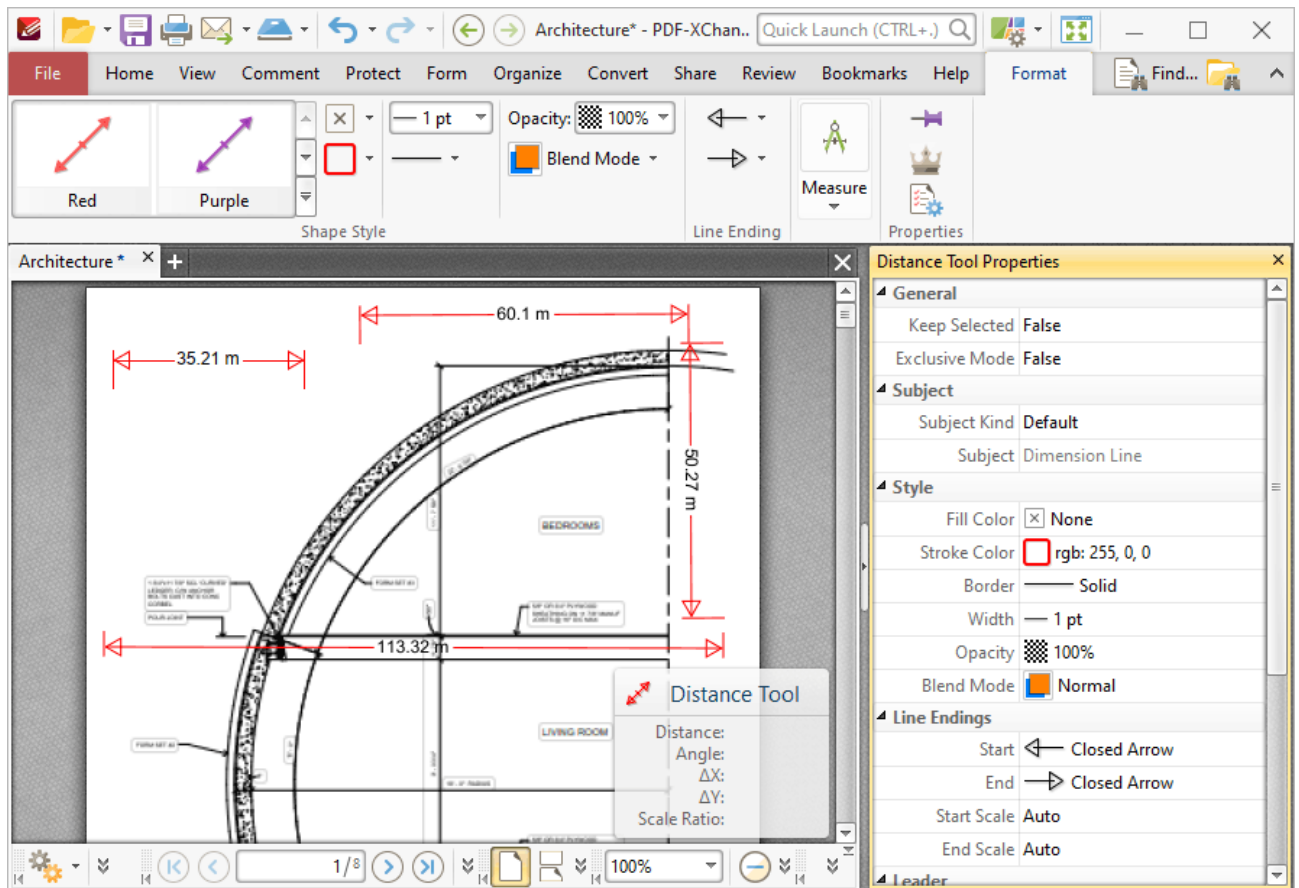

Figure 4. Format Tab, Distance Tool

- Click options in the **Shape Style** group to select alternative default distance annotation styles.
- Click **Keep Selected** to keep the **Distance Tool** selected and create multiple lines consecutively. If this option is disabled then **PDF-XChange Editor** will revert to the designated default tool after the creation of one line.
- Click **Exclusive Mode** to give the **Distance Tool** priority over all other document content. When **Exclusive Mode** is enabled, the pointer ignores all interactive elements of documents other than base content. This makes it possible to create lines on areas that overlap with other content without the risk of accidentally selecting undesired items. When **Exclusive Mode** is disabled, the pointer recognizes and interacts with all content as normal.
- Click **Properties** to view/edit the **Distance Tool** properties, as detailed above.
- Click **Export to CSV** to export a summary of document comments to a comma-separated-values document.
- Click **Edit Label** to create/edit the text label of the annotation, or click **Delete Label** to delete the label. Note that labels are displayed when the pointer is hovered over the annotation.
- When distance annotations are selected, the **Style Tools** dropdown menu is available in the **Format** tab. It contains the following options:
  - Click **Copy Comment Style** to copy the style properties of distance annotations.
  - Click **Apply Copied Comment Style** to apply a copied distance annotation style to selected annotations.

- Click **Apply Copied Comment Appearance** to apply a copied line annotation style to selected annotations.
- Click **Make Current Properties Default** to set the properties of the distance annotation as the default properties for subsequent annotations.
- Click **Apply Default Properties** to apply the default distance annotation properties to selected distance annotations.
- When distance annotations are selected, the **Pop-up** group is available in the **Format** tab and can be used to interact with the pop-up note of the annotation:
  - Click **Open** to open the pop-up note.
  - Click **Hide** to hide the pop-up note.
  - Click **Reset Location** to reset the location of the pop-up note.
- When distance annotations are selected, the **Arrange** tab is also available and can be used to manipulate comments as detailed [here](#).

Note that the [Comment Styles Palette](#) can be used to edit and save customized distance annotation styles for subsequent use, and the [Commenting](#) preferences can be used to view/edit preferences for all comments.

---

## 10.4.4.23.2 Perimeter Tool

**Perimeter Tool**

Click **Perimeter Tool** to measure the distance between multiple points:

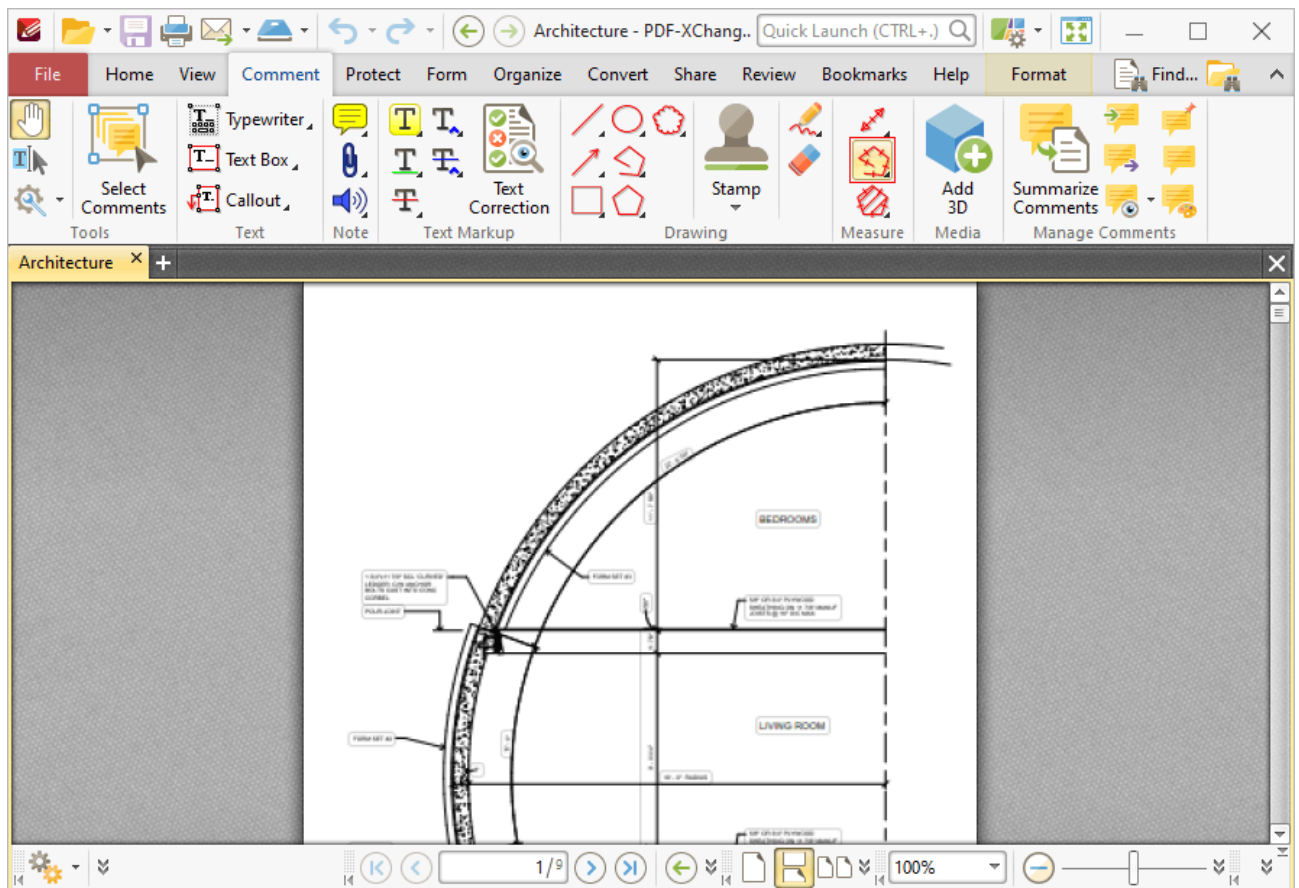

**Figure 1.** Comment Tab, Perimeter Tool

When the **Perimeter Tool** is selected the pointer becomes a crosshairs icon. Click to start a perimeter line. A red line will appear and the **Perimeter Tool** information box will be displayed in the lower right corner of the active window. This box will update as the tool is used. Drag the crosshairs to the desired location and click again to define the first line of the perimeter. Repeat the process until the perimeter is complete and then double-click to set the final point:

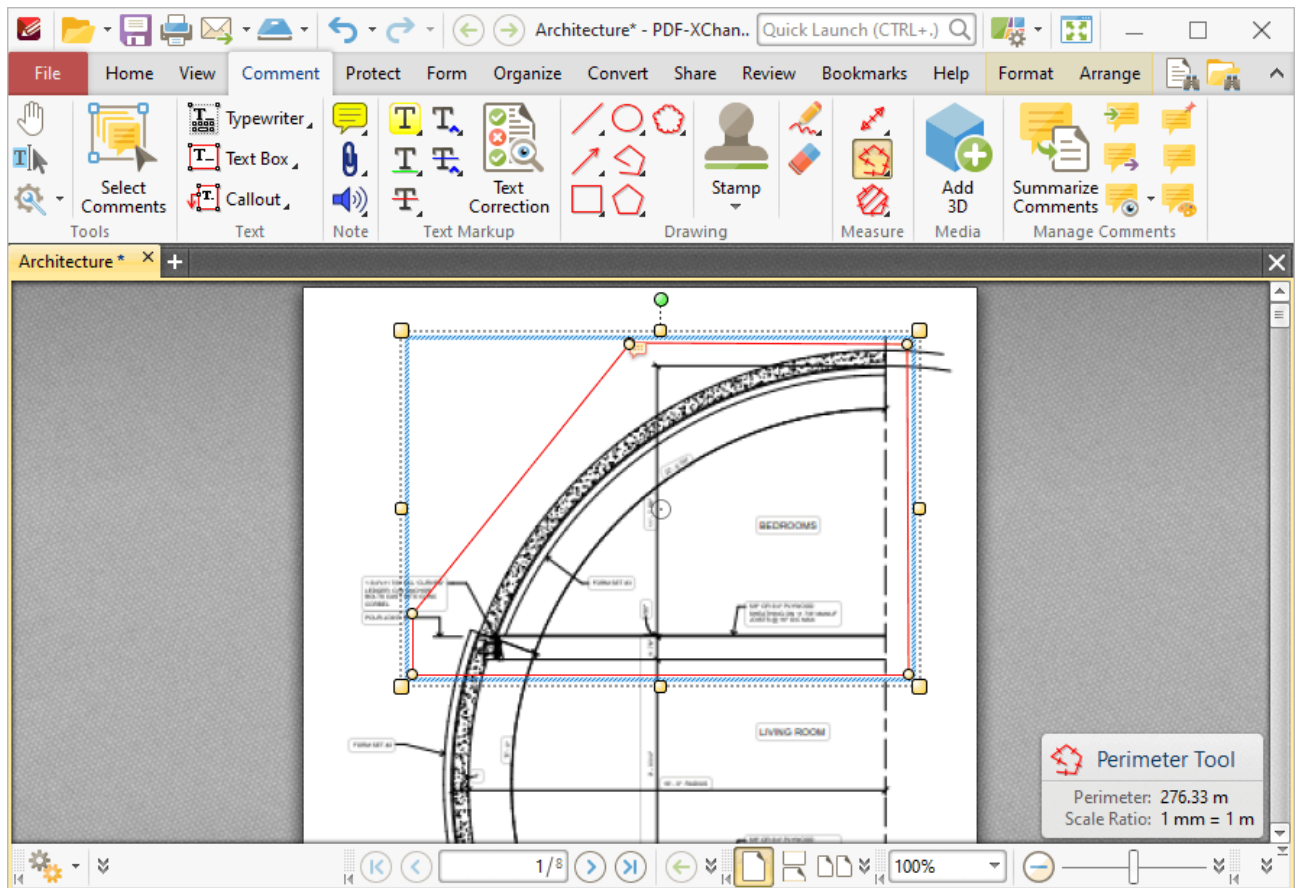

Figure 2. Perimeter Tool Example

- The **Perimeter Tool** calculates and displays distances measured according to the active scale, which can be determined in the **Format** tab, as detailed below.
- Click and drag the perimeter line to reposition it. The circle at the center can also be used for this purpose.
- Click and drag the outer control points to resize the perimeter line.
- Click and drag the inner control points to reshape the perimeter line.
- Click and drag the green control point at the top to rotate the perimeter line. Hold down Shift to rotate at increments of fifteen degrees.
- Use the arrow keys to reposition perimeter lines. Hold down Shift to move at an increased increment.
- Use the editing aids detailed [here](#)<sup>1075</sup> to assist in the precise placement of perimeter lines.
- Hold down Shift to create perimeter lines at increments of fifteen degrees.
- Right-click perimeter lines for further options. See [here](#)<sup>1783</sup> for an explanation of these options.
- Press Ctrl+' to open the **Properties** pane for selected perimeter lines and view/edit properties:

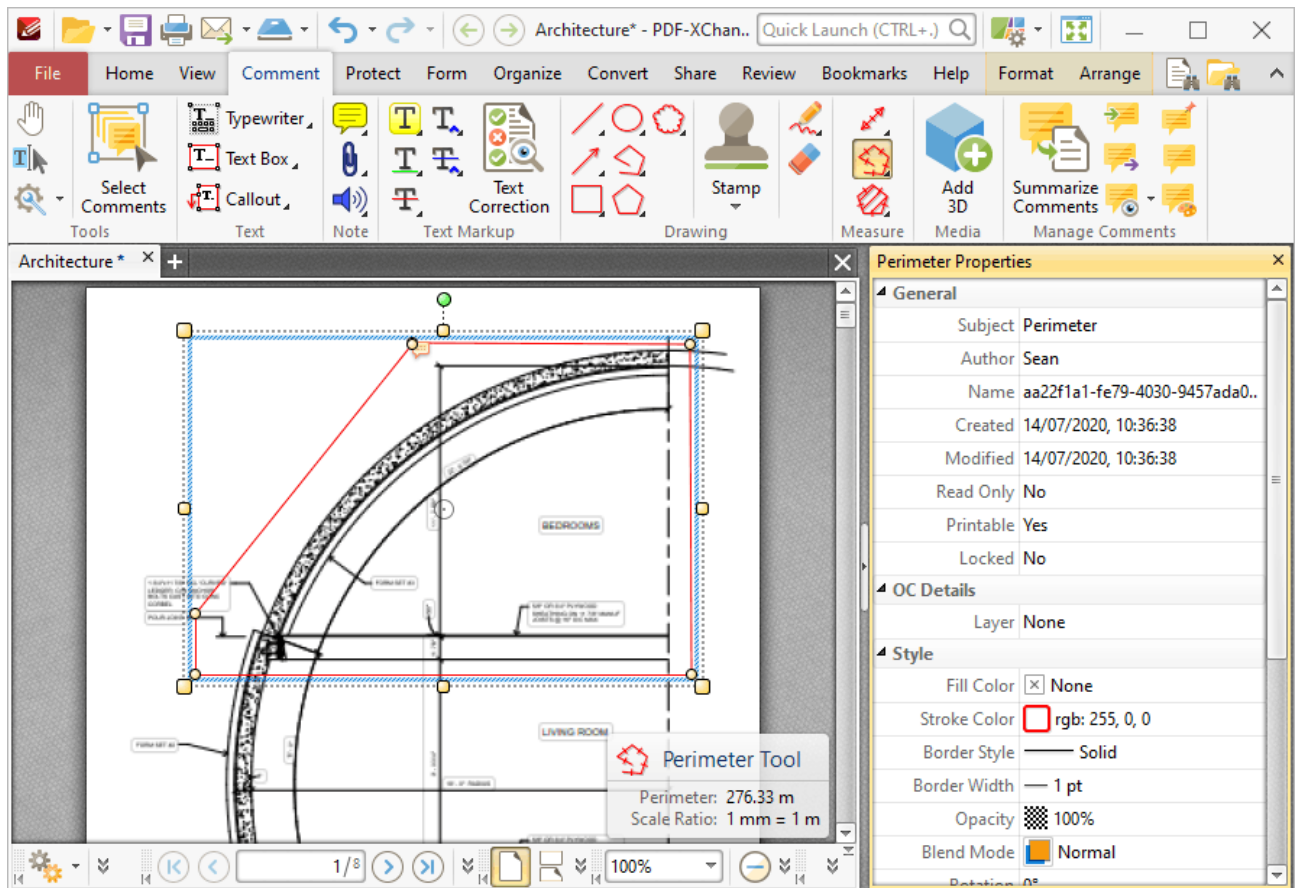

Figure 3. Perimeter Tool, Perimeter Properties Pane

- **Subject** is the name of the perimeter annotation, as referenced in the [Comments](#) pane.
- **Author** is the name of the user that created the perimeter annotation.
- **Name** is the unique name of the perimeter annotation, as referenced within the application.
- **Created** is the date and time at which the perimeter annotation was created.
- **Modified** is the date and time at which the perimeter annotation was last modified.
- **Read Only** is the read only status of the perimeter annotation. If this property is enabled then users cannot interact with the annotation. Please note that it is necessary to use JavaScript to change the value of this property.
- **Printable** is the print status of the perimeter annotation. If this property is enabled then the annotation is printed with the document. If this property is not enabled then the annotation is not printed.
- **Locked** is the locked status of the perimeter annotation. If this property is enabled then the annotation cannot be deleted and its properties (including its position and size) cannot be modified by users.
- **Layer** specifies the optional content layer to which the perimeter annotation belongs. Further information about layers is available [here](#).
- **Fill Color** determines the color of the line ending style used at the start of the perimeter annotation. The line ending property is detailed below.
- **Stroke Color** determines the color of the perimeter annotation.



- **Border Style** determines the style of the annotation.
- **Border Width** determines the width of the annotation.
- **Opacity** determines the level of transparency in the perimeter annotation.
- **Blend Mode** determines how perimeter annotations blend with overlapping content. These options are explained [here](#).<sup>1659</sup>
- **Rotation** determines the degrees of rotation of the perimeter annotation.
- **Start** determines the line ending style used at the start of the perimeter annotation.
- **End** determines the line ending style used at the end of the perimeter annotation.
- **Start Scale** determines the size of the line ending used at the start of the perimeter annotation.
- **End Scale** determines the size of the line ending used at the end of the perimeter annotation.
- **Scale** determines the scale used for the perimeter annotation. Further information about scales is available [here](#).<sup>1224</sup>
- **Precision** determines the precision with which scale conversions are displayed.
- **Decimal** determines the symbol used as the decimal separator.
- **Group** determines the symbol used as the group separator.

Note that when the **Perimeter Tool** is enabled, the **Format** tab is available and can be used to customize the default properties of perimeter annotations:

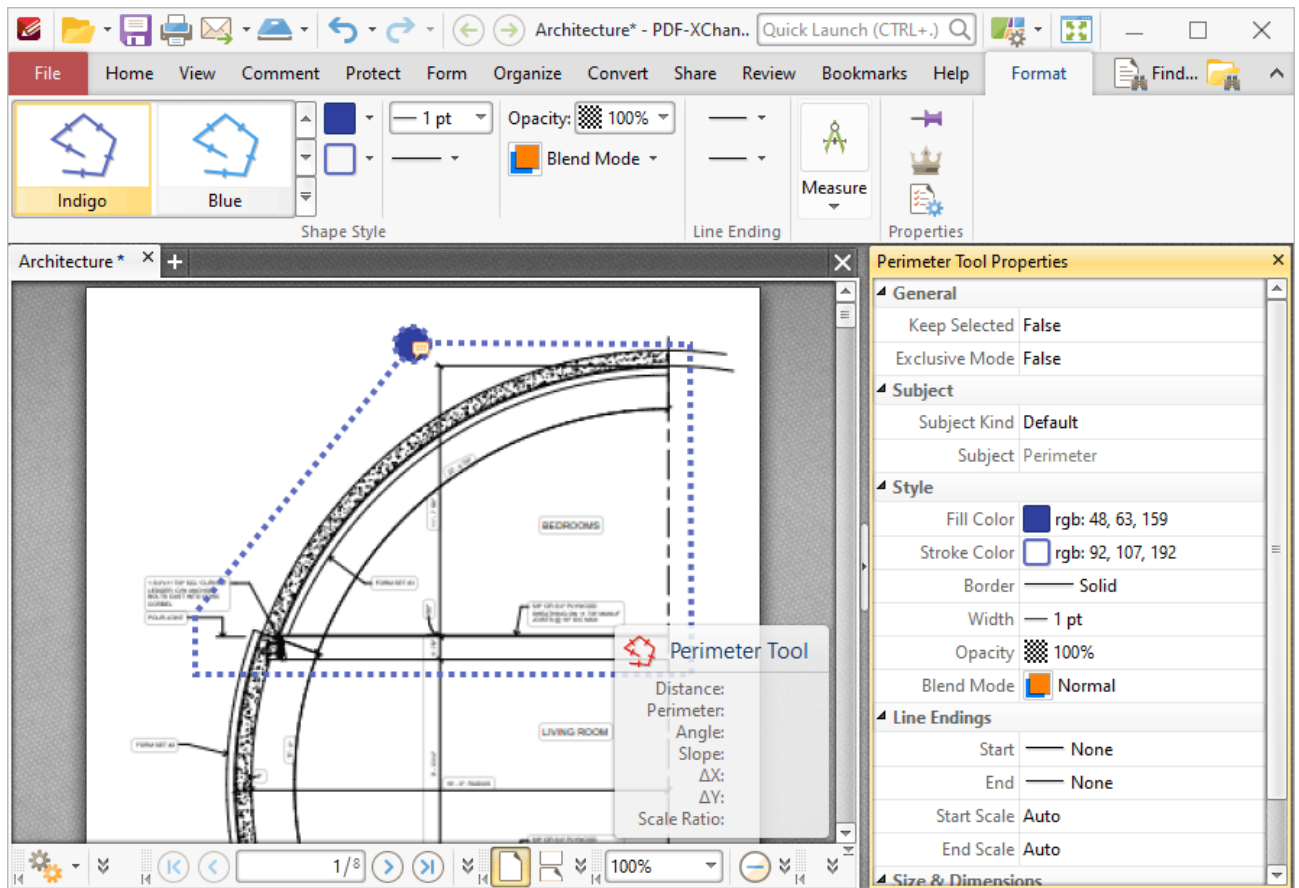

Figure 4. Format Tab, Perimeter Tool

- Click options in the **Shape Style** group to select alternative default perimeter annotation styles.
- Click **Keep Selected** to keep the **Perimeter Tool** selected and create multiple annotations consecutively. If this option is disabled then **PDF-XChange Editor** will revert to the designated default tool after the creation of one annotation.
- Click **Exclusive Mode** to give the **Perimeter Tool** priority over all other document content. When **Exclusive Mode** is enabled, the pointer ignores all interactive elements of documents other than base content. This makes it possible to create lines on areas that overlap with other content without the risk of accidentally selecting undesired items. When **Exclusive Mode** is disabled, the pointer recognizes and interacts with all content as normal.
- Click **Properties** to view/edit the **Perimeter Tool** properties, as detailed above.
- Click **Export to CSV** to export a summary of document comments to a comma-separated-values document. Note that when documents that contain perimeter annotations are exported to comma-separated-values, the output document will contain an **"Alt. Value"** column for perimeter annotations. This value details the area of perimeter annotations.
- Click **Edit Label** to create/edit the text label of the perimeter annotation, or click **Delete Label** to delete the label. Note that labels are displayed when the pointer is hovered over the annotation.
- When perimeter annotations are selected, the **Style Tools** dropdown menu is available in the **Format** tab. It contains the following options:
  - Click **Copy Comment Style** to copy the style properties of perimeter annotations.
  - Click **Apply Copied Comment Style** to apply a copied perimeter annotation style to selected annotations.
  - Click **Apply Copied Comment Appearance** to apply a copied perimeter annotation style to selected annotations.
  - Click **Make Current Properties Default** to set the properties of the perimeter annotation as the default properties for subsequent annotations.
  - Click **Apply Default Properties** to apply the default perimeter annotation properties to selected perimeter annotations.
- When perimeter annotations are selected, the **Pop-up** group is available in the **Format** tab and can be used to interact with the pop-up note of the annotation:
  - Click **Open** to open the pop-up note.
  - Click **Hide** to hide the pop-up note.
  - Click **Reset Location** to reset the location of the pop-up note.
- When perimeter annotations are selected, the **Arrange** tab is also available and can be used to manipulate comments as detailed [here](#).<sup>[1626]</sup>

Note that the [Comment Styles Palette](#)<sup>[1242]</sup> can be used to edit and save customized perimeter annotation styles for subsequent use, and the [Commenting](#)<sup>[875]</sup> preferences can be used to view/edit preferences for all comments.

---

## 10.4.4.23.3 Area Tool



Area Tool

Click **Area Tool** to measure custom document areas:

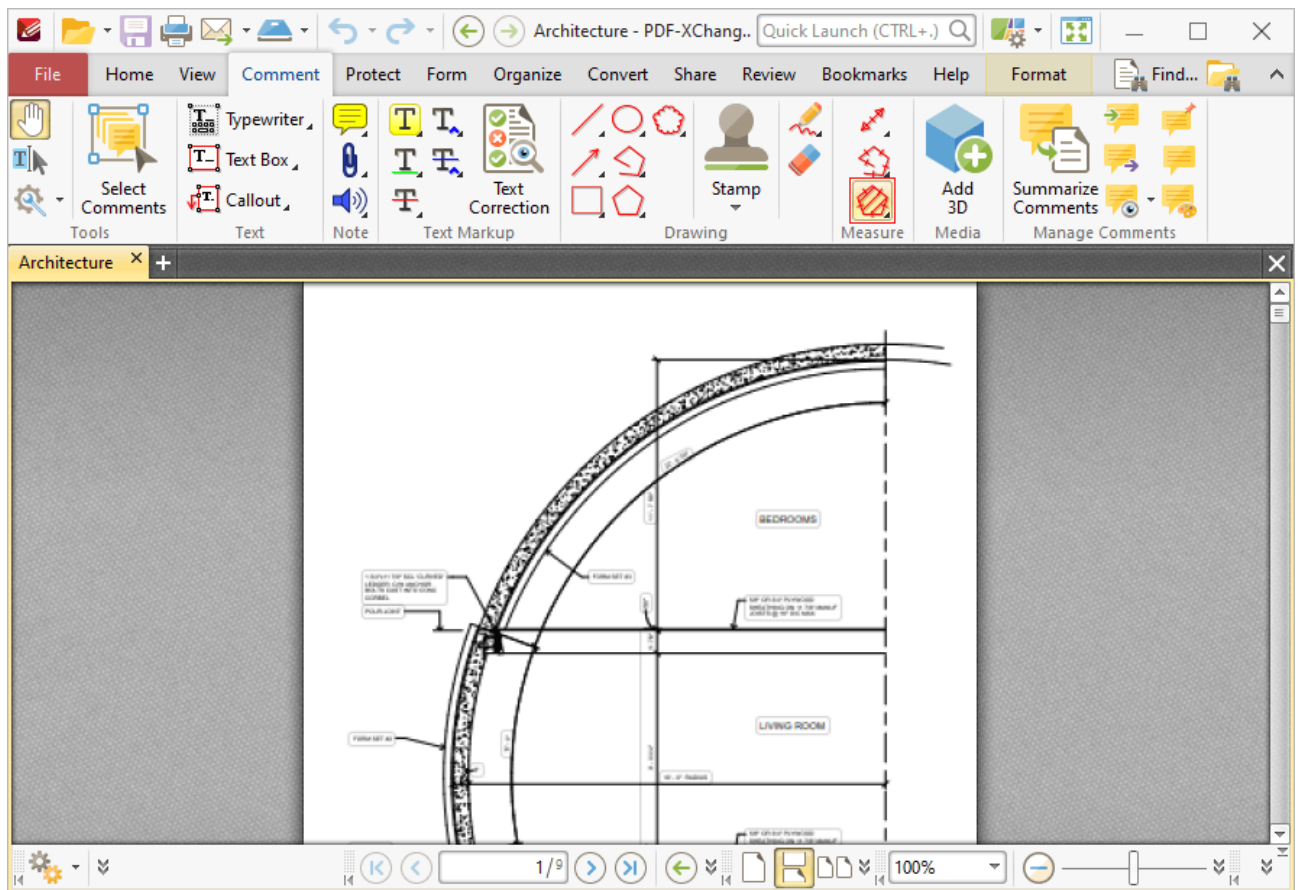

Figure 1. Comment Tab, Area Tool

When the **Area Tool** is selected the pointer becomes a crosshairs icon. Click to start an area measurement. A red line will appear and the **Area Tool** information box will be displayed in the lower right corner of the active window. This box will update as the tool is used. Drag the crosshairs to the location to which the first measurement is to be made, then click again to set the first line of the area measurement. Repeat the process until the area is complete and then double-click to define the final point:

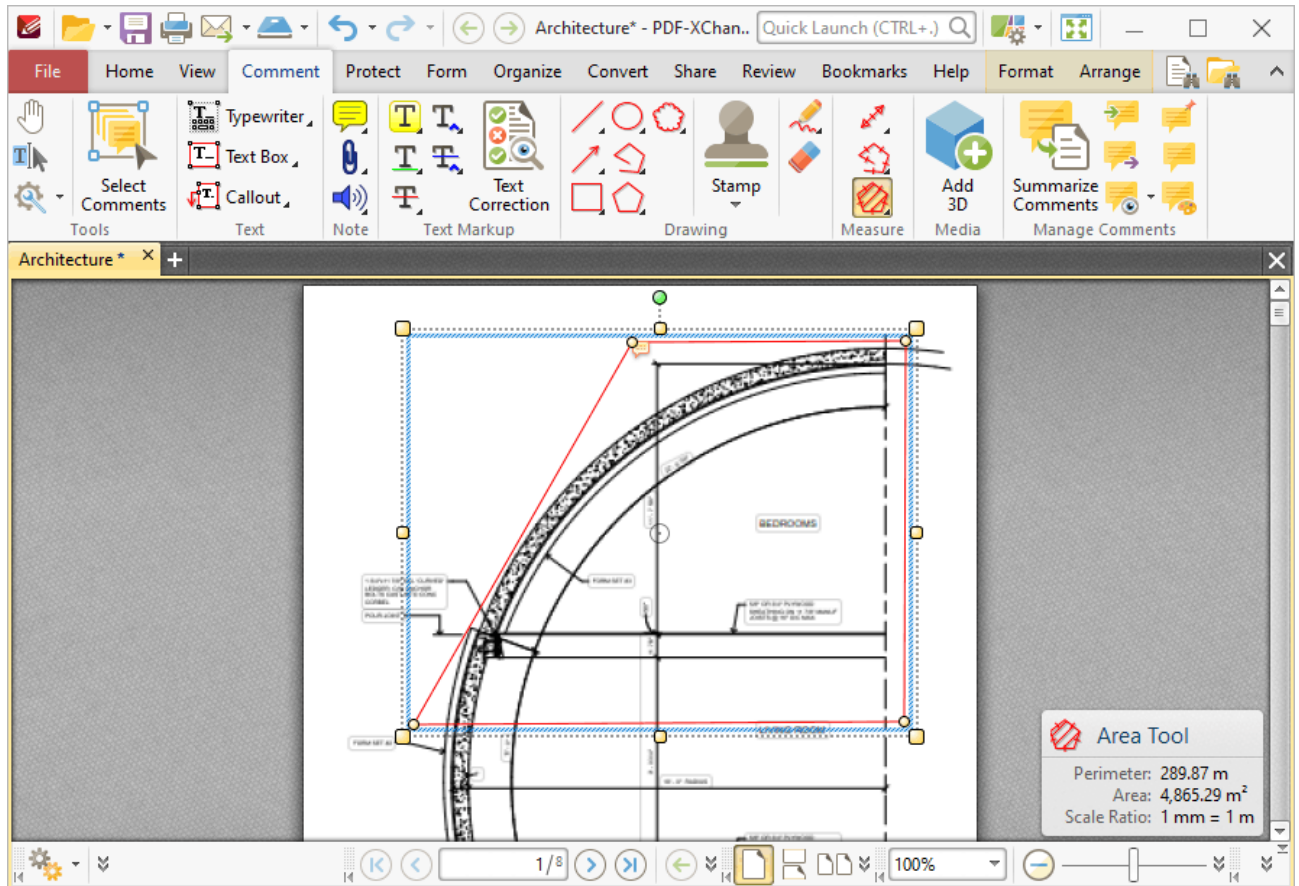

Figure 2. Area Tool Example

- The **Area Tool** calculates and displays areas measured according to the active scale, which can be determined in the **Format** tab, as detailed below.
- Click and drag the area annotation to reposition it. The circle at the center can also be used for this purpose.
- Click and drag the outer control points to resize the area annotation.
- Click and drag the inner control points to reshape the area annotation.
- Click and drag the green control point at the top to rotate the area annotation. Hold down Shift to rotate at increments of fifteen degrees.
- Use the arrow keys to reposition area annotations. Hold down Shift to move at an increased increment.
- Use the editing aids detailed [here](#)<sup>1075</sup> to assist in the precise placement of area annotations.
- Hold down Shift to create area annotations at increments of fifteen degrees.
- Right-click area annotations for further options. See [here](#)<sup>1783</sup> for an explanation of these options.
- Press Ctrl+' to open the **Properties** pane for selected area annotations and view/edit properties:

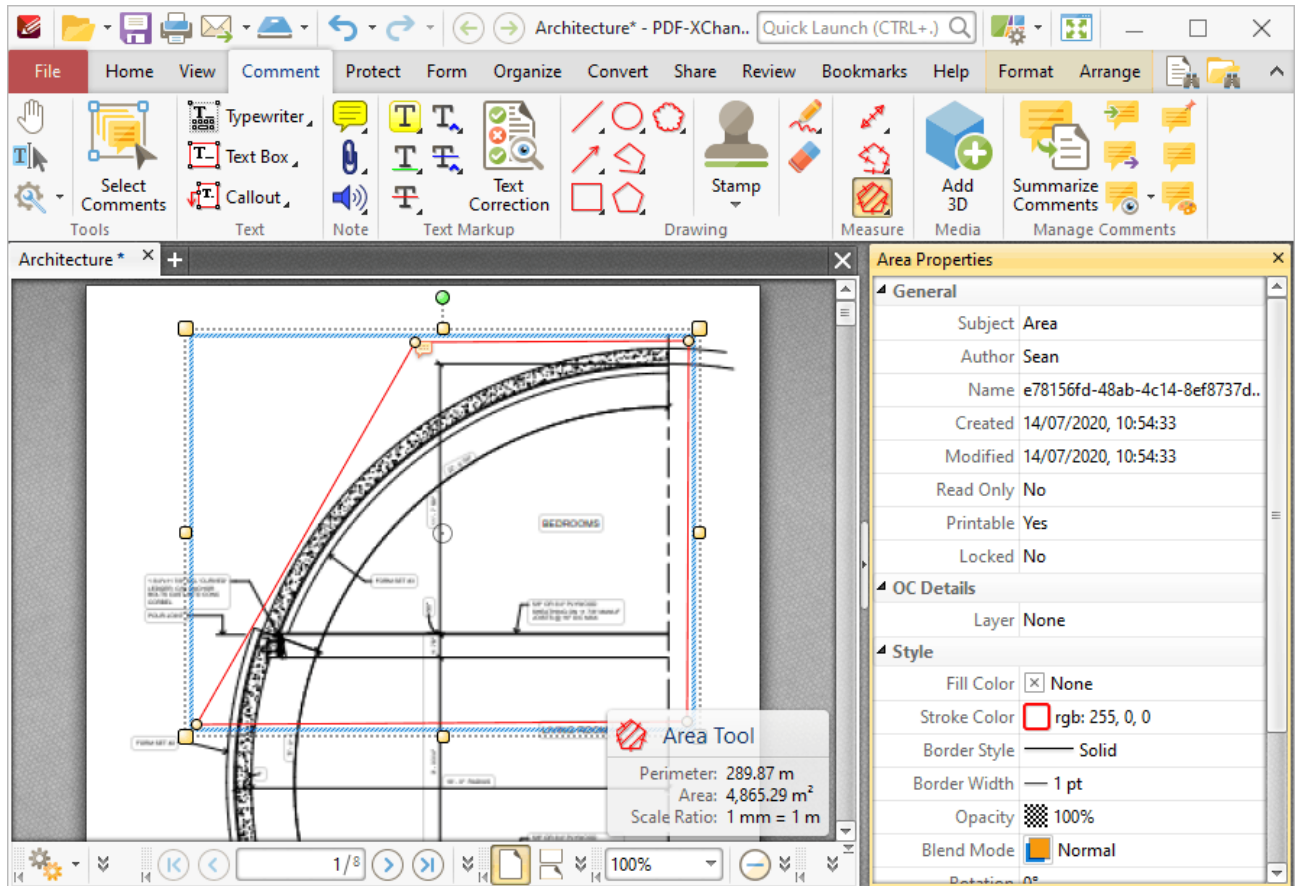

Figure 3. Area Tool, Area Properties Pane

- **Subject** is the name of the area annotation, as referenced in the [Comments](#)<sup>1007</sup> pane.
- **Author** is the name of the user that created the area annotation.
- **Name** is the unique name of the area annotation, as referenced within the application.
- **Created** is the date and time at which the area annotation was created.
- **Modified** is the date and time at which the area annotation was last modified.
- **Read Only** is the read only status of the area annotation. If this property is enabled then users cannot interact with the annotation. Please note that it is necessary to use JavaScript to change the value of this property.
- **Printable** is the print status of the area annotation. If this property is enabled then the annotation is printed with the document. If this property is not enabled then the annotation is not printed.
- **Locked** is the locked status of the area annotation. If this property is enabled then the annotation cannot be deleted and its properties (including its position and size) cannot be modified by users.
- **Layer** specifies the optional content layer to which the area annotation belongs. Further information about layers is available [here](#).<sup>1024</sup>
- **Fill Color** determines the color of the line ending style used at the start of the area annotation. The line ending property is detailed below.
- **Stroke Color** determines the color of the area annotation.

- **Border Style** determines the style of the area annotation.
- **Border Width** determines the width of the area annotation.
- **Opacity** determines the level of transparency in the area annotation.
- **Blend Mode** determines how area annotations blend with overlapping content. These options are explained [here](#).<sup>1659</sup>
- **Rotation** determines the degrees of rotation of the area annotation.
- **Scale** determines the scale used for the area annotation. Further information about scales is available [here](#).<sup>1224</sup>
- **Precision** determines the precision with which scale conversions are displayed.
- **Decimal** determines the symbol used as the decimal separator.
- **Group** determines the symbol used as the group separator.

Note that when the **Area Tool** is enabled, the **Format** tab is available and can be used to customize the default properties of area annotations:

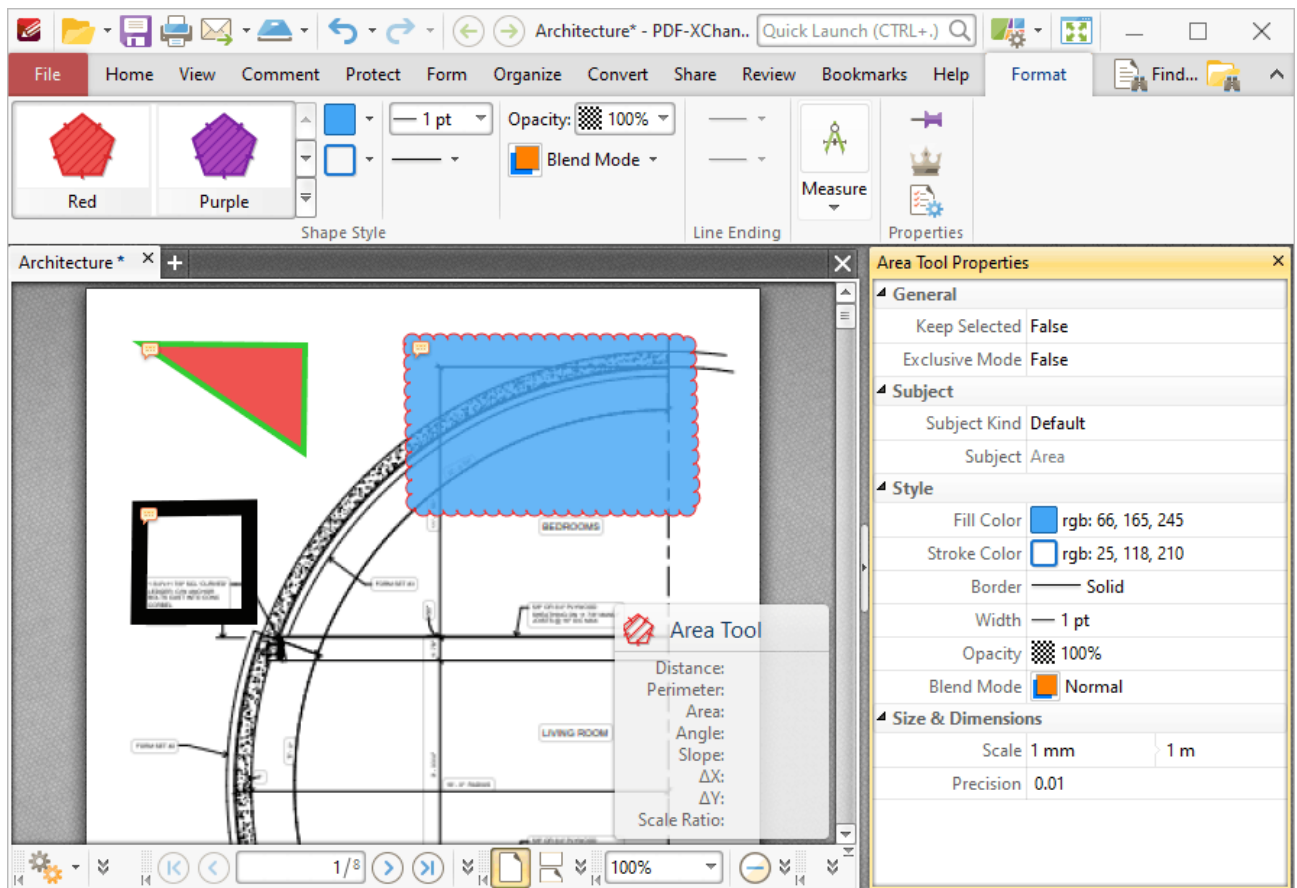

Figure 4. Format Tab, Area Tool

- Click **Keep Selected** to keep the **Area Tool** selected and create multiple area annotations consecutively. If this option is disabled then **PDF-XChange Editor** will revert to the designated default tool after the creation of one annotation.

- Click **Exclusive Mode** to give the **Area Tool** priority over all other document content. When **Exclusive Mode** is enabled, the pointer ignores all interactive elements of documents other than base content. This makes it possible to create lines on areas that overlap with other content without the risk of accidentally selecting undesired items. When **Exclusive Mode** is disabled, the pointer recognizes and interacts with all content as normal.
- Click **Properties** to view/edit the **Area Tool** properties, as detailed above.
- Click **Export to CSV** to export a summary of document comments to a comma-separated-values document. Note that when documents that contain area annotations are exported to comma-separated-values, the output document will contain an "**Alt. Value**" column for area annotations. This value details the perimeter of area annotations.
- Click **Edit Label** to create/edit the text label of the area annotation, or click **Delete Label** to delete the label. Note that labels are displayed when the pointer is hovered over the annotation.
- When area annotations are selected, the **Style Tools** dropdown menu is available in the **Format** tab. It contains the following options:
  - Click **Copy Comment Style** to copy the style properties of area annotations.
  - Click **Apply Copied Comment Style** to apply a copied area annotation style to selected annotations.
  - Click **Apply Copied Comment Appearance** to apply a copied area annotation style to selected annotations.
  - Click **Make Current Properties Default** to set the properties of the area annotation as the default properties for subsequent annotations.
  - Click **Apply Default Properties** to apply the default area annotation properties to selected area annotations.
- When area annotations are selected, the **Pop-up** group is available in the **Format** tab and can be used to interact with the pop-up note of the annotation:
  - Click **Open** to open the pop-up note.
  - Click **Hide** to hide the pop-up note.
  - Click **Reset Location** to reset the location of the pop-up note.
- When area annotations are selected, the **Arrange** tab is also available and can be used to manipulate comments as detailed [here](#).<sup>1626</sup>

Note that the [Comment Styles Palette](#)<sup>1242</sup> can be used to edit and save customized area annotation styles for subsequent use, and the [Commenting](#)<sup>875</sup> preferences can be used to view/edit preferences for all comments.

---

## 10.4.4.23.4 Set Scale



## Set Scale

When the **Measuring Tools** are selected, click **Scale** in the **Format** tab to view/select/manage/calibrate scales:

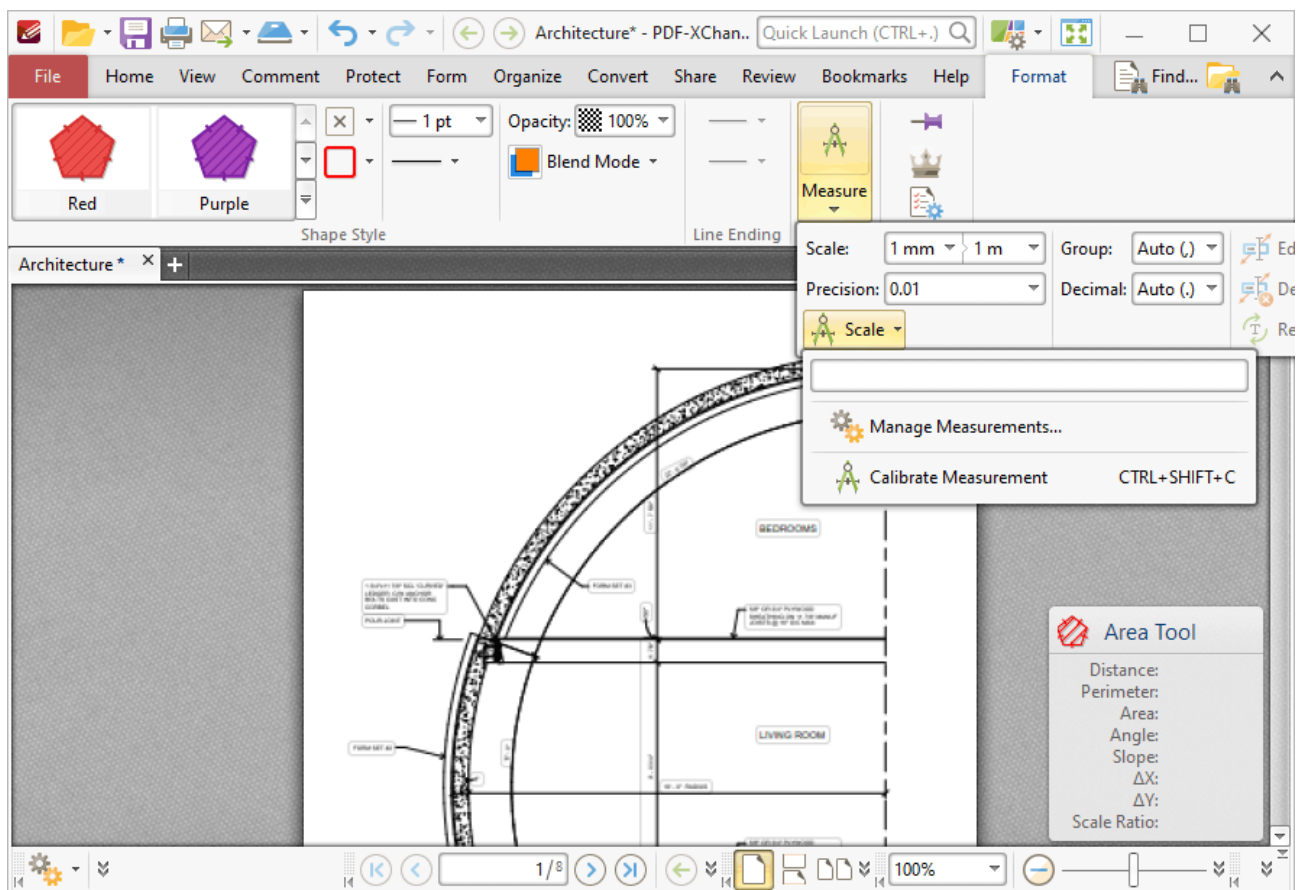

Figure 1. Format Tab, Scale Options

- Click **Manage Measurements** to view/edit/clone/delete scales.
- Click **Calibrate Measurement** to calibrate a new measurement. The pointer will become a crosshairs icon. Click and drag to determine a calibration distance. The **Calibration** dialog box will open:



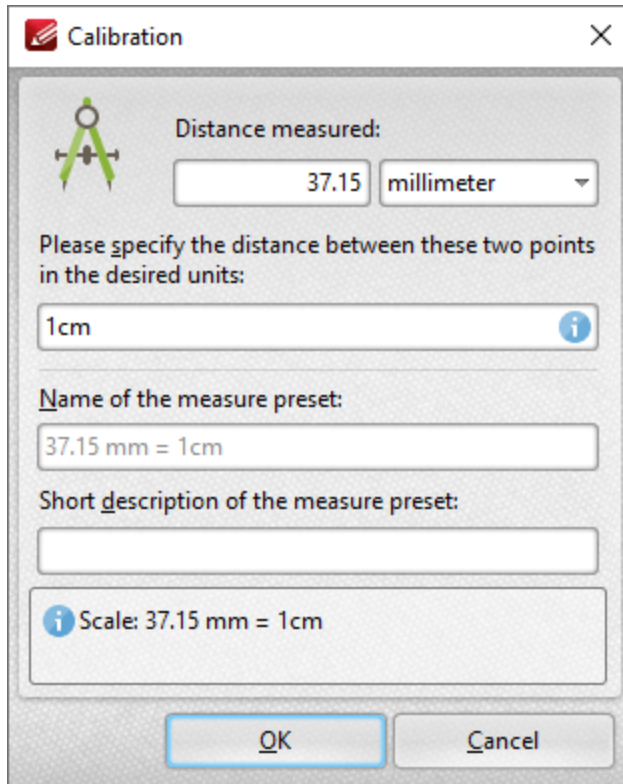

Figure 2. Calibration Dialog Box

- The distance determined in the document is detailed in the upper number box. Use the dropdown menu to select the desired units of measurement.
- Use the lower number box to determine the scale. Enter a numerical value and the desired units of measurement for the scale.
- Name and describe the calibration. The scale will be detailed in **Scale** pane.

Click **OK** to save the calibration.

The keyboard shortcut to enable this feature is Ctrl+Shift+C.

---

## 10.4.4.24 Add/Edit 3D Annotations

**Add/Edit 3D Annotations**

Click **Add/Edit 3D Annotations** to add/edit 3D annotations:

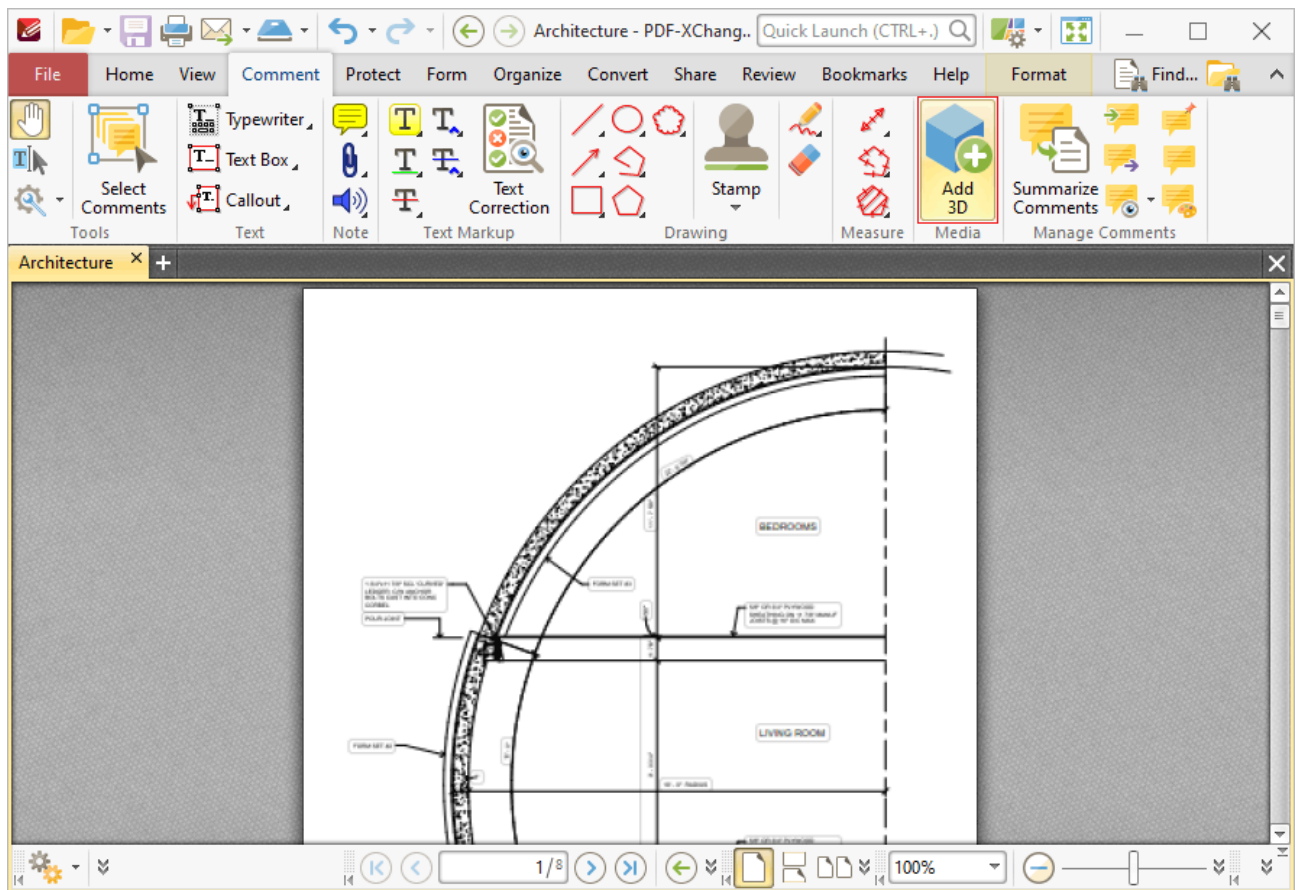

**Figure 1.** Comment Tab, Add/Edit 3D Annotation Highlighted

The pointer will become a crosshairs icon. Click and drag to determine the location at which you want to insert the 3D annotation. The **Add 3D Annotation** dialog box will open:

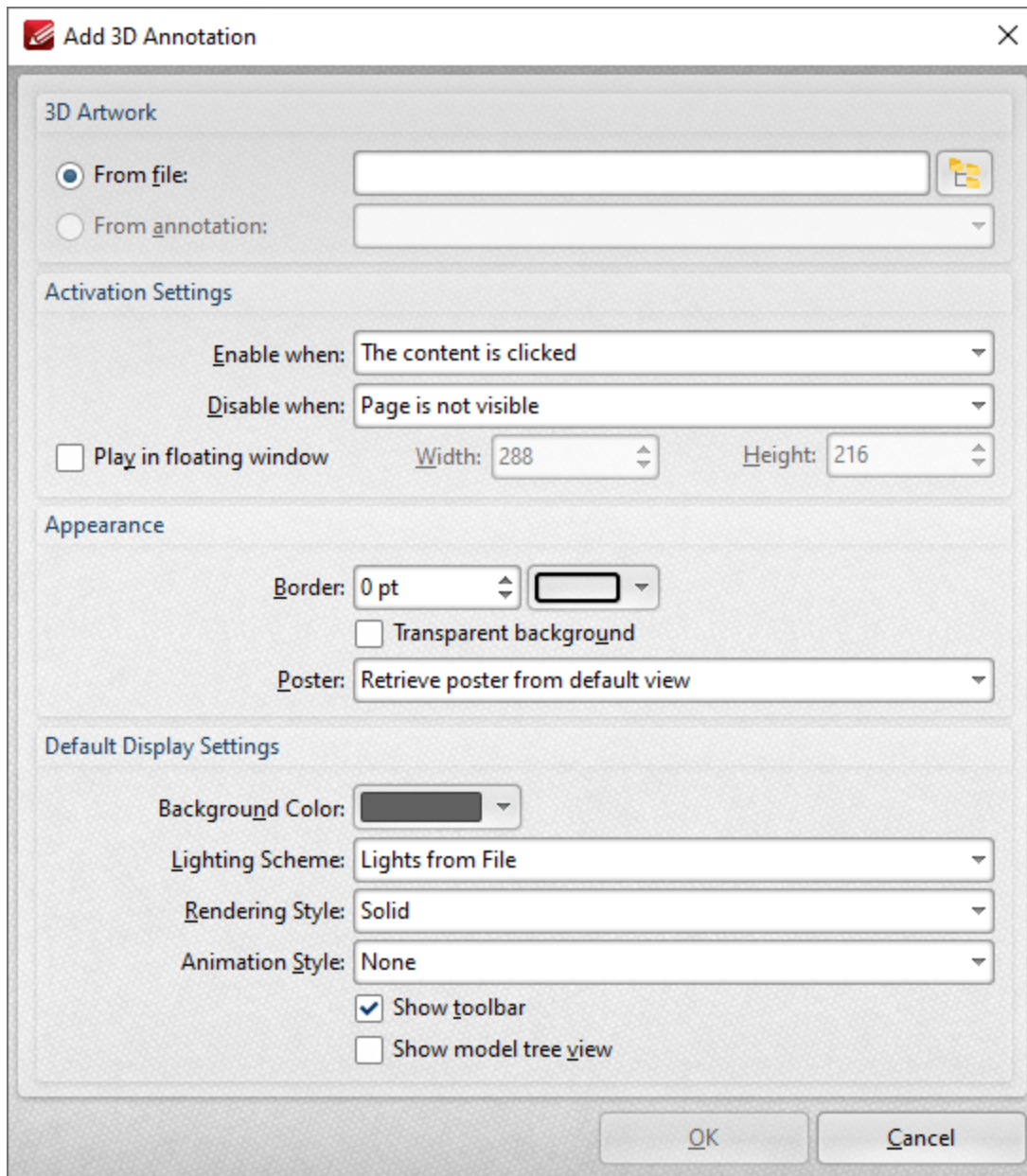

Figure 2. Add 3D Annotation Dialog Box

- Select the **From file** button to add a 3D annotation from file, then enter the name and path of the file or click the icon to select it using the **Windows** file explorer.
- Select the **From annotation** button to add a 3D annotation from an existing 3D annotation in the current document, then select the desired annotation in the dropdown menu.
- Use the **Enable when** dropdown menu to determine when the 3D annotation is enabled.
- Use the **Disable when** dropdown menu to determine when the 3D annotation is disabled.
- Select the **Play in floating window** box to display the 3D annotation in a floating window when it is enabled. Use the **Width** and **Height** number boxes to determine the dimensions of the floating window.

- Use the **Border** number box and adjacent dropdown menu to determine the size and color of the border around the 3D annotation.
- Use the **Poster** dropdown menu to determine the image that displays over the 3D annotation before it is enabled:
  - Select **Retrieve poster from default view** to use the default view of the 3D annotation as the poster.
  - Select **Create poster from file** to use a file on your computer, then select the file in the **Open Files** dialog box.
- Use the **Background Color** dropdown menu to determine the background color of the 3D annotation. This color will also be used as the color of the annotation before it is enabled when the **Retrieve poster from default view** option detailed above is used.
- Use the **Lighting Scheme** dropdown menu to determine the lighting scheme of the 3D annotation.
- Use the **Rendering Style** dropdown menu to determine the rendering style of the 3D annotation.
- Use the **Animation Style** dropdown menu to determine the animation style of the 3D annotation.
- Select the **Show toolbar** and/or **Show model tree view** boxes to enable/disable these options as desired.

Click **OK** to add the 3D annotation.

---

## 10.4.4.25 Manage Comments



## Manage Comments

Use the options in the **Manage Comments** group to manipulate and utilize comments:

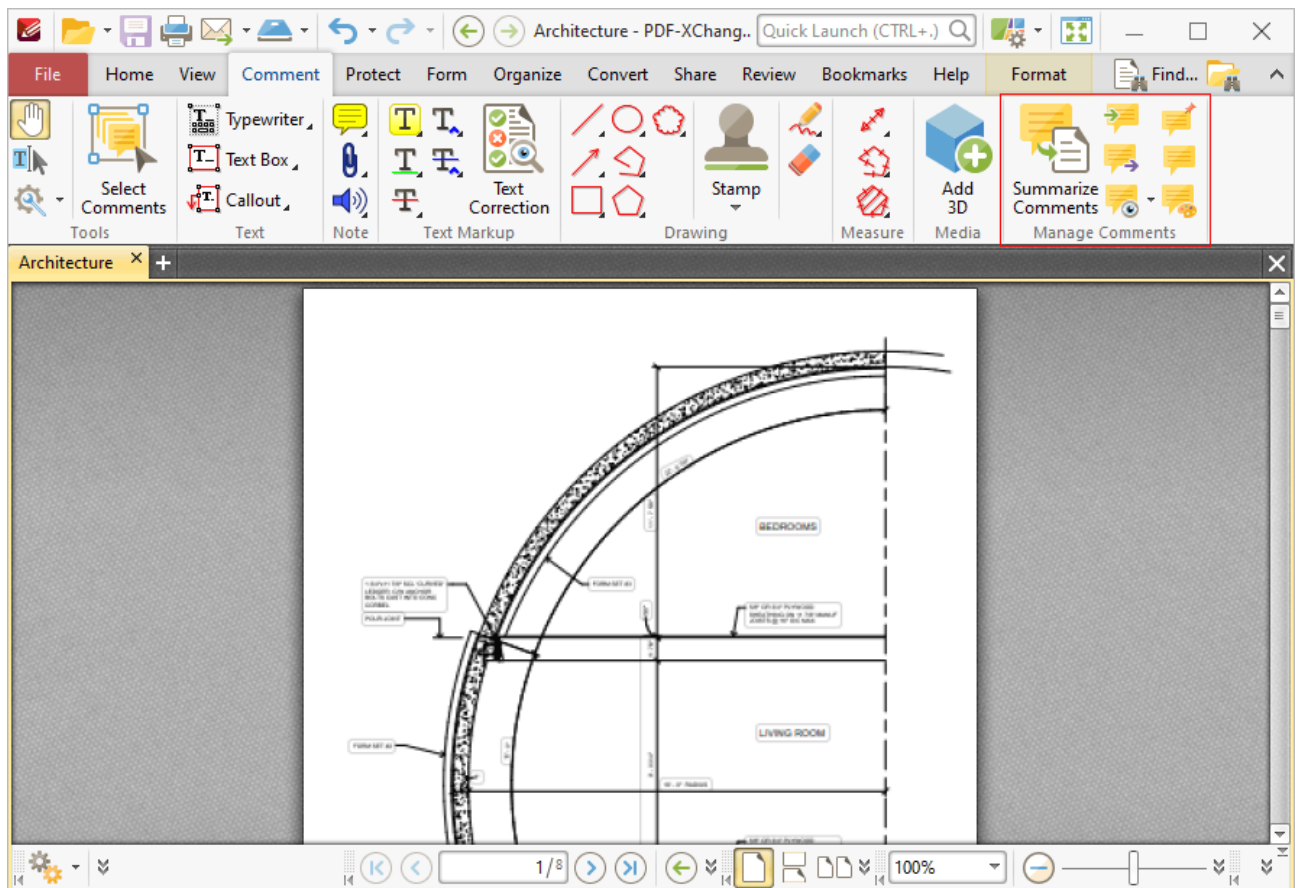

Figure 1. Comment Tab, Manage Comments Group

- Click **Summarize Comments** to create a comment summary, as detailed [here](#).<sup>1231</sup>
- Click **Import** to import comments from file, as detailed [here](#).<sup>1234</sup>
- Click **Export** to export comments to file, as detailed [here](#).<sup>1236</sup>
- Click the **Show** dropdown menu to determine which comments are shown/hidden, as detailed [here](#).<sup>1237</sup>
- Click **Flatten** to flatten comments to base content, as detailed [here](#).<sup>1238</sup>

- Click **Comments List** to open/close the [Comments](#)  pane.
  - Click **Comment Styles** to open the **Comment Styles Palette** and edit comment styles, as detailed [here](#). 
-

10.4.4.25.1 Summarize Comments



**Summarize Comments**

Click **Summarize Comments** to create a summary of document comments:

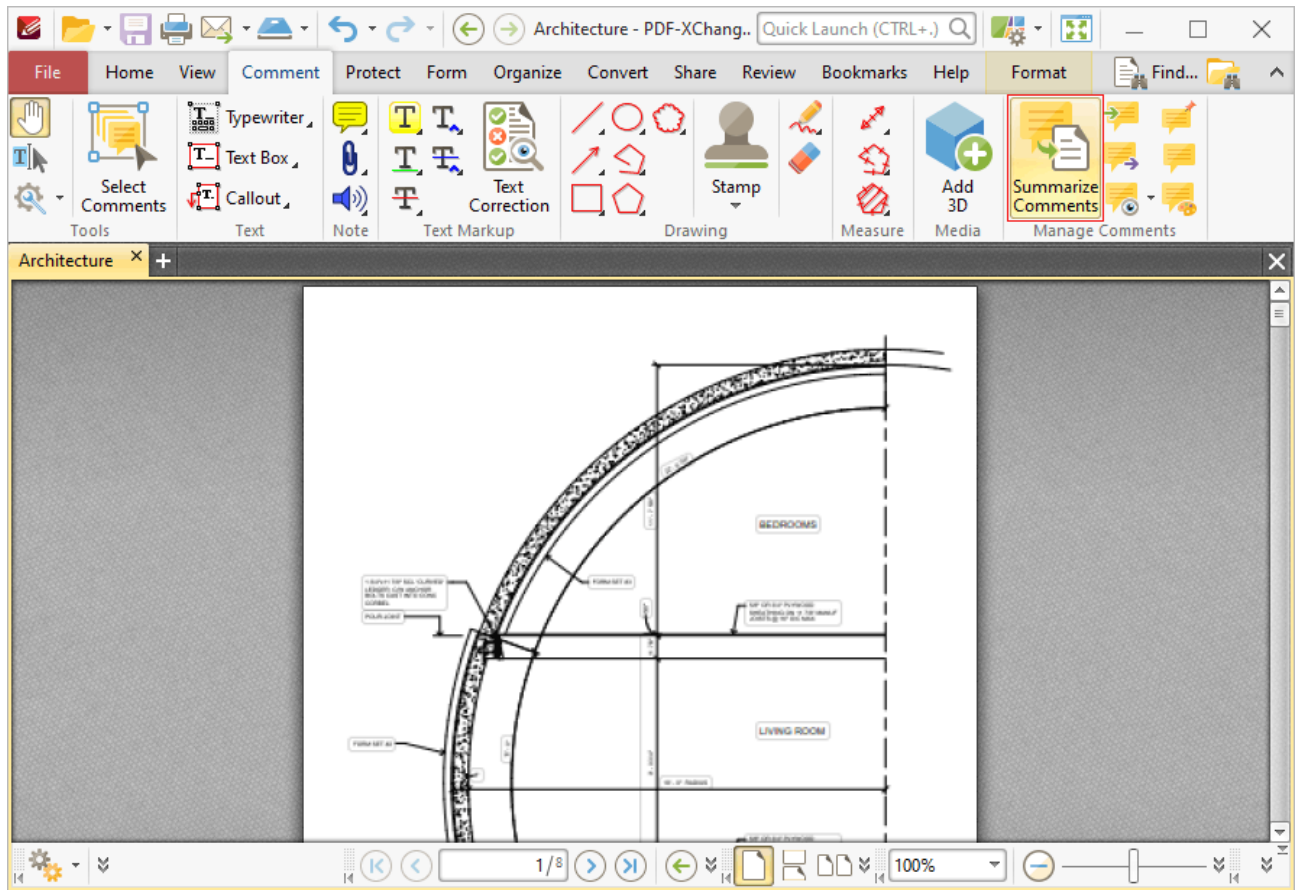

Figure 1. Comment Tab, Summarize Comments

The **Summarize Comments** dialog box will open:

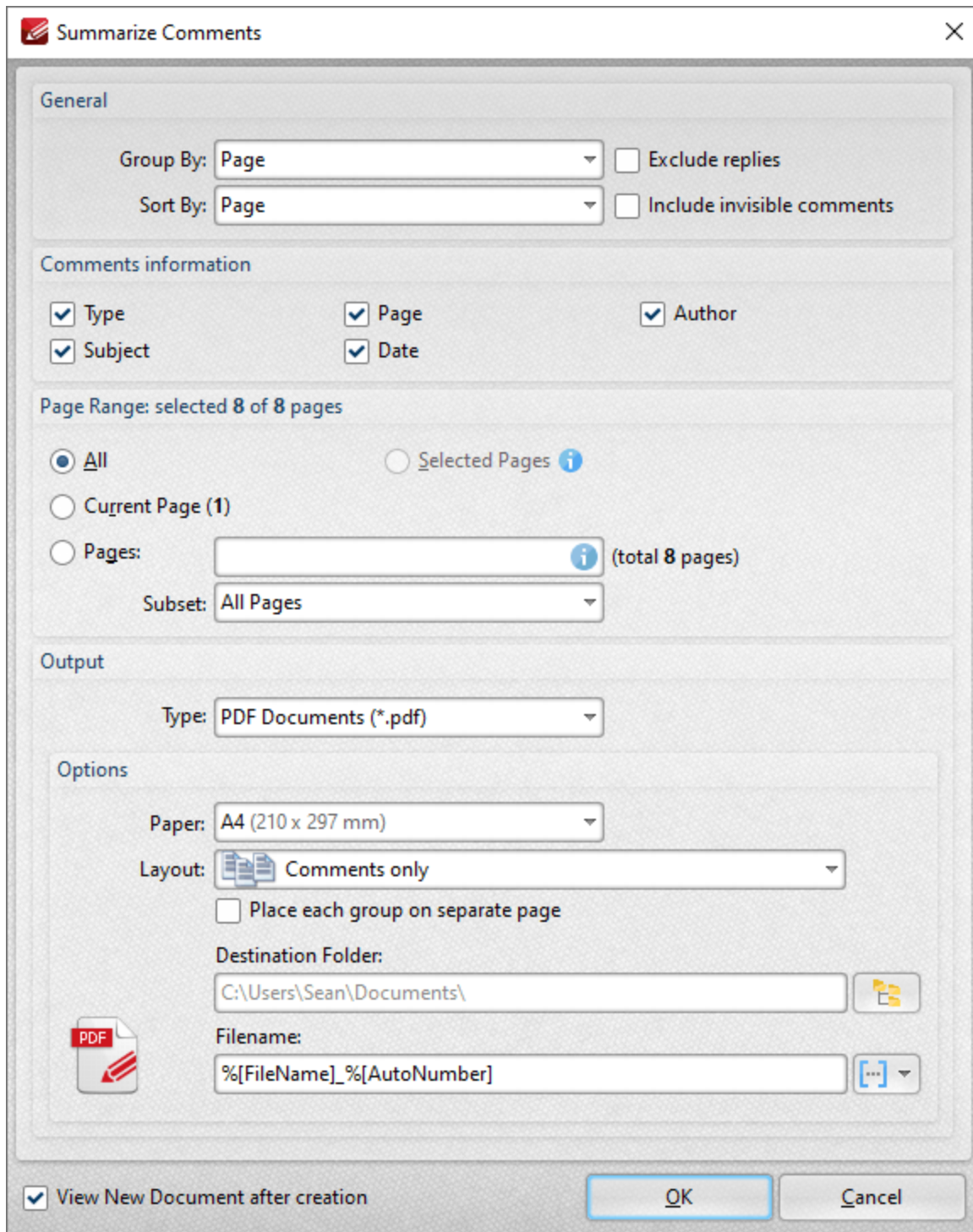

Figure 2. Summarize Comments Dialog Box

- Use the **Group by** and **Sort By** dropdown menus to determine how comments are grouped and summarized:
  - Select **Page** to group/sort comments by page.
  - Select **Type** to group/sort comments by type.
  - Select **Author** to group/sort comments by author.



- Select **Date** to group/sort comments by date.
- Select **Subject** to group/sort comments by subject.
- Select **Visual Order** to sort comments by their visual order.
- Select the **Exclude replies** box to exclude replies to comments from the summary.
- Select the **Include invisible comments** box to include invisible comments in the summary.
- Use the **Page Range** settings to determine the page range from which the comment summary comes:
  - Select **All** to include all pages.
  - Select **Current Page** to use only the current page.
  - Select **Selected** to use the pages currently selected in the [Thumbnails](#) <sup>1000</sup> pane.
  - Use the **Pages** box to specify a custom page range. Further information on the specification of page ranges is available [here](#). <sup>1772</sup>
  - Use the **Subset** option to specify a subset of custom page ranges. Select **All Pages, Odd Pages Only** or **Even Pages Only** as desired.
- Use the **Output** dropdown menu to determine the format of the summary.
- Use the **Options** dropdown boxes to determine customizable options for the selected output format.
- Use the **Destination Folder** text box to determine the destination folder for the summary, or click the icon to select a folder on the local computer.
- Use the **Filename** text box to determine the name of the summary. Click the macro dropdown menu to add [macros](#) <sup>1707</sup> as desired.
- Select the **View New Document after creation** box to open the document when the process is complete.

Click **OK** to create the summary.

N.b. Text that the **Highlight, Strikeout** and **Underline Tools** have been used to annotate is not included in comment summaries by default. Add text to the pop-up note of these annotations in order to include them in the comment summary. (This is true for all comments that feature pop-up notes). There is an option in the [Commenting Preferences](#) <sup>875</sup> that automatically adds annotated text to the associated pop-up note of annotations.

---

## 10.4.4.25.2 Import Comments

**Import Comments**

Click **Import** to import comments into the active document:

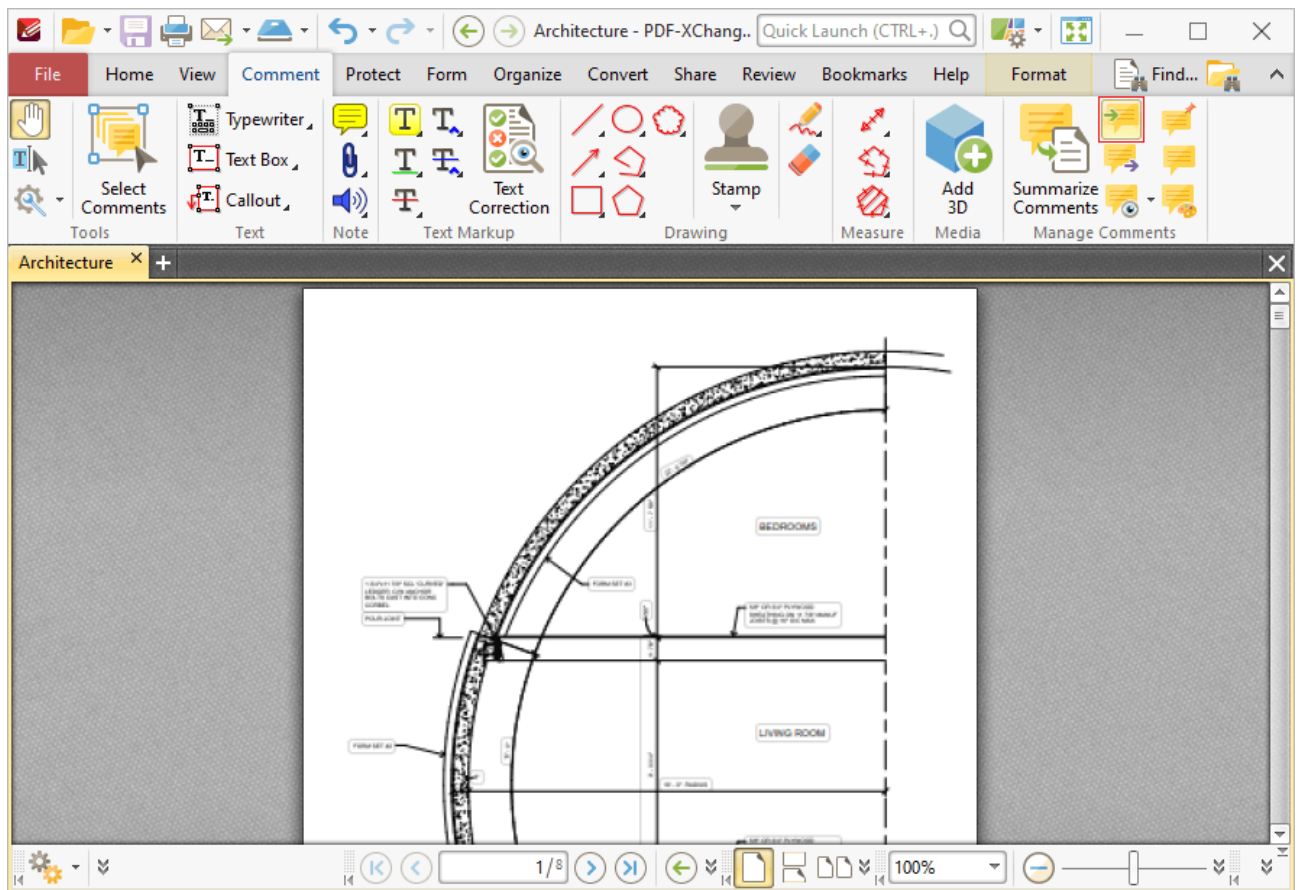

**Figure 1.** Comment Tab, Import

The **Open Files** dialog box will open. Select the desired file and click **Open** to import comments.

Comments can be imported from **(\*fdf)** or **(\*xdf)** files. FDF format is the file format used to submit, receive and incorporate form data to a server. It can also be used to export form data to stand-alone files that can be stored, electronically transmitted and imported back into the corresponding PDF

interactive form. Use the [Export Comments to Data File](#)  feature of **PDF-XChange Editor** to export document comments to (\*.fdf) or (\*.xpdf) files.

Please note that the document location of imported comments matches that of the file used for the import. If comments appear to be placed incorrectly then it is probable that the source and recipient files are different in format. For example, if comments from a ten-page document are imported into a two-page document, then comments from only the first two pages will be imported.

---

## 10.4.4.25.3 Export Comments

**Export Comments**

Click **Export** to export comments from the active document to (\*.fdf) or (\*.xpdf) files:

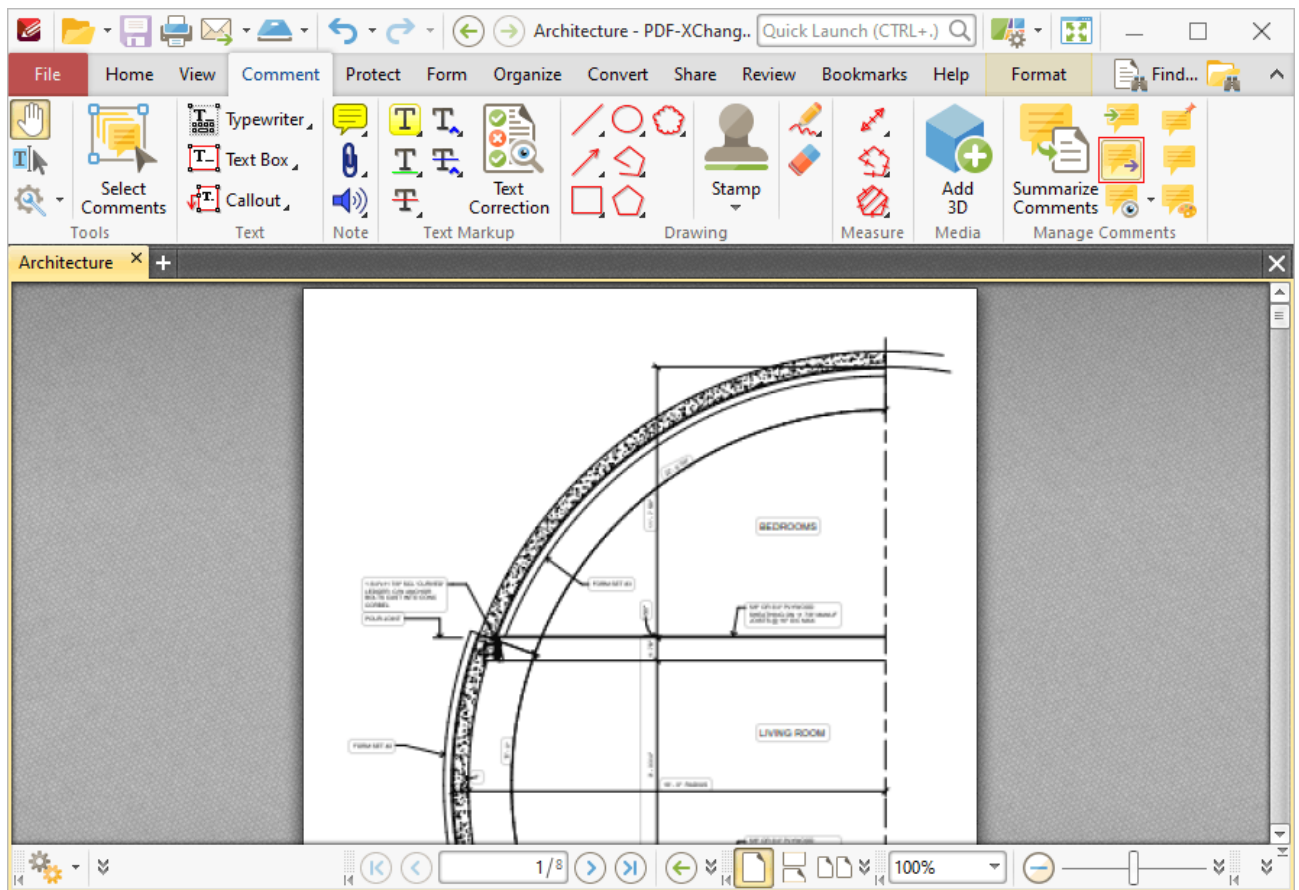

**Figure 1.** Comment Tab, Export

The **Save File** dialog box will open. Enter the desired file name and location, then click **Save** to export and save the document comments.

## 10.4.4.25.4 Show Comments



## Show Comments

Click the **Show** dropdown menu to view comment display options:

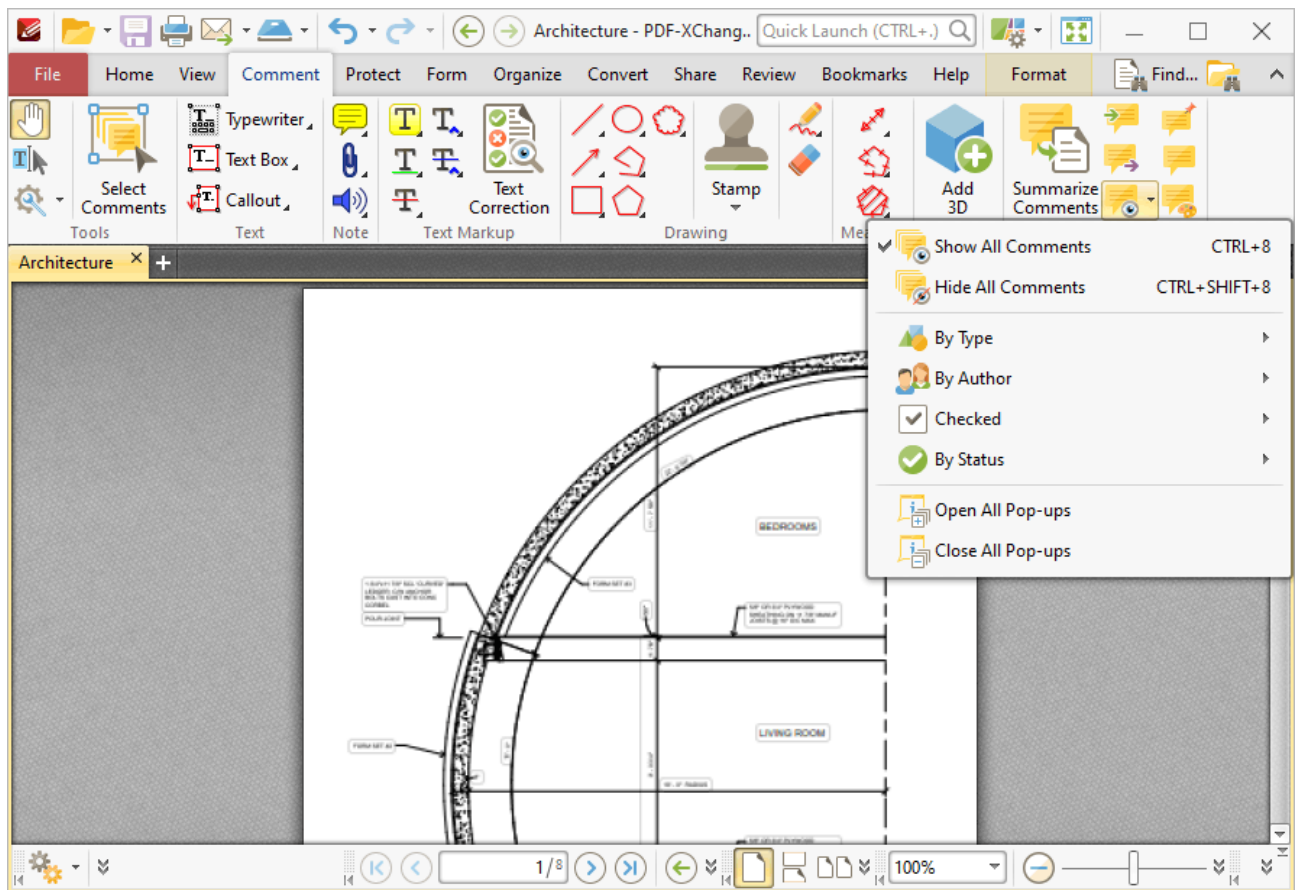

Figure 1. Comment Tab, Show

These options are used to determine the display settings for comments and comment pop-ups:

- Click **Show All Comments/Hide All Comments** to show/hide all document comments.
- Hover over **By Type** to determine comment display options according to their format. A submenu containing all comment formats in the document will be displayed. Select the check boxes of the desired comment formats to be displayed.

- Hover over **By Author** to determine comment display options according to their author. A submenu containing all comment authors will be displayed. Select the check boxes of the desired comment authors to be displayed.
  - Hover over **Checked** to determine comment display options according to their checked/unchecked status in the [Comments Pane](#).<sup>1007</sup> (Please note that each comment in the **Comments** pane features a check box, and it is these check boxes that are referenced with regard to this setting). A submenu containing all available options will be displayed. Select the check boxes of the desired comment statuses to be displayed.
  - Hover over **By Status** to determine comment display options according to their current editing status. (Right click comments and hover over **Status** in the submenu to view/edit the editing status of comments. The options are **None, Accepted, Cancelled, Completed** and **Rejected**. Click options to set them as the comment editing status). A submenu containing all available options will be displayed. Select the check boxes of the desired comment statuses to be displayed.
  - Select **Open All Pop-ups** or **Close All Pop-ups** to open/close the pop-up annotations of all comments.
-

10.4.4.25.5 Flatten Comments



**Flatten Comments**

Click **Flatten Comments** to flatten comments and annotations to the base content layer of documents:

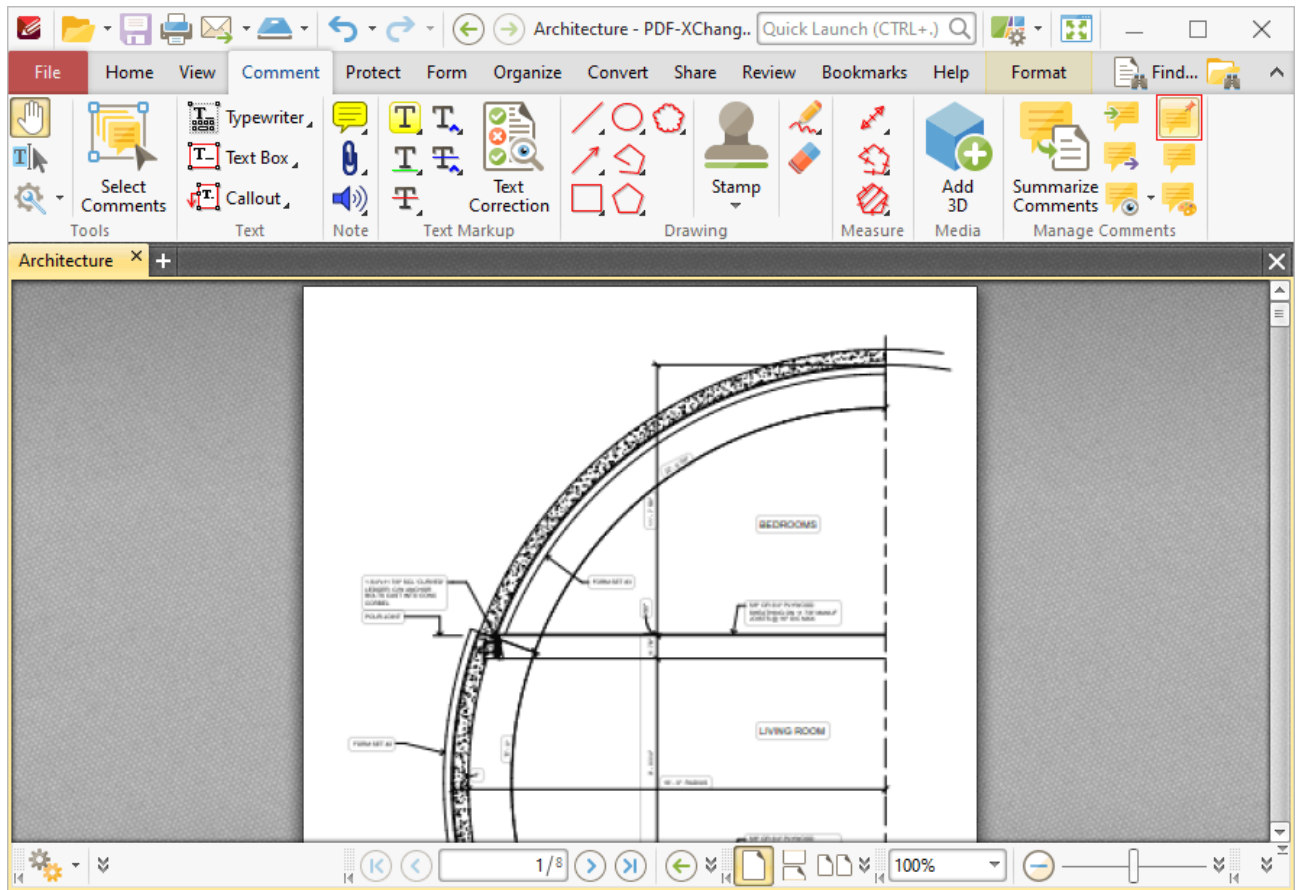

Figure 1. Comment Tab, Flatten Comments

The **Flatten Annotations** dialog box will open:

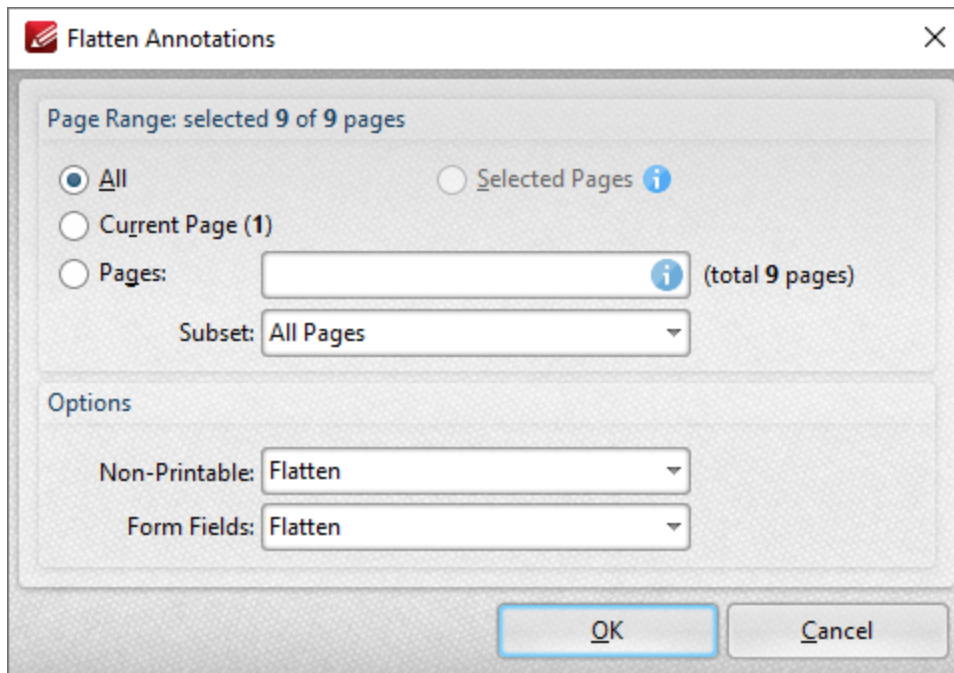

Figure 1. Flatten Annotations Dialog Box

- Use the **Page Range** options to determine the page range in which comments are flattened:
  - Select **All** to flatten comments/annotations on all pages.
  - Select **Current Page** to flatten comments/annotations on only the current page.
  - Use the **Pages** box to specify a custom page range in which to flatten comments/annotations. Further information on the specification of page ranges is available [here](#).<sup>1773</sup>
  - Use the **Subset** option to specify a subset of custom page ranges. Select **All Pages**, **Odd Pages Only** or **Even Pages Only** as desired.
- Use the **Non-Printable** and **Form Fields** options to determine the outcome of the flattening process for non-printable annotations and form fields. (The **Properties** options for comments/annotations can be used to determine whether or not they are printable):
  - Select **Flatten** to flatten content
  - Select **Left as Is** to retain the existing state of content.
  - Select **Remove** to remove the content from the document.

Click **OK** to flatten content.

---



## 10.4.4.25.6 Show Comments List



### Show Comments List

Click **Comments List** (or press Ctrl+M) to show/hide the [Comments Pane](#):

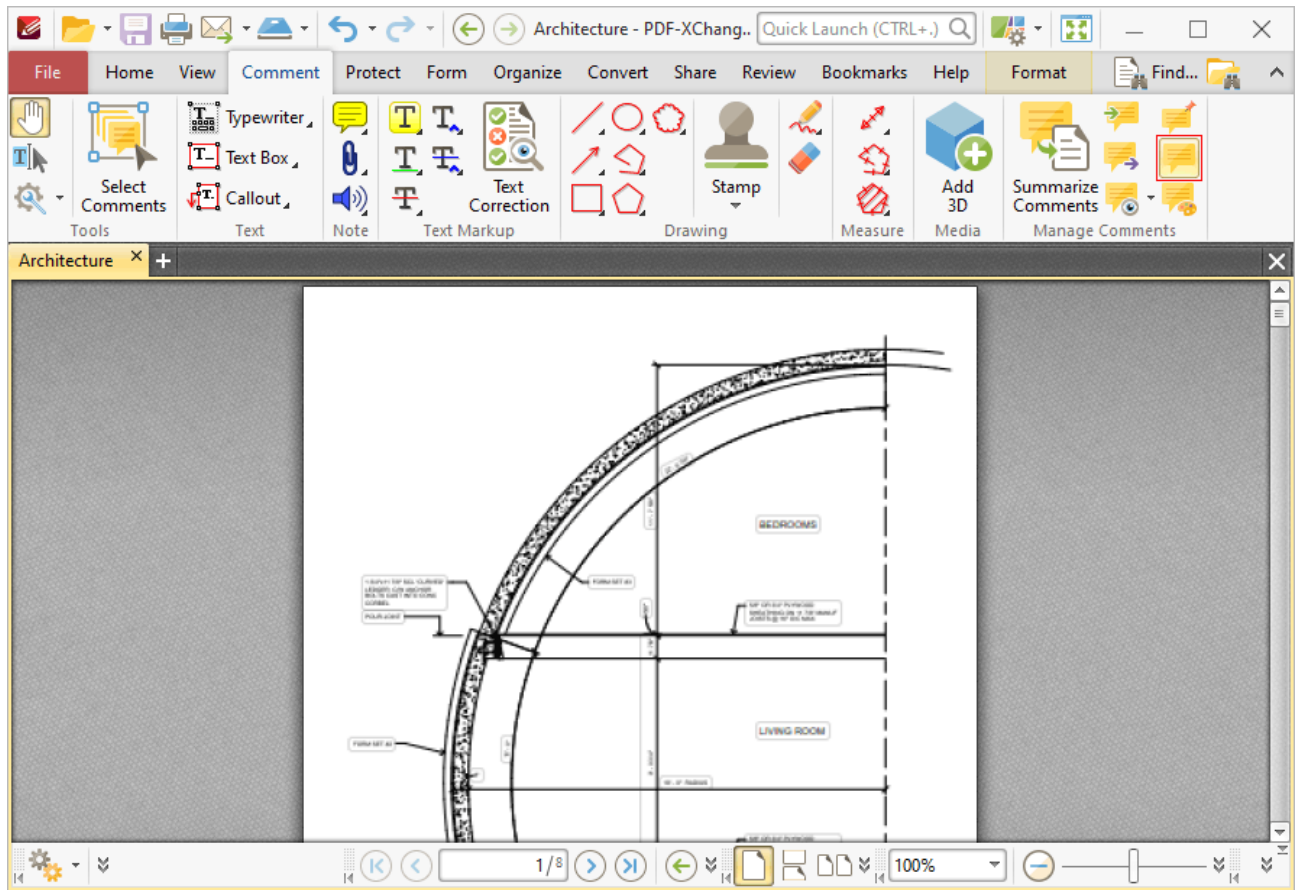

Figure 1. Comment Tab, Comments List

10.4.4.25.7 Comment Styles Palette



**Comment Styles Palette**

Click **Comment Styles** to open the **Comment Styles Palette**:

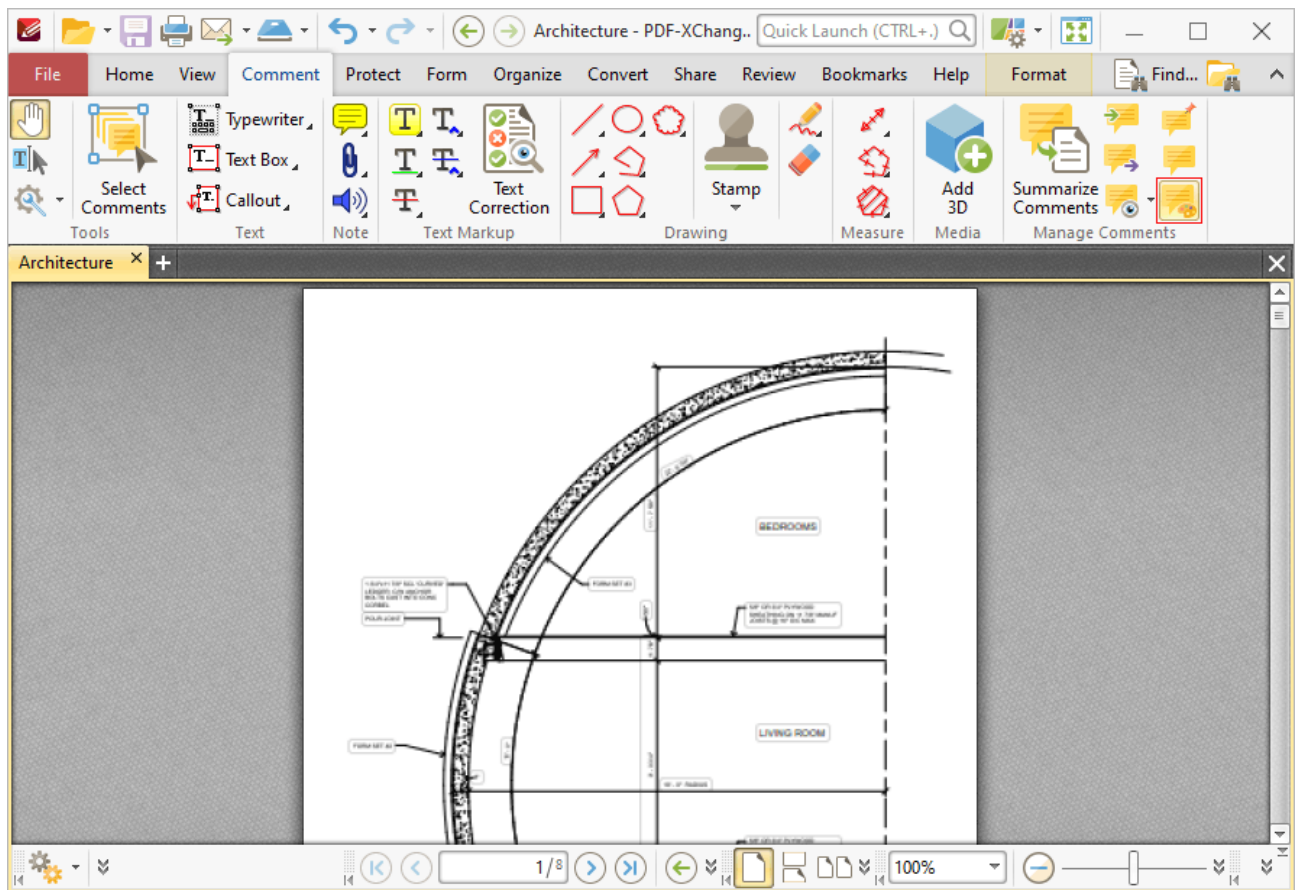

**Figure 1.** Comment Tab, Comment Styles

The **Comment Styles Palette** will open:

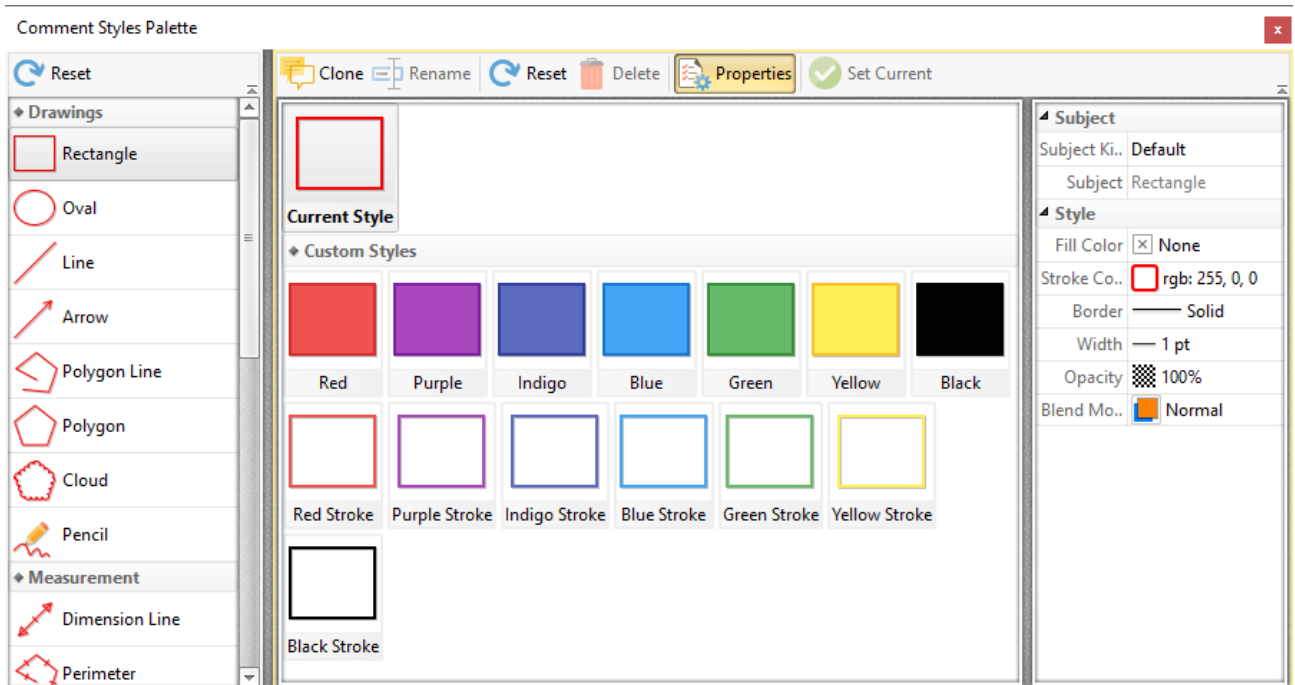

Figure 2. Comment Styles Palette

The **Comment Styles Palette** details current comment styles. Click comment formats in the pane on the left to view available comment styles. Several default comment styles are available for each format, and they are displayed in the central pane. Double-click to select styles (which will also update selected annotations in the current document). The following options are then available:

- Click **Clone** to clone the selected style. This feature creates a duplicate of styles in order to enable editing without the loss of the existing style. The cloned style will appear in the **Comment Styles Palette**. Select it and then click **Properties** to edit the properties of the style. Available properties depend on the annotation format. All available properties are detailed [here](#).
- Click **Rename** to rename the selected style, then enter the new name in the **Rename Comment Style** dialog box and click **OK**.
- Click **Reset** to reset the selected style to its default values.
- Click **Delete** to delete the selected style.
- Click **Set Current** to set the selected style selected as the active style for the tool.

Note that the active style of each comment is displayed in the **Comment** tab.

10.4.5 Protect Tab



**Protect Tab**

When the **Protect** tab is selected, the following options are available:

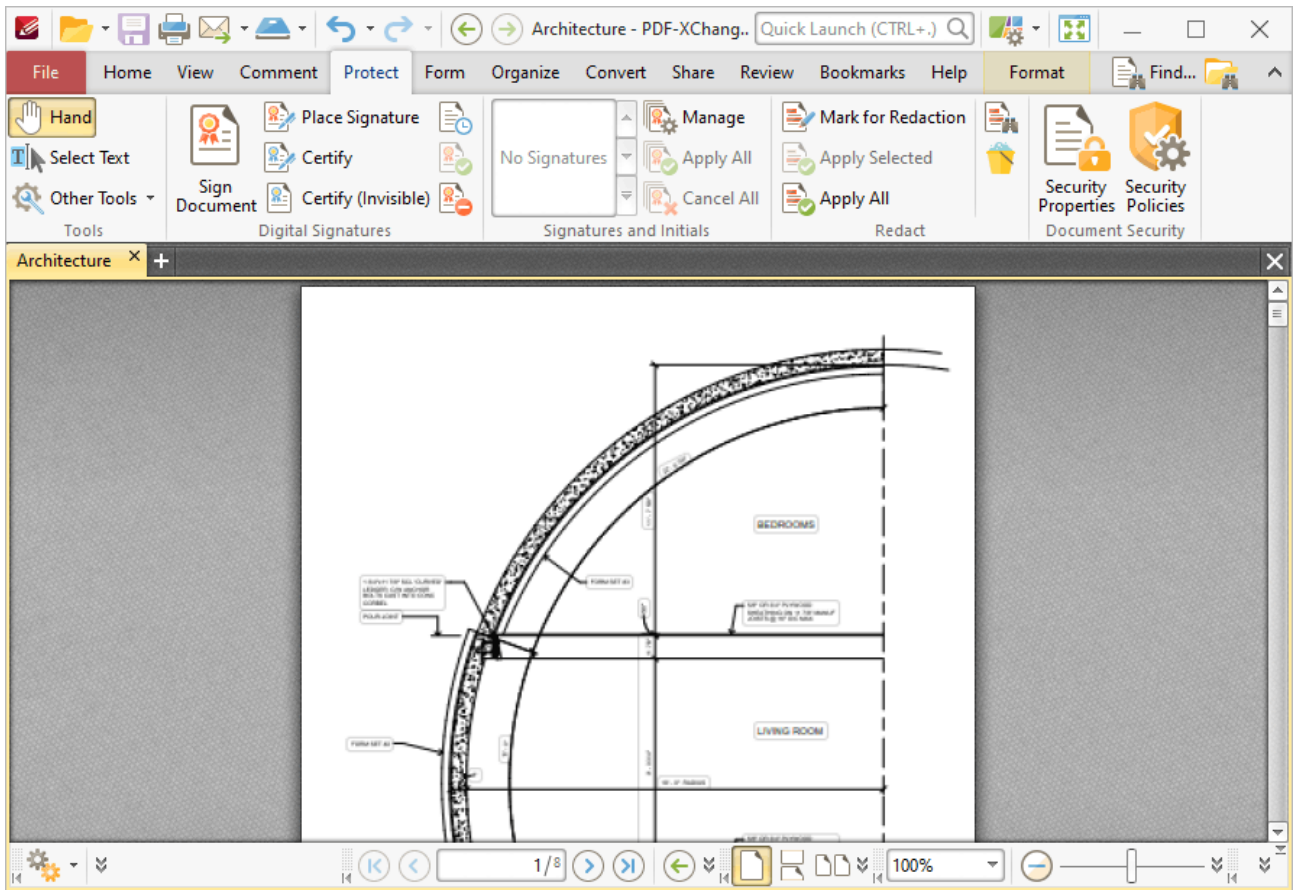
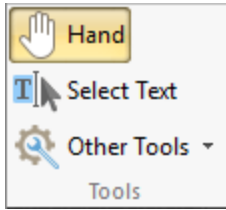

Figure 1. Protect Tab

The options in this tab are used to enhance/edit document security. There are five groups in the **Protect** tab:

**Tools**

The **Tools** group contains shortcuts to tools and other features:



- The **Hand Tool** is used as a basic scrolling device and navigation aid when browsing through documents. Click to enable the **Hand Tool**, then click and drag the page in the desired scrolling direction in order to browse through documents. Further information about the **Hand Tool** and its settings is available [here](#).<sup>943</sup>
- The **Select Text Tool** is used to select base-content text. Click to enable the **Select Text Tool**, then click and drag the pointer to select text. Double-click to select words, triple-click to select paragraphs and quadruple-click to select all text on the current page. Right-click selections for editing options, as detailed [here](#).<sup>1651</sup>
- Click the **Other Tools** dropdown menu to view/select additional tool options:
  - The **Select Comments Tool** is used to select and edit comments. Click to enable the **Select Comments Tool**, then click to select comments. Click and drag to select multiple comments. Selected comments can be edited, as detailed [here](#).<sup>1087</sup>
  - The **Snapshot Tool** is used to take screenshots of pages/selected page content. Click to enable the **Snapshot Tool**, then click or click and drag to take snapshots. Further information about this tool is available [here](#).<sup>926</sup>
  - The options in the **Clipboard** dropdown menu is used to interact with the current content of the clipboard. Click the dropdown menu to cut/copy/paste clipboard content.
  - The **Find** feature is used to [Find](#)<sup>1688</sup> or [Search](#)<sup>1776</sup> text, or to search the internet for text selected with the **Select Text Tool** in the current document.

## Digital Signatures

The **Digital Signatures** group contains options and adding and interacting with digital signatures:

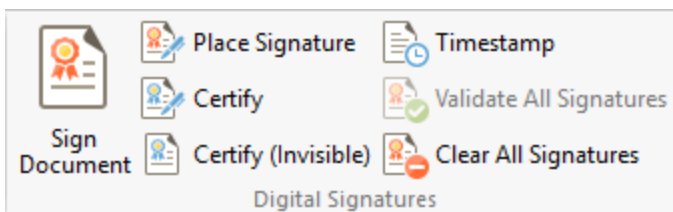

- Click **Sign Document** to sign an existing signature field in the current document. If more than one signature field is present then it is necessary to select the desired field. If there are no existing signature fields then the pointer will become a blue rectangle. Move the rectangle to the desired location then click to add a new signature field. These operations are detailed [here](#).<sup>1248</sup>

- Click **Place Signature** to create and sign a digital signature field in one step. The pointer will become a blue rectangle. This rectangle represents the new signature field. Move it to the desired location and then click to add it to the document. The **Sign Document** dialog box will open and can be used to customize digital signatures, as detailed [here](#).<sup>1246</sup>
- Click **Certify** to certify documents and add a physical signature. This process is identical to the **Sign Document** process detailed above. However, it is only possible to certify documents a single time, whereas it is possible to digitally sign documents multiple times.
- Click **Certify (Invisible)** to certify documents and add an invisible signature. This process is identical to the **Certify (Visible)** process detailed above, but the physical signature is excluded from the process.
- Click **Timestamp** to timestamp documents, as detailed [here](#).<sup>1253</sup>
- Click **Validate All Signatures** to validate all signatures in the current document.
- Click **Clear all Signatures** to remove signatures from signature fields.

## Signatures and Initials

The **Signatures and Initials** group is used to select and manage physical signatures. Current signatures are displayed in the pane. Use the arrows to browse/select signatures. Click to select signatures, then click again to add them to documents. Signatures can be edited as normal content items until the **Apply All** option detailed below is used.



- Click **Manage** to manage signatures. The **Manage Signatures and Initials** dialog box will open, which is detailed [here](#).<sup>1255</sup>
- Click **Apply All** to apply signatures that have been added to the document. Signatures are flattened to base content when this option is used.
- Click **Cancel All** to remove signatures that have been added to the document but have not been applied.

## Redact

The **Redact** group is used to mark document content for redaction and perform the redaction operation:

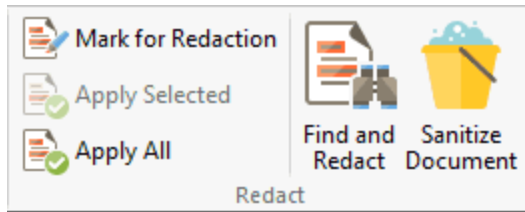

- Click **Mark for Redaction** to mark the document areas to be redacted.
- Click **Apply Selected** to apply redaction to the marked redaction area in cases where multiple areas have been marked.
- Click **Apply All** to apply redaction to all areas marked for redaction.
- Click **Find and Redact** to locate specific words or patterns (phone numbers, credit card numbers, social security numbers, emails or dates) in documents and either mark them for redaction or perform redaction on them immediately, as detailed [here](#).<sup>1257</sup>
- Click **Sanitize Document** to sanitize the current document, as detailed [here](#).<sup>1263</sup>

Further information about the **Redaction** feature is available [here](#).<sup>1257</sup>

## Document Security

The **Document Security** group contains options for viewing/editing document security:



- Click **Security Properties** to view/edit document security properties, as detailed [here](#).<sup>845</sup>
- Click **Security Policies** to view/manage security policies, as detailed [here](#).<sup>845</sup>

## 10.4.5.1 Digital Signature Options



## Digital Signature Options

Use the options in the **Digital Signatures** group to perform operations that relate to digital signatures:

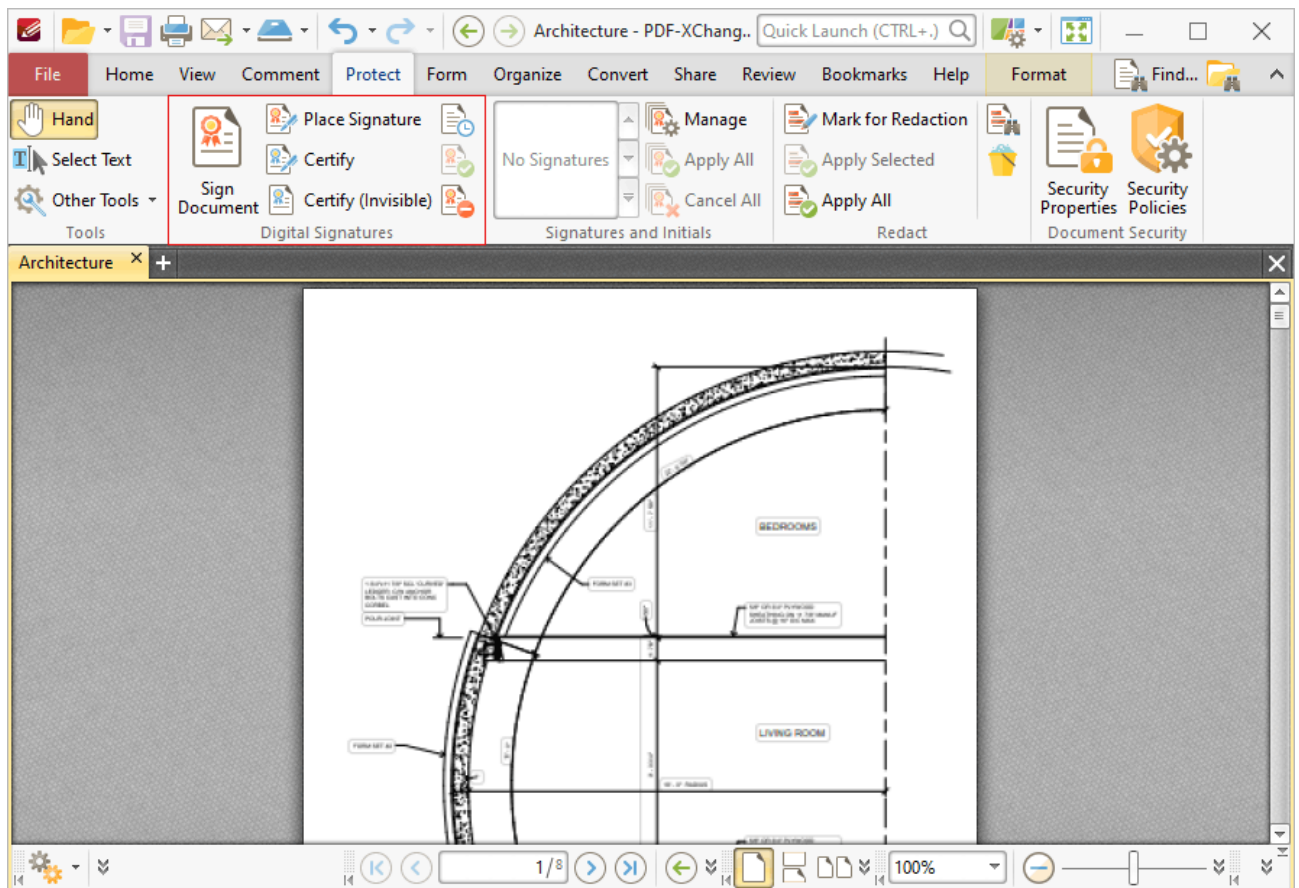

Figure 1. Protect Tab, Digital Signatures Group

Digital signatures are used to demonstrate the authenticity of documents and increase their security. They can also be used to determine editing permissions for documents, and to add timestamp server verification to documents. The **Form** <sup>1265</sup> tab can be used to add digital signature fields to documents. Digital signatures utilize a digital ID in order to operate. Digital IDs are used to create digital signatures and to decrypt documents that have been encrypted for the owner. They contain the information detailed in **(figure 3)** below, as well as two keys: the *public* key and the *private* key. The



public key contains the information about its owner, and can be shared by the owner in order for a recipient to encrypt information that is intended only for the owner to view. The public key can also be used to validate the digital signature of the owner. The private key is used to create/apply digital signatures, and to decrypt documents that have been encrypted via certificate security.

## Sign Document

Click **Sign Document** to sign existing signature fields. The dialog box detailed in **(figure 2)** will open. If more than one signature field is present then it is necessary to select the desired field. If there are no existing signature fields then the pointer will transform into a blue rectangle. This represents a new signature field. Place it at the desired location in the document and then click to create the signature field. The following dialog box will open:

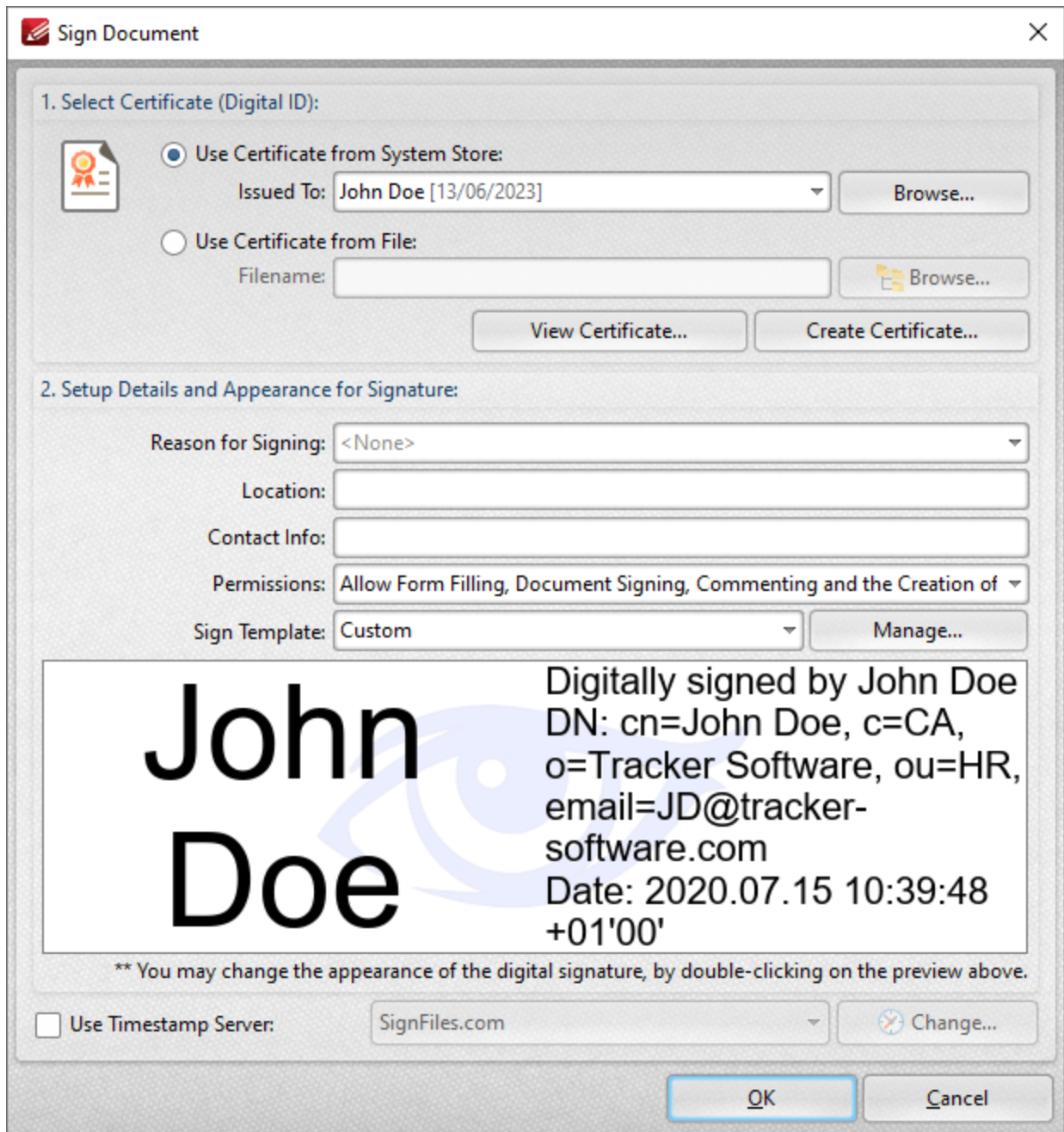

Figure 2. Sign Document Dialog Box

- Select a certificate from the system store or the local computer.
- Click **View Certificate** to view details about the selected certificate.
- Click **Create Certificate** to create a new certificate. The dialog box displayed in (**figure 3**) will open.
- Click the **Reason for Signing** menu, or enter text into the box manually, to add a reason for signing the document.
- Click the **Location** box to enter a location as desired.
- Click the **Contact Info** box to add contact information to the signature.

- Click the **Permissions** box to determine the changes that are permitted after the document has been signed.
- Click the **Sign Template** menu to select layout options for the signature and associated information.
- Click **Manage** to further customize the **Sign Template**.
- Select the **Use Timestamp Server** box to select a timestamp server to add to the signature, then select a timestamp server from the dropdown menu. Click **Change** to view/edit the details of the timestamp server used.

Click **OK** to add the digital signature to the document.

### Creating Digital Certificates

The following dialog box is used to create digital certificates:

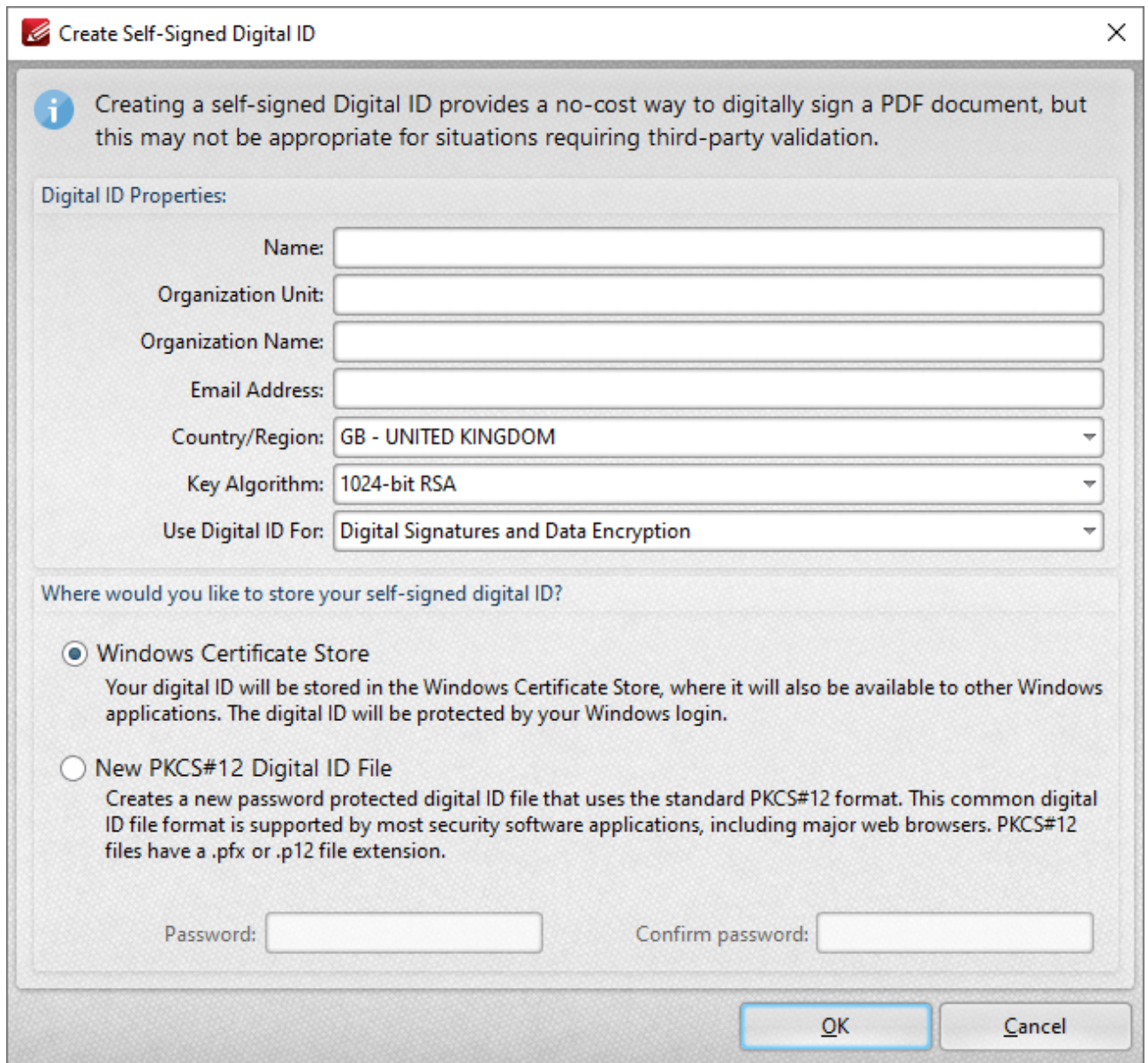

Figure 3. Create Self-Signed Digital ID Dialog Box

- Enter the desired user information in **Name**, **Organization** and **Email** text boxes.
- Use the **Country/Region** dropdown menu to enter the nationality of the owner of the digital certificate.
- Select either **1024-bit RSA** or **2048-bit RSA** as the key algorithm. **1024-bit RSA** is more universally compatible than **2048-bit RSA**, but **2048-bit RSA** offers more security.
- Select a storage location for the digital certificate. If the **PKCS#12** option is used then enter and confirm a password in the **Password** text boxes.

Click **OK** to create the digital certificate. It will then be available in the **Use Certificate from System Store** dropdown menu detailed in (figure 2).

## Place Signature

Click **Place Signature** to create and sign a digital signature field in one step. A blue rectangle will appear beneath the pointer. This rectangle represents the new signature field. Move it to the desired location and then click to add it to the document. The **Sign Document** dialog box will open. Follow the instructions as detailed beneath (*figure 2*).

## Certify (Visible) and (Invisible)

Click **Certify (Visible)** to certify documents and add a visible signature. This process is identical to the **Sign Document** process detailed above. However, it is only possible to certify documents a single time, whereas it is possible to digitally sign documents multiple times.

Click **Certify (Invisible)** to certify documents and add an invisible signature. This process is identical to the **Certify (Visible)** process detailed above, but the physical signature is excluded from the process.

## Timestamp

Click **Timestamp** to add timestamps to documents. The following dialog box will open:

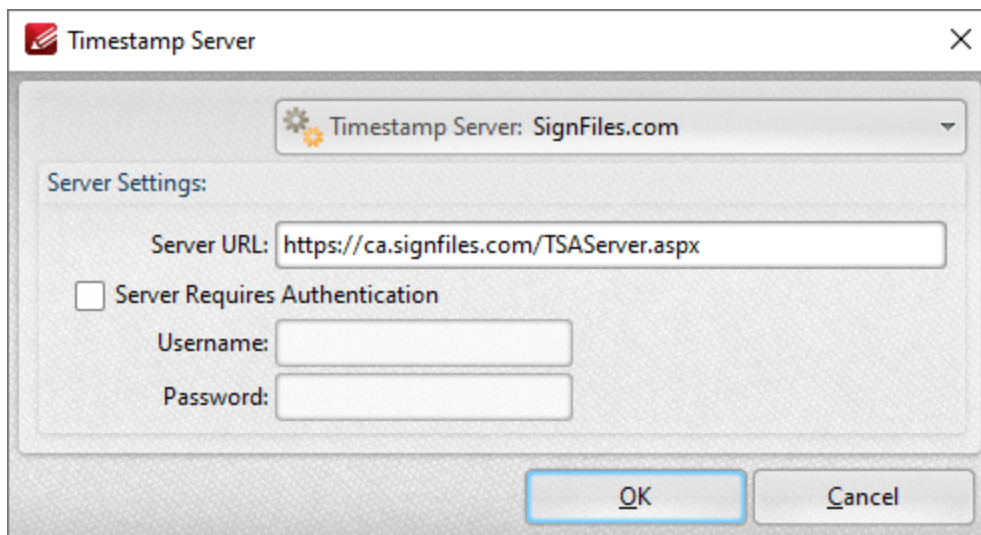

Figure 4. Timestamp Server Dialog Box

Timestamps are used to ensure the long-term preservation of digital signatures, time-seal date objects (to prove when they were received), protect copyrights/intellectual property and provide notarization services.

- Use the **Timestamp Server** dropdown menu to select a timestamp server.
- If a timestamp server is being used for the first time then enter the website address in the **Server URL** text box.

- If the selected timestamp server requires authentication then select the indicated box and enter the **User Name** and **Password** in the associated text boxes.

Click **OK** to timestamp documents.

### **Validate All Signatures**

Click **Validate All Signatures** to validate all document signatures. (Please note that the default settings of the computer on which the files are viewed may result in this happening automatically when documents are opened).

### **Clear all Signatures**

Click **Clear All Signatures** to clear all digital signatures/certificates from signature fields. Please note that this process does not remove the signature field itself. The [Select Fields](#)<sup>1265</sup> feature is used for this purpose.

Please note that when digital signatures have been applied to documents and need to be subsequently verified it is necessary to have the incremental save feature enabled. This feature can be enabled/disabled using the **Documents** settings of the **Preferences** tab, as detailed [here](#).<sup>857</sup>

---

## 10.4.5.2 Signatures and Initials



## Signatures and Initials

Use the options in the **Signatures and Initials** group to view customized signatures/initials and manage, apply or cancel current signatures/initials:

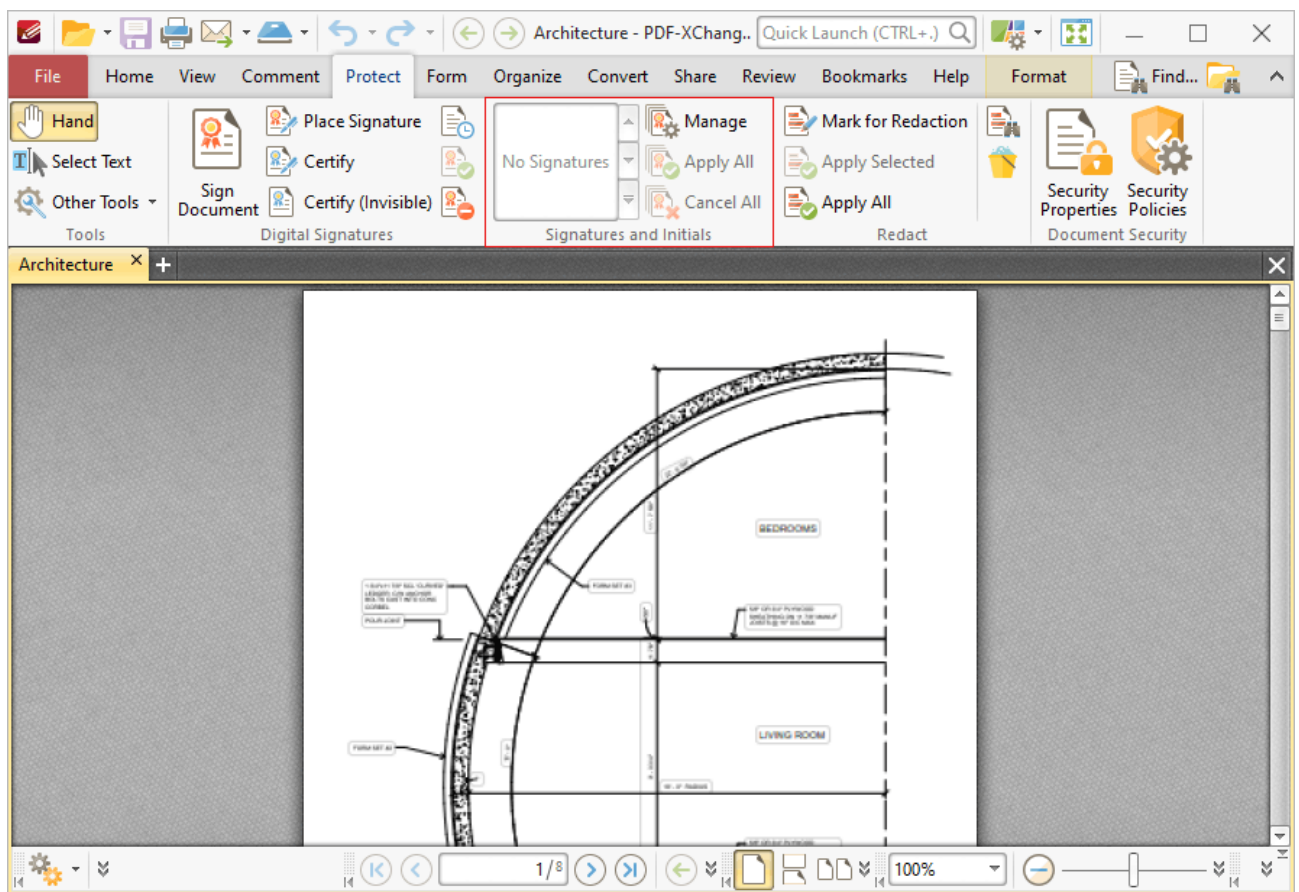

Figure 1. Protect Tab, Signatures and Initials Group

- Available signatures are displayed in the pane. Click to select signatures, then click again to add them to the document. They can then be resized and/or repositioned as detailed [here](#).
- Click **Manage** to manage signatures. The dialog box detailed in **(figure 2)** will open.
- Click **Apply All Signatures** to apply all placed signatures to the document. This process converts signatures from editable objects into base content of documents.

- Click **Cancel All Signatures** to remove signatures that have been placed in documents. (This action will not remove signatures that have been applied. The **Undo** action in the [Quick Access](#) toolbar can be used to remove applied signatures).

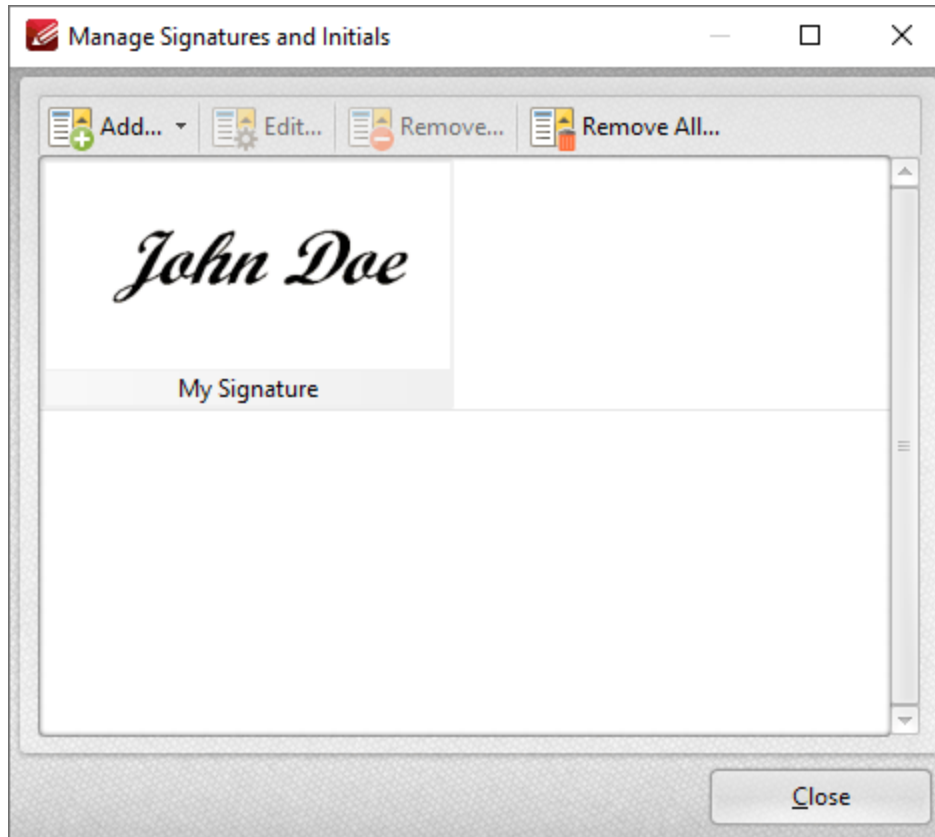

Figure 2. Manage Signatures and Initials Dialog Box

- Click **Add** to add new signatures/initials to the list of available options, then click **Import from File** or **Draw Signature** as desired.
- Click **Edit** to edit selected signatures. The **Edit Signatures/Initials Information** dialog box will open. Update the signature name/password as desired then click **OK**.
- Click **Remove** to remove selected signatures, or **Remove All** to remove all signatures.



10.4.5.3 Redaction and Sanitization



Redaction and Sanitization

Use the options in the **Redact** group to perform redaction or sanitization on the current document:

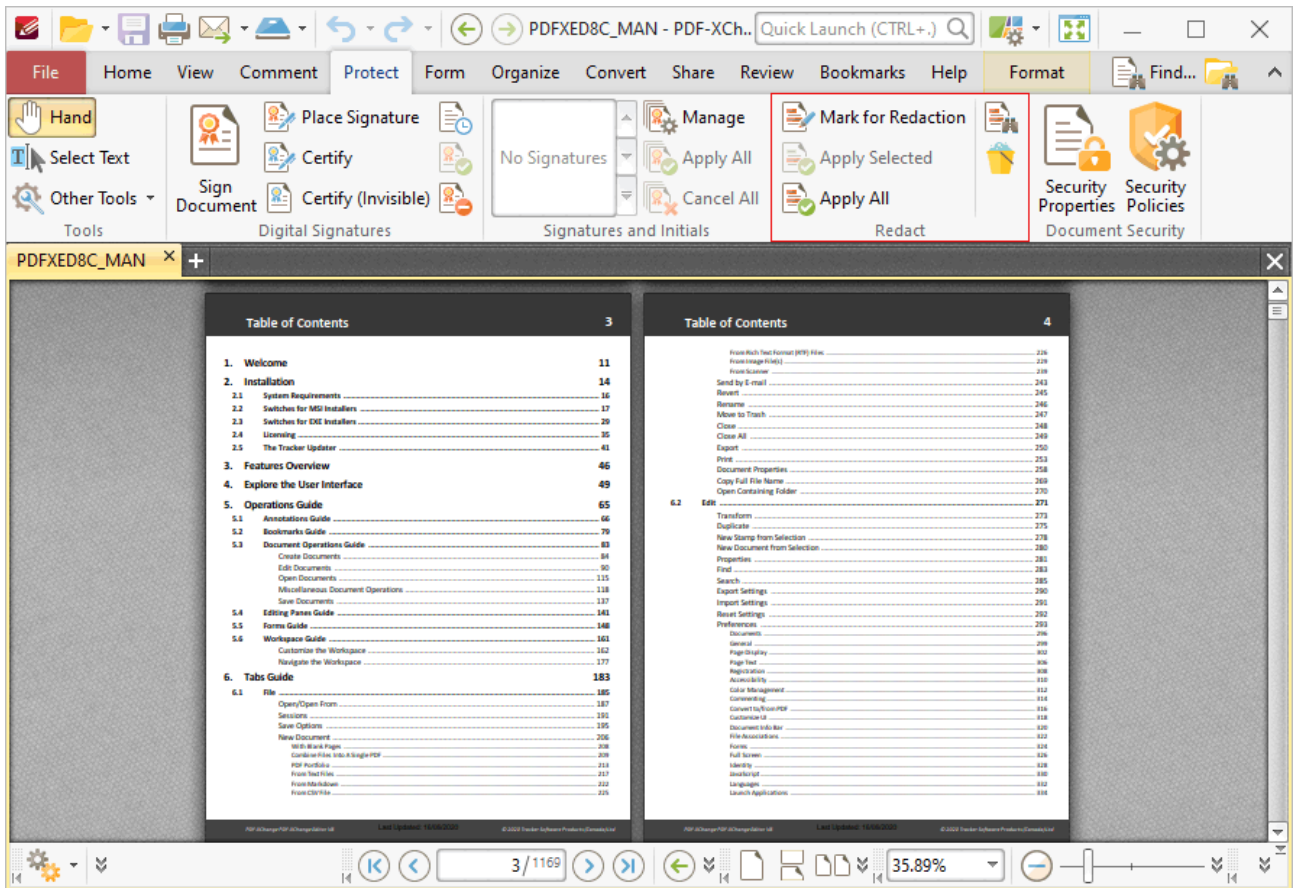

Figure 1. Protect Tab, Redact Group

Redaction "blacks out" designated document content. Click **Mark for Redaction** to determine sections of the document for redaction. The pointer will become a crosshairs icon. Click and drag to determine areas for redaction:

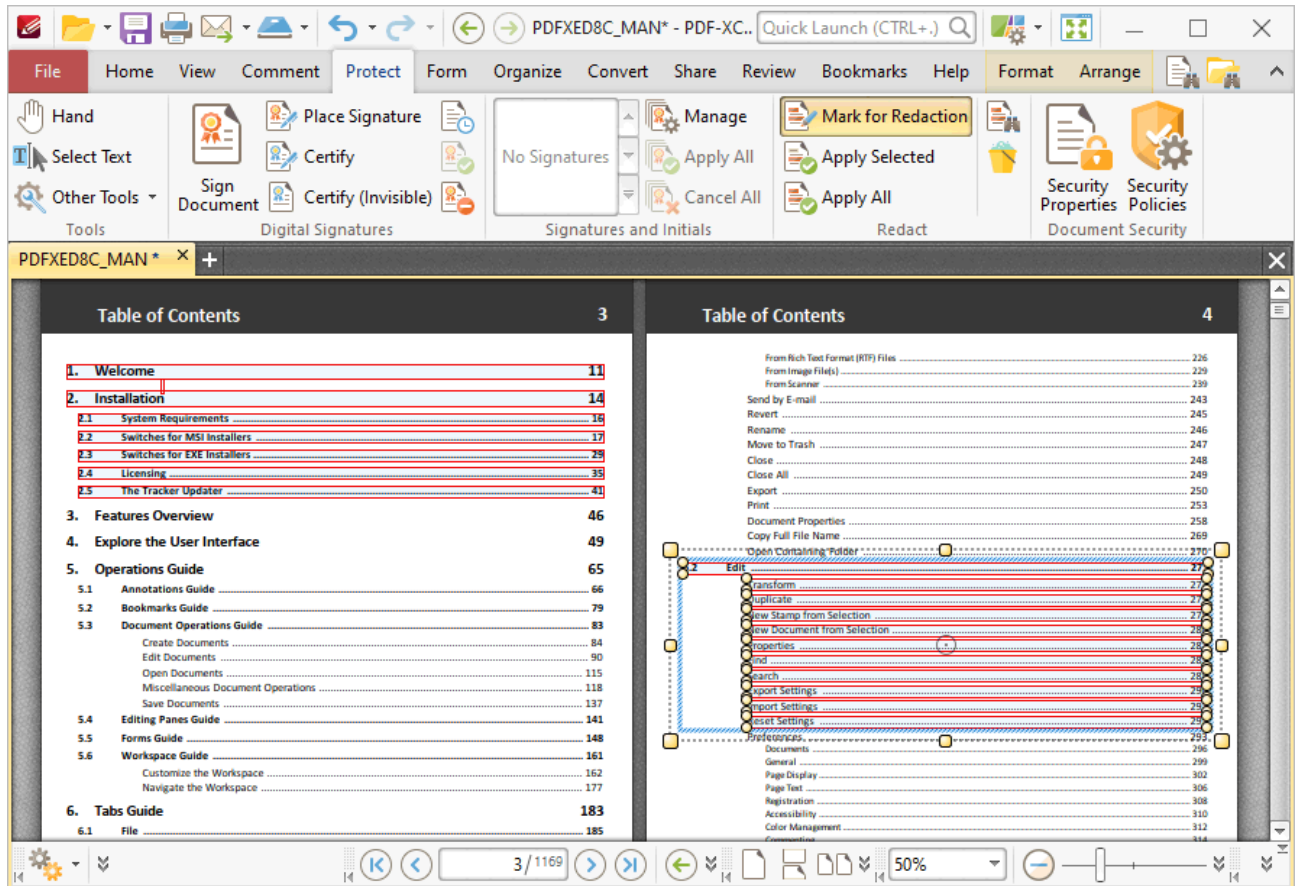

Figure 2. Areas Marked for Redaction

The area on the right has just been determined, which means editing options are available:

- Use the control points to resize areas.
- Use the editing aids detailed [here](#)<sup>1075</sup> to assist in the precise placement of areas marked for redaction.
- Click and drag areas to reposition them.
- Right-click areas for further options:
  - Click **Apply All** to redact all areas marked for redaction.
  - Click **Apply Selected** to redact only selected areas. (The [Select Comments Tool](#)<sup>1087</sup> can be used to select multiple areas).
  - See [here](#)<sup>1783</sup> for an explanation of the remaining options.

Click **Apply All** to perform the redaction. Marked areas will be replaced with black fill:

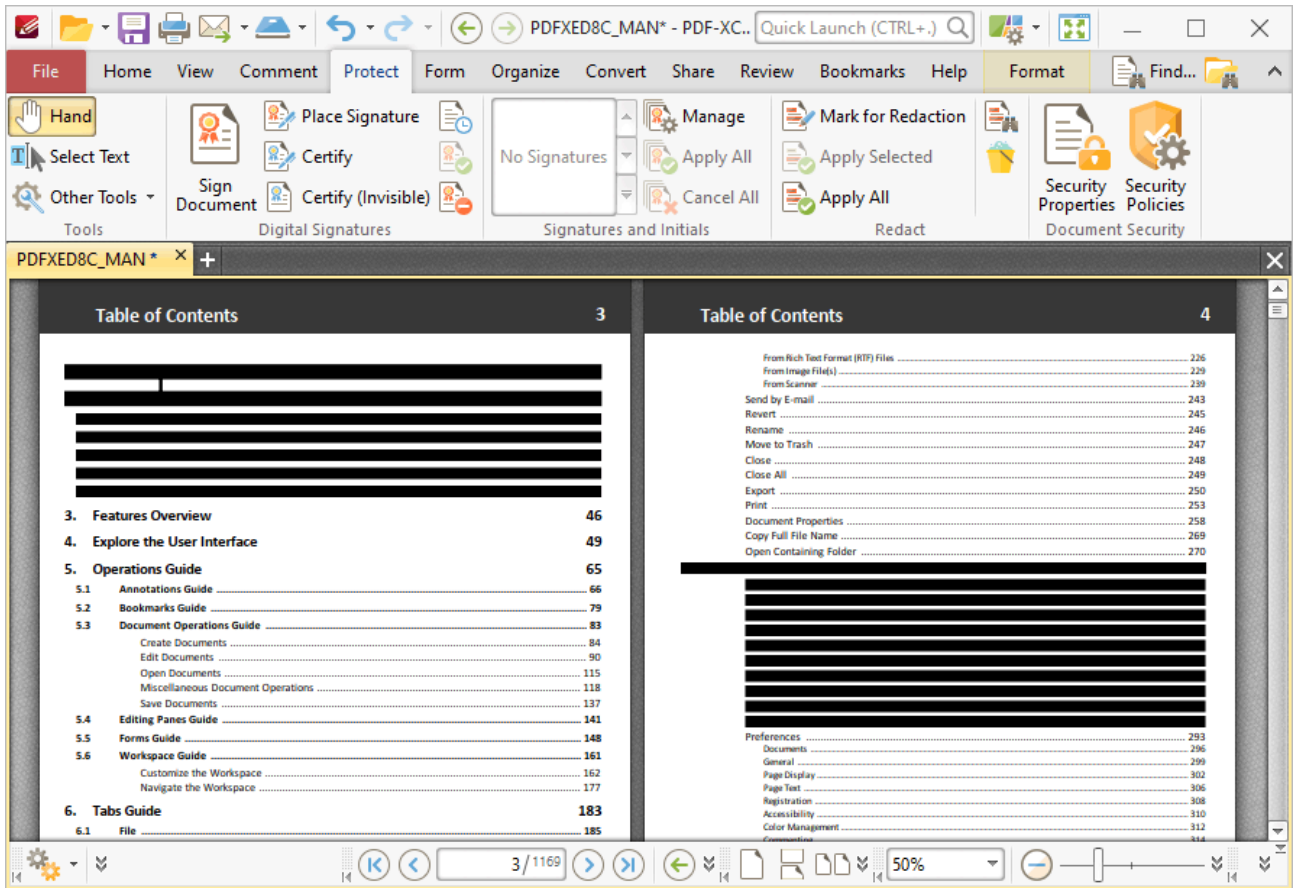

Figure 3. Redacted Areas

Note that the **Format** tab is enabled when the **Redaction** feature is in use. Use the commands in this tab to customize the style and properties of redactions:

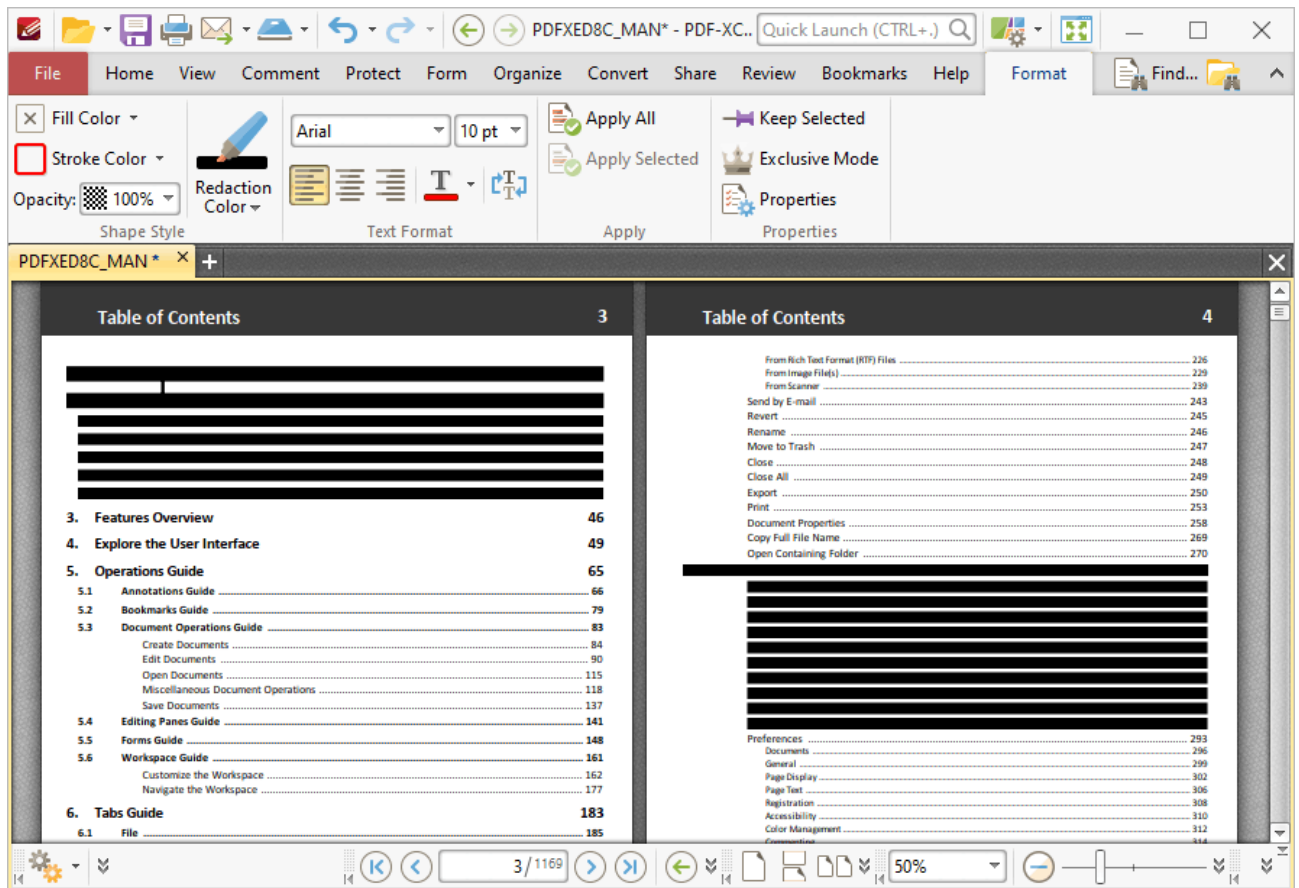

Figure 4. Format Tab, Redaction Tool, Redaction Properties Pane Enabled

- Use the **Fill Color** dropdown menu to determine the color of areas marked for redaction.
- Use the **Stroke Color** dropdown menu to determine the border color of areas marked for redaction.
- Use the **Opacity** dropdown menu to determine the level of transparency in areas marked for redaction.
- **Keep Selected** determines whether or not the **Redaction** feature remains selected after a single area has been marked for redaction. If this setting is enabled then the tool will remain selected and can be used to create areas consecutively. If this setting is not enabled then **PDF-XChange Editor** will revert to the designated default tool immediately after a single area is marked
- **Exclusive Mode** simplifies the process of using the **Redaction** feature. When **Exclusive Mode** is enabled, the pointer ignores all interactive elements of documents other than base content. This makes it possible to mark areas for redaction without the risk of accidentally selecting undesired items. When **Exclusive Mode** is disabled, the pointer recognizes and interacts with all underlying elements in the usual manner.
- Use the **Redaction Color** dropdown menu to determine the color of redacted areas.
- Use the **Text Color** dropdown menu to determine the color of text used to overlay redacted areas when the text option is enabled. Use the **Text** property in the **Redaction Properties** pane to specify the text used.
- Use the **Font** combo box to determine the font used when the **Text** property is being used.

- Use the **Font Size** combo box to determine the font size when the **Text** property is being used.
- Use the **Align** options determine the alignment of text when the **Text** property is being used.
- Enable the **Repeat Overlay Text** option to repeats the text used within redacted areas when the **Text** property is being used.
- Click **Apply All** to apply all redactions marked in the current document.
- Click **Properties** to view/edit the **Redaction Properties** pane, as detailed in **(figure 4)**. Click to edit properties. Note that the options in the **Overlay** section apply to completed redactions.

## Find and Redact

Click **Find and Redact** to launch the **Find and Redact** feature:

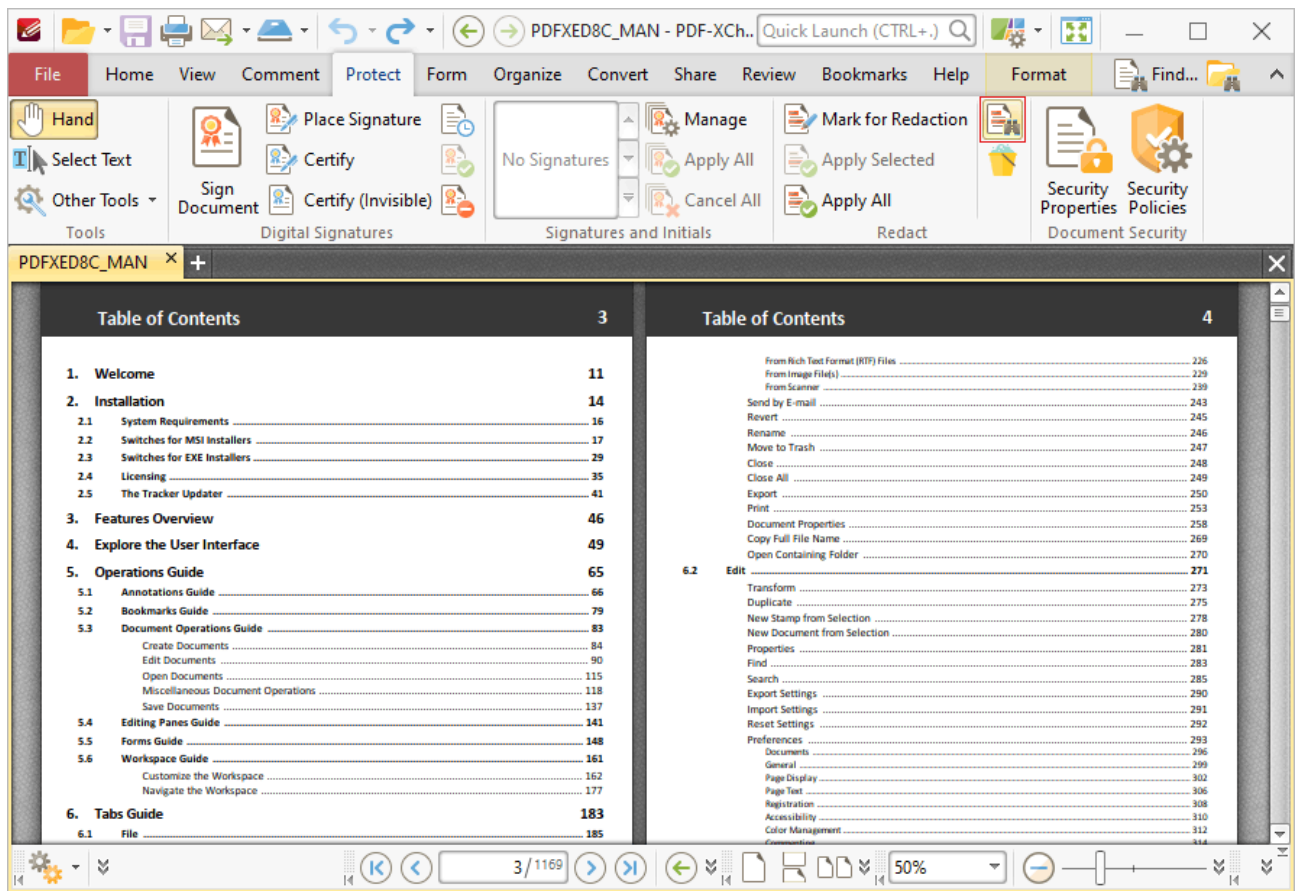

**Figure 5.** Protect Tab, Find and Redact Highlighted

This feature is used to search for specific words or patterns (phone numbers, credit card numbers, social security numbers, emails or dates) in documents and then either mark them for redaction or redact them immediately. When it is selected, the **Find and Redact Text** dialog box will open:

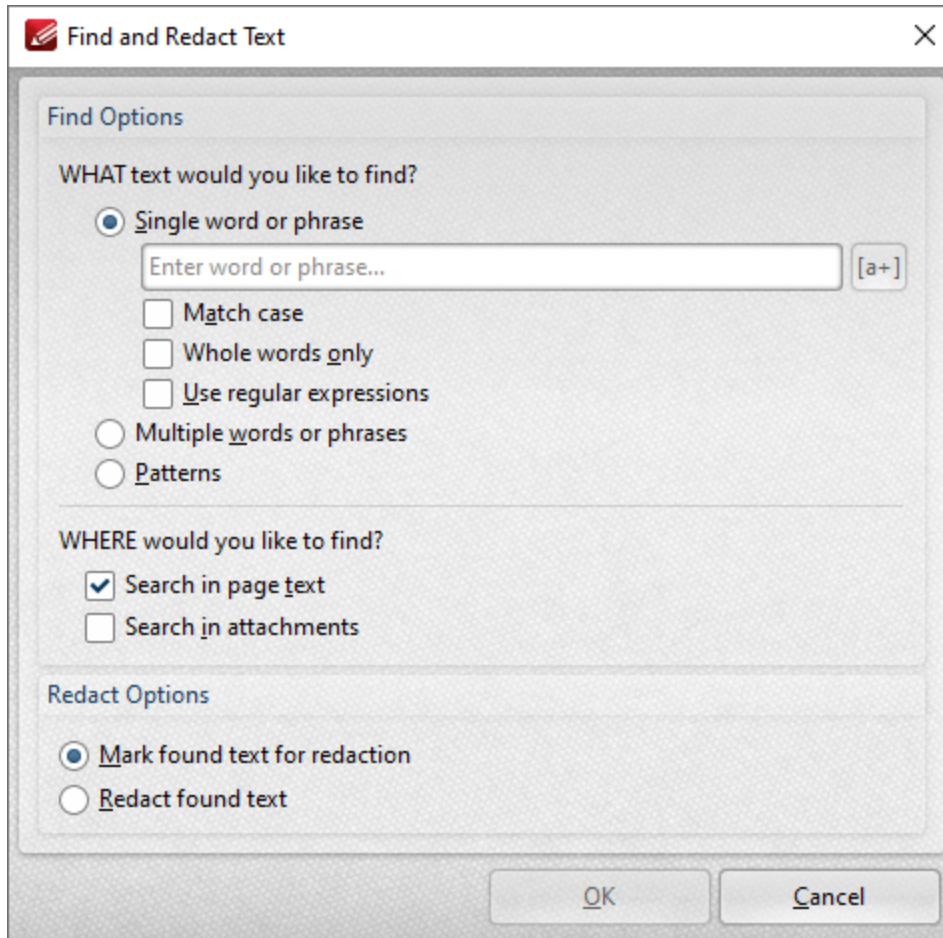

Figure 6. Find and Redact Text Dialog Box

- Select **Single word or phrase** to search for a single word/phrase, then enter the desired word/phrase in the text box.
  - Select the **Match Case** box to match the case of word entered in the text box.
  - Select the **Whole Words Only** box to match only whole words in the document to the word entered in the text box.
  - Select the **Use regular expressions** box to enable the use of ECMAScript syntax-based regular expressions in the search. Further information about regular expressions is available [here](#).
- Select **Multiple words or phrases** to search for multiple words/phrases. Click **Add/Remove** to add/remove words/phrases, then enter the desired words/phrases in the text box. Click **Save** to save the current word list to a plain text file for subsequent use. Click **Load** to load a plain text file of words into the text box.
- Select **Patterns** to search for specific patterns, then select either **Phone numbers, Credit cards, Social security numbers, Emails** or **Dates** to determine the patterns that you want to find.
  - Select an option in the **Locale** dropdown menu to determine the language used in the search.

- Click **Add** to add a custom pattern to the available search options. Enter the name, value and description of the custom pattern and click **OK** to save. The custom pattern will then be available in the list of patterns.
- Click **Remove** to remove selected custom patterns.
- Select the **Search in page text** box to search page text for the specified search terms.
- Select the **Search in attachments** box to search attachments to the current document for the specified search terms.
- Select **Mark found text for redaction** to mark search results for redaction.
- Select **Redact found text** to immediately redact search results.

Click **OK** to find and mark/redact content.

### Sanitize Document

Click **Sanitize Document** to remove sensitive information from documents:

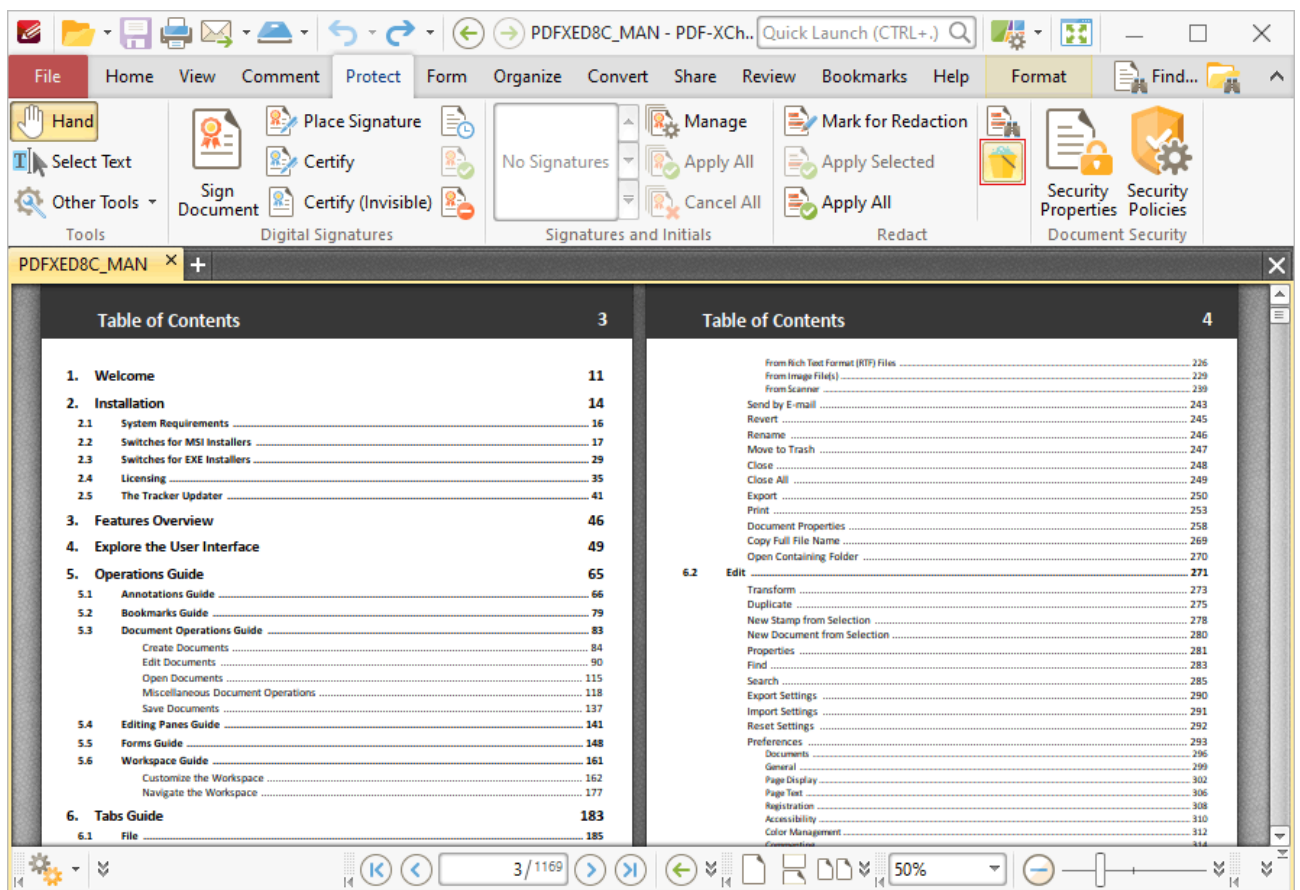
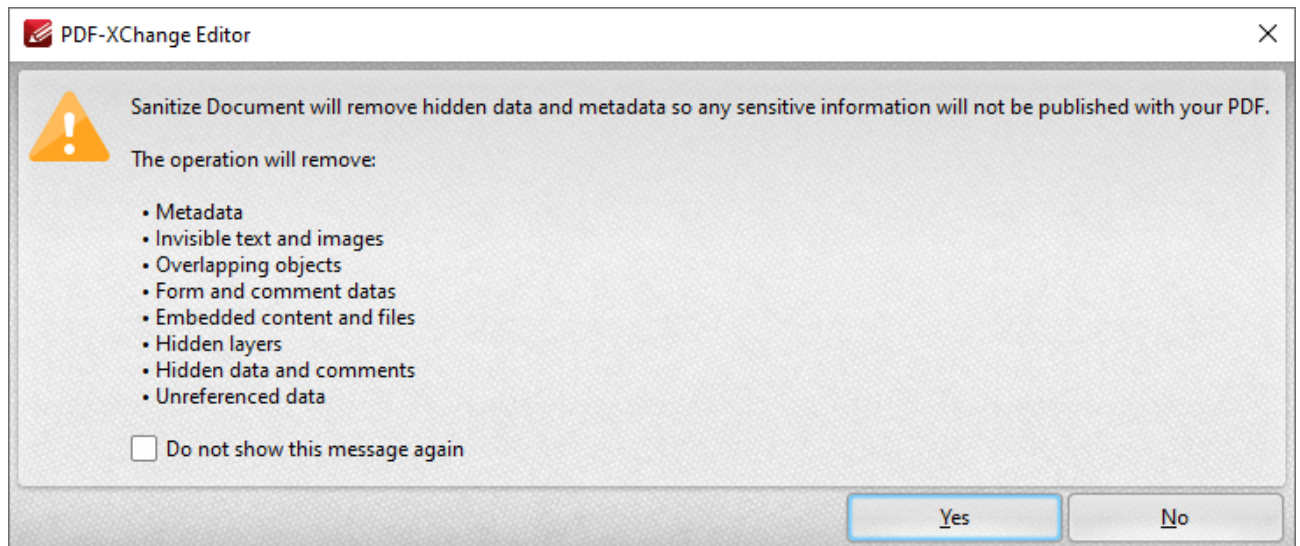

Figure 4. Document Tab Submenu, Redaction Options, Sanitize Document

The following dialog box will open:



**Figure 7.** PDF-XChange Editor Dialog Box

This dialog box details the document information that is removed when documents are sanitized.

Click **Yes** to sanitize documents.

---



10.4.6 Form Tab



**Form Tab**

When the **Form** tab is selected, the following options are available:

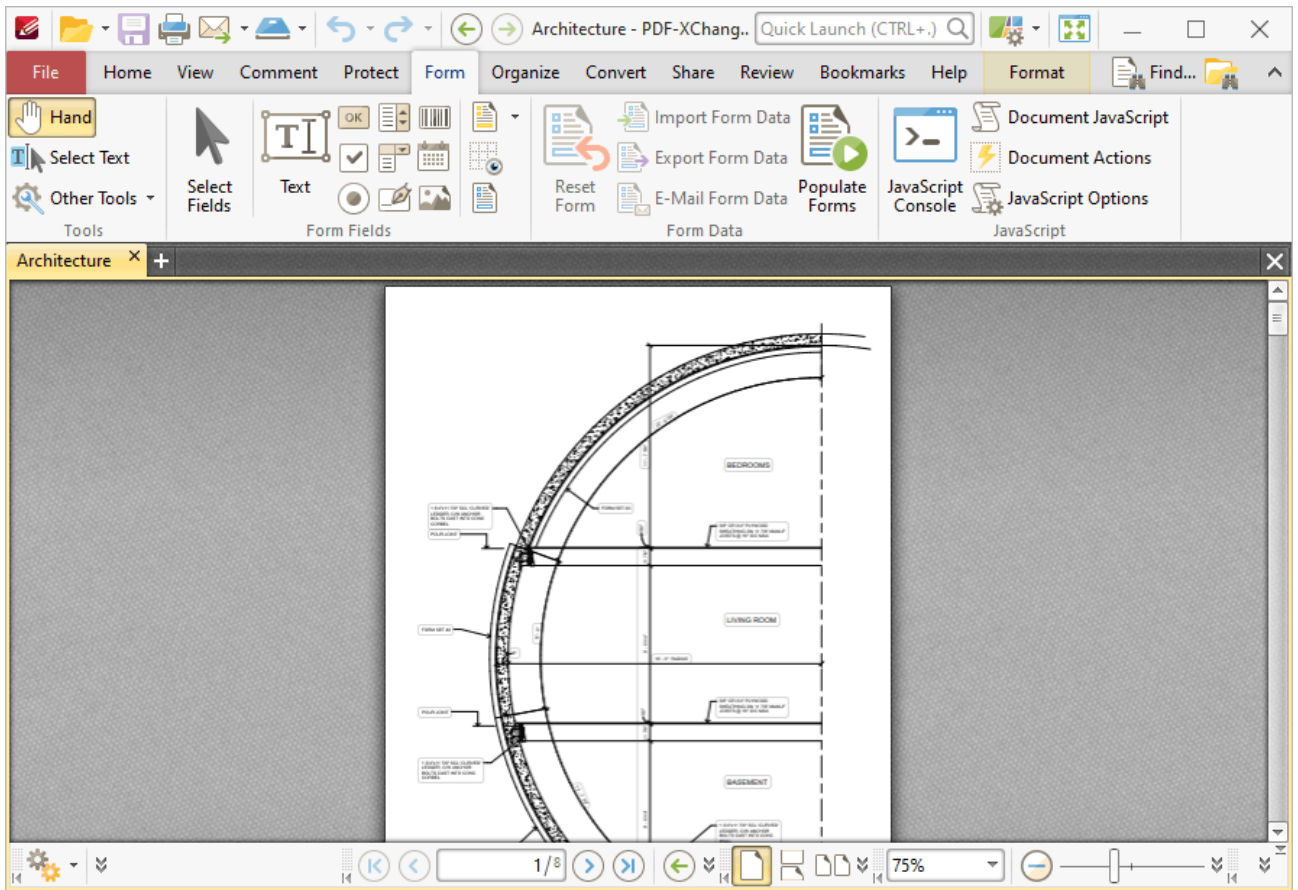
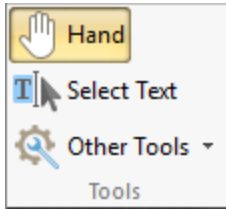

Figure 1. Form Tab

The options in the **Form** tab are used to create and edit form fields, form data, and JavaScript. There are four groups in the **Form** tab:

**Tools**

The **Tools** group contains shortcuts to tools and other features:







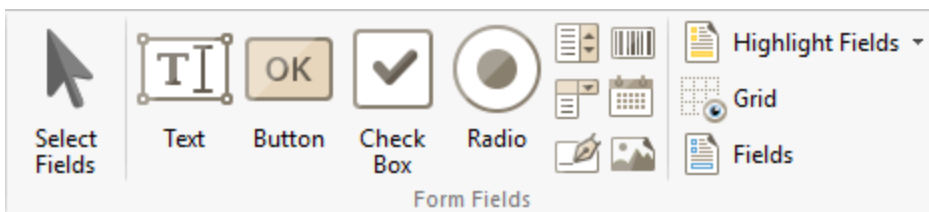

- The **Hand Tool** is used as a basic scrolling device and navigation aid when browsing through documents. Click to enable the **Hand Tool**, then click and drag the page in the desired scrolling direction in order to browse through documents. Further information about the **Hand Tool** and its settings is available [here](#).<sup>[943]</sup>
- The **Select Text Tool** is used to select base-content text. Click to enable the **Select Text Tool**, then click and drag the pointer to select text. Double-click to select words, triple-click to select paragraphs and quadruple-click to select all text on the current page. Right-click selections for editing options, as detailed [here](#).<sup>[1651]</sup>
- Click the **Other Tools** dropdown menu to view/select additional tool options:
  - The **Select Comments Tool** is used to select and edit comments. Click to enable the **Select Comments Tool**, then click to select comments. Click and drag to select multiple comments. Selected comments can be edited, as detailed [here](#).<sup>[1087]</sup>
  - The **Snapshot Tool** is used to take screenshots of pages/selected page content. Click to enable the **Snapshot Tool**, then click or click and drag to take snapshots. Further information about this tool is available [here](#).<sup>[926]</sup>
  - The options in the **Clipboard** dropdown menu is used to interact with the current content of the clipboard. Click the dropdown menu to cut/copy/paste clipboard content.
  - The **Find** feature is used to [Find](#)<sup>[1688]</sup> or [Search](#)<sup>[1776]</sup> text, or to search the internet for text selected with the **Select Text Tool** in the current document.

## Form Fields

The **Form Fields** group contains options for creating and editing form fields:



- Click **Select Fields** to select fields for editing or repositioning. Click a field to select it, or click and drag to reposition fields.
- Click **Text** to enable the **Text Field** feature, then click to add text fields. These fields are used to denote a space in which users can enter text, such as their address or credit card details. Further information and instructions for this feature are available [here](#).<sup>[1270]</sup>

- Click **Button** to enable the **Button** feature, then click to add buttons. Buttons allow users to trigger an event/action, such as opening a web link or playing a sound. Further information and instructions for this feature are available [here](#).<sup>1356</sup>
- Click **Check Box** to enable the **Check Box** feature, then click to add check boxes. Check boxes allow users to make a binary choice between mutually exclusive options, such as yes/no answers. Further information and instructions for this feature are available [here](#).<sup>1293</sup>
- Click **Radio** to enable the **Radio Button** feature, then click to add radio buttons. Radio buttons allow users to choose only one of a predefined set of options, such as when answering multiple choice questions. Further information and instructions for this feature are available [here](#).<sup>1305</sup>,<sup>1293</sup>
- Click  **List Box** to enable the **List Box** feature, then click to add list boxes. List boxes allow users to select one or more items from a list of options contained within a static, multiple line text box, such as a list of months of the year. Further information and instructions for this feature are available [here](#).<sup>1317</sup>
- Click  **Barcode** to enable the **Barcode** feature, then click to add barcodes. Barcodes translate form data into an encoded pattern that compatible devices can read and archive. Further information and instructions for this feature are available [here](#).<sup>1392</sup>
- Click  **Dropdown** to enable the **Dropdown** feature, then click to add dropdown menus. Dropdown menus allow users to select only one value from a list of options contained within a static, multiple line text box, such as a list of nationalities. Further information and instructions for this feature are available [here](#).<sup>1329</sup>
- Click  **Date** to enable the **Date** feature, then click to add date fields. These fields are a modified version of the **Text Fields** feature detailed above and feature date functionality by default.
- Click  **Digital Signature** to enable the **Digital Signature** feature, then click to add digital signature fields. These fields allow users to add digital signatures to documents. Further information and instructions for this feature are available [here](#).<sup>1374</sup>
- Click  **Image** to enable the **Image** feature, then click to add image fields. These fields are a modified version of the **Button** feature detailed above, and feature JavaScript by default that enables the insertion of images to be submitted as form data.
- Click **Highlight Fields** to highlight all form fields in the document. Alternatively, click the dropdown arrow to select manually which fields are highlighted.
- Click **Grid** to enable the grid feature, which is used to assist in the placement of form fields.
- Click **Fields** to show/hide the [Fields](#).<sup>1016</sup> pane, which displays a breakdown of form fields in the current document and can be used to edit fields.

## Form Data

The **Form Data** group contains options that are used to manipulate form data:

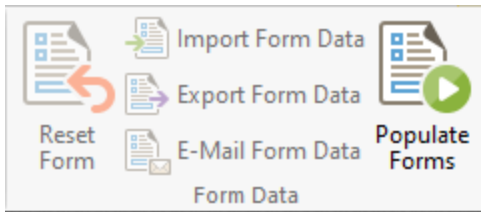

- Click **Reset Form** to reset all form fields in the current document.
- Click **Import Form Data** to import data into the forms of the current document. The **Open Files** dialog box will open. Select the desired file and click **OK** to import form data. Please note that the field names of forms must match in order for form data to be imported. For example, if there are three forms in the file from which data is imported that have the field names **'Text1'**, **'Text2'** and **'Text3'** respectively, then the current document must feature forms with the same field names in order for form data to import. The field name property can be viewed/edited in the **Properties** pane for forms, as detailed [here](#).<sup>1274</sup>
- Click **Export Form Data** to export all data from the forms of the current document. The **Save File** dialog box will open. Enter a name for the new file in the text box, then select a file format from the **Save as type** dropdown menu and click **Save** to export the form data.
- Click **Email Form Data** to email the current document form data. The **PDF-XChange Editor** dialog box will open. Select the desired file format and then click **OK** to email the form data. **PDF-XChange Editor** will use the current email method as defined in the [Send Mail](#)<sup>919</sup> preferences to email the form data. Please note that only the form data is sent, and not the form itself. Recipients of these emails can use the **Import Form Data** option detailed above to import the form data.
- Click **Populate Forms** to fill forms using data from a (\*.csv) file, as detailed [here](#).<sup>1431</sup>

## JavaScript

The **JavaScript** group contains options that are used to edit JavaScript in the current document:

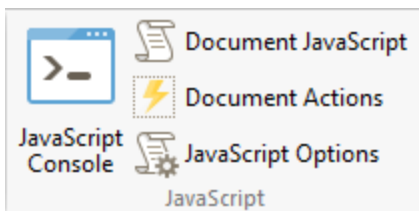

- Click **JavaScript Console** to open the **JavaScript Console**, which is used to add JavaScript to documents. This feature is detailed [here](#).<sup>1429</sup>
- Click **Document JavaScript** to open the **JavaScript** category of the **Document Properties** dialog box, which can be used to create, edit or delete JavaScript, as detailed [here](#).<sup>853</sup>
- Click **Document Actions** to open the **Actions** category of the **Document Properties** dialog box, which can be used to enable JavaScript actions when documents close, save or print, as detailed [here](#).<sup>852</sup>



10.4.6.1 Add Text Fields to Documents



Add Text Fields to Documents

Text fields are used to denote a space in which users can enter form information such as their name, password and date of birth:

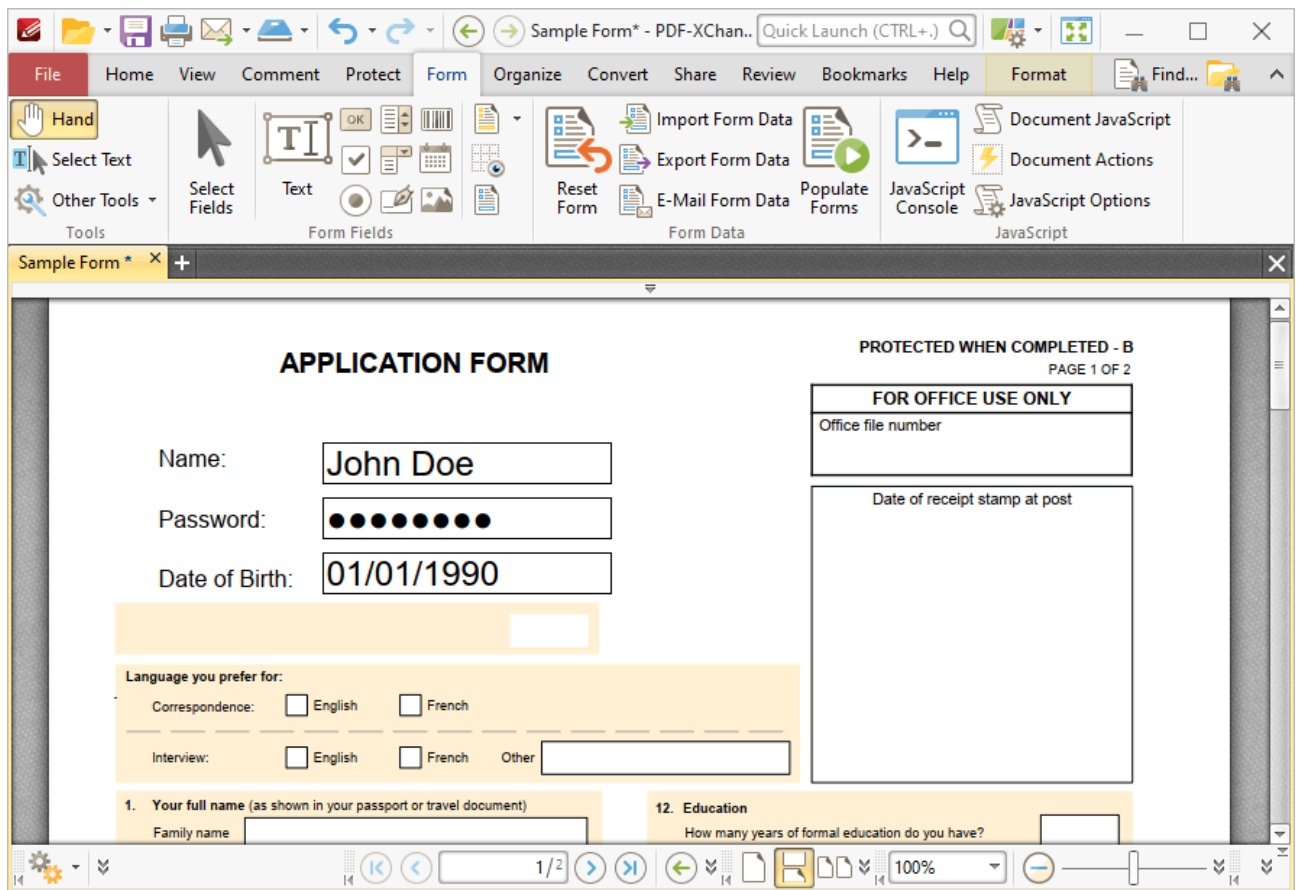

Figure 1. Example Text Fields

The functionality of **PDF-XChange Editor** enables a wide range of dynamic customization for text fields. Click the dropdowns below for further information:

▼ Add Text Fields to Documents

1. Click the **Form Tab**, then click the **Text Field** icon. A blue rectangle will be displayed beneath the pointer. This rectangle represents the text field:

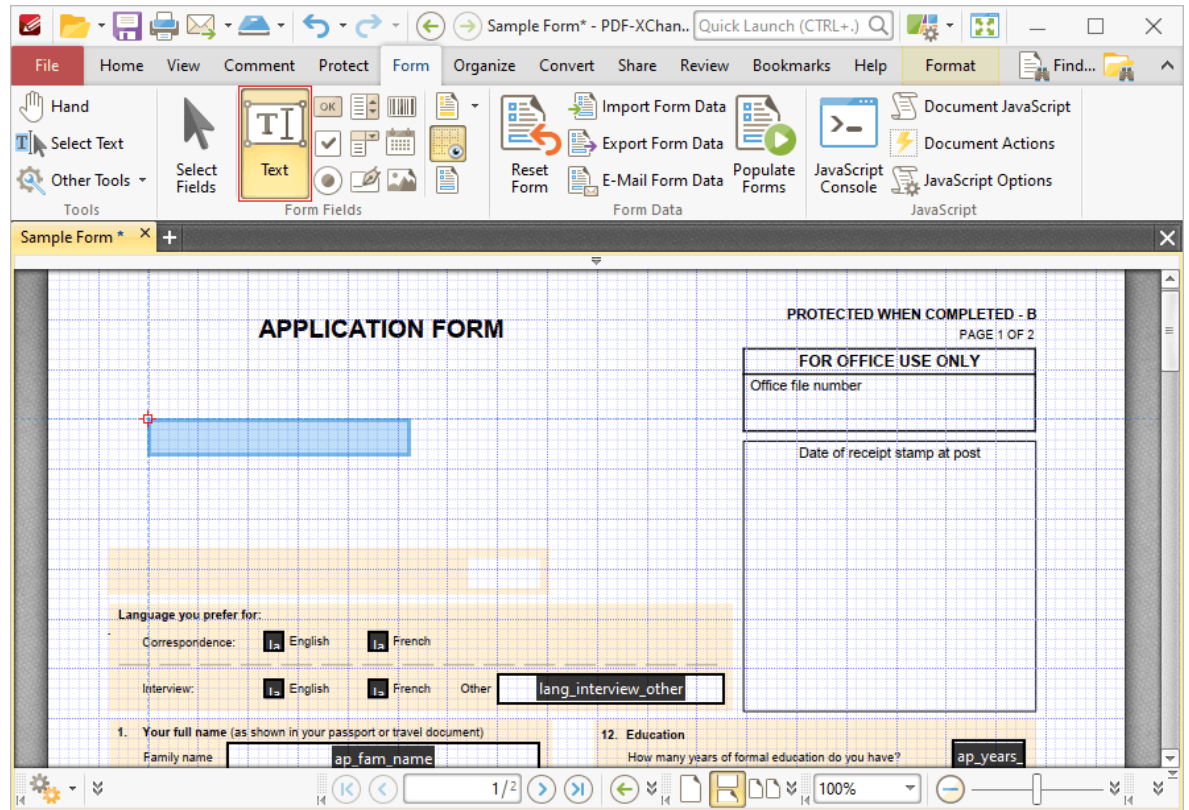

Figure 2. Active Text Field Tool

2. Move the rectangle to the desired location and then click to add the text field to the document. Added text fields appear as detailed below:

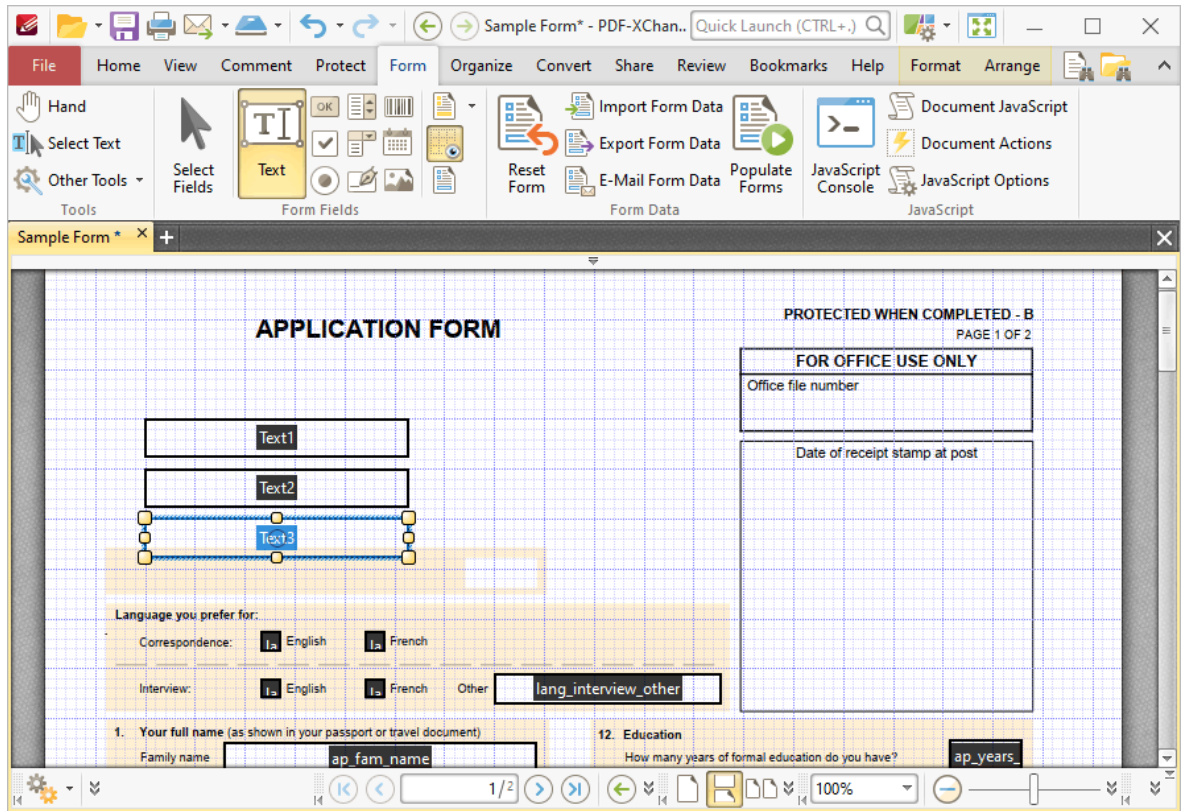

Figure 3. Added Text Fields

- Click and drag the yellow control points to resize text fields.
- Use the options in the **Format Tab** to determine the style and appearance of selected text fields:



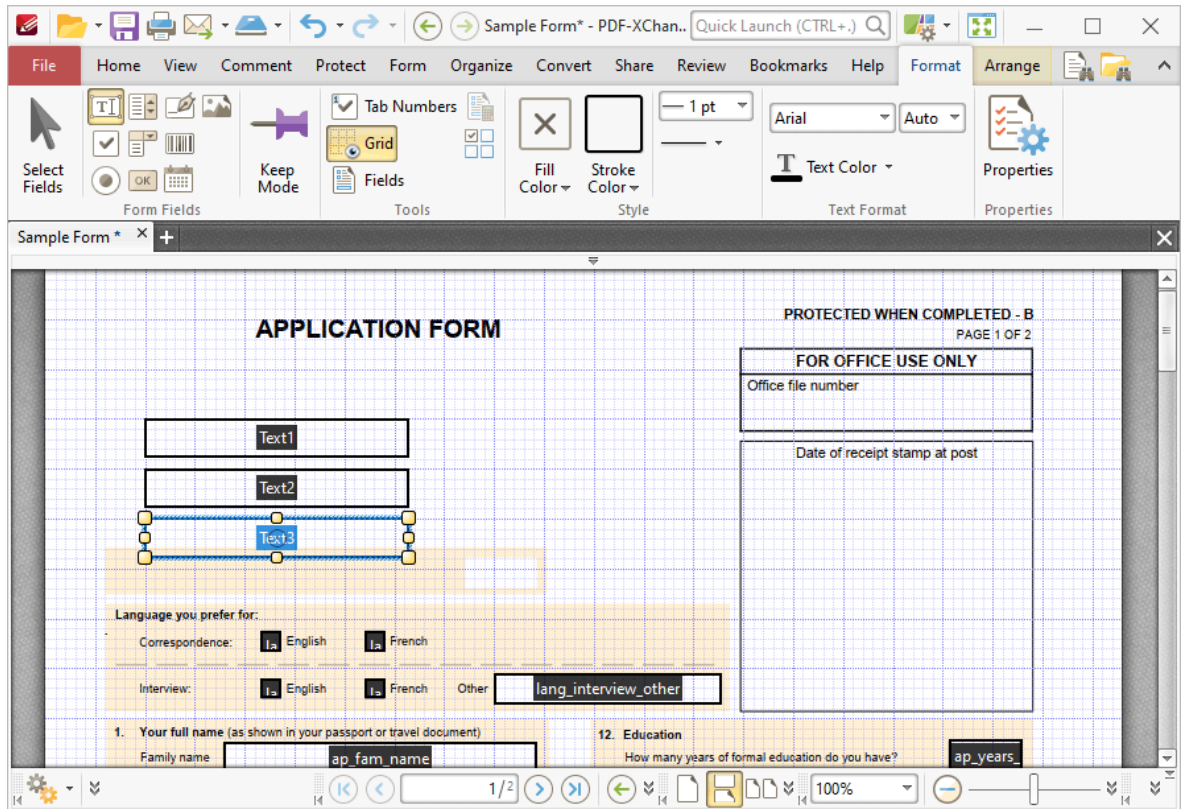

Figure 4. Format Tab, Text Field Forms

- Click **Select Fields** to select and edit form fields.
- Click the options in the **Form Fields** group to enable alternative form field formats.
- Click **Keep Mode** to create multiple text fields consecutively. If this option is disabled then **PDF-XChange Editor** will revert to the designated default tool after the creation of a single text field.
- Click **Tab Numbers** to show/hide the tab order numbers of form fields.
- Click **Calculation Order** to show/hide the order in which calculations are performed when there is more than one form field that contains a value calculation. Further information about value calculations is detailed below.
- Click **Grid** to enable/disable the grid, which is used to assist in the accurate placement of form fields, as detailed in **(figure 4)**.
- Click **Create Multiple Copies** to create multiple copies of selected form fields, as detailed [here](#).<sup>1437</sup>
- Click **Fields** to show/hide the **Fields**<sup>1016</sup> pane, which is used to view/edit form fields.
- Click **Fill Color** to determine the fill color of the text field.
- Click **Stroke Color** to determine the border color of text fields.
- Click **Width** to determine the width of text field borders.
- Click **Border** to determine the style of text field borders.

- Select an option in the **Font** and **Font Size** dropdown menus to determine the font style and size used in text fields.
- Use the **Text Color** dropdown menu to determine the color of fonts used in text fields.
- Click **Properties** to open the **Text Field Properties** pane, which enables the customization of additional elements of text fields and is detailed in the section below.

### ▼ The Text Field Properties Pane

The **Text Field Properties** pane can be used to determine a range of style and functionality options for text fields. For example, it is possible to use the **Actions** properties to add multiple dynamic actions to text fields, such as running JavaScript, launching web links and opening files on the local computer. (JavaScript is a high-level programming language that can be used to perform custom operations. See [here](#) for an index of existing JavaScript operations that the **PDF-XChange Editor** forms can use, as well as additional information about JavaScript). Click **Select Fields** to select form fields, then click the desired field and click **Properties** in the **Format** tab to open the **Text Field Properties** pane:

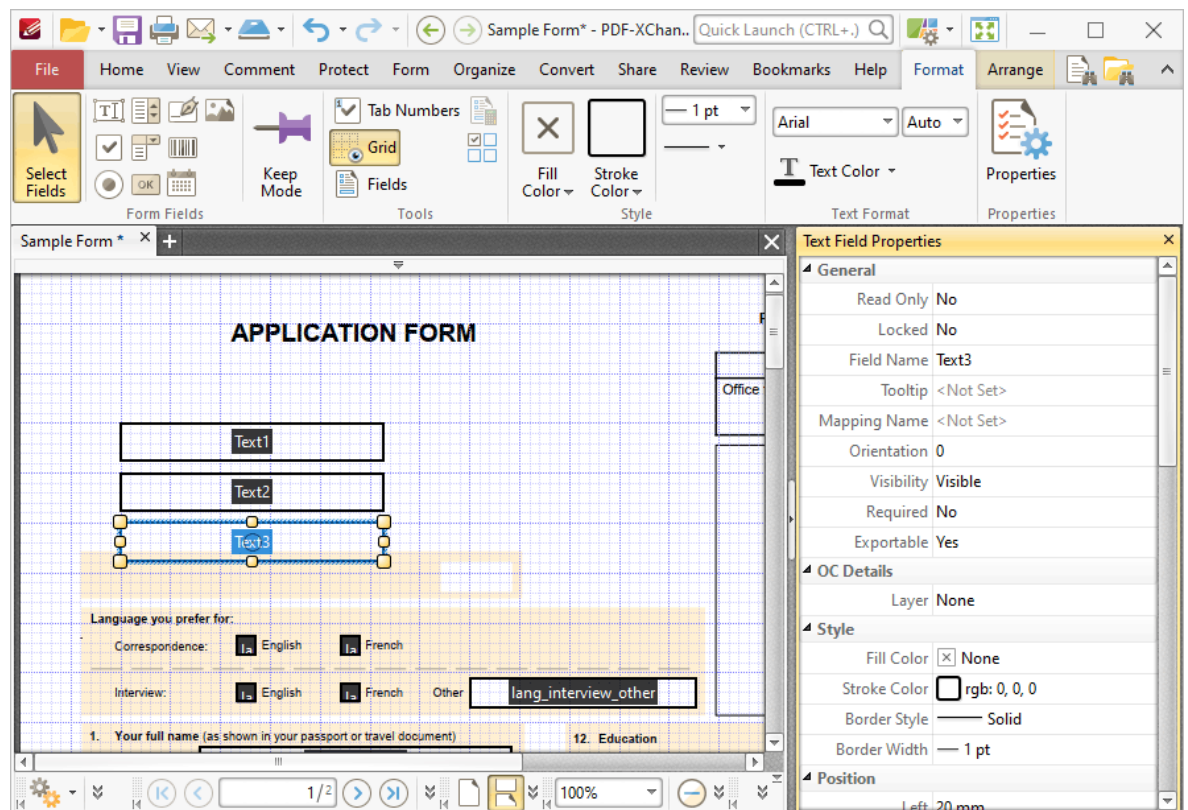

Figure 5. Text Field Tool, Text Field Properties Pane

The options detailed below are available in the **Text Field Properties** pane:

The **General** properties determine the general parameters of text fields:

- **Read Only** determines whether or not the text field can be edited.
- **Locked** determines whether or not the text field can be moved, and whether or not its properties can be modified.
- **Field Name** determines the name of the text field. This name is present when the **Select Fields** tool is enabled, and when text fields are listed in the [Fields pane](#).<sup>1016</sup>
- **Tooltip** determines the information displayed when the pointer is hovered over the text field.
- **Mapping Name** determines the mapping name that the text field uses. This name is used to reference interactive form data when the form is exported, and does so without affecting the appearance of the name in the original document.
- **Orientation** determines the orientation of text entered in the text field.
- **Visibility** determines the visibility of the text field.
- **Required** determines whether or not the text field is a required field. Required fields must be filled before documents that contain them can be submitted.
- **Exportable** determines whether or not the text field data can be exported from the form.

The **OC Details** property determines the optional content layer to which the text field belongs. When a field belongs to an optional content layer, it displays only when the layer is enabled. Use the **Layers** pane to view/create/edit layers, as detailed [here](#).<sup>1024</sup>

The **Style** properties determine stylistic elements of text fields. They are detailed beneath [\(figure 4\)](#).

The **Position** properties determine the position and dimensions of text fields:

- **Left** determines the distance of the text field from the left margin.
- **Top** determines the distance of the text field from the bottom of the page.
- **Width/Height** determine the width/height of the text field.

The **Default Text Format** properties determine the default properties when text is entered into the text field:

- **Font** determines the font used.
- **Font Size** determines the size of the font.
- **Text Color** determines the color of the font.

The **Options** properties determine additional options for text fields:

- **Alignment** determines the text alignment within the text field.
- **Default Value** determines the default value of the text field. Text fields will show this value by default. If they are edited and then reset then the value entered for this property will be displayed.

- **File Select** determines whether or not files on the local computer are selected when their filename is entered in the text field. If set to **Yes** then the file contents are submitted as the value of the text field when the form is submitted.
- **Password** determines whether or not the text field is a password field. If text fields are designated as passwords then text entered into them will be encrypted in the standard manner:

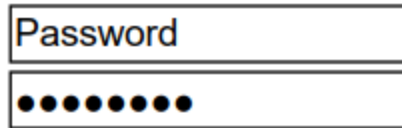

Figure 6. Standard Text Field (above) and Standard Text Field with Password Enabled (below)

- **Check Spelling** determines whether or not the spelling of words entered in the text field is automatically checked.
- **Multi Line** determines whether or not multiple lines of text are permitted in the text field.
- **Scroll** determines whether or not a scroll bar is added when multiple lines of text are entered into text fields.
- **Allow Rich Text** determines whether or not the text field permits rich text such as bold and italics.
- **Comb** determines whether or not line separators are inserted between characters in the text field:

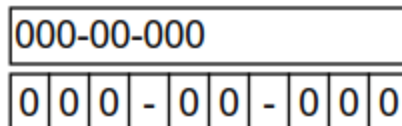

Figure 7. Standard Text Field (above) and Standard Text Field with Comb Enabled (below)

- **Character Limit** determines the maximum number of characters permitted in the text field.

The **Actions** properties determine the action taken when users interact with the text field:

- **Mouse Down** initiates an action when the left mouse button is pressed (without being released) on the text field.
- **Mouse Up** initiates an action when the left mouse button is clicked (pressed and released) on the text field.
- **Mouse Enter** initiates an action when the pointer moves into the text field.
- **Mouse Leave** initiates an action when the pointer moves out of the text field.
- **On Focus** initiates an action when the text field is selected.
- **On Blur** initiates an action when the text field is deselected.
- Click the ellipsis icon on the right of actions to add/edit text field actions:

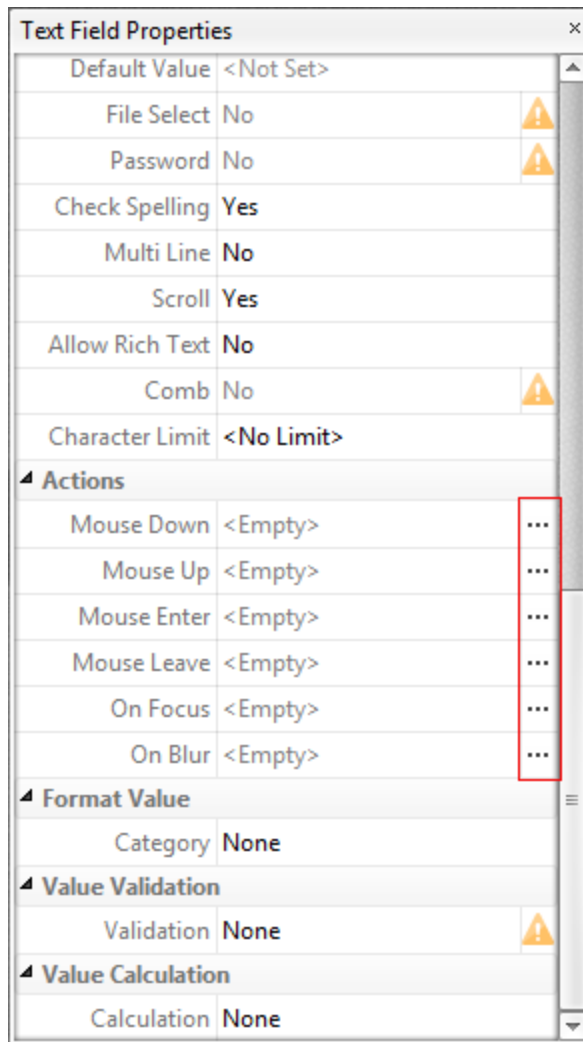

Figure 8. Text Field Properties Pane, Action Ellipses

The process of adding actions is detailed [here](#).<sup>959</sup>

The **Format Value** properties determine the type of information permitted to be entered in the text field and the format in which it should be entered:

- **Category** determines the category of the text field. Each category has different options, as detailed below:
  - **None** is the default setting. Text fields do not have a **Format Value** category when this option is selected.
  - **Number** sets the text field input to numerical values. The following options are available for this property:
    - **Decimal Places** determines the number of decimal places displayed.
    - **Separator Style** determines the separators used for numbers.
    - **Currency Symbol** determines the currency symbol used in the text field.
    - **Symbol Location** determines the location of the currency symbol in relation to the number.

- **Add Space** inserts a space between the currency symbol and the number.
- **Negative Number Style** determines how numbers with negative values are displayed.
- **Percentage** sets the text field input to percentage values. The following options are available for this property:
  - **Decimal Places** determines the number of decimal places permitted.
  - **Separator Style** determines the separator used for numbers.
- **Date** sets the text field input to date values and adds a dropdown calendar to the text field. Use the **Date Format** parameter to determine the format of dates.
- **Time** sets the text field input to time values (hours and minutes). Use the **Time Format** parameters to determine the format of time values.
- **Special** sets the text field input values to one of the special options. Use the **Special Format** parameter to determine the format. The options are:
  - **ZIP Code**
  - **ZIP Code +4**, which is used for nine-digit postal codes.
  - **Phone Number**
  - **Social Security Number**
- **Custom Action** adds custom JavaScript actions to text fields. There are two options:
  - **Format Action** is used to enable custom JavaScript for formats. Click the ellipsis icon to add/view JavaScript.
  - **Keystroke Action** is used to enable custom JavaScript for keystrokes. Click the ellipsis icon to add/view JavaScript.
  - If the options above are used then the **Add Action: "Run a JavaScript"** dialog box will open. Enter the desired JavaScript for the action and then click **OK**:

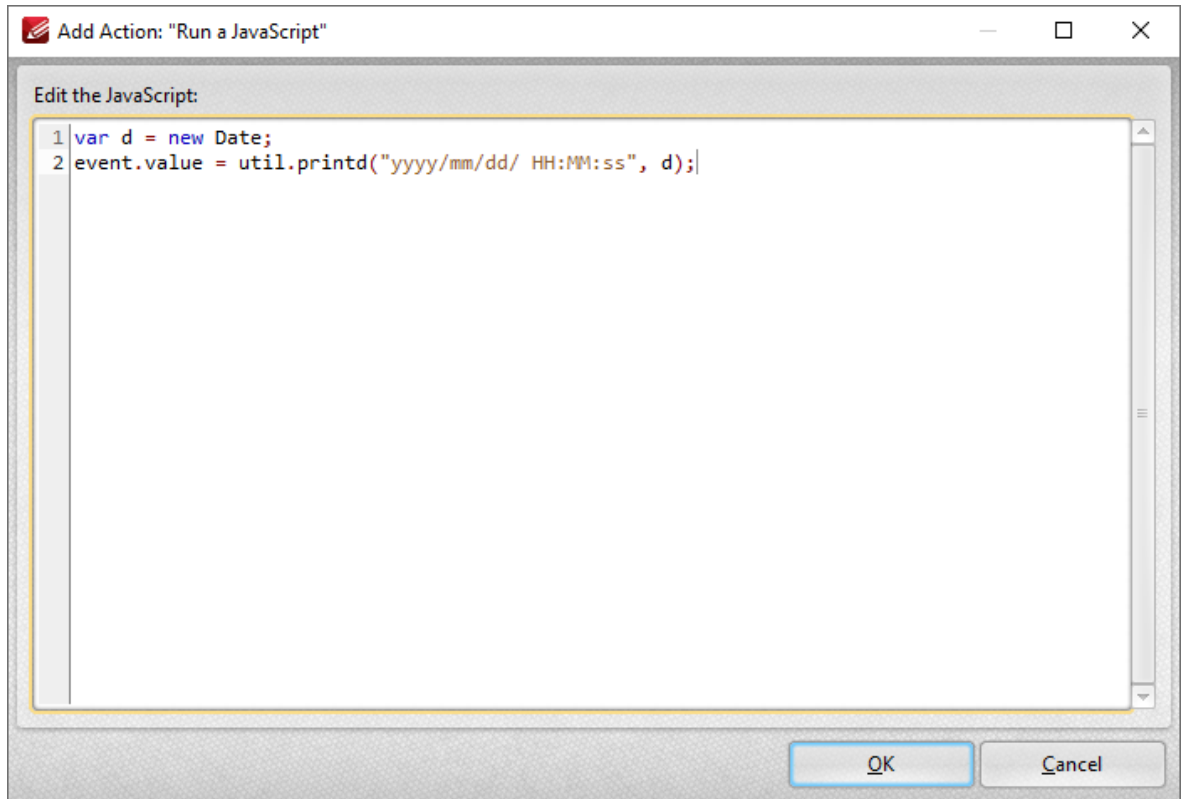

Figure 9. Edit Action: "Run a JavaScript" Dialog Box

The **Value Validation** properties determine the validation of values entered into the text field. These properties can be used to ensure that the information entered into forms fits within specific parameters:

- **Validation** determines how values are validated:
  - **Value in Range** sets the range within which values entered into the text field must fall:
    - **From** specifies the minimum value.
    - **To** specifies the maximum value.
  - **Custom Action** enables the use of custom JavaScript in order to validate values entered in the text field:
    - **Validation Action** specifies the JavaScript to use, as detailed in **(figure 9)**.

The **Value Calculation** properties determine the value of text fields from other text fields, and are used in forms where entered form data creates the value of further forms, such as when several orders are placed that combine to give a total cost. The available properties are detailed below:

- **None** specifies that calculations are not performed.
- **Sum** uses the sum of specified fields.
- **Product** uses the product of specified fields.
- **Average** uses the average of specified fields.
- **Minimum** uses the minimum value of all the specified fields.

- **Maximum** uses the maximum value of all specified fields.
- Please note that when the **Sum, Product, Average, Minimum** and **Maximum** properties are used, the additional entry "**Fields**" will appear beneath the **Calculation** property. Use this entry to specify the fields used in these calculations.
- **Simplified Notation** enables the insertion of a custom calculation to be performed on fields. Use the **Simple Notation** box to determine the calculation. Use the document field names and standard mathematical notation (+, -, \*, /) to specify the calculation. If there are spaces in form field names then they must be entered in quotation marks. For example: **Field1 + Field 2 / "Division Field" \* 64.**
- **Custom Action** enables the use of custom JavaScript in order to perform calculations and determine the order in which calculations are performed. Click the ellipsis icon to add custom JavaScript, as detailed in *(figure 9)*.

### ▼ Value Validation Example

The following example details a simple value validation of values entered into the text field '**Text1**':

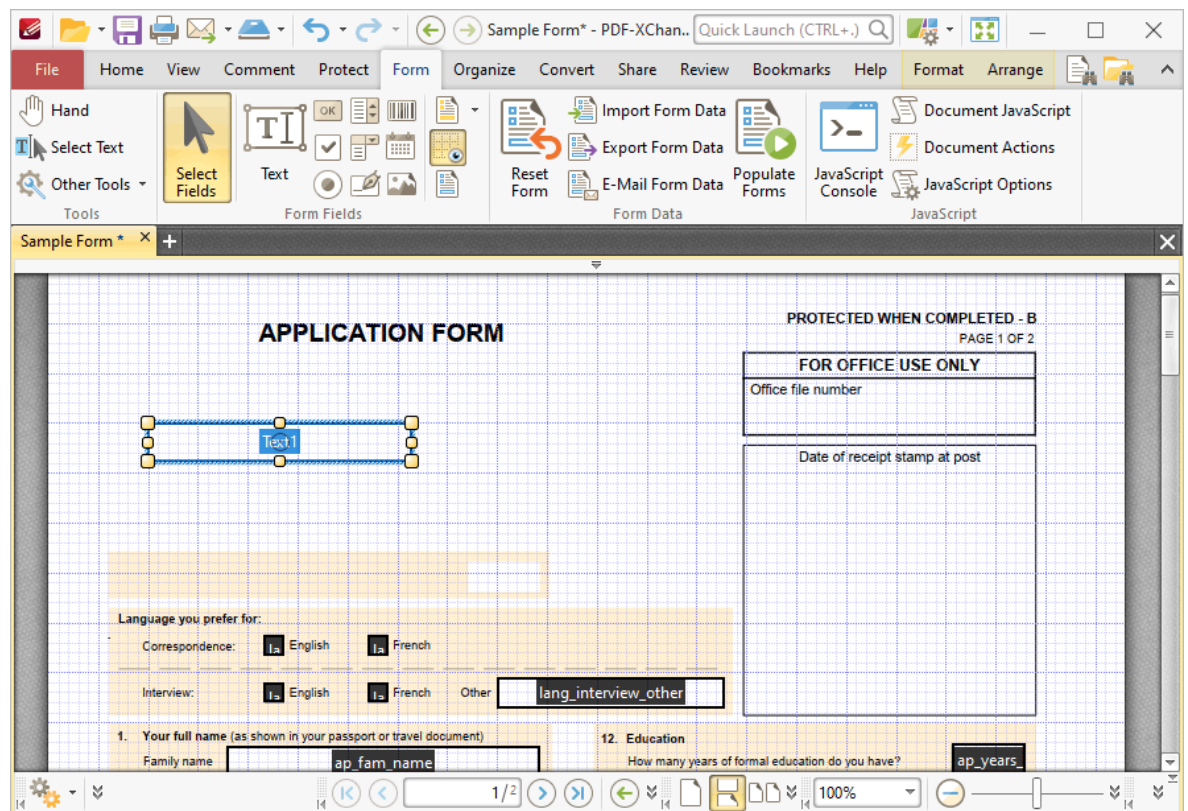

**Figure 10.** Value Validation Example, Text Field

This example will detail how to validate that values entered into the text field '**Text1**' fall in the range 0-100:



1. Click the **Form** tab, then click **Select Fields** and select the text field.
2. Click the **Format** tab and click **Properties**. The **Text Field Properties** pane will open:

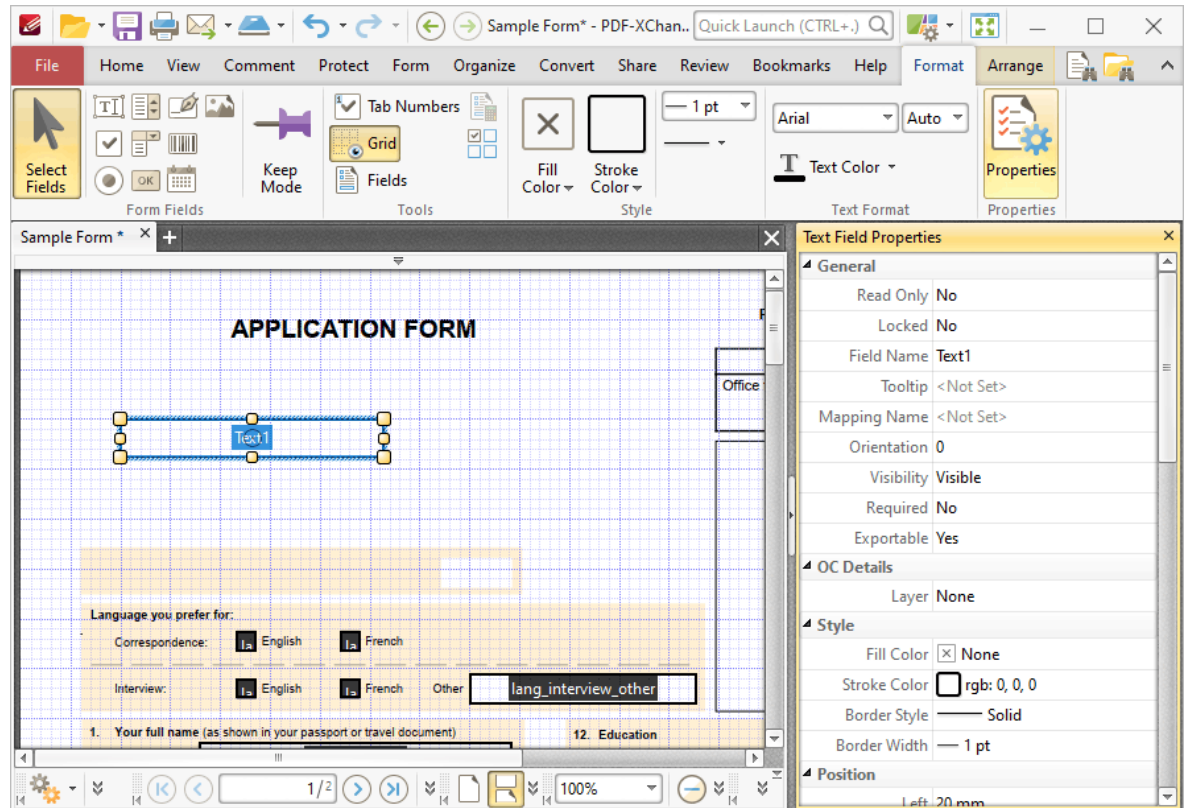

Figure 11. Value Validation Example, Text Field Properties Pane

3. Scroll down the **Text Field Properties** pane to the **Format Value** tab, then click the **Category** property and select **Number**:

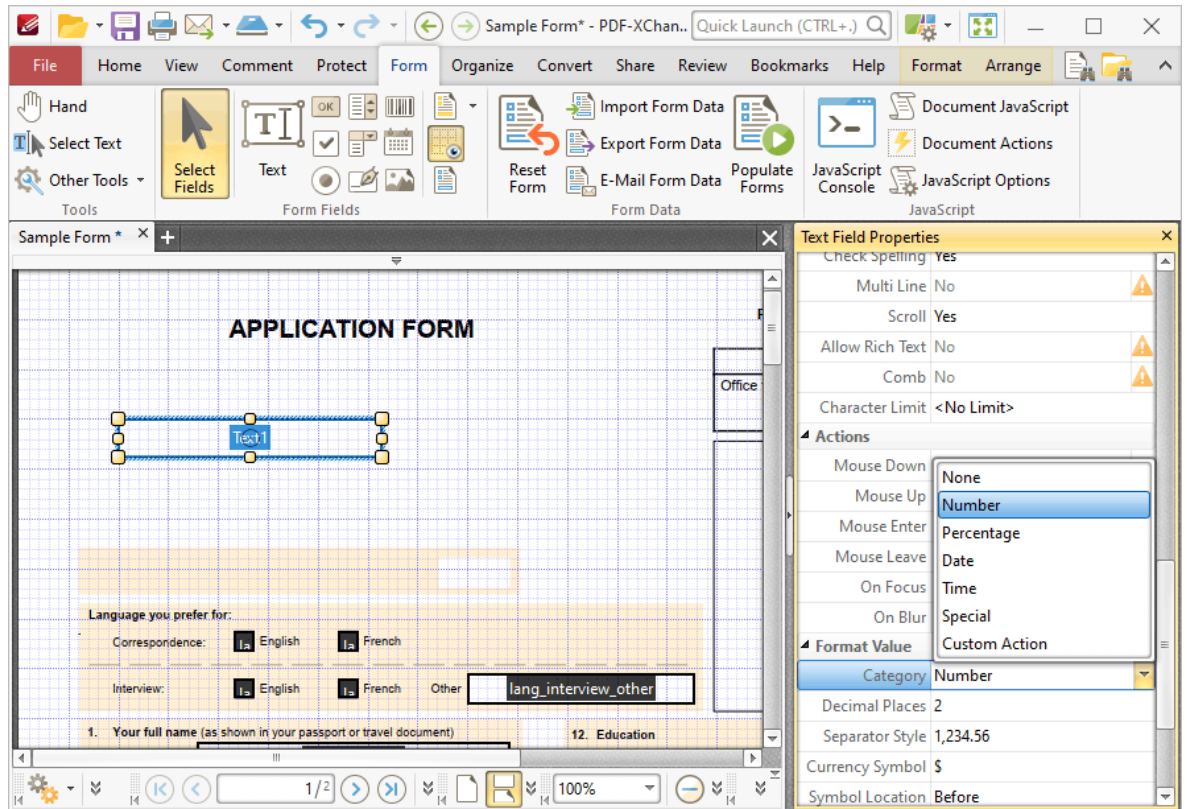

Figure 12. Value Validation Example, Category Option

4. Scroll down the **Text Field Properties** pane to the **Value Validation** tab, then click the **Validation** option and select **Value in Range**:

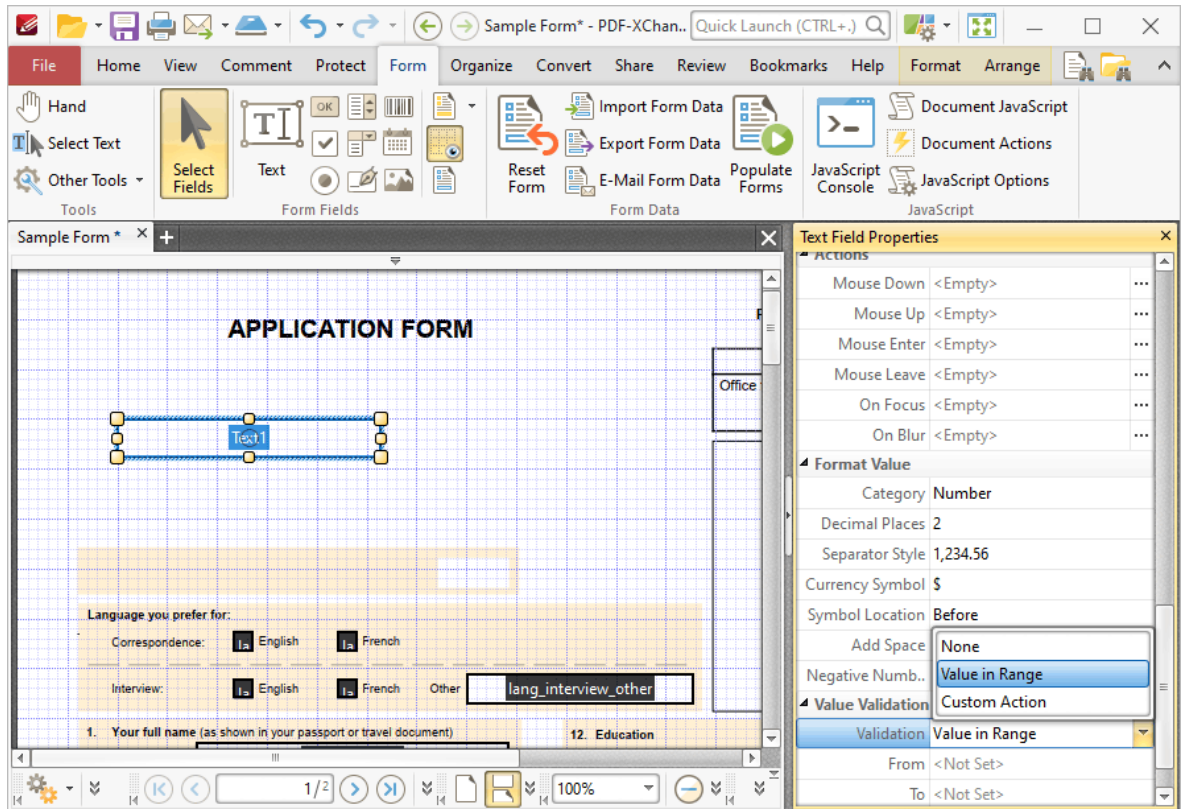

Figure 13. Value Validation Example, Validation Option

Note that the **From** and **To** options will appear beneath the **Validation** property.

5. Enter '0' in the **From** option and '100' in the **To** option:

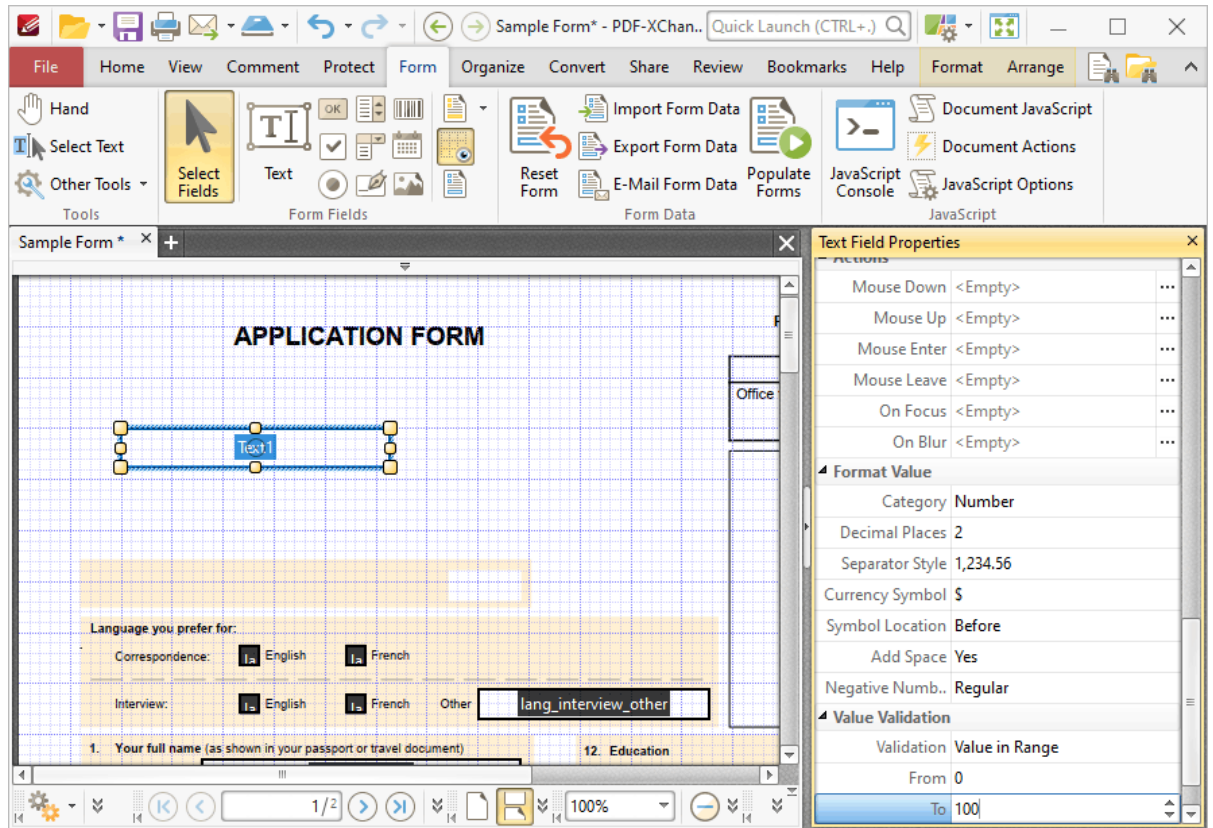

Figure 14. Value Validation Example, From/To Option

All values subsequently entered into 'Text1' must fall into the range 0-100. Values outside of the specified range will not be permitted, and if they are entered then an error message will appear.

▼ **Value Calculation Example**

The following example details a simple value calculation. There are three text fields: 'Text1', 'Text2' and 'Text3':

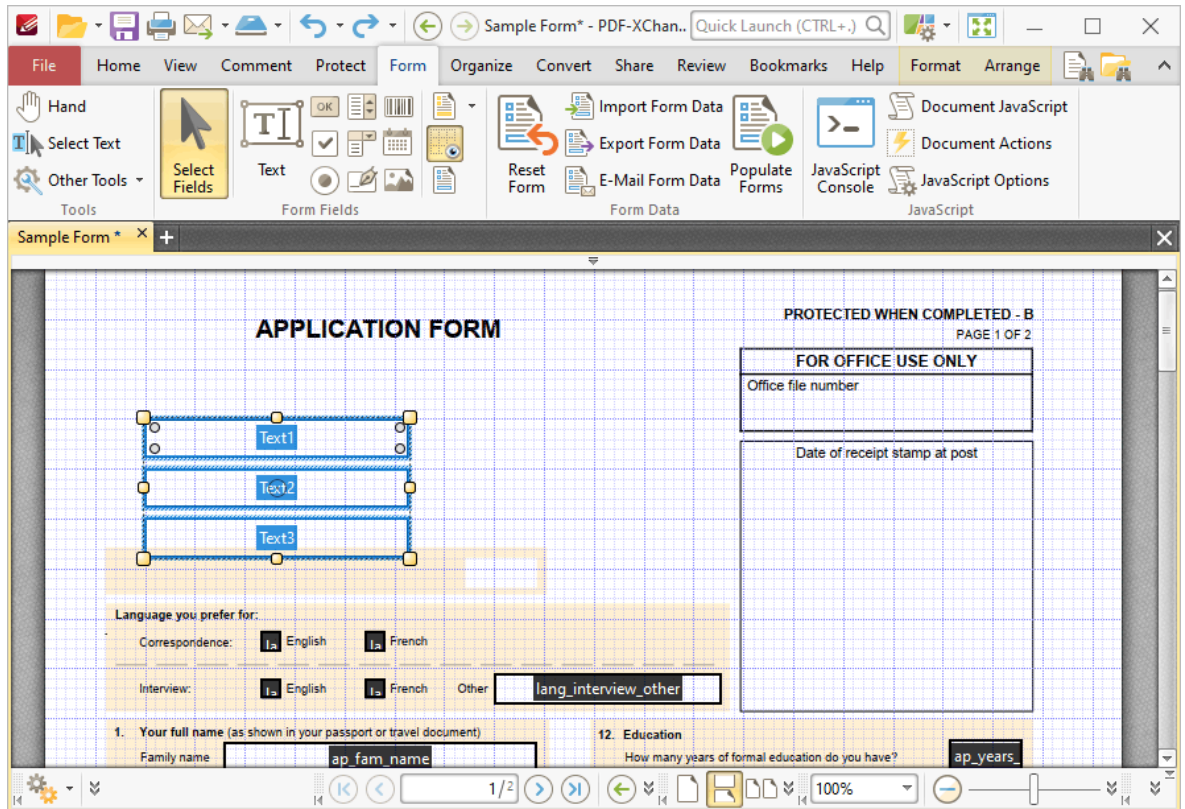

Figure 15. Value Calculation Example, Text Fields

This example will detail how to use the product of the values entered in '**Text1**' and '**Text2**' to create the value for '**Text3**':

1. Click the **Form** tab, then click **Select Fields** and select '**Text3**'.
2. Click the **Format** tab, then click **Properties**. The **Text Field Properties** pane will open:

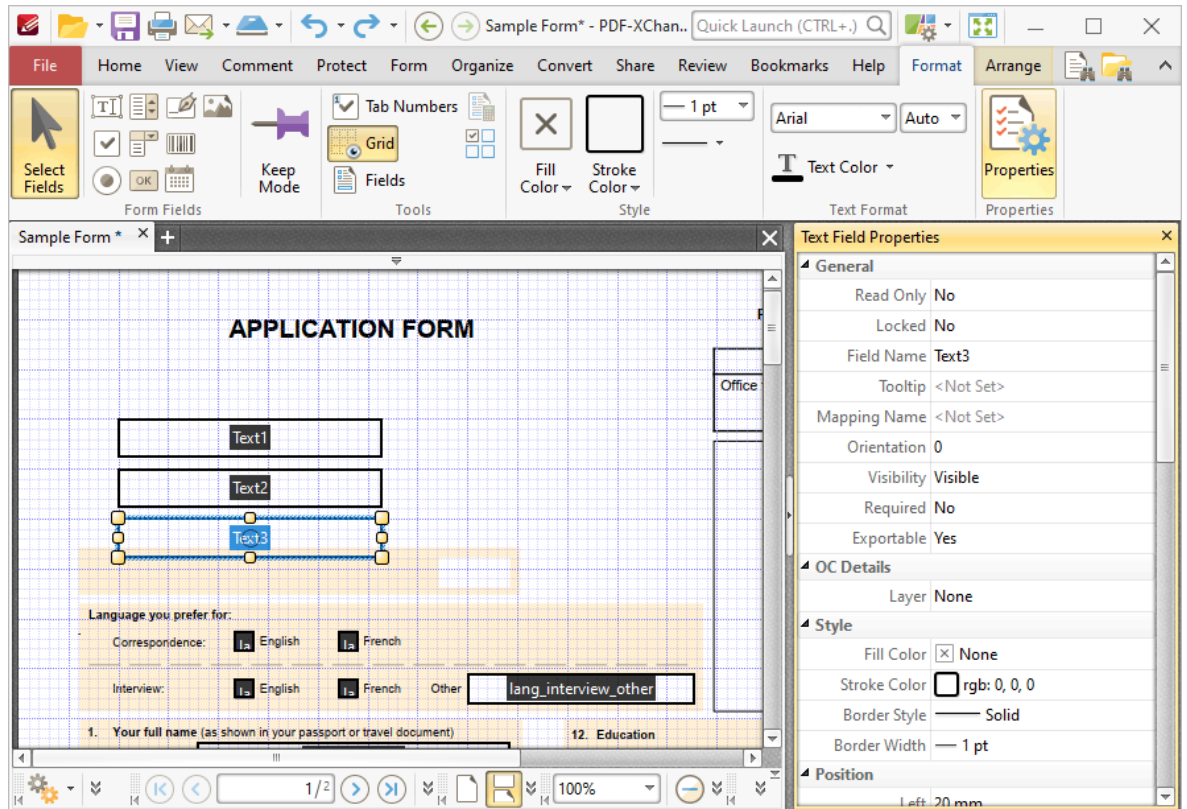

Figure 16. Value Calculation Example, Text Field Properties Pane

3. Scroll down the **Text Field Properties** pane to the **Value Calculation** tab, then click the **Calculation** property and select **Product**:

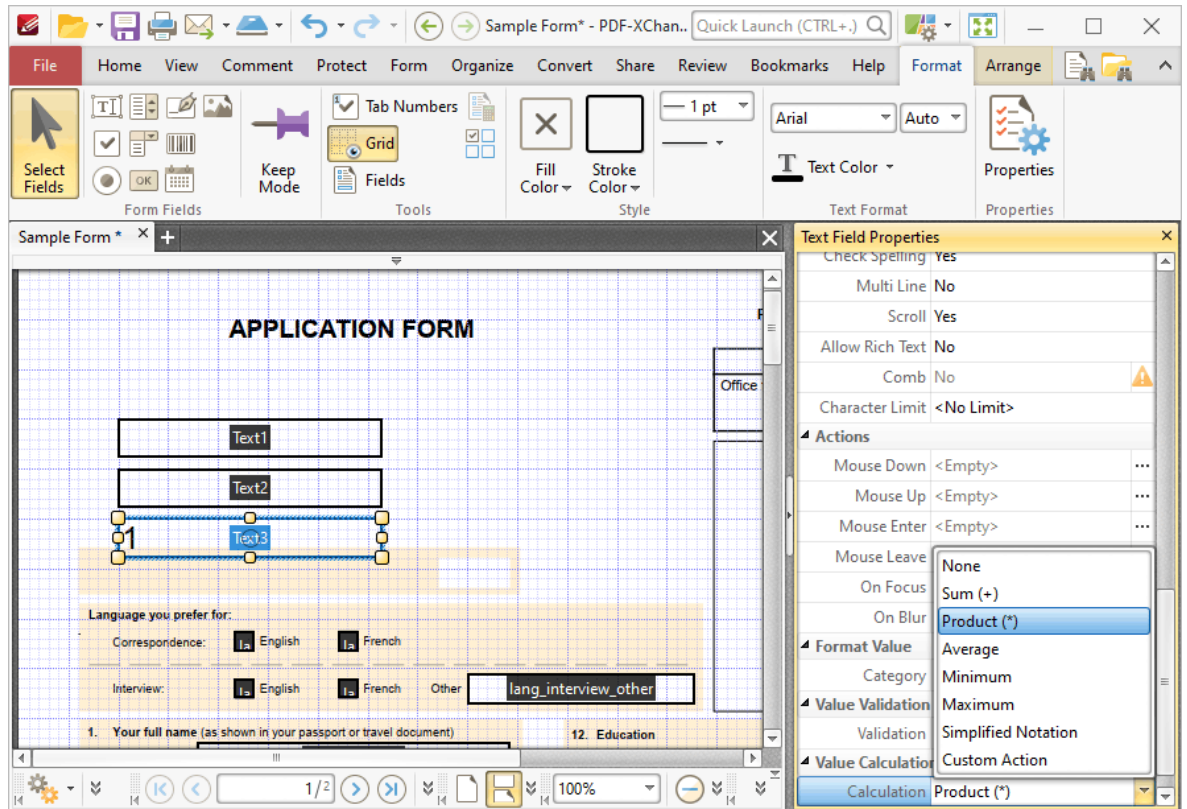

Figure 17. Value Calculation Example, Calculation Option

Note that the **Fields** property will appear beneath the **Calculation** property, as detailed in the image below. This option is used to specify the source of the values to use in the product calculation that will create the value for '**Text3**'.

4. Click the ellipsis icon (three dots) on the right of the **Fields** option. The **Fields Selection** dialog box will open. Select '**Text1**' and '**Text2**', then click **OK**:

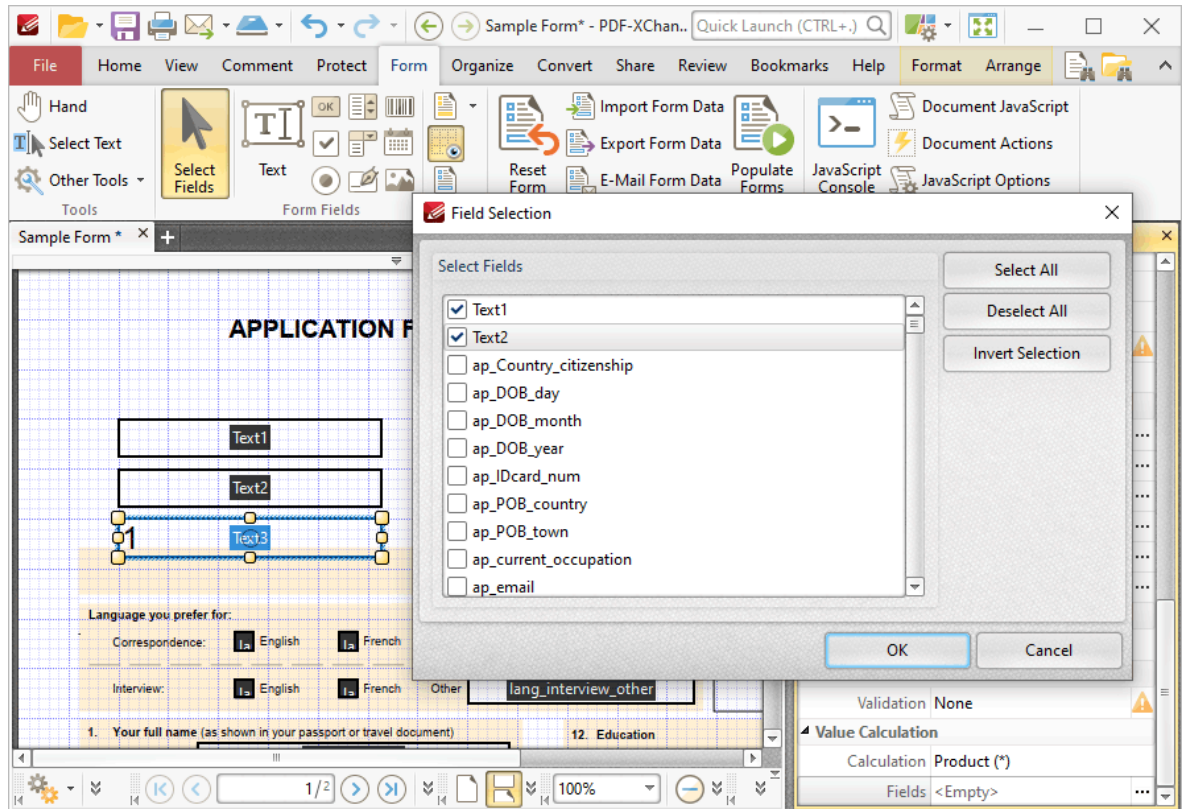

Figure 18. Value Calculation Example, Field Selection Dialog Box

The value of '**Text3**' will then be the product of the values entered in '**Text1**' and '**Text2**':



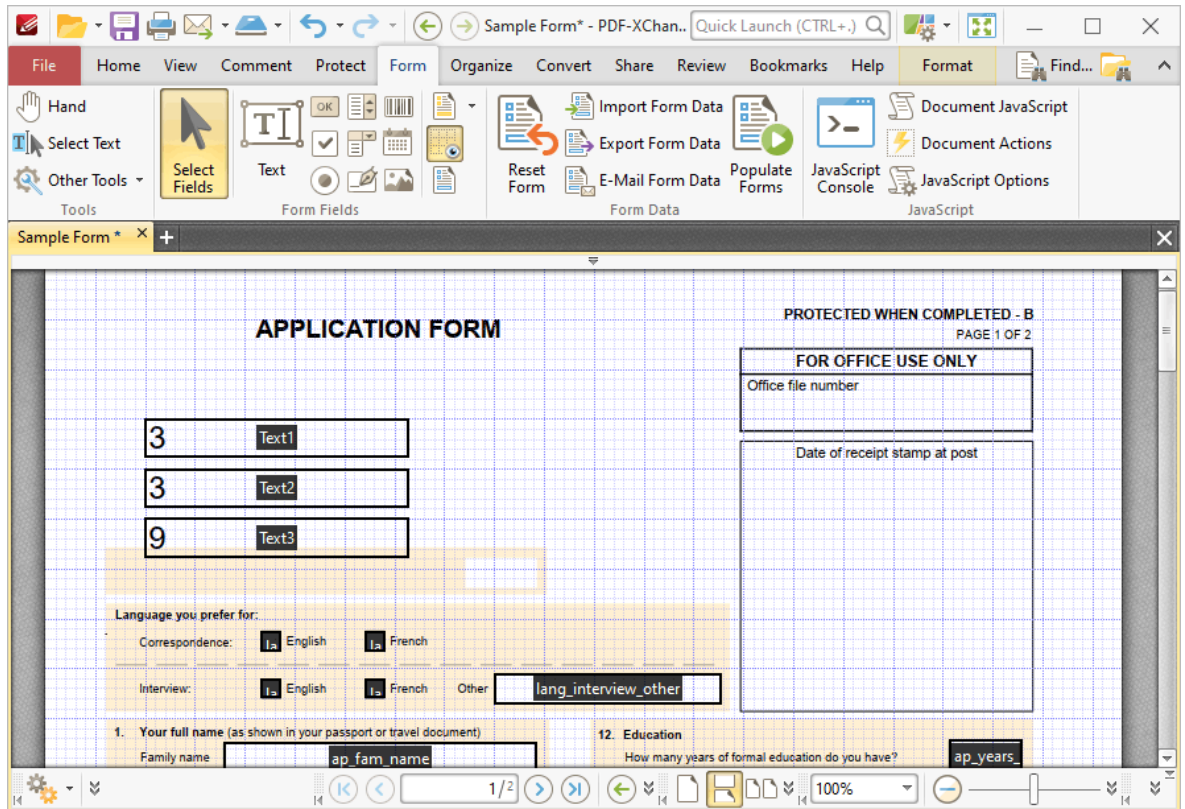

Figure 19. Value Calculation Example, Process Complete

If the values in '**Text1**' and '**Text2**' are subsequently changed, then the value in '**Text3**' will update.

Please note that the **Calculation Order** setting in the **Fields Pane** <sup>1016</sup> can be used to determine the order in which fields are calculated. This is a useful feature when documents contain more than one form field that has value calculation settings. Follow the steps below to determine the order of calculation:

1. Press Ctrl+I to open the **Fields** pane:

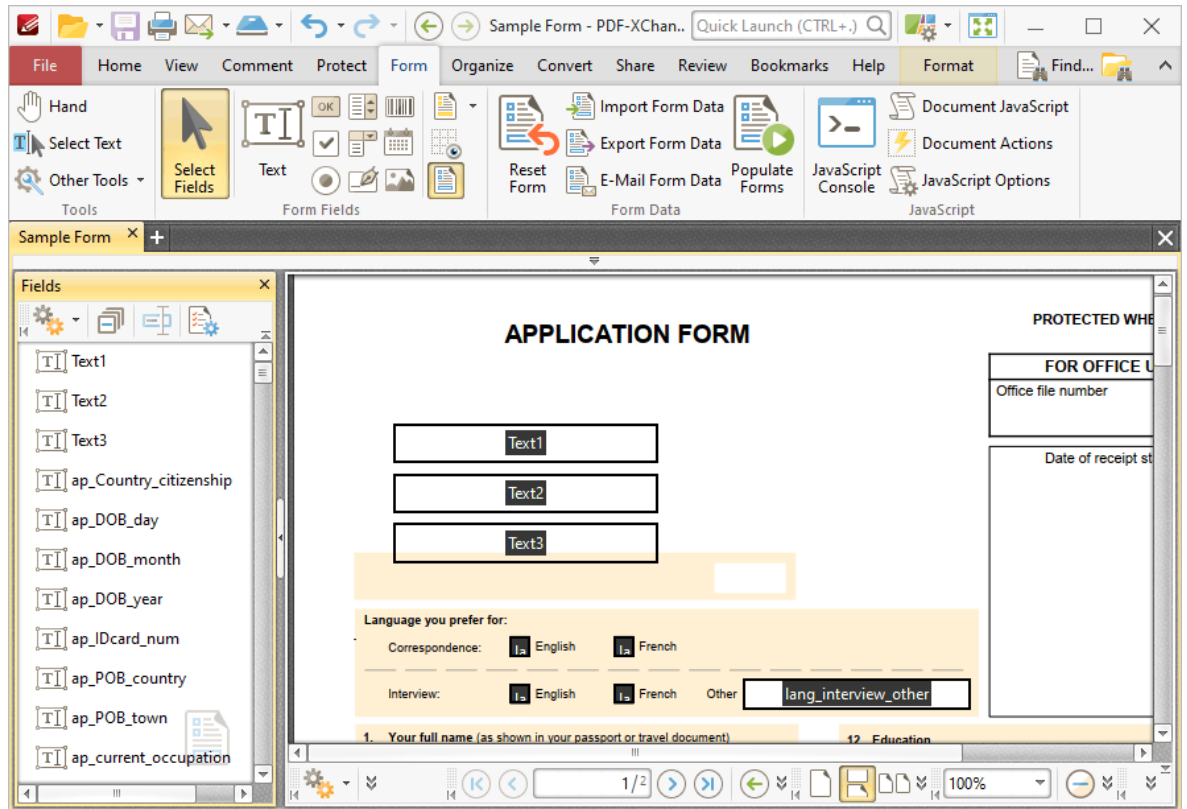

Figure 20. View Submenu, Other Panes, Fields

2. Click **Options** and then click **Calculation Order** in the submenu:

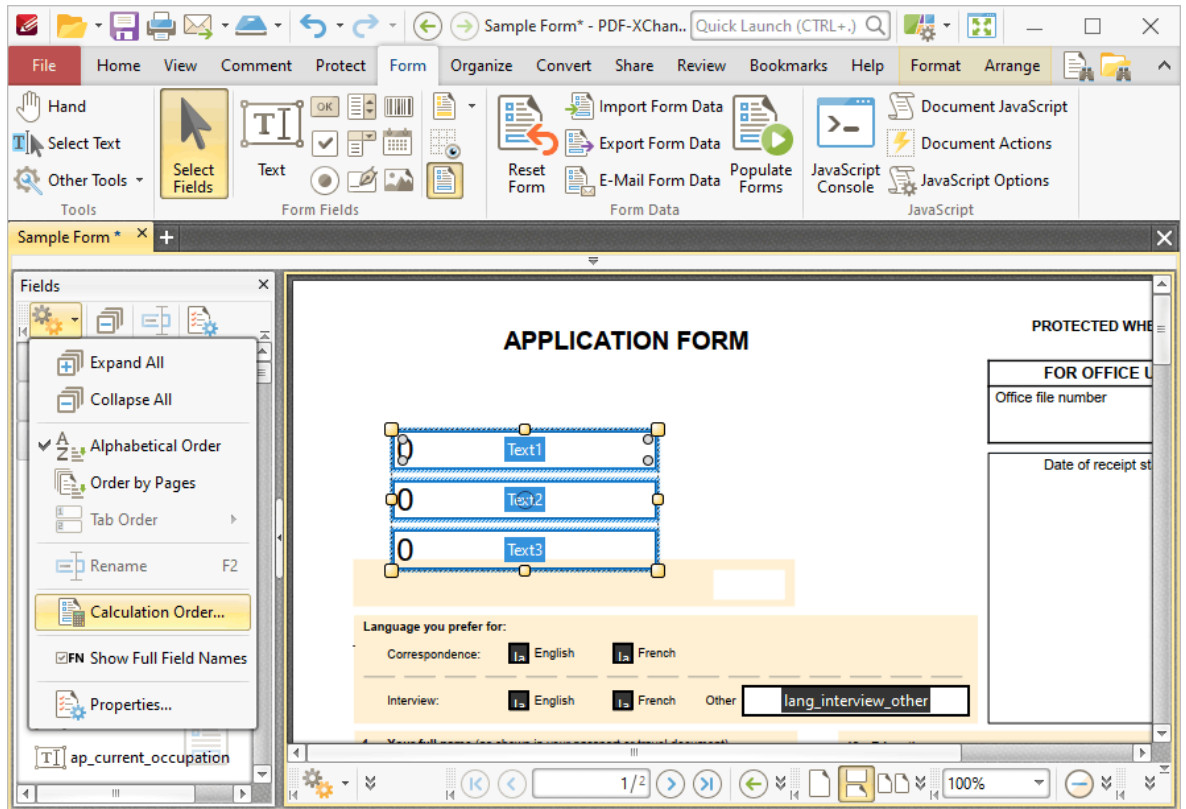

Figure 21. Fields Pane, Set Field Calculation Order

The **Calculation Order** dialog box will open:

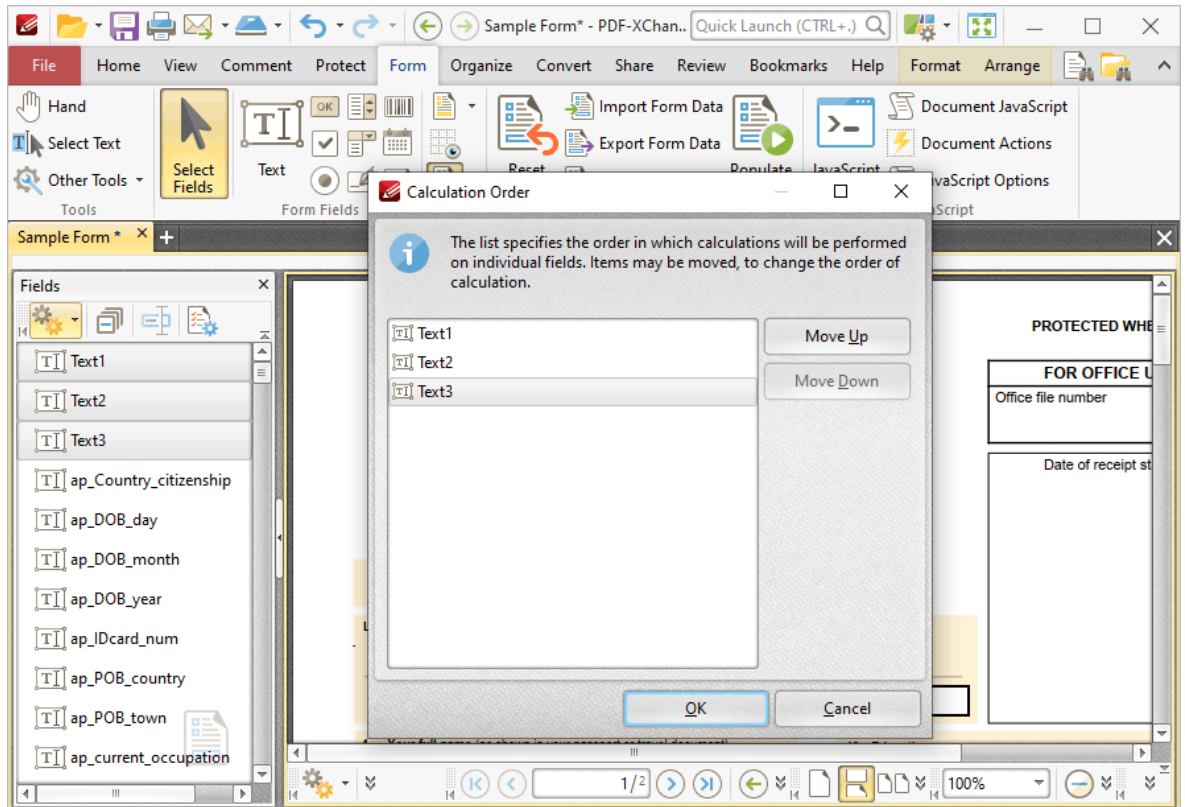

Figure 22. Calculation Order Dialog Box

The **Calculation Order** dialog box displays all form fields that contain value calculations. The order from top to bottom is the order in which calculations are performed. Click to select form fields and then click **Move Up/Move Down** to move fields up or down in the list.

10.4.6.2 Add Check Boxes to Documents



Add Check Boxes to Documents

Check boxes enable the selection of predefined options:

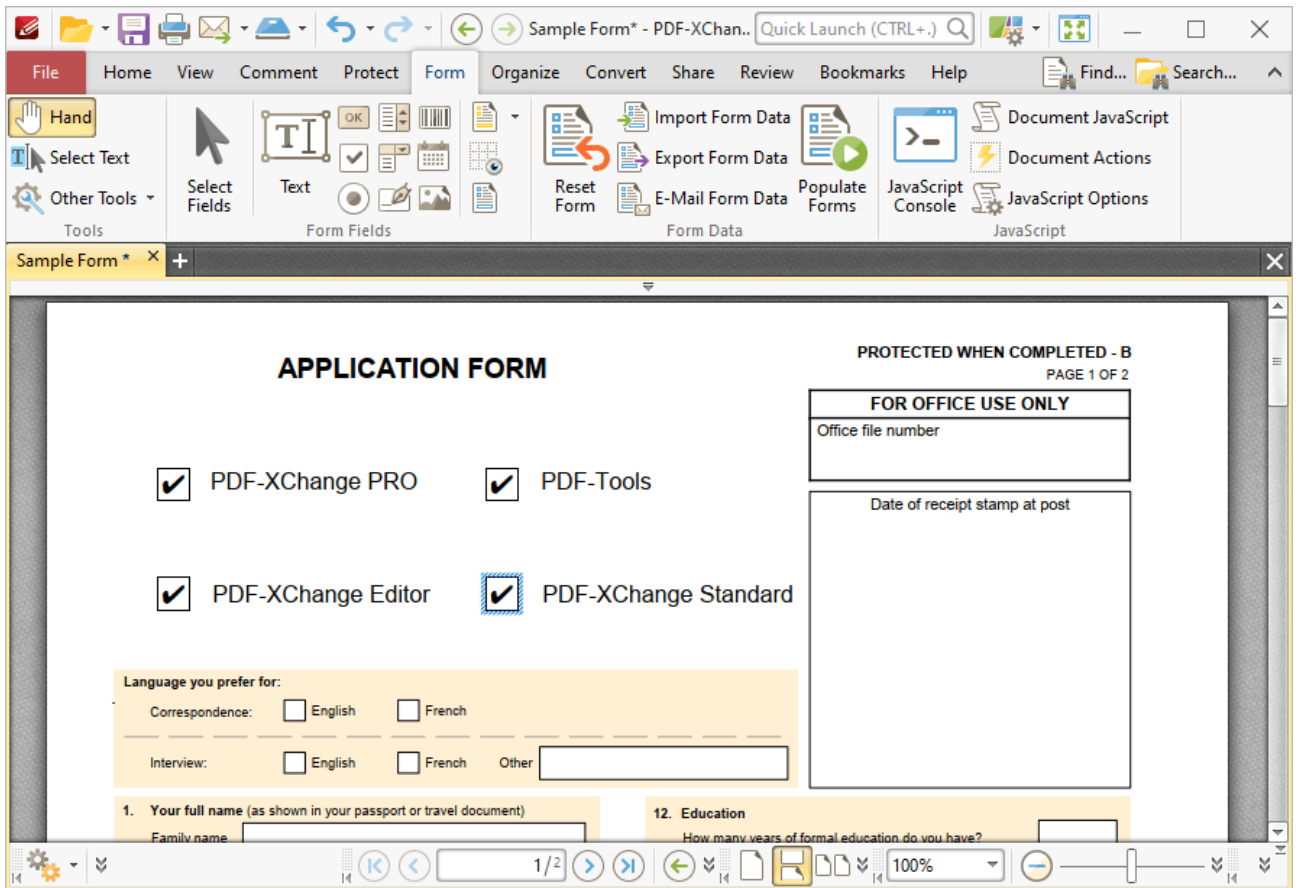

Figure 1. Example Check Boxes

The functionality of **PDF-XChange Editor** enables a wide range of dynamic customization for check boxes. Click the dropdowns below for further information:

▼ Add Check Boxes to Documents

1. Click the **Form** tab, then click **Check Box**. A blue square will be displayed beneath the pointer. This square represents the check box:

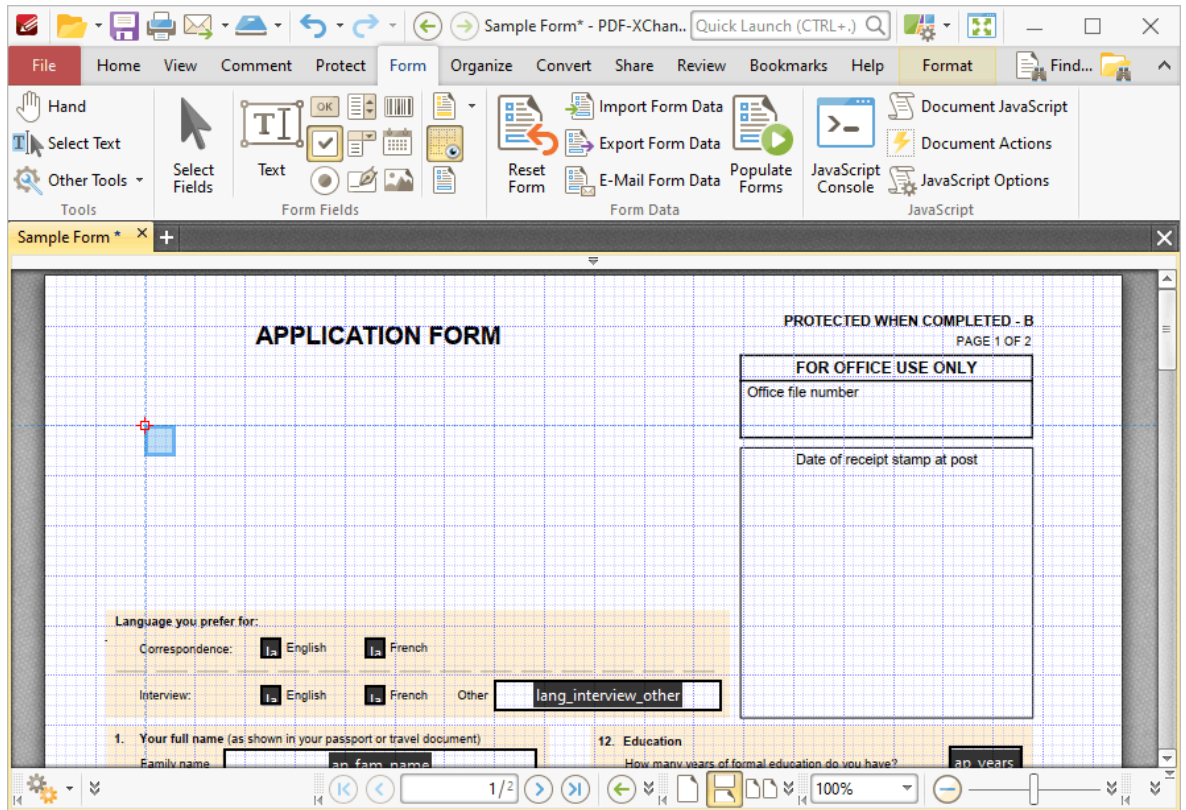

Figure 2. Active Check Box Tool

2. Move the square to the desired location and then click to add the check box to the document. Added check boxes appear as detailed below:

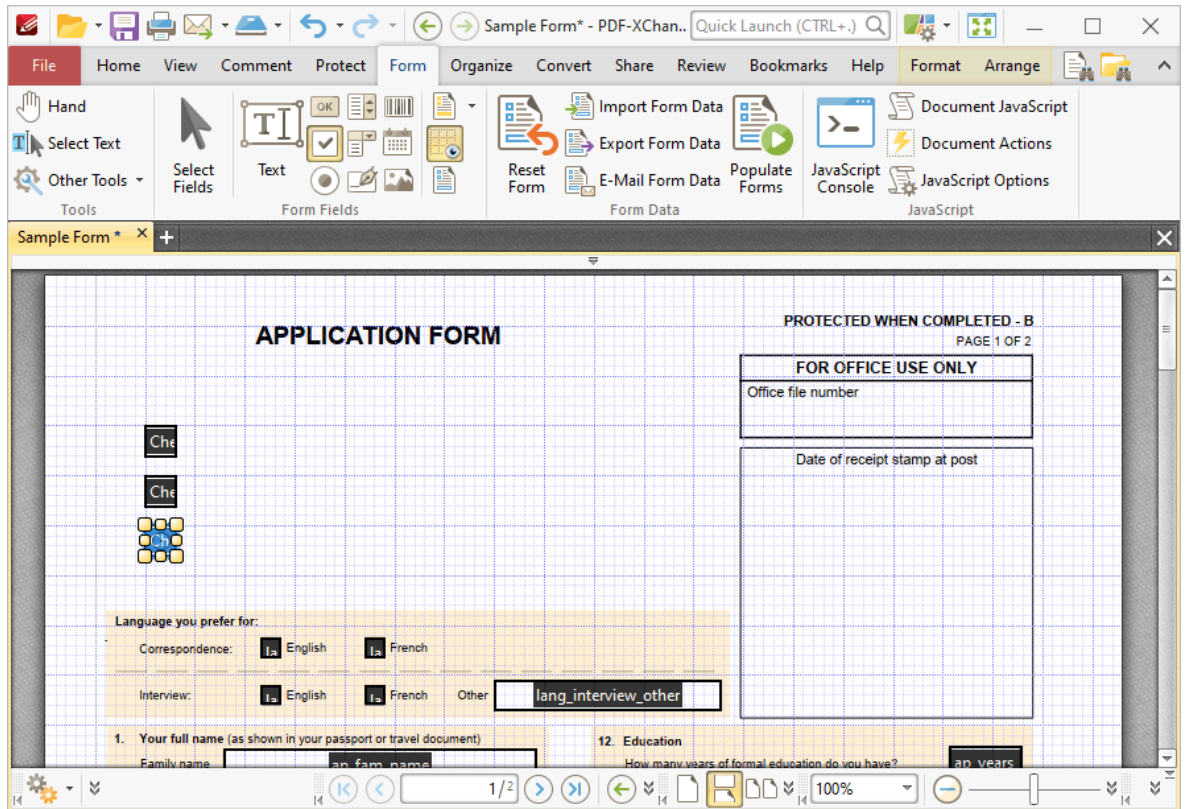

Figure 3. Added Check Boxes

- Click and drag the yellow control points to resize check boxes.
- Use the options in the **Format Tab** to determine the style and appearance of selected check boxes:

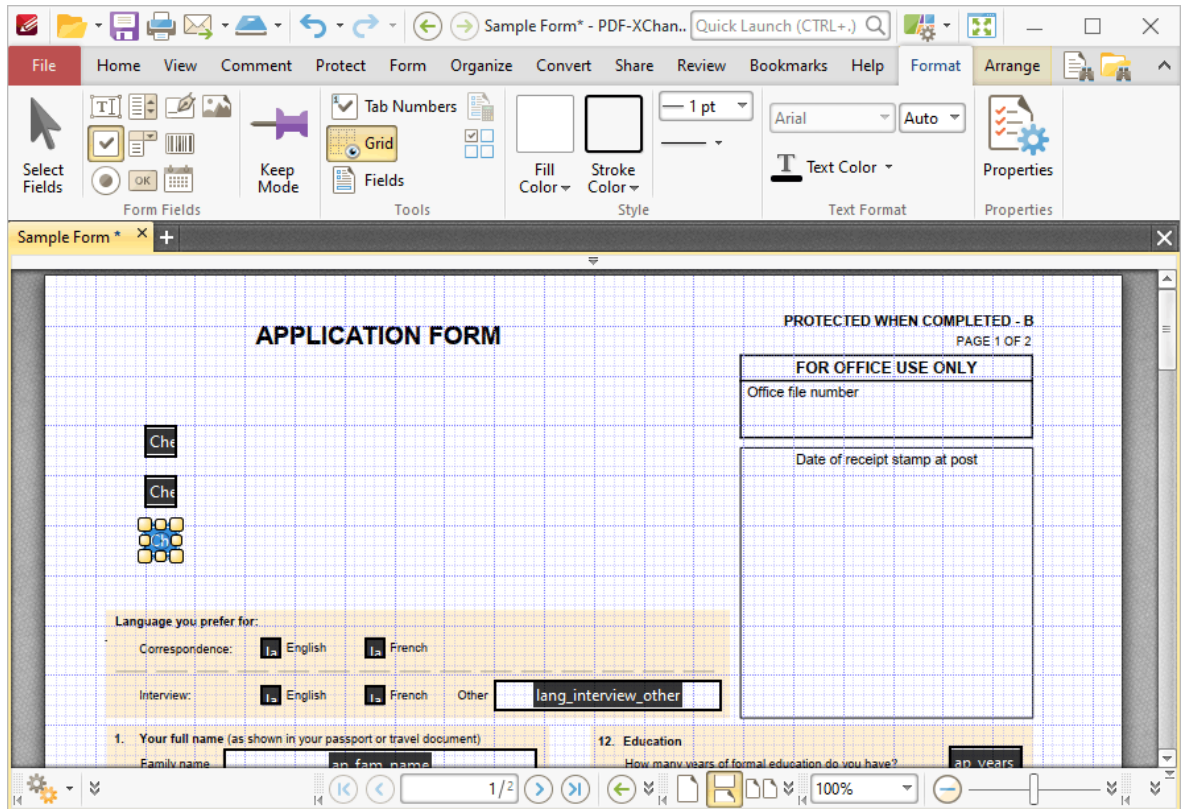

Figure 4. Format Tab, Check Boxes

- Click **Select Fields** to select and edit form fields.
- Click the options in the **Form Fields** group to enable alternative form field formats.
- Click **Keep Mode** to create multiple check boxes consecutively. If this option is disabled then **PDF-XChange Editor** will revert to the designated default tool after the creation of a single check box.
- Click **Tab Numbers** to show/hide the tab order numbers of form fields.
- Click **Calculation Order** to show/hide the order in which calculations are performed when there is more than one form field that contains a value calculation. Further information about value calculations is detailed below.
- Click **Grid** to enable/disable the grid, which is used to assist in the accurate placement of form fields, as detailed in **(figure 4)**.
- Click **Create Multiple Copies** to create multiple copies of selected form fields, as detailed [here](#).<sup>1437</sup>
- Click **Fields** to show/hide the **Fields**<sup>1016</sup> pane, which is used to view/edit form fields.
- Click **Fill Color** to determine the fill color of the check box.
- Click **Stroke Color** to determine the border color of check boxes.
- Click **Width** to determine the width of check box borders.
- Click **Border** to determine the style of check box borders.



- Select an option in the **Font Size** dropdown menus to determine the size of the check mark used in check boxes.
- Use the **Text Color** dropdown menu to determine the color of the check mark used in check boxes.
- Click **Properties** to open the **Check Box Properties** pane, which enables the customization of additional elements of check boxes and is detailed in the section below.

### ▼ The Check Box Properties Pane

The **Check Box Properties** pane can be used to determine a range of style and functionality options for check boxes. For example, it is possible to use the **Actions** properties to add multiple dynamic actions to check boxes, such as running JavaScript, launching web links and opening files on the local computer. (JavaScript is a high-level programming language that can be used to perform custom operations. See [here](#) for an index of existing JavaScript operations that the **PDF-XChange Editor** forms can use, as well as additional information about JavaScript). Click **Select Fields** to select form fields, then click the desired field and click **Properties** in the **Format** tab to open the **Check Box Properties** pane:

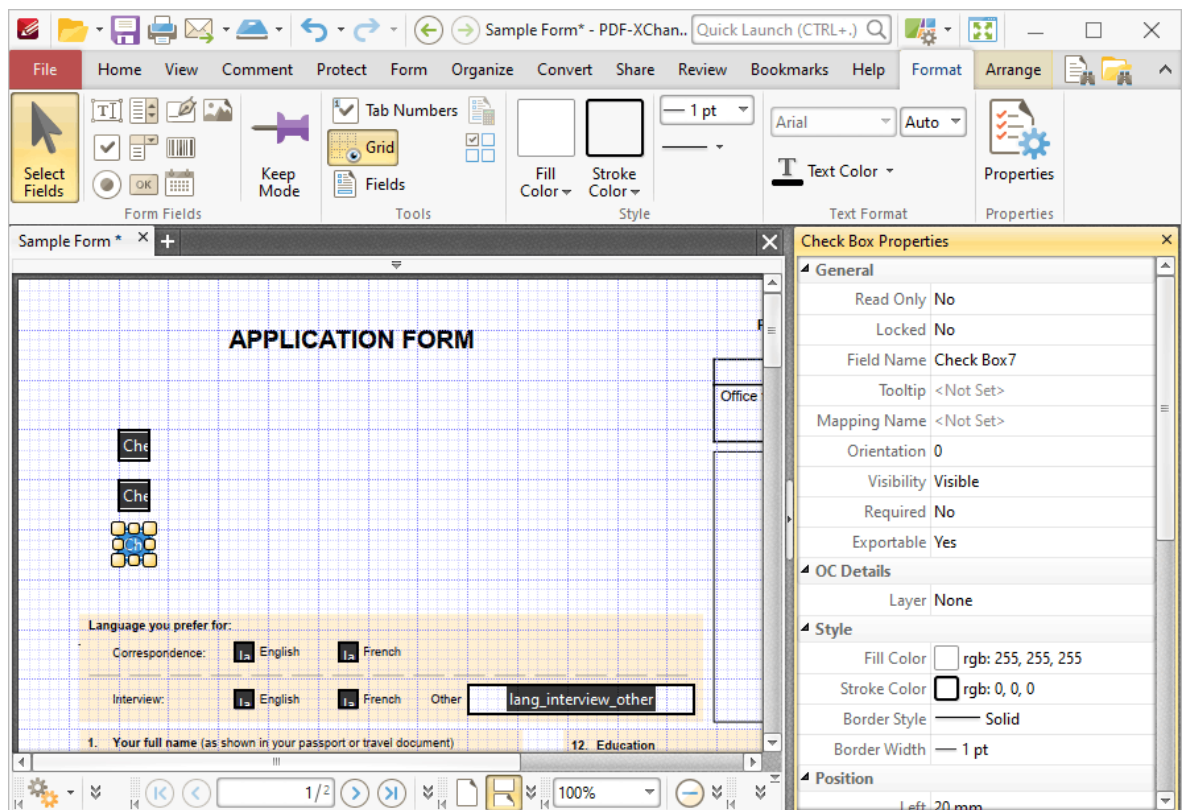

Figure 5. Check Box Tool, Check Box Properties Pane

The options detailed below are available in the **Check Box Properties** pane:

The **General** properties determine the general parameters of check boxes:

- **Read Only** determines whether or not the check box can be edited.
- **Locked** determines whether or not the check boxes can be moved, and whether or not its properties can be modified.
- **Field Name** determines the name of the check box. This name is present when the **Select Fields** tool is enabled, and when check boxes are listed in the **Fields pane**.<sup>1016</sup>
- **Tooltip** determines the information displayed when the pointer is hovered over the check box.
- **Mapping Name** determines the mapping name that the check box uses. This name is used to reference interactive form data when the form is exported, and does so without affecting the appearance of the name in the original document.
- **Orientation** determines the orientation of the check box.
- **Visibility** determines the visibility of the check box.
- **Required** determines whether or not the check box is a required field. Required fields must be filled before documents that contain them can be submitted.
- **Exportable** determines whether or not the check box data can be exported from the form.

The **OC Details** property determines the optional content layer to which the check box belongs. When a field belongs to an optional content layer, it displays only when the layer is enabled. Use the **Layers** pane to view/create/edit layers, as detailed **here**.<sup>1024</sup>

The **Style** properties determine stylistic elements of check boxes. They are detailed beneath **(figure 4)**.

The **Position** properties determine the position and dimensions of check boxes:

- **Left** determines the distance of the check box from the left margin.
- **Top** determines the distance of the check box from the bottom of the page.
- **Width/Height** determine the width/height of the check box.

The **Default Text Format** properties determine the default properties when text is entered into the check box:

- **Font Size** is always set to **auto** for check boxes. This is because the font size refers to the size of the tick when check boxes are selected, and the tick must be proportionate to the size of the check box.
- **Text Color** determines the color of the tick when check boxes are selected.

The **Options** properties determine additional options for check boxes:

- **Check Box Style** determines the icon used when check boxes are selected.
- **Export Value** determines the value that represents check boxes when they are exported.
- **Checked by Default** determines whether or not the check box is checked by default.

The **Actions** properties determine the action taken when users interact with the check box:

- **Mouse Down** initiates an action when the left mouse button is pressed (without being released).
- **Mouse Up** initiates an action when the left mouse button is clicked (pressed and released).
- **Mouse Enter** initiates an action when the pointer moves into the check box.
- **Mouse Leave** initiates an action when the pointer moves out of the check box.
- **On Focus** initiates an action when the check box is selected.
- **On Blur** initiates an action when the check box is deselected.
- Click the ellipsis icon on the right of actions to add/edit check box actions:

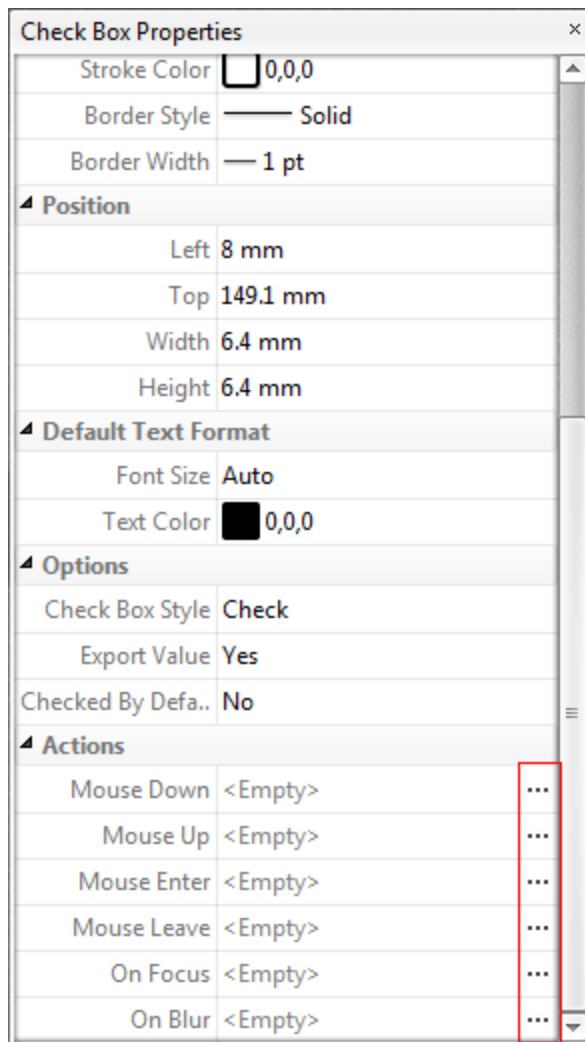

Figure 6. Check Box Properties Pane, Action Ellipses

The process of adding actions is detailed [here](#).<sup>959</sup>

▼ **Example Check Box List Creation**

The following example will detail how to create a check box list for the months of the year:

1. Click the **Form** tab, then click **Check Box**.
2. Click the **Format** tab, then click **Grid** and **Keep Mode**:

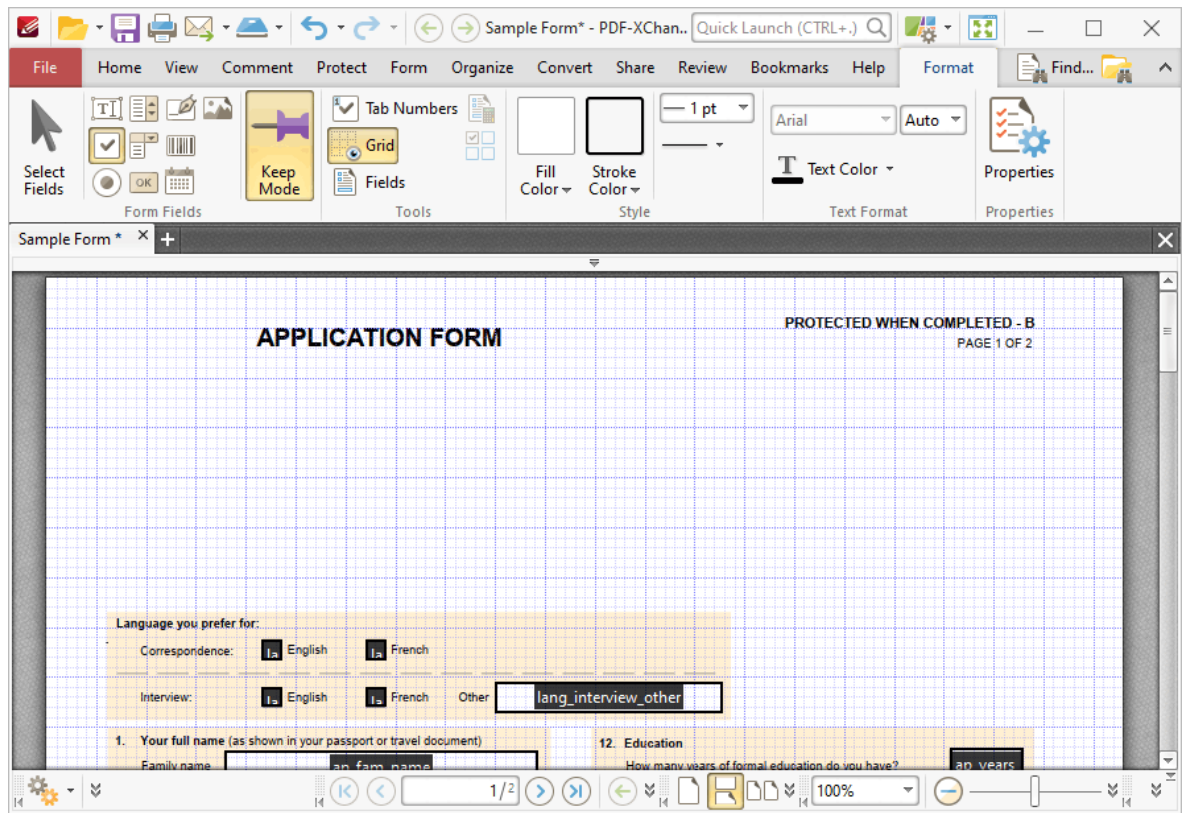

**Figure 7.** Format Tab, Keep Mode Highlighted

3. Click to place check boxes in the document:

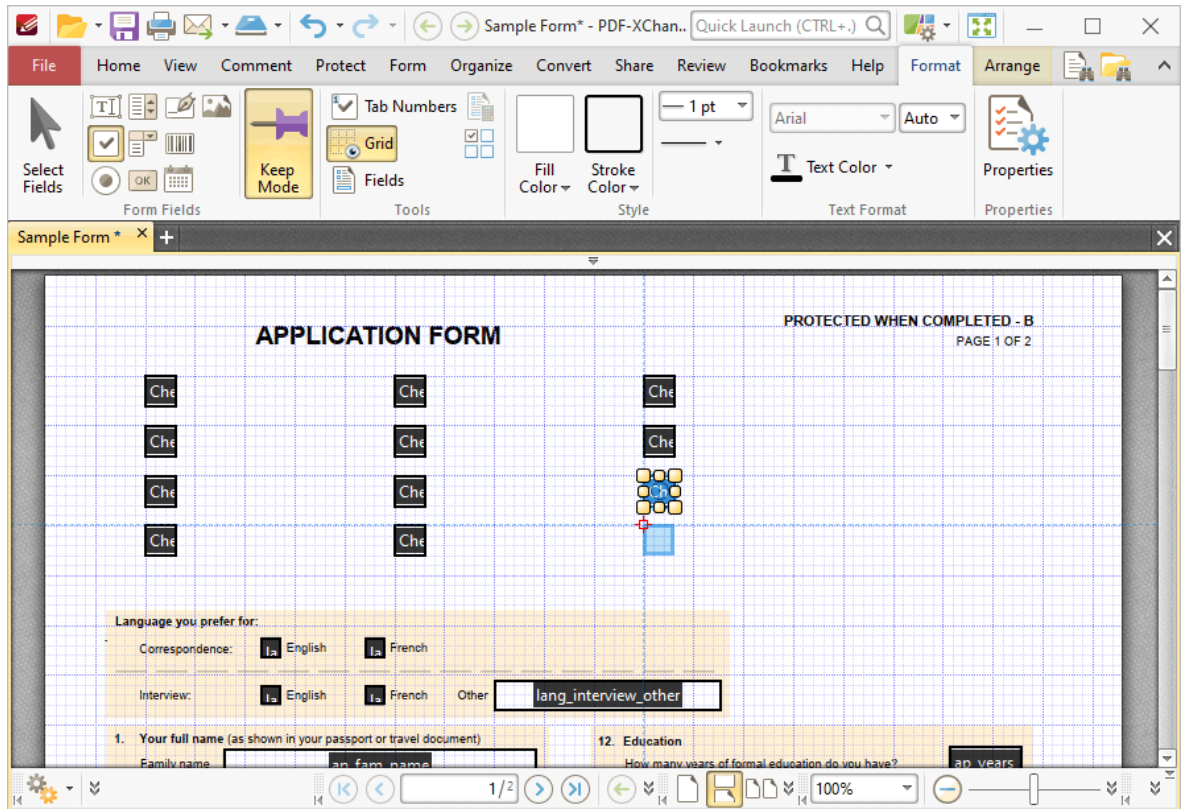

Figure 8. Adding Check Boxes

The next step is to add text box labels for the check boxes:

4. Click the **Text Box Tool** in the **Comment** tab, then click to add text boxes and enter the names of the months of the year:

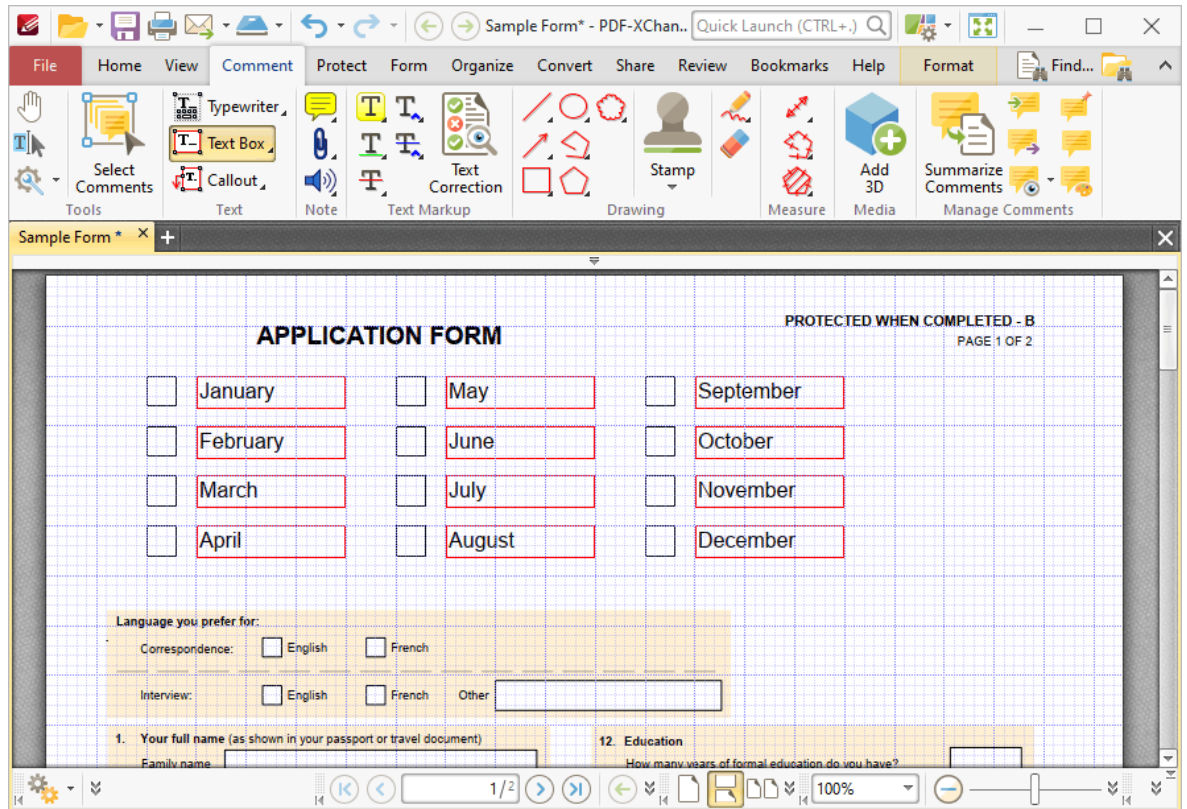
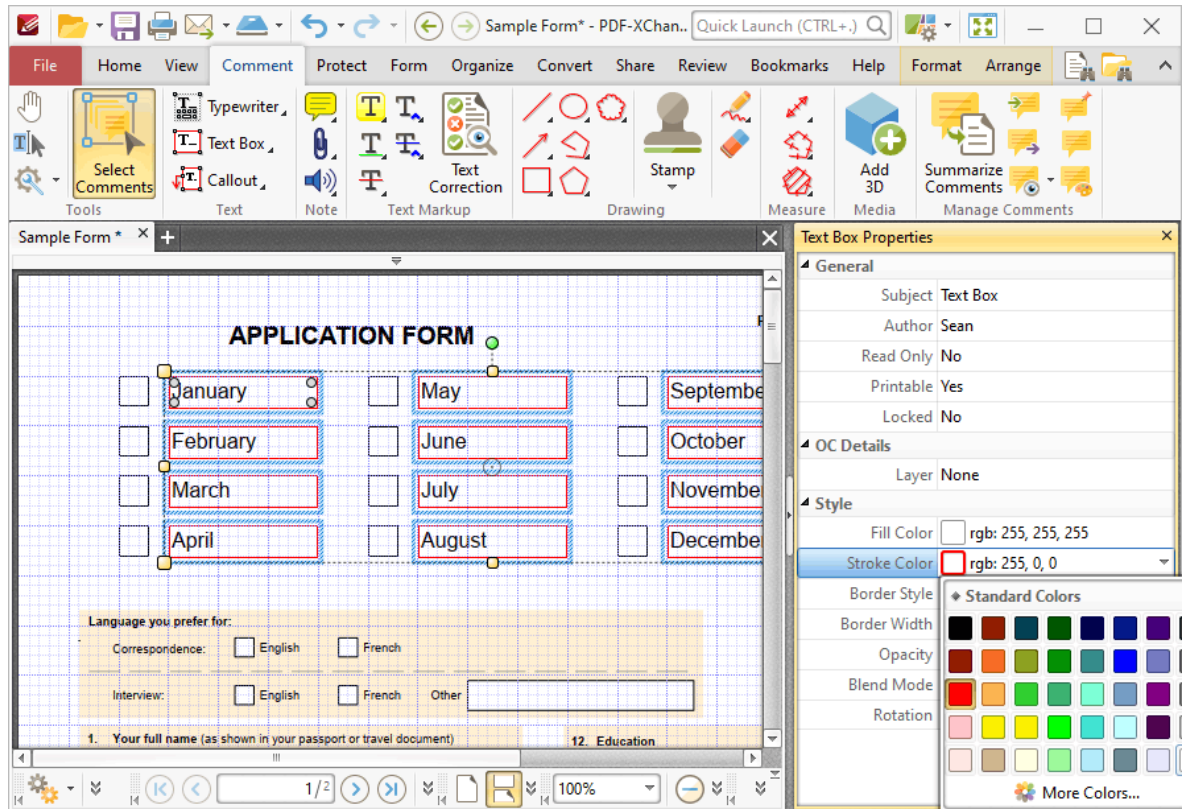

Figure 9. Comment Tab, Text Box Tool Selected

The text boxes can be customized as desired - for example the stroke color can be changed as detailed below:

5. Click **Select Comments**, then group-select the text boxes. Press Ctrl+' to open the properties pane, then change the **Stroke Color** property to white:



**Figure 10.** Comment Tab, Select Comments Highlighted, and Stroke Color Options in the Text Box Properties Pane

When all desired customizations have been made, press **Ctrl+#** to disable the grid. The check box list is then complete. Click the **Hand Tool** to select/clear check boxes:

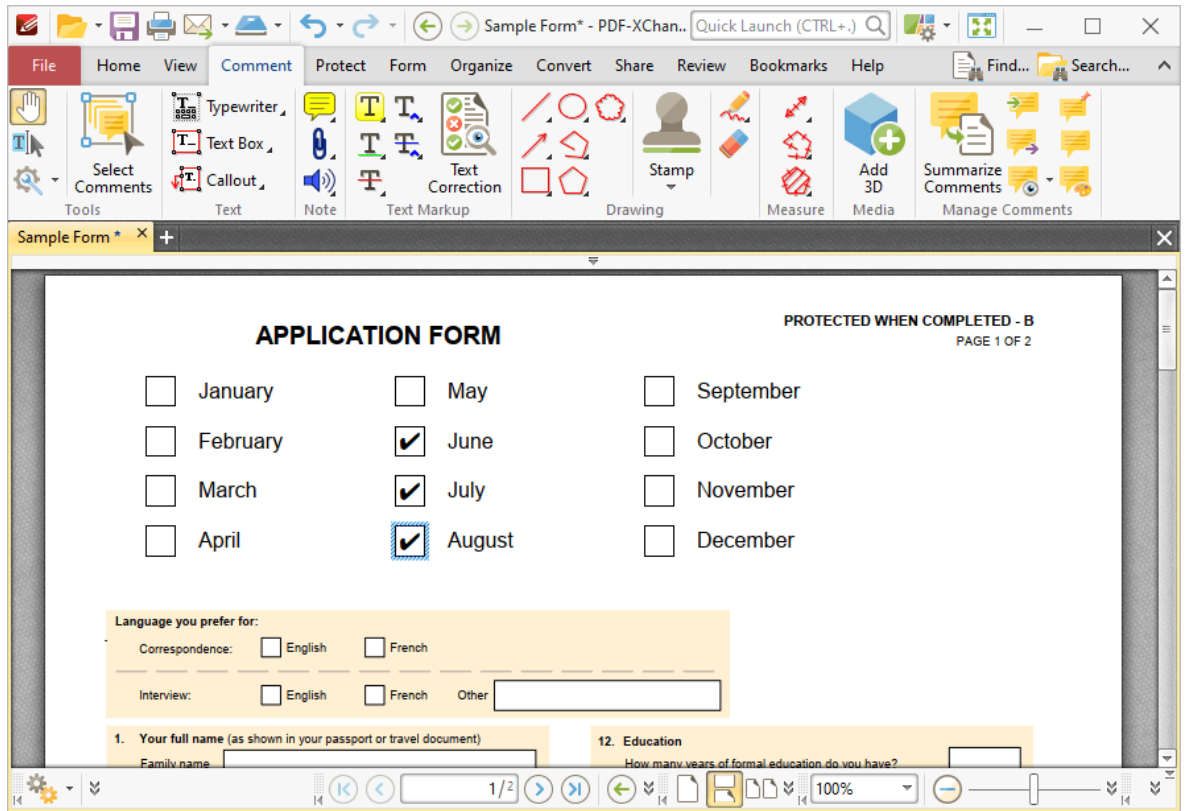

Figure 11. Completed Check Box List



10.4.6.3 Add Radio Buttons to Documents



Add Radio Buttons to Documents

Radio buttons enable the selection of a single choice from several options, such as in answers to multiple choice questions:

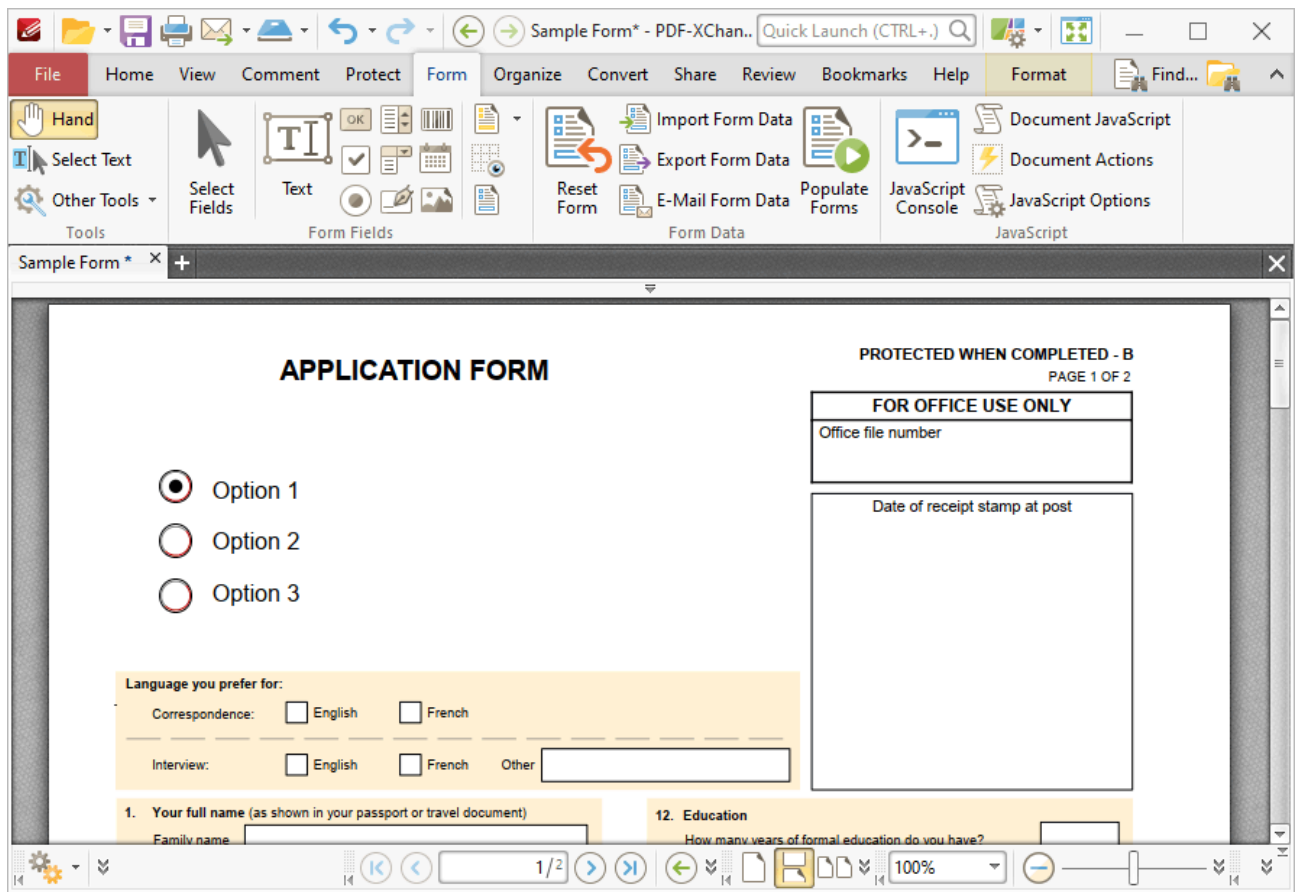

Figure 1. Example Radio Buttons

The functionality of **PDF-XChange Editor** enables a wide range of dynamic customization for radio buttons. Click the dropdowns below for further information:

▼ Add Radio Buttons to Documents

1. Click the **Form** tab, then click **Radio Button**. A blue square will be displayed beneath the pointer. This square represents the radio button:

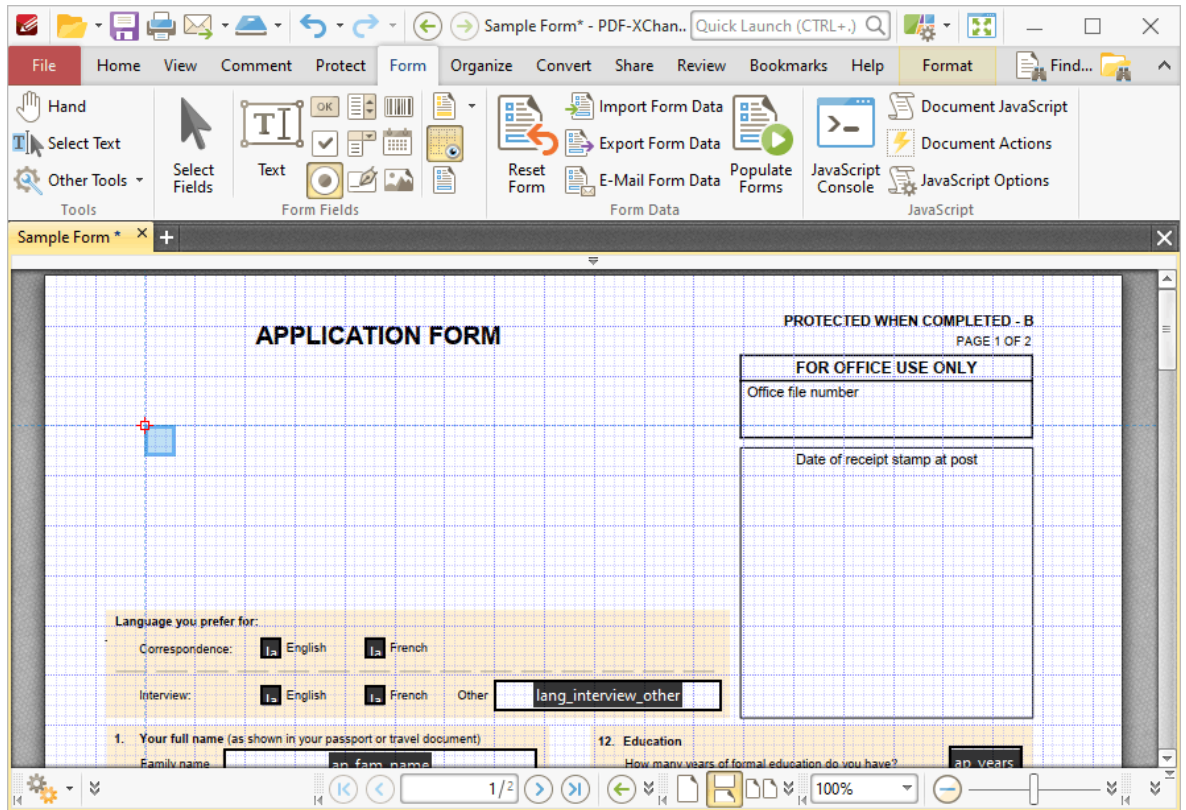

Figure 2. Active Radio Button Tool

2. Move the square to the desired location and then click to add the radio button to the document. Added radio buttons appear as detailed below:

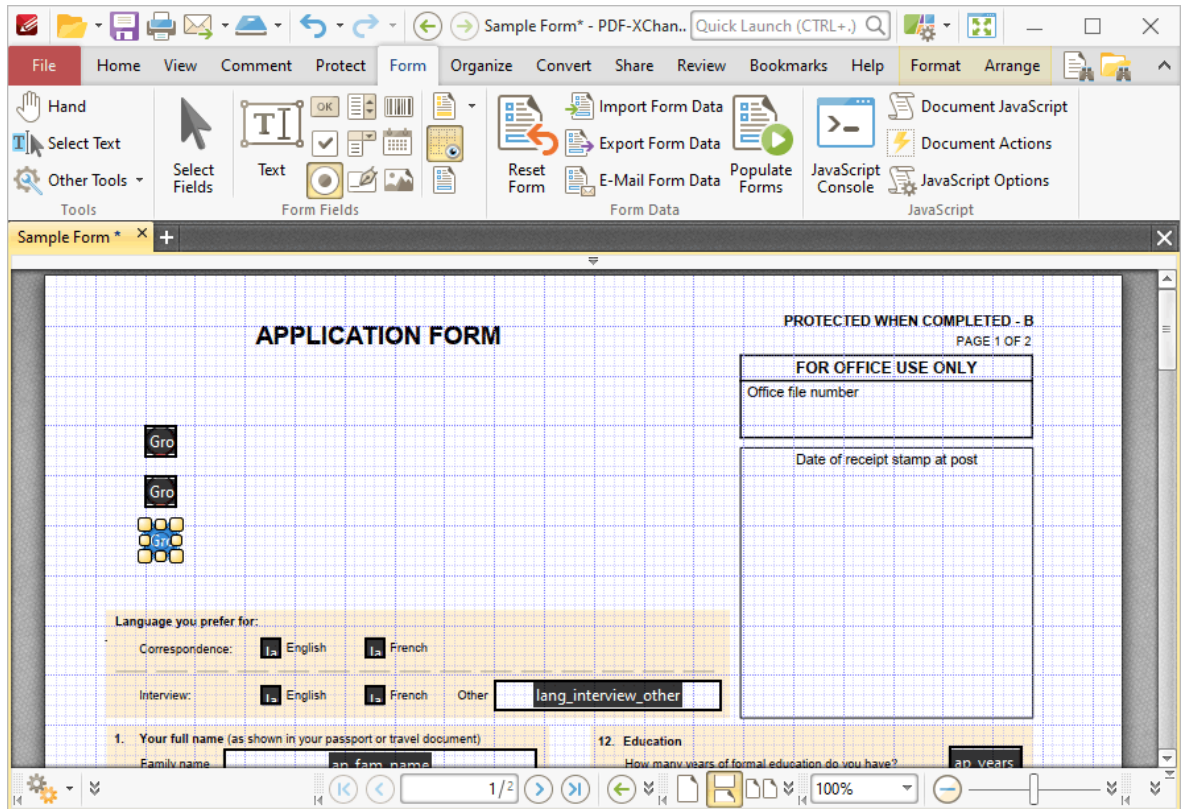

Figure 3. Added Radio Buttons

- Click and drag the yellow control points to resize radio buttons.
- Use the options in the **Format Tab** to determine the style and appearance of selected radio buttons:

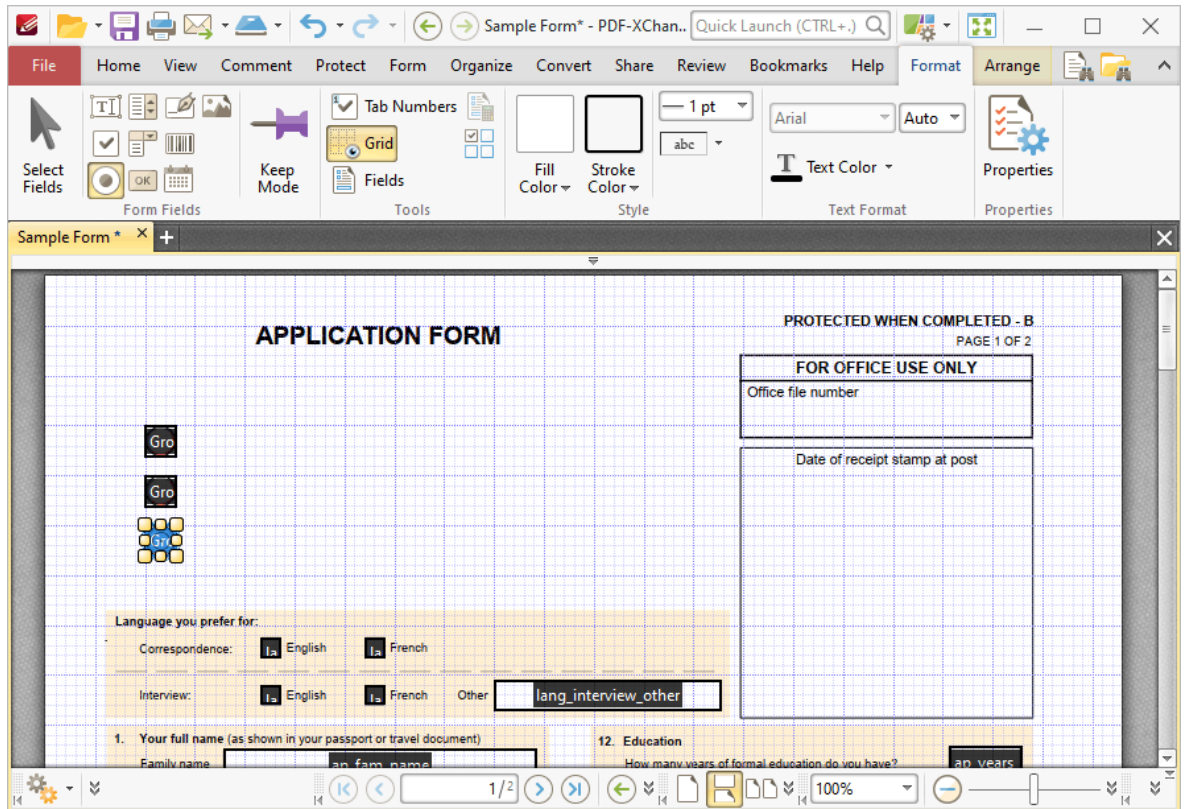

Figure 4. Format Tab, Radio Buttons

- Click **Select Fields** to select and edit form fields.
- Click the options in the **Form Fields** group to enable alternative form field formats.
- Click **Keep Mode** to create multiple radio buttons consecutively. If this option is disabled then **PDF-XChange Editor** will revert to the designated default tool after the creation of a single radio button.
- Click **Tab Numbers** to show/hide the tab order numbers of form fields.
- The **Calculation Order** setting is not available for radio buttons.
- Click **Grid** to enable/disable the grid, which is used to assist in the accurate placement of form fields, as detailed in **(figure 4)**.
- Click **Create Multiple Copies** to create multiple copies of selected form fields, as detailed [here](#).
- Click **Fields** to show/hide the **Fields** pane, which is used to view/edit form fields.
- Click **Fill Color** to determine the fill color of the radio button.
- Click **Stroke Color** to determine the border color of radio buttons.
- Click **Width** to determine the width of radio button borders.
- Click **Border** to determine the style of radio button borders.
- Use the **Text Color** dropdown menu to determine the color of the check mark used in radio buttons.

- Click **Properties** to open the **Radio Button Properties** pane, which enables the customization of additional elements of radio buttons and is detailed in the section below.

### ▼ The Radio Button Properties Pane

The **Radio Button Properties** pane can be used to determine a range of style and functionality options for radio buttons. For example, it is possible to use the **Actions** properties to add multiple dynamic actions to radio buttons, such as running JavaScript, launching web links and opening files on the local computer. (JavaScript is a high-level programming language that can be used to perform custom operations. See [here](#) for an index of existing JavaScript operations that the **PDF-XChange Editor** forms can use, as well as additional information about JavaScript). Click **Select Fields** to select form fields, then click the desired field and click **Properties** in the **Format** tab to open the **Radio Button Properties** pane:

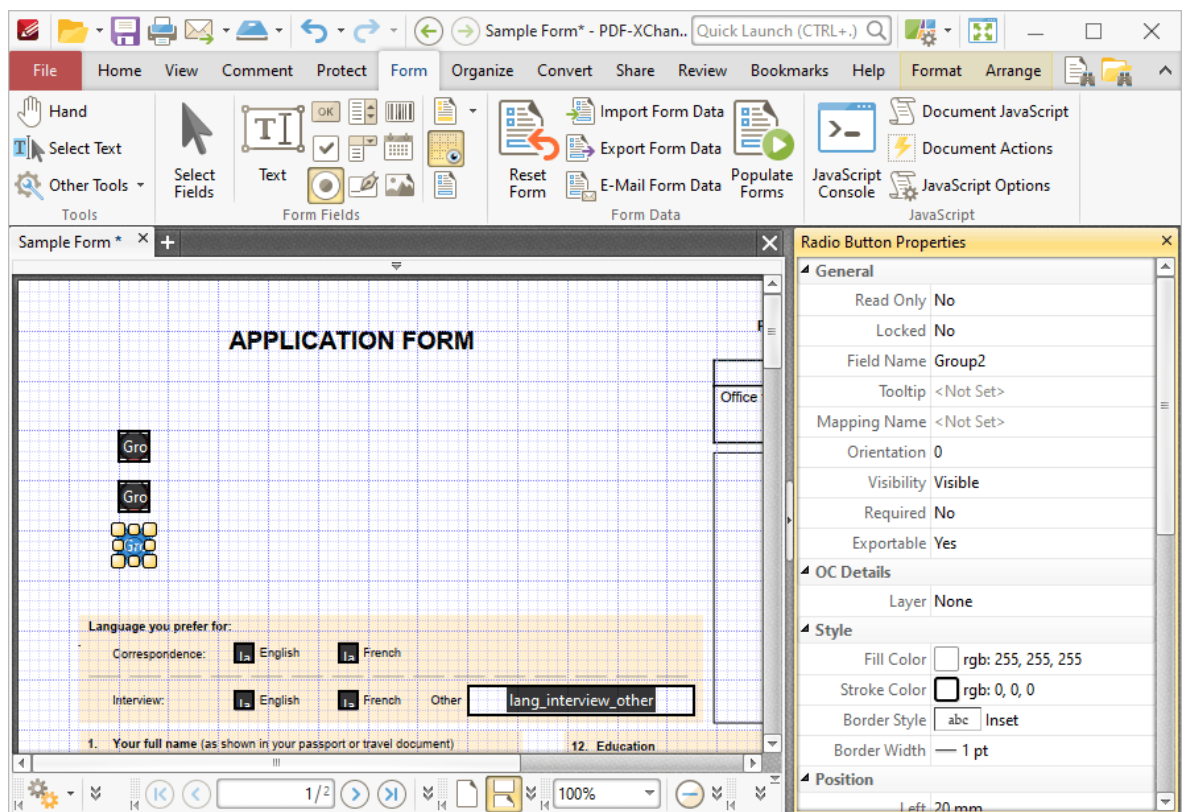

Figure 5. Radio Button Tool, Radio Button Properties Pane

The options detailed below are available in the **Radio Button Properties** pane:

The **General** properties determine the general parameters of radio buttons:

- **Read Only** determines whether or not the radio button can be edited.

- **Locked** determines whether or not the radio buttons can be moved, and whether or not their properties can be modified.
- **Field Name** determines the name of the radio button. This name is present when the **Select Fields** tool is enabled, and when radio buttons are listed in the **Fields pane**.<sup>1016</sup>
- **Tooltip** determines the information displayed when the pointer is hovered over the radio button.
- **Mapping Name** determines the mapping name that the radio button uses. This name is used to reference interactive form data when the form is exported, and does so without affecting the appearance of the name in the original document.
- **Orientation** determines the orientation of the radio button.
- **Visibility** determines the visibility of the radio button.
- **Required** determines whether or not the radio button is a required field. Required fields must be filled before documents that contain them can be submitted.
- **Exportable** determines whether or not the radio button data can be exported from the form.

The **OC Details** property determines the optional content layer to which the radio button belongs. When a field belongs to an optional content layer, it displays only when the layer is enabled. Use the **Layers** pane to view/create/edit layers, as detailed [here](#).<sup>1024</sup>

The **Style** properties determine stylistic elements of radio buttons. They are detailed beneath **(figure 4)**.

The **Position** properties determine the position and dimensions of radio buttons:

- **Left** determines the distance of the radio button from the left margin.
- **Top** determines the distance of the radio button from the bottom of the page.
- **Width/Height** determine the width/height of the radio button.

The **Default Text Format** properties determine the default properties when text is entered into the radio button:

- **Font Size** is always set to **auto** for radio buttons. This is because the font size refers to the size of the mark when radio buttons are selected, and the mark must be proportionate to the size of the radio button.
- **Text Color** determines the color of the tick when radio buttons are selected.

The **Options** properties determine additional options for radio buttons:

- **Radio Button Style** determines the icon used when radio buttons are selected.
- **Button Choice** is a unique identifier for the radio button and differentiates it from other radio buttons that have the same name.
- **In Unison** enables single-click selection for all radio buttons that share the same name and content as the selected radio button.
- **Checked by Default** determines whether or not the radio button is checked by default.

- The **Actions** properties determine the action taken when users interact with the radio button:
- **Mouse Down** initiates an action when the left mouse button is pressed (without being released).
  - **Mouse Up** initiates an action when the left mouse button is clicked (pressed and released).
  - **Mouse Enter** initiates an action when the pointer moves into the radio button.
  - **Mouse Leave** initiates an action when the pointer moves out of the radio button.
  - **On Focus** initiates an action when the radio button is selected.
  - **On Blur** initiates an action when the radio button is deselected.
  - Click the ellipsis icon on the right of actions to add/edit radio button actions:

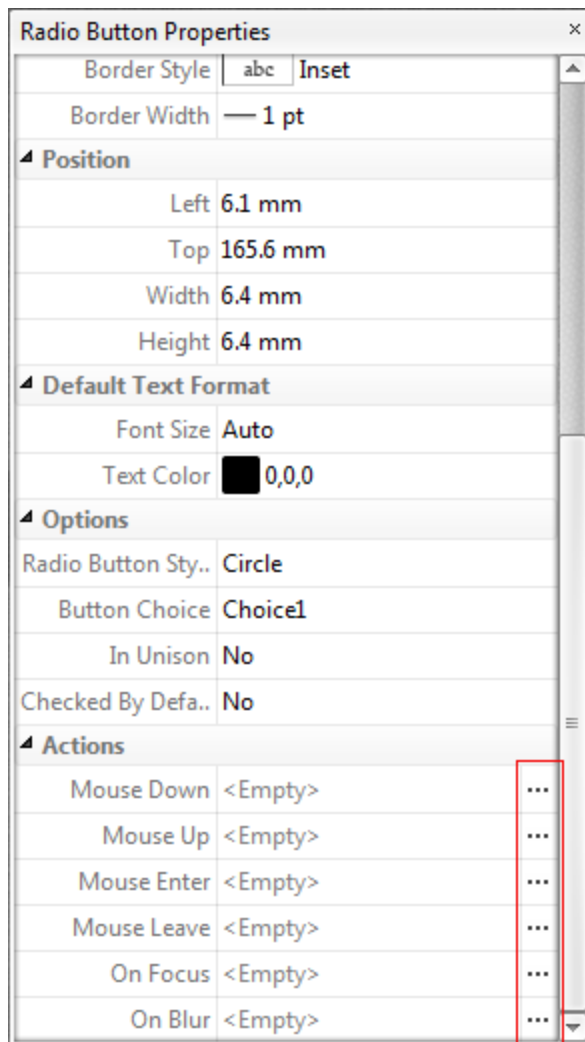

Figure 6. Radio Button Properties Pane, Action Ellipses

The process of adding actions is detailed [here](#). <sup>959</sup>

▼ **Example Radio Button List Creation**

The following example will detail how to create a radio button list of countries:

1. Click the **Form** tab, then click **Radio Button**.
2. Click the **Format** tab, then click **Keep Mode**:

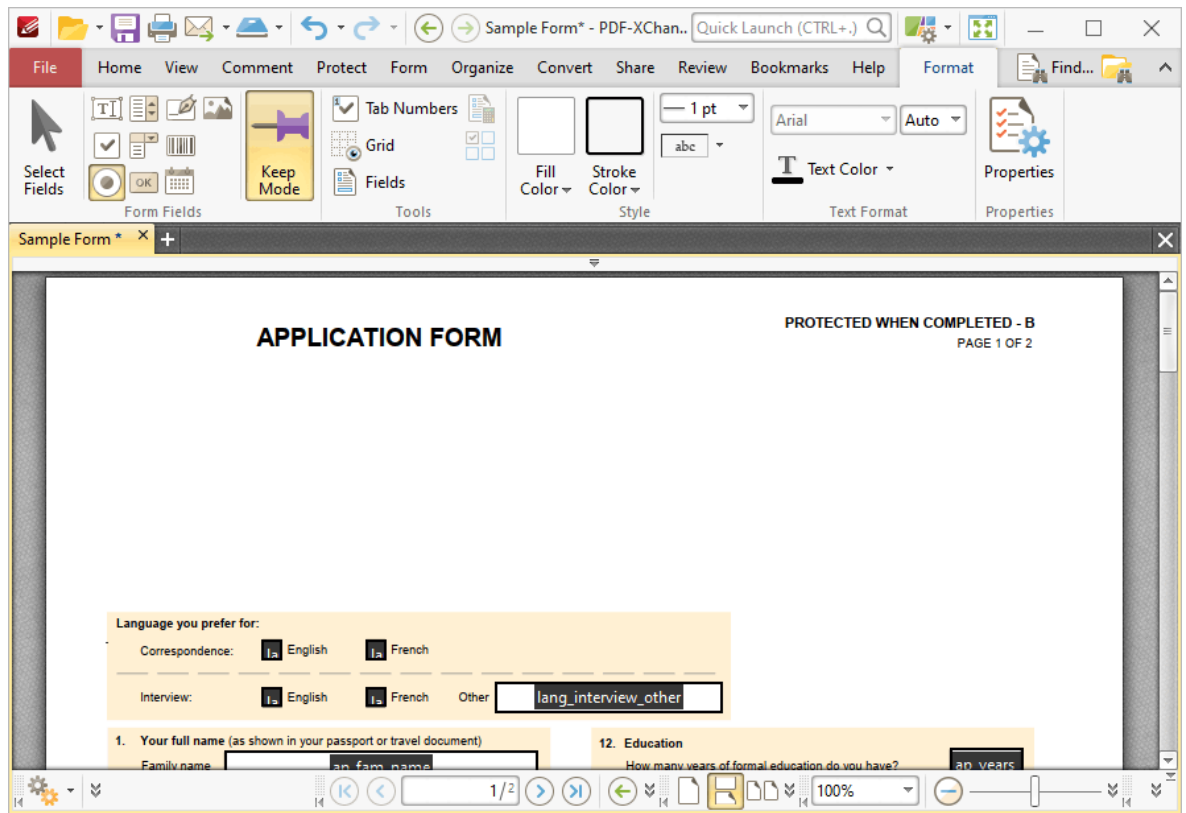

**Figure 7.** Format Tab, Keep Mode Highlighted

3. Press **Ctrl+#** to enable the grid in order to assist in the accurate placement of radio buttons, then click to place radio buttons in the document:



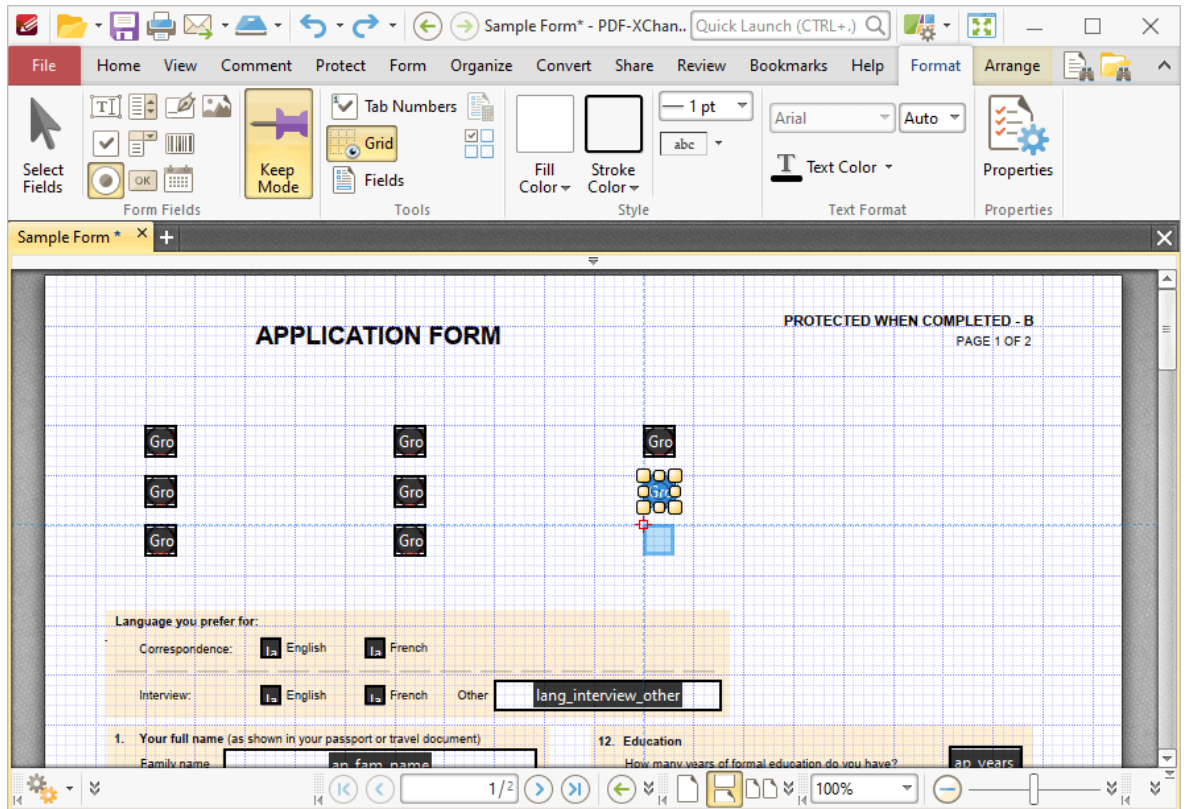

Figure 8. Adding Radio Buttons

The next step is to add text box labels for the radio buttons:

4. Click the **Comment** tab, then click the **Text Box Tool**. Click to add text boxes, then enter the names of the desired countries:

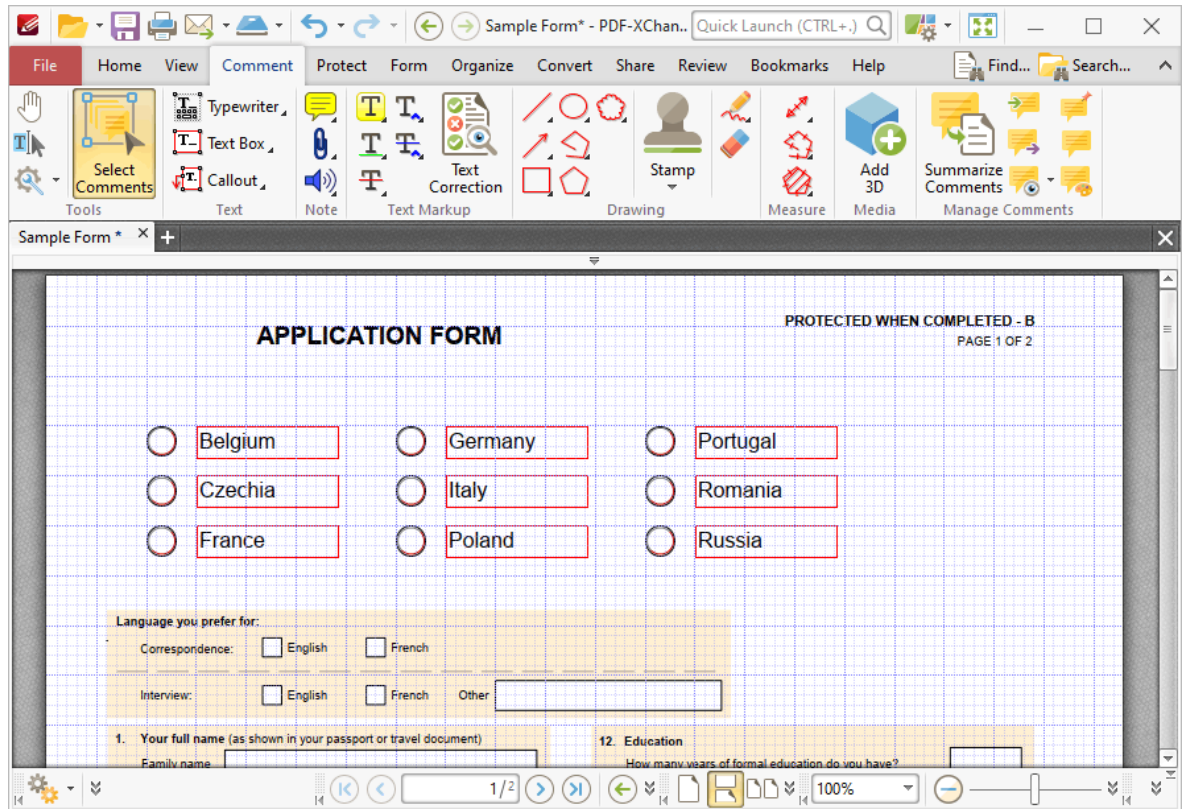

Figure 9. Text Boxes and Names Added

The text boxes can be customized as desired - for example the stroke color can be changed as follows:

5. Click **Select Comments**, then group-select the text boxes. Press Ctrl+' to open the properties pane, then change the **Stroke Color** property to white:

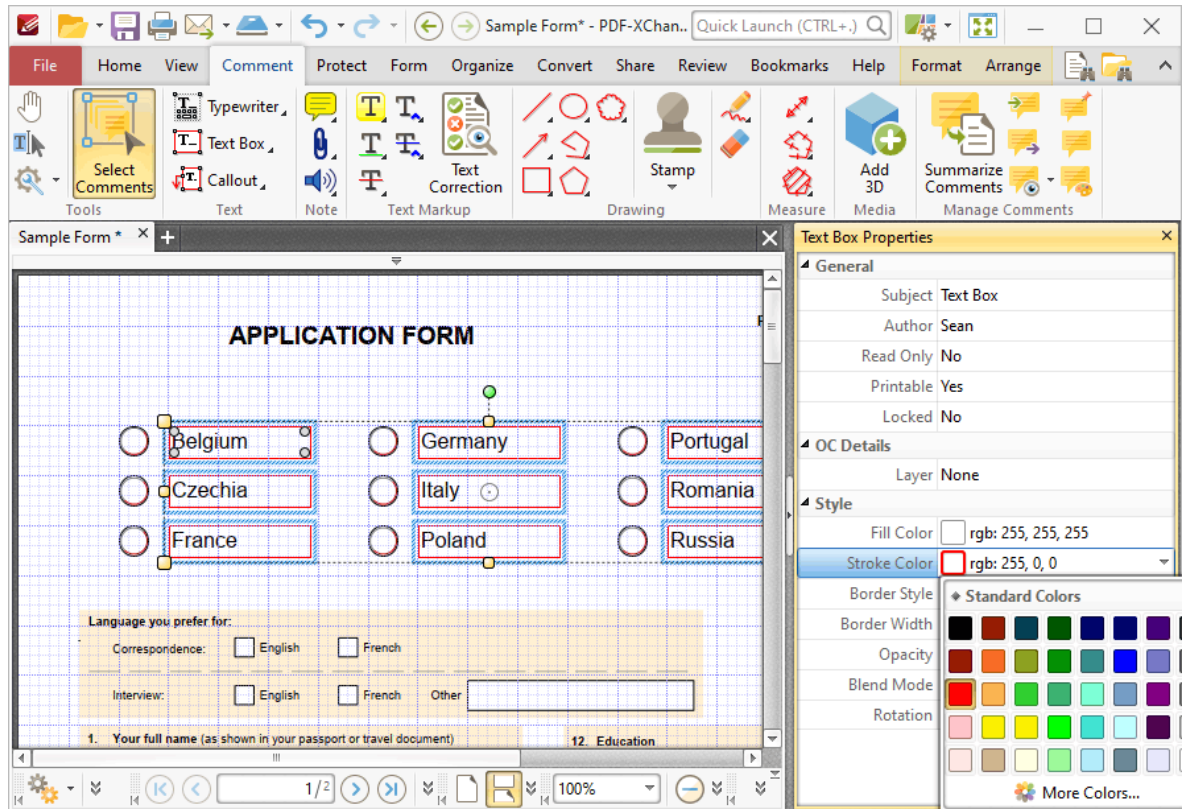

Figure 10. Text Box Properties Pane, Stroke Color Options

6. Press Ctrl+# to disable the grid. The radio button list is then complete. Use the **Hand Tool** to select an option as desired:

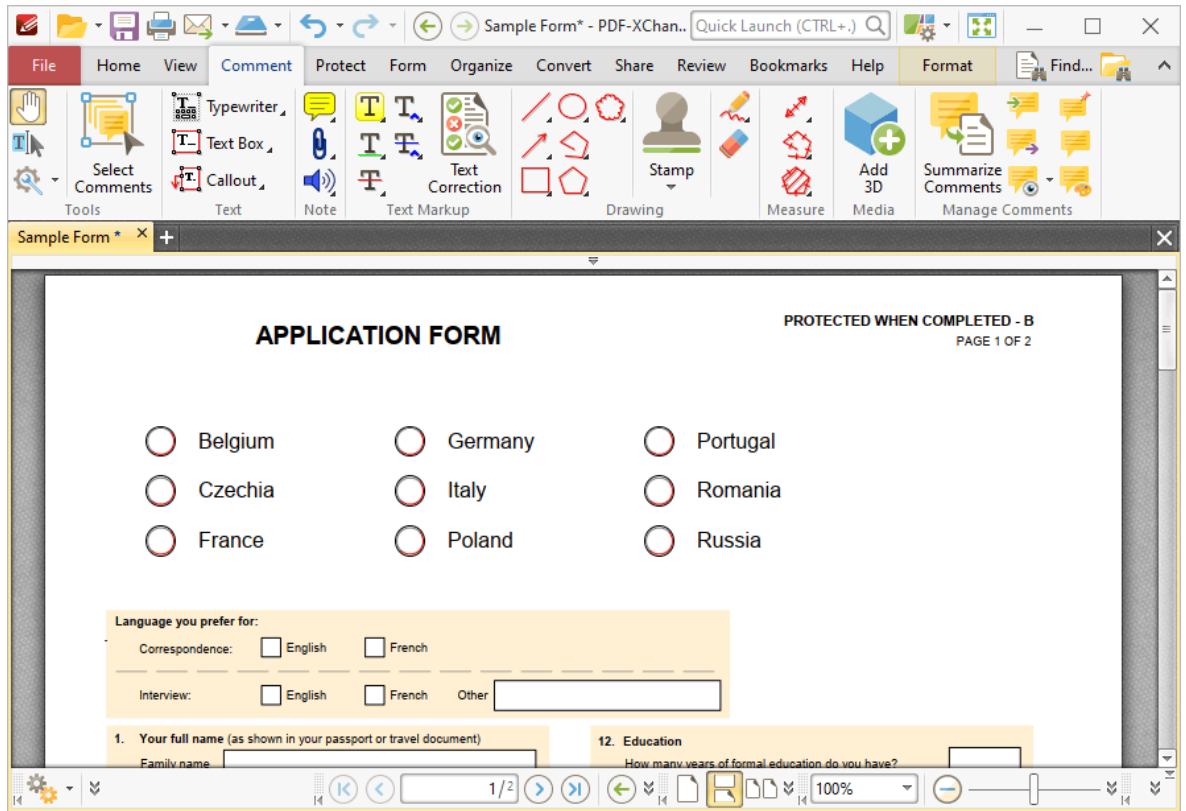

Figure 11. Completed Radio Button List

10.4.6.4 Add List Boxes to Documents



Add List Boxes to Documents

List boxes enable the selection of one or more options from a fixed list of options:

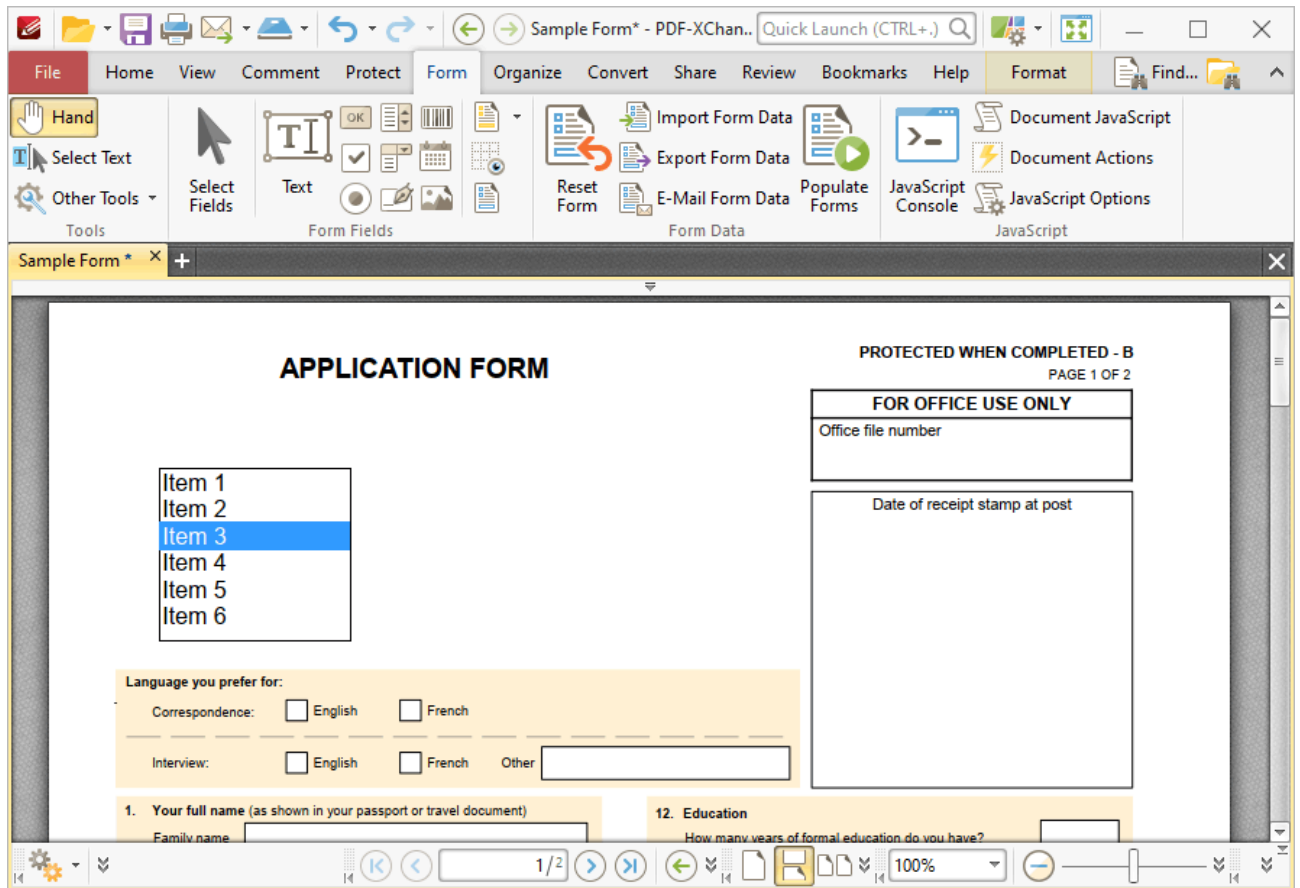

Figure 1. Example List Box

The functionality of **PDF-XChange Editor** enables a wide range of dynamic customization for list boxes. Click the dropdowns below for further information:

▼ Add List Boxes to Documents

1. Click the **Form** tab, then click **List Box**. A blue rectangle will be displayed beneath the pointer. This rectangle represents the list box:

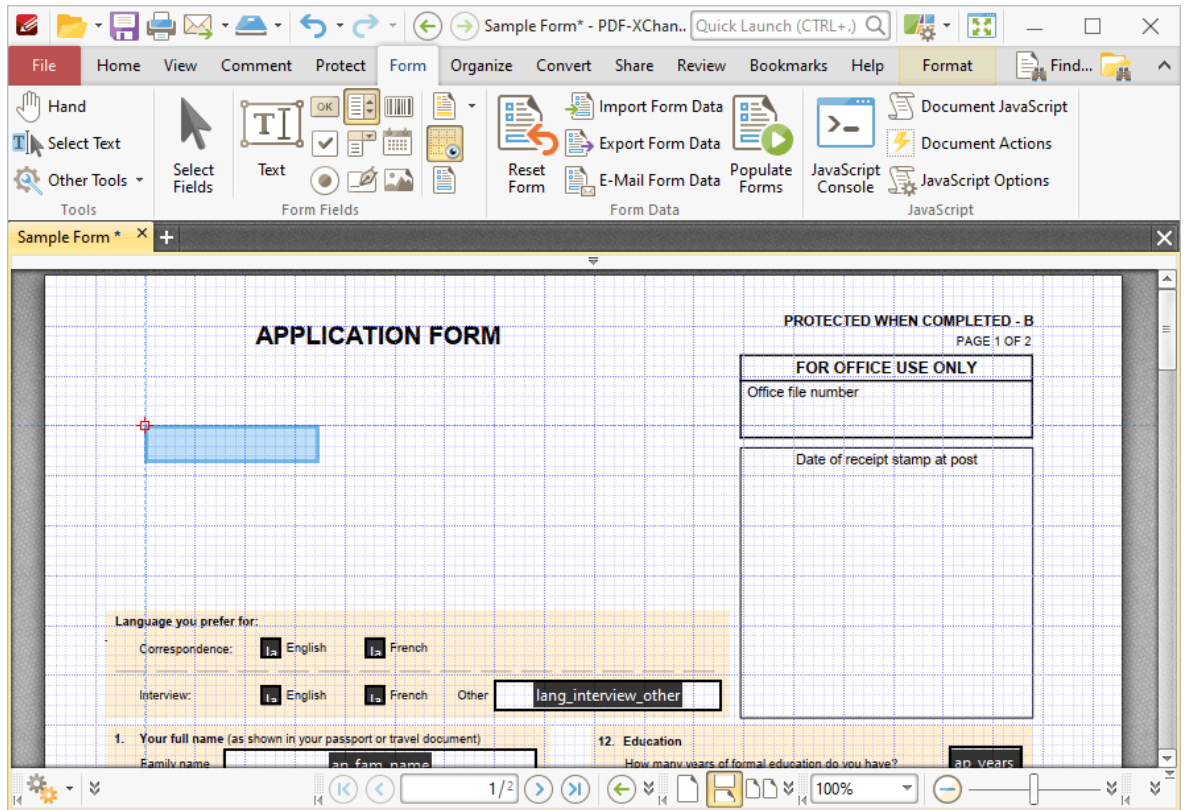

Figure 2. Active List Box Tool

2. Move the rectangle to the desired location and then click to add the list box to the document. Added list boxes appear as detailed below:

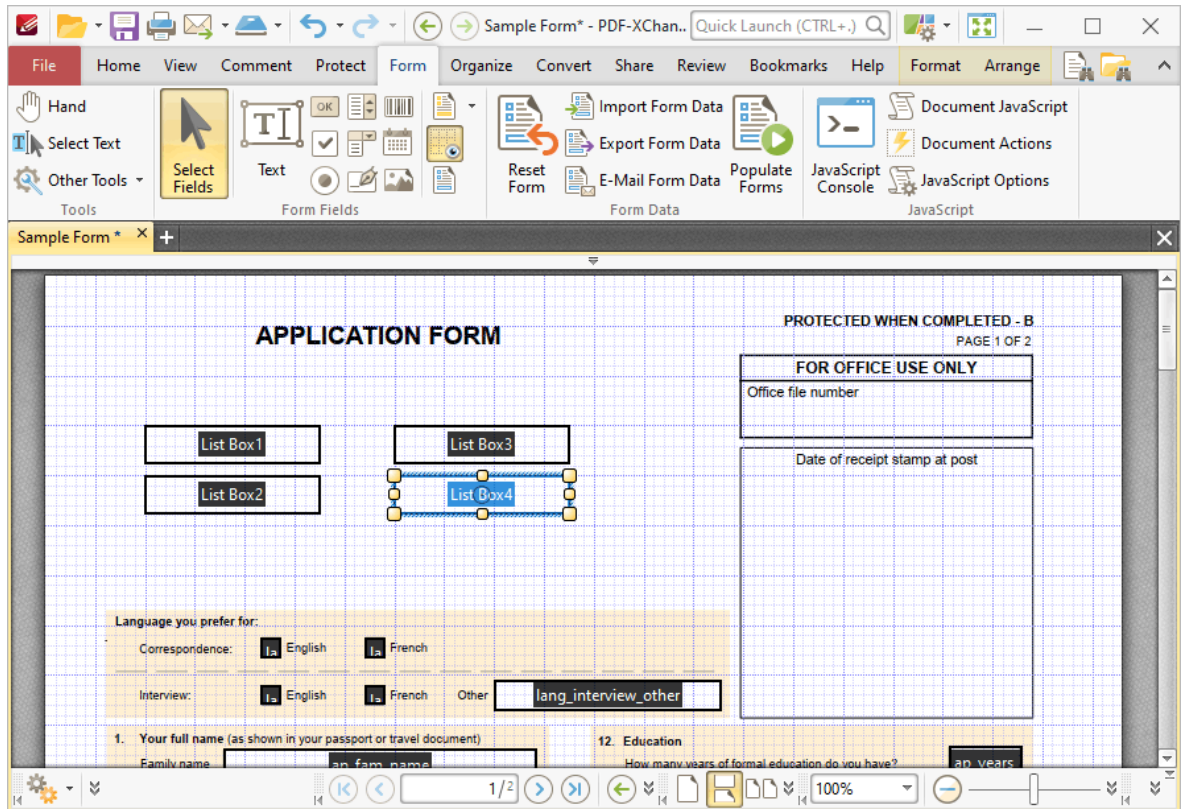

Figure 3. Added List Boxes

- Click and drag the yellow control points to resize list boxes.
- Use the options in the **Format Tab** to determine the style and appearance of selected list boxes:

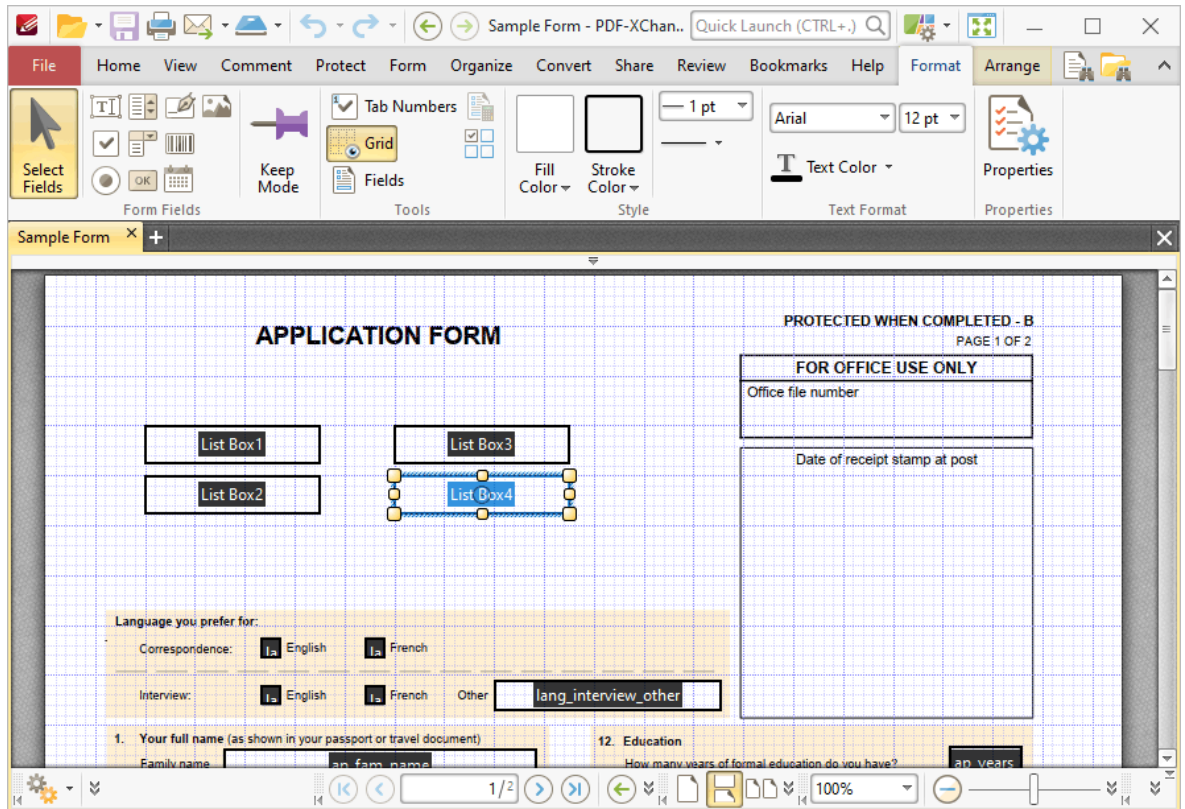

Figure 4. Format Tab, List Boxes

- Click **Select Fields** to select and edit form fields.
- Click the options in the **Form Fields** group to enable alternative form field formats.
- Click **Keep Mode** to create multiple list boxes consecutively. If this option is disabled then **PDF-XChange Editor** will revert to the designated default tool after the creation of a single list box.
- Click **Tab Numbers** to show/hide the tab order numbers of form fields.
- The **Calculation Order** setting is not available for list boxes.
- Click **Grid** to enable/disable the grid, which is used to assist in the accurate placement of form fields, as detailed in **(figure 4)**.
- Click **Create Multiple Copies** to create multiple copies of selected form fields, as detailed [here](#).
- Click **Fields** to show/hide the **Fields** pane, which is used to view/edit form fields.
- Click **Fill Color** to determine the fill color of the list box.
- Click **Stroke Color** to determine the border color of list boxes.
- Click **Width** to determine the width of list box borders.
- Click **Border** to determine the style of list box borders.
- Use the **Font** and **Font Size** dropdown menus to determine the font and font size used for list box items.



- Use the **Text Color** dropdown menu to determine the color of the font used in list box items.
- Click **Properties** to open the **List Box Properties** pane, which enables the customization of additional elements of list boxes and is detailed in the section below.

### ▼ The List Box Properties Pane

The **List Box Properties** pane can be used to determine a range of style and functionality options for list boxes. For example, it is possible to use the **Actions** properties to add multiple dynamic actions to list boxes, such as running JavaScript, launching web links and opening files on the local computer. (JavaScript is a high-level programming language that can be used to perform custom operations. See [here](#) for an index of existing JavaScript operations that the **PDF-XChange Editor** forms can use, as well as additional information about JavaScript). Click **Select Fields** to select form fields, then click the desired field and click **Properties** in the **Format** tab to open the **List Box Properties** pane:

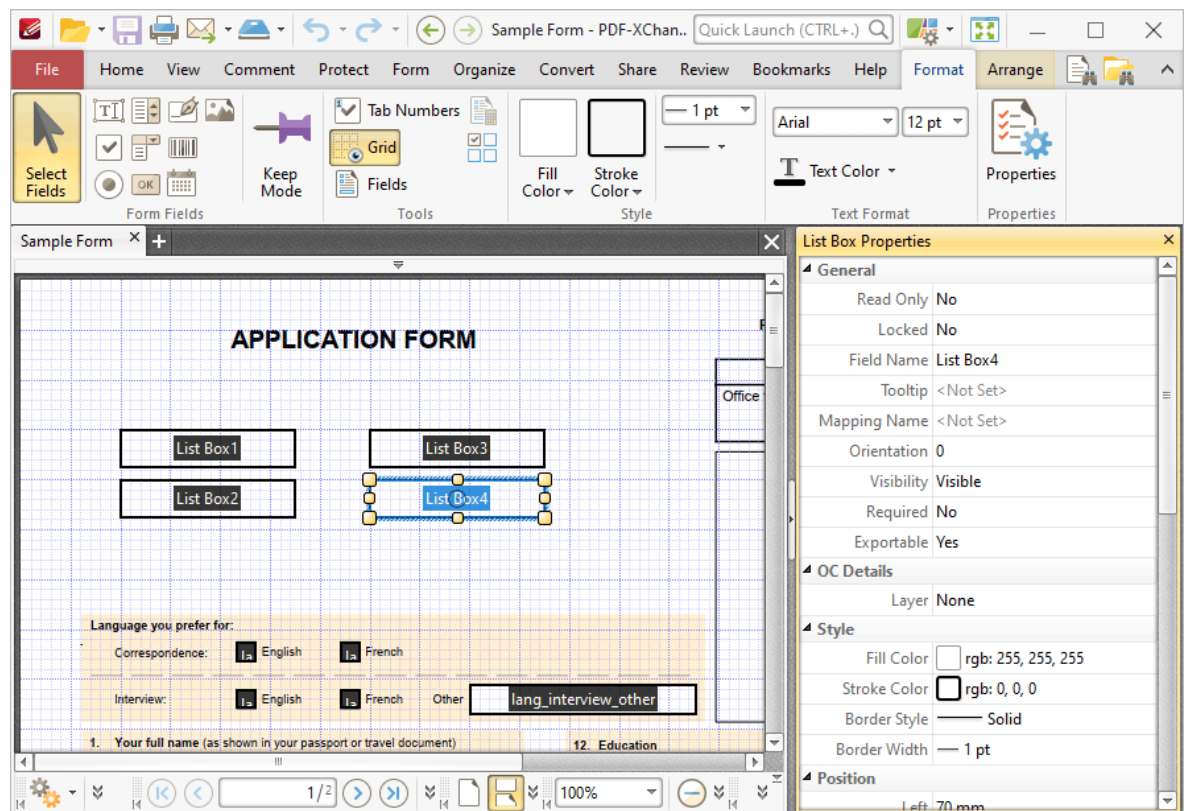

Figure 5. List Box Tool, List Box Properties Pane

The options detailed below are available in the **List Box Properties** pane:

The **General** properties determine the general parameters of list boxes:

- **Read Only** determines whether or not the list box can be edited.

- **Locked** determines whether or not the list box can be moved, and whether or not its properties can be modified.
- **Field Name** determines the name of the list box. This name is present when the **Edit Form** tool is selected, and when list boxes are listed in the **Fields pane**.<sup>1016</sup>
- **Tooltip** determines the information displayed when the pointer is hovered over the list box.
- **Mapping Name** determines the mapping name that the list box uses. This name is used to reference interactive form data when the form is exported, and does so without affecting the appearance of the name in the original document.
- **Orientation** determines the orientation of the list box.
- **Visibility** determines the visibility of the list box.
- **Required** determines whether or not the list box is a required field. Required fields must be filled before documents that contain them can be submitted.
- **Exportable** determines whether or not the list box data can be exported from the form.

The **OC Details** property determines the optional content layer to which the list box belongs. When a field belongs to an optional content layer, it displays only when the layer is enabled. Use the **Layers** pane to view/create/edit layers, as detailed [here](#).<sup>1024</sup>

The **Style** properties determine stylistic elements of list boxes. They are detailed beneath **(figure 4)**.

The **Position** properties determine the position and dimensions of list boxes:

- **Left** determines the distance of the list box from the left margin.
- **Top** determines the distance of the list box from the bottom of the page.
- **Width/Height** determine the width/height of the list box.

The **Default Text Format** properties determine the default properties when text is entered into the list box:

- **Font** determines the font used to create the list box entries.
- **Font Size** determine the size of the font used to create the list box entries.
- **Text Color** determines the color of the font used to create the list box entries.

The **Options** properties determine additional options for list boxes:

- **List Box Items** determine the options in the list box. See below for an example on how to add/edit options in the list box.
- **Sort Items** arranges the listed items numerically and/or alphabetically. Note that numerical sorts are performed before alphabetical sorts in cases where both sorts apply.
- **Multiple Selection** enables the selection of multiple list box entries.
- **Immediately Commit** saves selected values as soon as they are selected. If this option is not enabled then the value is saved only when the user tabs out of the current

field/clicks a different form field. Please note that this option is not available when the **Multiple Selection** property is enabled.

The **Actions** properties determine the action taken when users interact with the list box:

- **Mouse Down** initiates an action when the left mouse button is pressed (without being released).
- **Mouse Up** initiates an action when the left mouse button is clicked (pressed and released).
- **Mouse Enter** initiates an action when the pointer moves into the list box.
- **Mouse Leave** initiates an action when the pointer moves out of the list box.
- **On Focus** initiates an action when the list box is selected.
- **On Blur** initiates an action when the list box is deselected.
- The **Selection Change** property initiates a JavaScript action when the selection in the list box is changed. Click the ellipsis icon to add custom JavaScript. The **Edit Action: "Run a JavaScript"** dialog box will open. Enter the desired JavaScript for the action and then click **OK**:

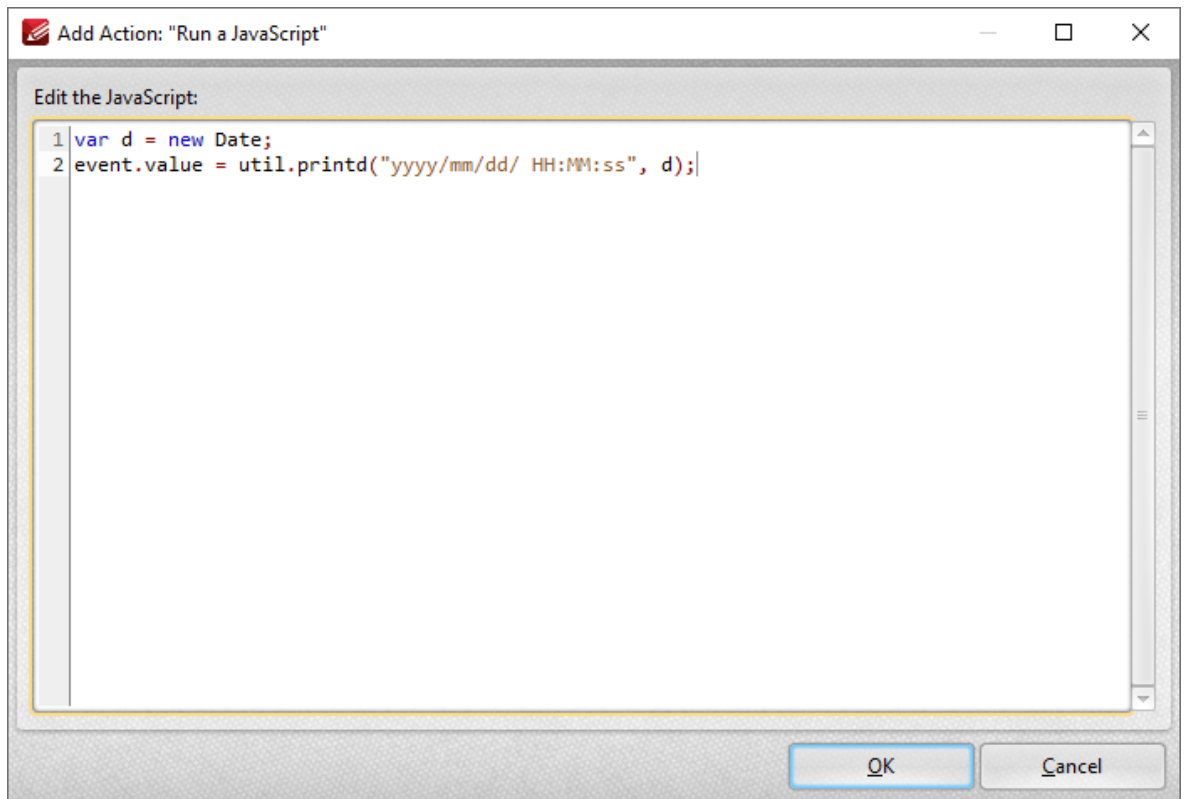

**Figure 6.** Edit Action: "Run a JavaScript" Dialog Box

Click the ellipsis icon on the right of actions to add/edit list box actions:

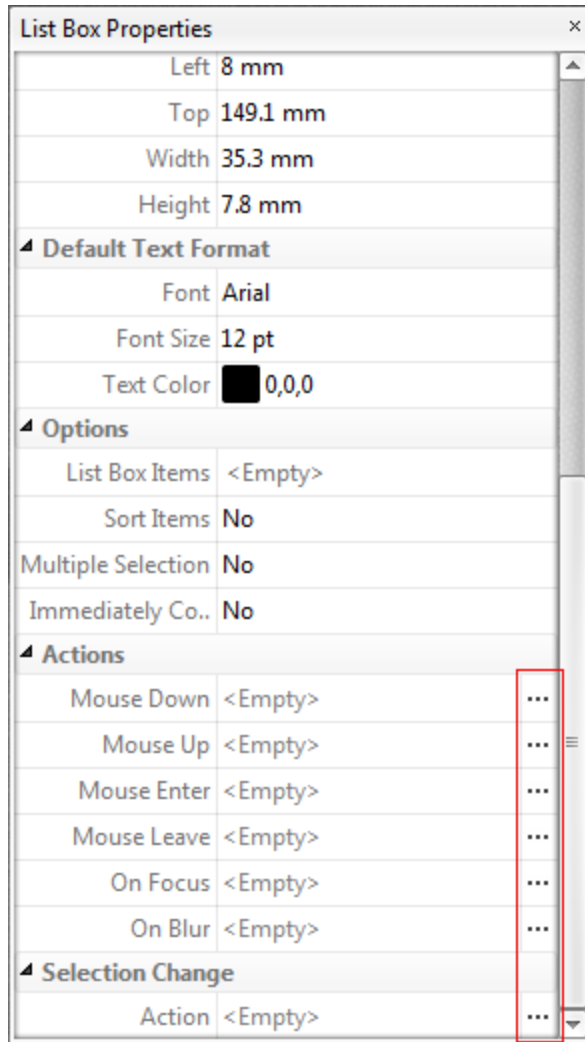

Figure 7. List Box Properties Pane, Action Ellipses

The process of adding actions is detailed [here](#).<sup>959</sup>

▼ **Adding and Editing List Box Items**

Follow the steps below to add/edit list box items:

1. Click **Select Fields** in the **Form** tab and select the list box, then click the **Format** tab and click **Properties**:

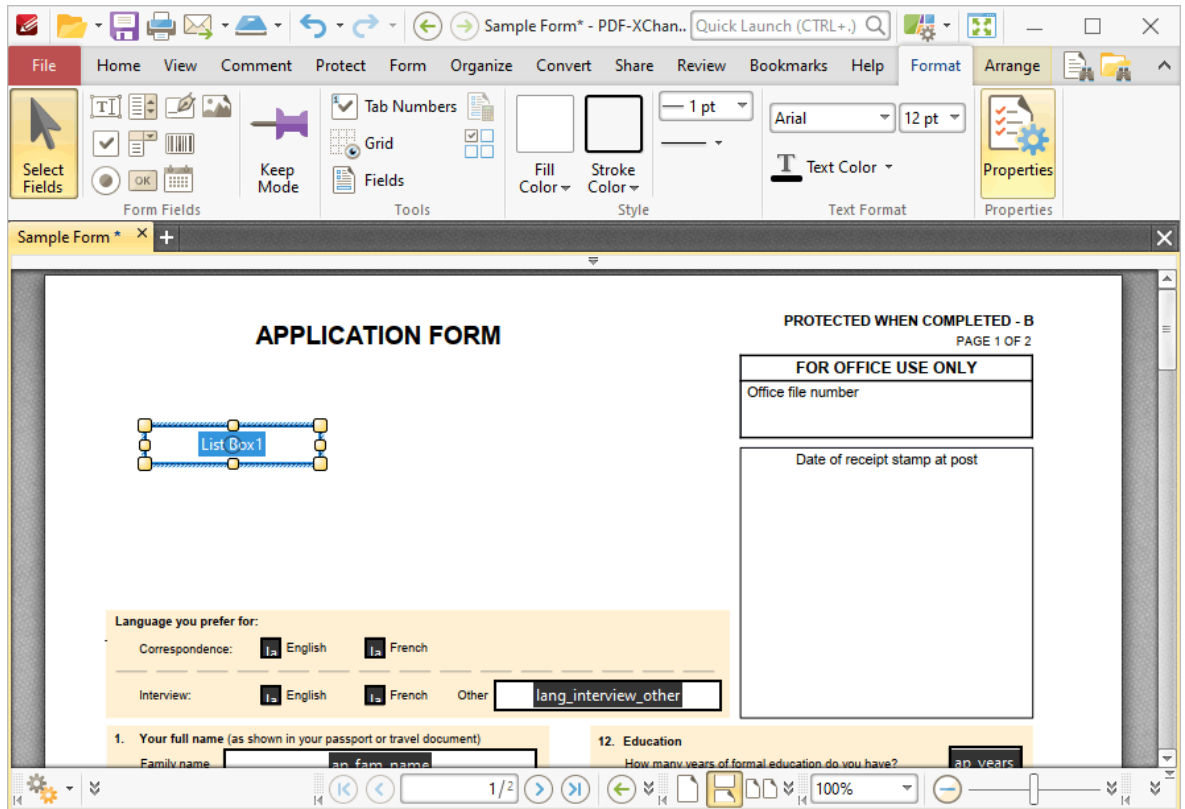

Figure 8. Selected List Box

The **List Box Properties** pane will open.

2. Scroll down to the **List Box Items** property and click **<Empty>**:

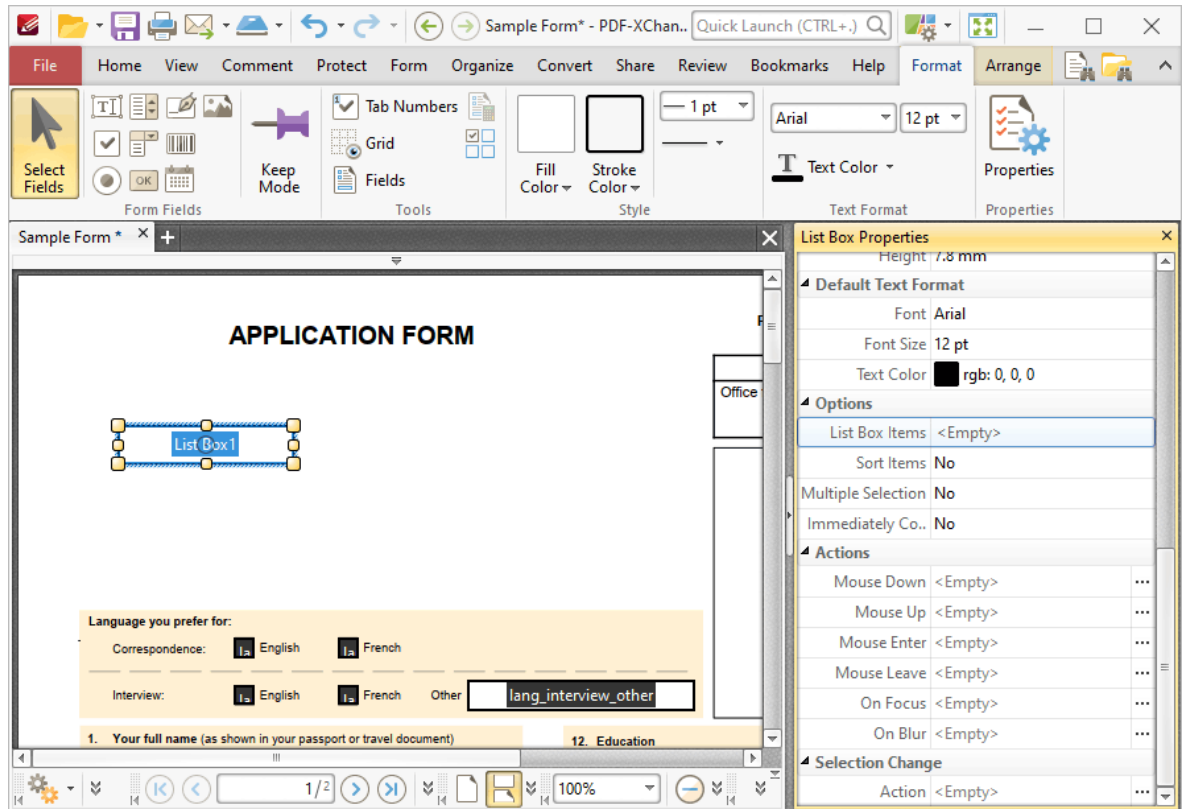

Figure 9. List Box Properties Pane, List Box Items Property

The **List Box** pane will open. This pane is used to add/edit list box items.

3. Click **Add New** to add new entries to the list box:

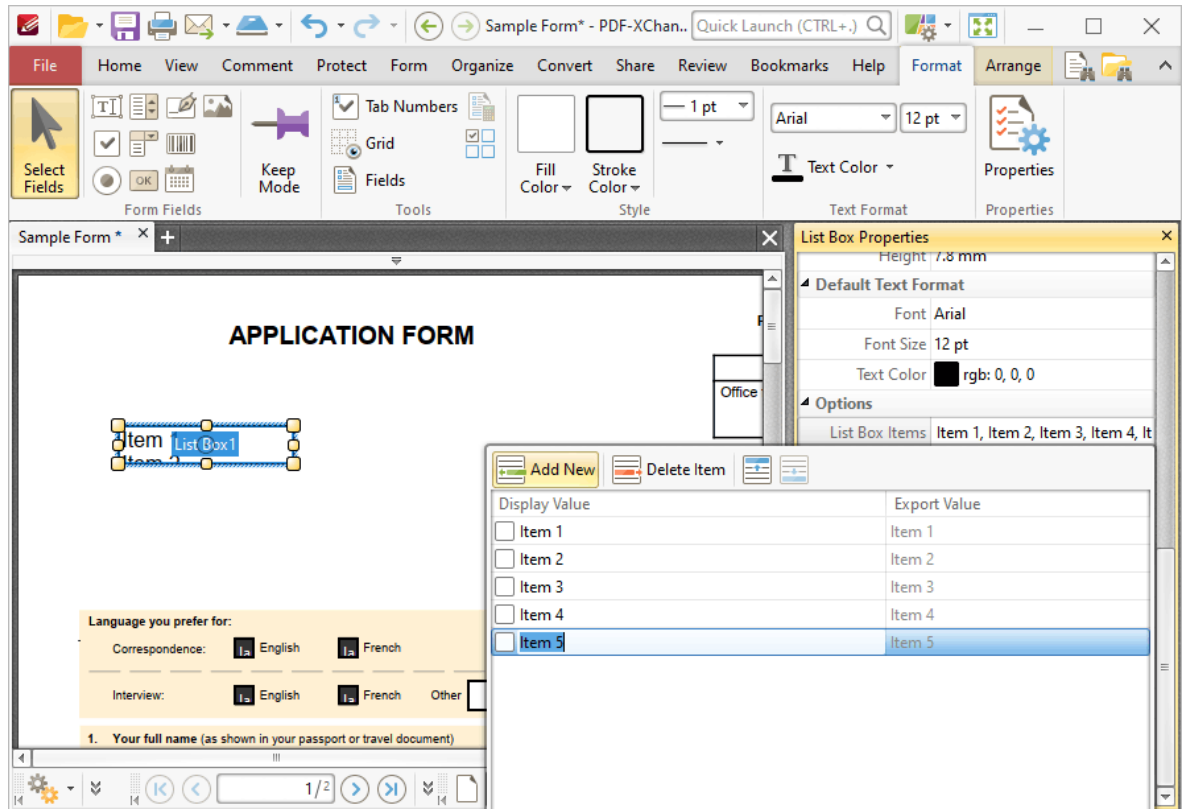

Figure 10. List Box Pane

- Click **Delete Item** to delete the selected item from the list box.
- Click the **Up** and **Down** buttons to move selected items up or down in the list. The order of items in the pane represents the order to items in the list box.
- Enter values in the **Export Value** column to determine the value given for exported list box items. Note that values must be first selected in the **List Box Items** pane and then clicked in order to edit the name.
- Click to select **Display Value** names, and then click them again in order to edit the name.
- Select the check box of the item to be used as the default selection in the list box. This item will be selected when the list box is in its default state.
- Click and drag the yellow control points to resize the list box as desired.

4. Click outside the **List Box Items** pane to complete the process, then use the **Hand Tool** to select list box items:

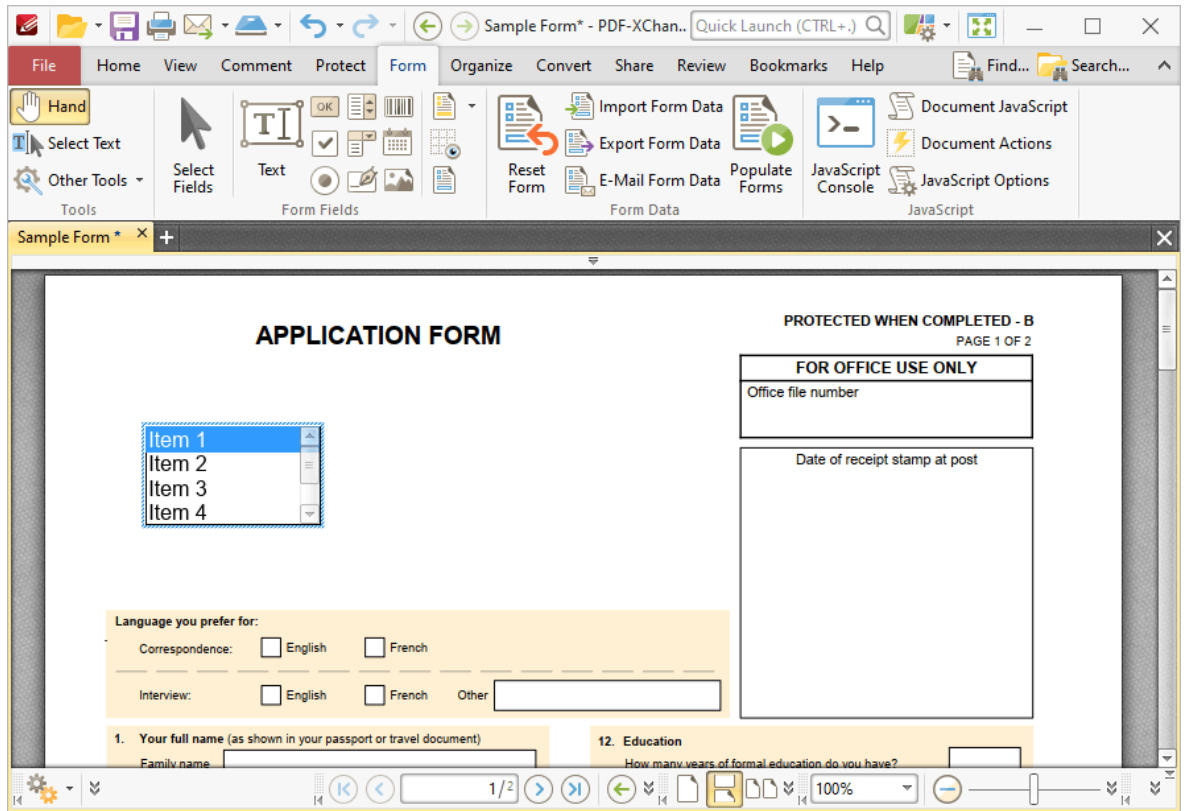

Figure 11. Completed List Box



### 10.4.6.5 Add Dropdown Menus to Documents



## Add Dropdown Menus to Documents

Dropdown menus enable the selection of one option from a fixed list of options:

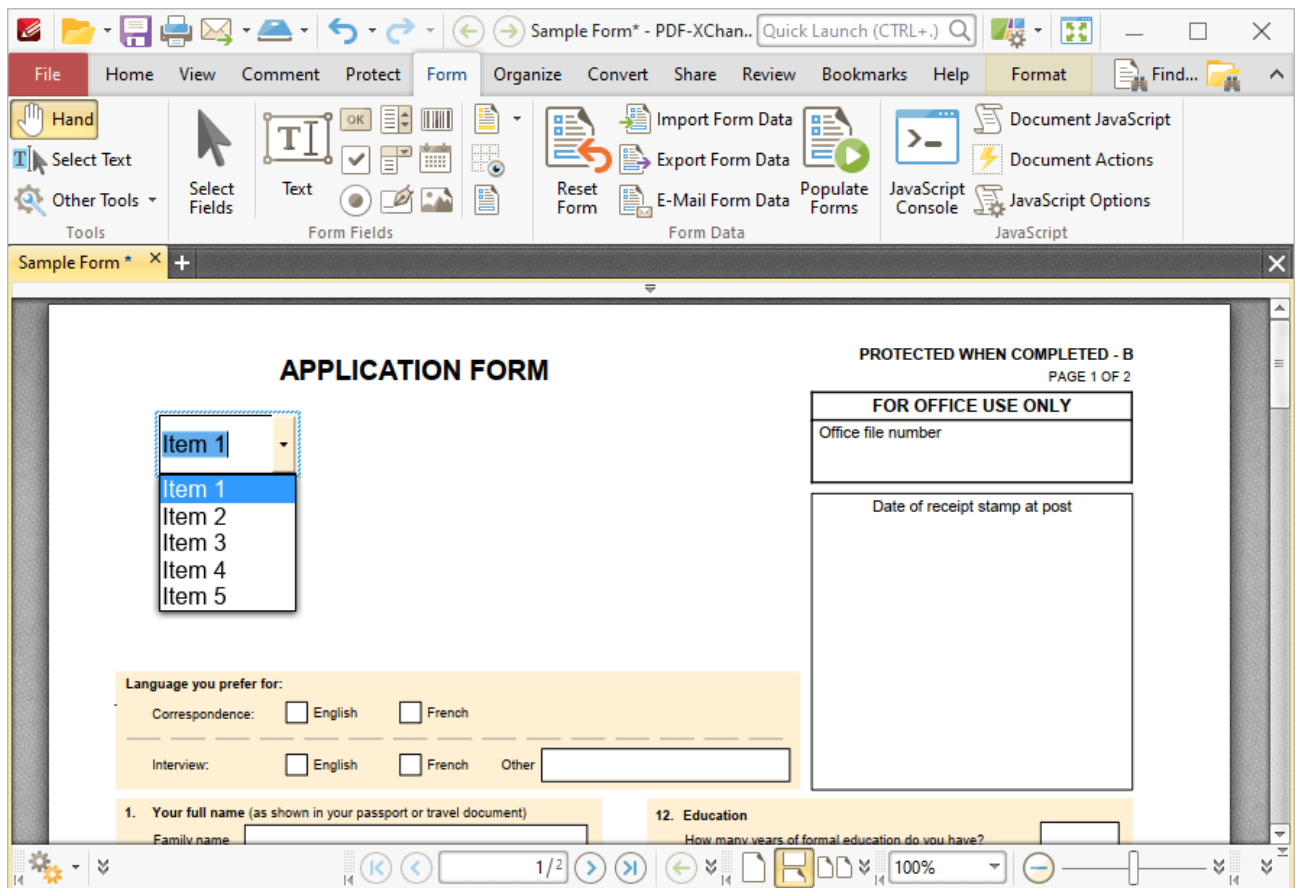

Figure 1. Example Dropdown Menu

The functionality of **PDF-XChange Editor** enables a wide range of dynamic customization for dropdown menus. Click the dropdowns below for further information:

#### ▼ Add Dropdown Menus to Documents

1. Click the **Form** tab, then click the **Dropdown** icon (highlighted in the image below). A blue rectangle will be displayed at the location of the pointer. This rectangle represents the dropdown menu:

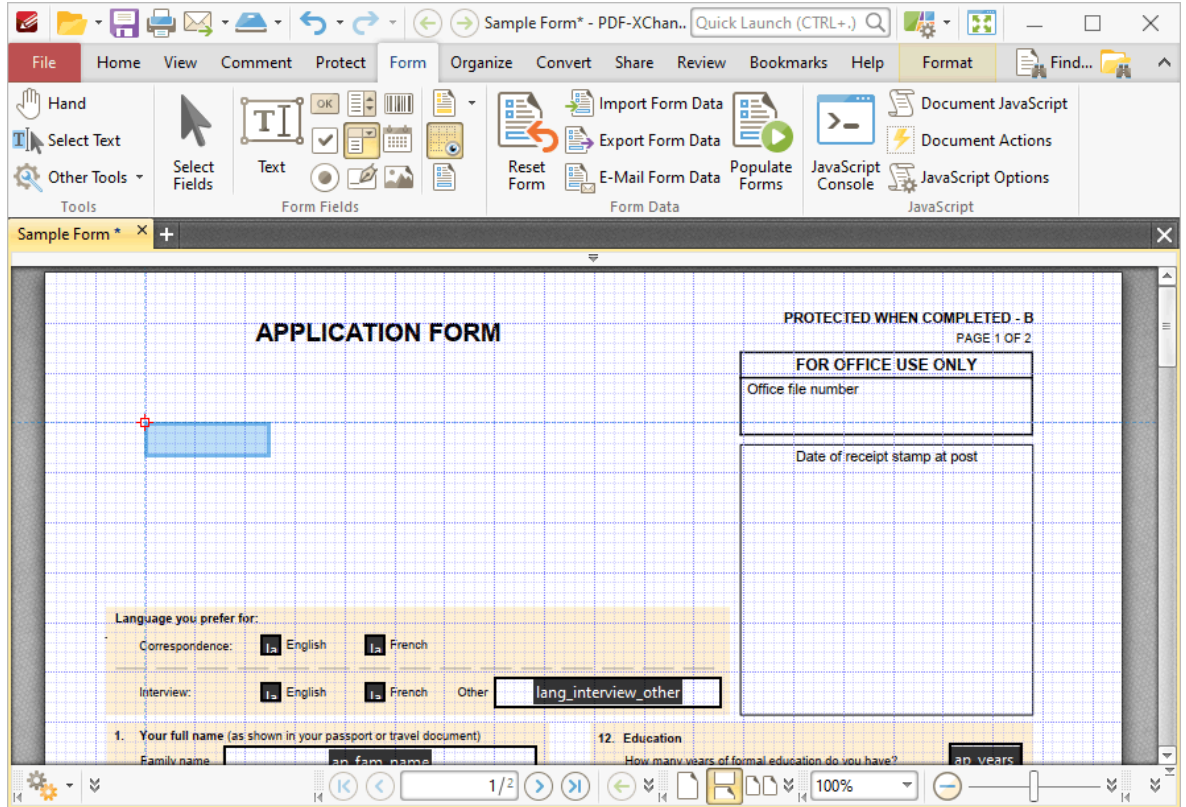

Figure 2. Active Dropdown Menu Tool

2. Move the rectangle to the desired location and then click to add the dropdown menu to the document. Added dropdown menus appear as detailed below:

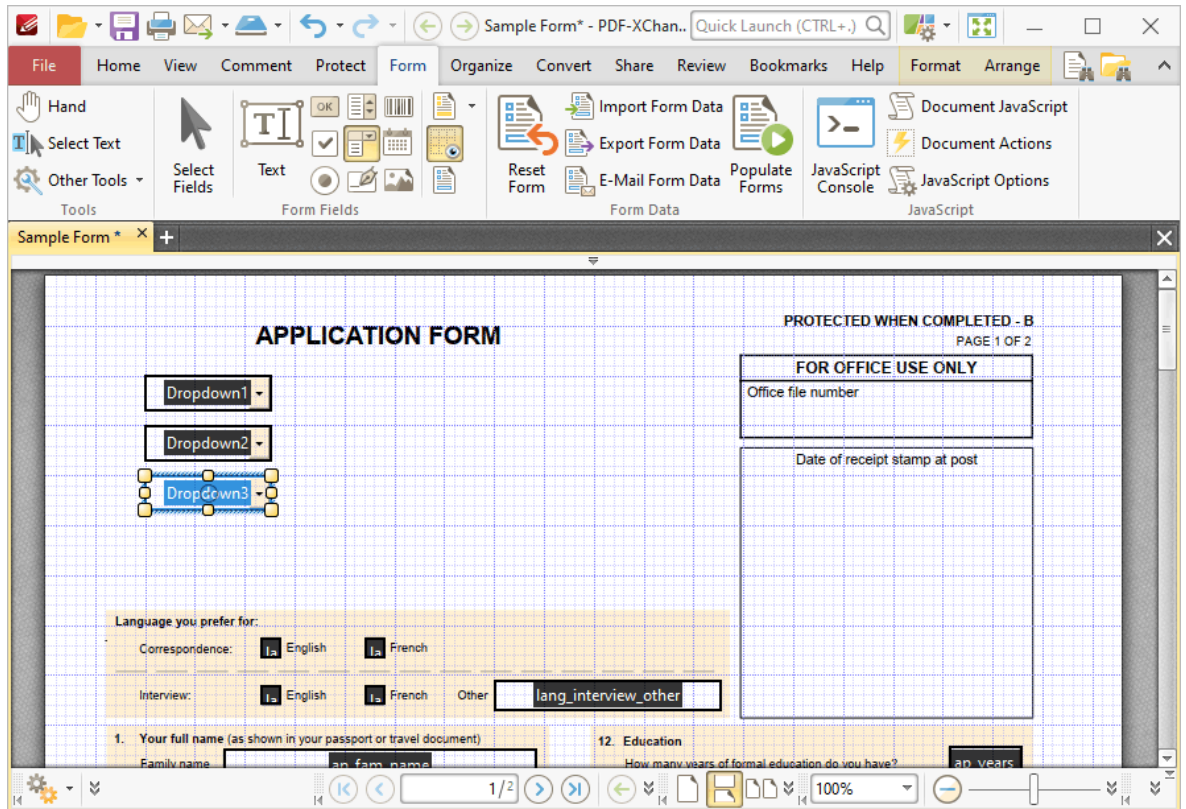

Figure 3. Added Dropdown Menus

- Click and drag the yellow control points to resize dropdown menus.
- Use the options in the **Format Tab** to determine the style and appearance of selected dropdown menus:

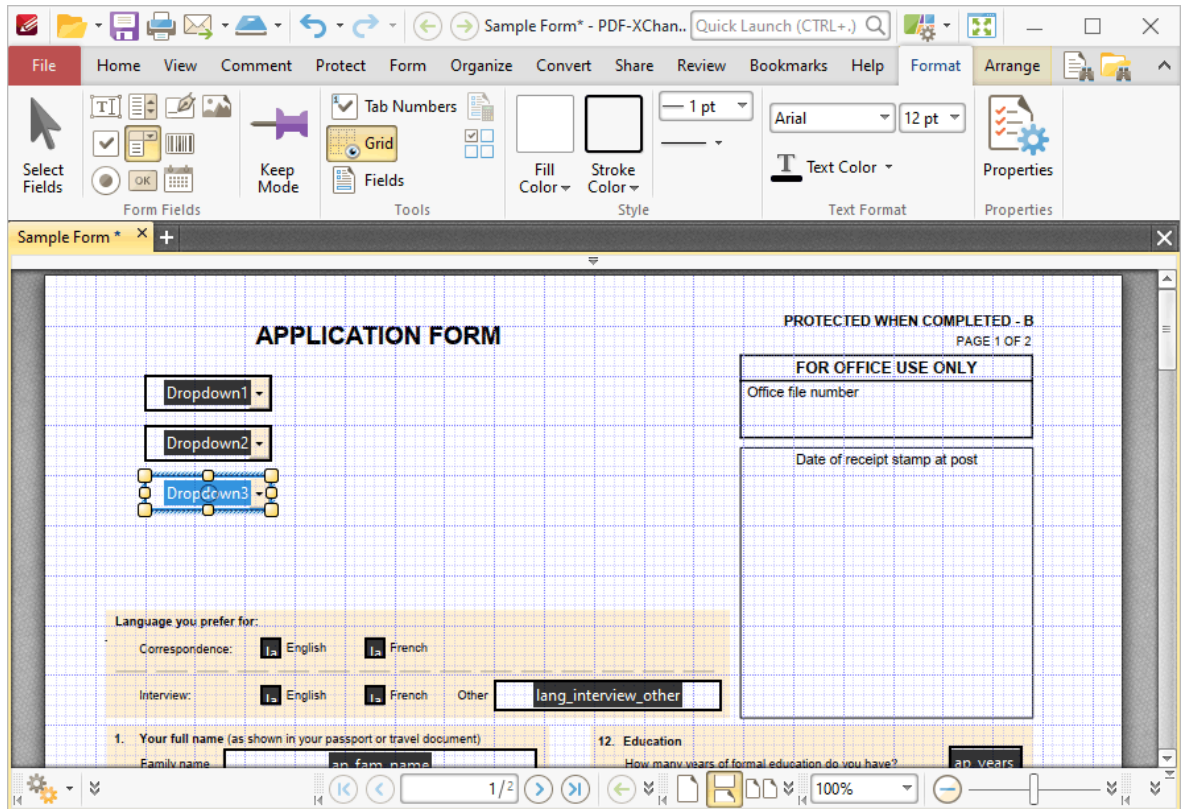

Figure 4. Format Tab, Dropdown Menus

- Click **Select Fields** to select and edit form fields.
- Click the options in the **Form Fields** group to enable alternative form field formats.
- Click **Keep Mode** to create multiple dropdown menus consecutively. If this option is disabled then **PDF-XChange Editor** will revert to the designated default tool after the creation of a single dropdown menu.
- Click **Tab Numbers** to show/hide the tab order numbers of form fields.
- The **Calculation Order** setting is not available for dropdown menus.
- Click **Grid** to enable/disable the grid, which is used to assist in the accurate placement of form fields, as detailed in *(figure 4)*.
- Click **Create Multiple Copies** to create multiple copies of selected form fields, as detailed [here](#).
- Click **Fields** to show/hide the **Fields** pane, which is used to view/edit form fields.
- Click **Fill Color** to determine the fill color of the dropdown menu.
- Click **Stroke Color** to determine the border color of dropdown menus.
- Click **Width** to determine the width of dropdown menu borders.
- Click **Border** to determine the style of dropdown menu borders.
- Use the **Font** and **Font Size** dropdown menus to determine the font and font size used for dropdown menu items.

- Use the **Text Color** dropdown menu to determine the color of the font used in dropdown menu items.
- Click **Properties** to open the **Dropdown Properties** pane, which enables the customization of additional elements of dropdown menus and is detailed in the section below.

### ▼ The Dropdown Properties Pane

The **Dropdown Properties** pane can be used to determine a range of style and functionality options for dropdown menus. For example, it is possible to use the **Actions** properties to add multiple dynamic actions to dropdown menus, such as running JavaScript, launching web links and opening files on the local computer. (JavaScript is a high-level programming language that can be used to perform custom operations. See [here](#) for an index of existing JavaScript operations that the **PDF-XChange Editor** forms can use, as well as additional information about JavaScript). Click **Select Fields** to select form fields, then click the desired field and click **Properties** in the **Format** tab to open the **Dropdown Properties** pane:

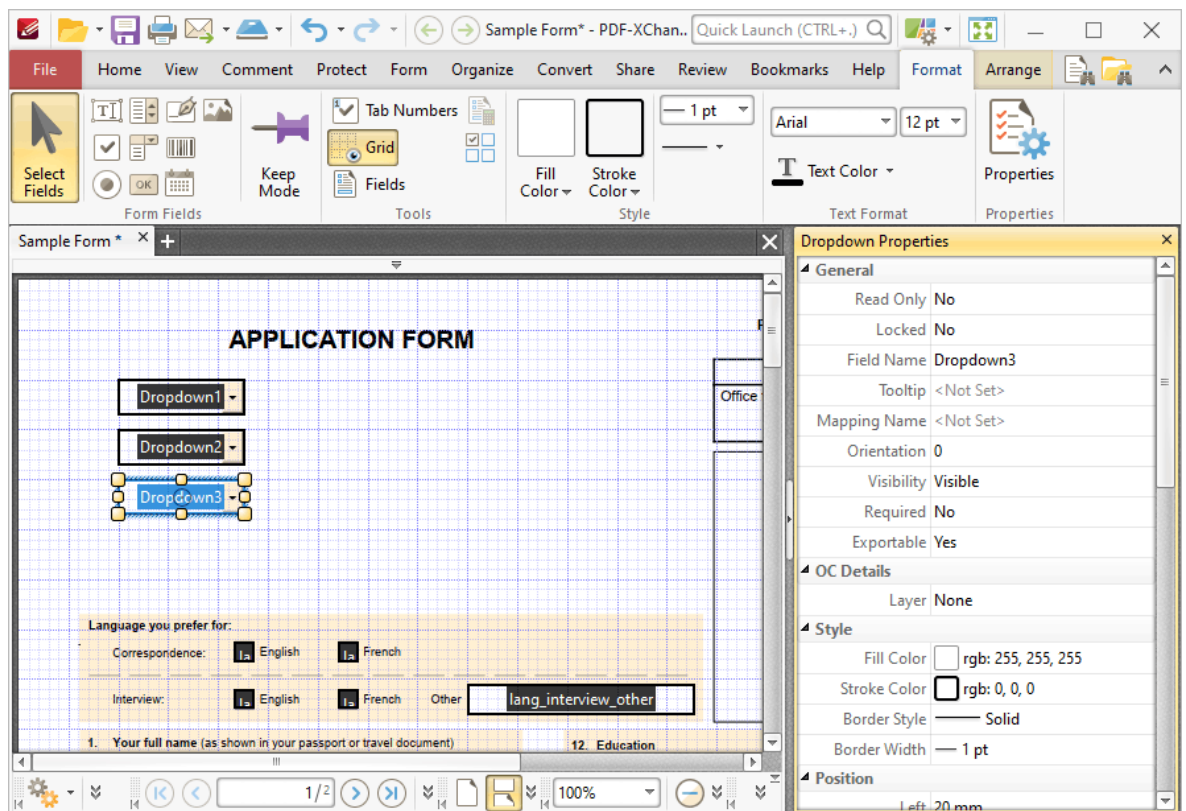

Figure 5. Dropdown Menu Tool, Dropdown Properties Pane

The options detailed below are available in the **Dropdown Properties** pane:

The **General** properties determine the general parameters of dropdown menus:

- **Read Only** determines whether or not the dropdown menu can be edited.

- **Locked** determines whether or not the dropdown menu can be moved, and whether or not its properties can be modified.
- **Field Name** determines the name of the dropdown menu. This name is present when the **Edit Form** tool is selected, and when dropdown menus are listed in the [Fields pane](#).<sup>1016</sup>
- **Tooltip** determines the information displayed when the pointer is hovered over the dropdown menu.
- **Mapping Name** determines the mapping name that the dropdown menu uses. This name is used to reference interactive form data when the form is exported, and does so without affecting the appearance of the name in the original document.
- **Orientation** determines the orientation of the dropdown menu.
- **Visibility** determines the visibility of the dropdown menu.
- **Required** determines whether or not the dropdown menu is a required field. Required fields must be filled before documents that contain them can be submitted.
- **Exportable** determines whether or not the dropdown menu data can be exported from the form.

The **OC Details** property determines the optional content layer to which the dropdown menu belongs. When a field belongs to an optional content layer, it displays only when the layer is enabled. Use the **Layers** pane to view/create/edit layers, as detailed [here](#).<sup>1024</sup>

The **Style** properties determine stylistic elements of dropdown menus. They are detailed beneath [\(figure 4\)](#).

The **Position** properties determine the position and dimensions of dropdown menus:

- **Left** determines the distance of the dropdown menu from the left margin.
- **Top** determines the distance of the dropdown menu from the bottom of the page.
- **Width/Height** determine the width/height of the dropdown menu.

The **Default Text Format** properties determine the default properties when text is entered into the dropdown menu:

- **Font** determines the font used to create the dropdown menu entries.
- **Font Size** determine the size of the font used to create the dropdown menu entries.
- **Text Color** determines the color of the font used to create the dropdown menu entries.

The **Options** properties determine additional options for dropdown menus:

- **Combo Box Items** determine the options in the dropdown menu. See below for an example on how to add/edit options in the dropdown menu.
- **Sort Items** arranges the listed items numerically and/or alphabetically. Note that numerical sorts are performed before alphabetical sorts in cases where both sorts apply.

- **Allow Edit** enables a text box at the top of dropdown menus that can be used to enter custom values as the value of the dropdown menu:

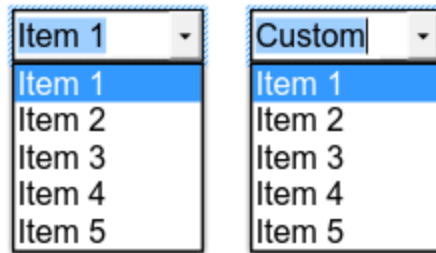

Figure 6. Standard Dropdown (left) and Allow Edit Dropdown (right)

Please note that this property can also be used to give dropdown menus a title that is different from the entries that it contains. An example of this process is detailed below.

- **Check Spelling** is available only when the **Allow Edit** property is enabled, and auto-checks the spelling of custom values entered into dropdown menus.
- **Immediately Commit** saves selected values as soon as they are selected. If this option is not enabled then the value is saved only when the user tabs out of the current field/clicks a different form field.

The **Actions** properties determine the action taken when users interact with the dropdown menu:

- **Mouse Down** initiates an action when the left mouse button is pressed (without being released).
- **Mouse Up** initiates an action when the left mouse button is clicked (pressed and released).
- **Mouse Enter** initiates an action when the pointer moves into the dropdown menu.
- **Mouse Leave** initiates an action when the pointer moves out of the dropdown menu.
- **On Focus** initiates an action when the dropdown menu is selected.
- **On Blur** initiates an action when the dropdown menu is deselected.
- Click the ellipsis icon on the right of actions to add/edit dropdown menu actions:

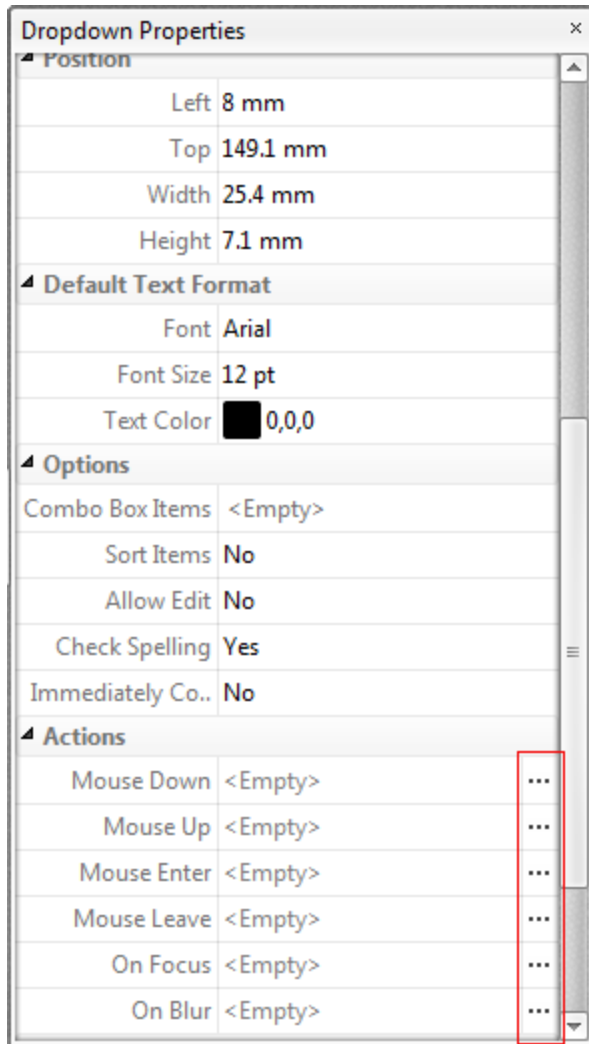

Figure 7. Dropdown Properties Pane, Action Ellipses

The process of adding actions is detailed [here](#).<sup>959</sup>

The **Format Value** properties determine the type of information permitted to be entered in the dropdown menu and the format in which it should be entered. This setting applies to both predefined items in the dropdown list, and custom entries entered when the **Allow Edit** property is enabled:

- **Category** determines the category of the dropdown menu. Each category has different options, as detailed below:
  - **None** is the default setting. Dropdown menu do not have a **Format Value** category when this option is selected.
  - **Number** sets the dropdown menu input to numerical values. The following options are available for this setting:
    - **Decimal Places** determines the number of decimal places displayed.
    - **Separator Style** determines the separators used for numbers.



- **Currency Symbol** determines the currency symbol used in the dropdown menu.
- **Symbol Location** determines the location of the currency symbol in relation to the number.
- **Add Space** inserts a space between the currency symbol and the number.
- **Negative Number Style** determines how numbers with negative values are displayed.
- **Percentage** sets the dropdown menu input to percentage values. The following options are available for this setting:
  - **Decimal Places** determines the number of decimal places permitted.
  - **Separator Style** determines the separator used for numbers.
- **Date** sets the dropdown menu input to date values and adds a dropdown calendar to the dropdown menu. Use the **Date Format** parameter to determine the format of dates.
- **Time** sets the dropdown menu input to time values (hours and minutes). Use the **Time Format** parameters to determine the format of time values.
- **Special** sets the dropdown menu input values to one of the special options. Use the **Special Format** parameter to determine the format. The options are:
  - **ZIP Code**
  - **ZIP Code +4**, which is used for nine-digit postal codes.
  - **Phone Number**
  - **Social Security Number**
- **Custom Action** adds custom JavaScript actions to dropdown menu. There are two options:
  - **Format Action** is used to enable custom JavaScript for formats. Click the ellipsis icon to add/view JavaScript.
  - **Keystroke Action** is used to enable custom JavaScript for keystrokes. Click the ellipsis icon to add/view JavaScript.
  - If the options above are used then the **Edit Action: "Run a JavaScript"** dialog box will open. Enter the desired JavaScript for the action and then click **OK**:

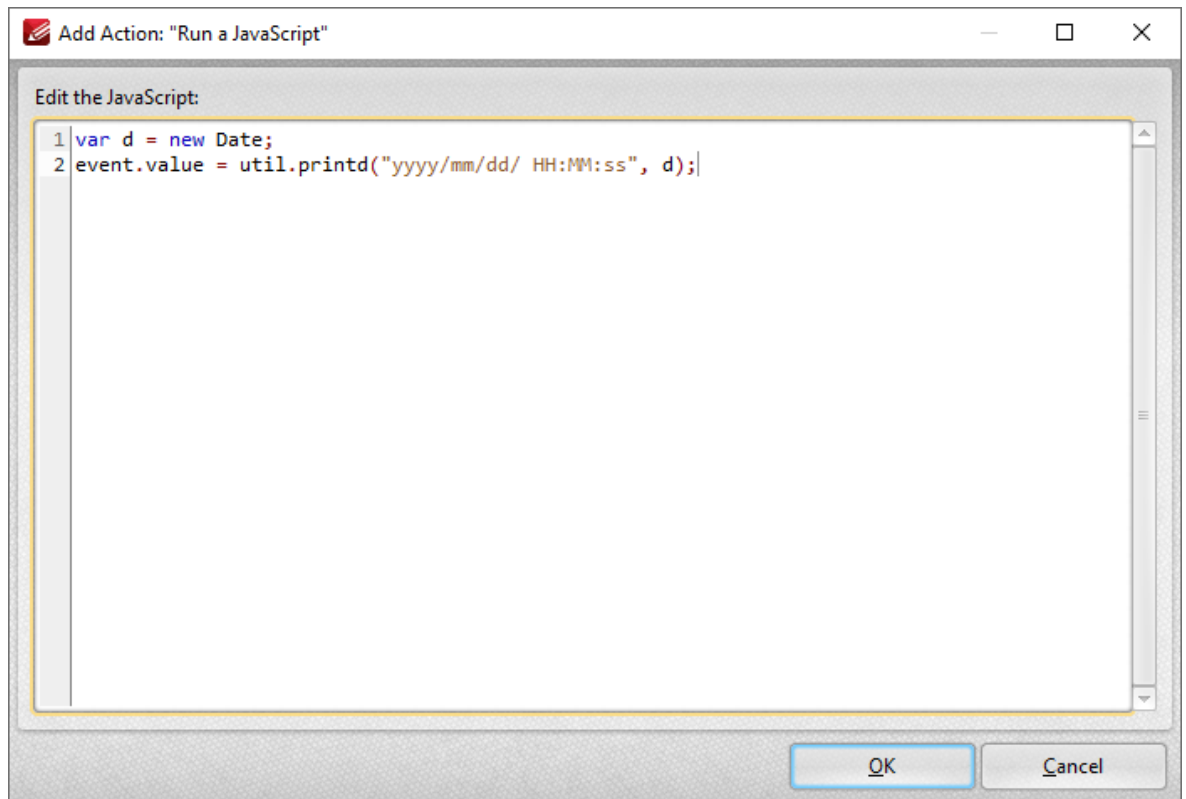

Figure 8. Edit Action: "Run a JavaScript" Dialog Box

The **Value Validation** properties determine the validation of values entered into the dropdown menu:

- **Validation** determines how values are validated:
  - **Value in Range** sets the range within which values entered into the dropdown menu must fall:
    - **From** specifies the minimum value.
    - **To** specifies the maximum value.
  - **Custom** enables the use of custom JavaScript in order to validate values entered in the dropdown menu. Click the ellipsis icon to add/view custom JavaScript, as detailed in **(figure 8)**.

The **Value Calculation** properties determine the value of dropdown menu from other dropdown menus:

- **None** specifies that calculations are not performed.
- **Sum** uses the sum of specified fields.
- **Product** uses the product of specified fields.
- **Average** uses the average of specified fields.
- **Minimum** uses the minimum value of all the specified fields.
- **Maximum** uses the maximum value of all specified fields.

- Please note that when the **Sum, Product, Average, Minimum** and **Maximum** properties are used, the additional entry "**Fields**" will appear beneath the **Calculation** property. Use this entry to specify the fields used in these calculations.
- **Simplified Notation** enables the insertion of a custom calculation to be performed on fields. Use the **Simple Notation** box to determine the calculation. Use the document field names and standard mathematical notation (+, -, \*, /) to specify the calculation. If there are spaces in form field names then they must be entered in quotation marks. For example: **Field1 + Field 2 / "Division Field" \* 64.**
- **Custom Action** enables the use of custom JavaScript in order to perform calculations and determine the order in which calculations are performed. Click the ellipsis icon to add custom JavaScript, as detailed in *(figure 8)*.

▼ **Adding and Editing Dropdown Menu Items**

Follow the steps below to add/edit dropdown menu items:

1. Click **Select Fields** in the **Form** tab and select the dropdown menu, then click the **Format** tab and click **Properties**. The **Dropdown Properties** pane will open:

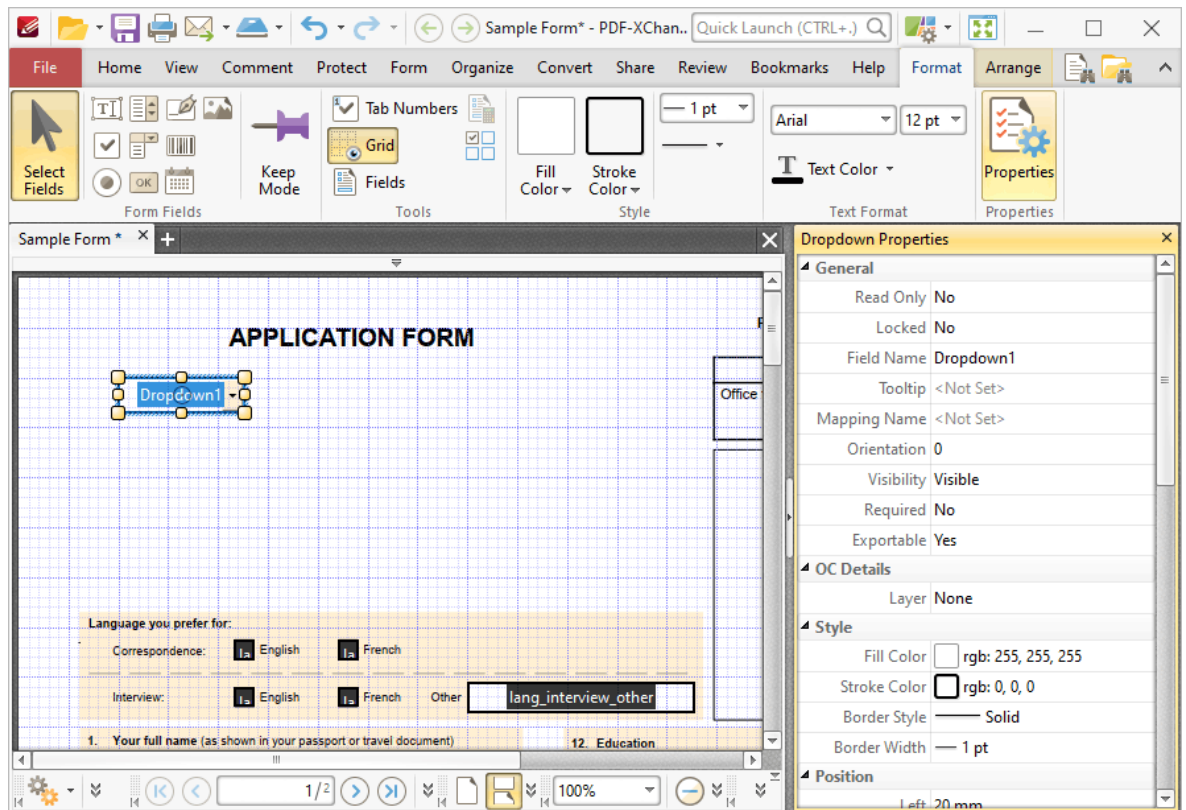

Figure 9. Selected Dropdown Menu

2. Move to the **Combo Box Items** property and click **<Empty>**:

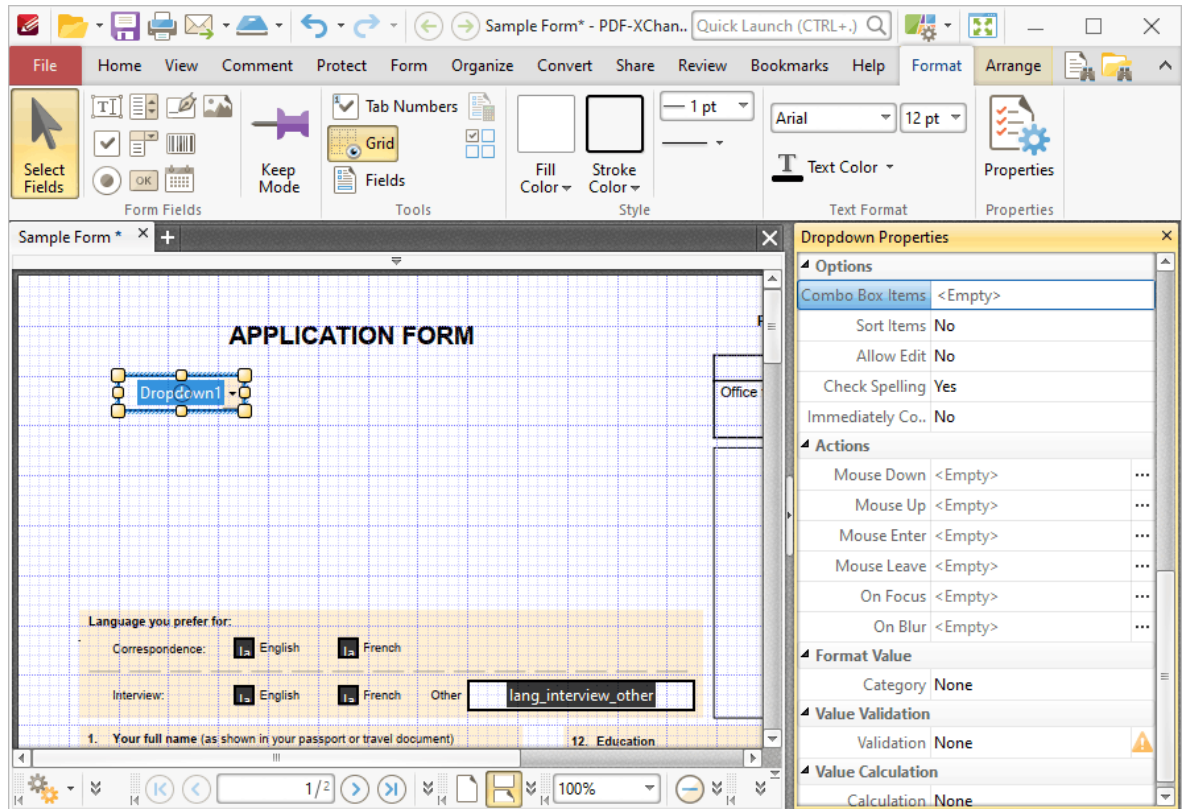

Figure 10. Dropdown Properties Pane, Combo Box Items

The **Dropdown Menu Items** pane will open. This pane is used to add/edit dropdown menu items:

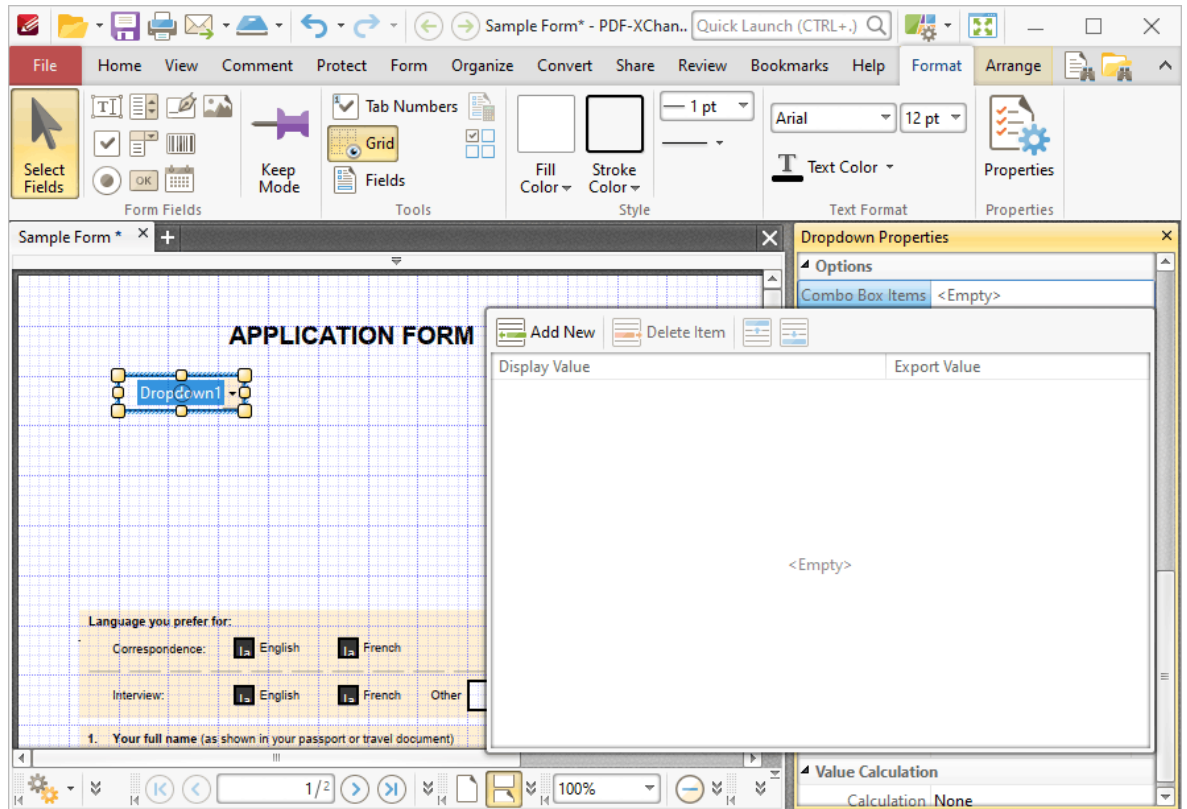

Figure 11. Dropdown Menu Items Pane

3. Click **Add New** to add new entries to the dropdown menu:

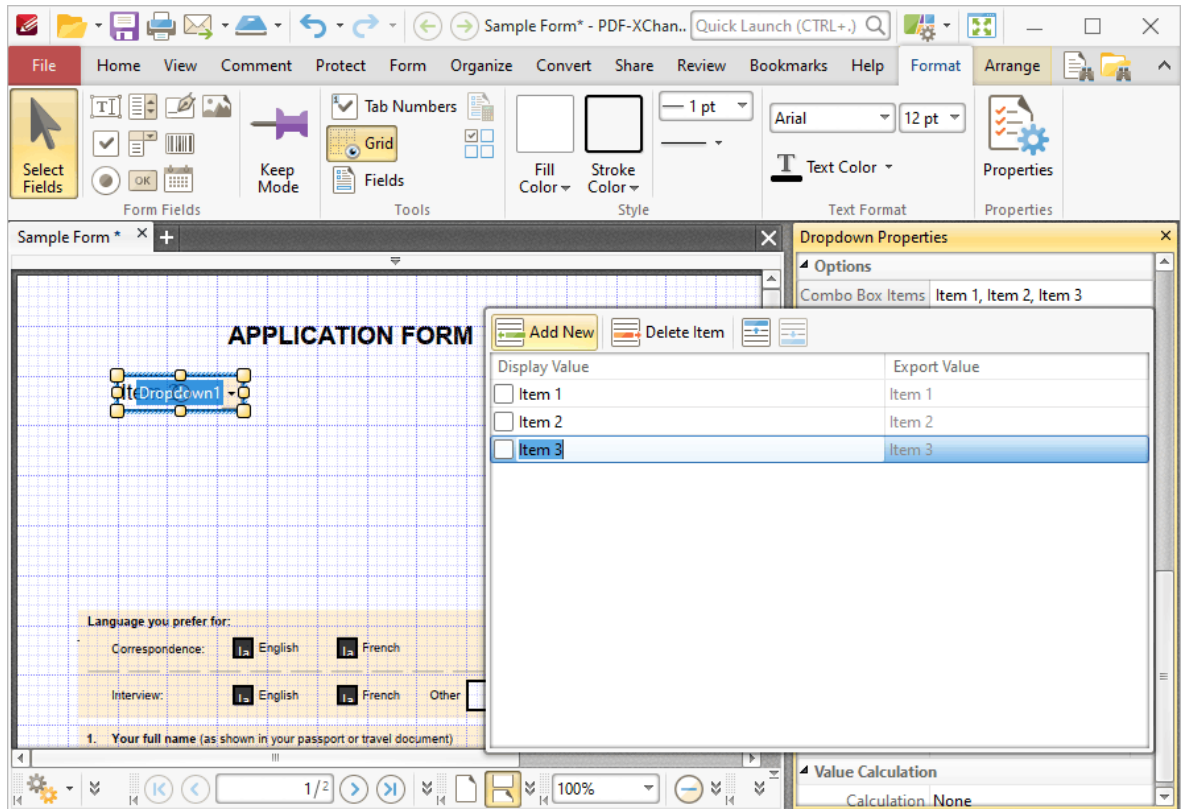

Figure 12. Dropdown Menu Items Pane

- Click **Delete Item** to delete the selected item from the dropdown menu.
- Click the **Up** and **Down** buttons to move selected items up or down in the list. The order of items in the pane represents the order to items in the dropdown menu.
- Enter values in the **Export Value** column to determine the value given for exported dropdown menu items. Note that values must be first selected in the **Dropdown Menu Items** pane and then clicked in order to edit the name.
- Click to select **Display Value** names, and then click them again in order to edit the name.
- Select the check box of the item to be used as the default selection in the dropdown menu. This item will be selected when the dropdown menu is in its default state.
- Click and drag the yellow control points to resize the dropdown menu as desired.

4. Click outside the **Dropdown Menu Items** pane to complete the process, then enable the **Hand Tool** to select dropdown menu items:

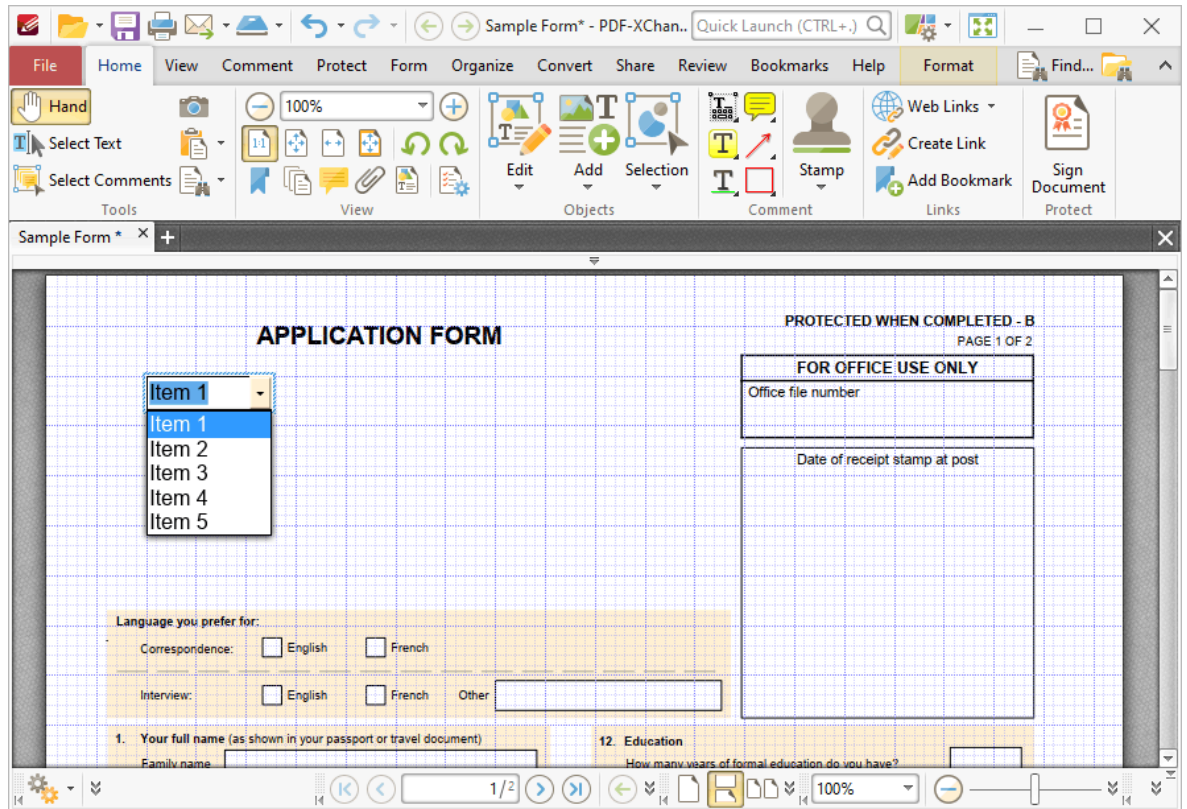

Figure 13. Completed Dropdown Menu

▼ Value Validation Example

The following example details a simple value validation of values entered into the dropdown 'Dropdown1':

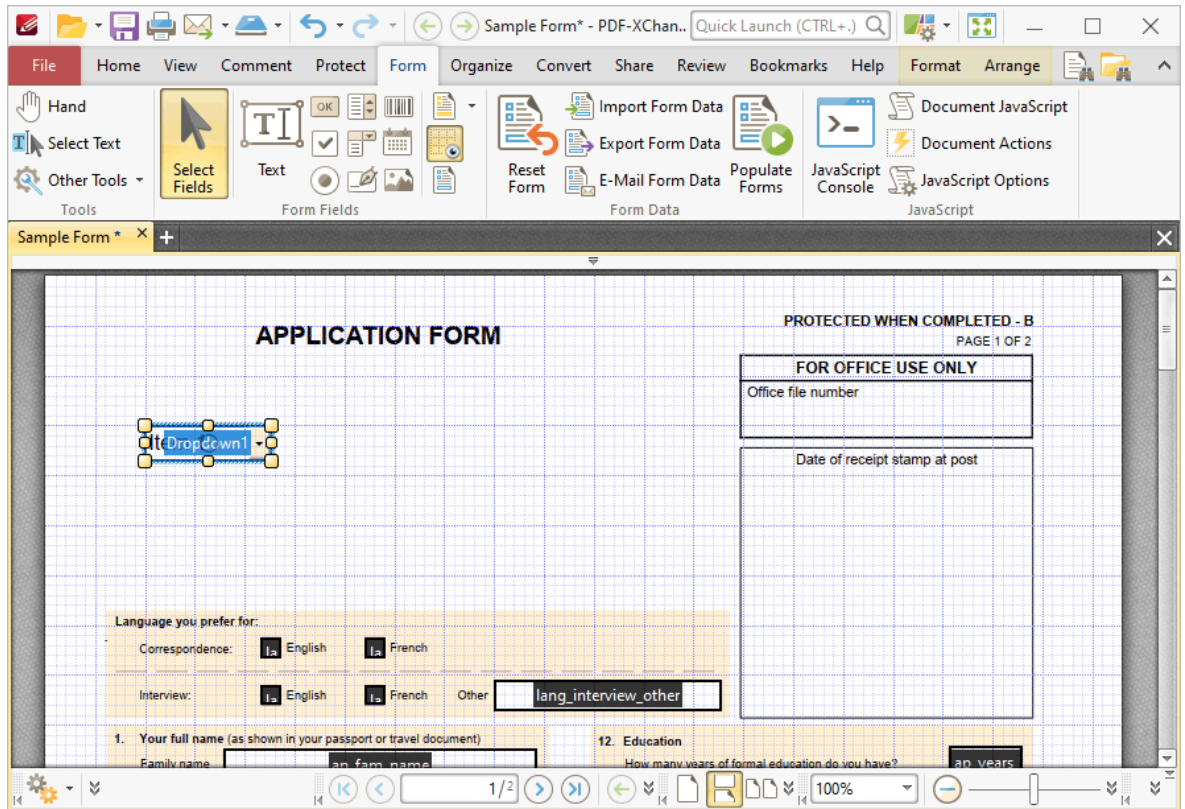

Figure 14. Value Validation Example, Dropdown Menu

This example will detail how to validate that values entered into '**Dropdown1**' fall in the range 0-100:

1. Click the **Form Tab**, then click **Select Fields** and select the dropdown menu.
2. Click the **Format** tab, then click **Properties**. The **Dropdown Properties** pane will open:



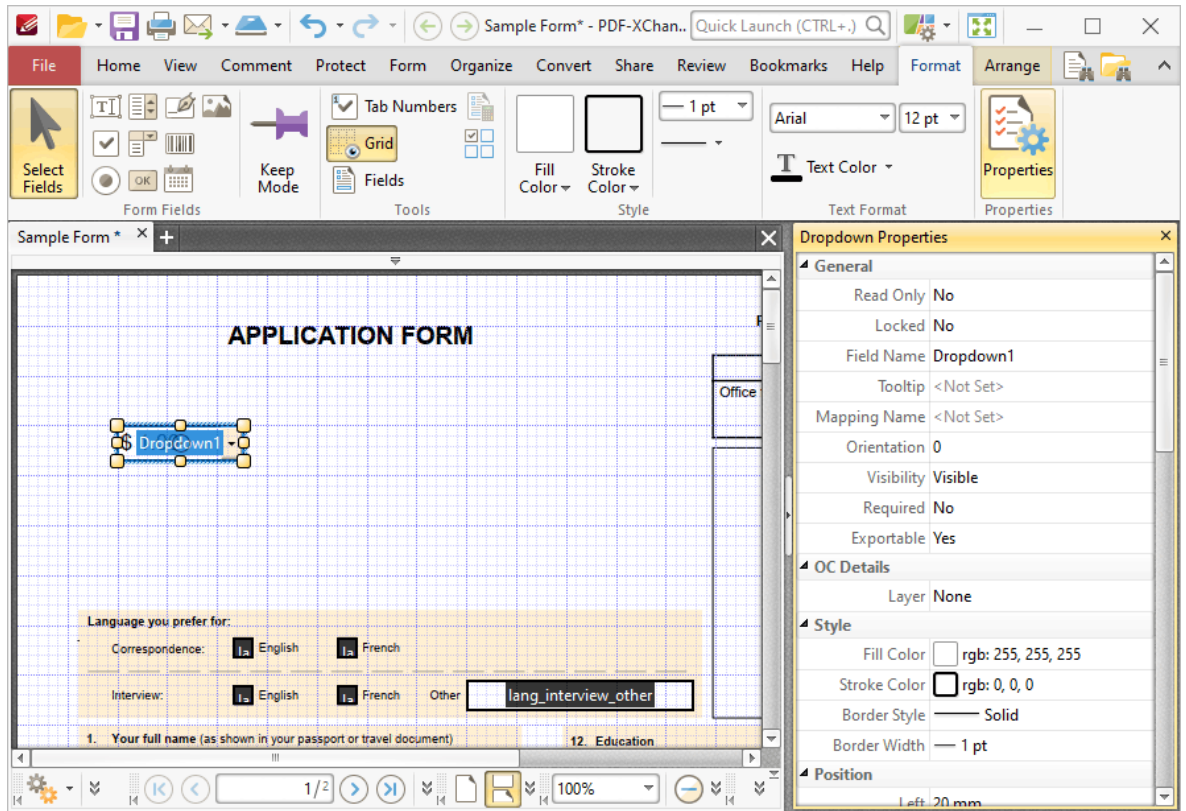

Figure 15. Value Validation Example, Dropdown Properties Pane

3. Scroll down the **Dropdown Properties** pane to the **Format Value** tab, then click the **Category** property and select **Number**:

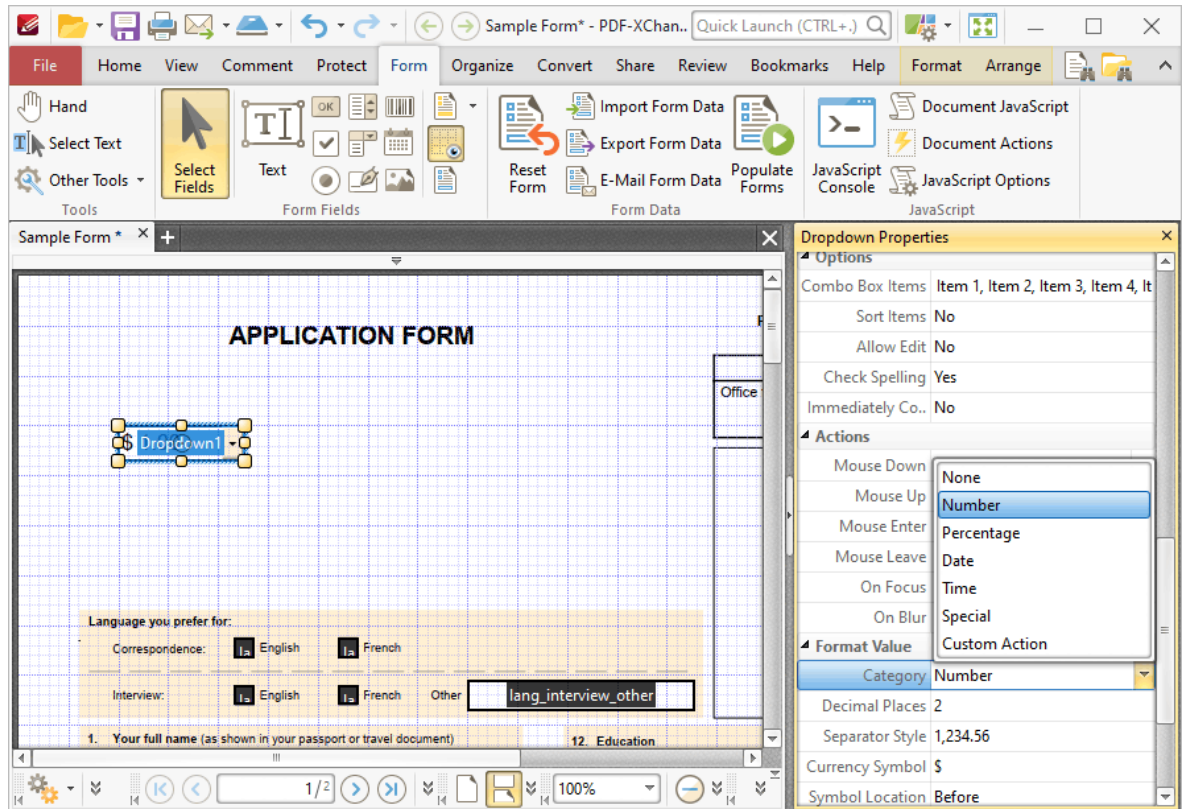

Figure 16. Value Validation Example, Category Property Options

4. Scroll down the **Dropdown Properties** pane to the **Value Validation** tab, then click the **Validation** option and select **Value in Range**:

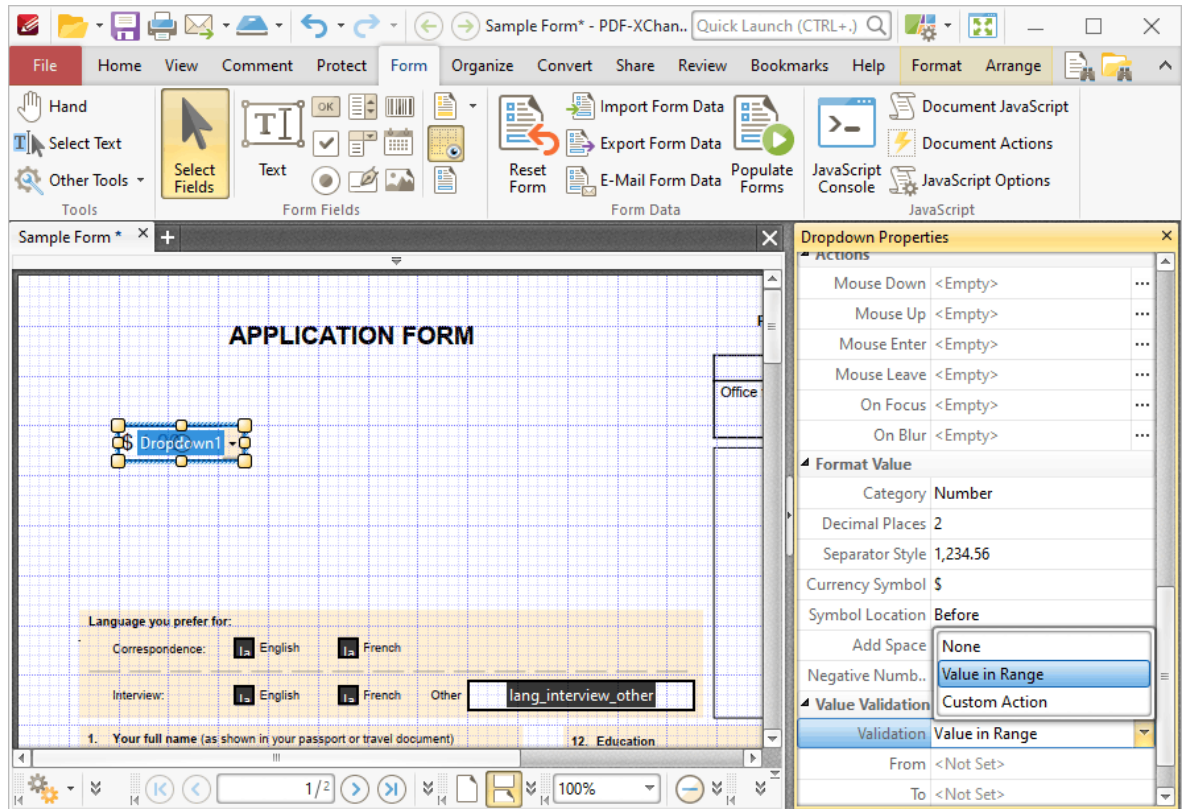

Figure 17. Value Validation Example, Validation Property Options

Note that the **From** and **To** options will appear beneath the **Validation** property when **Value in Range** is selected.

5. Enter '0' in the **From** option and '100' in the **To** option:

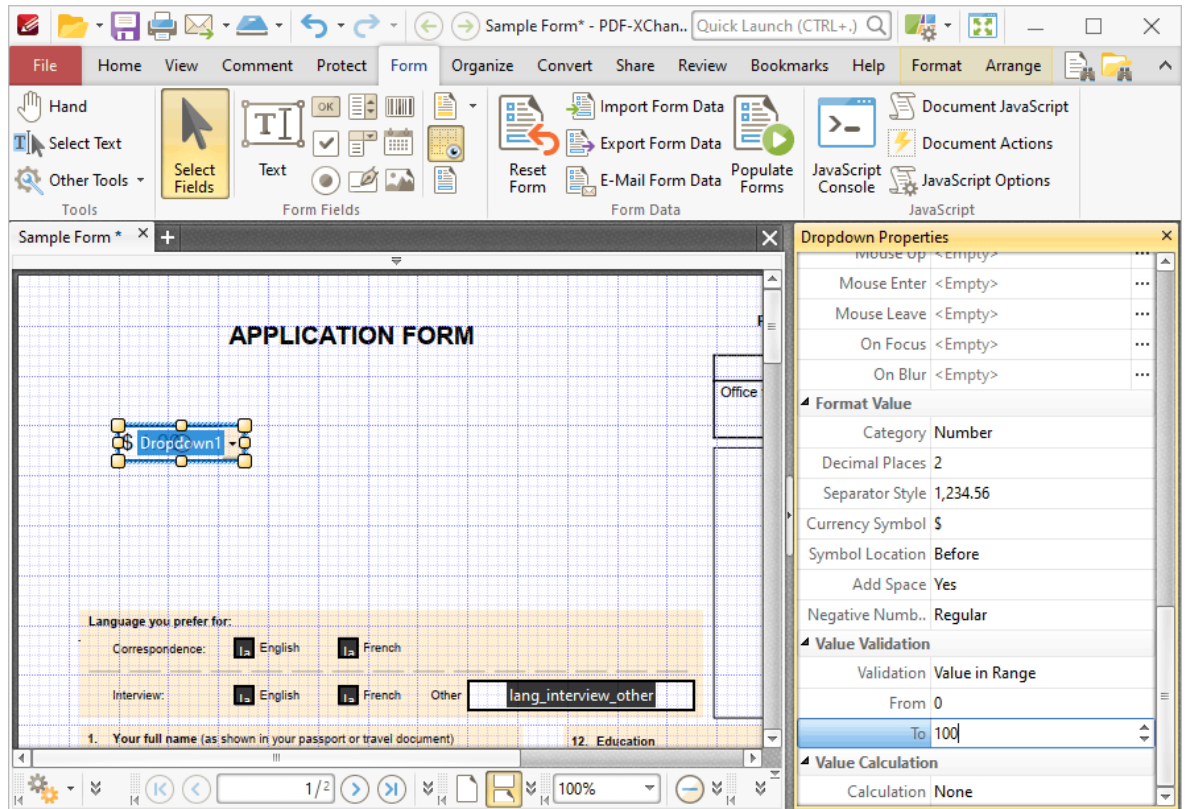

Figure 18. Value Validation Example, From/To Option

All values subsequently entered into '**Dropdown1**' must fall into the range 0-100. Values outside of the specified range will not be permitted, and if they are entered then an error message will appear.

▼ **Edit the Display Name of Dropdown Menus**

The default settings of dropdown menus use a list item as the display name. The process below details how to create a different display name for dropdown menus:

A default dropdown menu is detailed below and the display name is '**Item 1**':

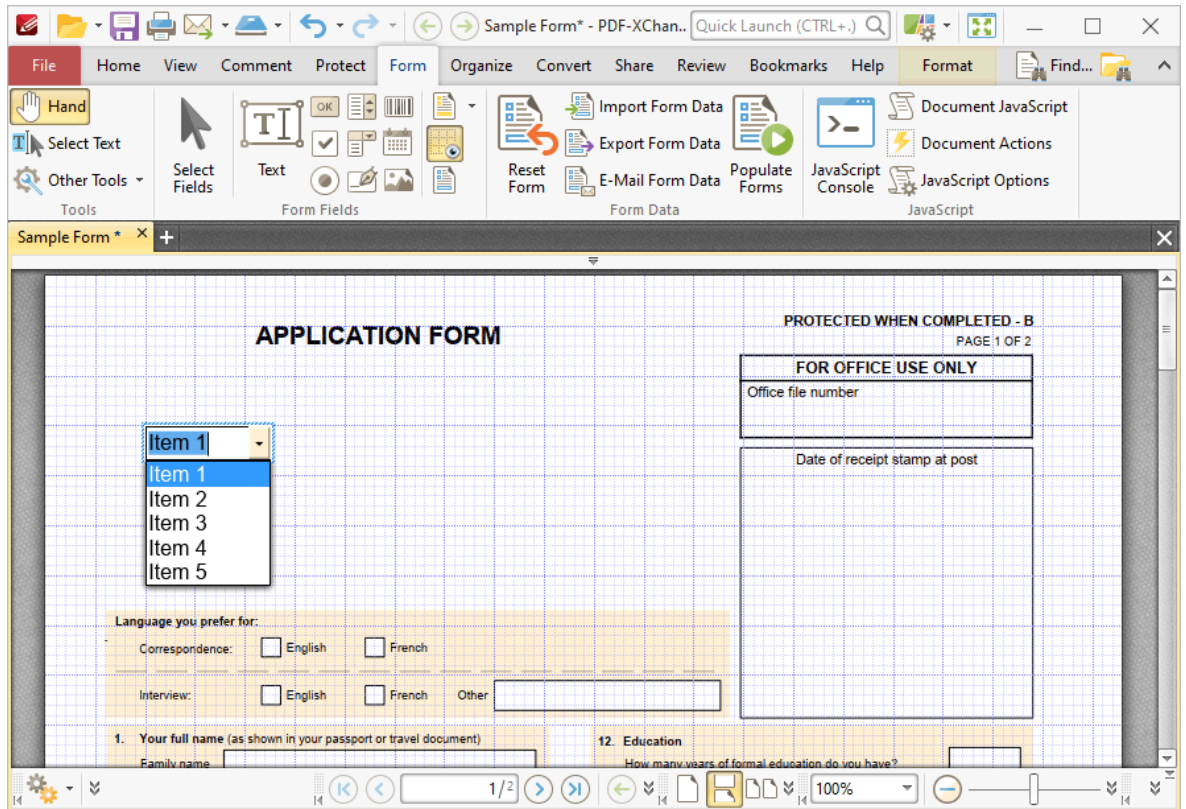

Figure 19. Default Dropdown Menu

1. Click the **Form Tab**, then click **Select Fields** and select the dropdown menu.
2. Click the **Format** tab, then click **Properties**. The **Dropdown Properties** pane will open:

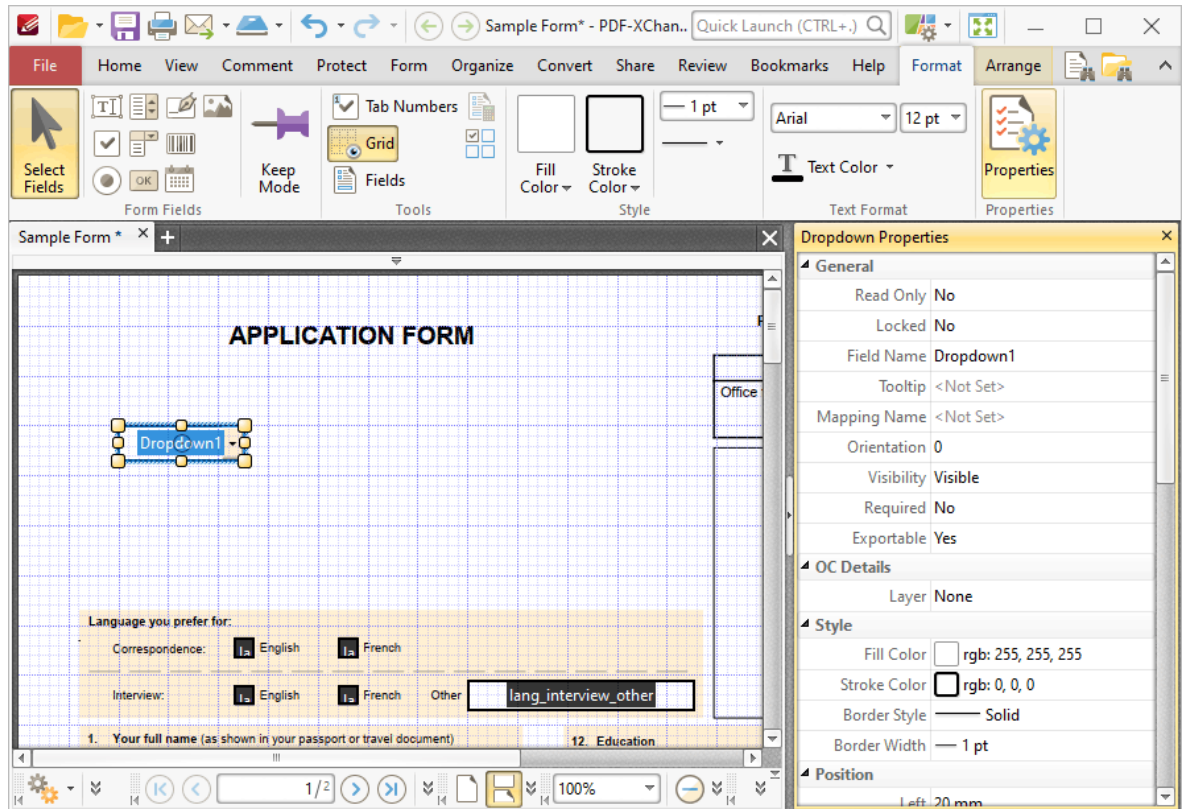

Figure 20. Dropdown Menu Tool, Dropdown Properties Pane

3. Scroll down the **Dropdown Properties** pane to the **Allow Edit** property and change the setting to **Yes**:

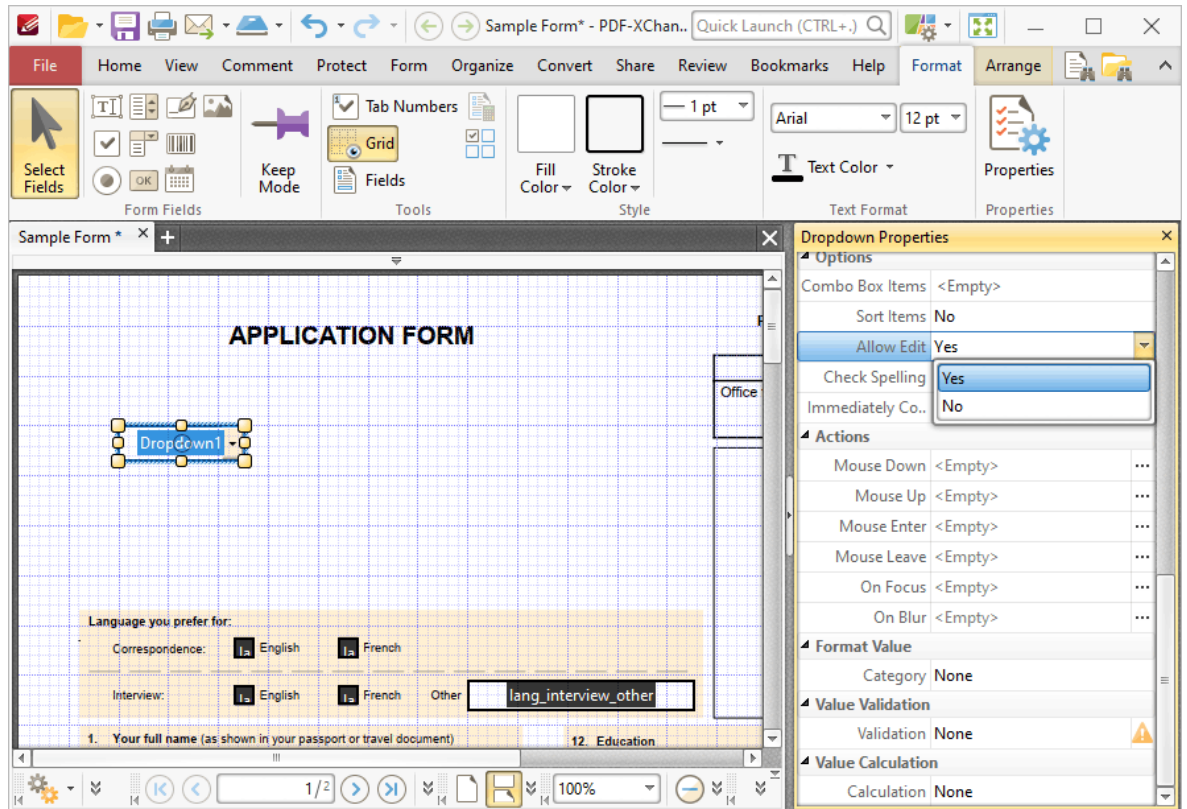

Figure 21. Dropdown Menu Tool, Allow Edit Property

4. Click the **Home** tab and select the **Hand Tool**, then click the dropdown menu and enter the desired display name. This example will use **'Select...'**:

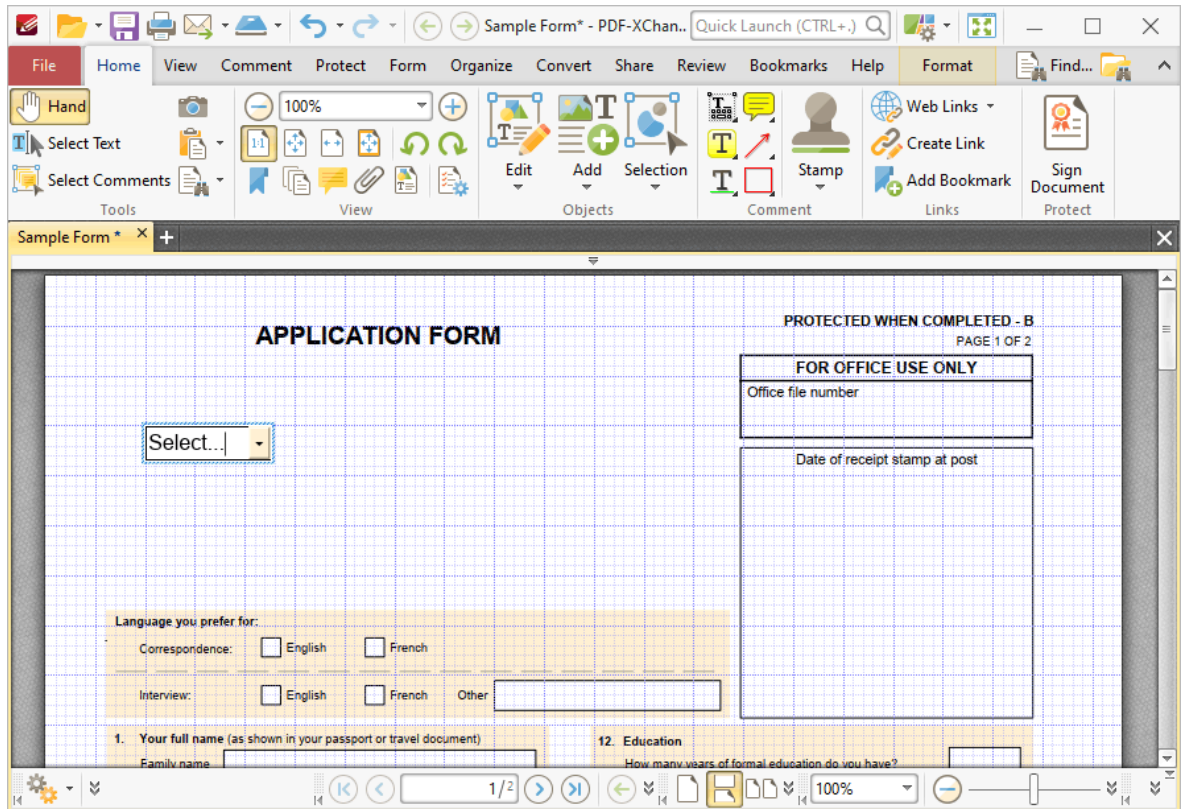

Figure 22. New Dropdown Menu Display Name

5. Click the **Form** tab and click **Select Fields**, then select the dropdown menu and click **Properties** in the **Format** tab. The **Dropdown Properties** pane will open:



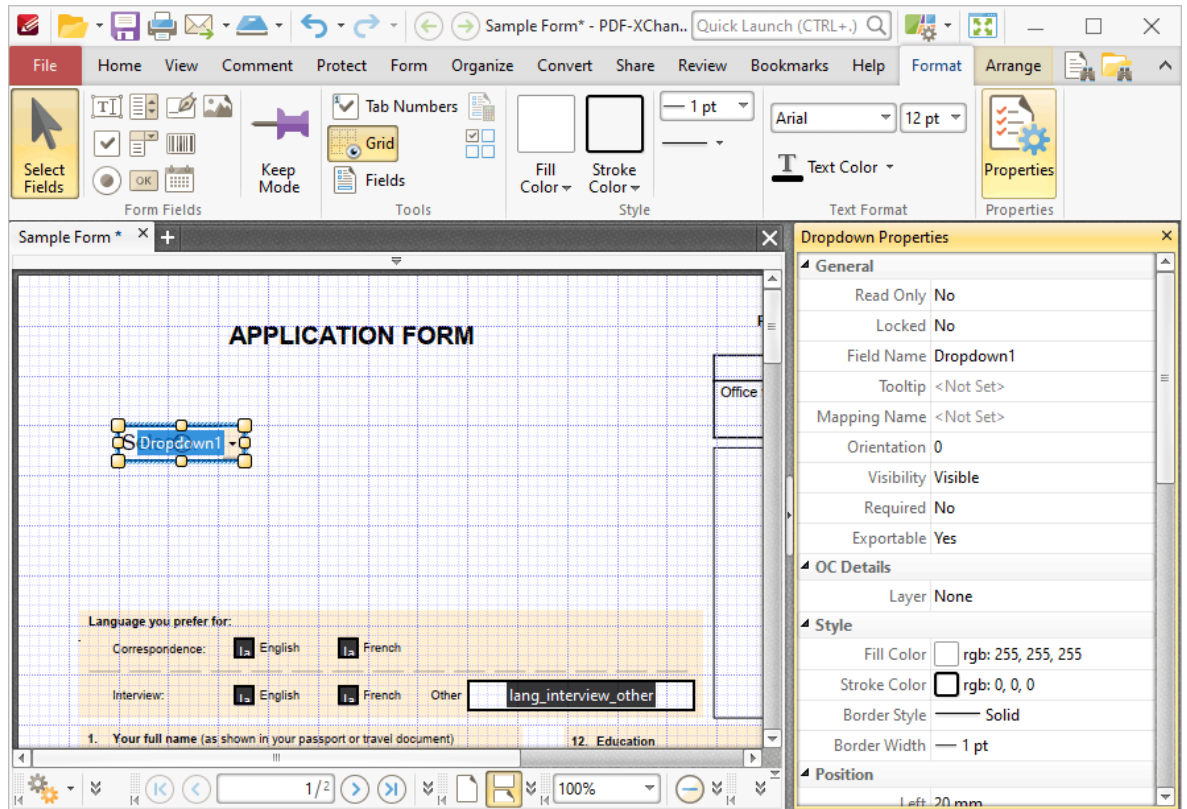

Figure 23. Dropdown Menu Tool, Dropdown Properties Pane

6. Scroll down the **Dropdown Properties** pane to the **Allow Edit** property and change the setting to **No**:

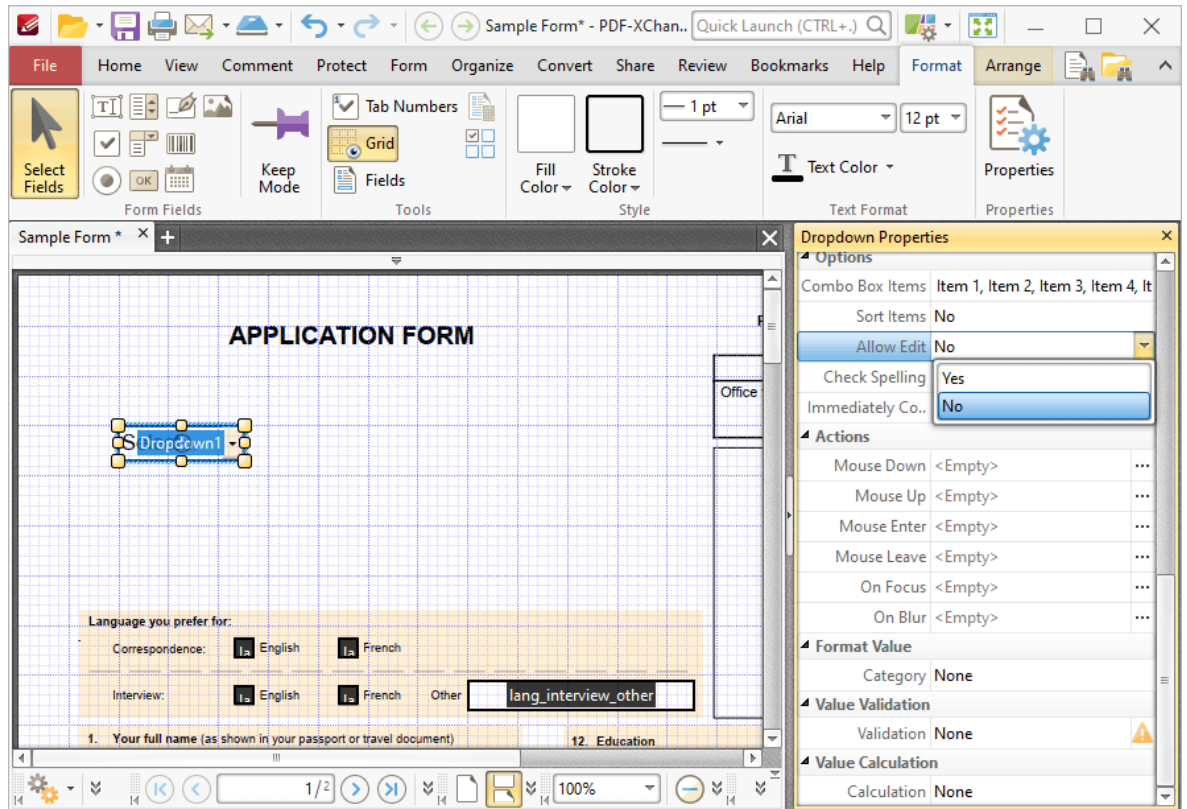

Figure 24. Dropdown Properties Pane,, Allow Edit Property

The dropdown menu will display as detailed below:

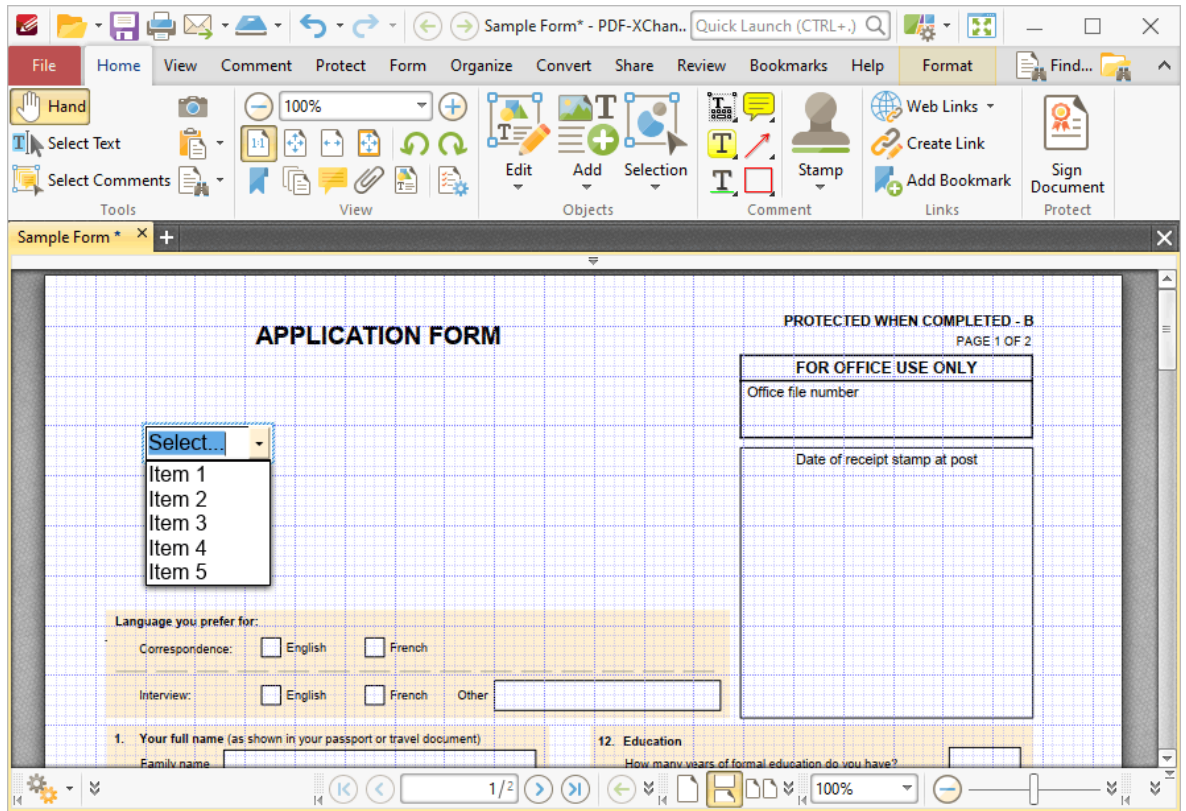

Figure 25. Dropdown Menu, New Display Name

10.4.6.6 Add Buttons to Documents



Add Buttons to Documents

Buttons enable the triggering of predefined events:

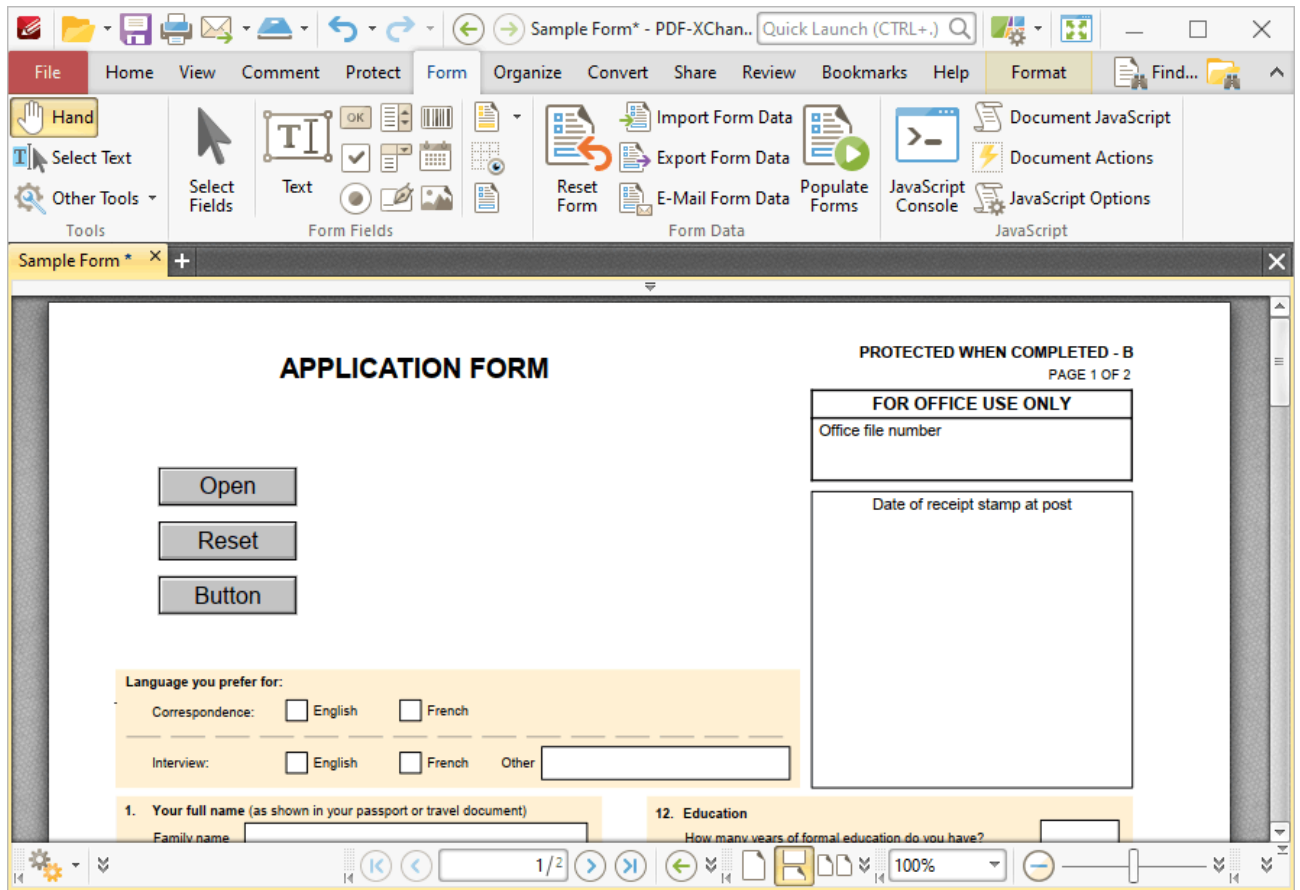

Figure 1. Example Buttons

The functionality of **PDF-XChange Editor** enables a wide range of customization for buttons. Click the dropdowns below for further information:

▼ Add Buttons to Documents

1. Click the **Form** tab, then click **Button**. A blue rectangle will be displayed at the location of the pointer. This rectangle represents the button:

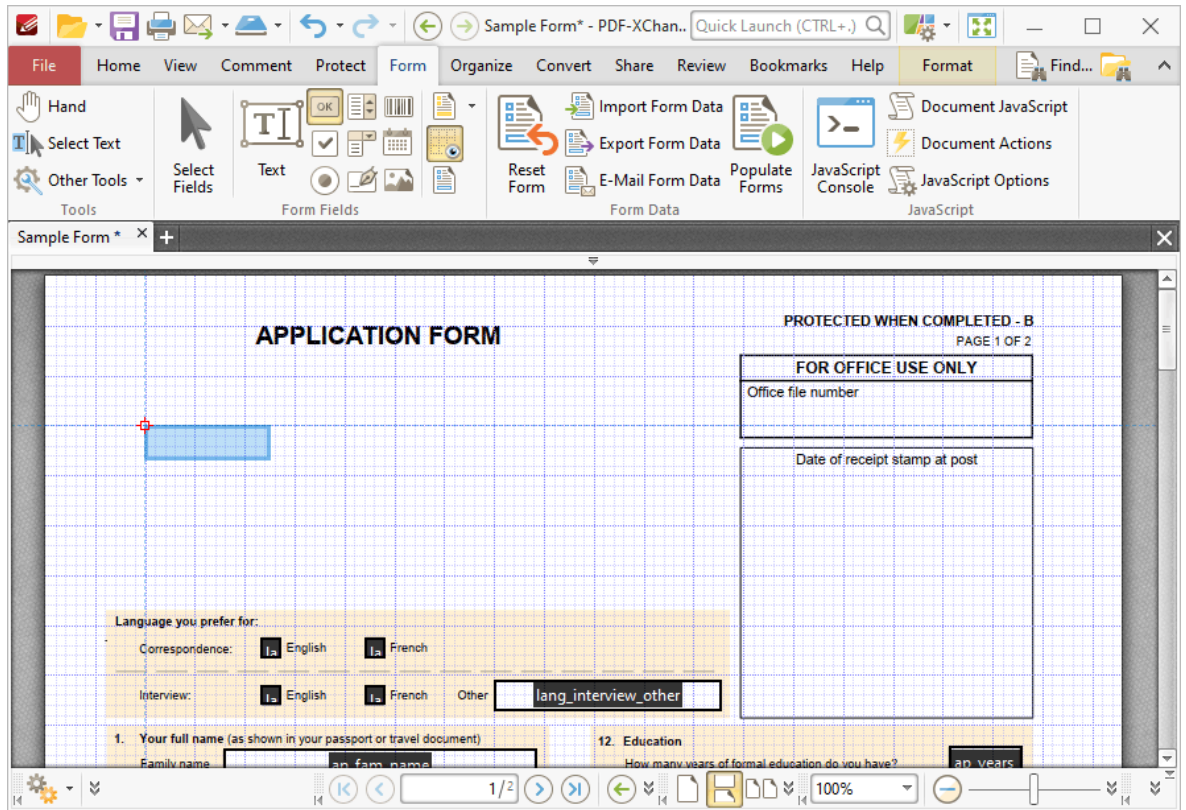

Figure 2. Active Button Tool

2. Move the rectangle to the desired location and then click to add the button to the document. Added buttons appear as detailed below:

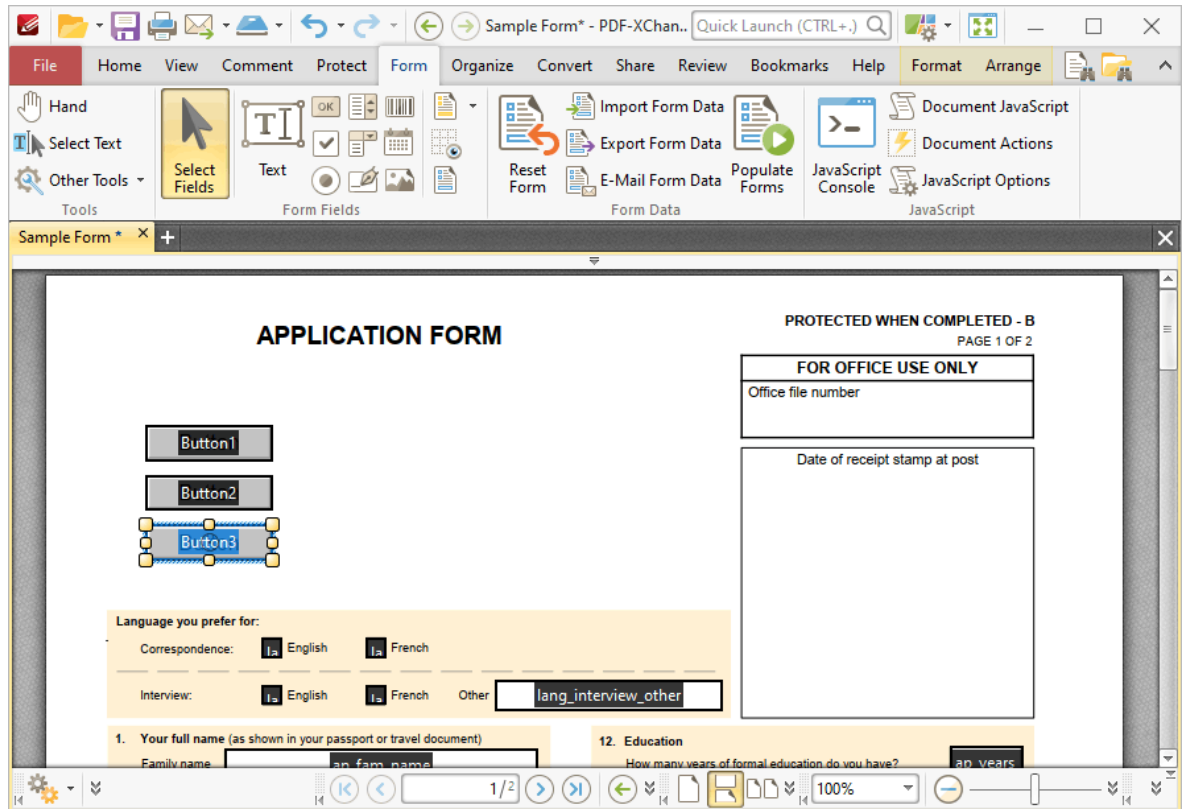

Figure 3. Added Buttons

- Click and drag the yellow control points to resize buttons.
- Use the options in the **Format Tab** to determine the style and appearance of selected buttons:

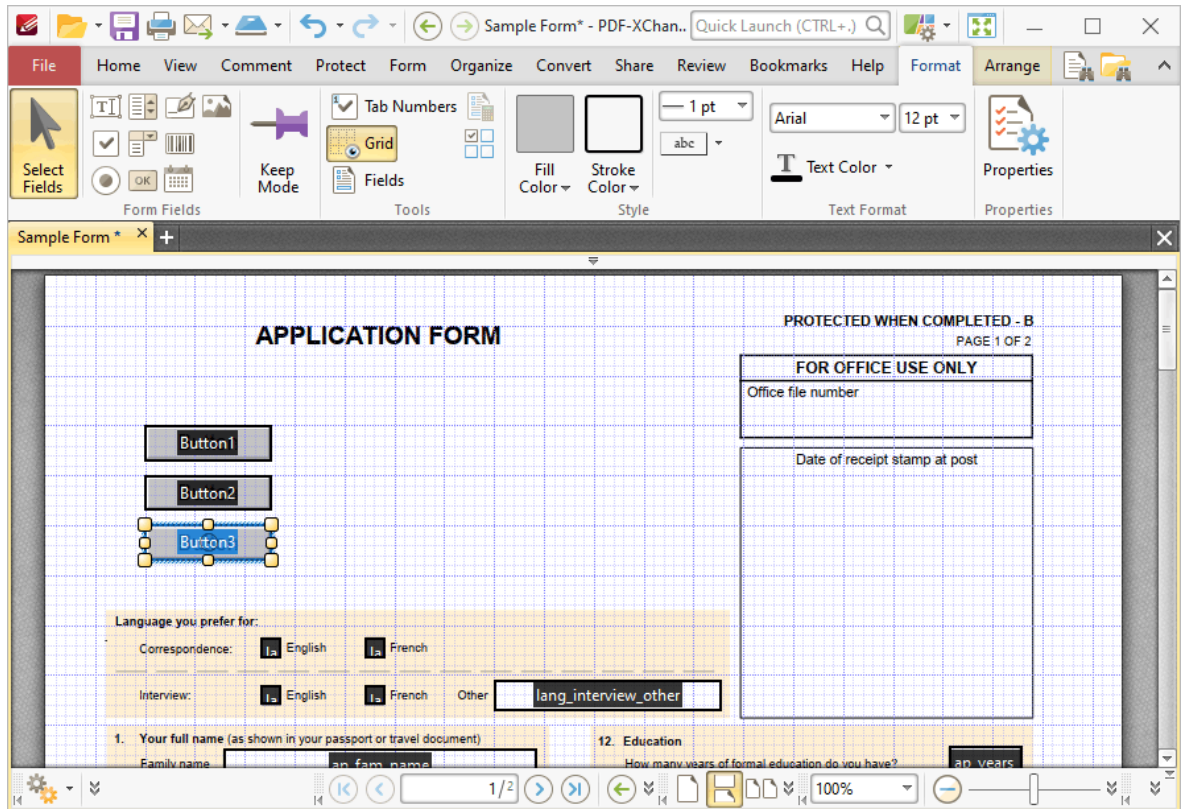

Figure 4. Format Tab, Buttons

- Click **Select Fields** to select and edit form fields.
- Click the options in the **Form Fields** group to enable alternative form field formats.
- Click **Keep Mode** to create multiple buttons consecutively. If this option is disabled then **PDF-XChange Editor** will revert to the designated default tool after the creation of a single button.
- Click **Tab Numbers** to show/hide the tab order numbers of form fields.
- The **Calculation Order** setting is not available for buttons.
- Click **Grid** to enable/disable the grid, which is used to assist in the accurate placement of form fields, as detailed in **(figure 4)**.
- Click **Create Multiple Copies** to create multiple copies of selected form fields, as detailed [here](#).
- Click **Fields** to show/hide the **Fields** pane, which is used to view/edit form fields.
- Click **Fill Color** to determine the fill color of the button.
- Click **Stroke Color** to determine the border color of buttons.
- Click **Width** to determine the width of button borders.
- Click **Border** to determine the style of button borders.
- Use the **Font** and **Font Size** dropdown menus to determine the font and font size used for button labels.

- Use the **Text Color** button to determine the color of the font used in button labels.
- Click **Properties** to open the **Push Button Properties** pane, which enables the customization of additional elements of buttons and is detailed in the section below.

### ▼ The Push Button Properties Pane

The **Push Button Properties** pane can be used to determine a range of style and functionality options for buttons. For example, it is possible to use the **Actions** properties to add multiple dynamic actions to buttons, such as running JavaScript, launching web links and opening files on the local computer. (JavaScript is a high-level programming language that can be used to perform custom operations. See [here](#) for an index of existing JavaScript operations that the **PDF-XChange Editor** forms can use, as well as additional information about JavaScript). Click **Select Fields** to select form fields, then click the desired field and click **Properties** in the **Format** tab to open the **Push Button Properties** pane:

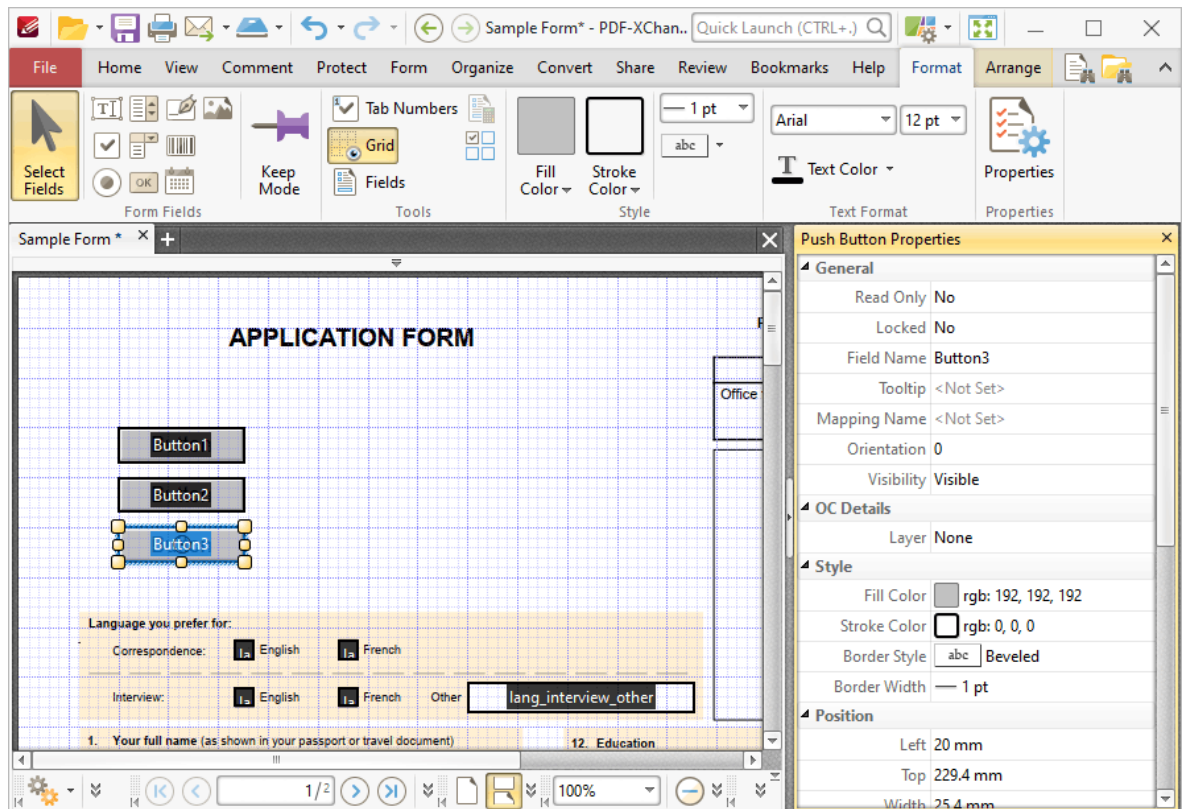

Figure 5. Button Tool, Push Button Properties Pane

The options detailed below are available in the **Push Button Properties** pane:

The **General** properties determine the general parameters of buttons:

- **Read Only** determines whether or not the button can be edited.



- **Locked** determines whether or not buttons can be moved, and whether or not their properties can be modified.
- **Field Name** determines the name of the button. This name is present when the **Edit Form** tool is selected, and when buttons are listed in the [Fields pane](#).<sup>1016</sup>
- **Tooltip** determines the information displayed when the pointer is hovered over the button.
- **Mapping Name** determines the mapping name that the button uses. This name is used to reference interactive form data when the form is exported, and does so without affecting the appearance of the name in the original document.
- **Orientation** determines the orientation of the button.
- **Visibility** determines the visibility of the button.

The **OC Details** property determines the optional content layer to which the button belongs. When a field belongs to an optional content layer, it displays only when the layer is enabled. Use the **Layers** pane to view/create/edit layers, as detailed [here](#).<sup>1024</sup>

The **Style** properties determine stylistic elements of buttons. They are detailed beneath *(figure 4)*.

The **Position** properties determine the position and dimensions of buttons:

- **Left** determines the distance of the button from the left margin.
- **Top** determines the distance of the button from the bottom of the page.
- **Width/Height** determine the width/height of the button.

The **Default Text Format** properties determine the default properties when text is entered into the button:

- **Font Size** is always set to **auto** for buttons. This is because the font size refers to the size of the mark when buttons are selected, and the mark must be proportionate to the size of the button.
- **Text Color** determines the color of the tick when buttons are selected.

The **Options** properties determine additional options for buttons:

- **Layout** determines the layout of the button, which can be displayed as text label, icon or a combination of both elements:
  - **Label Only** is the default setting. The text label that the **Up Label** property specifies is the only element displayed on the button. The **Up Label** property becomes available in the **Options** properties when the **Label Only** setting is enabled.
  - **Icon Only** uses the custom image that the **Up Icon** property specifies to represent the button. The **Up Label** property becomes available in the **Options** properties when **Icon Only** setting is enabled.
  - **Icon Top, Label Bottom** displays a custom image as the upper section of the button and the text label beneath the image.

- **Label Top, Icon Bottom** displays the text label as the upper section of the button and a custom image beneath the text.
- **Icon Left, Label Right** displays a custom image on the left and the text label on the right.
- **Label Left, Icon Right** displays the text label on the left and a custom image on the right.
- **Label over Icon** uses a custom image to represent the button and places the text label over the image.



Figure 6. Available Layout Options for Buttons

- **Behaviour** specifies the visual effect when buttons are pressed:
  - **None** specifies that no visual change occurs.
  - **Invert** inverts the fill color of the button.
  - **Outline** creates an outline around the button.
  - **Push** creates a visual effect when buttons are clicked:



Figure 7. Default to Invert (Top), Default to Outline (Centre) and Default to Push (Bottom)

- **Up Label** specifies the text that the button uses. N.b. A **Layout** property that specifies a label must be enabled for the option to be available.
- **Up Icon** specifies the icon that the button uses. N.b. A **Layout** property that specifies an icon must be enabled for the option to be available.

The **Icon Placement** properties determine settings for the icon used in the button:

- **When to Scale** determines when icons are scaled to the size of the button on which they are featured:
  - **Always** scales the icon to the size of the button in all cases.
    - **Scale Type** determines how the icon is scaled:
      - **Proportionally** retains the aspect ratio of the icon
      - **Non-proportionally** ignores the aspect ratio of the icon.
    - **Never** retains the original size of the icon regardless of the size of the button.
    - **Icon is Too Big** scales icons in cases where icons are larger than the button.
    - **Icon is Too Small** scales icons in cases where icons are smaller than the button.
  - **Fit to Bounds** fits the icon to the bounds of the button.
  - **Horizontal Position** determines the horizontal position of the icon in the button.
  - **Vertical Position** determines the vertical position of the icon in the button.

The **Actions** properties determine the action taken when users interact with the button:

- **Mouse Down** initiates an action when the left mouse button is pressed (without being released).
- **Mouse Up** initiates an action when the left mouse button is clicked (pressed and released).
- **Mouse Enter** initiates an action when the pointer moves into the button.
- **Mouse Leave** initiates an action when the pointer moves out of the button.
- **On Focus** initiates an action when the button is selected.
- **On Blur** initiates an action when the button is deselected.
- Click the ellipsis icon on the right of actions to add/edit button actions:

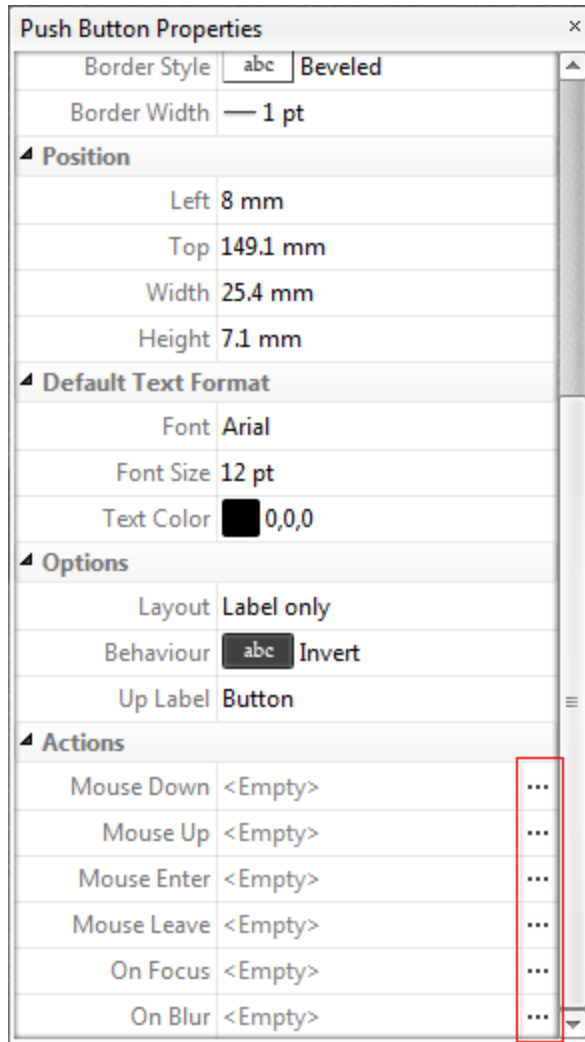

Figure 8. Push Button Properties Pane, Action Ellipses

The process of adding actions is detailed [here](#).<sup>959</sup>

▼ **Button Creation Example**

The following example will detail the creation of a button that contains an icon and text, and activates a link to the **PDF-XChange** website when it is clicked:

1. Click the **Form** tab, then click **Button**. The blue rectangle that represents the button will be displayed beneath the pointer:

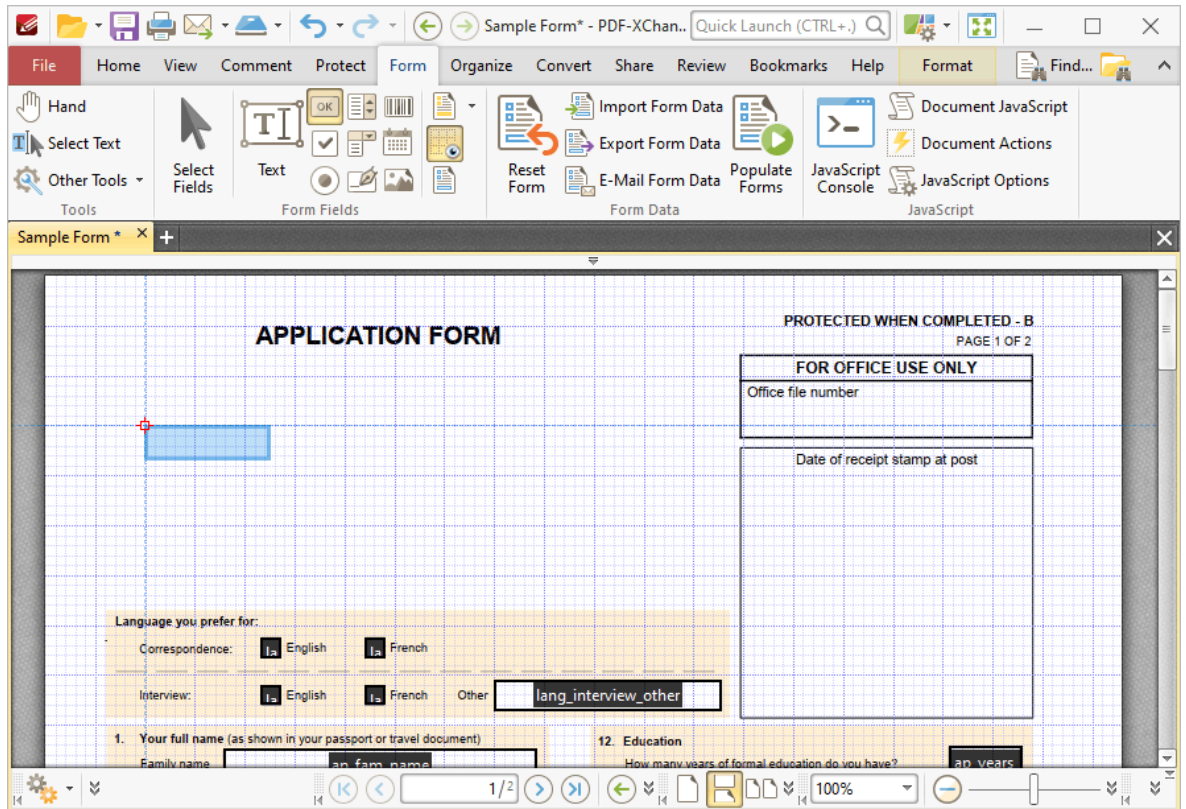

Figure 9. Active Button Tool

2. Click to add the button, then click the **Format** tab and click **Properties**. The **Push Button Properties** pane will open:

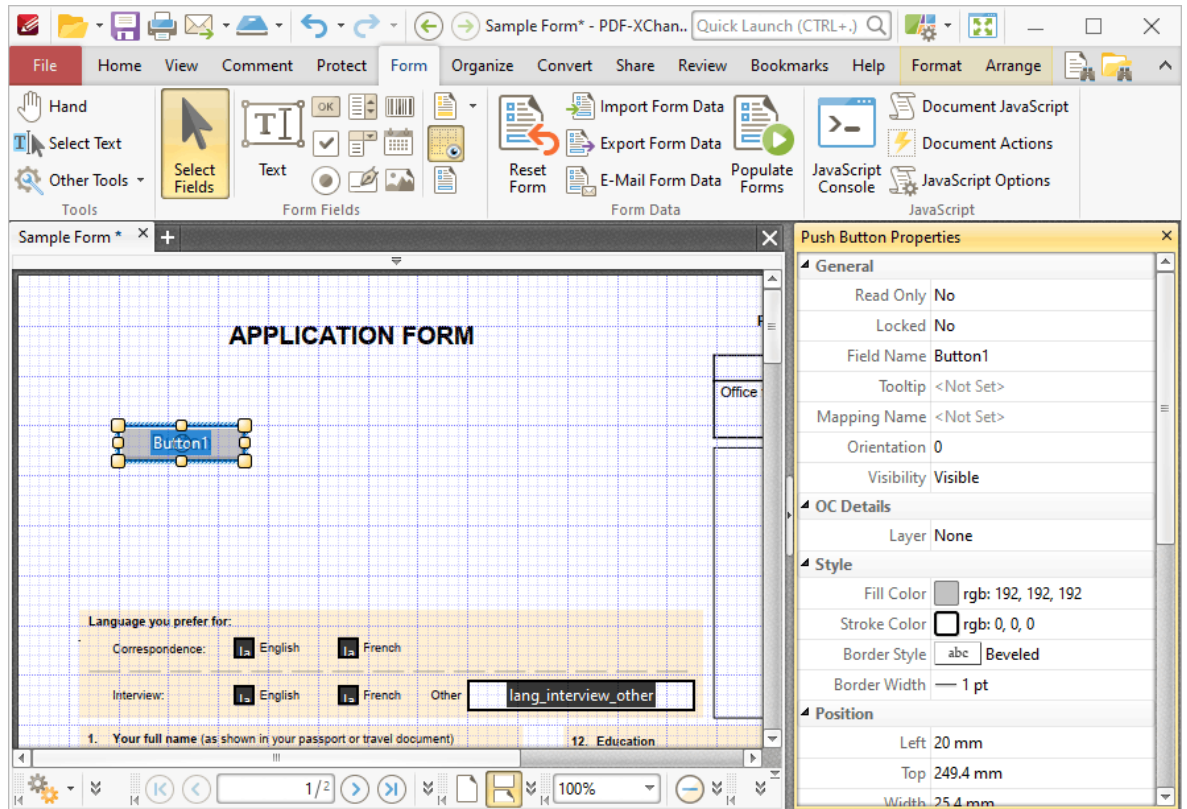

Figure 10. Active Button Tool, Push Button Properties Pane

3. Scroll down the **Push Button Properties** pane to the **Up Label** property, and then enter the text "**Launch Website**":

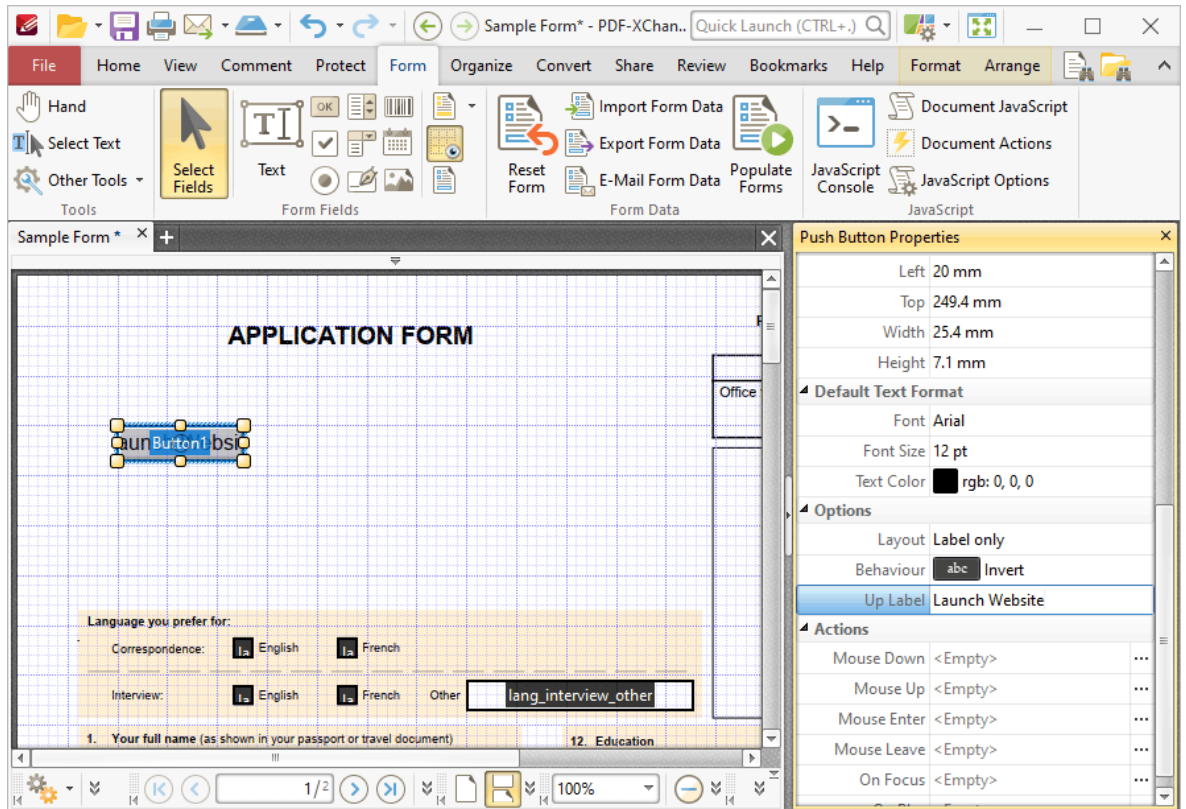

Figure 11. Active Button Tool, Up Label Property Highlighted

Note that it is necessary to resize the button in order to fit the text inside:

4. Click **Select Fields**, then click the button to select it. Yellow control points will appear around the button. Click and drag the control points to resize the button:

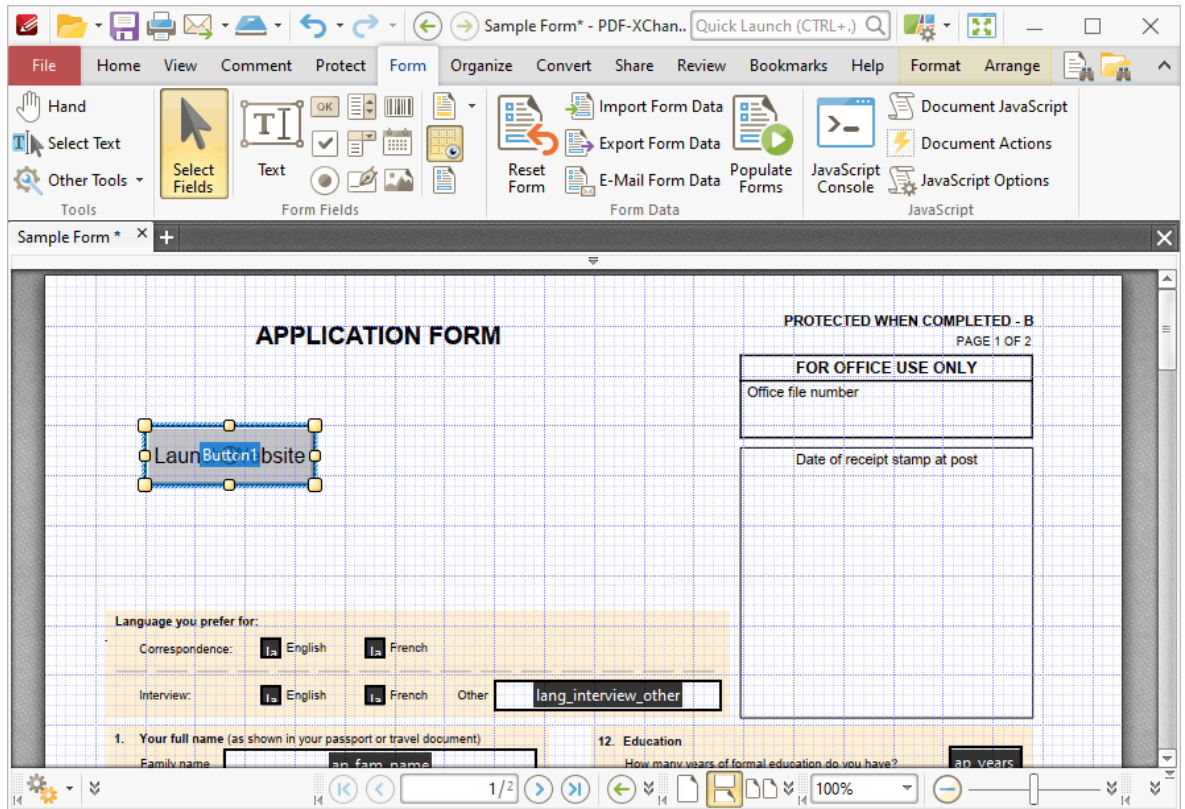

Figure 12. Resized Button

The next step is to add an icon to the button:

5. Click **Select Fields**, then select the button and click **Properties**. The **Push Button Properties** pane will open. Scroll down to the **Options** tab, then select **Icon top, label button** for the **Layout** property. The **Up Icon** property will appear. Click the ellipsis icon on the right of the **Up Icon** property, then select the desired icon from the local computer:



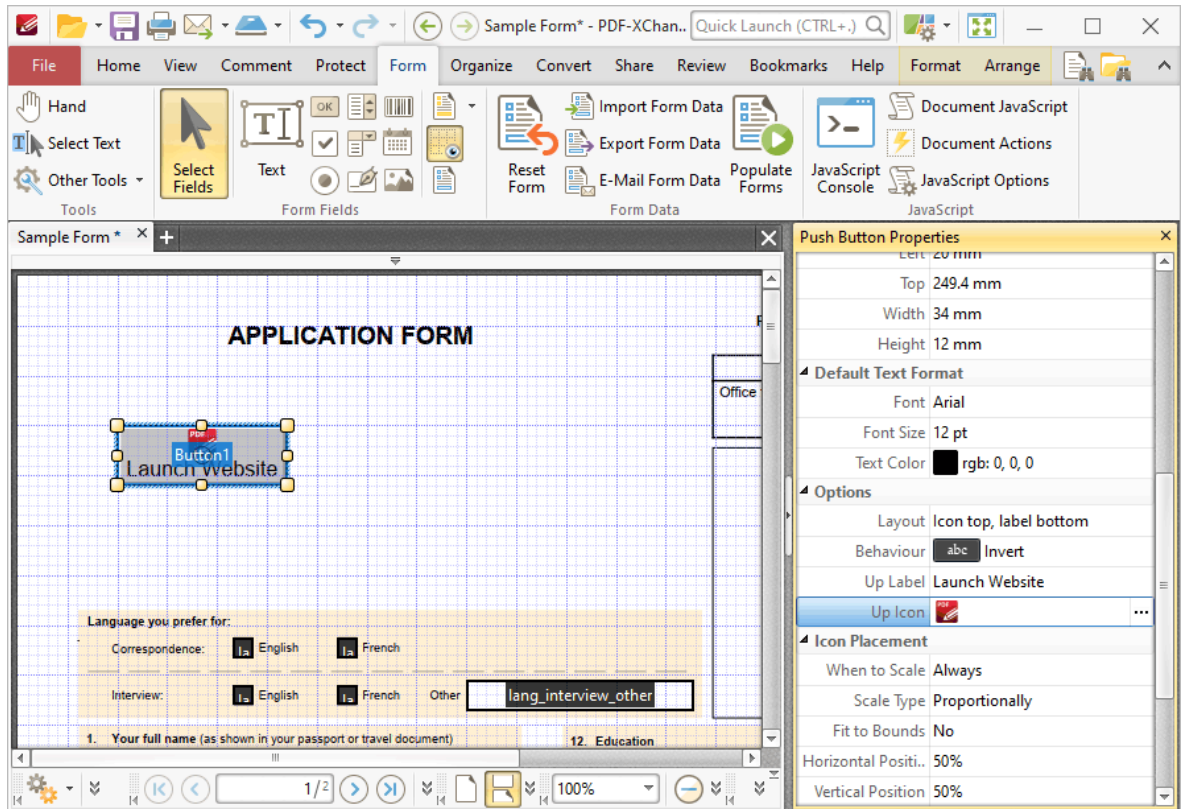

Figure 13. Push Button Properties Pane, Options Properties

The next step is to add the action to the button:

6. Click **Select Fields**, then select the button and click **Properties**. The **Push Button Properties** pane will open. Scroll down to the **Actions** tab, then click the ellipsis icon on the right of the **Mouse Up** property:

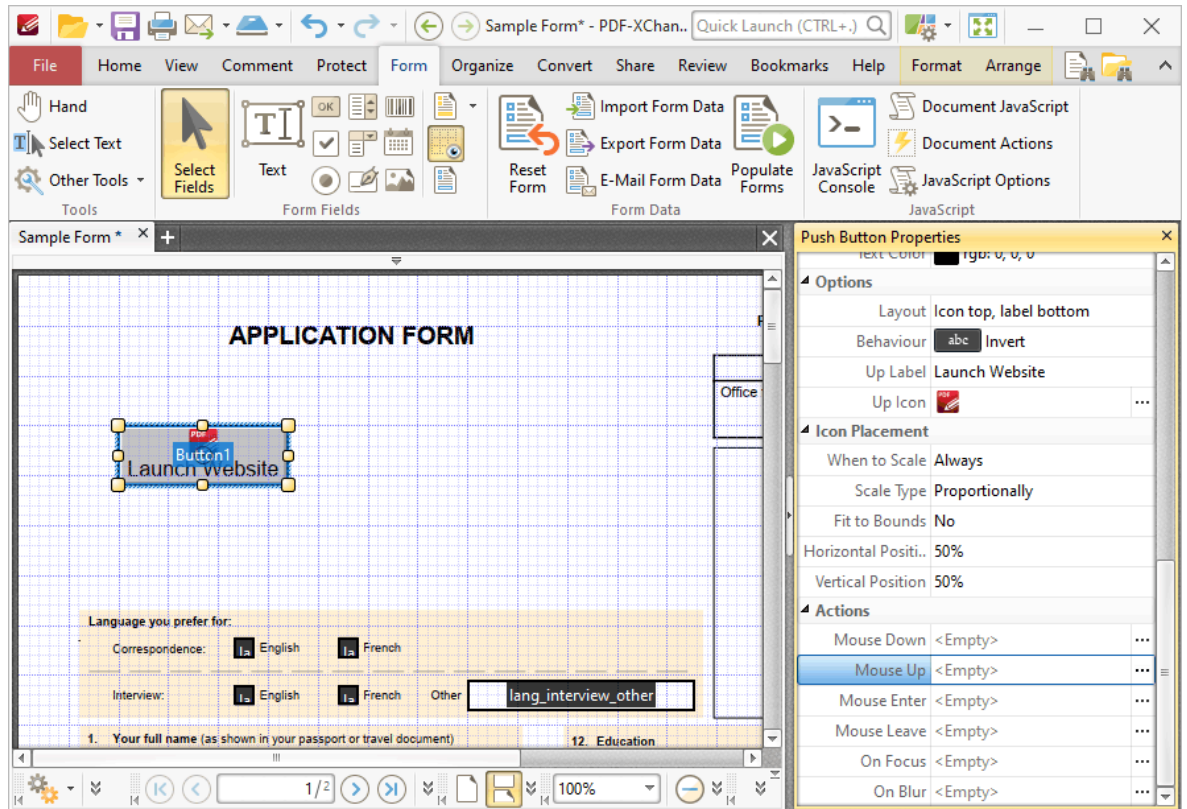

Figure 14. Push Button Properties Pane, Mouse Up Property

The **Edit Action List** dialog box will open.

7. Click **Add** and then click **Open a Web Link** in the submenu:

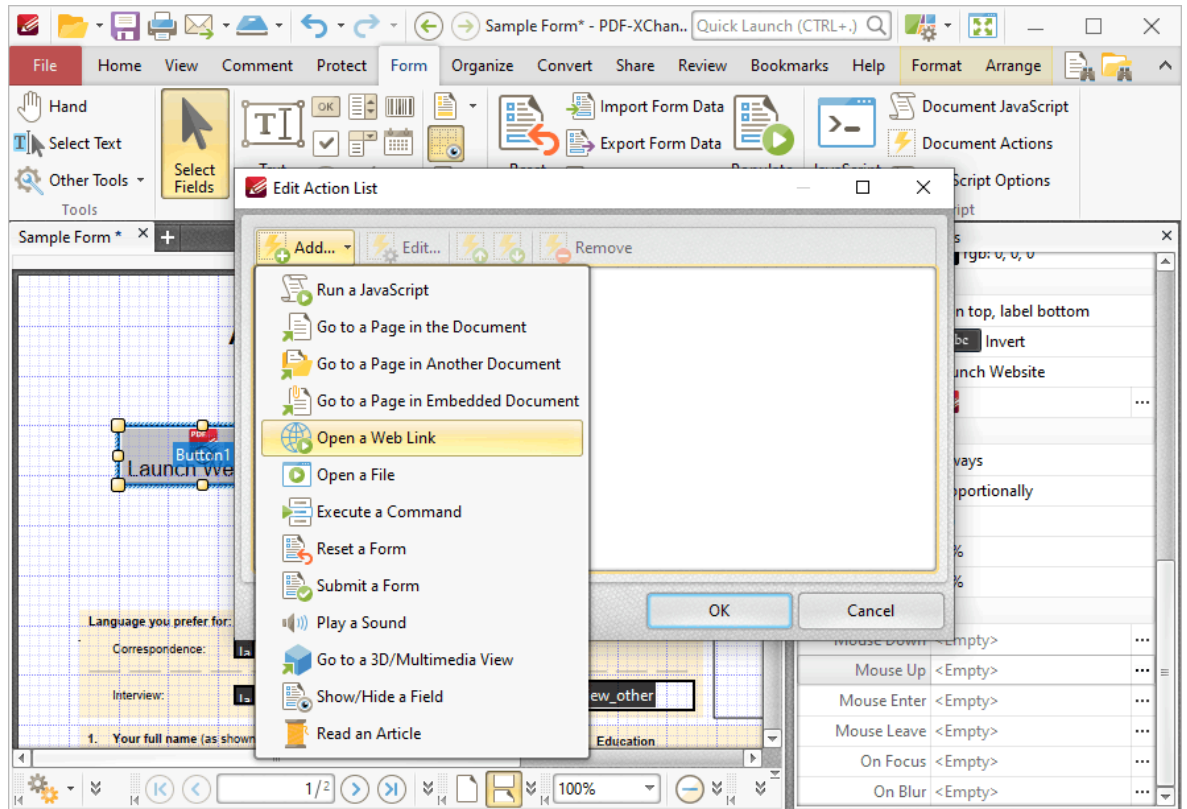

Figure 15. Button Tool, Edit Action List Dialog Box

The **Add Action: "Open a Web Link"** dialog box will open.

8. Enter the desired web location for the button to launch when it is clicked and then click **OK** in both dialog boxes:

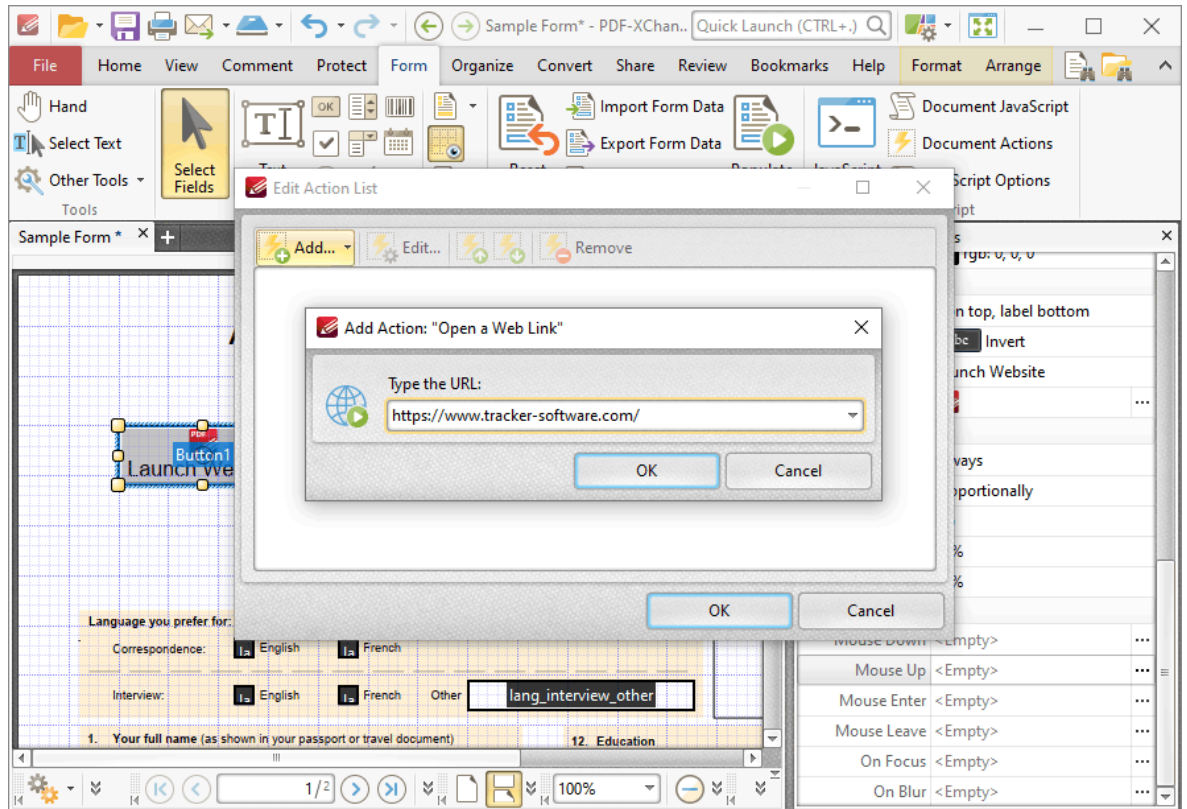

Figure 16. Button Tool, Add Action: "Open a Web Link" Dialog Box

The button is then complete and will launch the **PDF-XChange** website when it is clicked:

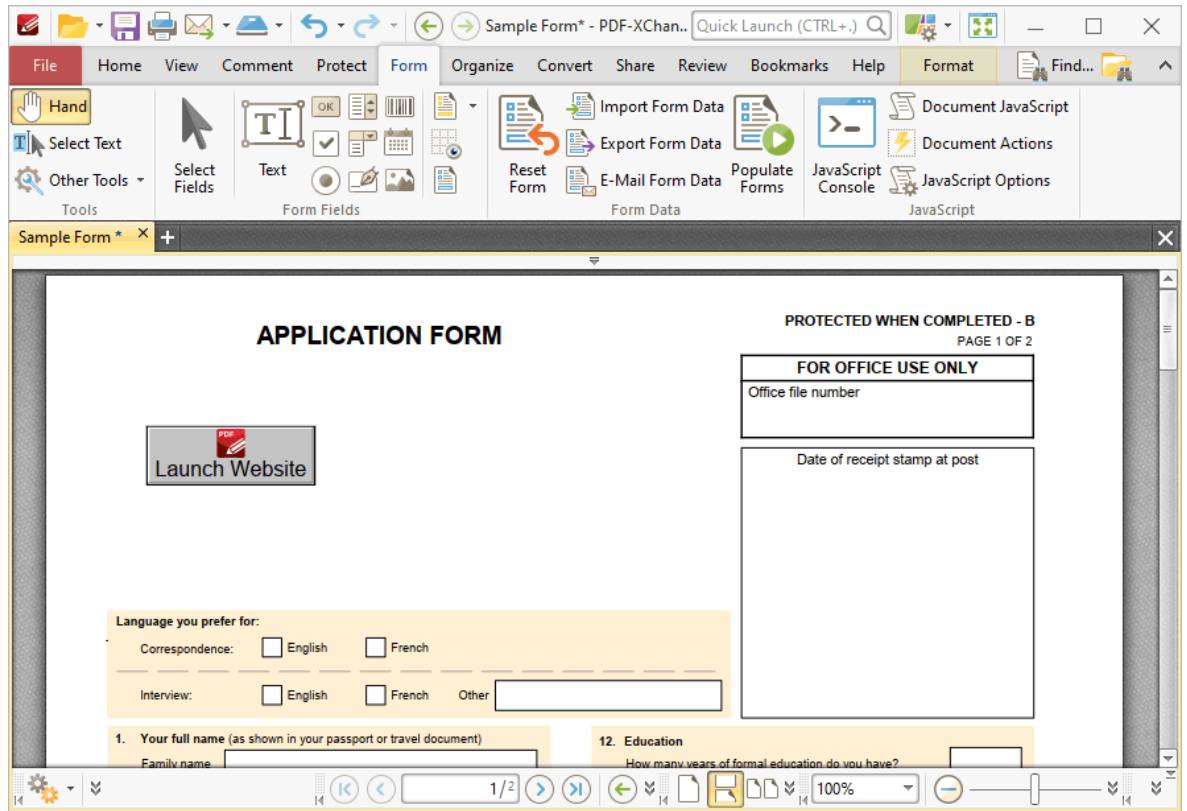

Figure 17. Completed Button

10.4.6.7 Add Digital Signature Fields to Documents



Add Digital Signature Fields to Documents

Digital signatures are used to demonstrate the authenticity of documents and increase their security. They can also be used to determine editing permissions for documents and/or utilize timestamp servers in order to further increase document security and integrity:

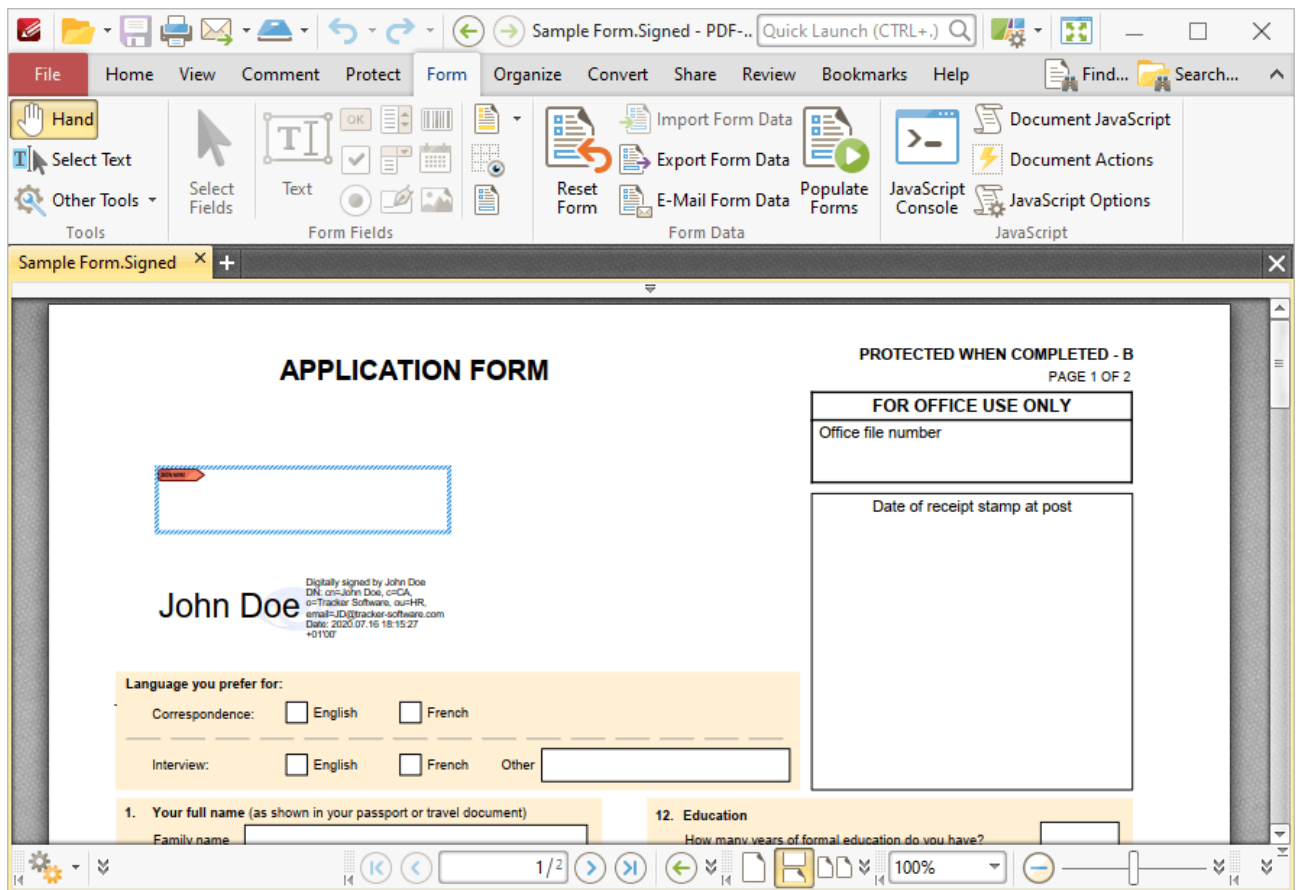

Figure 1. Example Signature Fields, Unsigned (above) and Signed (below)

The functionality of **PDF-XChange Editor** enables a wide range of dynamic customization for signature fields. Click the dropdowns below for further information:

▼ Add Digital Signature Fields to Documents

1. Click the **Form** tab, then click **Digital Signature**. A blue rectangle will be displayed at the location of the pointer. This rectangle represents the signature field:

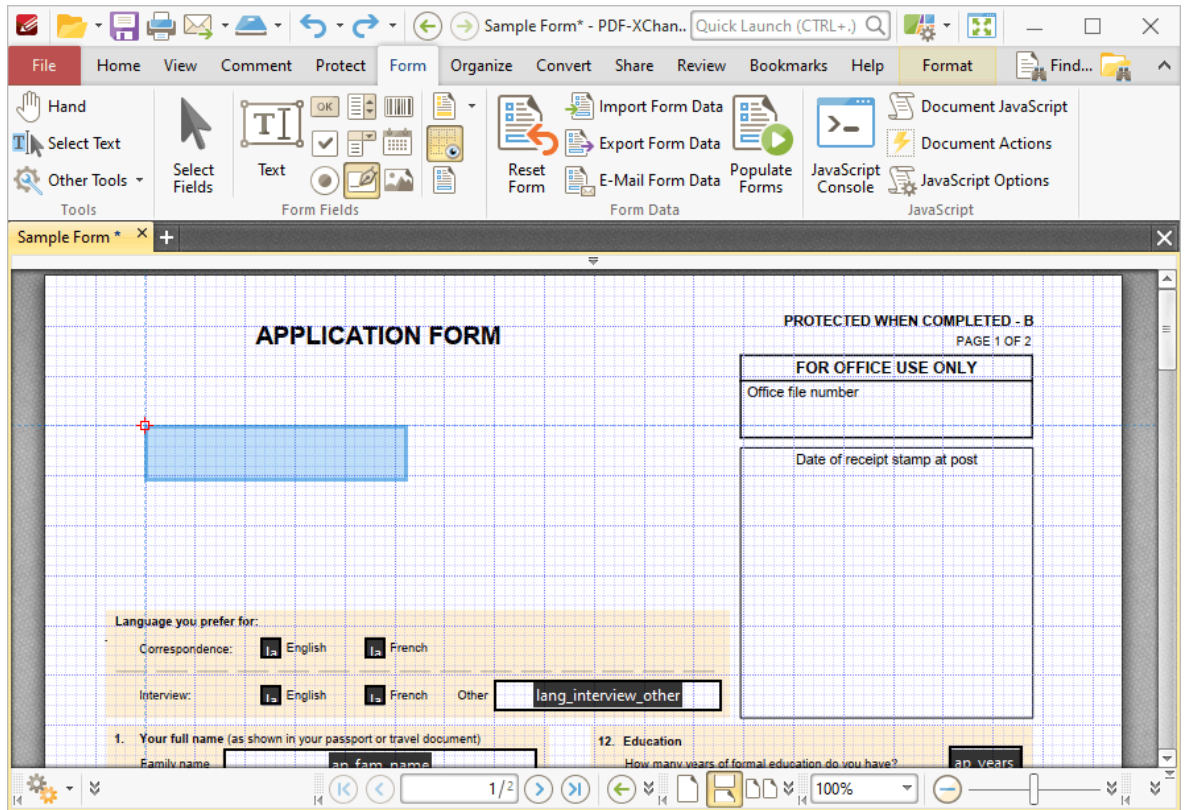

Figure 2. Active Signature Field Tool

2. Move the rectangle to the desired location and then click to add the signature field to the document. Added signature fields appear as below:

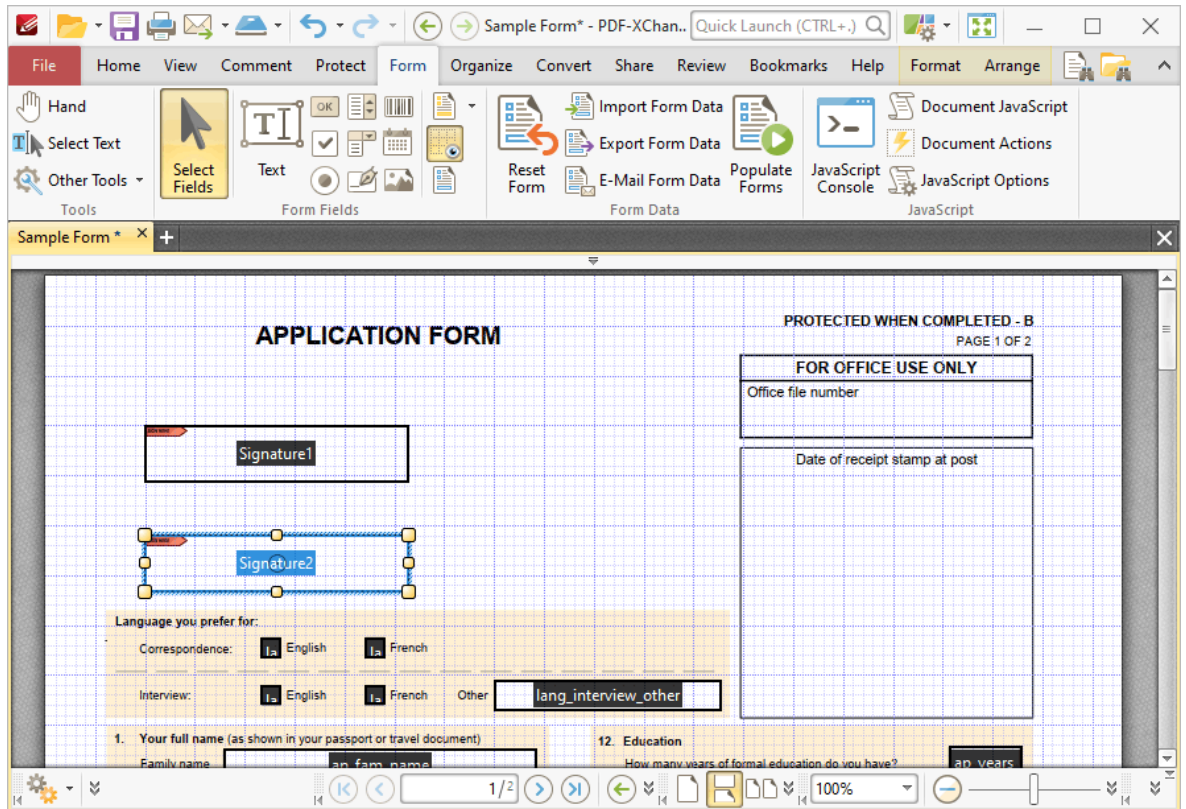

Figure 3. Added Signature Fields

- Click and drag the yellow control points to resize signature fields.
- Use the options in the **Format Tab** to determine the style and appearance of selected signature fields:



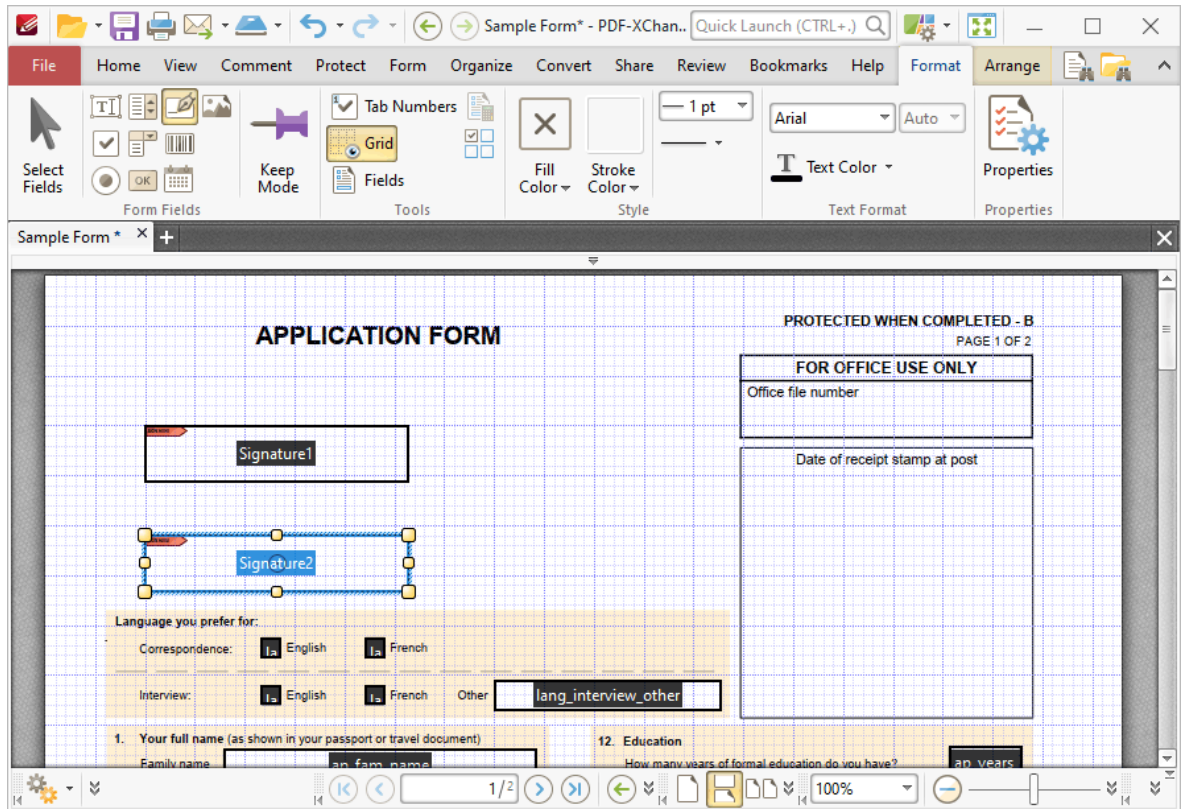

Figure 4. Format Tab, Signature Fields

- Click **Select Fields** to select and edit form fields.
- Click the options in the **Form Fields** group to enable alternative form field formats.
- Click **Keep Mode** to create multiple signature fields consecutively. If this option is disabled then **PDF-XChange Editor** will revert to the designated default tool after the creation of a single signature field.
- Click **Tab Numbers** to show/hide the tab order numbers of form fields.
- The **Calculation Order** setting is not available for signature fields.
- Click **Grid** to enable/disable the grid, which is used to assist in the accurate placement of form fields, as detailed in **(figure 4)**.
- Click **Create Multiple Copies** to create multiple copies of selected form fields, as detailed [here](#).
- Click **Fields** to show/hide the **Fields** pane, which is used to view/edit form fields.
- Click **Fill Color** to determine the fill color of the signature field.
- Click **Stroke Color** to determine the border color of signature fields.
- Click **Width** to determine the width of signature field borders.
- Click **Border** to determine the style of signature field borders.
- Use the **Font** and **Font Size** dropdown menus to determine the font and font size used when signature fields are signed.

- Use the **Text Color** signature field to determine the color of the font used when signature fields are signed.
- Click **Properties** to open the **Digital Signature Properties** pane, which enables the customization of additional elements of signature fields and is detailed in the section below.

### ▼ The Digital Signature Properties Pane

The **Digital Signature Properties** pane can be used to determine a range of style and functionality options for signature fields. For example, it is possible to use the **Actions** properties to add multiple dynamic actions to signature fields, such as running JavaScript, launching web links and opening files on the local computer. (JavaScript is a high-level programming language that can be used to perform custom operations. See [here](#) for an index of existing JavaScript operations that the **PDF-XChange Editor** forms can use, as well as additional information about JavaScript). Click **Select Fields** to select form fields, then click the desired field and click **Properties** in the **Format** tab to open the **Digital Signature Properties** pane:

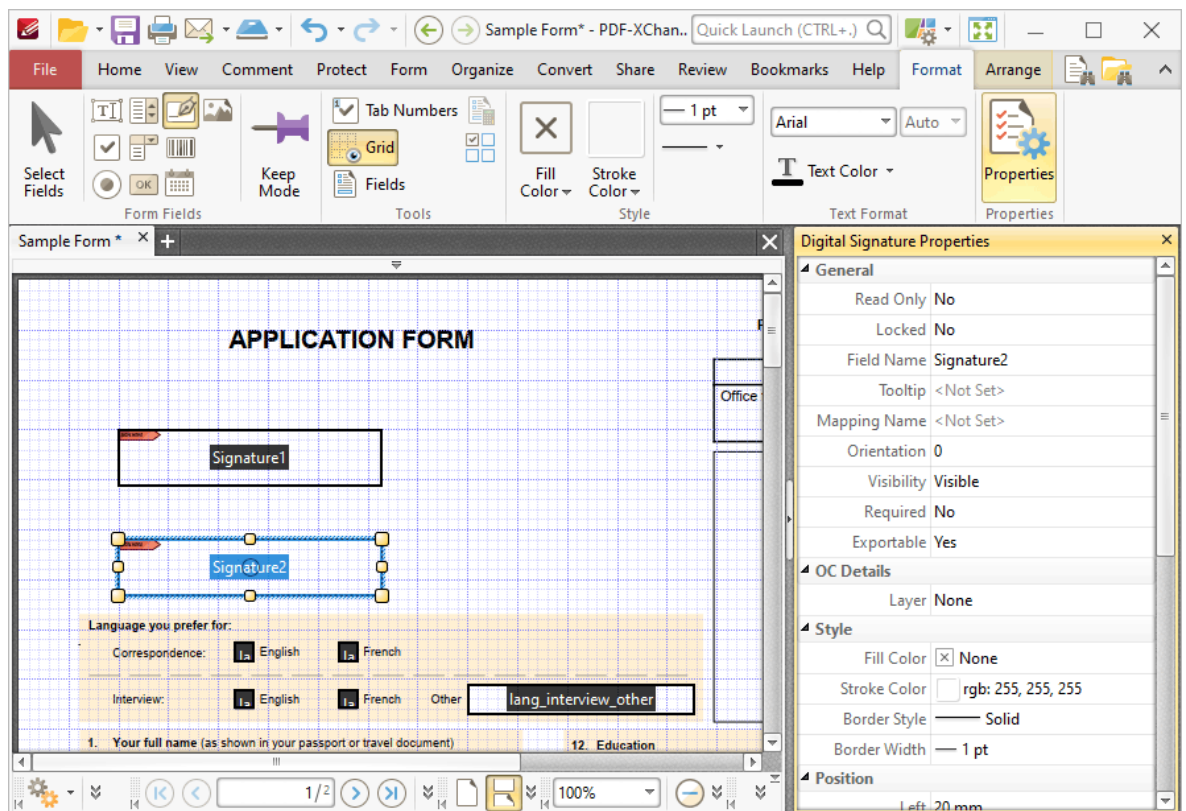

Figure 5. Signature Field Tool, Digital Signature Properties Pane

The options detailed below are available in the **Digital Signature Properties** pane:

The **General** properties determine the general parameters of signature fields:

- **Read Only** determines whether or not the signature field can be edited.
- **Locked** determines whether or not signature fields can be moved, and whether or not their properties can be modified.
- **Field Name** determines the name of the signature field. This name is present when the **Edit Form** tool is selected, and when signature fields are listed in the [Fields pane](#).<sup>1016</sup>
- **Tooltip** determines the information displayed when the pointer is hovered over the signature field.
- **Mapping Name** determines the mapping name that the signature field uses. This name is used to reference interactive form data when the form is exported, and does so without affecting the appearance of the name in the original document.
- **Orientation** determines the orientation of the signature field.
- **Visibility** determines the visibility of the signature field.
- **Required** determines whether or not the digital signature field is a required field. Required fields must be filled before documents that contain them can be submitted.
- **Exportable** determines whether or not the digital signature field data can be exported from the form.

The **OC Details** property determines the optional content layer to which the digital signature field belongs. When a field belongs to an optional content layer, it displays only when the layer is enabled. Use the **Layers** pane to view/create/edit layers, as detailed [here](#).<sup>1024</sup>

The **Style** properties determine stylistic elements of signature fields. They are detailed beneath [\(figure 4\)](#).

The **Position** properties determine the position and dimensions of signature fields:

- **Left** determines the distance of the signature field from the left margin.
- **Top** determines the distance of the signature field from the bottom of the page.
- **Width/Height** determine the width/height of the signature field.

The **Default Text Format** properties determine the default properties when text is entered into the signature field:

- **Font** determines the font used for digital signature fields.
- **Font Size** determines the size of the font.
- **Text Color** determines the color of the text.

The **Actions** properties determine the action taken when users interact with the signature field:

- **Mouse Down** initiates an action when the left mouse button is pressed (without being released).
- **Mouse Up** initiates an action when the left mouse button is clicked (pressed and released).
- **Mouse Enter** initiates an action when the pointer moves into the signature field.
- **Mouse Leave** initiates an action when the pointer moves out of the signature field.
- **On Focus** initiates an action when the signature field is selected.

- **On Blur** initiates an action when the signature field is deselected.
- Click the ellipsis icon on the right of actions to add/edit signature field actions:

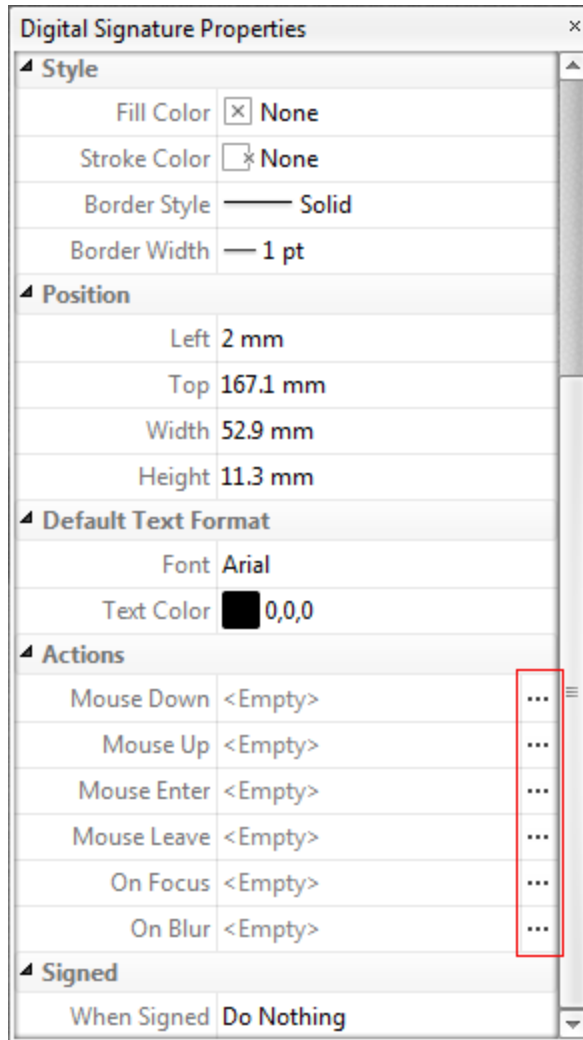

Figure 6. Digital Signature Properties Pane, Action Ellipses

The process of adding actions is detailed [here](#).

The **When Signed** property determines the action taken when signature fields are signed:

- **Do Nothing** determines that no action is taken.
- **Custom Action** enables the activation of custom JavaScript when signature fields are signed. When this option is selected the **Action** property will appear. Click the ellipsis icon on the right of the property to add JavaScript:

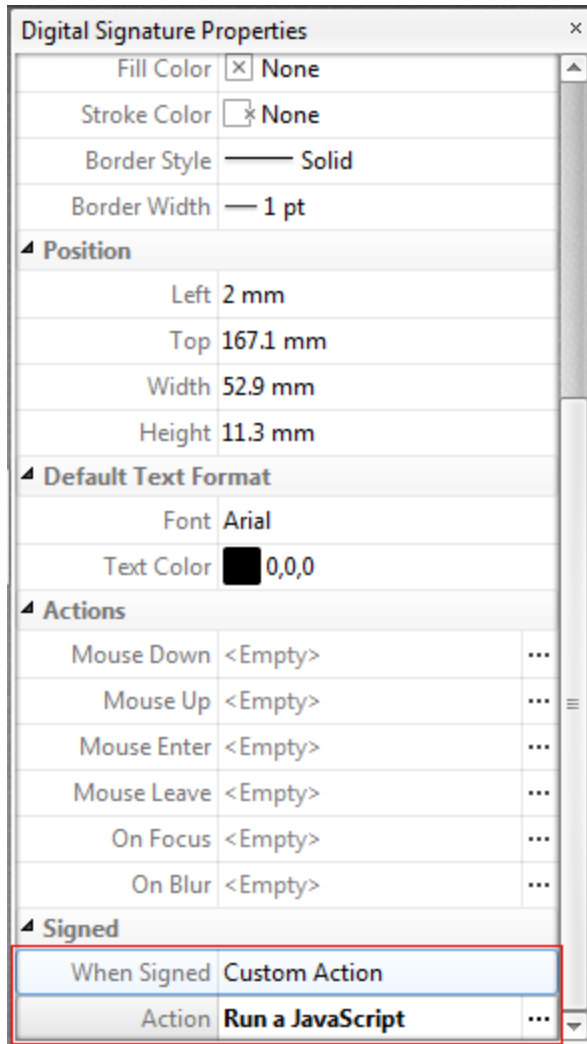

Figure 7. Digital Signature Properties Pane, Action Property

The **Edit Action: "Run a JavaScript"** dialog box will open. Enter the desired JavaScript for the action and then click **OK**:

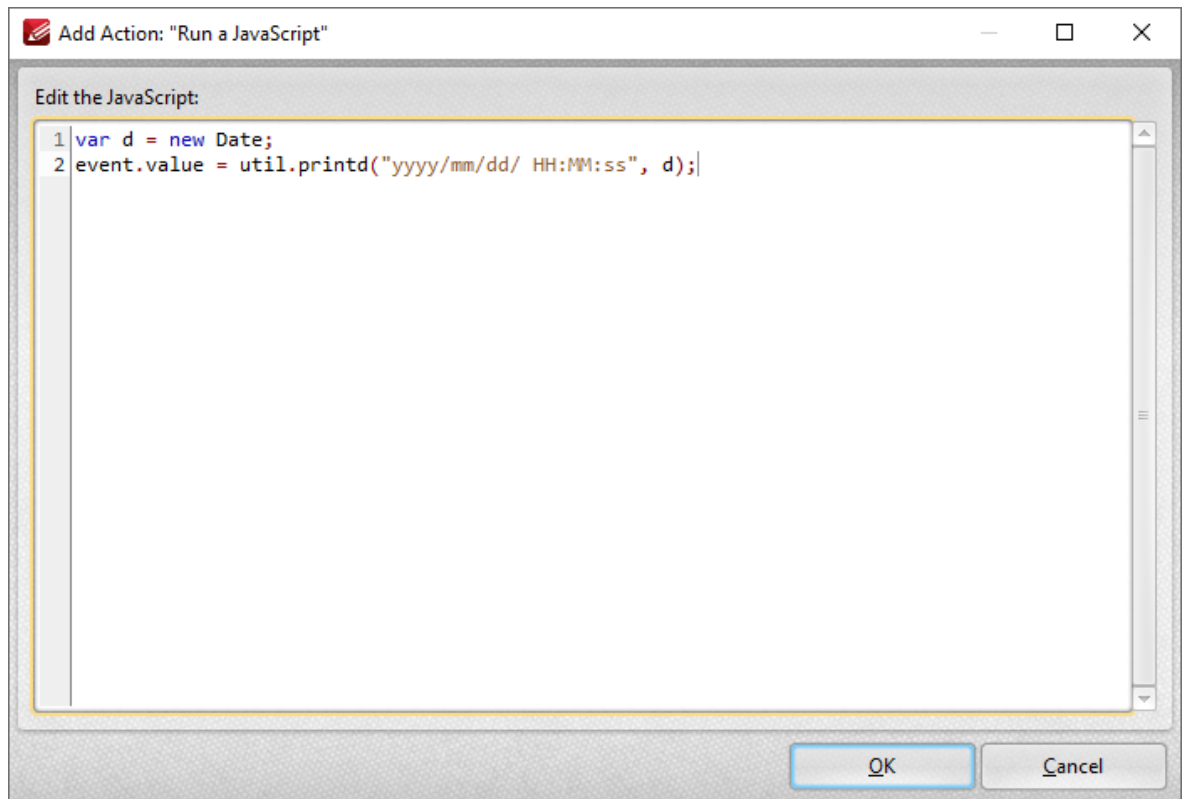

Figure 8. Edit Action: "Run a JavaScript" Dialog Box

- **Mark as Read-Only** sets specified fields as read-only in order to disable subsequent editing. When this option is selected, the **Fields Range** property will appear beneath the **When Signed** property:

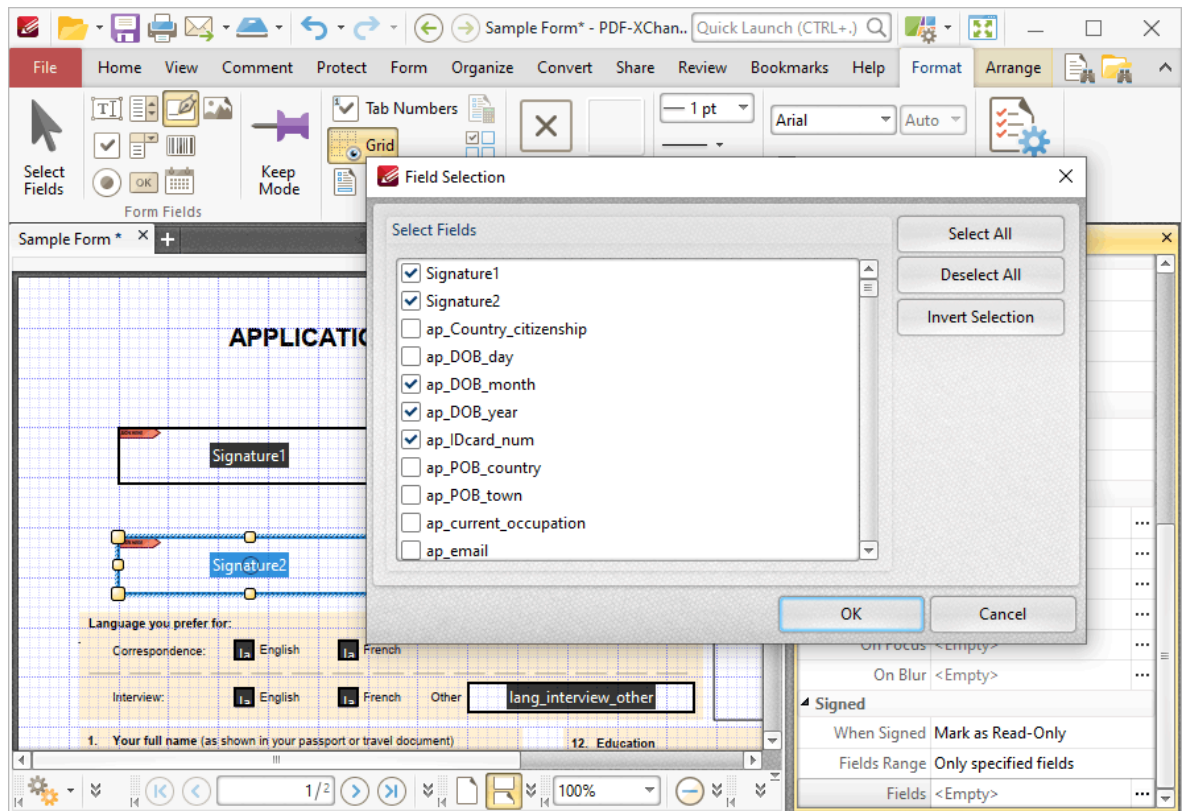

Figure 9. Mark as Read-Only Options

- Select **All fields** to set all fields in the document as read-only.
- Select **Only specified Fields** to specify the fields that are set as read-only.
- Select **All fields except specified** to specify the fields that are not set as read-only.

The **Fields** property will become available when an option to specify fields is selected. Click the ellipsis icon on the right of the property to specify fields. The **Field Selection** dialog box detailed in (**figure 9**) will open. Select the desired fields and then click **OK**.

### ▼ Signature Field Creation Example

The following example will detail the creation of a signature field that displays a tooltip when the pointer is hovered over it, and creates a bookmark for the current page when it is clicked:

1. Click the **Form** tab, then click **Digital Signature**. The blue rectangle that represents the signature field will be displayed beneath the pointer:

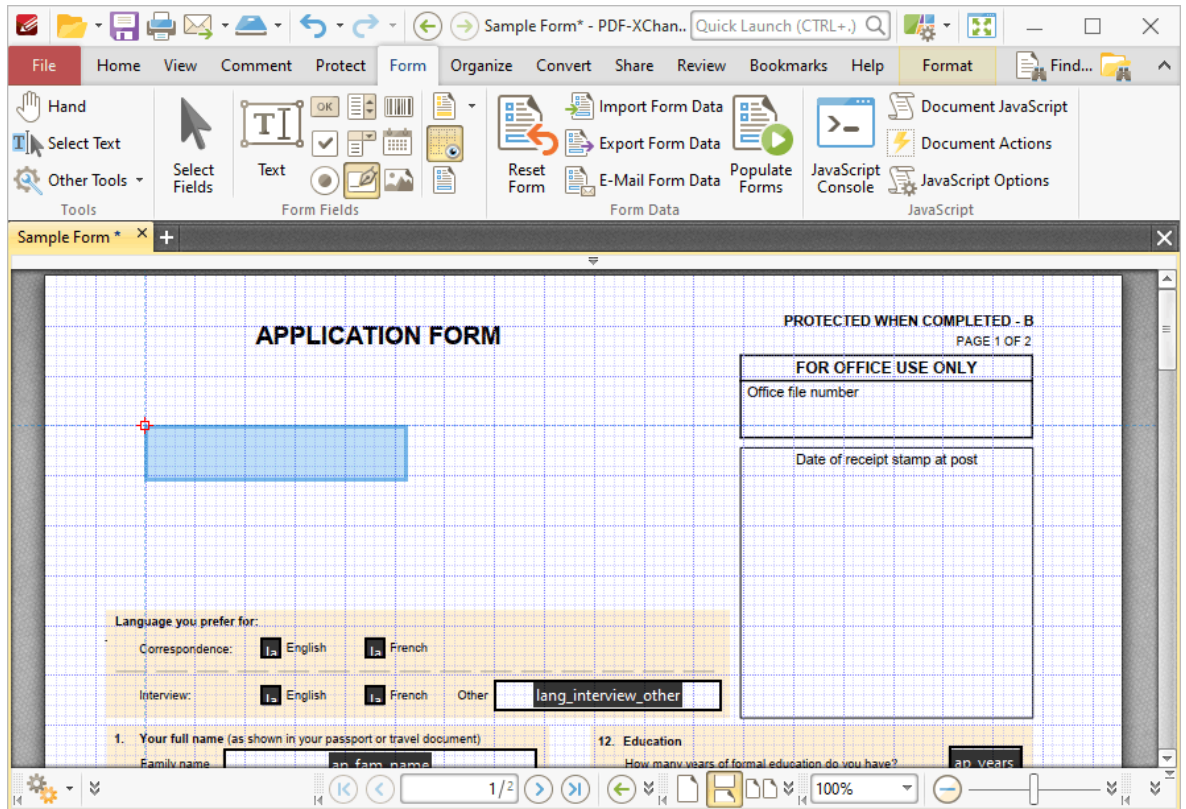

Figure 10. Active Signature Field Tool

2. Click to add the signature field, then click the **Format** tab and click **Properties**. The **Digital Signature Properties** pane will open:



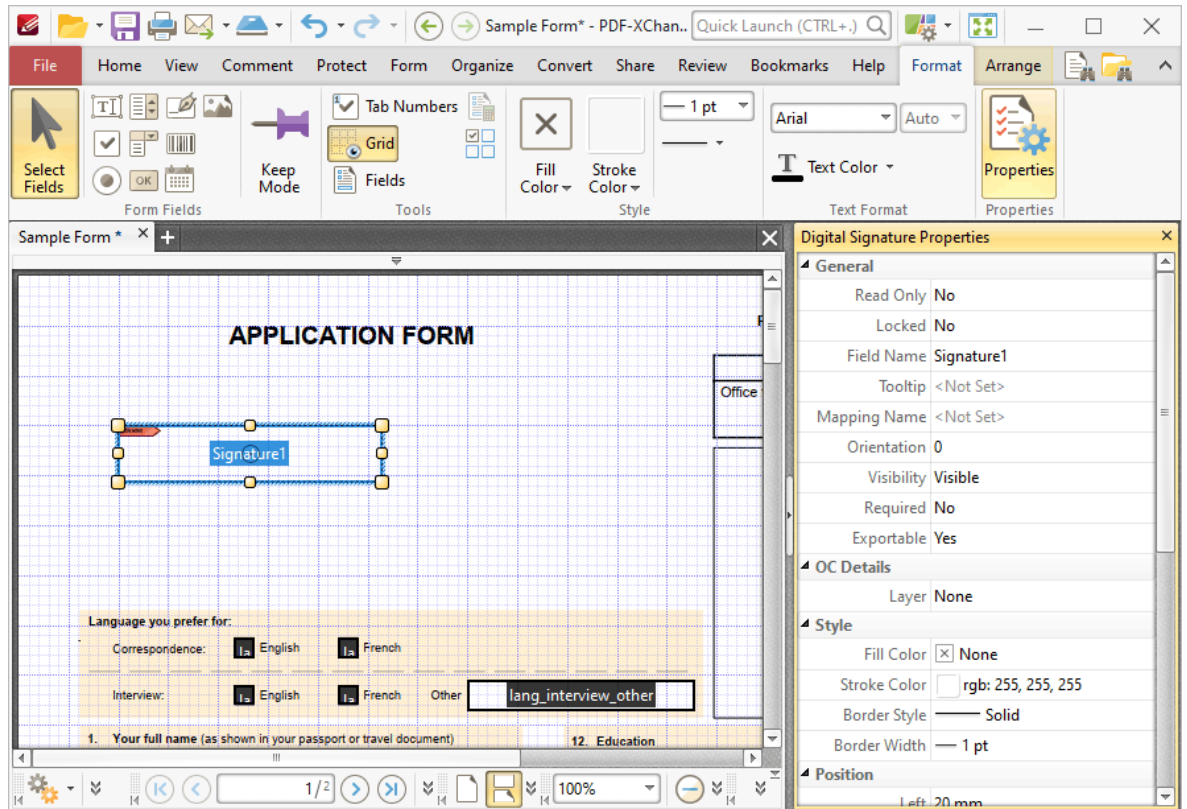

Figure 11. Active Signature Field Tool, Digital Signature Properties Pane

3. Click the **Tooltip** property and enter the desired text for the tooltip:

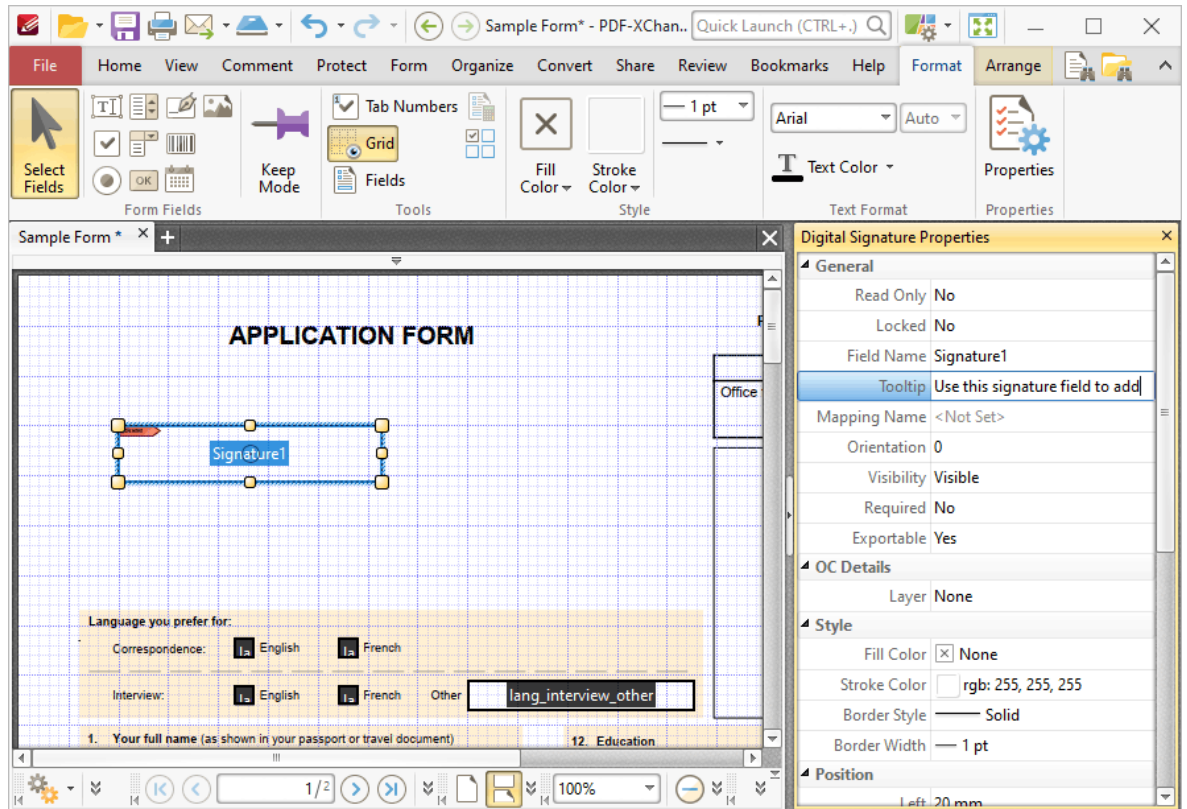

Figure 12. Digital Signature Properties Pane, Tooltip Property

4. Scroll down the **Digital Signature Properties** pane to the **Actions** properties and click the ellipsis icon on the right of the **Mouse Up** property:

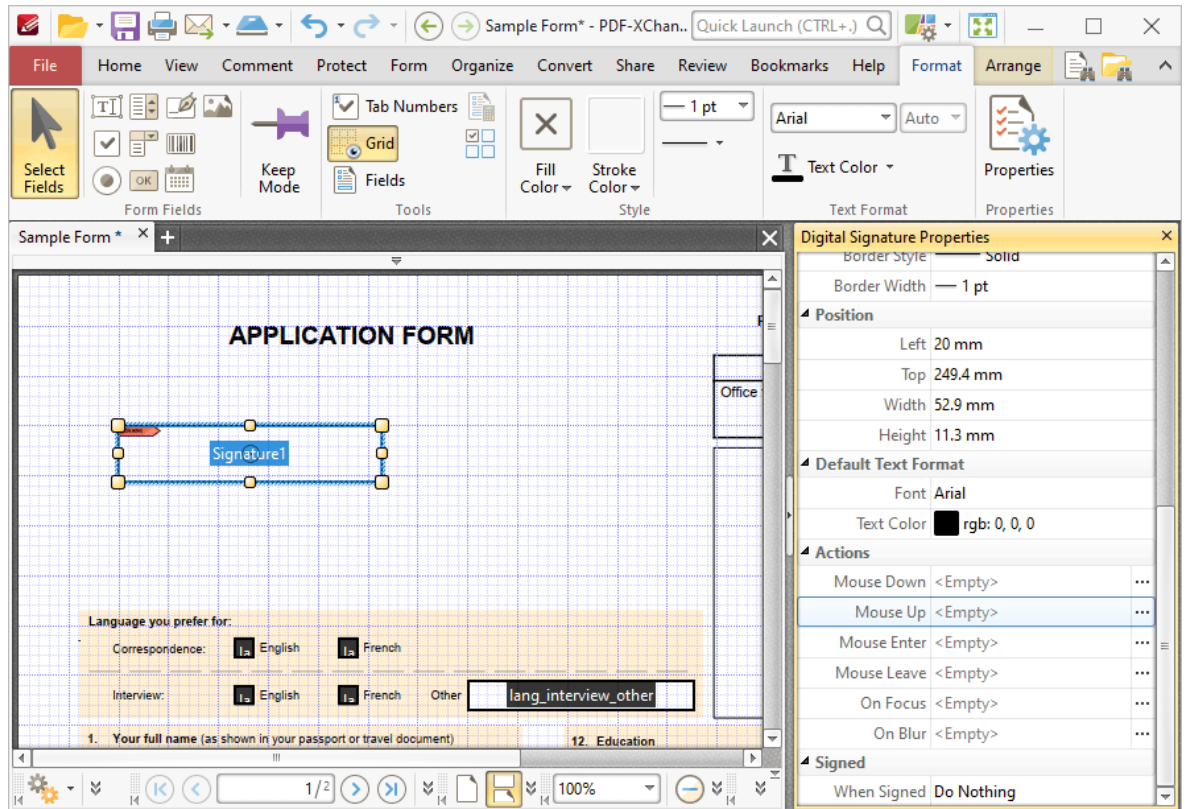

Figure 13. Digital Signature Properties Pane, Mouse Up Property

The **Edit Action List** dialog box will open.

5. Click **Add** in the **Edit Action List** dialog box and then click **Execute a Command** in the dropdown menu:

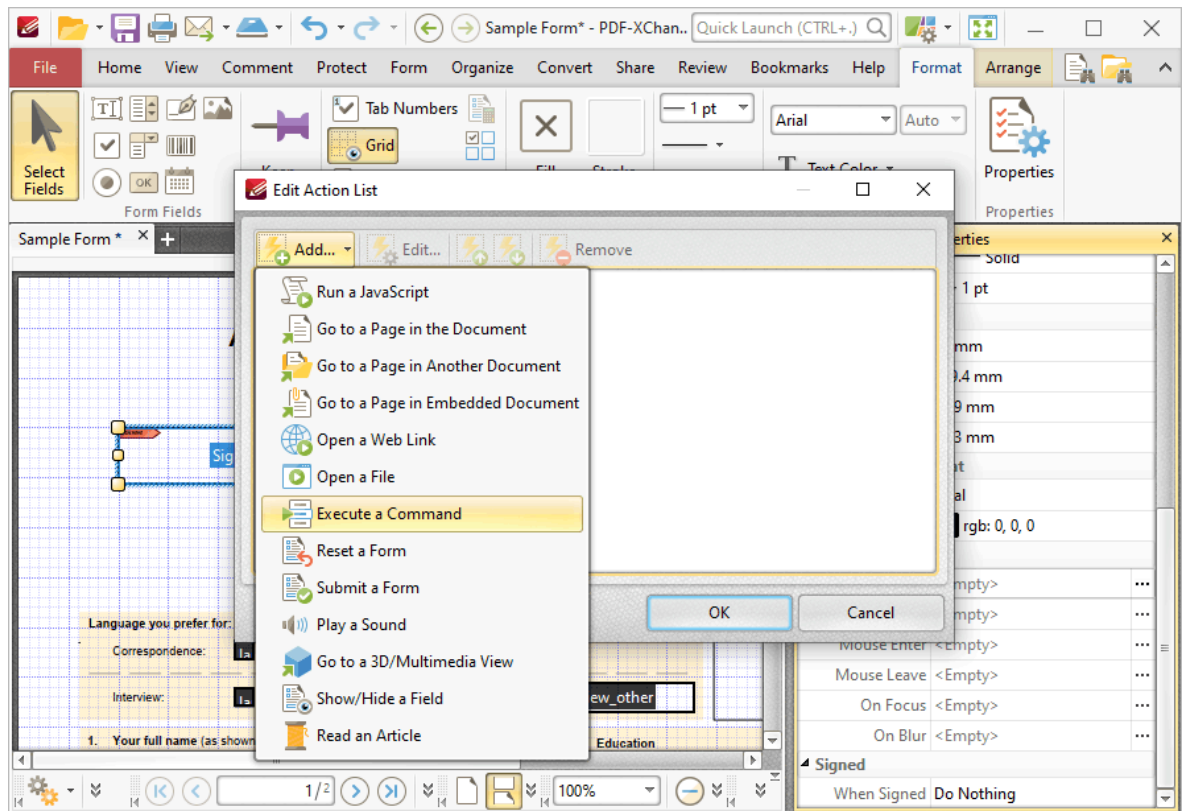

Figure 14. Edit Action Dialog Box, Execute a Command

The **Add Action: "Execute a Command"** dialog box will open.

6. Click the dropdown menu, then scroll down to and click the **NewBookmark** command:

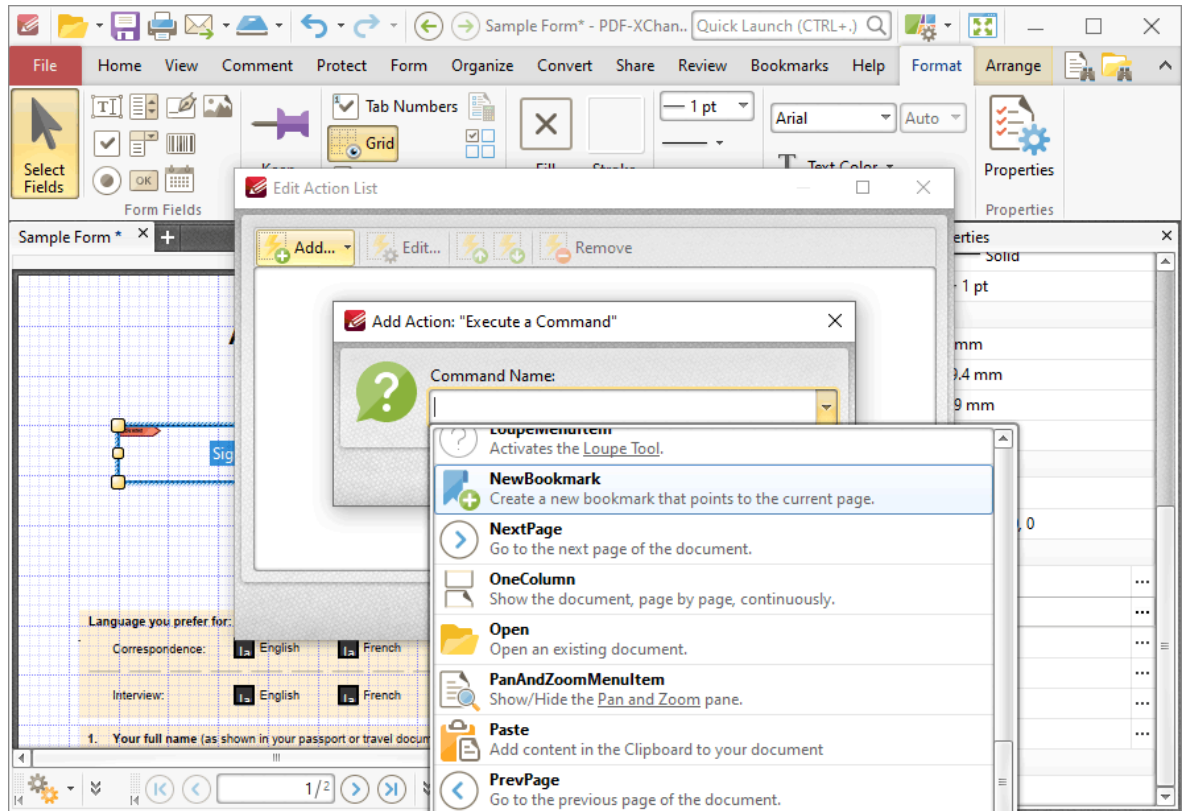

Figure 15. New Bookmark Command

7. Click **OK** in the **Add Action: "Execute a Command"** and **Edit Action List** dialog boxes.

The signature field is then complete. The tooltip entered at step three will be present when the pointer is hovered over the signature field:

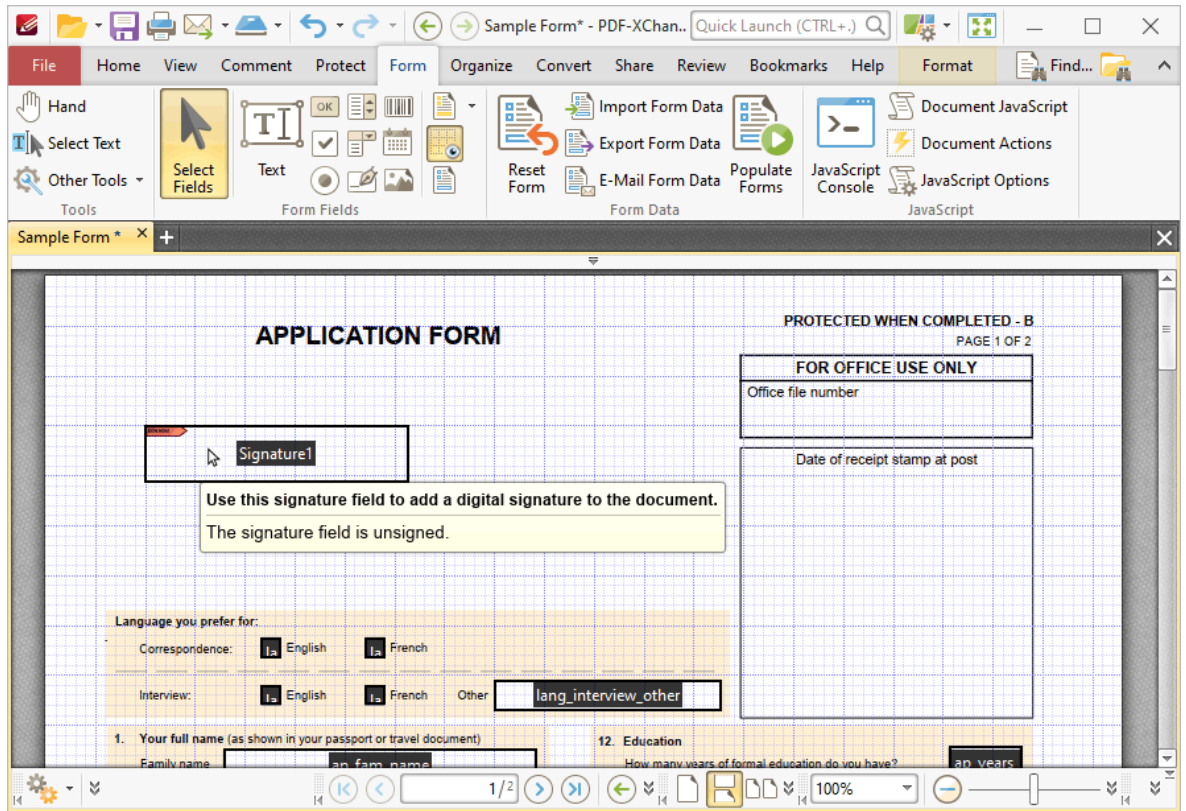

Figure 16. Active Tooltip

A new bookmark is created for the current page when the signature field is clicked:

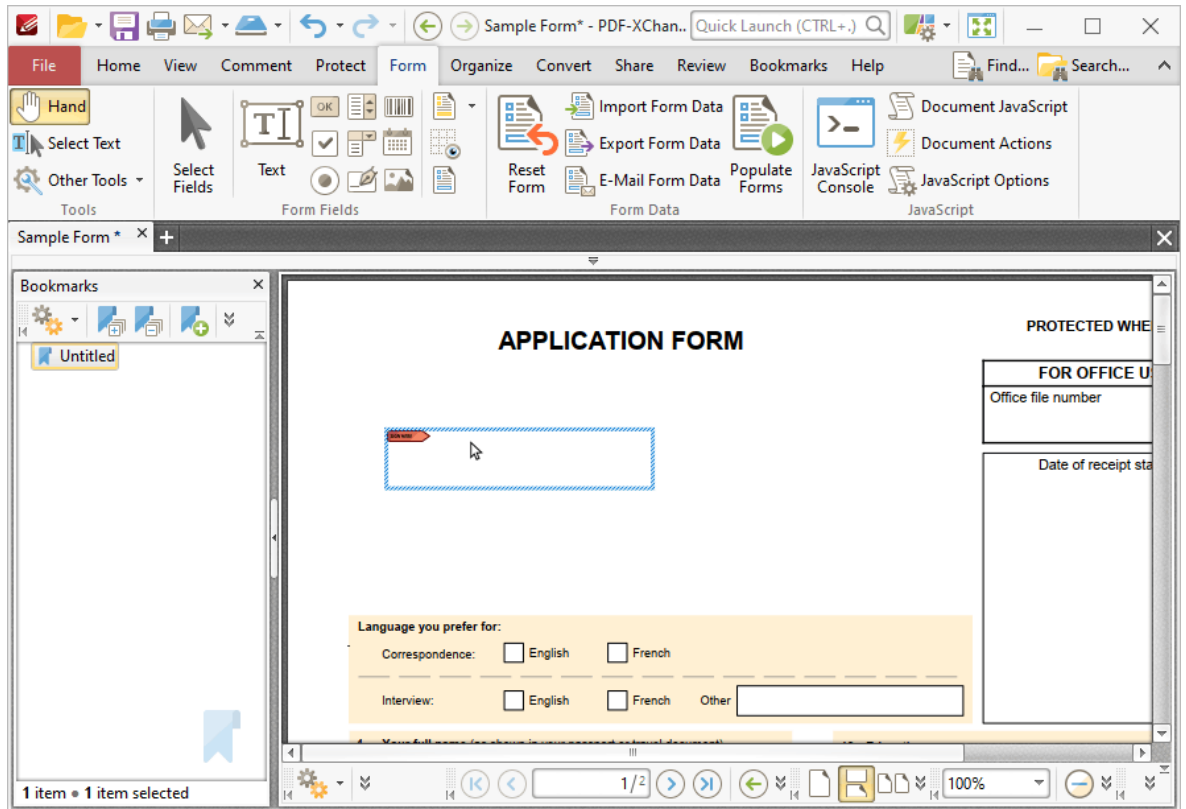

Figure 17. New Bookmark Created

10.4.6.8 Add Barcodes to Documents



Add Barcodes to Documents

Barcodes enable the encoding of form data and display it as a visual pattern that can be decoded by compatible software/hardware:

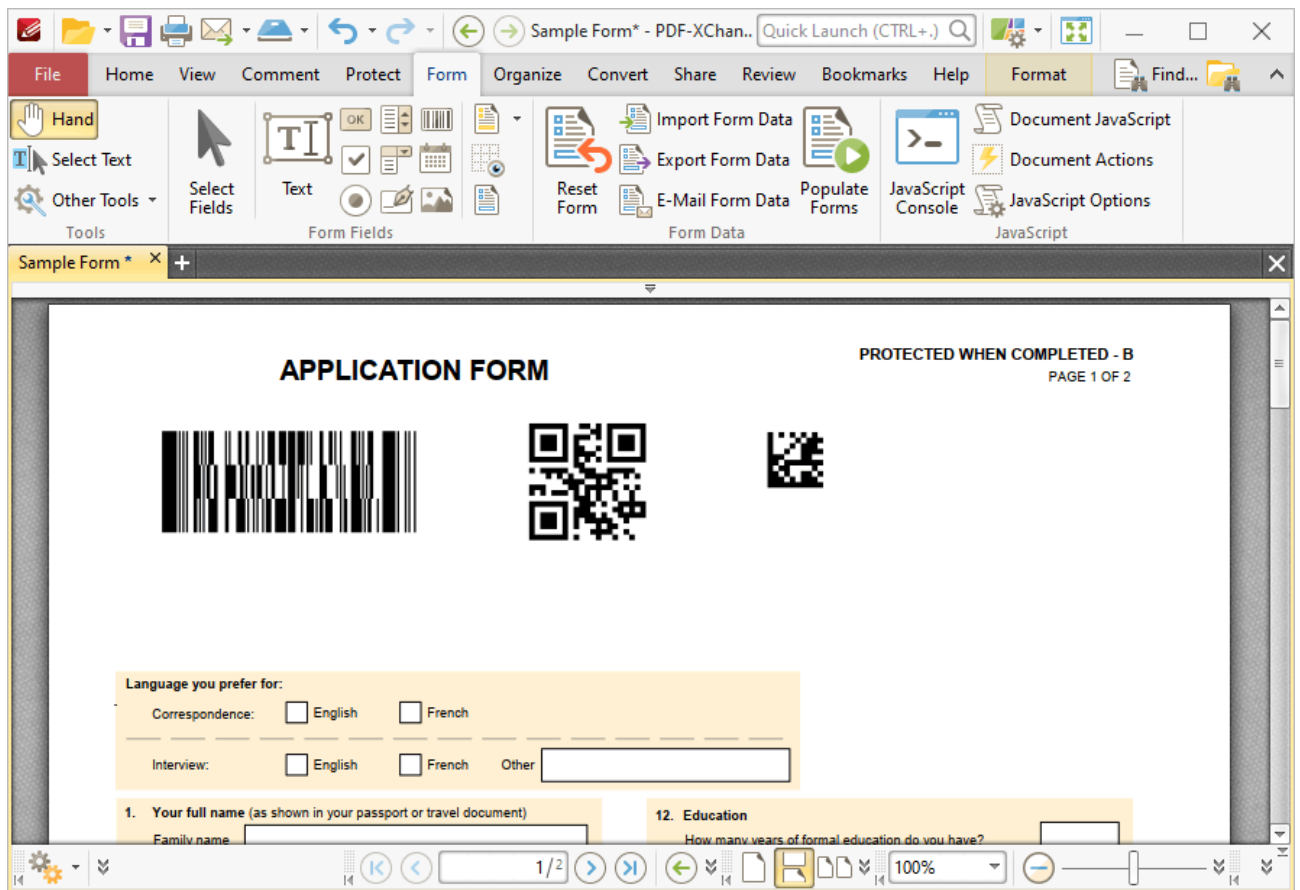

Figure 1. Example Barcodes. PDF417 Barcode (Left), QR Code Barcode (Center), Data Matrix Barcode (Right)

The functionality of **PDF-XChange Editor** enables a wide range of dynamic customization for barcodes. Click the dropdowns below for further information:

▼ Add Barcodes to Documents



1. Click the **Form** tab, then click **Barcode**. A blue rectangle will be displayed at the location of the pointer. This rectangle represents the barcode:

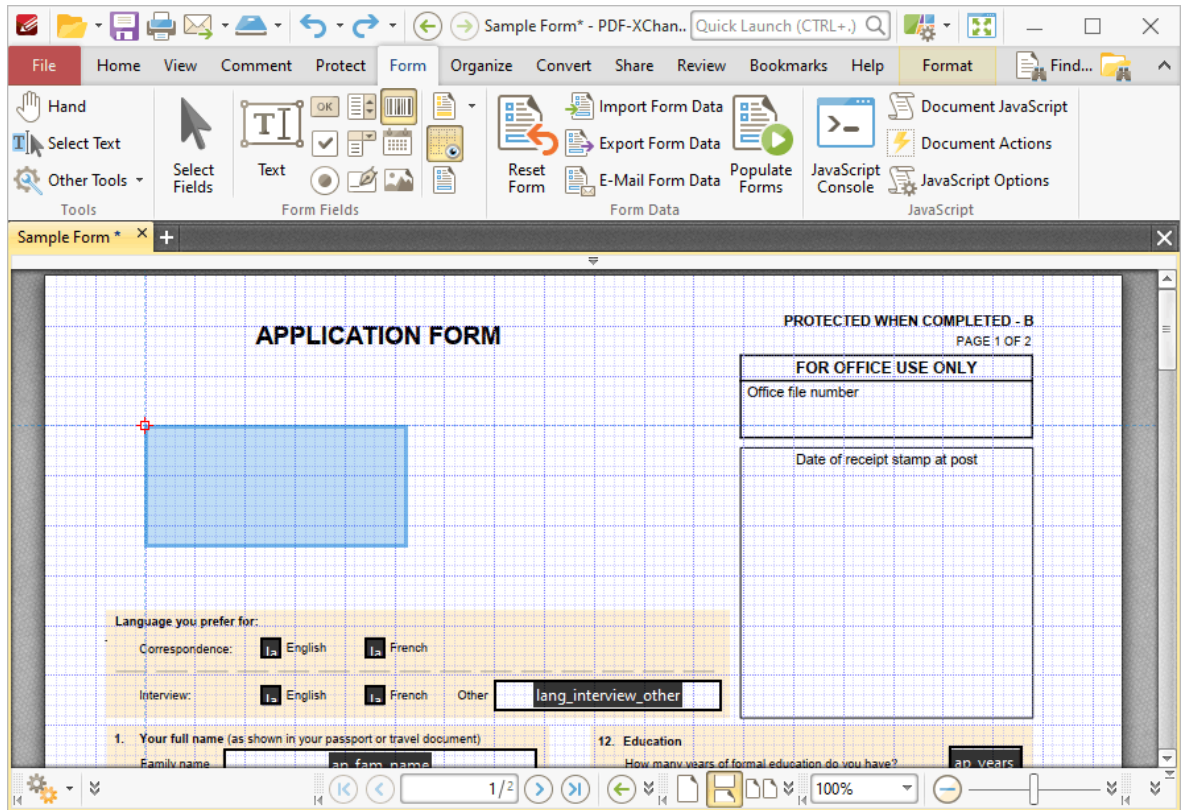

Figure 2. Active Barcode Tool

2. Move the rectangle to the desired location and then click to add the barcode to the document. Added barcodes appear as below:

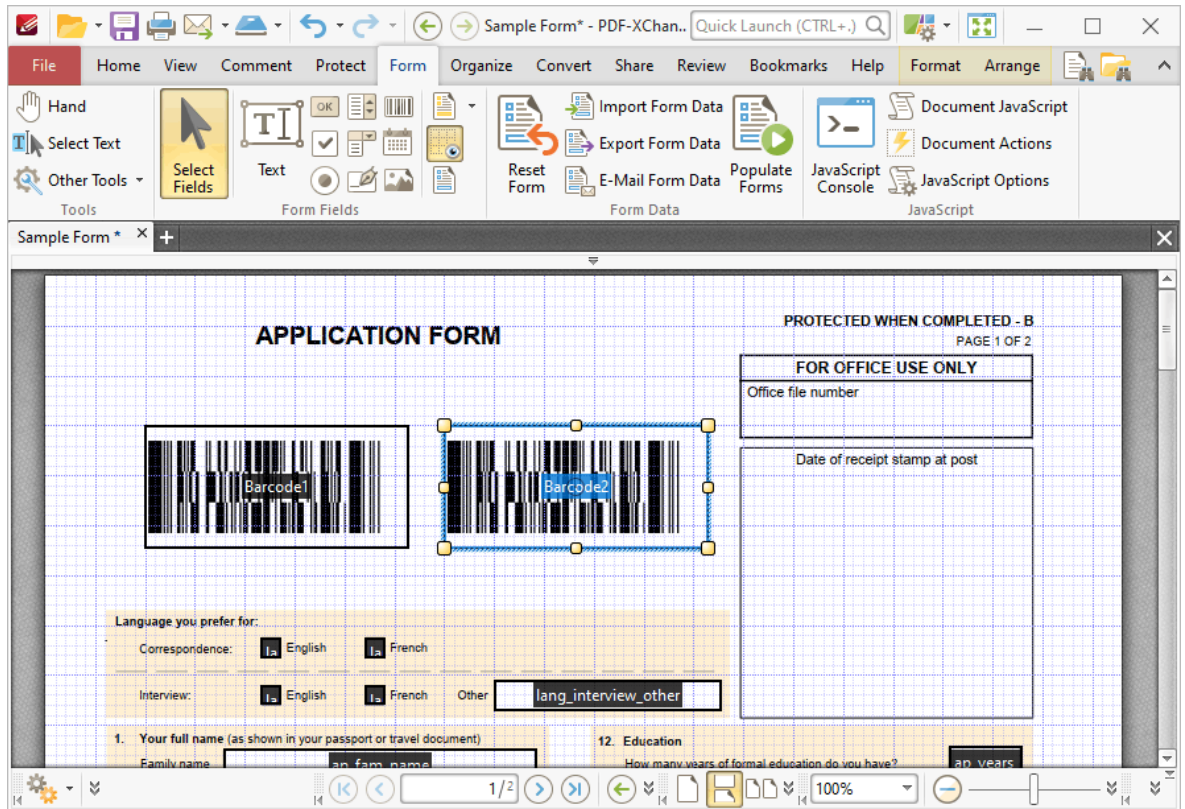

Figure 3. Added Barcodes

- Click and drag the yellow control points to resize barcodes.
- Use the options in the **Format Tab** to determine the style and appearance of selected barcodes:

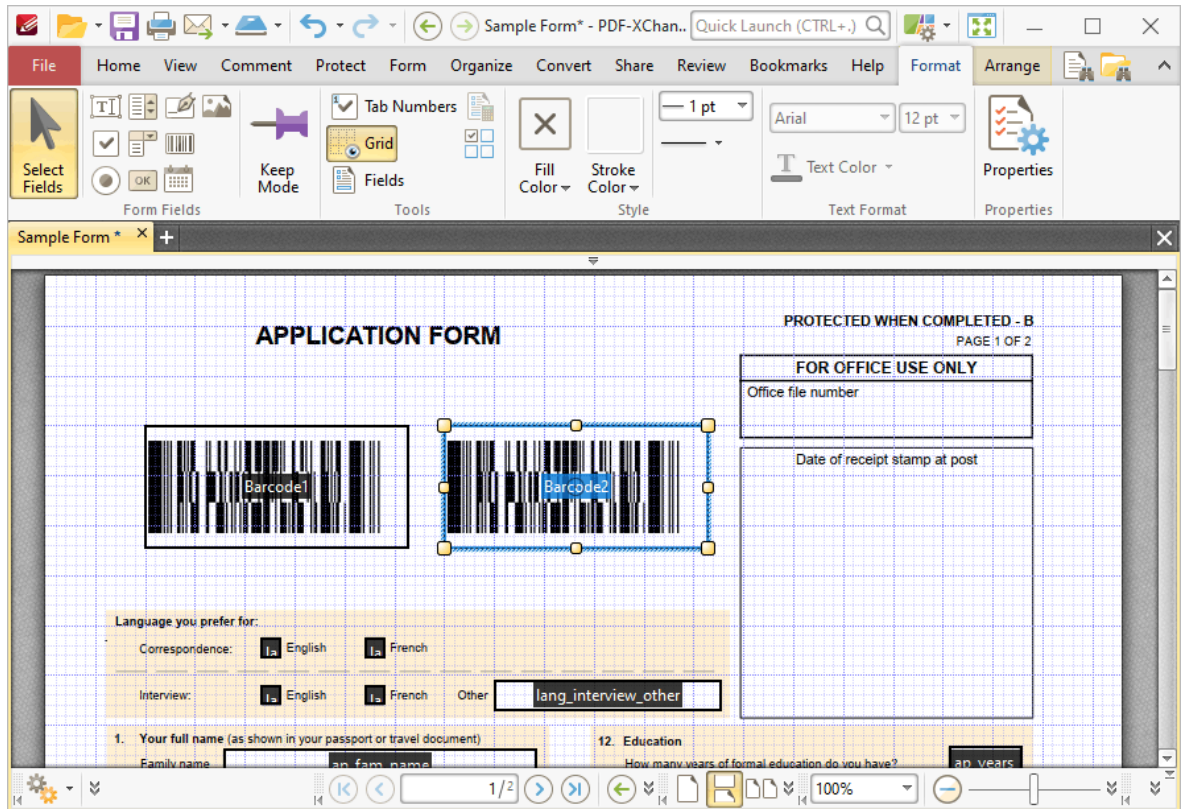

Figure 4. Format Tab, Barcodes

- Click **Select Fields** to select and edit form fields.
- Click the options in the **Form Fields** group to enable alternative form field formats.
- Click **Keep Mode** to create multiple barcodes consecutively. If this option is disabled then **PDF-XChange Editor** will revert to the designated default tool after the creation of a single barcode.
- Click **Tab Numbers** to show/hide the tab order numbers of form fields.
- The **Calculation Order** setting is not available for barcodes.
- Click **Grid** to enable/disable the grid, which is used to assist in the accurate placement of form fields, as detailed in **(figure 4)**.
- Click **Create Multiple Copies** to create multiple copies of selected form fields, as detailed [here](#).
- Click **Fields** to show/hide the **Fields** pane, which is used to view/edit form fields.
- The **Fill Color** option is not available for barcodes.
- Click **Stroke Color** to determine the border color of barcodes.
- The **Width, Border** and **Font** options are not available for barcodes.
- Click **Properties** to open the **Barcode Field Properties** pane, which enables the customization of additional elements of barcodes and is detailed in the section below.

## ▼ The Barcode Field Properties Pane

The **Barcode Field Properties** pane can be used to determine a range of style and functionality options for barcodes. For example, it is possible to use the **Actions** properties to add multiple dynamic actions to barcodes, such as running JavaScript, launching web links and opening files on the local computer. (JavaScript is a high-level programming language that can be used to perform custom operations. See [here](#) for an index of existing JavaScript operations that the **PDF-XChange Editor** forms can use, as well as additional information about JavaScript). Click **Select Fields** to select form fields, then click the desired field and click **Properties** in the **Format** tab to open the **Barcode Field Properties** pane:

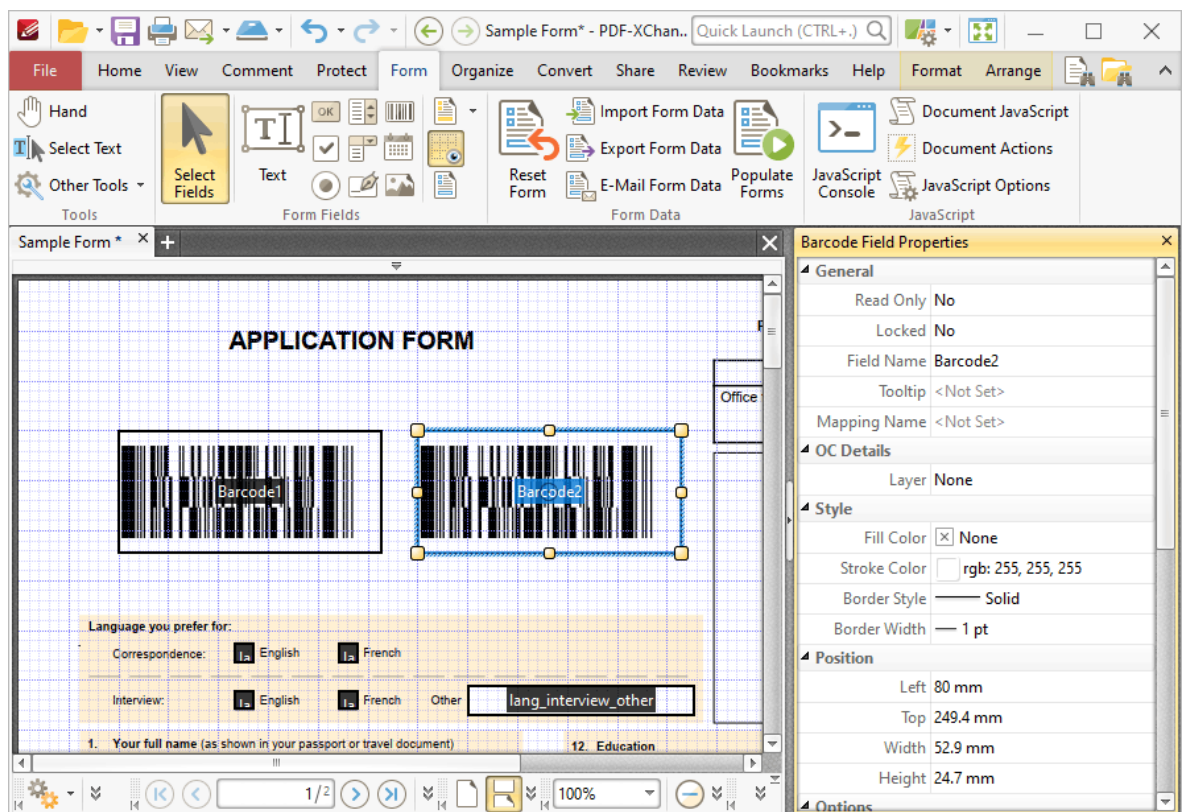

Figure 5. Barcode Tool, Barcode Field Properties Pane

The options detailed below are available in the **Barcode Field Properties** pane:

The **General** properties determine the general parameters of barcodes:

- **Read Only** determines whether or not the barcode can be edited.
- **Locked** determines whether or not the barcode can be moved, and whether or not its properties can be modified.
- **Field Name** determines the name of the barcode. This name is present when the **Edit Form** tool is selected, and when barcodes are listed in the **Fields pane**.
- **Tooltip** determines the information displayed when the pointer is hovered over the barcode.

- **Mapping Name** determines the mapping name that the barcode uses. This name is used to reference interactive form data when the form is exported, and does so without affecting the appearance of the name in the original document.

The **OC Details** property determines the optional content layer to which the barcode belongs. When a field belongs to an optional content layer, it displays only when the layer is enabled. Use the **Layers** pane to view/create/edit layers, as detailed [here](#).<sup>1024</sup>

The **Style** properties determine stylistic elements of barcodes. They are detailed beneath **(figure 4)**.

The **Position** properties determine the position and dimensions of barcodes:

- **Left** determines the distance of the barcode from the left margin.
- **Top** determines the distance of the barcode from the bottom of the page.
- **Width/Height** determine the width/height of the form field that contains the barcode. (The **X Dimension** property, detailed below, determines the size of the barcode itself).

The **Default Text Format** properties determine the default properties when text is entered into the barcode:

- **Font Size** is always set to **auto** for barcodes. This is because the font size refers to the size of the tick when barcodes are selected, and the tick must be proportionate to the size of the barcode.
- **Text Color** determines the color of the tick when barcodes are selected.

The **Options** properties determine additional options for barcodes:

- **Symbology** determines the format of the barcode, as detailed in **(figure 1)**:
  - **PDF417** is a stacked linear barcode used primarily in transport, identification cards and inventory management.
  - **QR Code** is a matrix barcode that features advanced storage capacity in comparison to older barcodes, and is one of the most common barcodes used worldwide.
  - **Data Matrix** is similar to a **QR Code** barcode. **Data Matrices** hold less information than **QR Codes**, but they are more secure.

Additional barcode options are available, depending on the selected barcode format:

- **Compress Data** converts the content of barcodes into a .zip archive when it is enabled. Please note that this is not recommended for mobile scanners, as they are usually incompatible with .zip files.
- **X Dimension** determines the size of the barcode.
- **ECC Level** (Error Correction Capability) determines the level of compensation when barcodes are damaged, for example when printing imperfections occur. A higher ECC level results in a higher degree of data retention in the event of damage, but also requires more space. Please note that this property is not available for the **Data Matrix** barcode format.

- **Y/X Ratio** sets the ratio of the barcode axes when the **PDF417** barcode format is used.

The **Actions** properties, although displayed in the **Barcode Field Properties** pane, are not compatible with barcodes and should be ignored.

The **Value Calculation** properties determine the physical appearance of the barcode:

- **Calculation Type** determines the type of calculation used to create the barcode:
  - **Custom Script** enables the use of custom JavaScript in order to create the barcode:
    - **Calculation Script** is used to enter custom JavaScript. Click the ellipsis icon to add JavaScript. The **Edit Action: "Run a JavaScript"** dialog box will open. Enter the desired JavaScript for the action and then click **OK**:

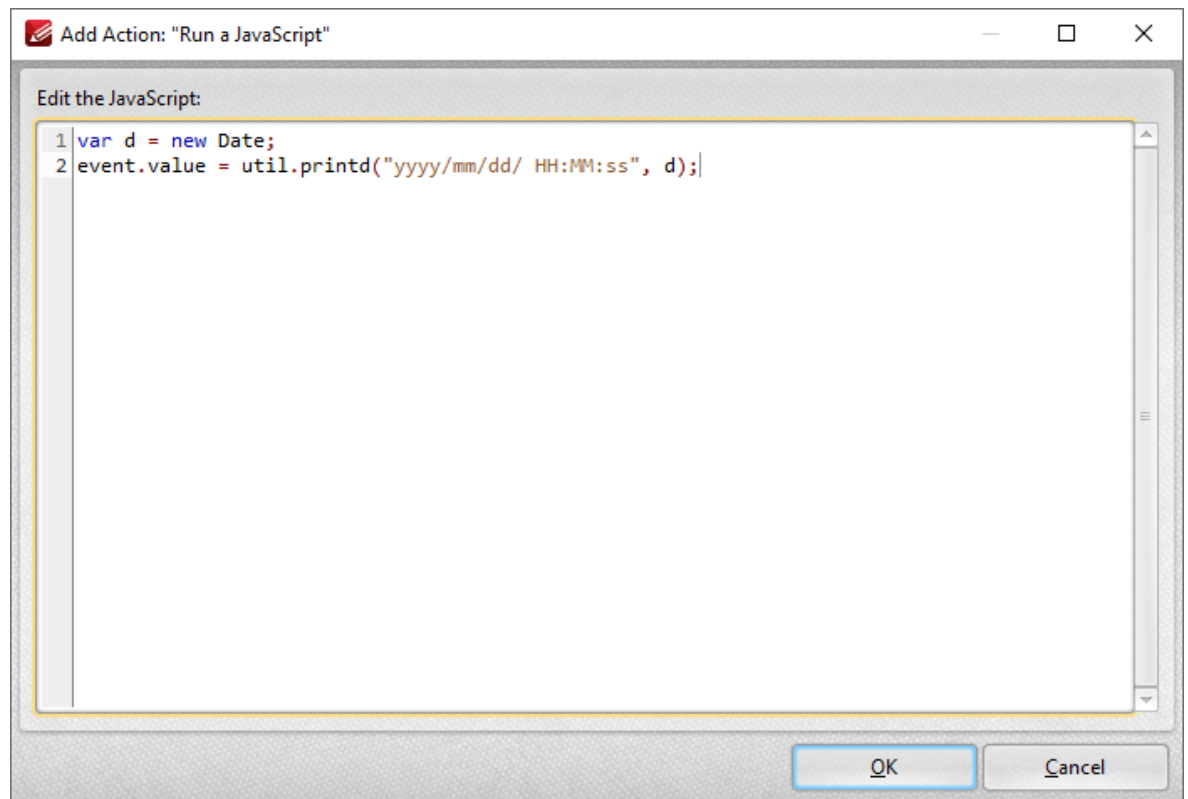
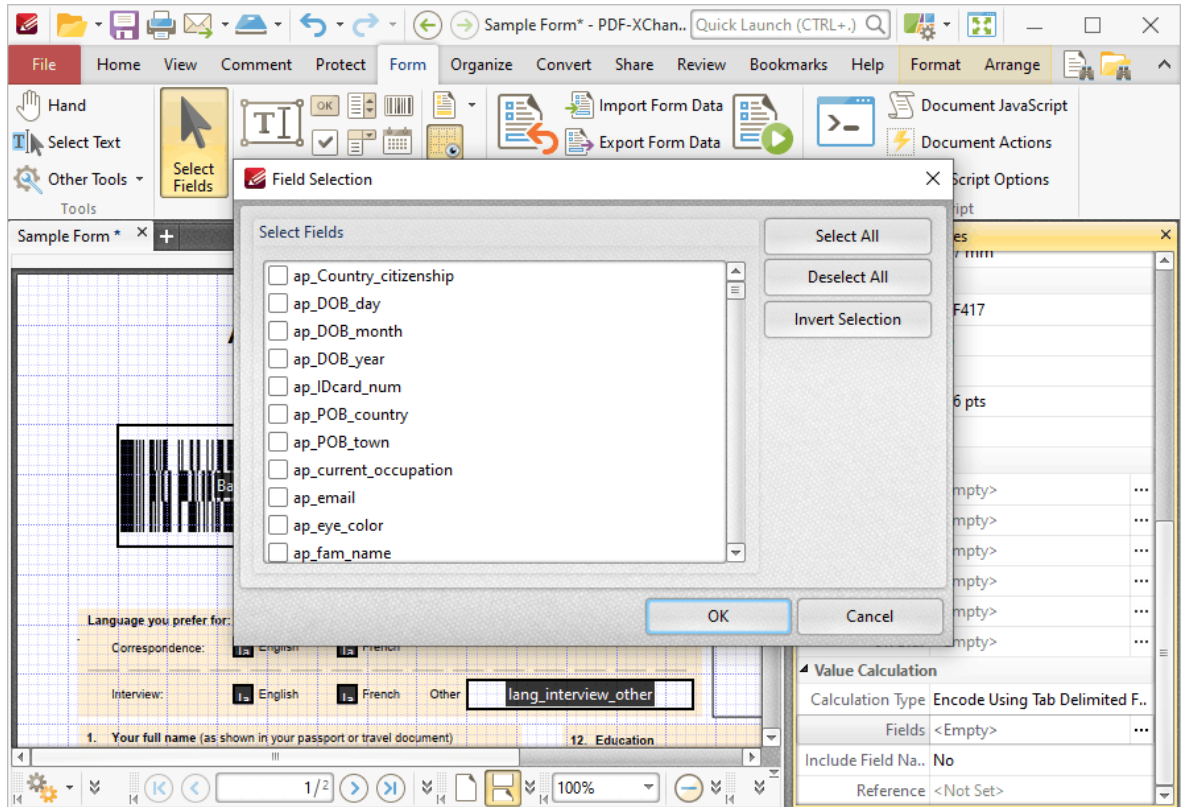

Figure 6. Edit Action: "Run a JavaScript" Dialog Box

- **Reference** is an optional property that has several uses, such as to reference the URL of the published form or other relevant information. Values entered in this property will appear beneath the barcode.
- **Encode Using Tab Delimited Format** encodes fields into the barcode as tab-delimited values. Please note that if the form is configured to output the data in individual **XPDF** or **XDP** files, then this format must be used. Additionally, this

format enables the inclusion of the most data and is the best choice in cases where the form data will be copied into a database/spreadsheet.

- **Fields** is used to determine the fields that create the content of the barcode. This property becomes available when the **Encode Using Tab Delimited Format** option is selected, as detailed in **(figure 7)**. Click the ellipsis icon (three dots) to open the **Field Selection** dialog box, then select the fields to include for the barcode and click **OK**:



**Figure 7.** Encode Using Tab Delimited Format, Fields Property Highlighted and Field Selection Dialog Box

- **Include Field Name** determines whether or not the field name is included in the data of the barcode. Please note that if the form is configured to output the data in individual **XPDF** or **XDP** files then the data must be in a tab-delimited format and the field names must be in the first line.
- **Reference** is an optional property that has several uses, such as to reference the URL of the published form or other relevant information. Values entered in this property will appear beneath the barcode.
- **Encode Using XML Format** encodes fields into the barcode in standard **XPDF** format.
  - **Fields** is used to determine the fields that create the content of the barcode. This property becomes available when the **Encode Using XML Format** option is selected, as detailed in **(figure 8)**. Click the ellipsis icon

to open the **Field Selection** dialog box, then select the fields to include for the barcode and click **OK**:

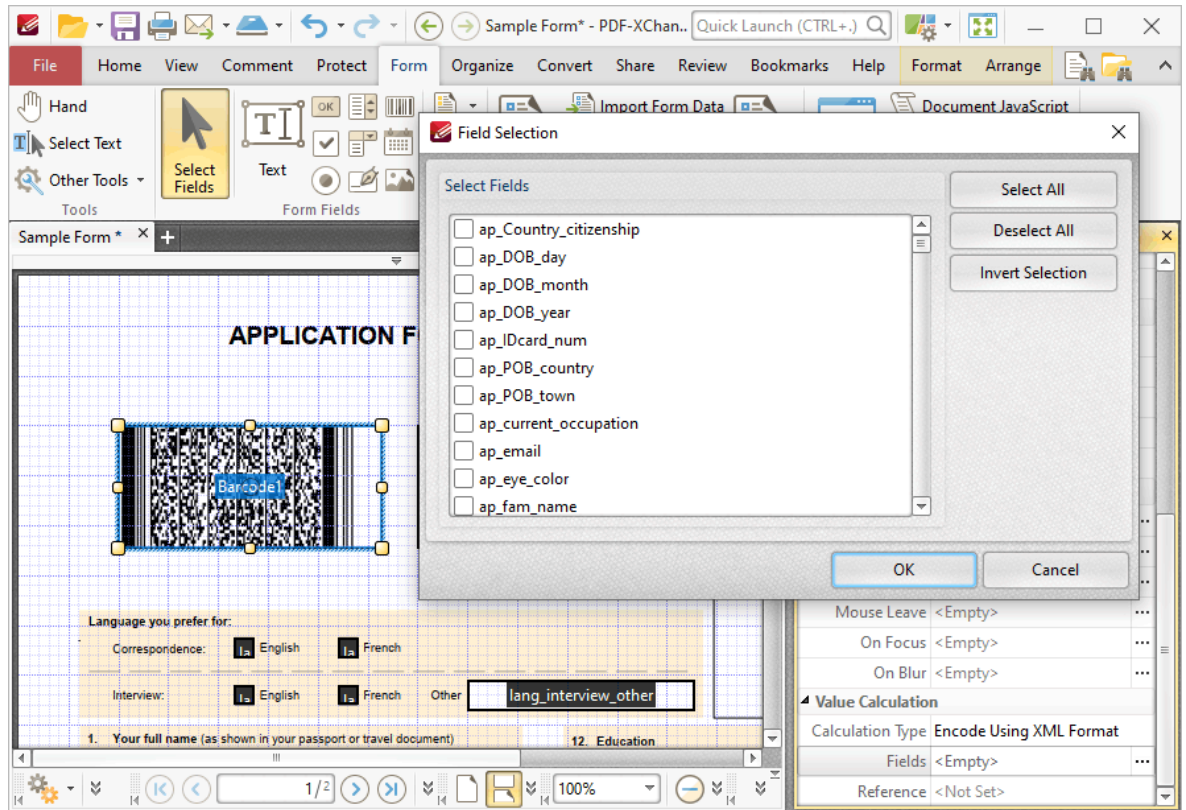

Figure 8. Encode Using XML Format, Fields Property Highlighted and Field Selection Dialog Box

- **Reference** is an optional property that has several uses, such as to reference the URL of the published form or other relevant information. Values entered for this property will appear beneath the barcode.

▼ **Barcode Creation Example**

The following example will detail the creation of a barcode that represents numerical form data entered elsewhere in the same form:

1. Click the **Form tab**, then click **Barcode**. The blue rectangle that represents the barcode will be displayed:



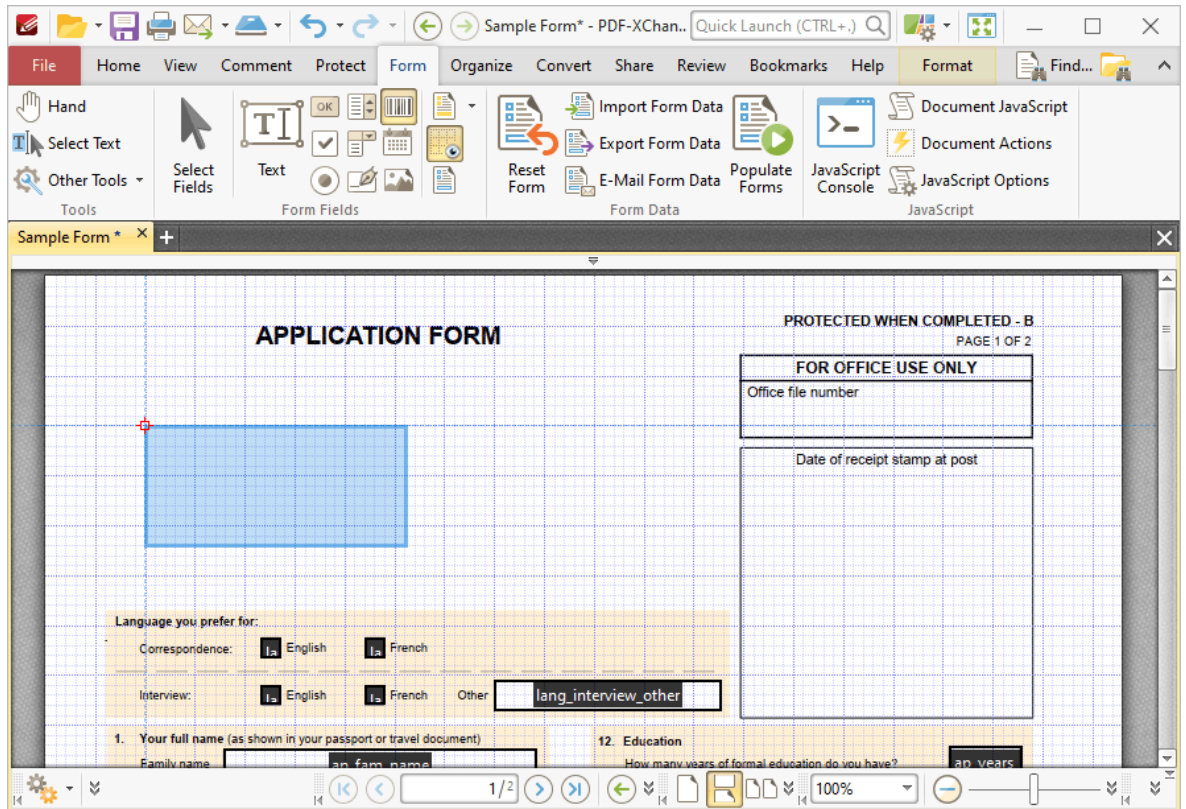

Figure 9. Active Barcode Tool

2. Click to add the barcode, then click the **Format** tab and click **Properties**. The **Barcode Field Properties** pane will open:

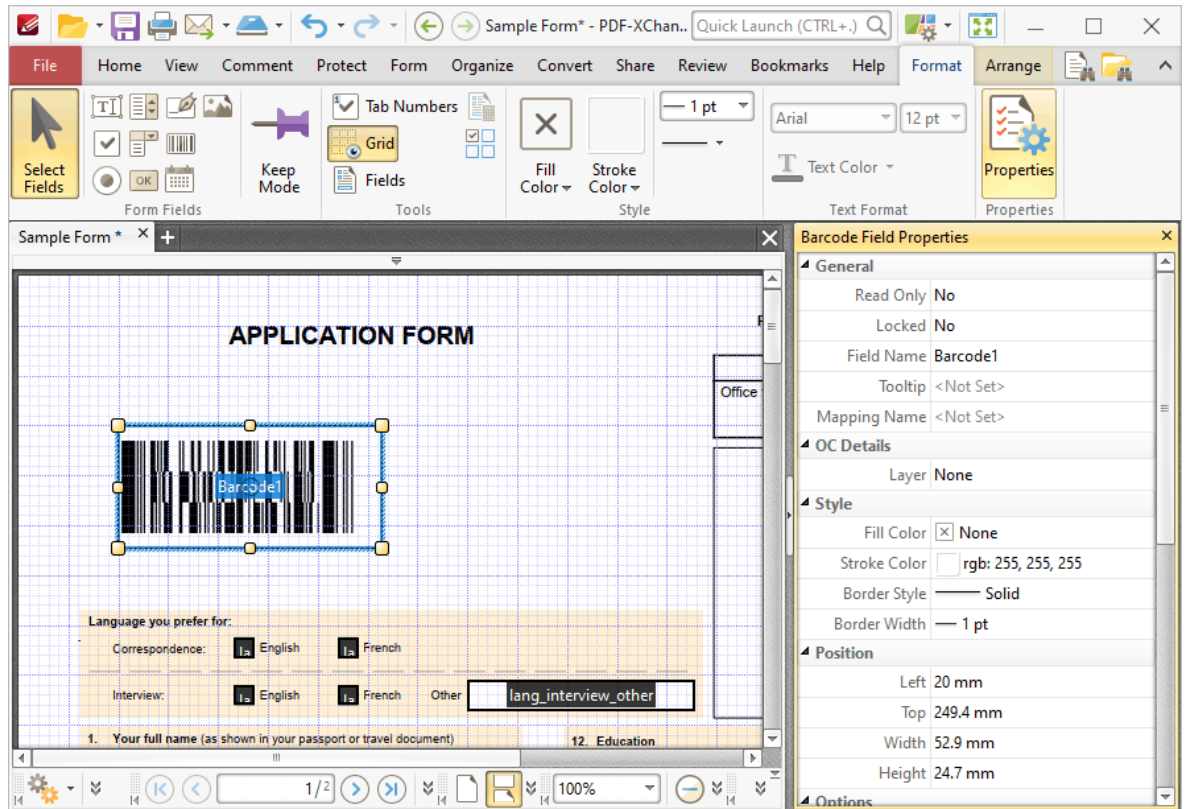

Figure 10. Active Barcode Tool, Barcode Field Properties Pane

3. Scroll down the **Barcode Field Properties** pane to the **Calculation Type** property, then select **Encode Using Tab Delimited Format**:

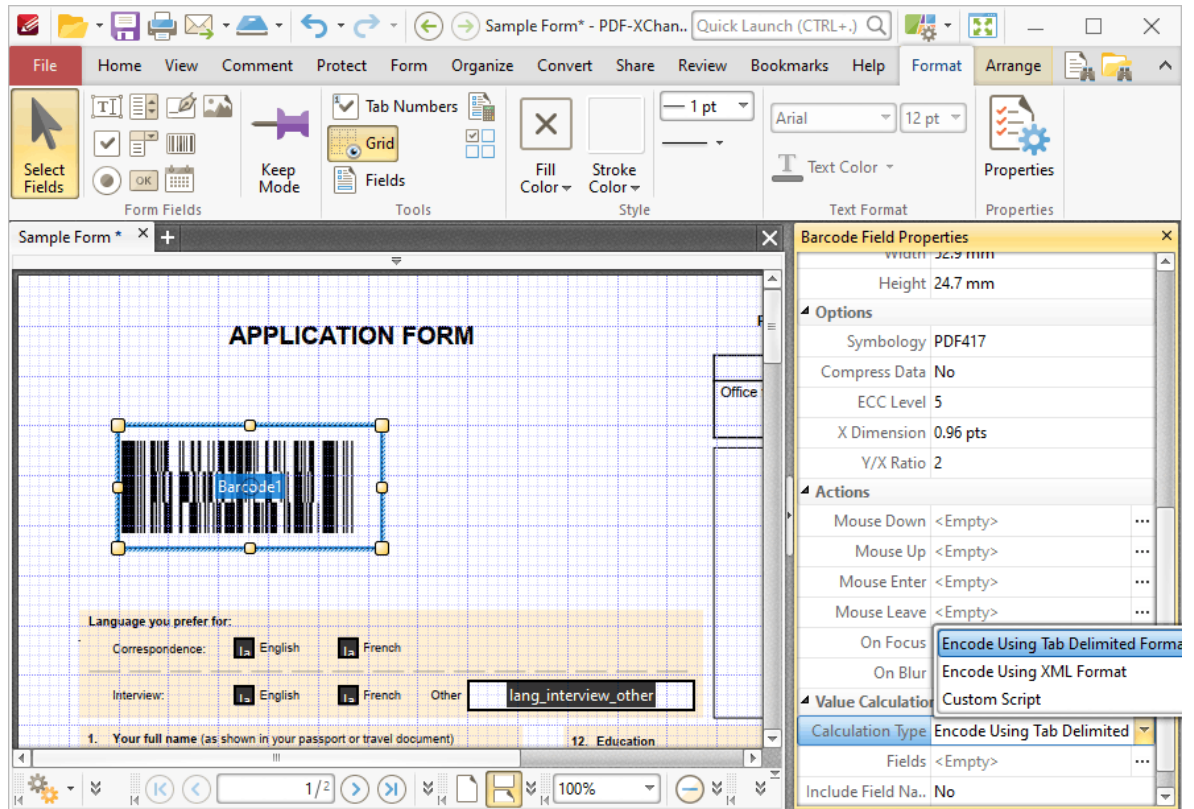

Figure 11. Calculation Type Property, Encode Using Tab Delimited Format

The next step is to create the form fields from which the barcode will take its data:

4. Click **Text Field** and **Keep Mode**, then click to add some text fields to the document:

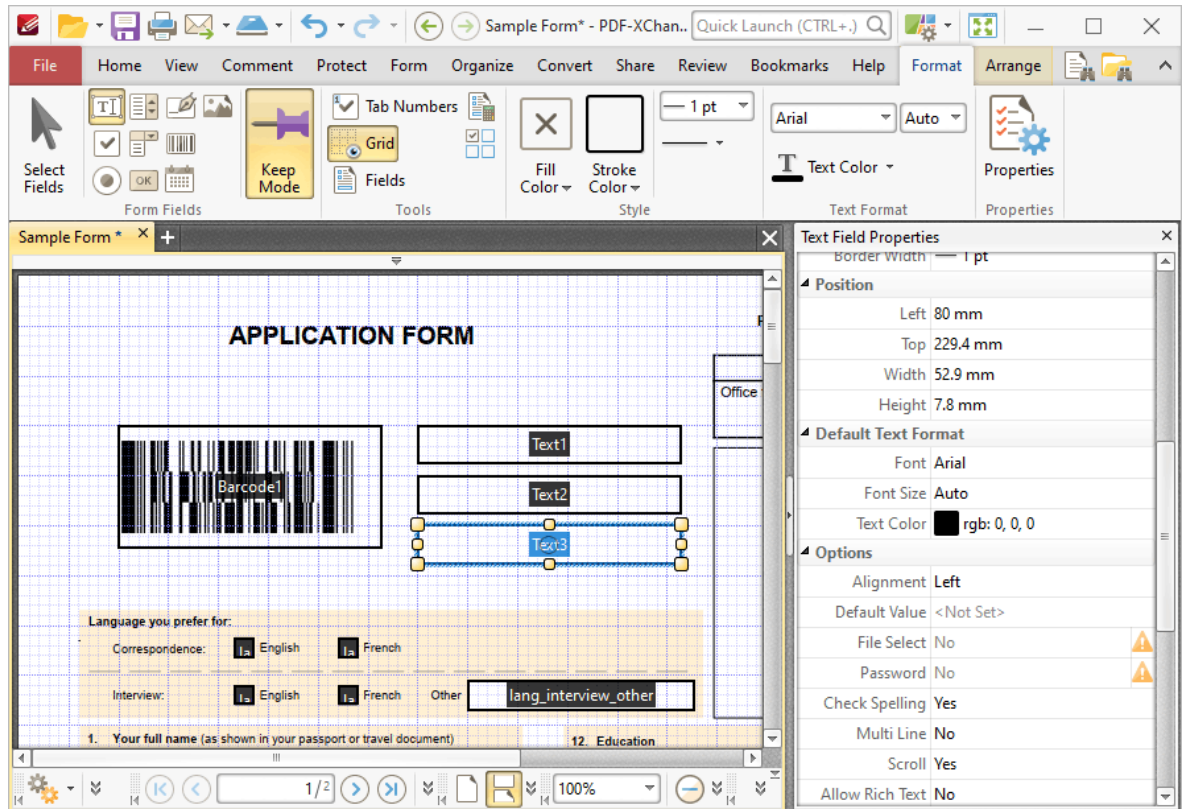

Figure 12. New Text Boxes

5. Click the **Home** tab, then click the **Hand Tool**. Select the text fields one at a time and enter some numerical data:

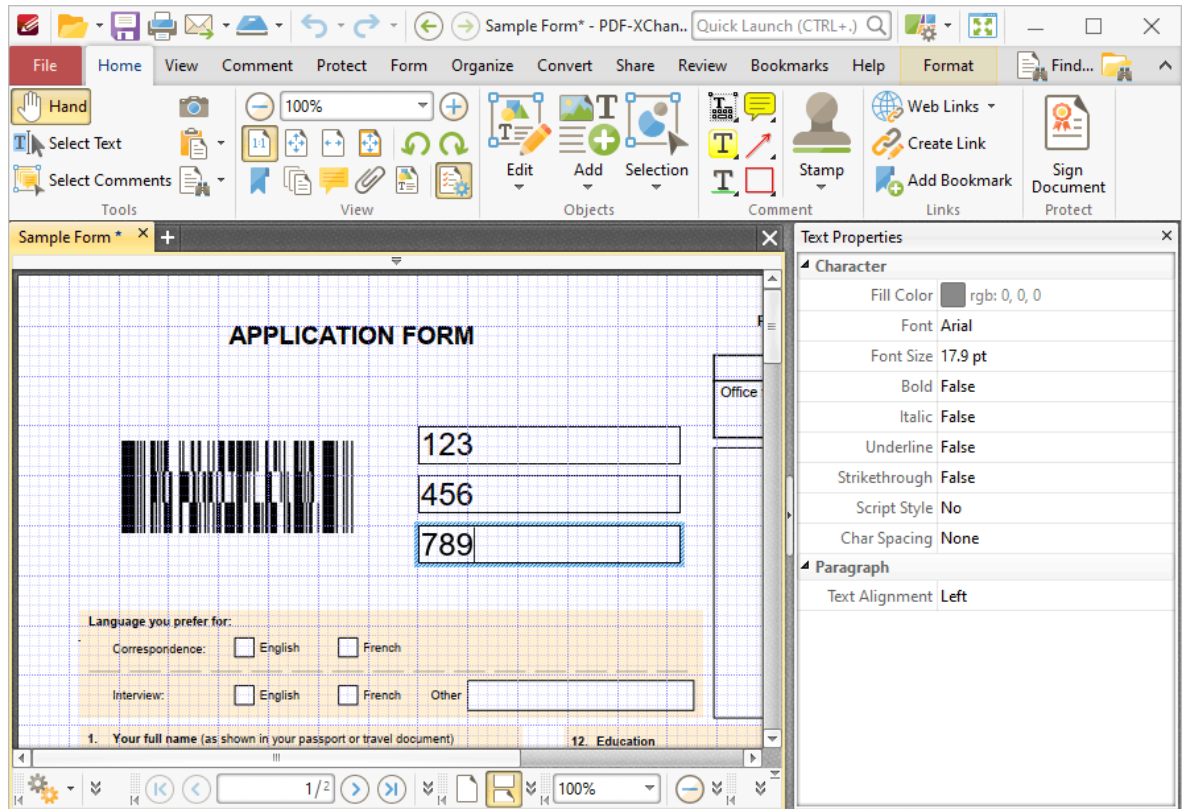

Figure 13. Active Hand Tool

6. Click the **Form tab**, then click **Select Fields** and select the barcode:

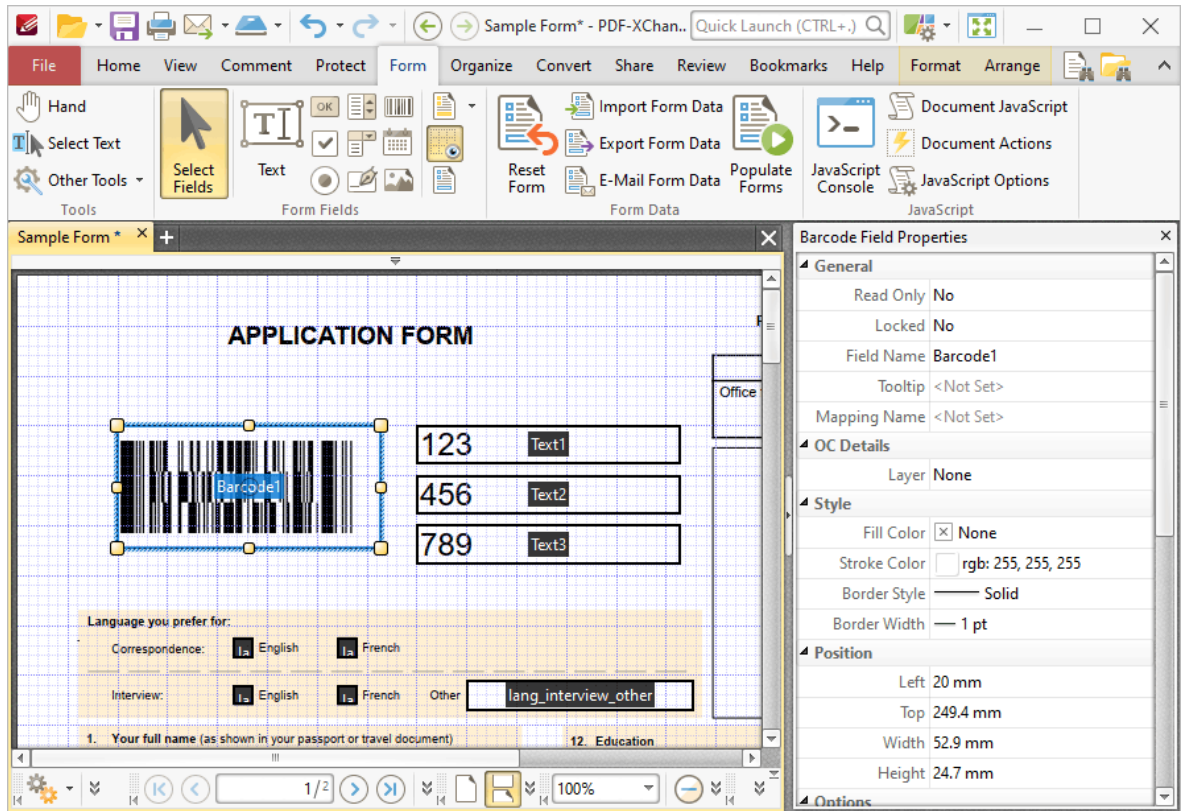

Figure 14. Selected Barcode

7. Scroll down the **Barcode Field Properties** pane to the **Fields** property and click the ellipsis icon (three dots). The **Field Selection** dialog box will open. Note that the text fields entered at step four each feature a corresponding check box. Select the boxes of the forms to be included in the creation of the barcode and click **OK**:

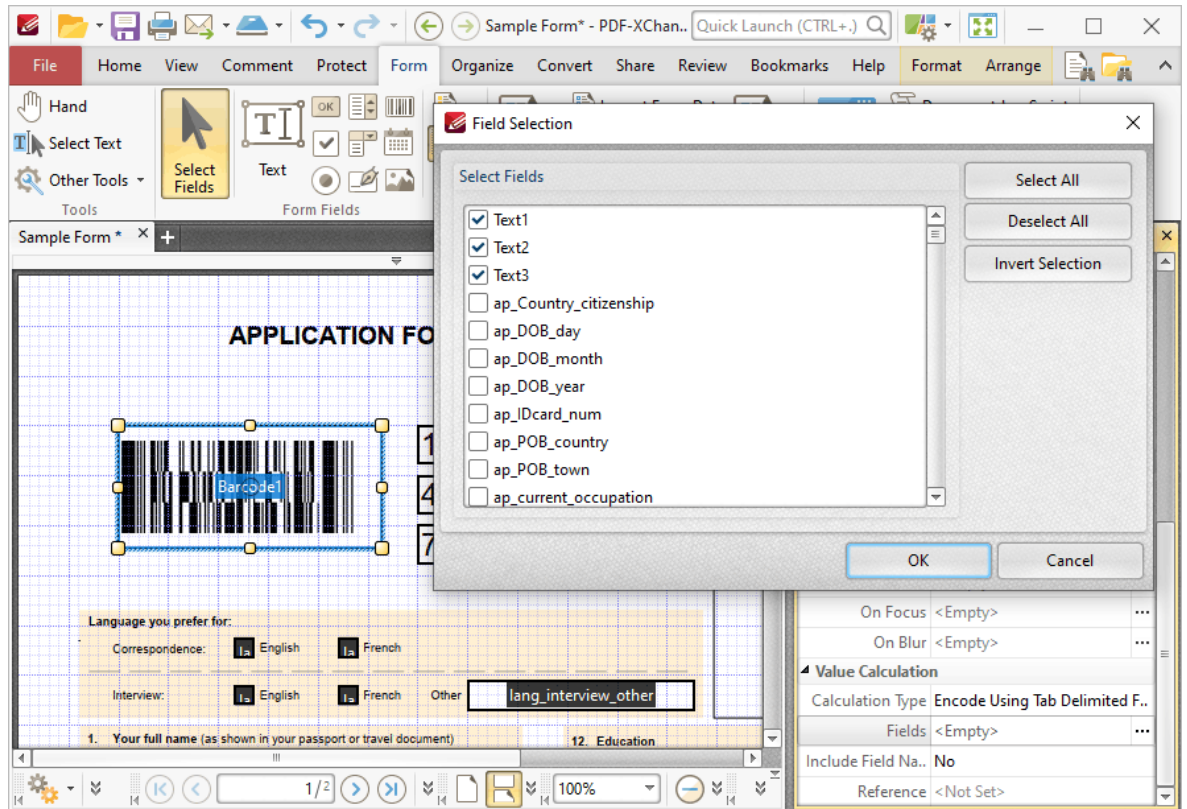

Figure 15. Selected Barcode and Field Selection Dialog Box

The barcode will update to represent the numerical information:

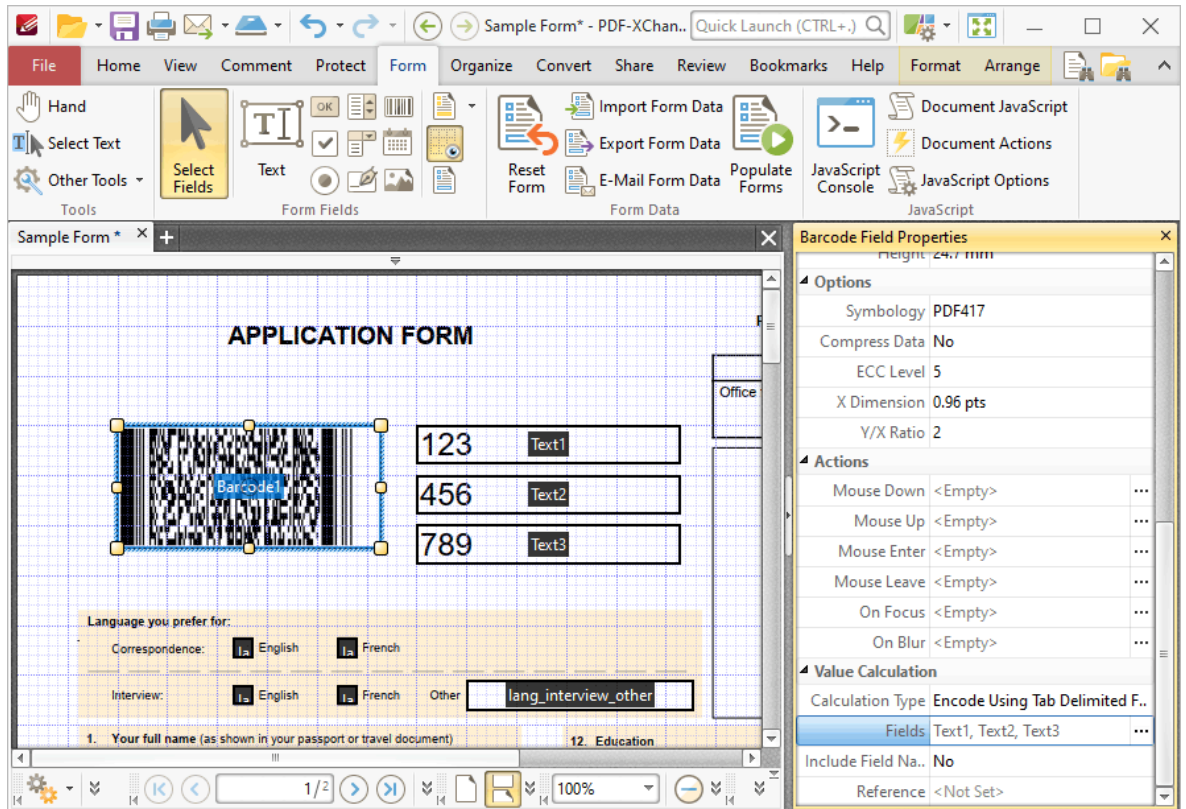

Figure 16. Updated Barcode

If the content of the text fields used to create the barcode is updated then the barcode will update to represent the new information.



10.4.6.9 Add Date Fields to Documents



Add Date Fields to Documents

Date fields are used to add an interactive calendar to documents in order to specify dates:

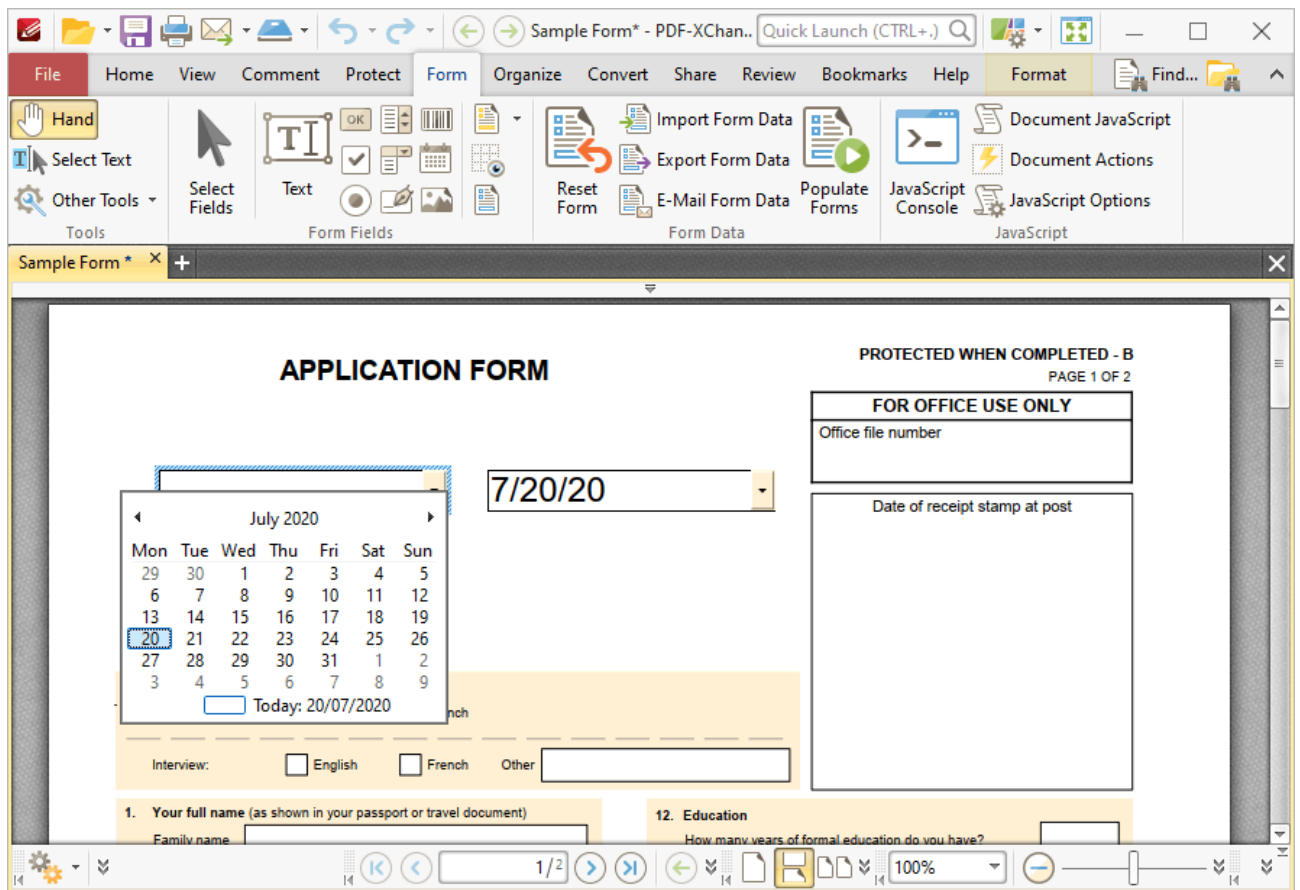

Figure 1. Example Date Fields

Please note that date fields are a modified version of the text fields detailed [here](#).<sup>1270</sup> The only difference is that the **Category** property in the **Format Value** tab of the **Properties** pane is set to **Date** by default for convenience of use. This means that some properties and functions available by default for text fields are disabled by default for date fields. These can be edited using the **Properties** pane detailed below.

The functionality of **PDF-XChange Editor** enables a wide range of dynamic customization for date fields. Click the dropdowns below for further information:

▼ **Add Date Fields to Documents**

1. Click the **Form Tab**, then click the **Date** icon. A blue rectangle will be displayed beneath the pointer. This rectangle represents the date field:

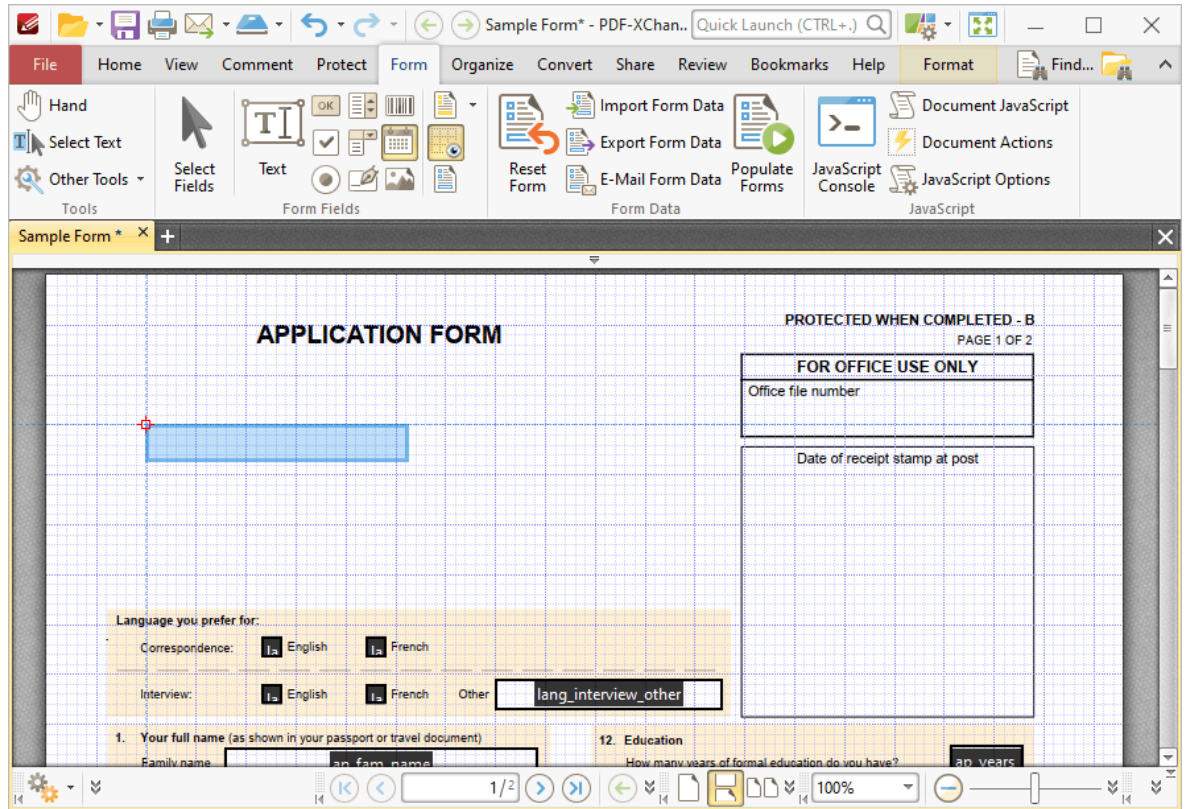

**Figure 2.** Active Date Field Tool

2. Move the rectangle to the desired location and then click to add the date field to the document. Added date fields appear as detailed below:

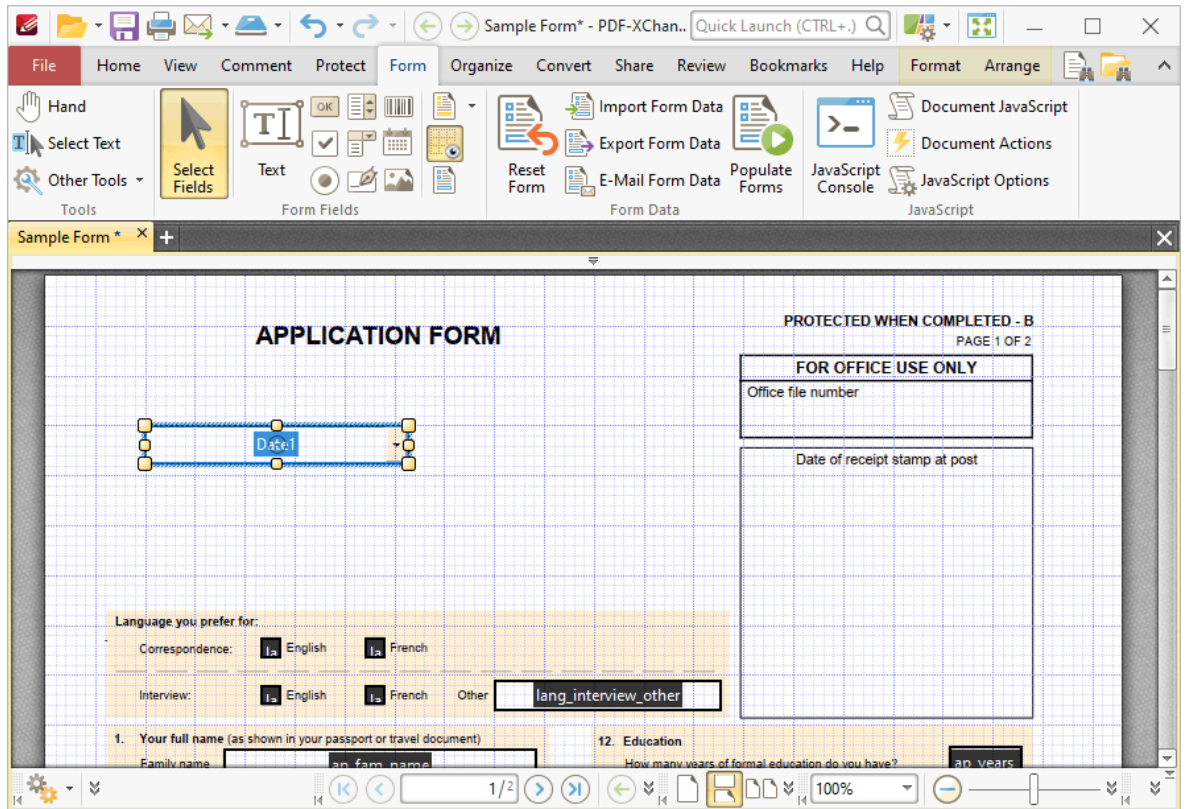

Figure 3. Added Date Field

- Click and drag the yellow control points to resize date fields.
- Use the options in the **Format Tab** to determine the style and appearance of selected date fields:

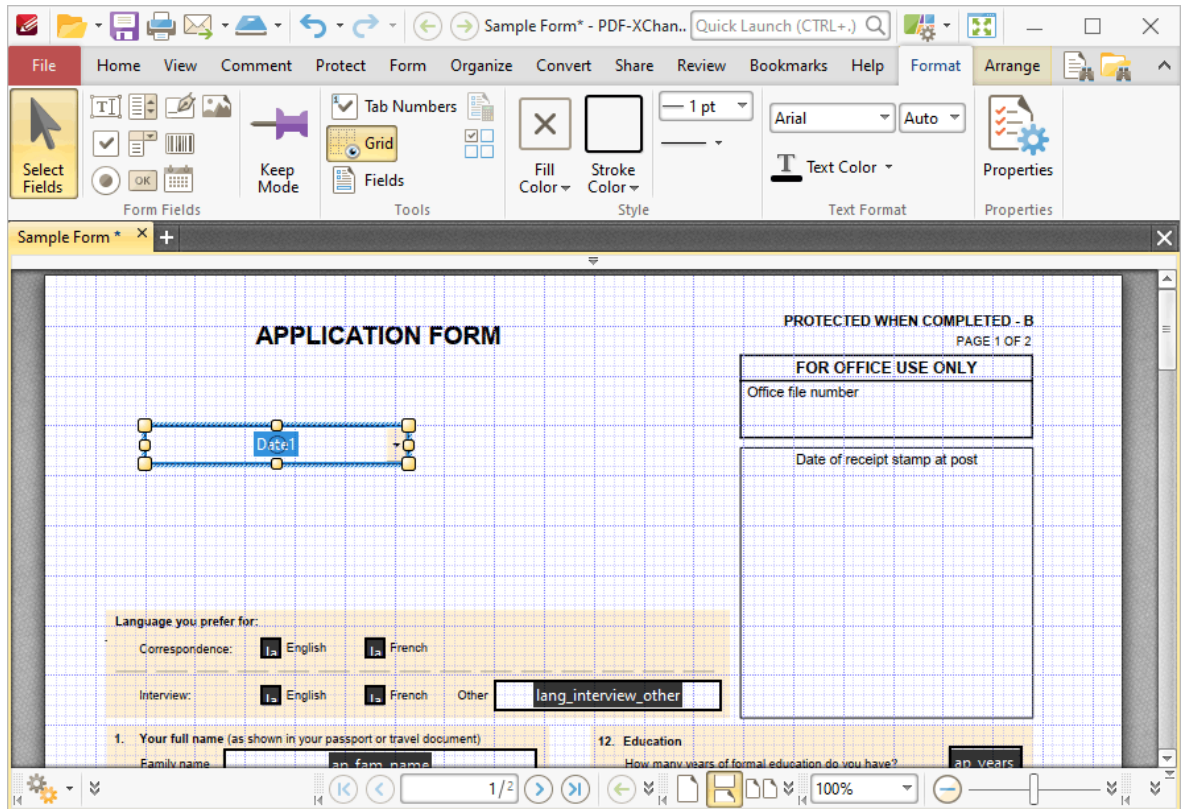

Figure 4. Format Tab, Date Field Forms

- Click **Select Fields** to select and edit form fields.
- Click the options in the **Form Fields** group to enable alternative form field formats.
- Click **Keep Mode** to create multiple date fields consecutively. If this option is disabled then **PDF-XChange Editor** will revert to the designated default tool after the creation of a single date field.
- Click **Tab Numbers** to show/hide the tab order numbers of form fields.
- Click **Calculation Order** to show/hide the order in which calculations are performed when there is more than one form field that contains a value calculation. Further information about value calculations is detailed below.
- Click **Grid** to enable/disable the grid, which is used to assist in the accurate placement of form fields, as detailed in **(figure 4)**.
- Click **Create Multiple Copies** to create multiple copies of selected form fields, as detailed [here](#).<sup>1437</sup>
- Click **Fields** to show/hide the **Fields**<sup>1016</sup> pane, which is used to view/edit form fields.
- Click **Fill Color** to determine the fill color of the date field.
- Click **Stroke Color** to determine the border color of date fields.
- Click **Width** to determine the width of date field borders.
- Click **Border** to determine the style of date field borders.
- Click the options in the **Text Format** group to format the text of date fields.

- Click **Properties** to open the **Text Field Properties** pane, which enables the customization of additional elements of date fields and is detailed in the section below.

### ▼ The Text Field Properties Pane

The **Text Field Properties** pane can be used to determine a range of style and functionality options for date fields. For example, it is possible to use the **Actions** properties to add multiple dynamic actions to date fields, such as running JavaScript, launching web links and opening files on the local computer. (JavaScript is a high-level programming language that can be used to perform custom operations. See [here](#) for an index of existing JavaScript operations that the **PDF-XChange Editor** forms can use, as well as additional information about JavaScript).

Click **Select Fields** to select form fields, then click the desired field and click **Properties** in the **Format** tab to open the **Text Field Properties** pane:

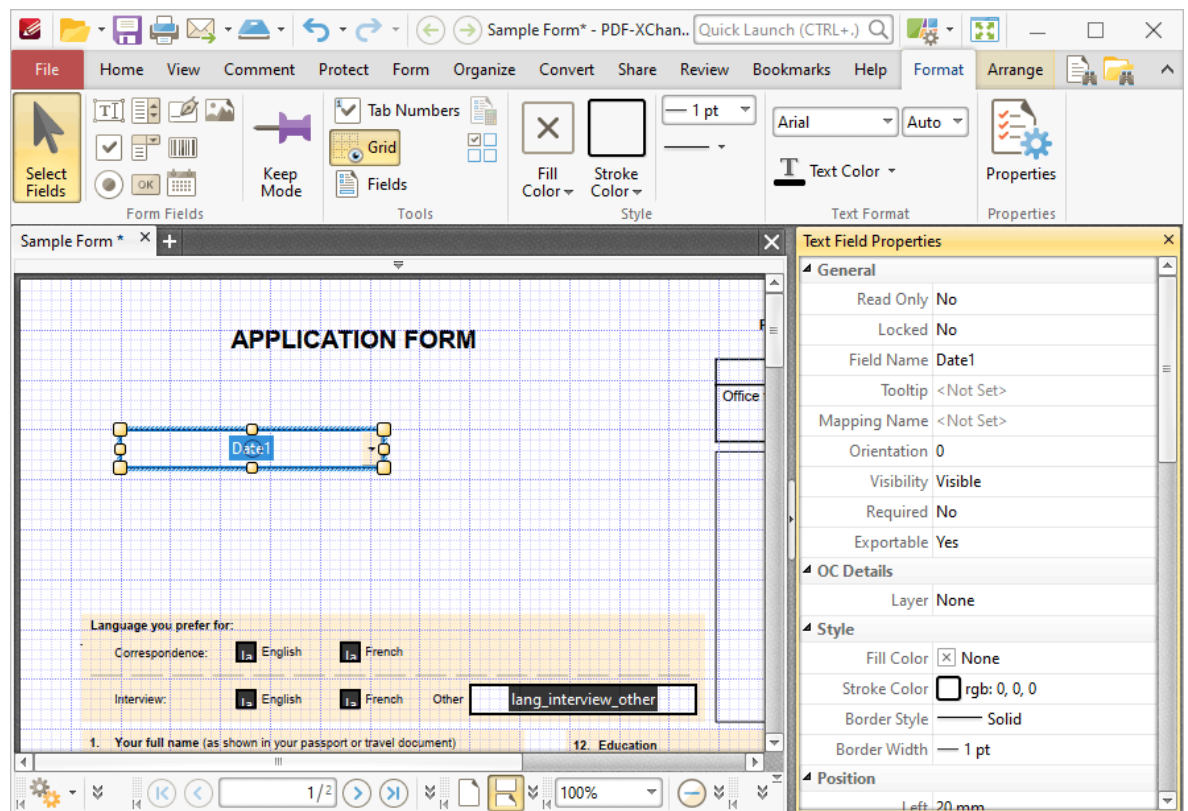

Figure 5. Date Field Tool, Text Field Properties Pane

The options detailed below are available in the **Text Field Properties** pane:

The **General** properties determine the general parameters of date fields:

- **Read Only** determines whether or not the date field can be edited.

- **Locked** determines whether or not the date field can be moved, and whether or not its properties can be modified.
- **Field Name** determines the name of the date field. This name is present when the **Select Fields** tool is enabled, and when date fields are listed in the **Fields pane**.<sup>1016</sup>
- **Tooltip** determines the information displayed when the pointer is hovered over the date field.
- **Mapping Name** determines the mapping name that the date field uses. This name is used to reference interactive form data when the form is exported, and does so without affecting the appearance of the name in the original document.
- **Orientation** determines the orientation of text entered in the date field.
- **Visibility** determines the visibility of the date field.
- **Required** determines whether or not the date field is a required field. Required fields must be filled before documents that contain them can be submitted.
- **Exportable** determines whether or not the date field data can be exported from the form.

The **OC Details** property determines the optional content layer to which the date field belongs. When a field belongs to an optional content layer, it displays only when the layer is enabled. Use the **Layers** pane to view/create/edit layers, as detailed [here](#).<sup>1024</sup>

The **Style** properties determine stylistic elements of date fields. They are detailed beneath *(figure 4)*.

The **Position** properties determine the position and dimensions of date fields:

- **Left** determines the distance of the date field from the left margin.
- **Top** determines the distance of the date field from the bottom of the page.
- **Width/Height** determine the width/height of the date field.

The **Default Text Format** properties determine the default properties when text is entered into the date field:

- **Font** determines the font used.
- **Font Size** determines the size of the font.
- **Text Color** determines the color of the font.

The **Options** properties determine additional options for date fields:

- **Alignment** determines the text alignment within the date field.
- **Default Value** determines the default value of the date field. Date fields will show this value by default. If they are edited and then reset then the value entered for this property will be displayed.
- **File Select** determines whether or not files on the local computer are selected when their filename is entered in the date field. If set to **Yes** then the file contents are submitted as the value of the date field when the form is submitted.
- The **Password** property is not applicable to date fields.

- The **Check Spelling** property is not applicable to date fields.
- The **Multi Line** property is not applicable to date fields.
- The **Scroll** property is not applicable to date fields.
- **Allow Rich Text** determines whether or not the date field permits rich text such as bold and italics.
- The **Comb** property is not applicable to date fields.
- **Character Limit** determines the maximum number of characters permitted in the date field.

The **Actions** properties determine the action taken when users interact with the date field:

- **Mouse Down** initiates an action when the left mouse button is pressed (without being released) on the date field.
- **Mouse Up** initiates an action when the left mouse button is clicked (pressed and released) on the date field.
- **Mouse Enter** initiates an action when the pointer moves into the date field.
- **Mouse Leave** initiates an action when the pointer moves out of the date field.
- **On Focus** initiates an action when the date field is selected.
- **On Blur** initiates an action when the date field is deselected.
- Click the ellipsis icon on the right of actions to add/edit date field actions:

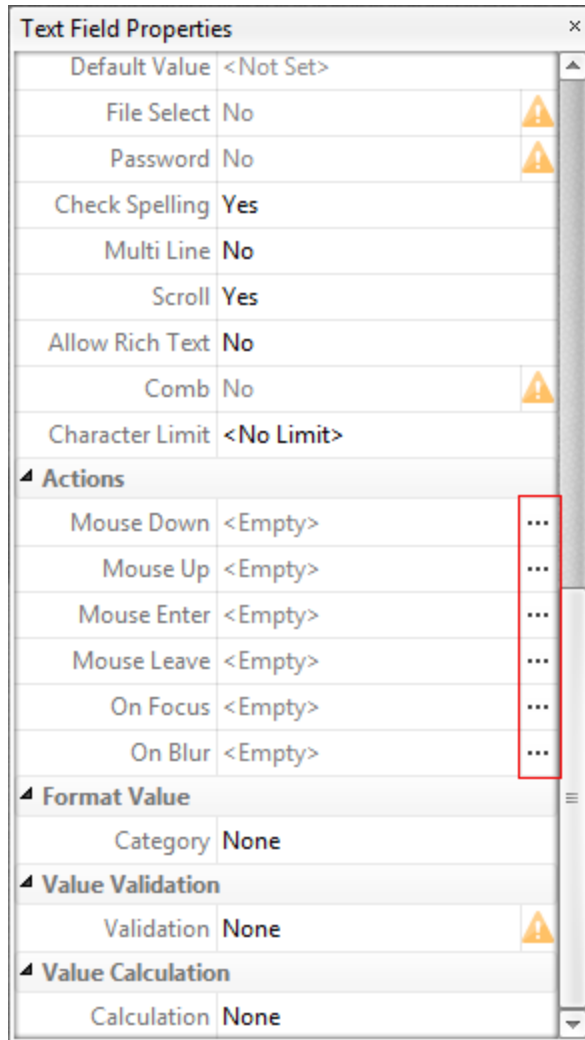

Figure 7. Date Field Properties Pane, Action Ellipses

The process of adding actions is detailed [here](#).<sup>959</sup>

The **Format Value** properties determine the type of information permitted to be entered in the date field and the format in which it should be entered. Date fields are set to **Date** by default.

- **Category** determines the category of the field. Each category has different options, as detailed below:
  - **None** determines that there is no category for the field.
  - **Number** sets the field input to numerical values. The following options are available for this property:
    - **Decimal Places** determines the number of decimal places displayed.
    - **Separator Style** determines the separators used for numbers.
    - **Currency Symbol** determines the currency symbol used in the date field.
    - **Symbol Location** determines the location of the currency symbol in relation to the number.



- **Add Space** inserts a space between the currency symbol and the number.
- **Negative Number Style** determines how numbers with negative values are displayed.
- **Percentage** sets the field input to percentage values. The following options are available for this property:
  - **Decimal Places** determines the number of decimal places permitted.
  - **Separator Style** determines the separator used for numbers.
- **Date** is the default setting and sets the field input to date values, then adds a dropdown calendar to the date field. Use the **Date Format** parameter to determine the format of dates.
- **Time** sets the field input to time values (hours and minutes). Use the **Time Format** parameters to determine the format of time values.
- **Special** sets the field input values to one of the special options. Use the **Special Format** parameter to determine the format. The options are:
  - **ZIP Code**
  - **ZIP Code +4**, which is used for nine-digit postal codes.
  - **Phone Number**
  - **Social Security Number**
- **Custom Action** adds custom JavaScript actions to date fields. There are two options:
  - **Format Action** is used to enable custom JavaScript for formats. Click the ellipsis icon to add/view JavaScript.
  - **Keystroke Action** is used to enable custom JavaScript for keystrokes. Click the ellipsis icon to add/view JavaScript.
  - If the options above are used then the **Edit Action: "Run a JavaScript"** dialog box will open. Enter the desired JavaScript for the action and then click **OK**:

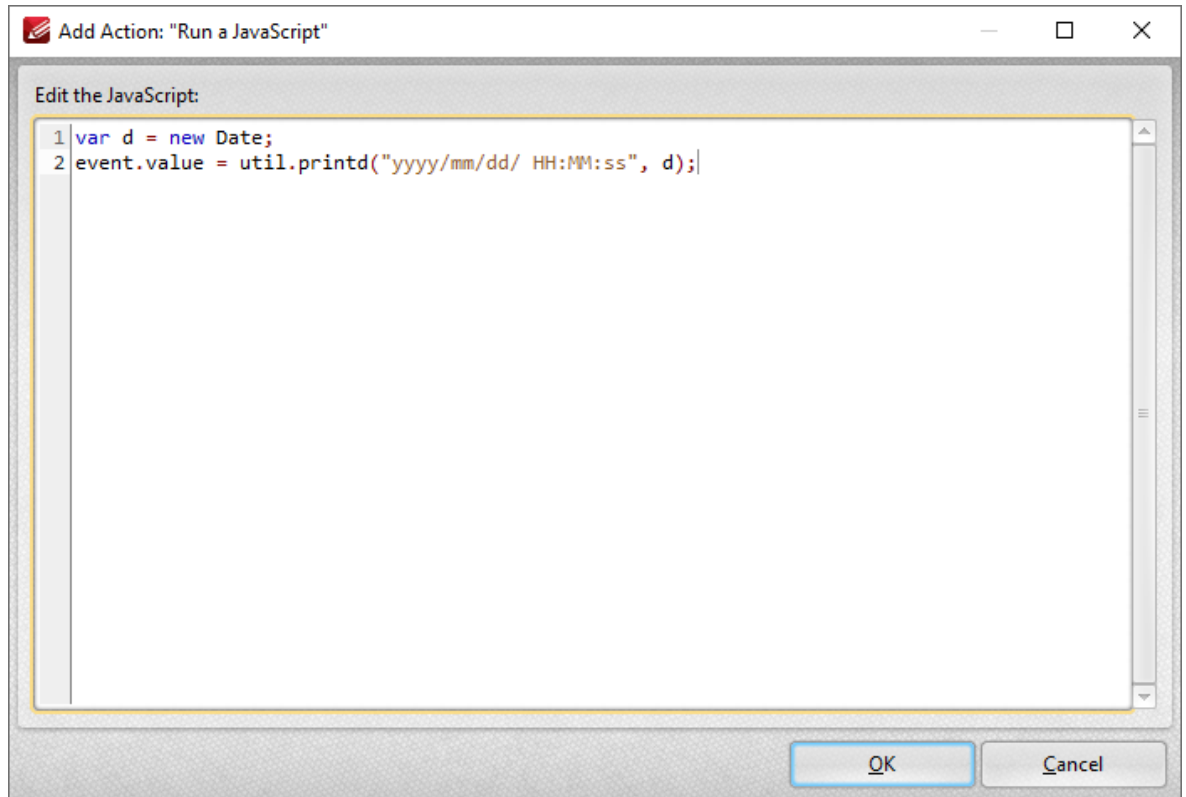

Figure 8. Edit Action: "Run a JavaScript" Dialog Box

The **Value Validation** properties determine the validation of values entered into the date field. These properties can be used to ensure that the information entered into forms fits within specific parameters:

- **Validation** determines how values are validated:
  - **Value in Range** sets the range within which values entered into the date field must fall:
    - **From** specifies the minimum value.
    - **To** specifies the maximum value.
  - **Custom Action** enables the use of custom JavaScript in order to validate values entered in the date field:
    - **Validation Action** specifies the JavaScript to use, as detailed in **(figure 9)**.

The **Value Calculation** properties determine the value of date fields from other date fields, and are used in forms where entered form data creates the value of further forms, such as when several orders are placed that combine to give a total cost. The available properties are detailed below:

- **None** specifies that calculations are not performed.
- **Sum** uses the sum of specified fields.
- **Product** uses the product of specified fields.
- **Average** uses the average of specified fields.
- **Minimum** uses the minimum value of all the specified fields.

- **Maximum** uses the maximum value of all specified fields.
- Please note that when the **Sum, Product, Average, Minimum** and **Maximum** properties are used, the additional entry "**Fields**" will appear beneath the **Calculation** property. Use this entry to specify the fields used in these calculations.
- **Simplified Notation** enables the insertion of a custom calculation to be performed on fields. Use the **Simple Notation** box to determine the calculation. Use the document field names and standard mathematical notation (+, -, \*, /) to specify the calculation. If there are spaces in form field names then they must be entered in quotation marks. For example: **Field1 + Field 2 / "Division Field" \* 64.**
- **Custom Action** enables the use of custom JavaScript in order to perform calculations and determine the order in which calculations are performed. Click the ellipsis icon to add custom JavaScript, as detailed in *(figure 9)*.

Examples of **Value Validation** and **Value Calculation** are available [here](#). 

---

10.4.6.10 Add Image Fields to Documents



Add Image Fields to Documents

Image fields are used to add form fields that enable the submission of images as form data:

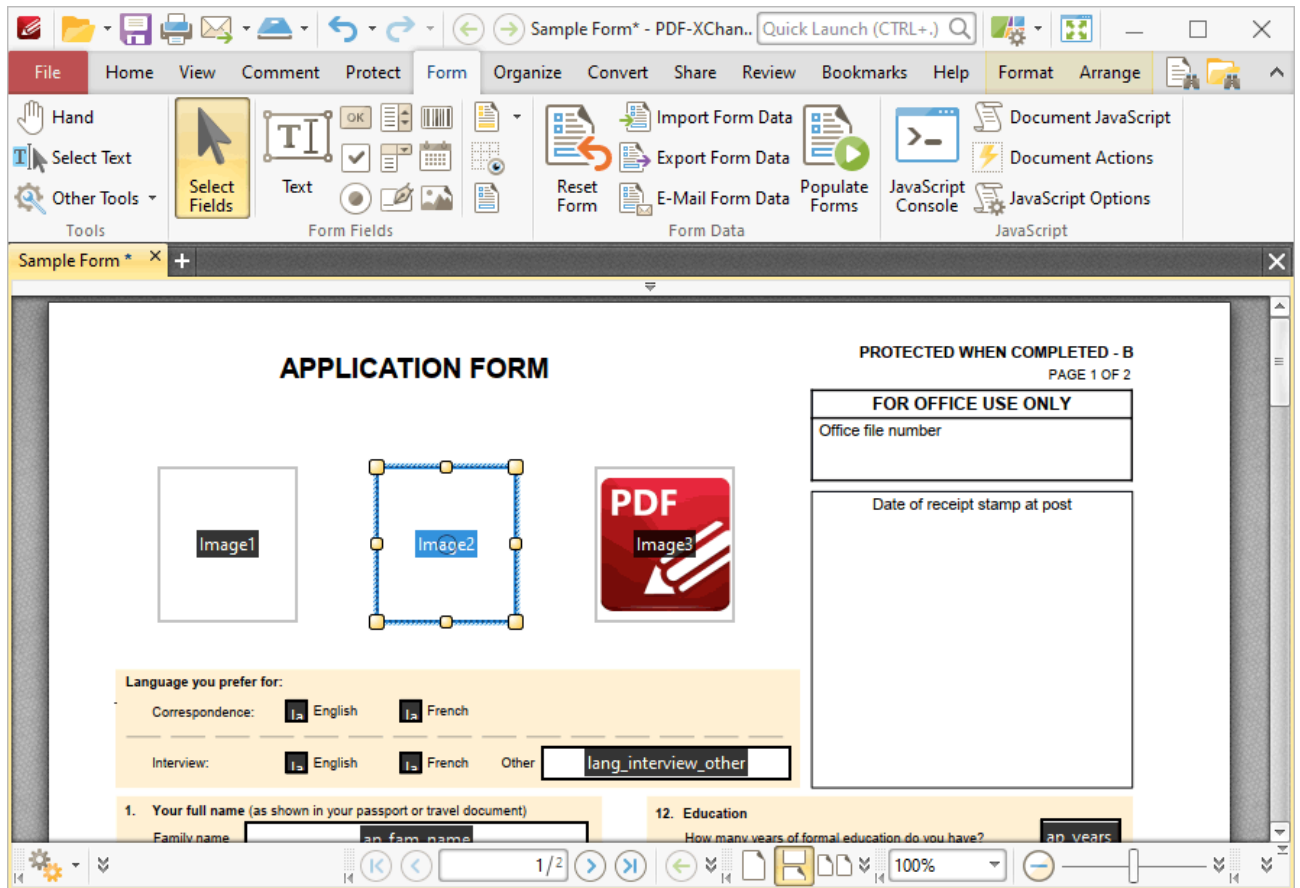

Figure 1. Example Image Fields. Image Added (left), Empty Field (center), Selected Empty Field (right)

Please note that image fields are a modified version of the button fields detailed [here](#).<sup>1356</sup> The only difference is that the **Layout** property in the **Options** tab of the **Properties** pane is set to **Icon Only** by default for convenience of use. All properties can be edited using the **Properties** pane detailed below.

The functionality of **PDF-XChange Editor** enables a wide range of dynamic customization for image fields. Click the dropdowns below for further information:

▼ **Add Image Fields to Documents**

1. Click the **Form** tab, then click **Image**. A blue rectangle will be displayed at the location of the pointer. This rectangle represents the image field:

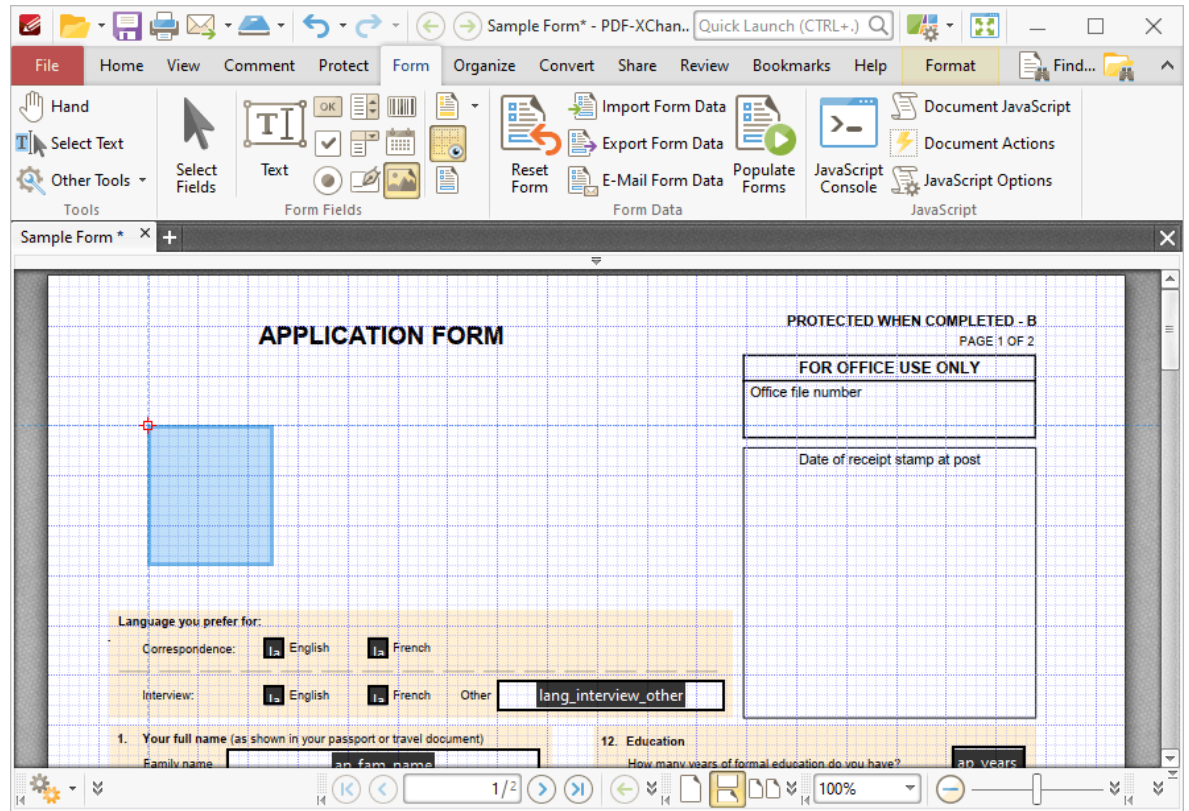

**Figure 2.** Active Image Field Tool

2. Move the rectangle to the desired location and then click to add the image field to the document. Added image fields appear as detailed below:

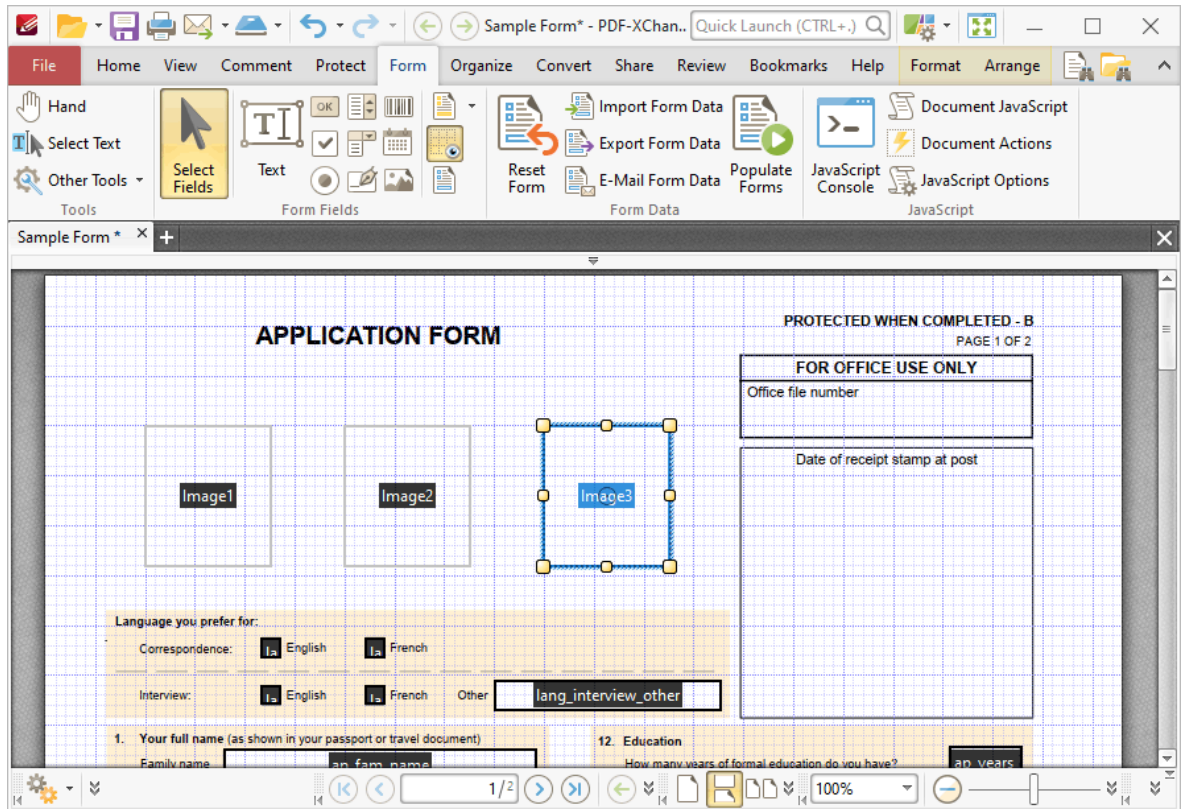

Figure 3. Added Image Fields

- Click and drag the yellow control points to resize image fields.
- Use the options in the **Format Tab** to determine the style and appearance of selected image fields:

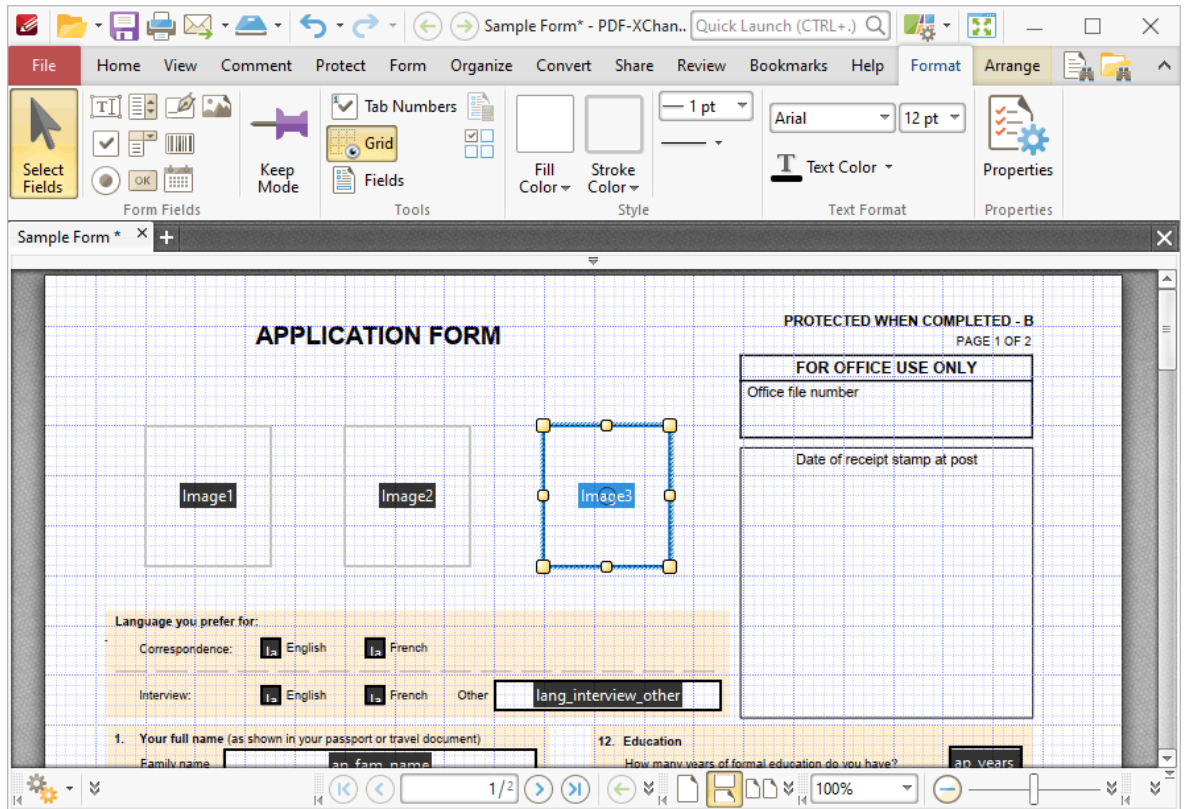

Figure 4. Format Tab, Image Fields

- Click **Select Fields** to select and edit form fields.
- Click the options in the **Form Fields** group to enable alternative form field formats.
- Click **Keep Mode** to create multiple image fields consecutively. If this option is disabled then **PDF-XChange Editor** will revert to the designated default tool after the creation of a single image field.
- Click **Tab Numbers** to show/hide the tab order numbers of form fields.
- The **Calculation Order** setting is not available for image fields.
- Click **Grid** to enable/disable the grid, which is used to assist in the accurate placement of form fields, as detailed in **(figure 4)**.
- Click **Create Multiple Copies** to create multiple copies of selected form fields, as detailed [here](#).
- Click **Fields** to show/hide the **Fields** pane, which is used to view/edit form fields.
- Click **Fill Color** to determine the fill color of the image field.
- Click **Stroke Color** to determine the border color of image fields.
- Click **Width** to determine the width of image field borders.
- Click **Border** to determine the style of image field borders.
- The options in the **Text Format** group are not applicable to image fields.

- Click **Properties** to open the **Push Button Properties** pane, which enables the customization of additional elements of image fields and is detailed in the section below.

### ▼ The Push Button Properties Pane

The **Push Button Properties** pane can be used to determine a range of style and functionality options for image fields. For example, it is possible to use the **Actions** properties to add multiple dynamic actions to image fields, such as running JavaScript, launching web links and opening files on the local computer. (JavaScript is a high-level programming language that can be used to perform custom operations. See [here](#) for an index of existing JavaScript operations that the **PDF-XChange Editor** forms can use, as well as additional information about JavaScript). Click **Select Fields** to select form fields, then click the desired field and click **Properties** in the **Format** tab to open the **Push Button Properties** pane:

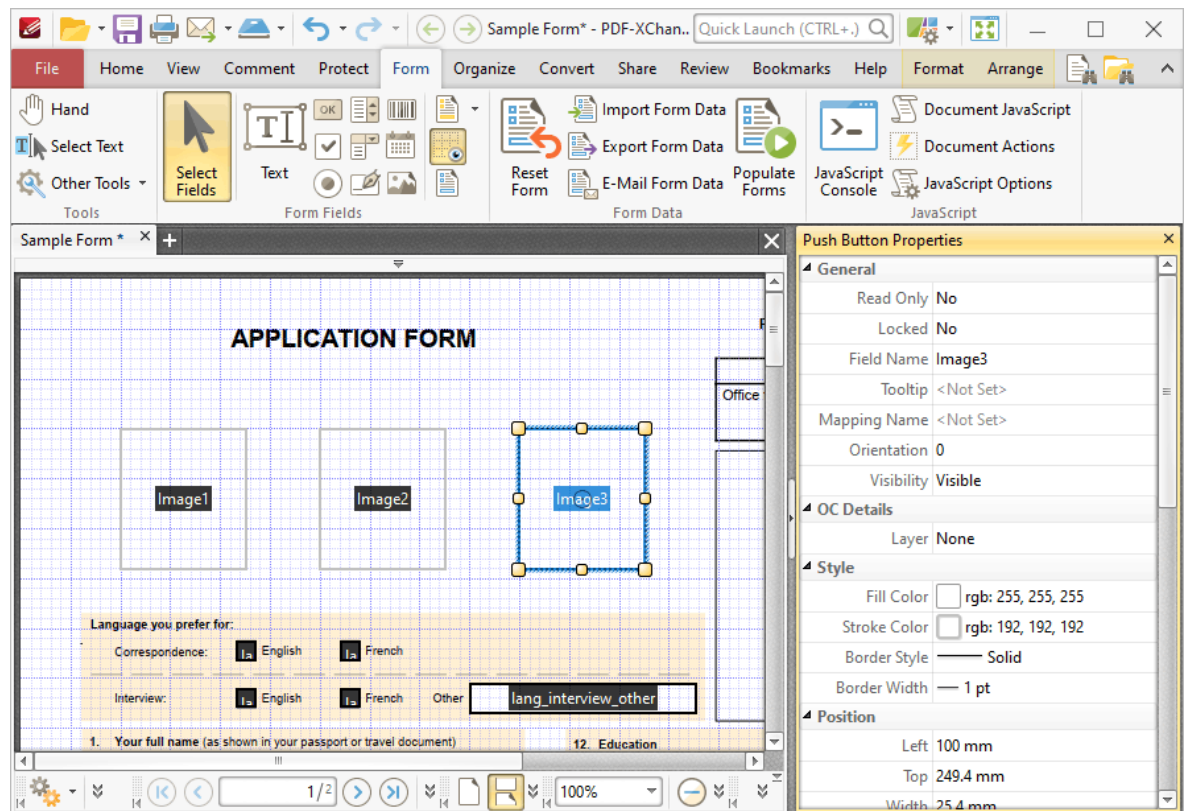

Figure 5. Image Field Tool, Push Button Properties Pane

The options detailed below are available in the **Image Field Properties** pane:

The **General** properties determine the general parameters of image fields:

- **Read Only** determines whether or not the image field can be edited.
- **Locked** determines whether or not image fields can be moved, and whether or not their properties can be modified.



- **Field Name** determines the name of the image field. This name is present when the **Edit Form** tool is selected, and when image fields are listed in the [Fields pane](#).<sup>1016</sup>
- **Tooltip** determines the information displayed when the pointer is hovered over the image field.
- **Mapping Name** determines the mapping name that the image field uses. This name is used to reference interactive form data when the form is exported, and does so without affecting the appearance of the name in the original document.
- **Orientation** determines the orientation of the image field.
- **Visibility** determines the visibility of the image field.

The **OC Details** property determines the optional content layer to which the image field belongs. When a field belongs to an optional content layer, it displays only when the layer is enabled. Use the **Layers** pane to view/create/edit layers, as detailed [here](#).<sup>1024</sup>

The **Style** properties determine stylistic elements of image fields. They are detailed beneath [\(figure 4\)](#).

The **Position** properties determine the position and dimensions of image fields:

- **Left** determines the distance of the image field from the left margin.
- **Top** determines the distance of the image field from the bottom of the page.
- **Width/Height** determine the width/height of the image field.

The **Default Text Format** properties are not applicable to image fields.

The **Options** properties determine additional options for image fields.

- **Layout** determines the layout of the image field, which can be displayed as text label, icon or a combination of both elements:
  - **Label Only** is the default setting for standard buttons. The text label that the **Up Label** property specifies is the only element displayed on the button. The **Up Label** property becomes available in the **Options** properties when **Label Only** setting is enabled.
  - **Icon Only** uses the custom image that the **Up Icon** property specifies to represent the button. The **Up Label** property becomes available in the **Options** properties when **Icon Only** setting is enabled. Image fields are set to **Icon Only** by default.
  - **Icon Top, Label Bottom** displays a custom image as the upper section of the button and the text label beneath the image.
  - **Label Top, Icon Bottom** displays the text label as the upper section of the button and a custom image beneath the text.
  - **Icon Left, Label Right** displays a custom image on the left and the text label on the right.
  - **Label Left, Icon Right** displays the text label on the left and a custom image on the right.

- **Label over Icon** uses a custom image to represent the button and places the text label over the image.



Figure 6. Available Layout Options for Image Fields

- **Behaviour** specifies the visual effect when buttons are pressed:
  - **None** specifies that no visual change occurs.
  - **Invert** inverts the fill color of the button.
  - **Outline** creates an outline around the button.
  - **Push** creates a visual effect when buttons are clicked:



Figure 7. Default to Invert (Top), Default to Outline (Centre) and Default to Push (Bottom)

- **Up Label** specifies the text that the button uses. N.b. A **Layout** property that specifies a label must be enabled for the option to be available.
- **Up Icon** specifies the icon that the button uses. N.b. A **Layout** property that specifies an icon must be enabled for the option to be available.

The **Icon Placement** properties determine settings for the icon used in the image field:

- **When to Scale** determines when icons are scaled to the size of the image field on which they are featured:
  - **Always** scales the icon to the size of the image field in all cases.
  - **Scale Type** determines how the icon is scaled:
    - **Proportionally** retains the aspect ratio of the icon
    - **Non-proportionally** ignores the aspect ratio of the icon.

- **Never** retains the original size of the icon regardless of the size of the image field.
- **Icon is Too Big** scales icons in cases where icons are larger than the image field.
- **Icon is Too Small** scales icons in cases where icons are smaller than the image field.
- **Fit to Bounds** fits the icon to the bounds of the image field.
- **Horizontal Position** determines the horizontal position of the icon in the image field.
- **Vertical Position** determines the vertical position of the icon in the image field.

The **Actions** properties determine the action taken when users interact with the image field:

- **Mouse Down** initiates an action when the left mouse button is pressed (without being released).
- **Mouse Up** initiates an action when the left mouse button is clicked (pressed and released).
- **Mouse Enter** initiates an action when the pointer moves into the image field.
- **Mouse Leave** initiates an action when the pointer moves out of the image field.
- **On Focus** initiates an action when the image field is selected.
- **On Blur** initiates an action when the image field is deselected.
- Click the ellipsis icon on the right of actions to add/edit image field actions:

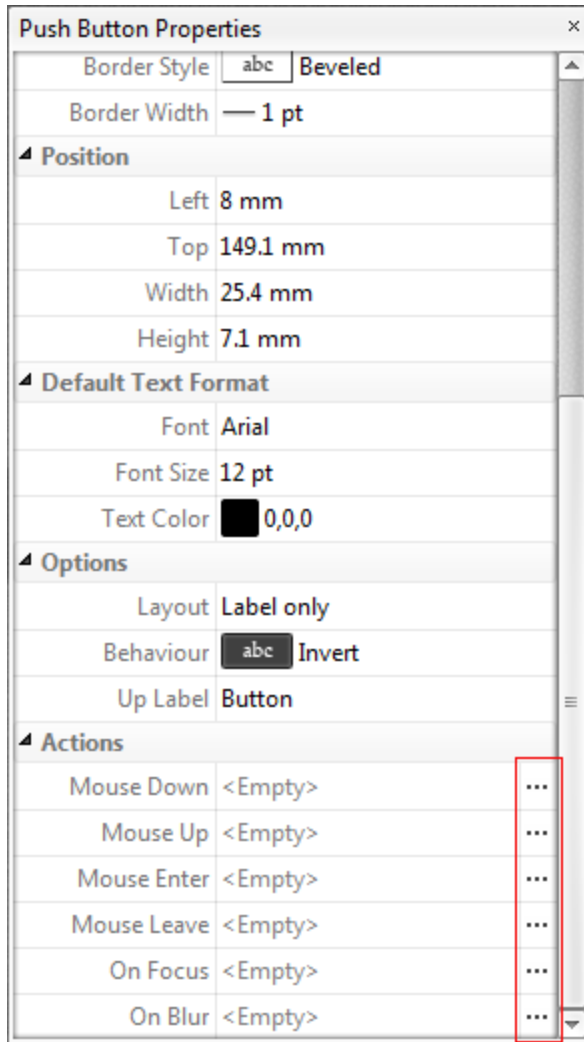

Figure 8. Image Field Properties Pane, Action Ellipses

The process of adding actions is detailed [here](#).<sup>959</sup>

### 10.4.6.11 JavaScript Console



## JavaScript Console

The **JavaScript Console** is used to execute JavaScript in documents. JavaScript is a high-level programming language that can be used to perform a range of operations.

Click the **Form** tab, then click **JavaScript Console** (or press Ctrl+J) to open the **JavaScript Console**:

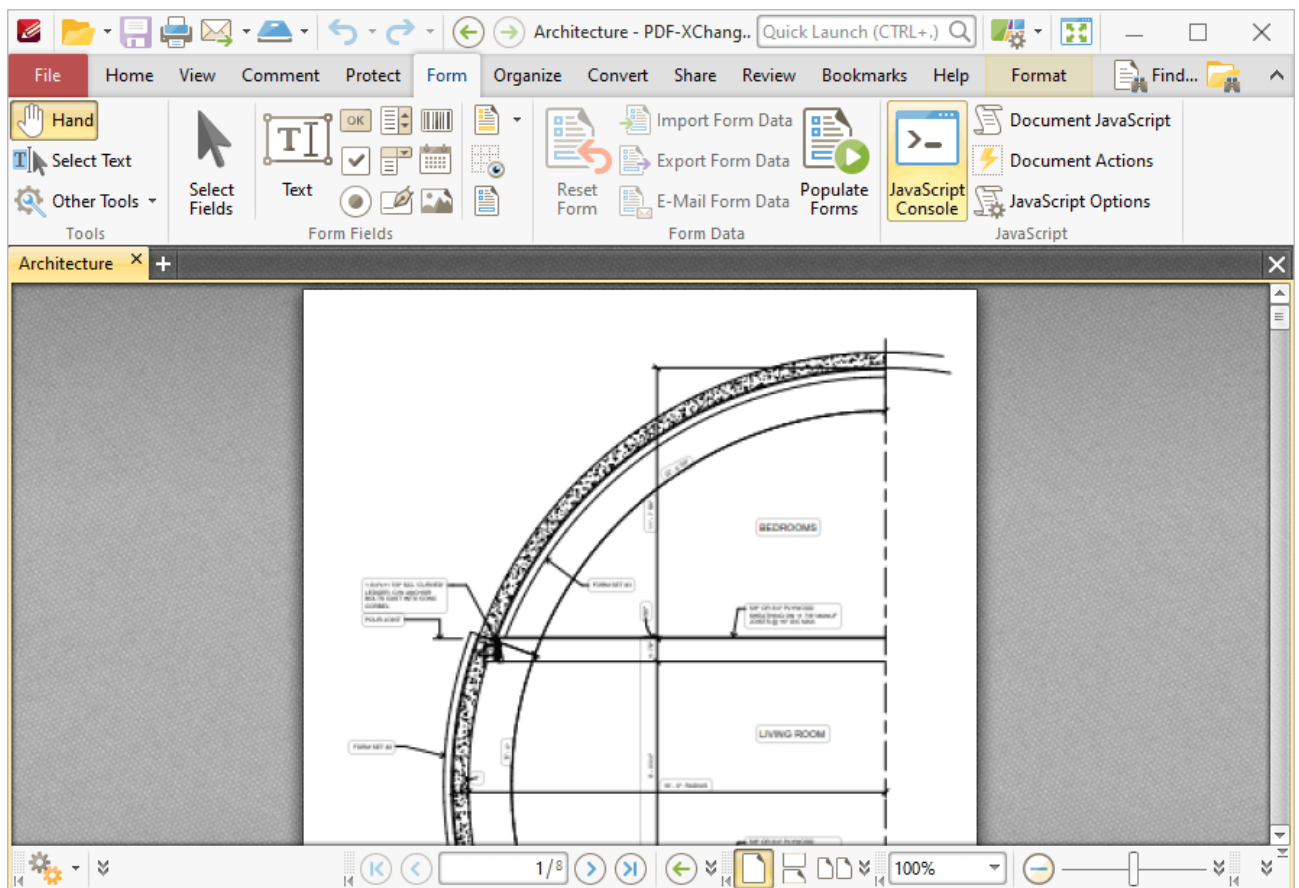

Figure 1. Form Tab, JavaScript Console

The **JavaScript Console** will open:

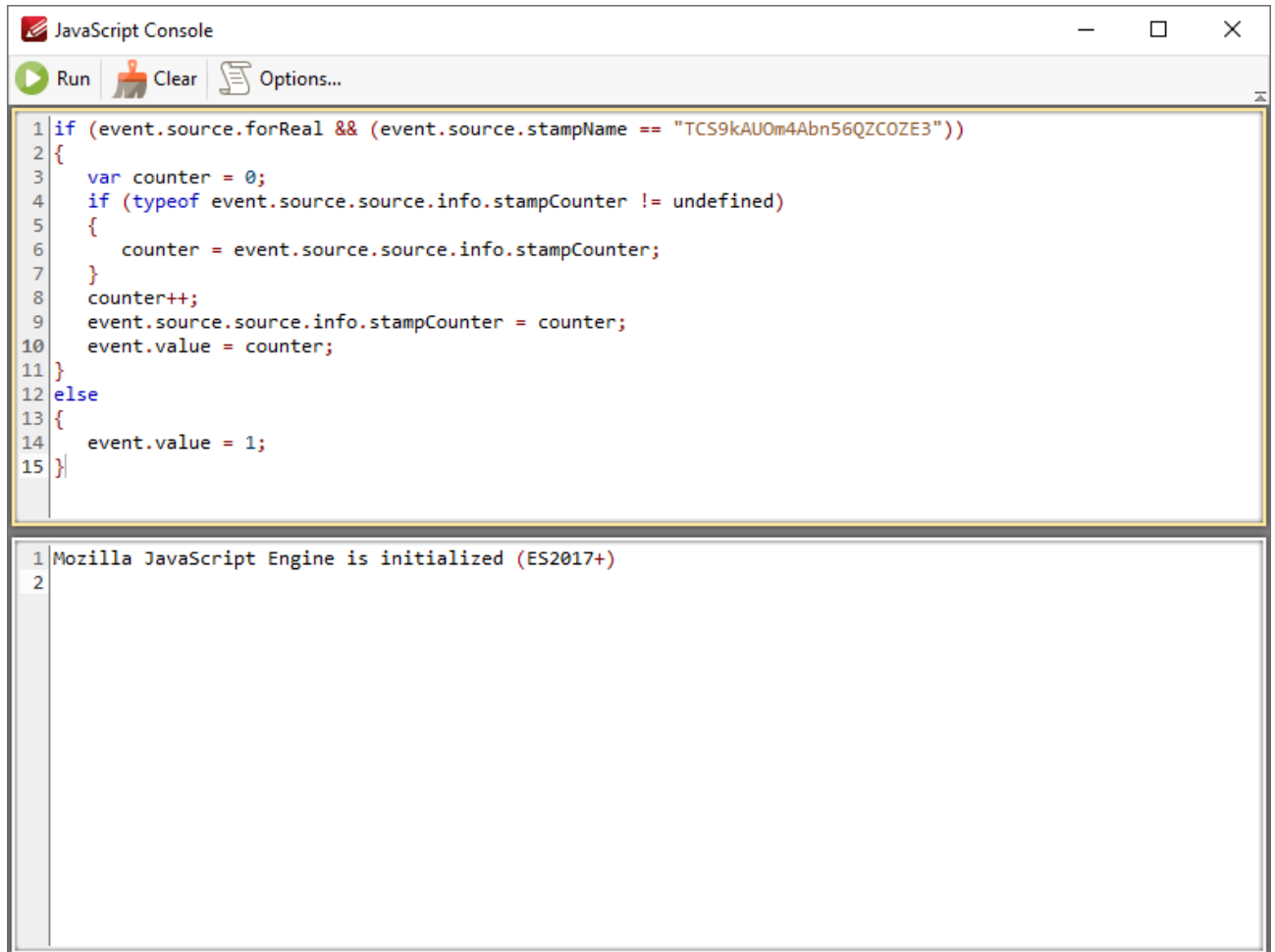

Figure 2. JavaScript Console

- Enter the desired JavaScript in the upper window, then click **Run** (or press Ctrl+Enter) to run JavaScript. Errors in JavaScript and/or output of JavaScript will be displayed in the lower window.
- Click **Clear** to remove error messages/output from the lower window.
- Click **Options** to customize JavaScript preferences, as detailed [here](#).<sup>[891]</sup>

Note that the [Link Creation Tool](#)<sup>[956]</sup> can be used to create JavaScript-enabled links.

If you want to add JavaScript permanently to documents, then the **Actions/JavaScript** categories in [Document Properties](#)<sup>[843]</sup> must be used.

An index of existing JavaScript operations that **PDF-XChange Editor** supports and additional information about JavaScript is available [here](#).

10.4.6.12 Populate Forms



**Populate Forms**

Click **Populate Forms** to create and populate forms with data from an existing file:

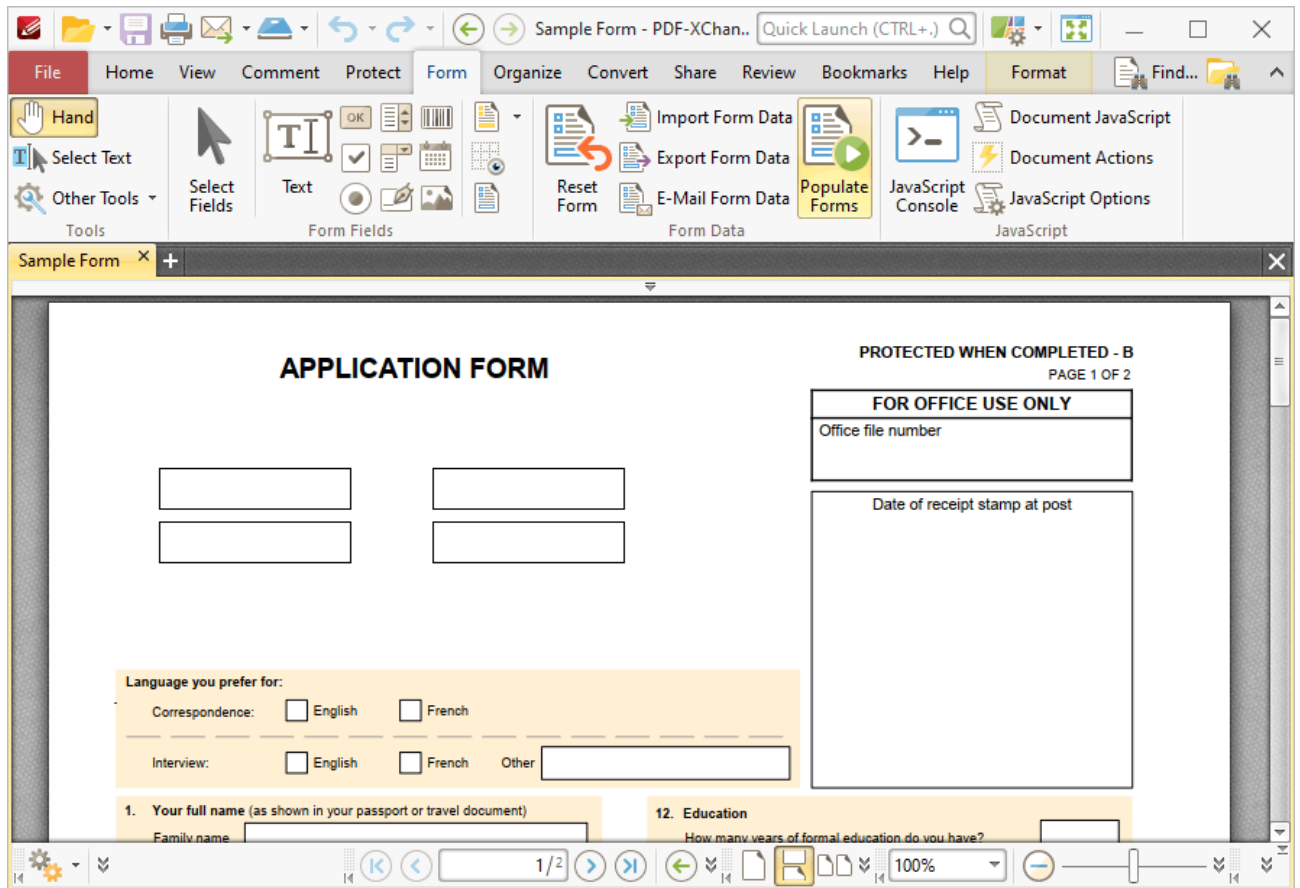

Figure 1. Forms Tab, Populate Forms

The **Populate PDF Forms** dialog box will open:

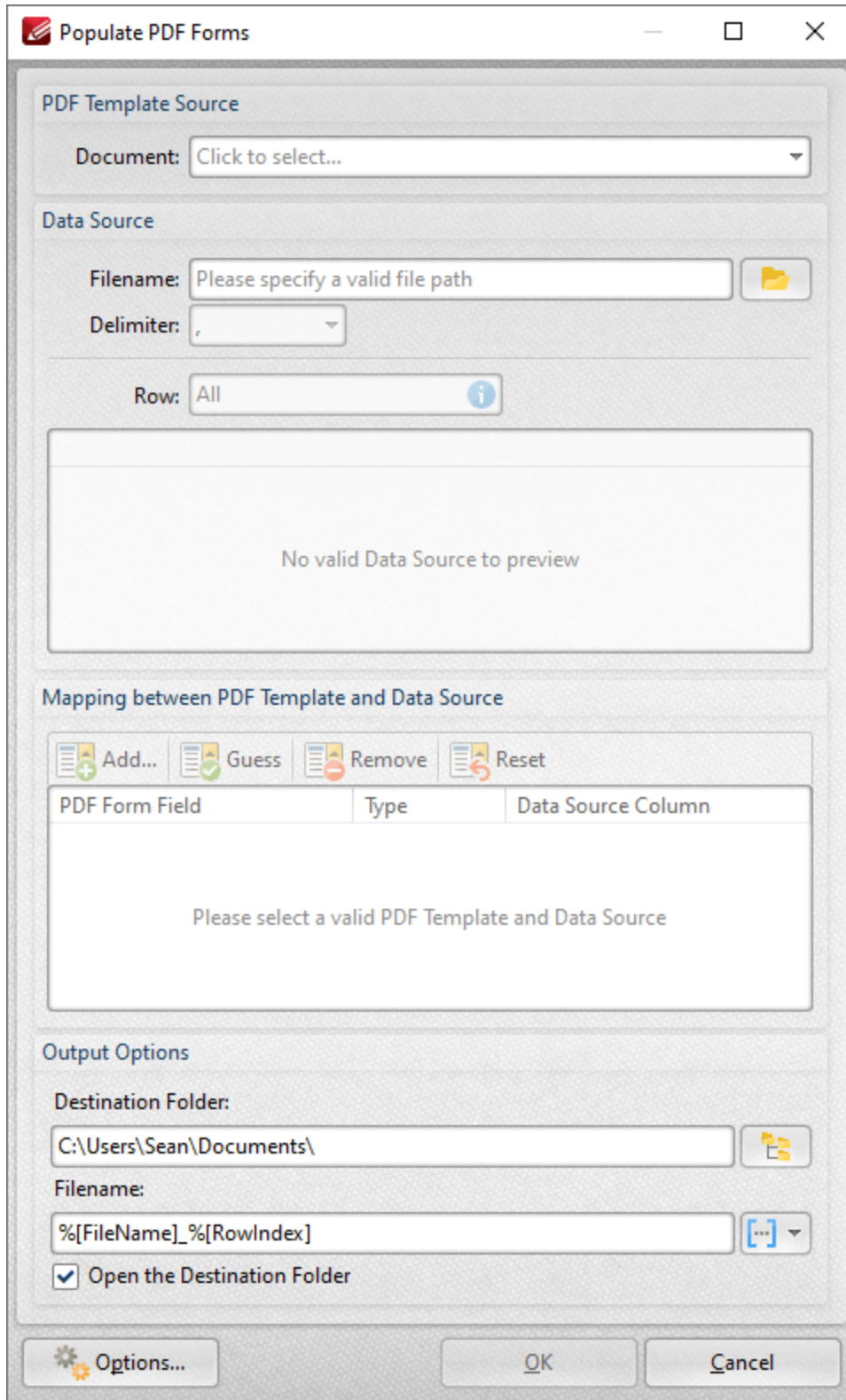

Figure 2. Populate PDF Forms Dialog Box

- Use the **Document** dropdown menu to determine the template used to create the form.



- Use the **Filename** dropdown menu to determine the file used to populate the form fields in the created document, and the **Delimiter** dropdown menu to determine the delimiter used to define files and values in the data source document. Note that it is only necessary to specify the delimiter when plain text files are used, and it may be necessary to add these delimiters before the document is used for this feature.
- Use the **Row** dropdown menu to determine the row of information used in cases where the source document contains more than one set of form information.

When you have selected a template and a data source file, the **Mapping between PDF Template and Data Source** section will display the form fields from the template file in the left column:

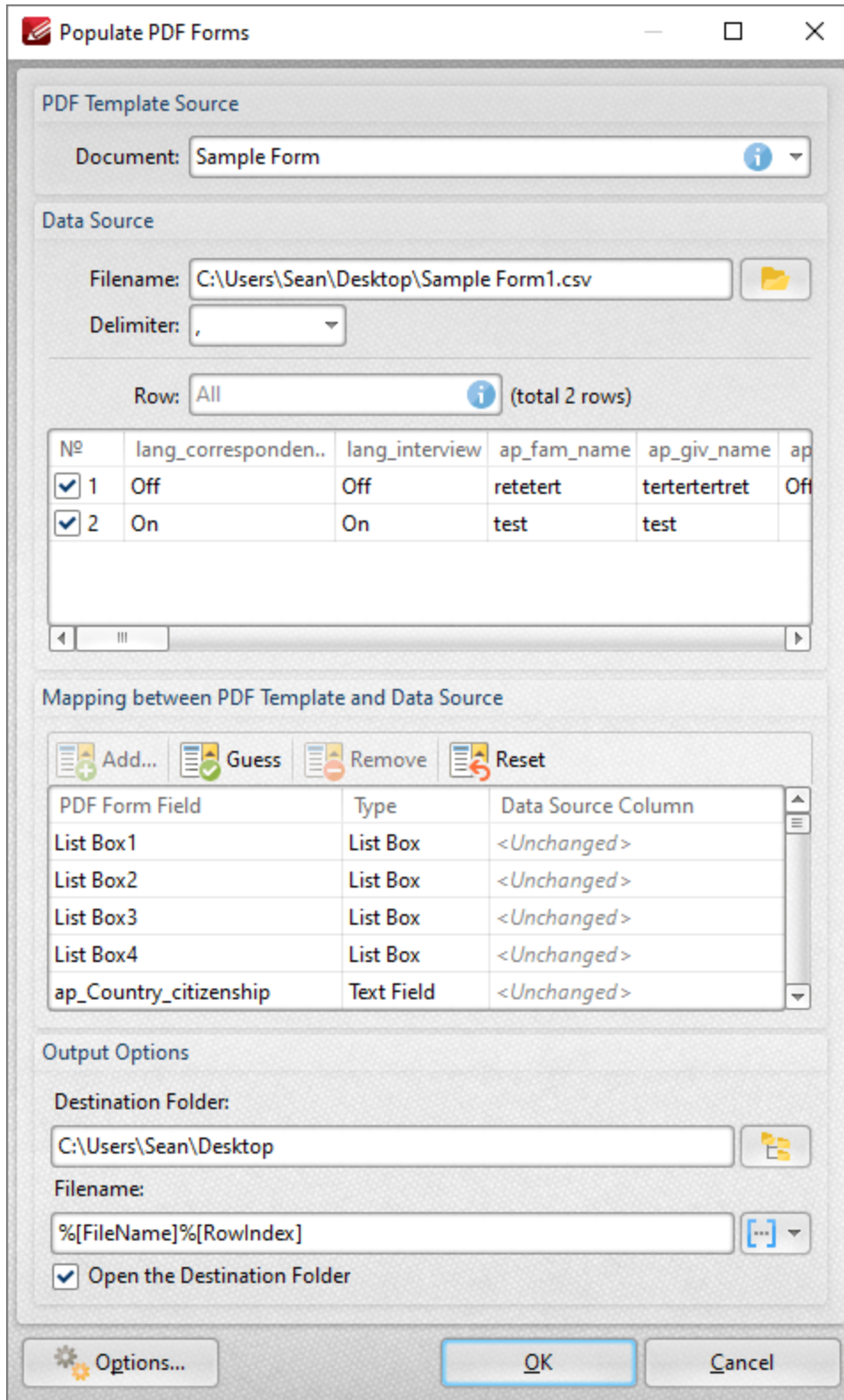



Figure 3. Populate PDF Forms Dialog Box, Data Source Column Selection Active

- Select entries in the **PDF Form Field** column and click **Add** (or click the associated entry in the **Data Source Column**) to add data from the data source file to the selected form field in output documents.
- Click **Guess** to auto-fill forms. This is a useful feature when the names of the forms in the template document match the names of the forms in the data source document, as they will populate automatically with the matching information.
- Click **Remove** to remove selected entries from the **Data Source Column**.
- Click **Reset** to reset all entries in the **Data Source Column**.
- Use the **Destination Folder** dropdown menu to determine the folder for created documents.
- Use the **Filename** dropdown menu to determine the filename of created documents. Note that you can use [macros](#)  when creating the file name. Two of the available macros apply specifically to the populate forms feature:
  - **Row Data by Column** uses the form data from either the **Column Index** or the **Column Name** to determine the file name.
  - **Row Index** uses the index values of the rows of data in the data source document to determine the file name.

Click **OK** to create and populate the form.

Click **Options** for additional options:

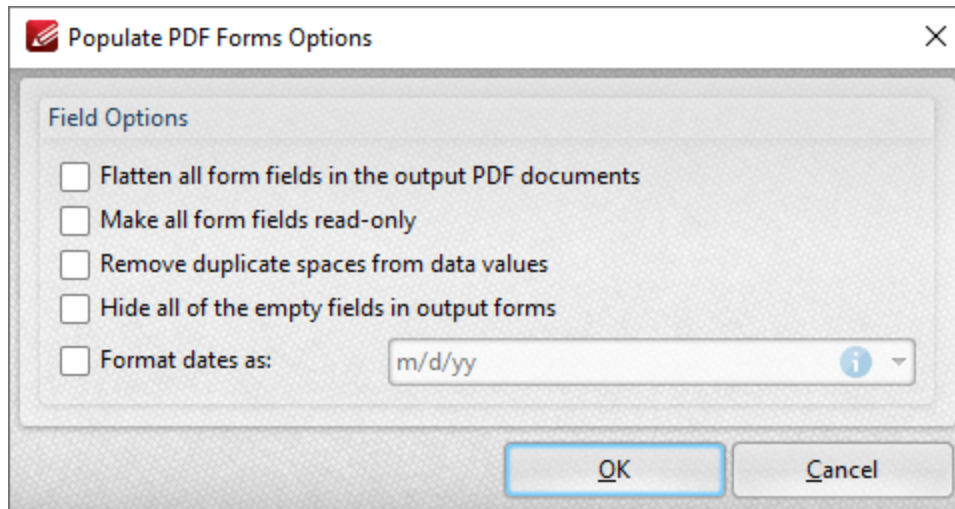



Figure 4. Populate PDF Forms Options

- Select the **Flatten all form fields in the output PDF documents** box to flatten form fields into base content when the output documents are created.
- Select the **Make all form fields read-only** to enable the read-only property of form fields in output documents. This means that form fields cannot be edited unless the read-only property is subsequently disabled.
- Select the **Remove duplicate spaces from data values** box to remove duplicated spaces from data values in output documents.

- Select the **Hide all of the empty fields in output forms** to hide empty fields in output documents.
- Select the **Format dates as** box to specify the use of a date format, then select the desired format in the adjacent dropdown menu.

Click **OK** to save changes.

Note that you can use the [Export Form Data](#)  feature to export data from filled-out forms to **(\* .csv)** format for subsequent use as data source files with the **Populate Forms** feature.

---

## 10.4.6.13 Editing Forms



## Editing Forms

Right-click fields to open the fields shortcut menu, which is used to edit and manipulate form fields:

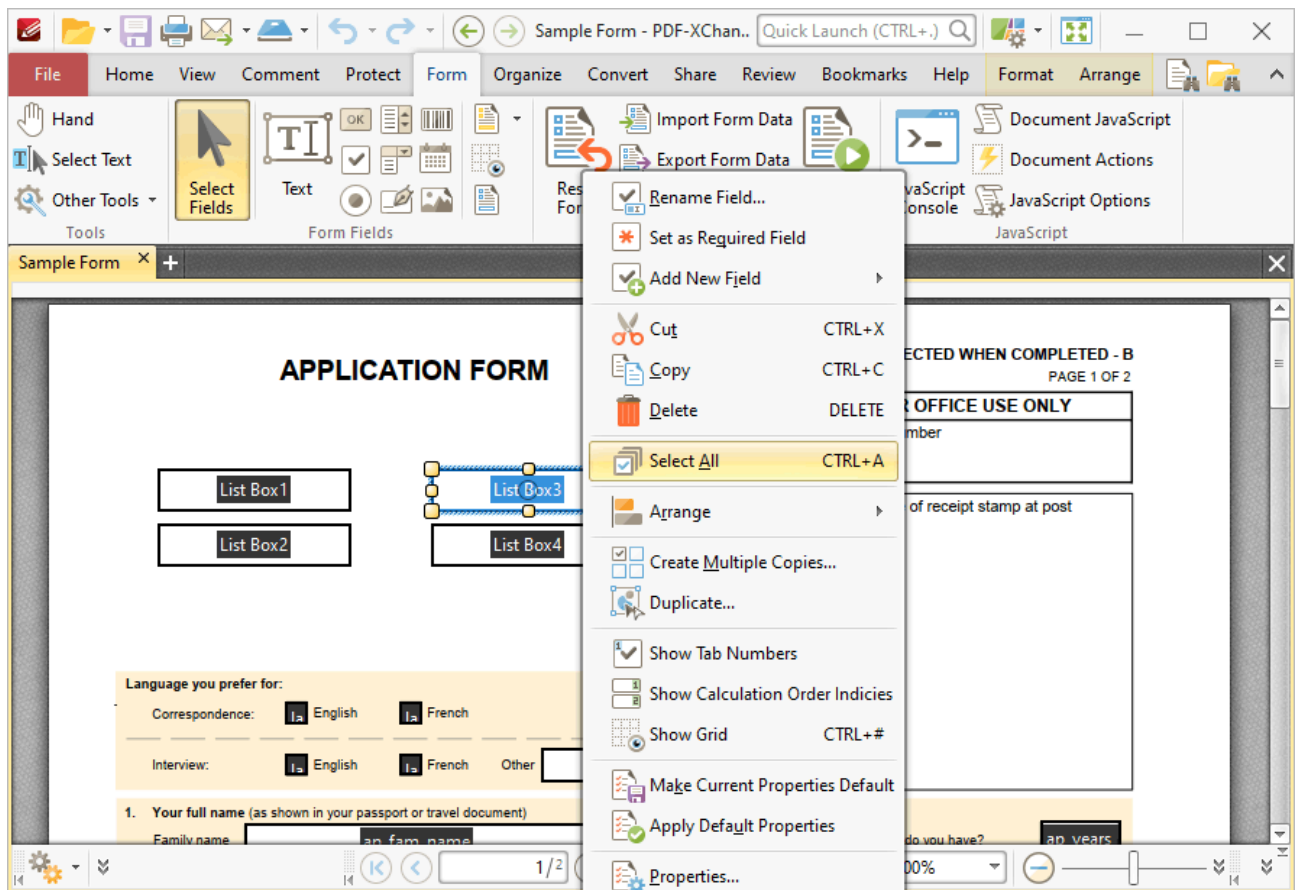



Figure 1. Forms Shortcut Menu

- Click **Rename Field** to rename selected fields.
- Click **Set as Required Field** to designate selected field as required, which means it must be filled before the document can be submitted. These fields will also be highlighted when the **Highlight Required Fields Only** option outlined [here](#) is enabled.
- Click **Add New Field** to add new form fields to documents.
- Click **Cut**, **Copy** or **Delete** to cut/copy/delete selected forms.

- Click **Select All** to select all form fields.
- Click **Arrange** to arrange fields. This option is available only when multiple fields are selected. If the fields were group-selected with the mouse, then the first field placed in the document is used as the reference point to arrange the other fields. If the form fields were group-selected by holding Ctrl and selecting fields one at a time, then the first field selected will be used as the reference point. The **Arrange** options are detailed below:
  - **Align Left Edges**
  - **Align Horizontal Centers**
  - **Align Right Edges**
  - **Align Top Edges**
  - **Align Vertical Centers**
  - **Align Bottom Edges**
  - **Align to Selection** aligns selected forms to **Selection Bounds**, **Key Object** or **Page** as desired.
  - **Distribute Horizontally**
  - **Distribute Vertically**
  - **Make Same Width**
  - **Make Same Height**
  - **Make Same Size**
  - **Bring Forward**, which brings the selected field up a step in cases where multiple forms overlap.
  - **Send Backward**, which sends the selected field back a step in cases where multiple forms overlap.
  - **Bring to Front**, which brings the selected field to the top in cases where multiple forms overlap.
  - **Send to Back**, which sends the selected field to the back in cases where multiple forms overlap.
- Click **Create Multiple Copies** to create copies of selected forms, as detailed below.
- Click **Duplicate** to duplicate selected forms to a specific page range, as detailed below.
- Click **Show Tab Numbers** to display automated tab numbers in each form field. These numbers represent the tab order when the Tab key is used to navigate between forms.
- Click **Show Grid** to activate the grid feature, which displays in the background of documents and assists in the placement of objects.
- Click **Make Current Properties Default** to set the properties of the form field currently selected as the default properties for all subsequent forms of the same format.
- Click **Apply Default Properties** to apply the default properties to the selected form field.
- Click **Properties** to launch the [Properties](#)  pane, which can be used to view/edit the properties of selected fields.

## Create Multiple Copies of Form Fields

Follow the steps below to create multiple copies of form fields:

1. Click the **Form** tab, then click **Select Fields** and select the form fields to be copied:

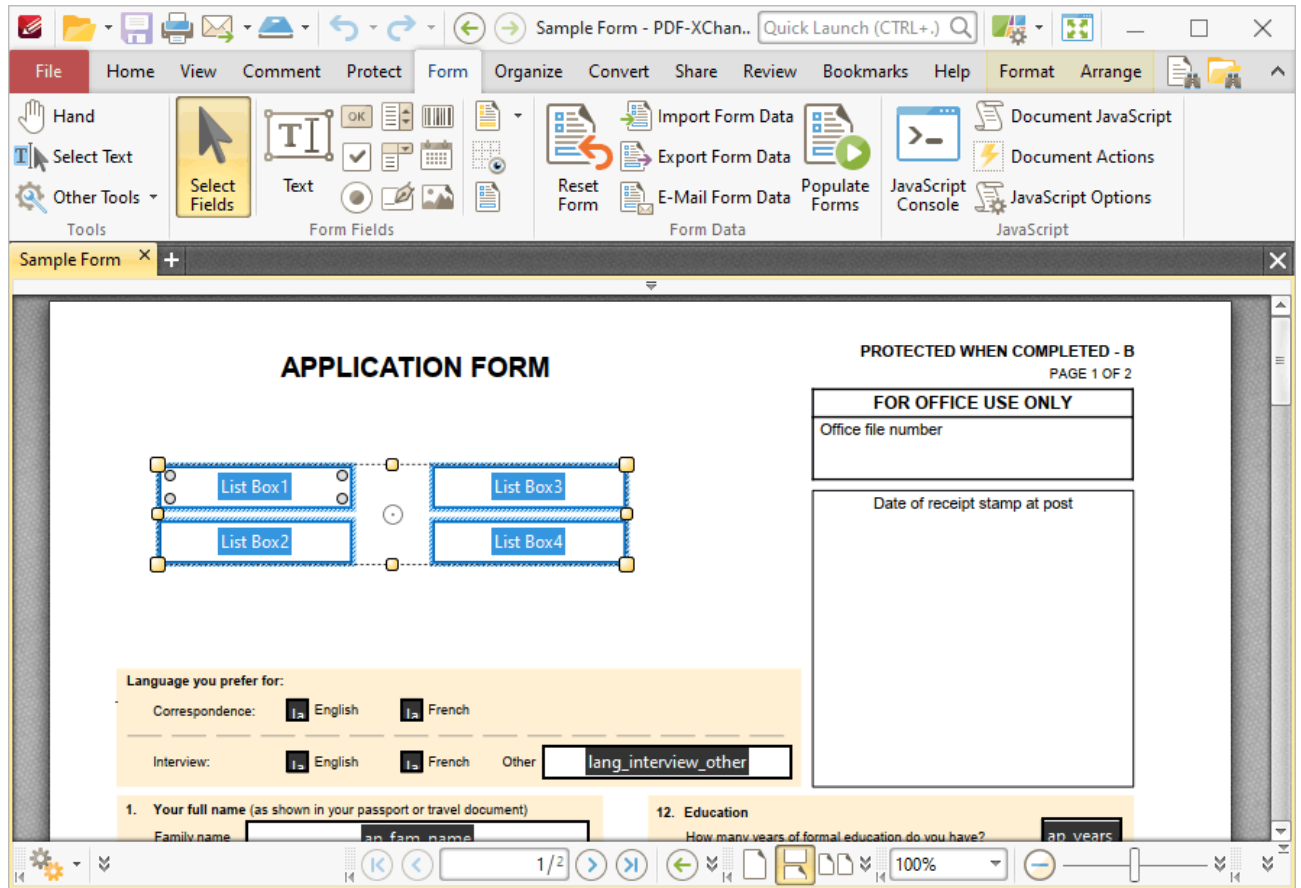

Figure 2. Form Tab, Select Fields Enabled, Forms Selected

2. Click the **Format** tab, then click **Create Multiple Copies**:

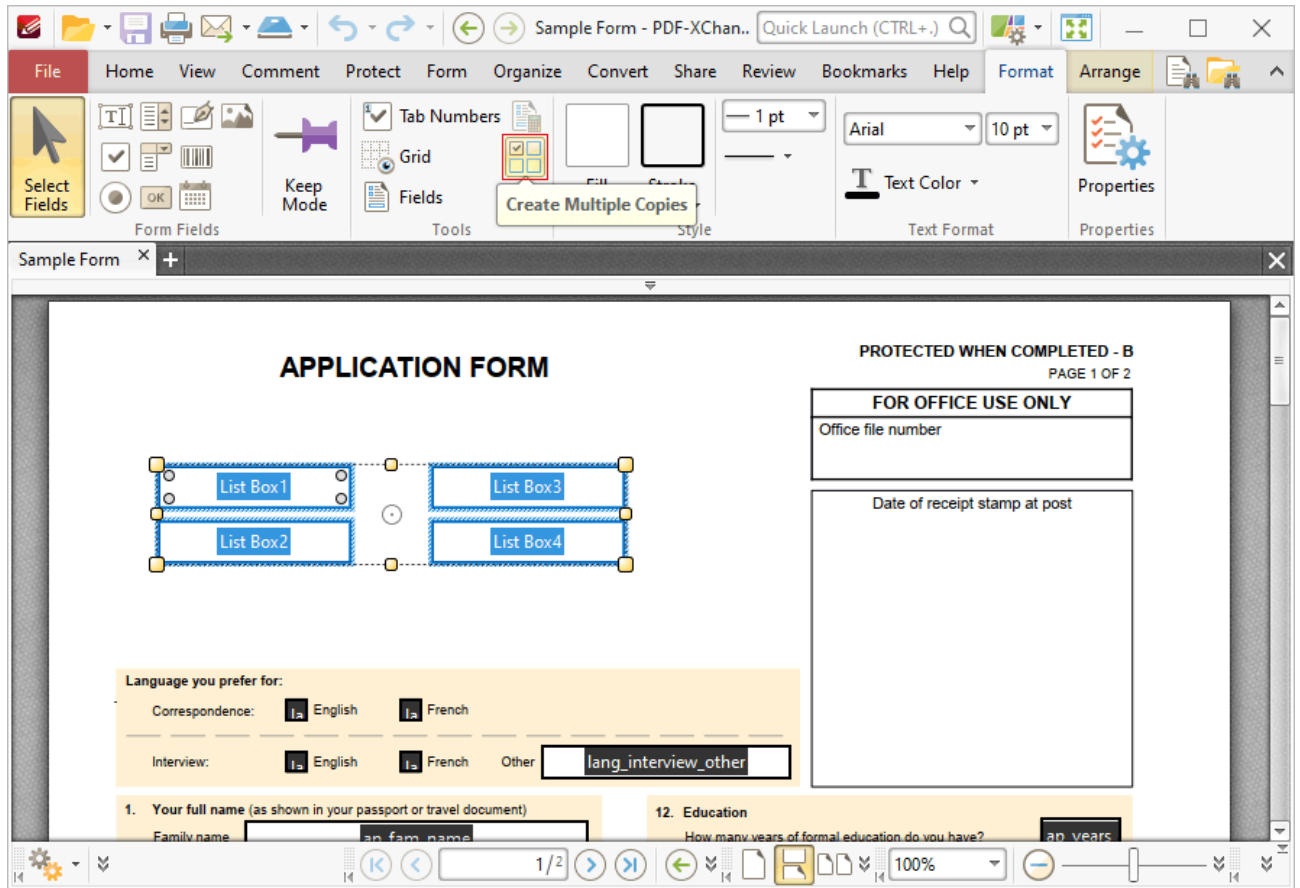

Figure 3. Format Tab, Create Multiple Copies

The **Create Multiple Copies of Fields** dialog box will open:



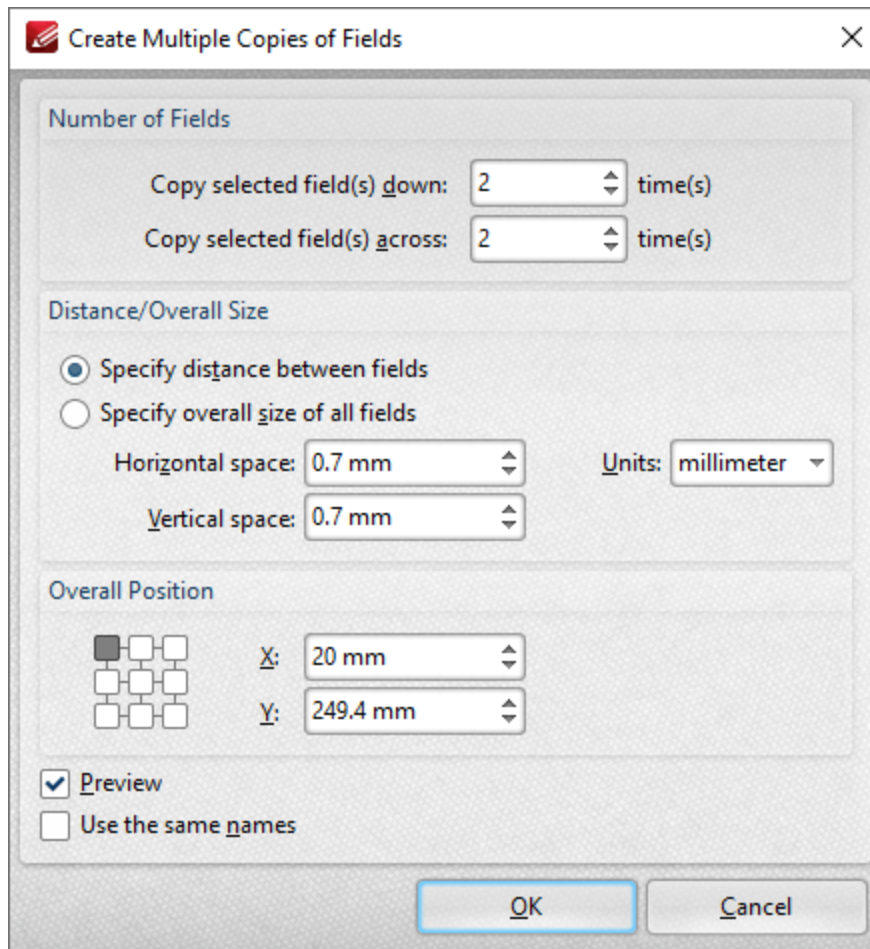

Figure 4. Create Multiple Copies of Files Dialog Box

- The figure entered in the the **Copy selected fields down** number box determines the amount of copies placed vertically below source fields.
- The figure entered in the the **Copy selected fields across** number box determines the amount of copies placed horizontally from source fields.
- Select **Specify distance between fields** to determine the distance between copies. Enter the desired distances in the **Horizontal space** and **Vertical space** number boxes.
- Select a unit of measurement from the **Units** menu.
- Select **Specify overall size of all fields** to determine the size of the area in which fields are multiplied. The value entered in the **Overall width** and **Overall height** number boxes determines the overall width and height of the area in which the selected field is multiplied. Select the desired units of measurement from the **Units** menu.
- The **Overall Position** settings can be used to determine the overall position of copied fields. Edit the **X** and **Y** values as desired. The position selected in the grid determines the starting point for measurements when multiple copies of form fields are created.
- Select the **Preview** box to place a preview before the creation of copied fields.
- Select the **Use the same names** box as desired. This is useful for fields that require the same user data or other elements such as the current date. Copies will feature the same name as source fields, followed by a unique number.

### Duplicate Form Fields

Follow the steps below to duplicate form fields:

1. Click the **Form** tab, then click **Select Fields** and select the form fields to be copied:

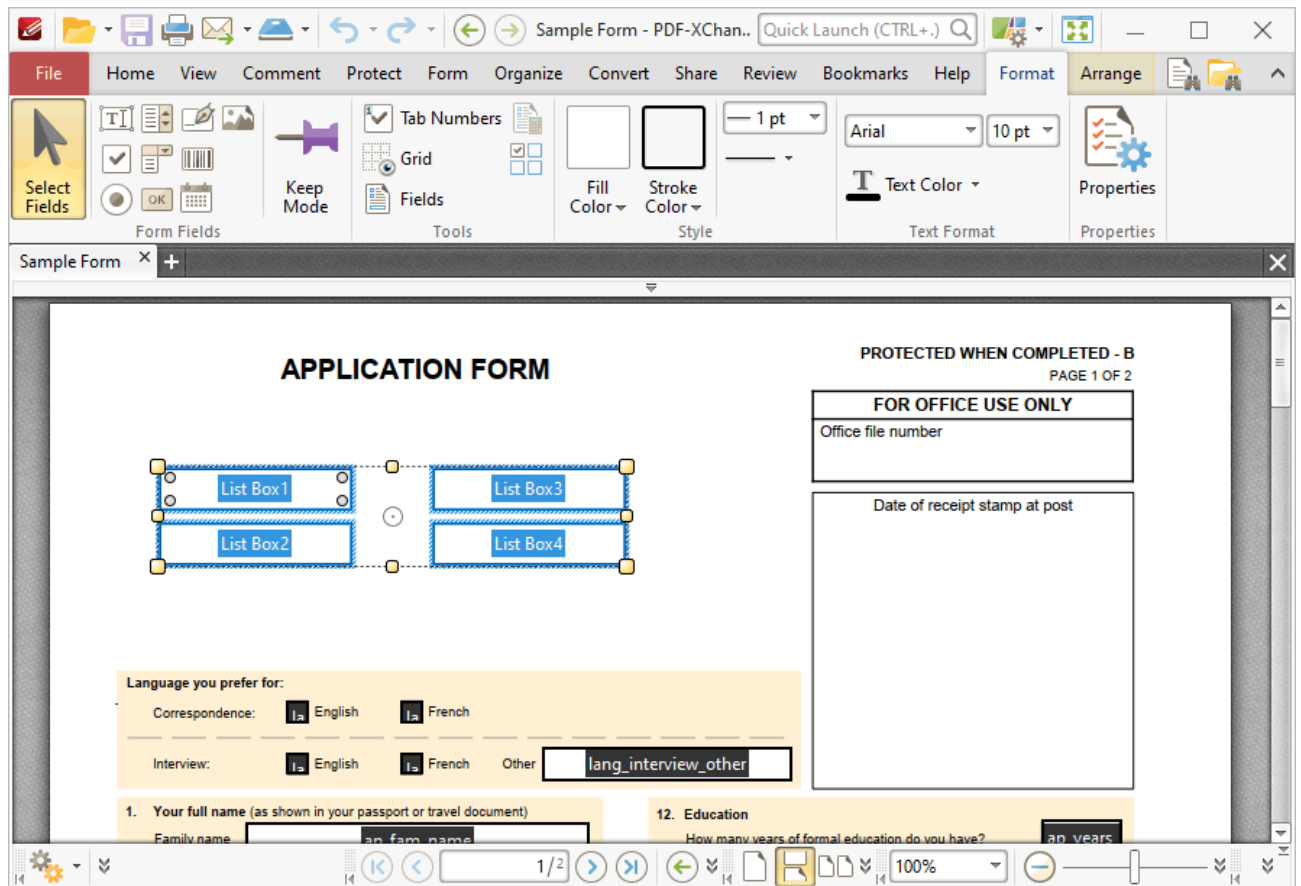

Figure 5. Selected Fields

2. Right click the fields and then click **Duplicate**:

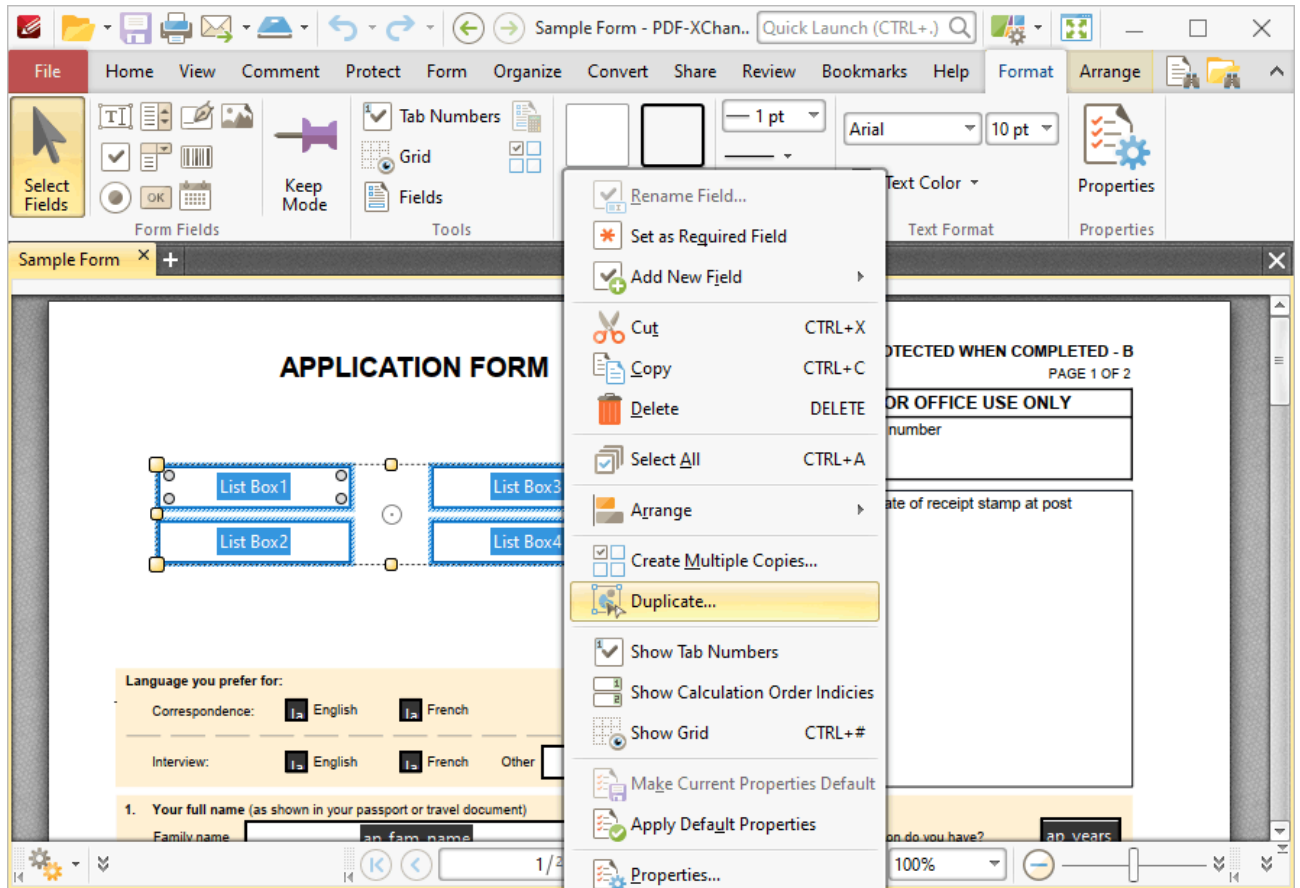

Figure 6. Right-Click Shortcut Menu, Duplicate

The **Duplicate Annotations** dialog box will open:

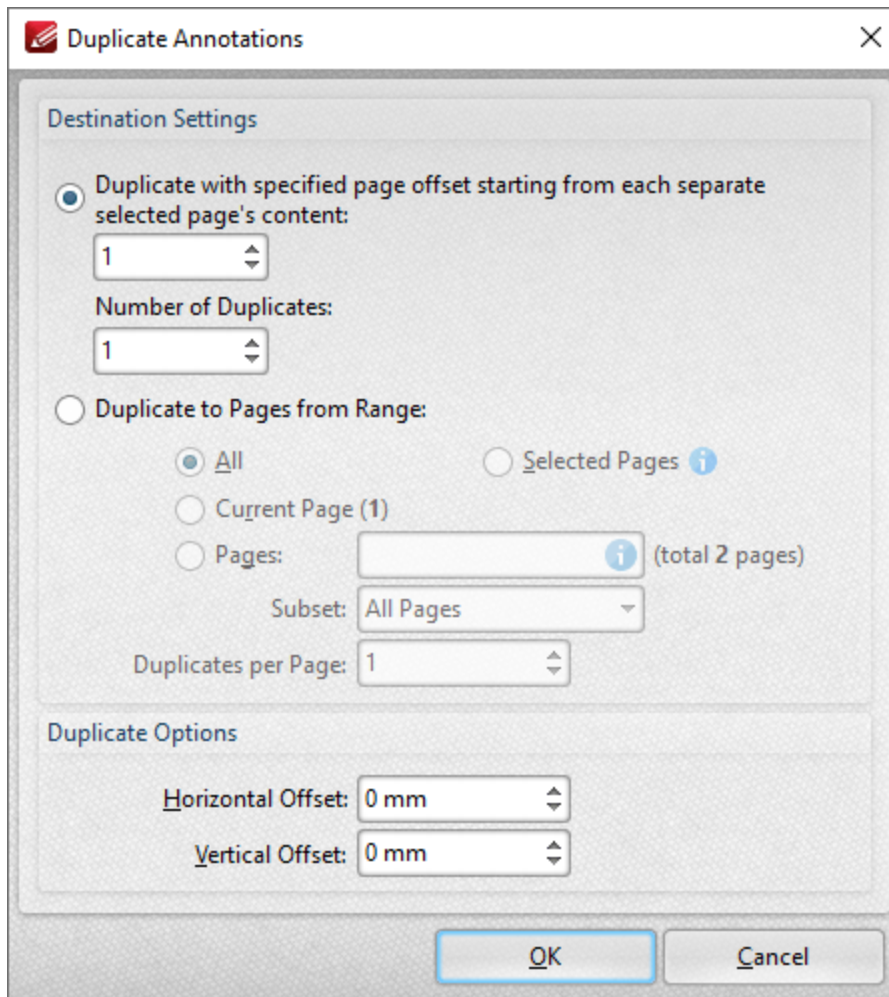

Figure 6. Duplicate Annotations Dialog Box

- Use the **Destination Settings** to determine the output settings for duplicated forms:
  - Select the upper option button to duplicate forms through a specified page offset from the source form. Enter the desired page offset in the upper number box and the number of duplicates in the lower number box. For example, if the page offset is specified as '3' and the number of duplicates is specified as '3', then three duplicates will be created, with one placed on every third page starting from the source form.
  - Select the lower option button to duplicate forms to a specified page range:
    - Click **All** to select all document pages.
    - Click **Current Page** to duplicate the form on only the current page.
    - Click **Pages** to determine a page range. See [here](#)<sup>1773</sup> for page range options.
    - Use the **Subset** option to select **All Pages**, **Odd Pages Only** or **Even Pages Only** for page ranges.
    - Use the **Duplicates per Page** number box to specify the number of duplicate forms created per page.
- Use the **Duplicate Options** settings to determine the duplication of selected forms:

- The value entered in the **Horizontal Offset** number box determines the horizontal offset from the duplicated field.
- The value entered in the **Vertical Offset** number box determines the vertical offset from the duplicated field.

## Tab Order of Forms

Please note that the Tab key can be used to scroll through text field forms after they have been added to documents. Follow the steps below to change the tab order of forms:

1. Click the **View** tab.
2. Click the **Panes** dropdown menu, then click **Fields**. The **Fields** pane will open.
3. Click **Options**. The **Options** submenu will open.
4. Click **Order by Pages**, then click and drag fields within the **Fields** pane to change the tab order.

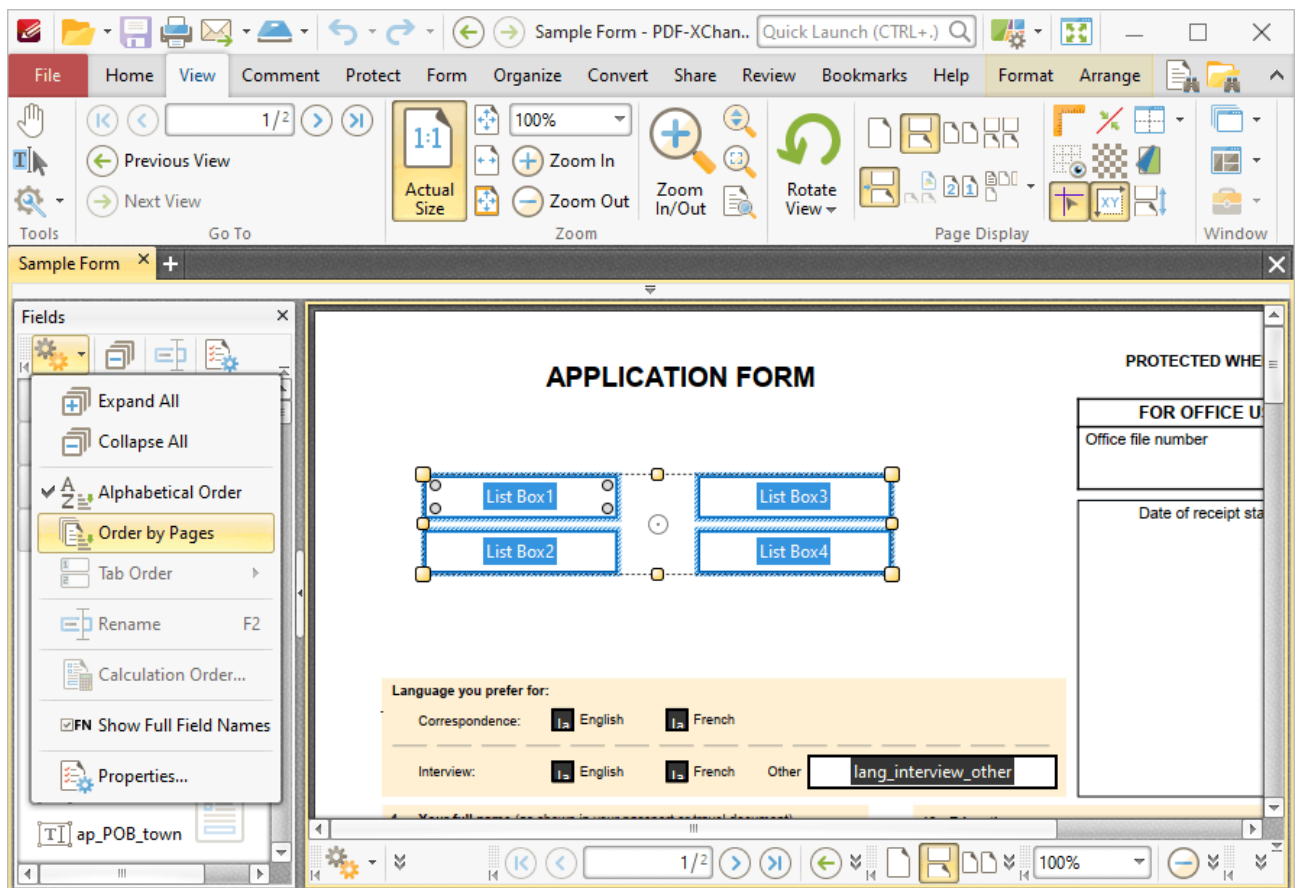

Figure 7. Fields Pane, Tab Order Submenu



### 10.4.7 Organize Tab



## Organize Tab

When the **Organize** tab is selected, the following options are available:

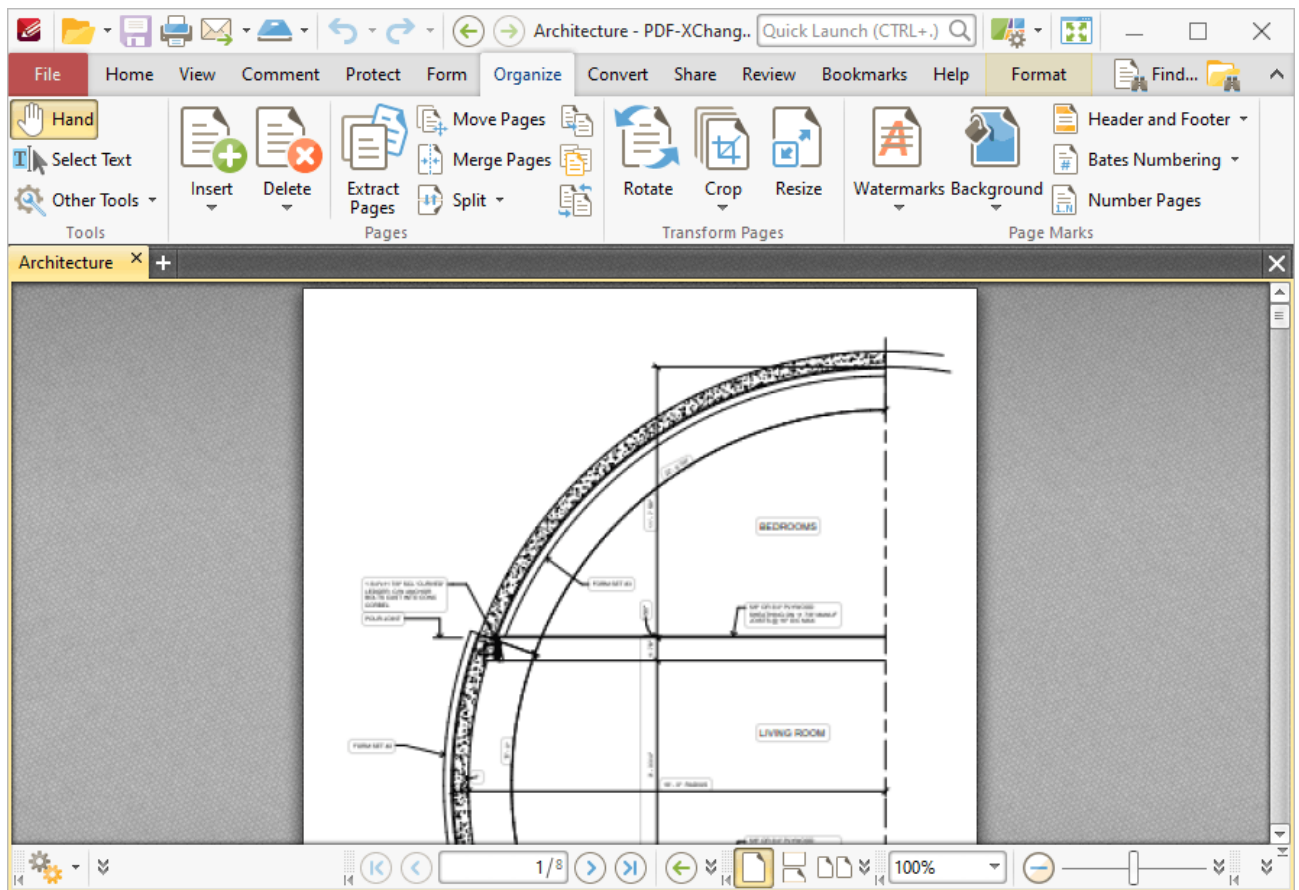
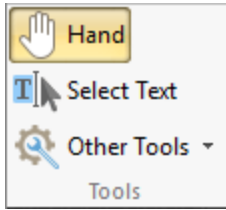

Figure 1. Organize Tab

The options in the **Organize** tab are used to edit and manipulate document pages. There are four groups in the **Organize** tab:

#### Tools

The **Tools** group contains shortcuts to tools and other features:



- The **Hand Tool** is used as a basic scrolling device and navigation aid when browsing through documents. Click to enable the **Hand Tool**, then click and drag the page in the desired scrolling direction in order to browse through documents. Further information about the **Hand Tool** and its settings is available [here](#).<sup>943</sup>
- The **Select Text Tool** is used to select base-content text. Click to enable the **Select Text Tool**, then click and drag the pointer to select text. Double-click to select words, triple-click to select paragraphs and quadruple-click to select all text on the current page. Right-click selections for editing options, as detailed [here](#).<sup>1651</sup>
- Click the **Other Tools** dropdown menu to view/select additional tool options:
  - The **Select Comments Tool** is used to select and edit comments. Click to enable the **Select Comments Tool**, then click to select comments. Click and drag to select multiple comments. Selected comments can be edited, as detailed [here](#).<sup>1087</sup>
  - The **Snapshot Tool** is used to take screenshots of pages/selected page content. Click to enable the **Snapshot Tool**, then click or click and drag to take snapshots. Further information about this tool is available [here](#).<sup>926</sup>
  - The options in the **Clipboard** dropdown menu is used to interact with the current content of the clipboard. Click the dropdown menu to cut/copy/paste clipboard content.
  - The **Find** feature is used to [Find](#)<sup>1688</sup> or [Search](#)<sup>1776</sup> text, or to search the internet for text selected with the **Select Text Tool** in the current document.

## Pages

The **Pages** group contains options for the manipulation of document pages:

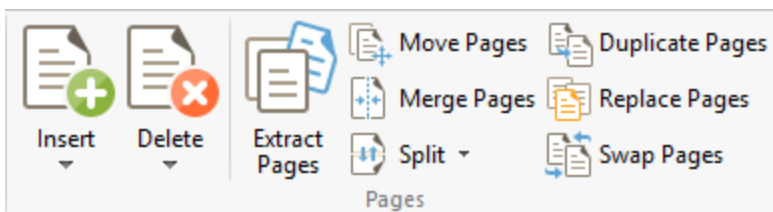

- Click **Insert** to view options for inserting pages into the document. These options are detailed [here](#).<sup>1451</sup>
- Click **Delete** to view options for deleting pages from documents. These options are detailed [here](#).<sup>1459</sup>



- Click **Extract Pages** to extract a specified page range of the document to a new document, as detailed [here.](#)<sup>1462</sup>
- Click **Move Pages** to move a specified page range to a new document location, as detailed [here.](#)<sup>1468</sup>
- Click **Duplicate Page** to duplicate document pages and insert them at a specified document location, as detailed [here.](#)<sup>1465</sup>
- Click **Merge Pages** to merge split pages, as detailed [here.](#)
- Click **Replace Pages** to replace document pages with pages from other documents, as detailed [here.](#)<sup>1470</sup>
- Click the **Split** dropdown menu to view splitting options for the current page/document:
  - Click **Split Document** to split the current document into smaller documents, as detailed [here.](#)<sup>1473</sup>
  - Click **Split Pages** to split the pages of the current document, as detailed [here.](#)<sup>1473</sup>
- Click **Swap Pages** to switch the location of two pages in the current document, as detailed [here.](#)<sup>1477</sup>

## Transform Pages

The **Transform Pages** group contains options for editing the pages of the current document:

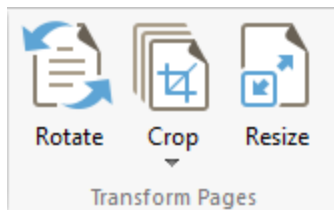

- Click **Rotate** to rotate the pages of the current document, as detailed [here.](#)<sup>1482</sup>
- Click **Crop** to crop the pages the current document, as detailed [here.](#)<sup>1484</sup>
- Click **Resize** to resize the pages of the current document, as detailed [here.](#)<sup>1488</sup>

## Page Marks

The **Page Marks** group contains options for creating and editing additional page elements:

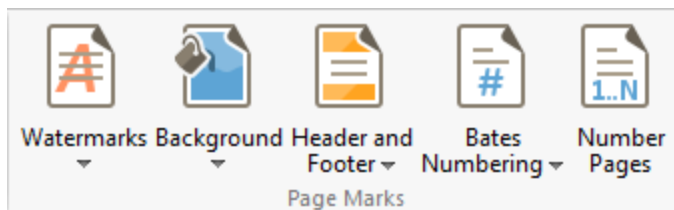

- Click the **Watermarks** dropdown menu, then click **Add**, **Remove All** or **Manage** to perform these operations on watermarks, as detailed [here.](#)<sup>1491</sup>

- Click the **Background** dropdown menu, then click **Add, Remove All** or **Manage** to perform these operations on backgrounds, as detailed [here](#).<sup>1494</sup>
  - Click the **Header and Footer** dropdown menu, then click **Add, Remove All** or **Manage** to perform these operations on headers and footers, as detailed [here](#).<sup>1497</sup>
  - Click the **Bates Numbering** dropdown menu, then click **Add, Add to Multiple Files, Remove All** or **Manage** to perform these operations on watermarks, as detailed [here](#).<sup>1500</sup>
  - Click **Number Pages** to assign new labels to pages, as detailed [here](#).<sup>1504</sup>
-

10.4.7.1 Insert



Insert

Click **Insert** to view page insertion options:

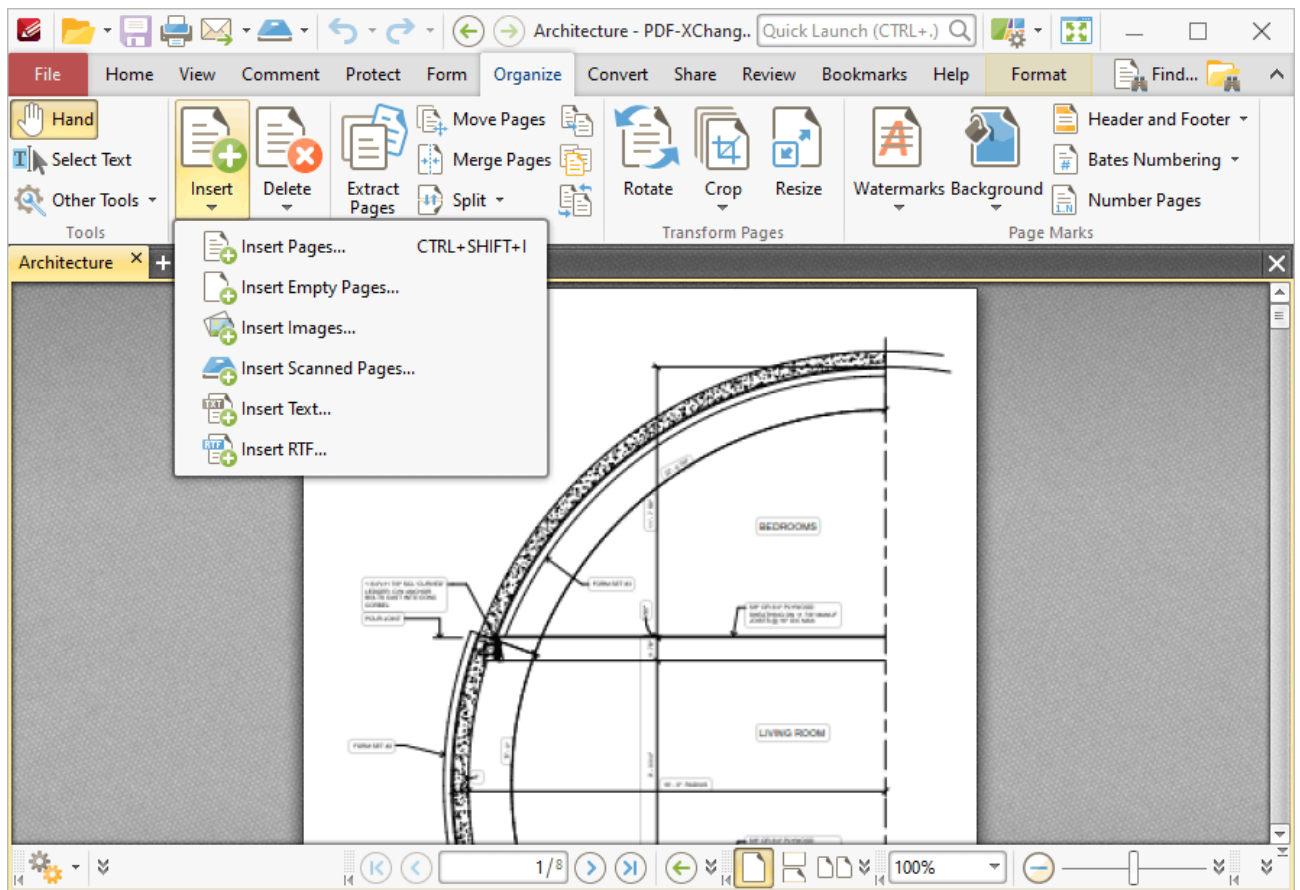

Figure 1. Organize Tab, Insert

Click **Insert Pages** to insert pages into the active document:

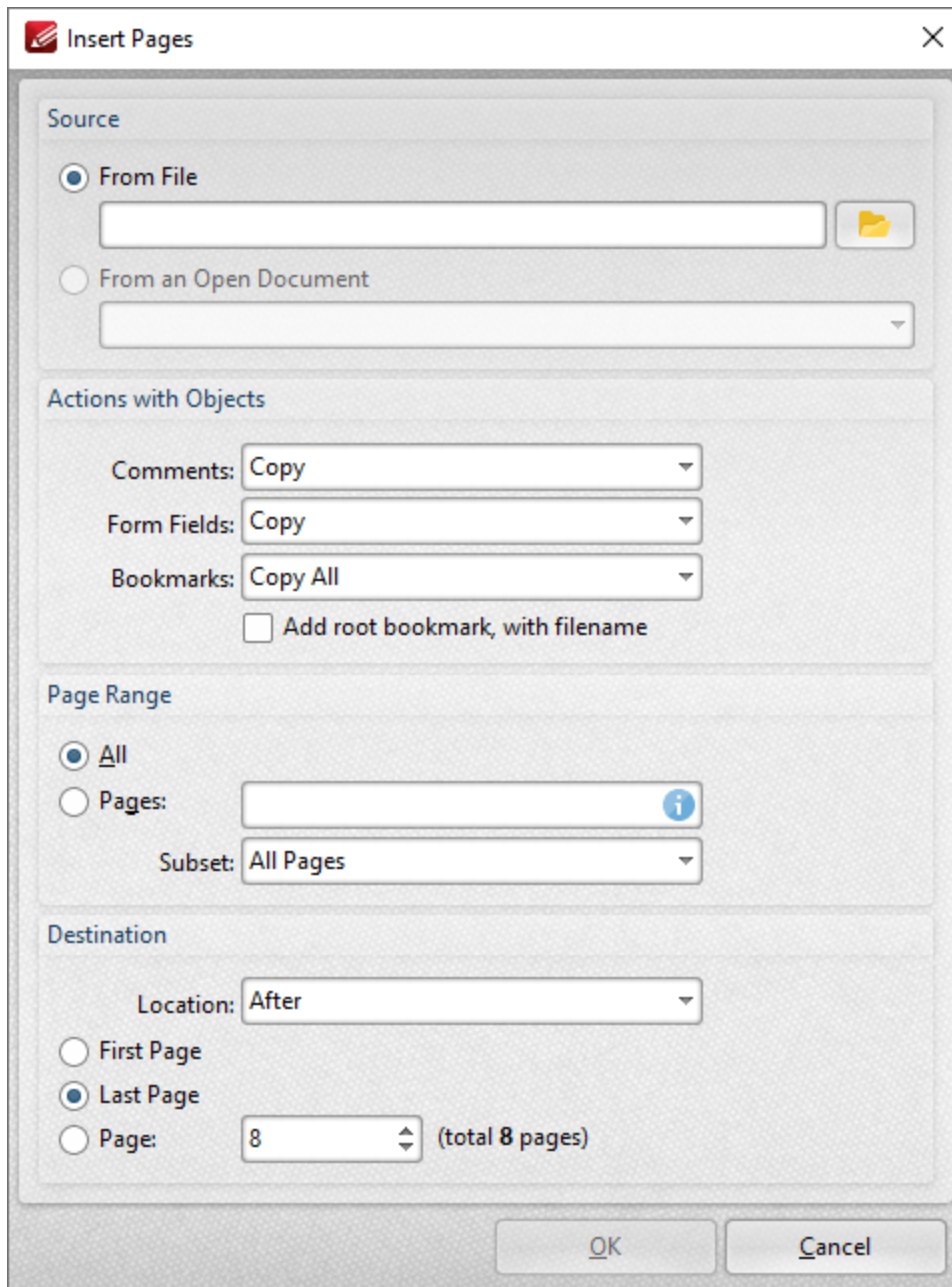

Figure 2. Insert Pages Dialog Box

- Select **From File** to insert pages from a file into the active document. Alternatively, select **From an Open Document** to insert pages from an open document.
- Use the **Actions with Objects** options to determine the action taken for **Comments**, **Form Fields** and **Bookmarks** contained in the inserted pages.
- Select the **Add root bookmark, with file name** box to create a root bookmark from inserted pages.
- Use the **Page Range** options to determine which pages are inserted:
  - Select **All** to insert all pages.

- Use the **Pages** number box to specify individual pages, separated with a comma, and/or page ranges, separated with a hyphen. See [here](#) for further information.
- Use the **Subset** dropdown menu to select **All Pages**, **Odd Pages** or **Even Pages** as desired.
- Use the **Destination** options to determine the location at which the new pages are inserted.

Click **OK** to insert pages.

Click **Insert Empty Pages** to insert empty pages into the active document:

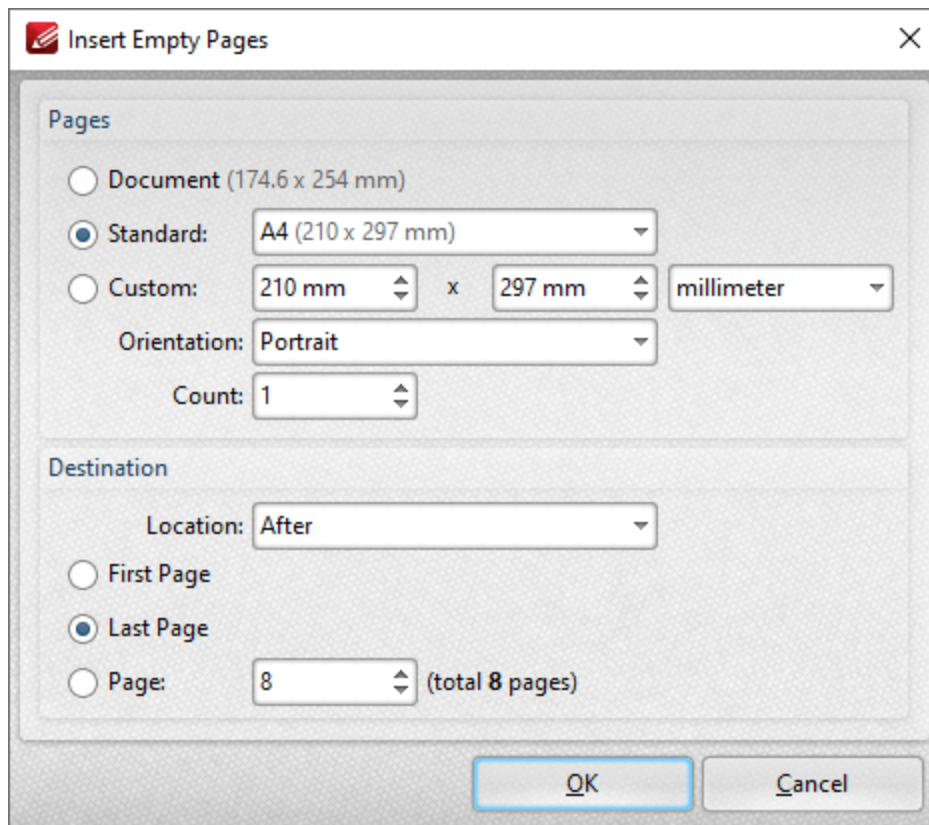

Figure 3. Insert Empty Pages Dialog Box

- Select an option in the **Pages** section to determine the dimensions of new pages:
  - Select **Document** to match the dimensions of the current document.
  - Select **Standard** to select a standard document size, such as those used by the **ISO** and **ANSI**.
  - Select **Custom** to enter custom dimensions. Enter the desired dimensions into the number boxes.
  - Select either **Portrait** or **Landscape** for the orientation of new pages.
  - Use the **Count** menu to determine the number of pages inserted.
- Use the **Destination** options to determine the location at which the new pages are inserted.

Click **OK** to insert the empty pages.

Click **Insert Images** to insert images into the active document:

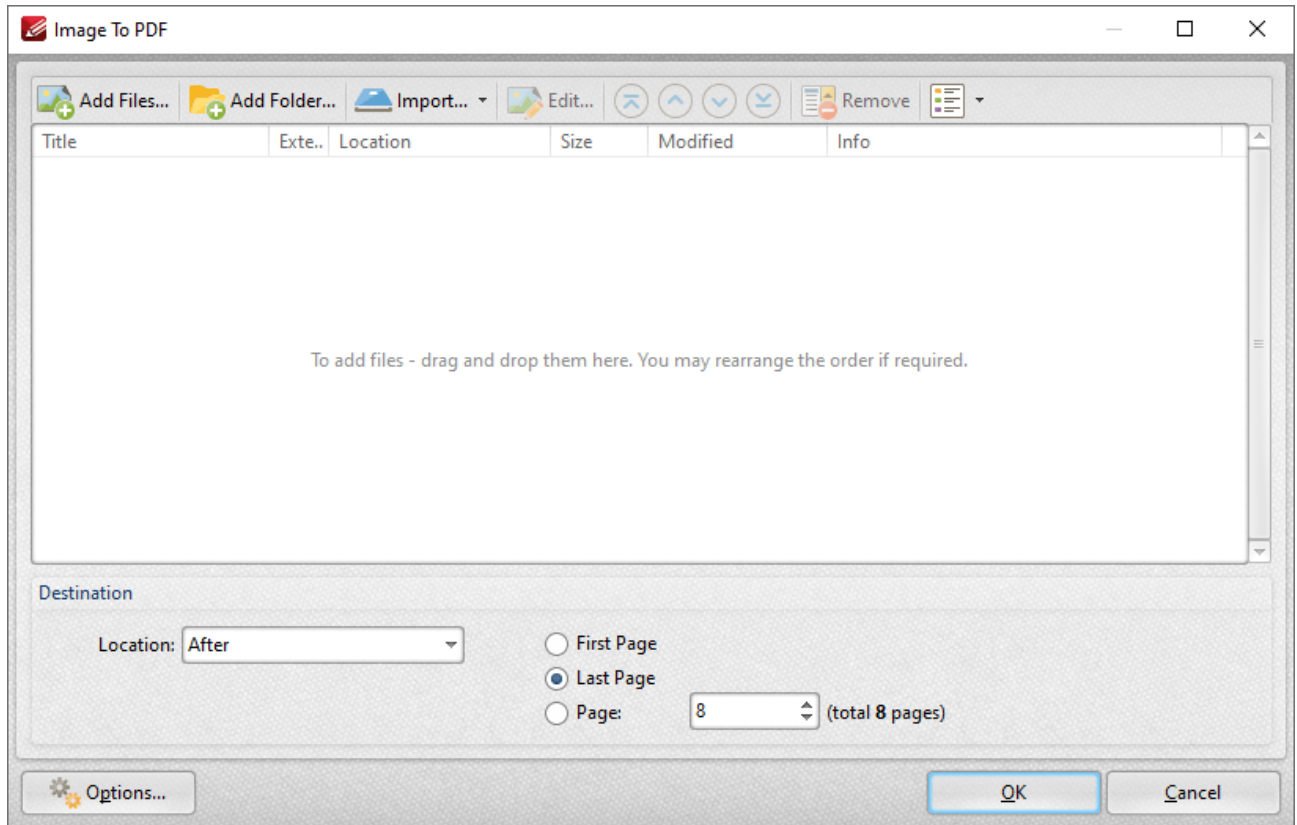

Figure 4. Images to PDF Dialog Box

- Click **Add Files** to add images to the list of source files.
- Click **Add Folder** to add folders of images to the list of source files.
- Click **Import** to add images from the local scanner. See [here](#)<sup>[829]</sup> for further details.
- Click **Edit** to edit selected images before insertion.
- Use the blue arrow icons to reorder images. The order of images in the **Image to PDF** dialog box determines the order in which images are inserted into the active document.
- Click **Remove** to remove selected images.
- Use the **Change View Mode** button to select **Details**, **Icons** or **Thumbnails** as the display mode of list items.
- Use **Destination** options to determine at which images are inserted.
- Click **Options** to determine the options for inserted images. See [here](#)<sup>[820]</sup> for further details.

Click **OK** to insert images.

Click **Insert Scanned Pages** to insert scanned pages into the active document:

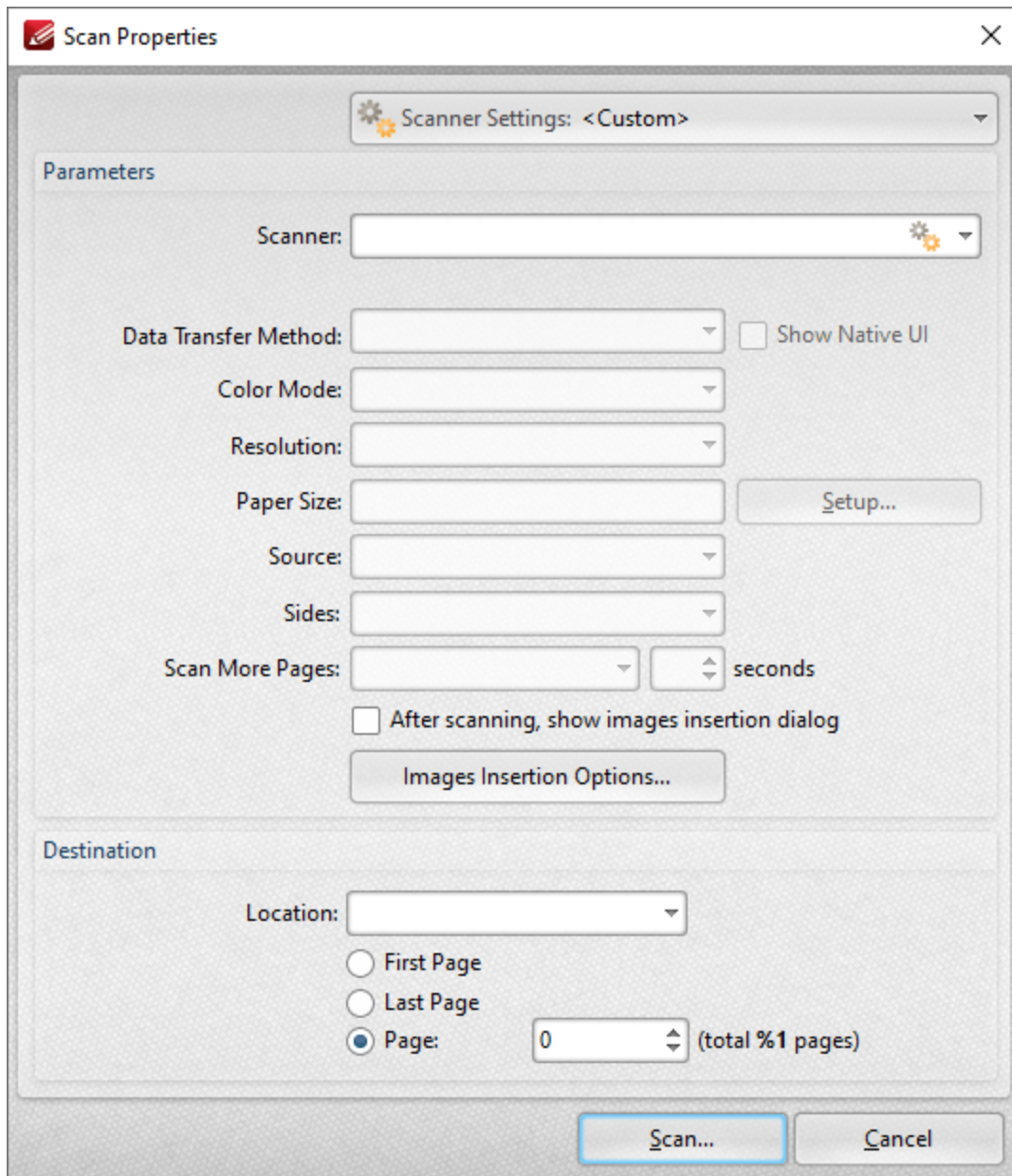



Figure 5. Scan Properties Dialog Box

- Click the **Scanner Settings** menu to select a preset scanning mode.
- Click the **Scanner** menu to select a scanner.
- Click the **Data Transfer Method** menu to select either **Native Mode** or **Memory Mode**:
  - **Native Mode** uses a single memory buffer. This is the default and fastest mode, and is compatible with the broadest range of scanners.
  - **Memory Mode** enables the use of multiple memory buffers. This is a useful function in cases where memory is low and/or when large images are scanned.
- The **Show Native UI** box is selected by default, which means the user interface of the device driver is used. This is the most reliable option, and the scanner will select

certain parameters of the scan itself: **Color Mode**, **Resolution**, **Paper Size** and **Source**. Clear the **Show Native UI** box to customize these options:

- **Color Mode** has four options: **Auto detect**, **Color**, **Grayscale** and **Black & White**. These refer to the format of scanned documents.
- Click the **Resolution** menu to select the **DPI** (dots per inch) of scanned documents.
- **Paper Size** refers to the size of the paper used when scanning. Click **Setup** for further options:
  - **Automatic** set the paper size automatically.
  - **Standard** contains standard sizes such as those used by the **ISO** and **ANSI**.
  - **Custom** can be used to enter custom dimensions.
- **Source** has three options **Auto**, **Flatbed** and **Feeder**. These refer to the type of scanner used.
- Click **Sides** to determine which sides of documents are scanned. There are three options: **Simple Scan**, **Manual Duplex** and **Manual Duplex Reversed**. Click the dropdown arrow for an explanation of these options.
- Click **Scan More Pages** to determine when additional pages are scanned.
- Select the **After scanning, show images insertion dialog** box to view the images insertion dialog box after the scan has been performed. This enables the customization of images and image settings.
- Click **Images Insertion Options** to determine further options for images. These options are detailed [here](#).
- Use the **Destination** options to determine the location at which scanned pages are inserted.
- Please note that the **Save Current Settings** option in the **Scanner Settings** dropdown menu can be used to save customized settings.

Click **Scan** to scan images.

Click **Insert Text** to insert text files into the active document:



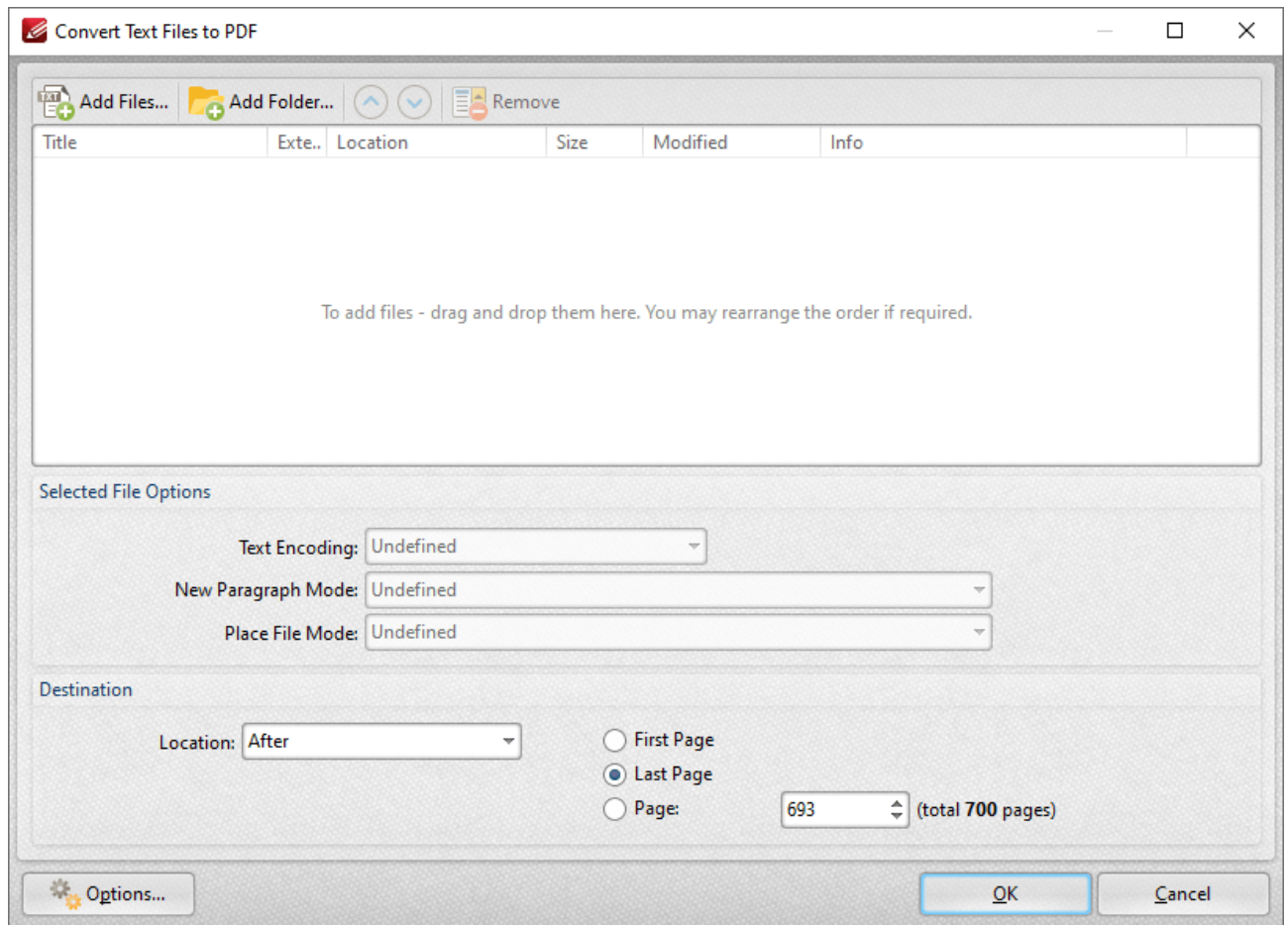

Figure 6. Convert Text Files to PDF Dialog Box

- Click **Add Files** to add text files to the list of source files.
- Click **Add Folder** to add all text files from a folder to the list of source files.
- Use the blue arrows to reorder files. The order of files in the list determines the order in which they are added to the document.
- Click **Remove** to remove selected files.
- Select files to enable the **Selected File Options**:
  - **Text Encoding** determines character encoding of text.
  - **New Paragraph Mode** determines how **PDF-XChange Editor** defines paragraphs in inserted text:
    - **Auto-Detect** searches for and identifies paragraphs automatically.
    - **Each newline character starts a new paragraph.** (A newline is a special character in computing that signifies the end of a line of text).
    - **Two newline characters start a new paragraph, single is ignored.**
    - **A double newline character starts a new paragraph, a single is converted to a space.**
  - **Place File Mode** determines how files are placed:
    - **Start each file from new paragraph** places each file in a new paragraph, and files can share the same page.

- **Start each file from new page** places each file in a new page.
- Use the **Destination** options to determine the location at which scanned pages are inserted.
- Click **Options** to determine the options for inserted text tiles, as detailed [here](#).

Click **OK** to insert text files.

Click **Insert RTF** to insert RTF files into documents:

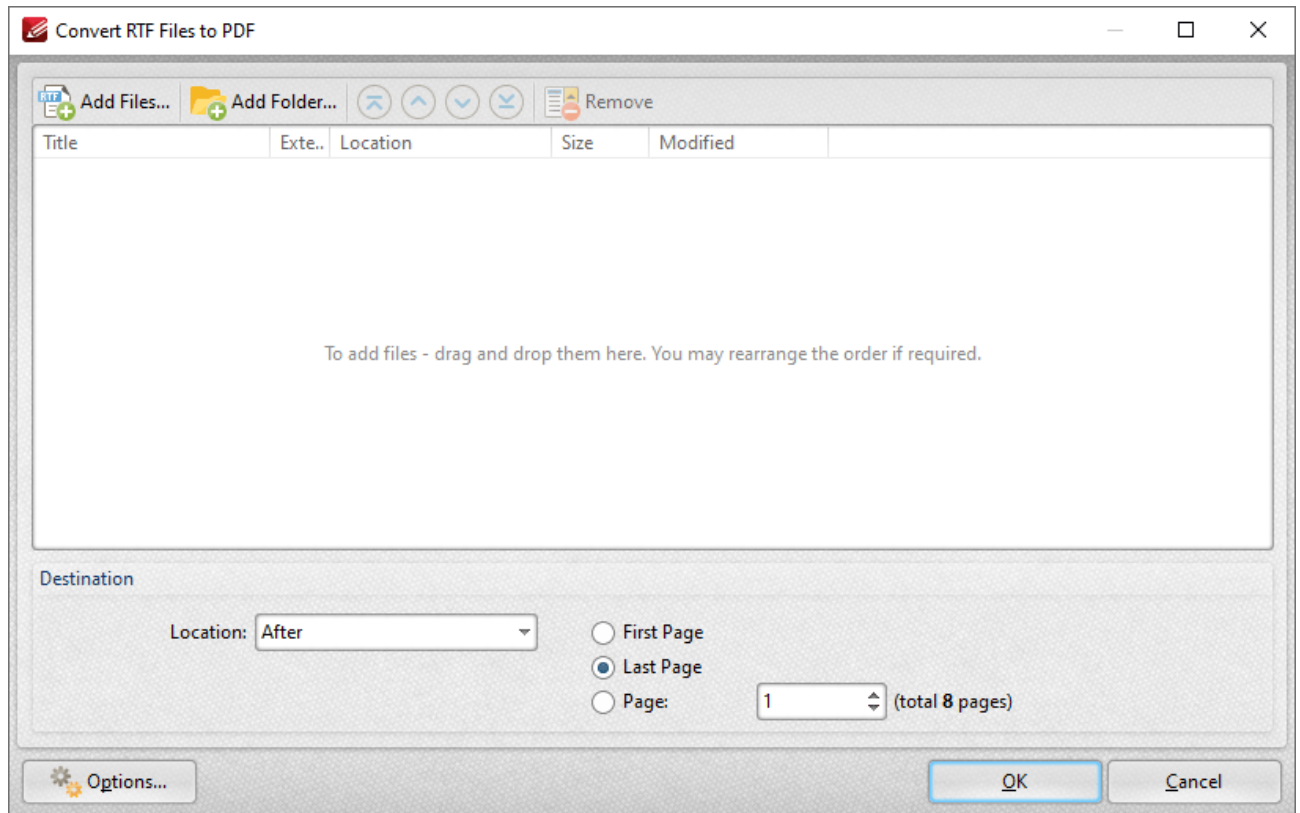

Figure 7. Convert RTF Files to PDF Dialog Box

- Click **Add Files** to add RTF files to the list of source files.
- Click **Add Folder** to add all RTF files from a folder to the list of source files.
- Use the blue arrows to reorder files. The order of files in the list determines the order in which they are added to the document.
- Click **Remove** to remove selected files.
- Use the **Destination** options to determine the location at which files are inserted.
- Click **Options** to determine the relative path options for inserted files.

Click **OK** to insert files.

---

10.4.7.2 Delete Pages



Delete Pages

Click **Delete** to view the **Delete** options for pages in the current document:

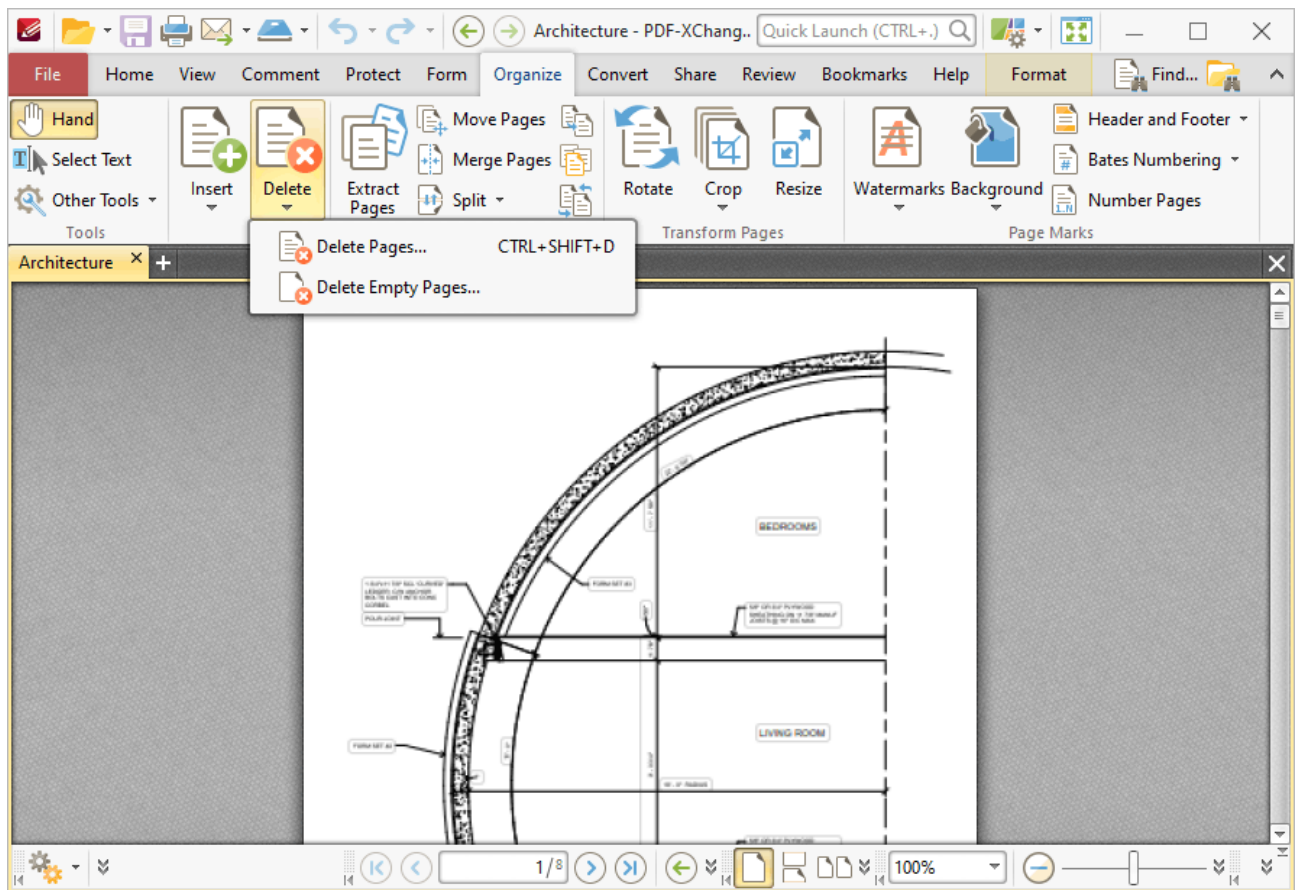

Figure 1. Organize Tab, Delete Pages Options

Click **Delete Pages** to delete document pages:

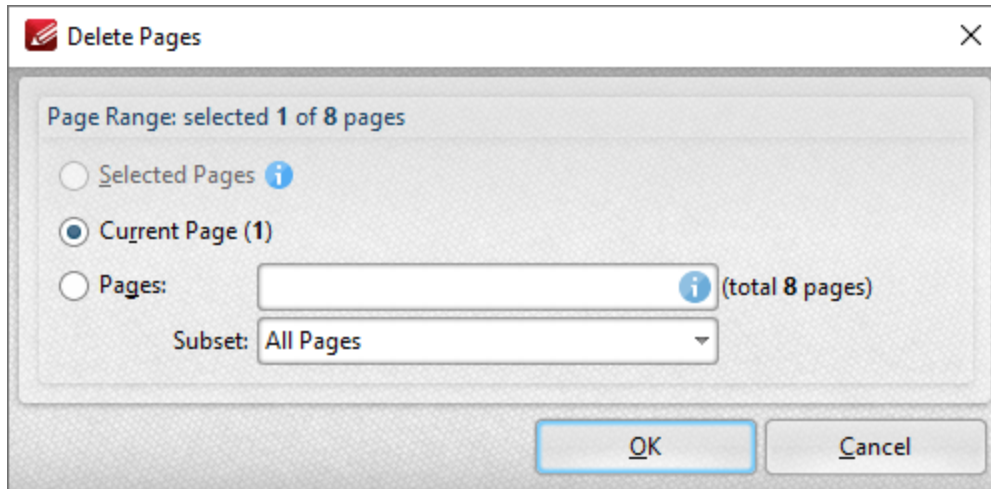

Figure 2. Delete Pages Dialog Box

- Select **Selected Pages** to delete the pages currently selected in the [Thumbnails](#) pane.
- Select **Current Page** to delete the current page in the main window.
- Select **Pages** to specify a page range for deletion. Further information on the specification of page ranges is available [here](#).
- Use the **Subset** menu to select a subset of the specified page range. Select **All Pages**, **Odd Pages Only** or **Even Pages Only** as desired.

Click **OK** to delete the pages.

Click **Delete Empty Pages** to delete empty document pages:

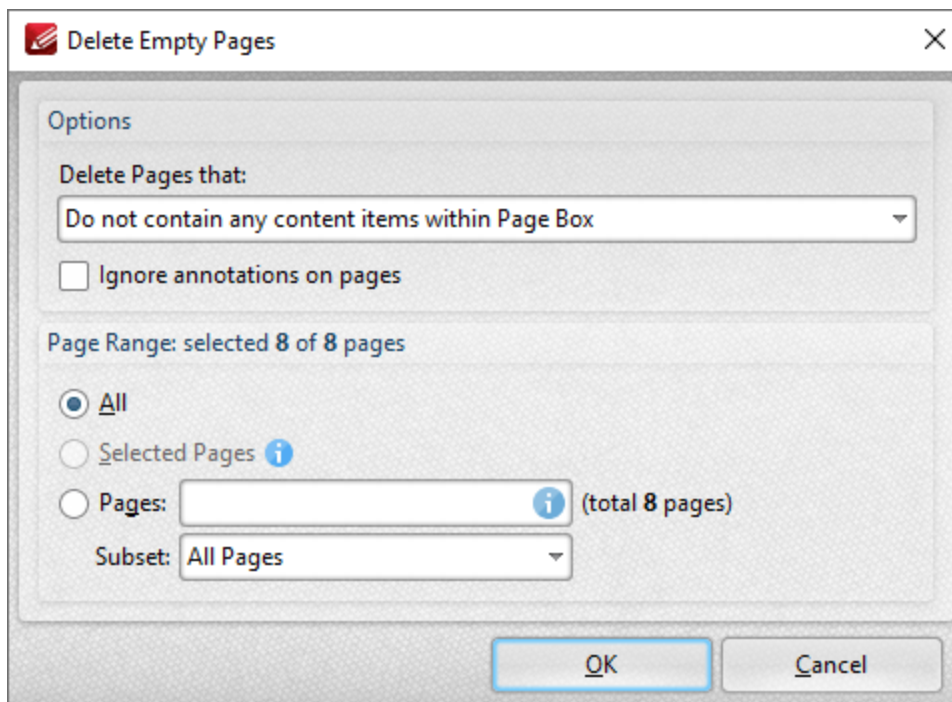

Figure 3. Delete Empty Pages Dialog Box

- Use the **Delete pages that:** dropdown menu to specify the deletion of specific types of pages:
  - Select **Do not contain any content items within Page Box** to delete only pages that do not contain content items in the page box of the document. The page box is defined as the intersection between the crop box and the media box, as detailed [here](#).<sup>1770</sup>
  - Select **Do not contain any content items** to delete only pages that do not contain content items.
  - Select **Have only a solid background** to delete pages that contain only a solid background.
- Select the **ignore annotations on pages** box to ignore annotations when **PDF-XChange Editor** decides which pages to delete.
- Use the **Page Range** options to determine the page range from which empty pages are deleted:
  - Select **All** to search all pages.
  - Select **Selected Pages** to search only the pages selected in the [Thumbnails](#).<sup>1000</sup> pane.
  - Use the **Pages** box to specify a page range. Further information on page range settings is available [here](#).<sup>1773</sup>
  - Use the **Subset** option to determine a subset of the specified page range.

Click **OK** to delete the pages.

---

### 10.4.7.3 Extract Pages



## Extract Pages

Click **Extract Pages** (or press Ctrl+Shift+E) to extract pages from the current document:

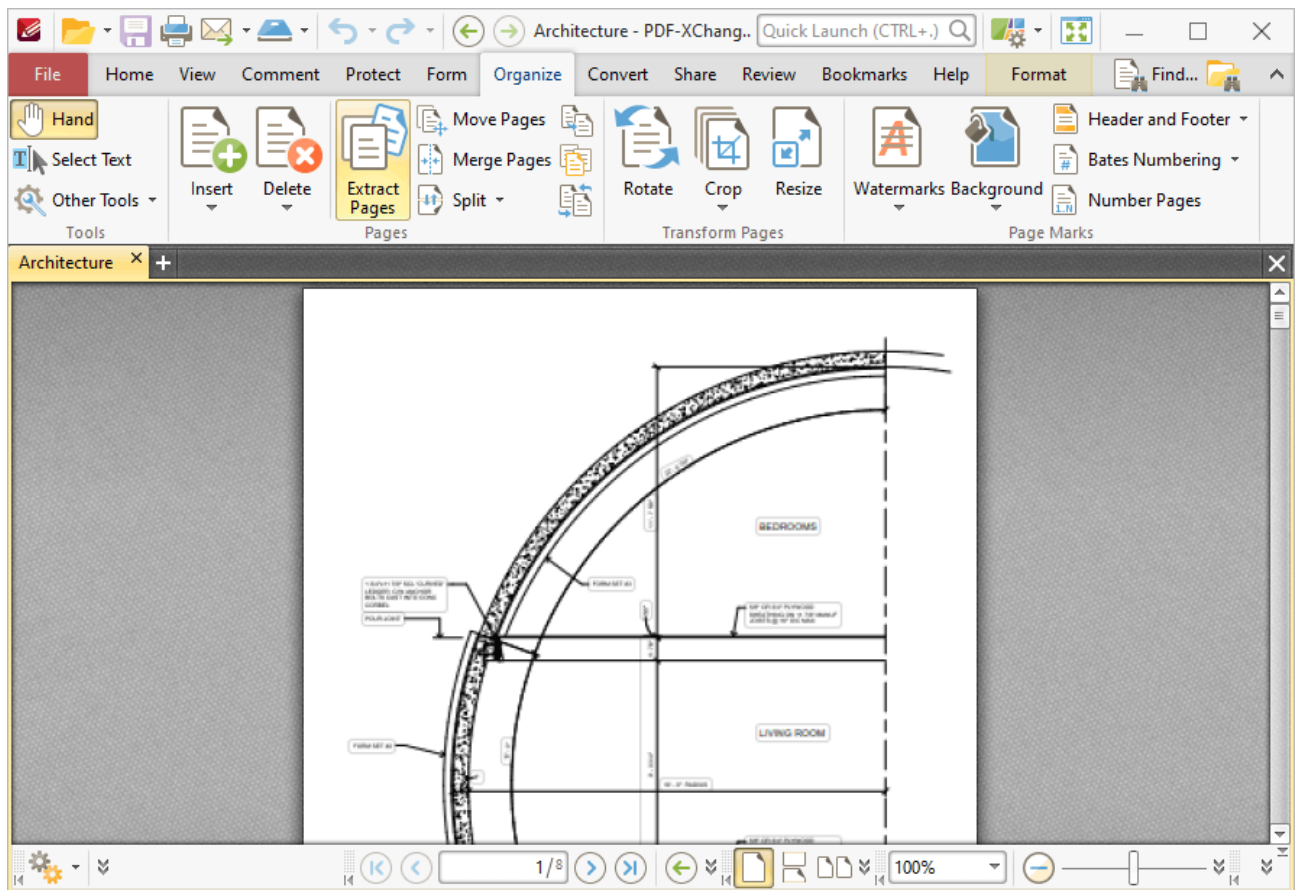

Figure 1. Organize Tab, Extract Pages

The **Extract Pages** dialog box will open:

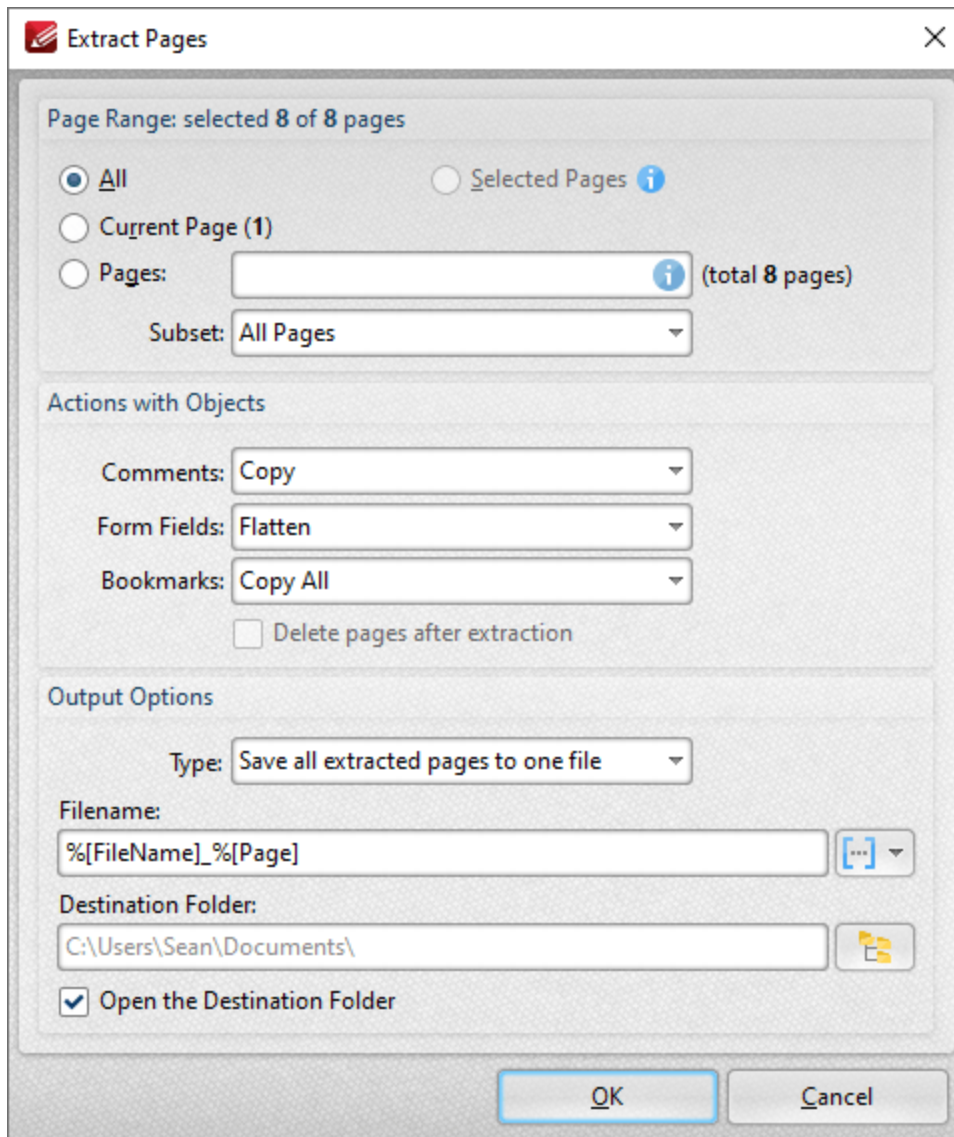



Figure 2. Extract Pages Dialog Box

- Use the **Page Range** settings to determine the page range of extracted pages:
  - Select **All** to extract all pages.
  - Select **Current Page** to extract only the page visible in the main window.
  - Select **Selected Pages** to extract the pages selected in the [Thumbnails pane](#).
  - Use the **Pages** text box to determine a specified page range. Page range settings are detailed [here](#).
  - Use the **Subset** dropdown menu to extract a subset of the specified page range.
- Use the **Actions with Objects** options to determine the action taken for **Comments**, **Form Fields** and **Bookmarks** contained in extracted pages.
- Select the **Delete pages after extraction** box to delete pages from the source document after they are extracted.
- Use the **Output Options** to determine how extracted pages are saved:

- Use the **Type** dropdown menu to determine the grouping of extracted pages. The options are:
  - **Extract all pages to a new document.**
  - **Save all extracted pages to one file.**
  - **Save each page to a separate file.**
  - **Save each pages range to a separate file.**
- Use the **Filename** text box to set a file name for extracted pages. Click the blue icon to use [macros](#).
- Use the **Destination Folder** text box to set the destination folder, or click the yellow icon to select a folder.
- Select the **Open the Destination Folder with Result Files** box to open the destination folder when the operation is complete.

Click **OK** to extract pages.

---



10.4.7.4 Duplicate Pages



Duplicate Pages

Click **Duplicate Pages** to duplicate document pages and insert them at a specified location in the current document:

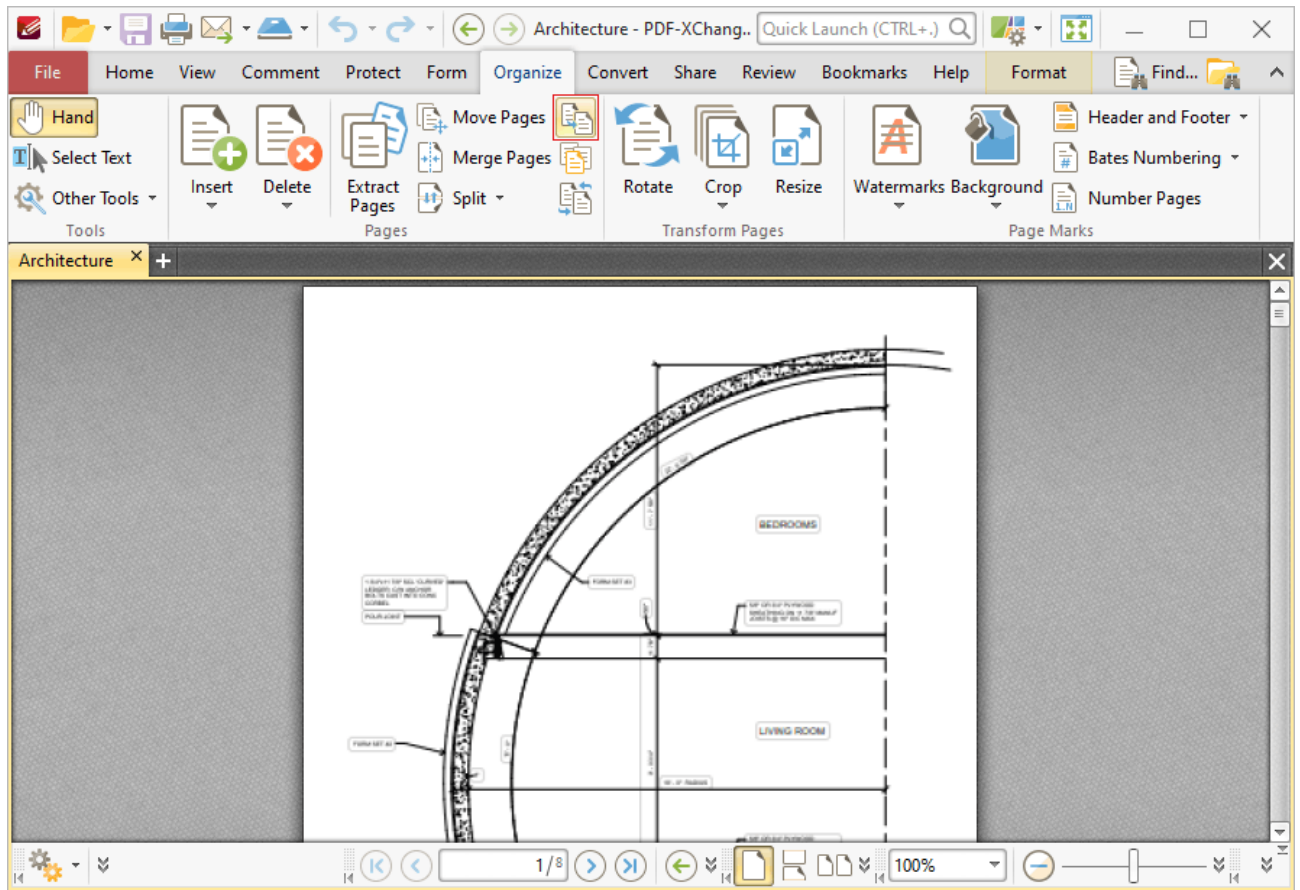

Figure 1. Organize Tab, Duplicate Pages

The **Duplicate Pages** dialog box will open:

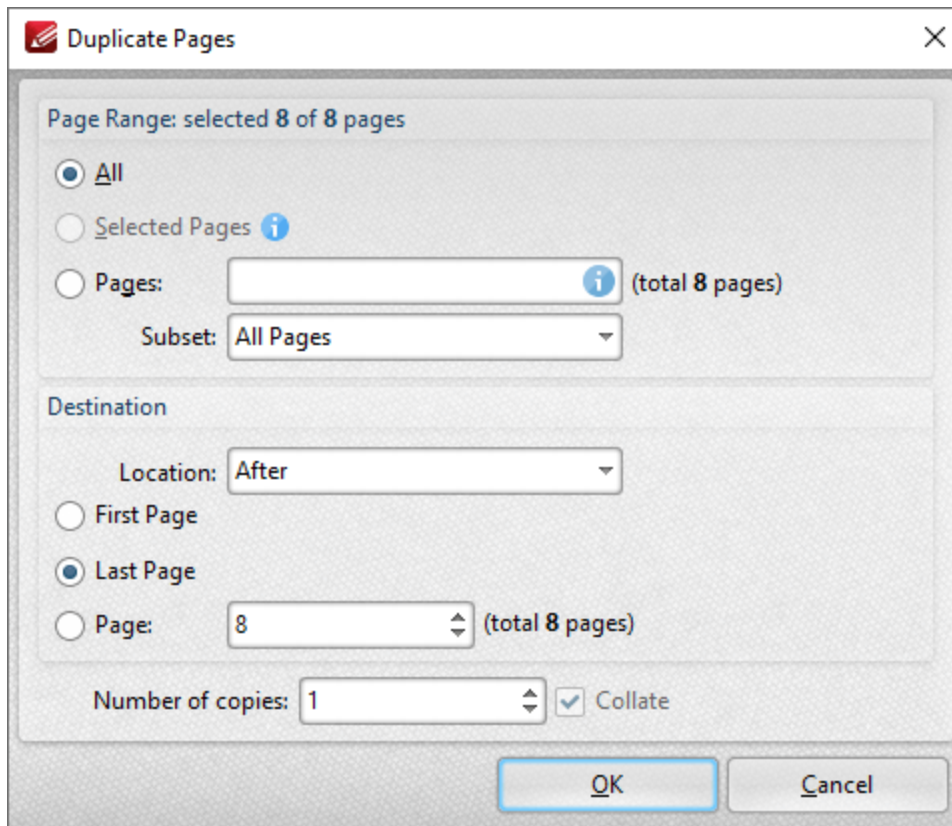

Figure 2. Duplicate Pages Dialog Box

Use the **Page Range** settings to determine which pages are duplicated:

- Select **All** to specify all pages.
- Select **Selected Pages** to specify the pages selected in the [Thumbnails](#) pane.
- Select **Pages** to specify a custom page range. Further information on defining page ranges is available [here](#). Use the **Subset** dropdown menu to specify a subset of page ranges. Select **All Pages**, **Odd Pages Only** or **Even Pages Only** as desired.

Use the **Destination** settings to determine the insertion location of duplicated pages:

- Select either **Before** or **After** in the **Location** dropdown menu.
- Select **First Page** or **Last Page** as desired. Alternatively, select **Page** to specify a different document page.
- Use the **Number of copies** dropdown menu to determine the amount of duplicates created.
- Select the **Collate** box to collate document pages. This is a useful feature when duplicating multiple copies of multi-page documents. It duplicates entire copies of documents together, as opposed to multiple copies of each page at a time.

Click **OK** to duplicate pages.



10.4.7.5 Move Pages



**Move Pages**

Click **Move Pages** to move a specified page range to a new document location:

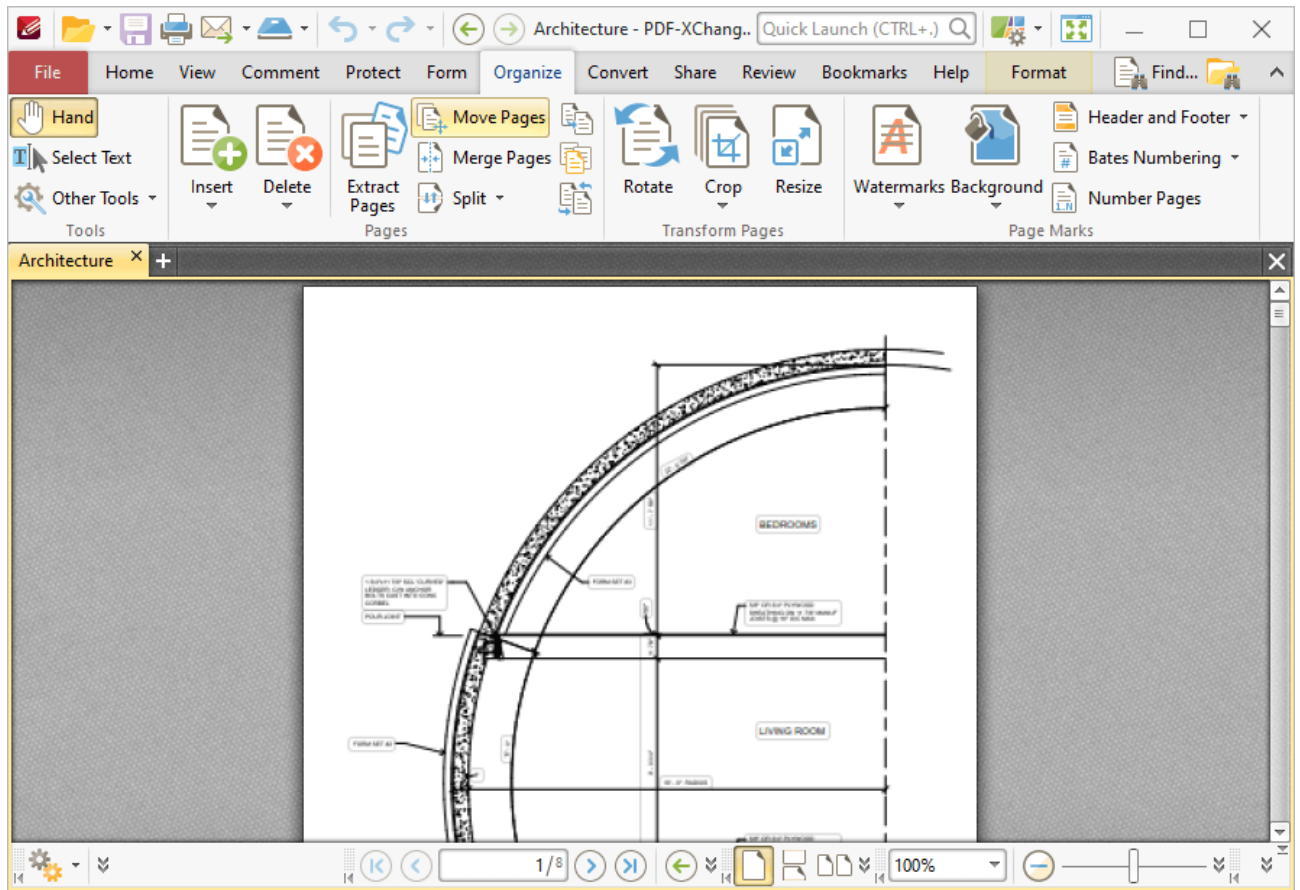

Figure 1. Organize Tab, Move Pages

The **Move Pages** dialog box will open:

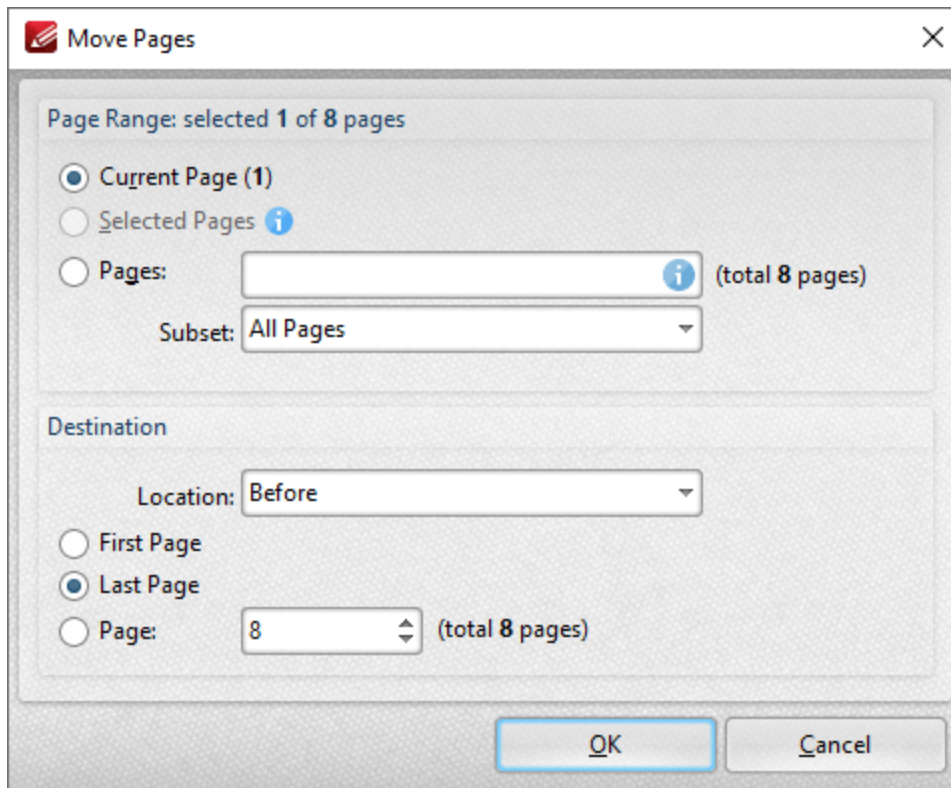

Figure 2. Move Pages Dialog Box

Use the **Page Range** settings to determine the page range of moved pages:

- Select **Current Page** to move the current page.
- Select **Selected Pages** to move the pages selected in the [Thumbnails](#) pane.
- Select **Pages** to specify a custom page range. Further information on defining page ranges is available [here](#). Use the **Subset** dropdown menu to specify a subset of page ranges. Select **All Pages**, **Odd Pages Only** or **Even Pages Only** as desired.

Use the **Destination** settings to determine the new location of the specified pages:

- Select either **Before** or **After** in the **Location** dropdown menu.
- Select **First Page** or **Last Page** as desired. Alternatively, select **Page** to specify a different document page.

Click **OK** to move pages.

---

### 10.4.7.6 Replace Pages



## Replace Pages

Click **Replace Pages** to replace document pages with pages from other documents:

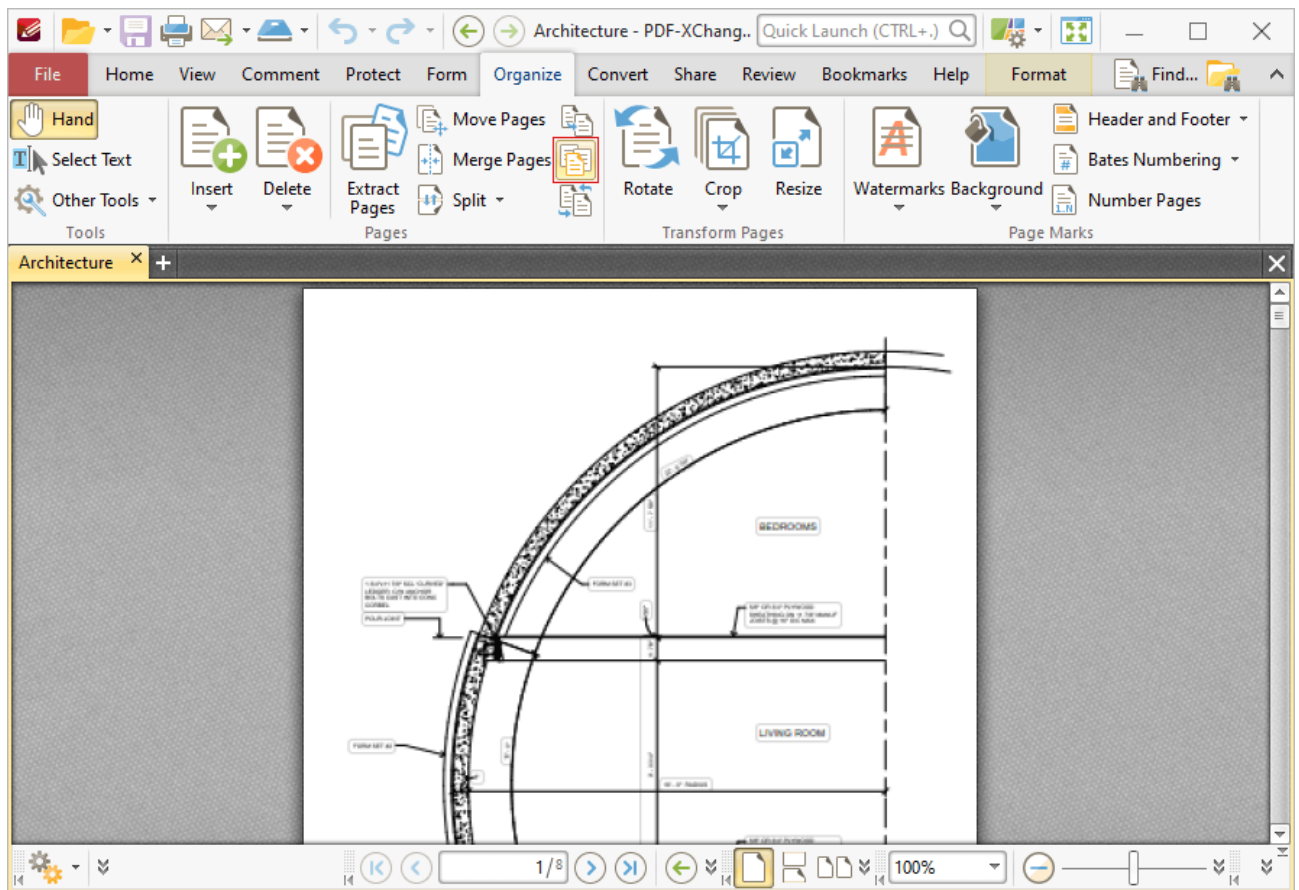

Figure 1. Organize Tab, Replace Pages

The **Replace Pages** dialog box will open:

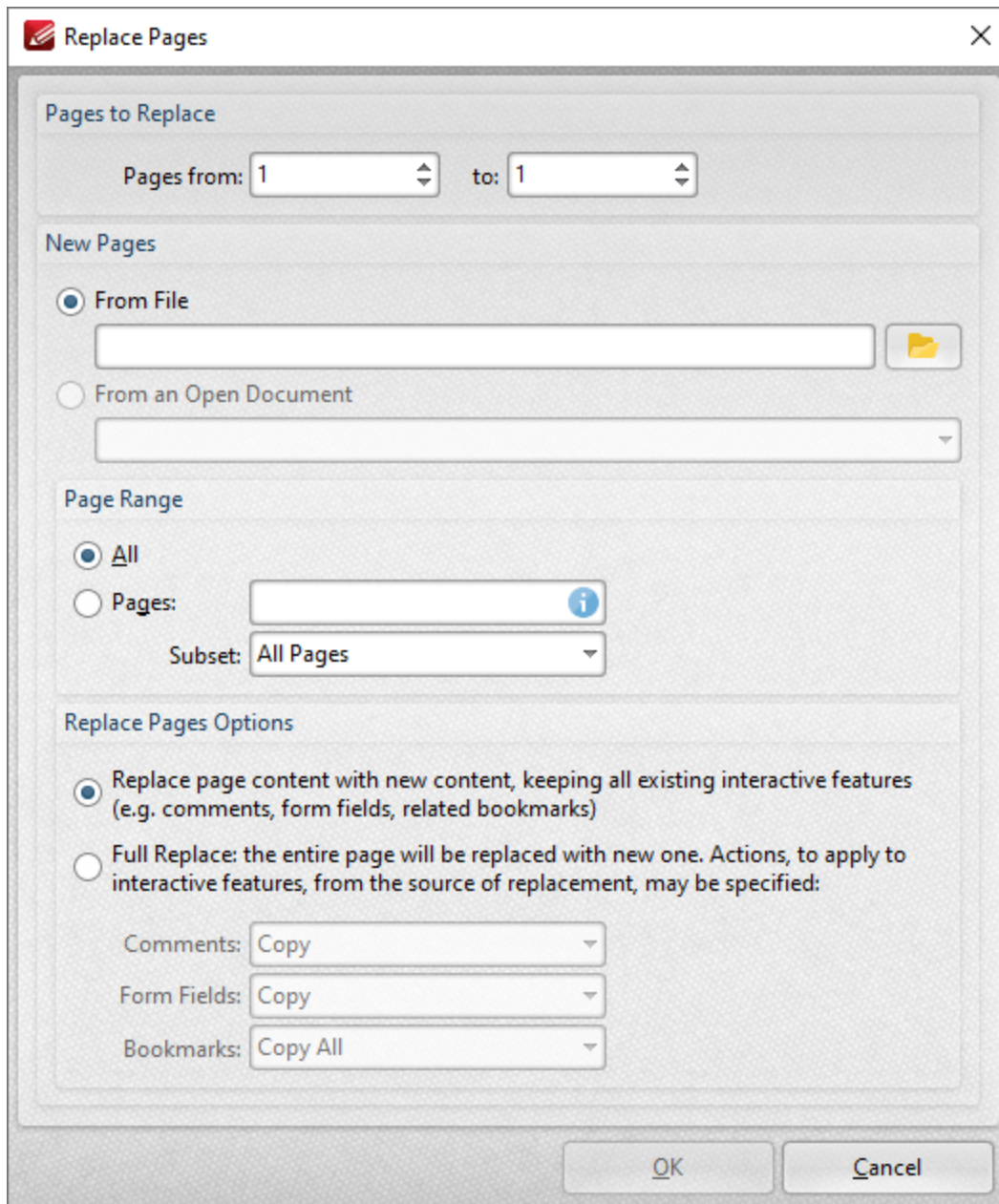

Figure 2. Replace Pages Dialog Box

- Enter the page numbers of the pages to be replaced in the **Page to Replace** number boxes.
- Select either **From File** or **From an Open Document** to determine the source of the replacement pages, then use the **Page Range** settings to determine the page range used. Further information on the specification of page ranges is available [here](#).<sup>1773</sup>
- Select a **Replace Pages Options** radio button to determine the parameters of the page replacement, as detailed in (*figure 2*). Use the dropdown menus to determine the action taken for **Comments**, **Form Fields** and **Bookmarks** in replacement files.

Click **OK** to replace pages.





### 10.4.7.7 Split Options



## Split Options

Click **Split** to view splitting options:

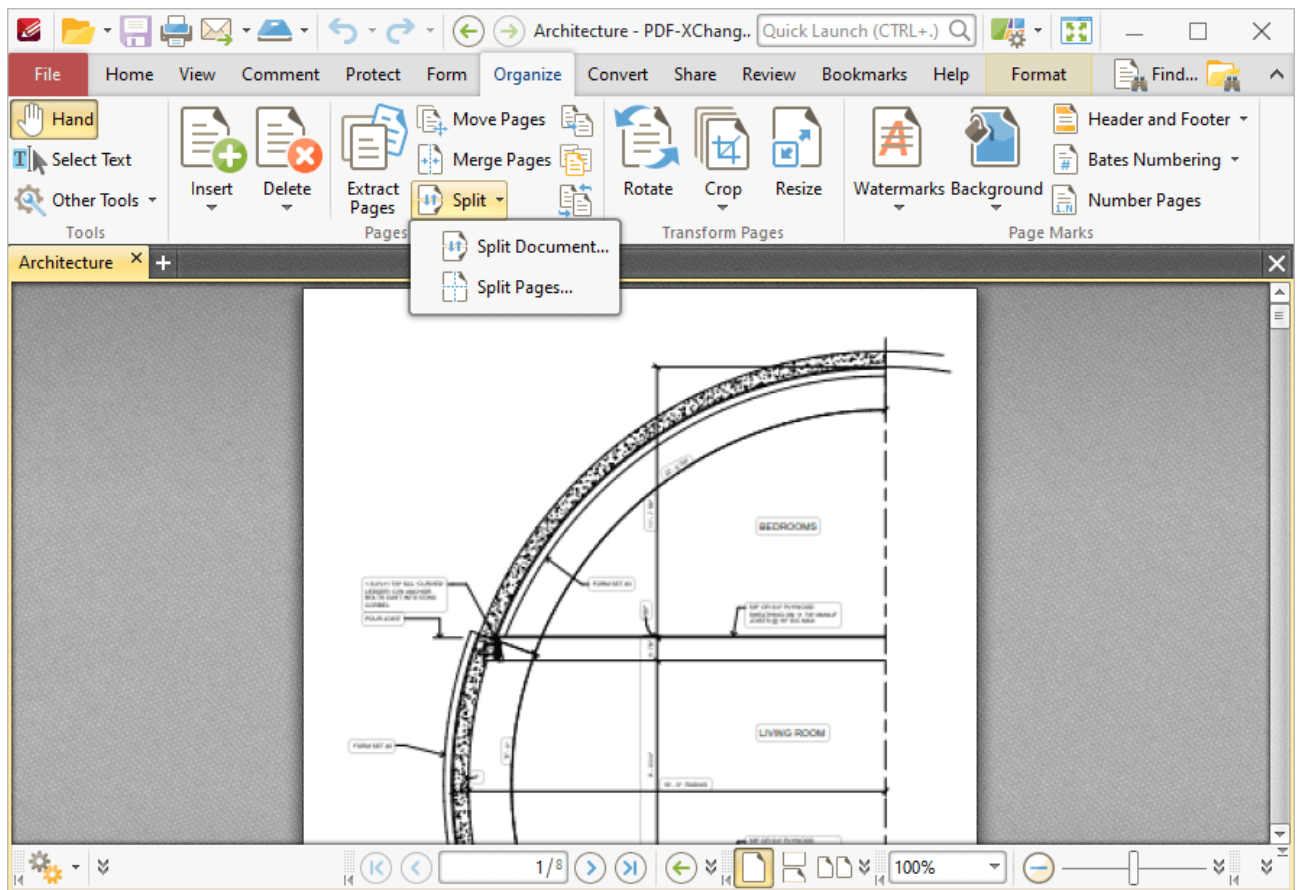

Figure 1. Organize Tab, Split Options

### Split Document

The **Split Document** feature is useful for the breaking down of one document into several smaller documents, such as books into chapters. Click **Split Document** to split the current document. The **Split Document** dialog box will open:

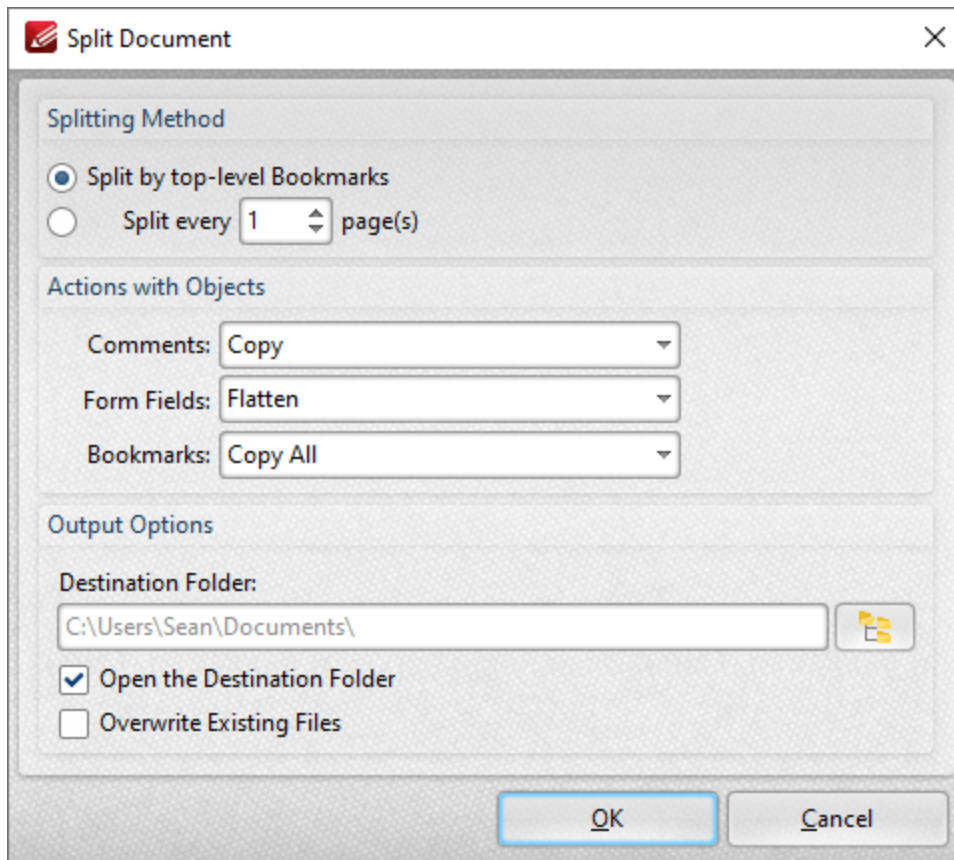

Figure 2. Split Document Dialog Box

- Select a **Splitting Method** to determine how the document is split:
  - Select **Split by top-level Bookmarks** to split the document according to its top-level bookmarks.
  - Select **Split by every  $n$  page(s)** to split the document every  $n$  pages. For example, enter the value '3' to place a split after every third page.
- Use the **Actions with Objects** options to determine the settings for objects in split documents.
- Use the **Output Options** to determine how split documents are saved:
  - Enter the name of the desired folder in the **Destination Folder** text box, or click the icon to select a folder.
  - Select the **Open the Destination Folder** box to open the destination folder when the process is complete.
  - Select the **Overwrite Existing Files** box to overwrite existing files that have the same name as those being saved. This is a useful feature when documents need to be split multiple times.

Click **OK** to split documents.

## Split Pages

The **Split Pages** feature is a convenient feature for splitting document pages into smaller sections. Click **Split Pages** to split the pages of the current document. The **Split Pages** dialog box will open:

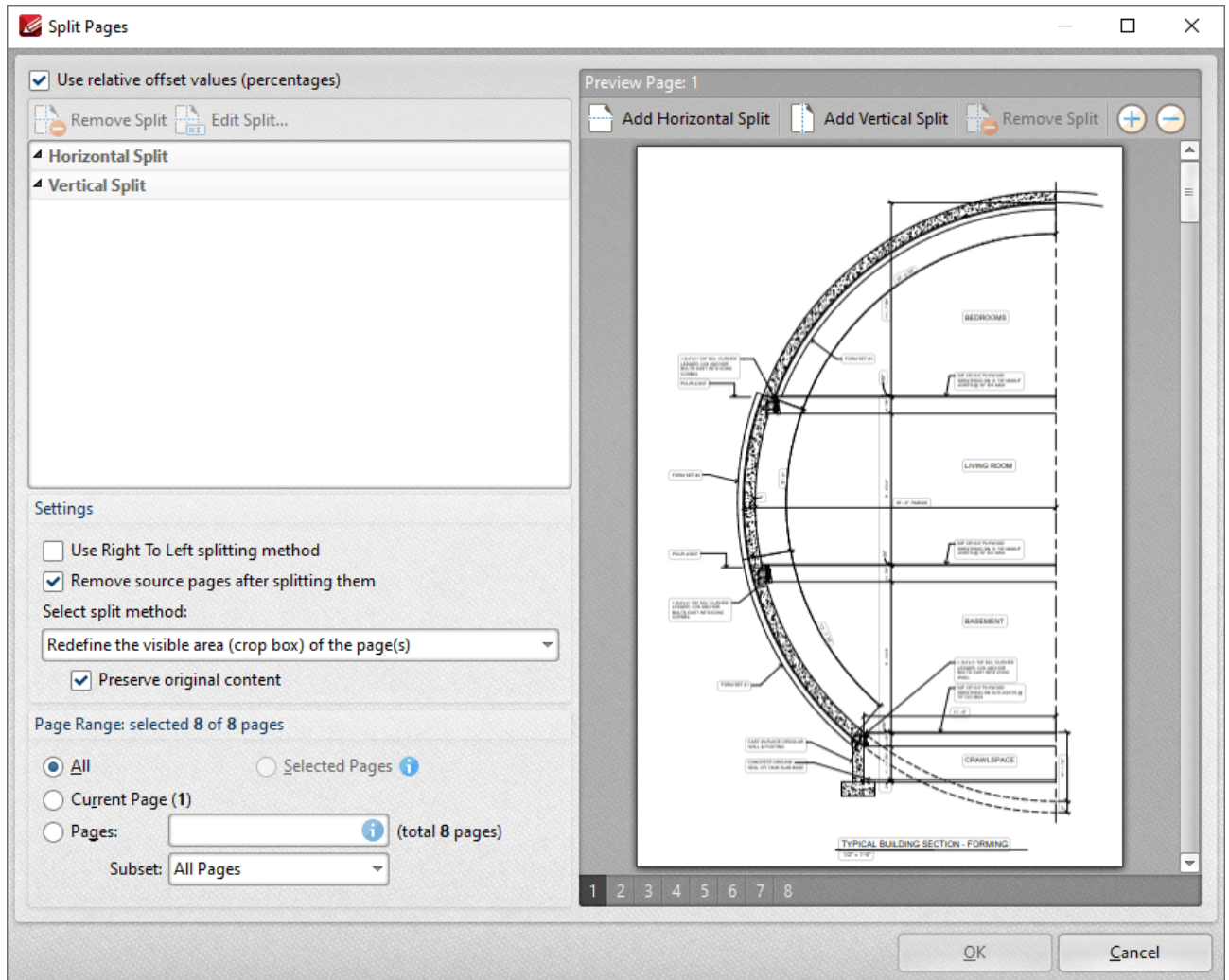

Figure 2. Split Pages Dialog Box

- Percentage is the default method used to split pages. Clear the **Use relative offset values** box to use metric measurements instead.
- Click **Add Horizontal Split** and/or **Add Vertical Split** at the top of the preview pane to add splits to documents. Splits are inserted at 50% by default and will appear in the preview pane and the list of splits when these options are used, as detailed above. Click and drag to reposition splits as desired.
- Use the plus and minus zoom icons to edit the view of the preview pane.
- Click **Edit Split/Remove Split** to edit/remove selected splits in the list of splits.
- Select the **Use Right To Left splitting method** box to split documents from right to left. Note that the order in which documents are split determines the order of sections in the split document.

- Select the **Remove source pages after splitting them** to remove the original document from the active pane when pages are split. If this box is cleared then both the original document and the split pages will be present after pages are split.
- Select an option from the **Select split method** dropdown menu to determine the method used to split documents:
  - **Change the physical size of the pages** adjusts the size of pages in order to split them.
  - **Redefine the visible area (crop box) of the pages** adjusts the crop box of pages. Further information about the crop box and other page boxes is available [here](#).<sup>1770</sup> When this option is used the **Preserve original content** box is available. If this option is enabled then the visible page area will be reduced, but the cropped content will remain available and be present if, for example, pages are resized subsequently.
- The **Page Range** settings are as follows:
  - Select **All** to split all the pages of the document.
  - Select **Current Page** to split only the current page.
  - Use the **Pages** box to determine specific pages of the document to be split. Further information on defining page ranges is available [here](#).<sup>1773</sup> Use the **Subset** option to select **All Pages**, **Odd Pages Only** or **Even Pages Only** for page ranges specified in the **Pages** number box.

Click **OK** to split pages.

---

10.4.7.8 Swap Pages



Swap Pages

Click **Swap Pages** to swap the location of two document pages:

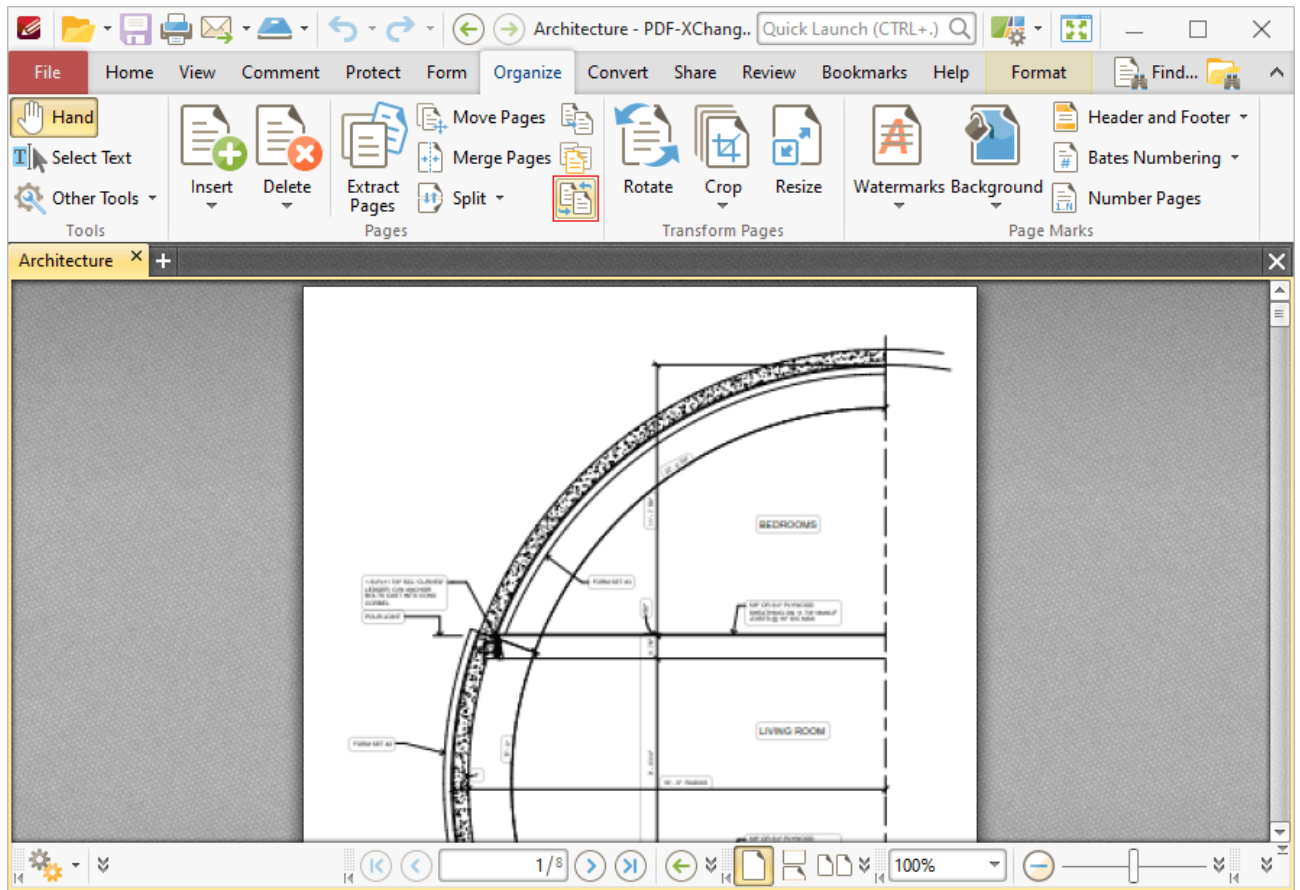
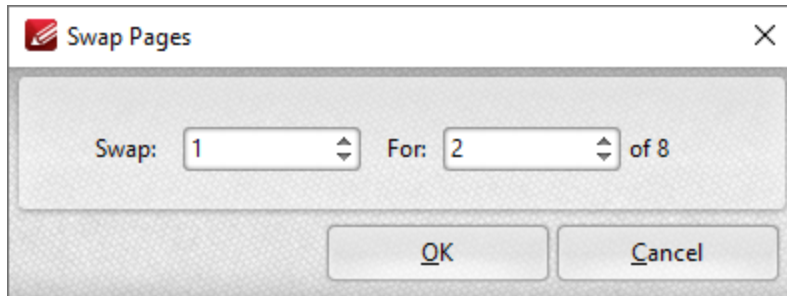

Figure 1. Organize Tab, Swap Pages

The **Swap Pages** dialog box will open:



**Figure 2.** Swap Pages Dialog Box

Enter the page numbers of the pages to be swapped and then click **OK** to swap pages.

---

### 10.4.7.9 Merge Pages



## Merge Pages

Click **Merge Pages** to merge document pages:

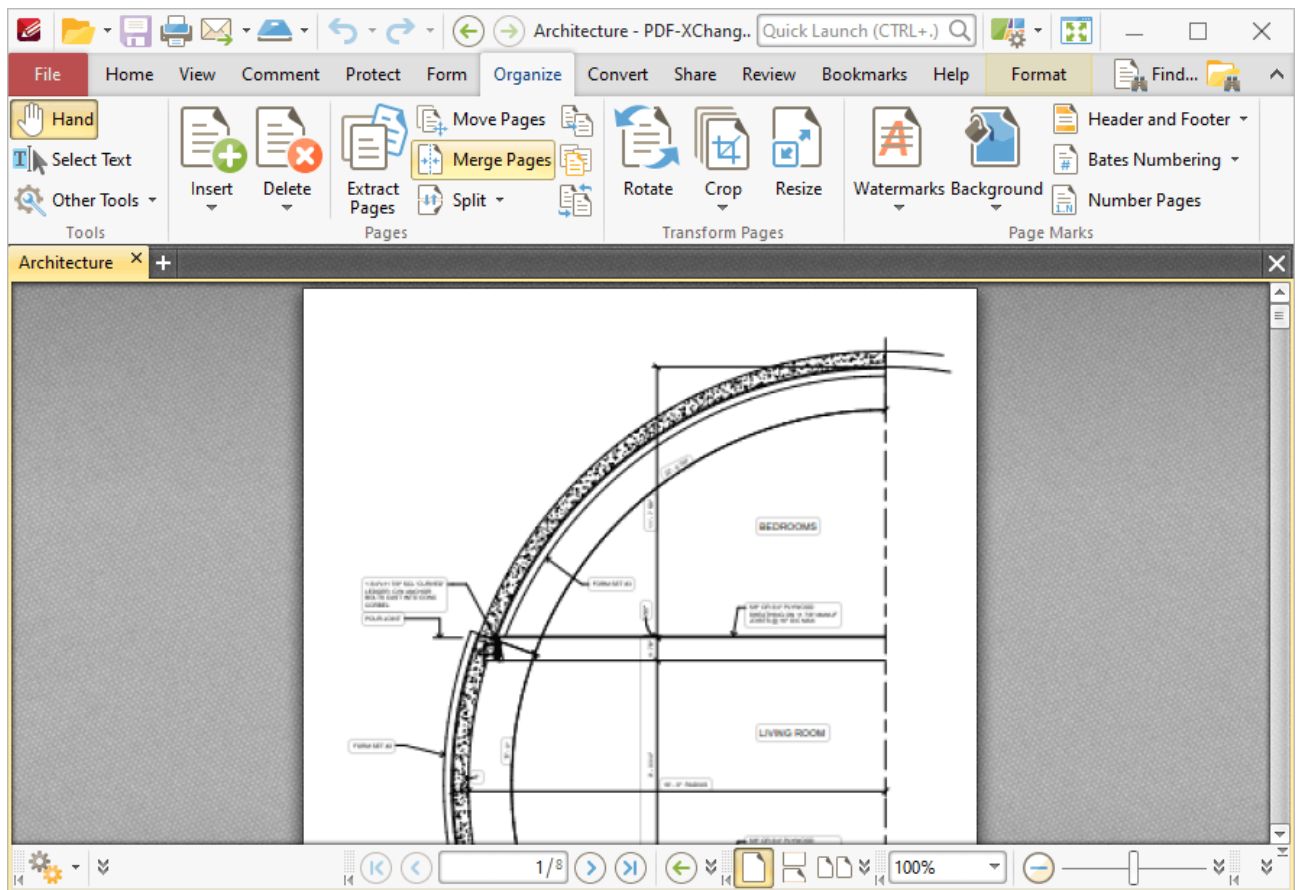

Figure 1. Organize Tab, Merge Pages

The **Merge Pages** dialog box will open:

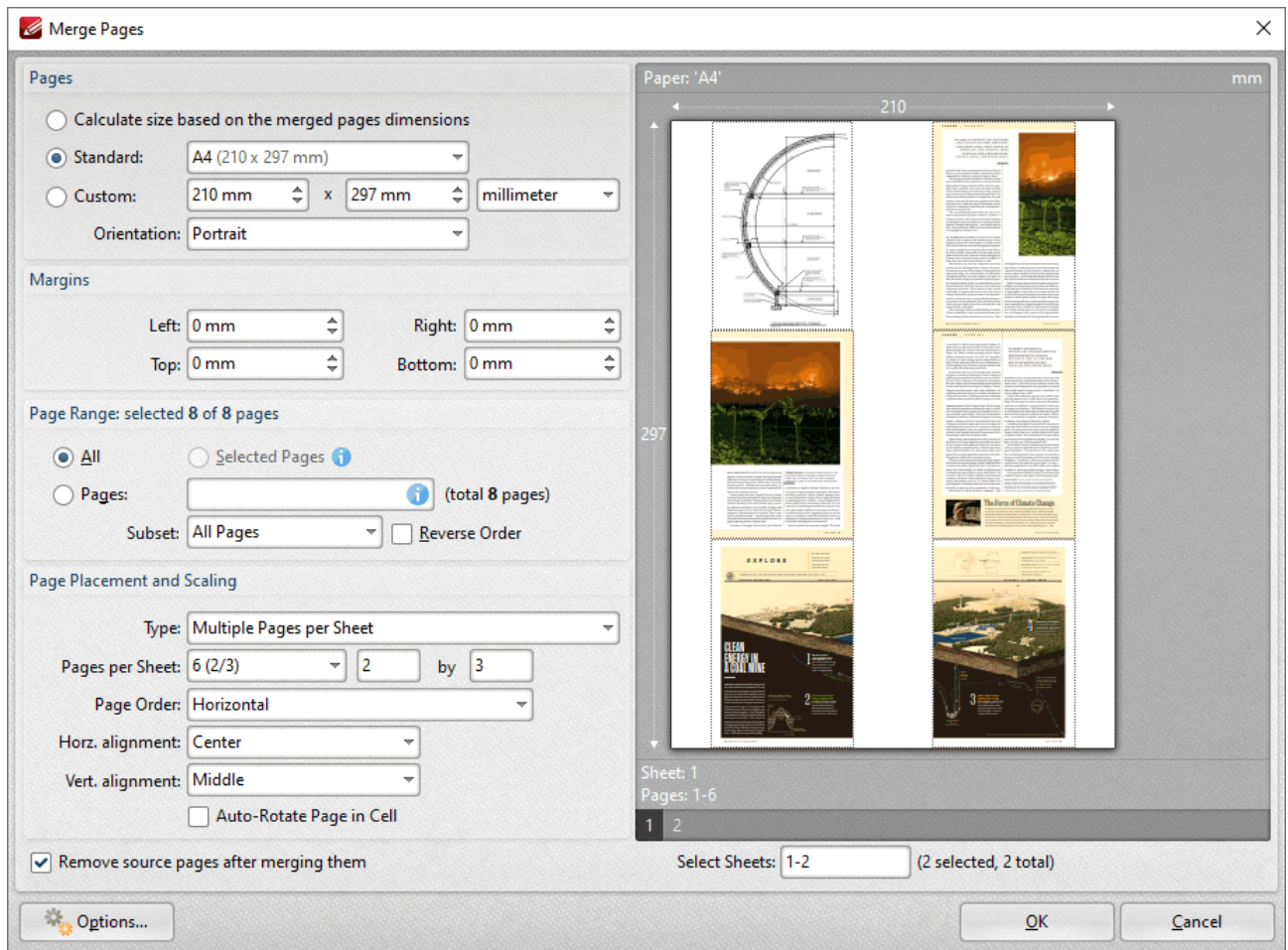

Figure 2. Merge Pages Dialog Box

- Use the **Pages** options to determine the size of the new page:
  - Click **Calculate Size based on the merged pages dimensions** to retain the size of the source pages in the output document.
  - Click **Standard** to use a standard page size for the output document, then select an option in the dropdown menu.
  - Click **Custom** to use a custom page size for the output document, then enter the measurements in the combo boxes and select a unit of measurement as desired.
  - Use the **Orientation** dropdown menu to determine the orientation of the output document.
- Use the **Margins** number boxes to determine the margins of the output document.
- Use the **Page Range** options to determine the page range of the source document used to create the output document:
  - Click **All** to include all pages.
  - Click **Select Pages** to use the pages currently selected in the **Thumbnails** pane.
  - Click **Pages** to specify a custom page range, then enter the desired range in the box. Information on the specification of page ranges is available [here](#).<sup>1773</sup>



- Use the **Page Placement and Scaling** options to determine how source pages are placed in the output document, as detailed in the preview pane when settings are edited.
- Select/clear the **Remove source pages after merging them** box as desired.

Click **OK** to merge pages.

---

10.4.7.10 Rotate Pages



**Rotate Pages**

Click **Rotate** (or press Ctrl+Shift+R) to rotate document pages:

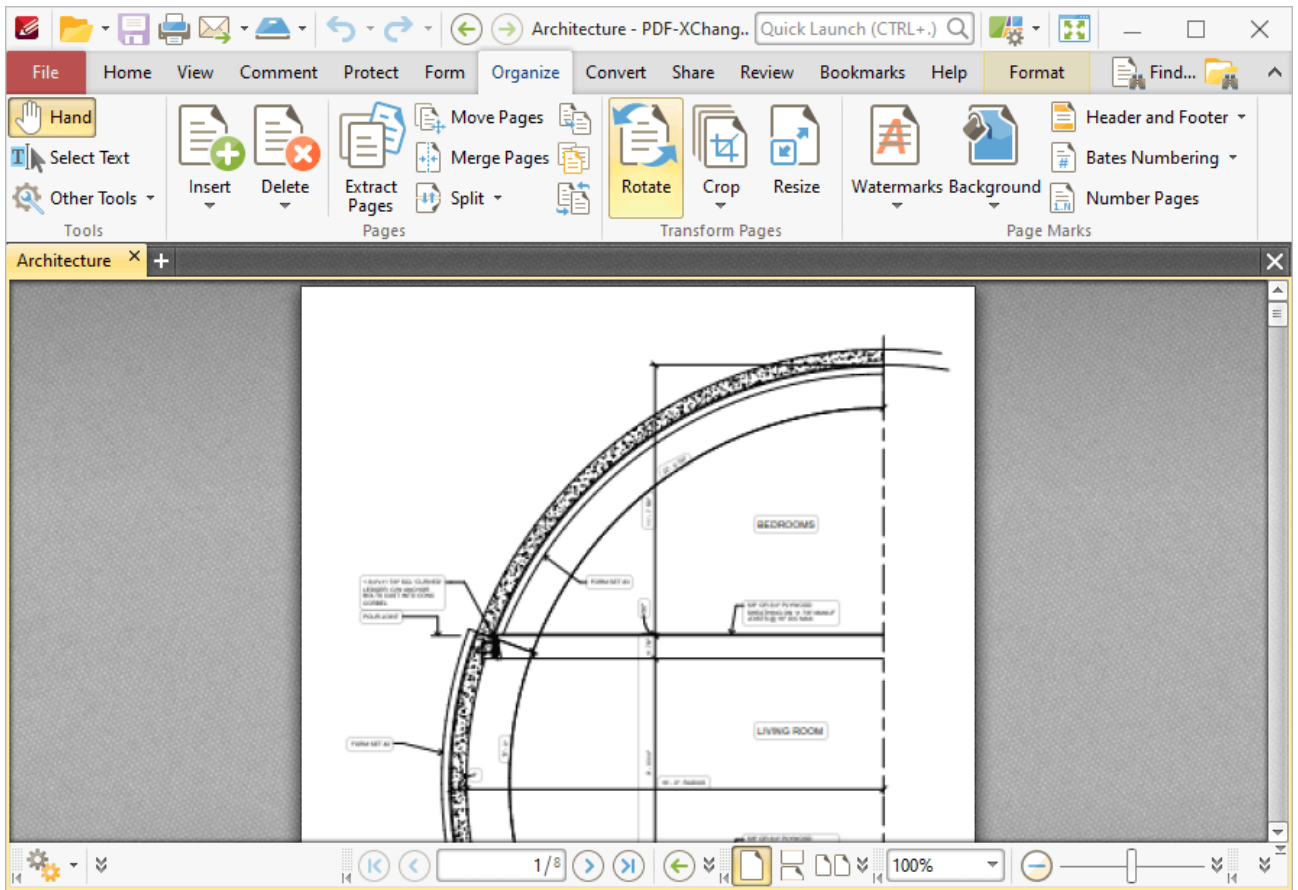

Figure 1. Document Tab Submenu. Rotate Pages

The **Rotate Pages** dialog box will open:

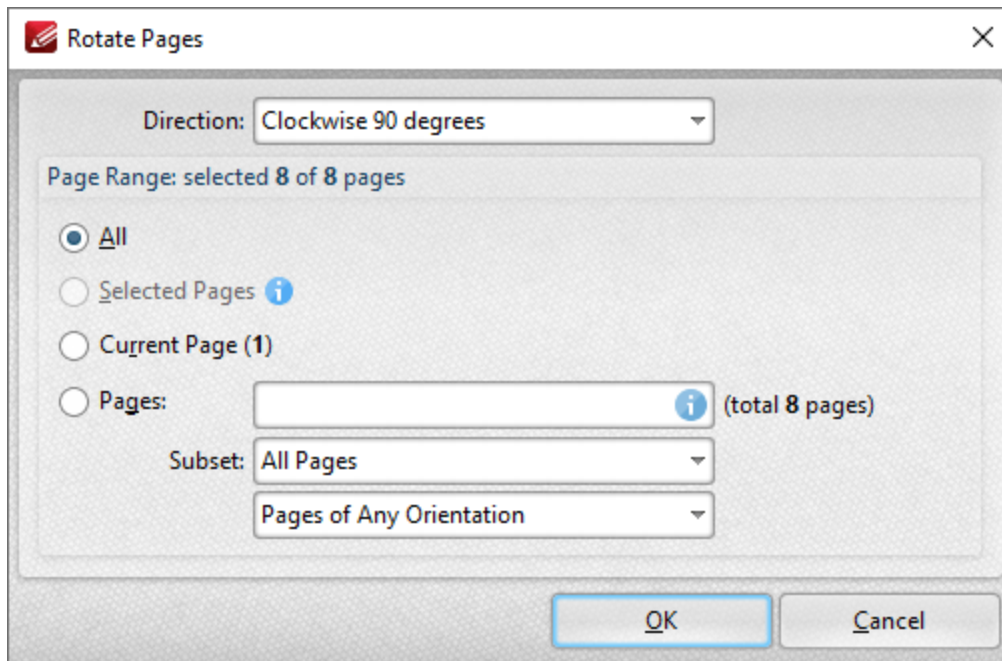

Figure 2. Rotate Pages Dialog Box

- Use the **Direction** dropdown menu to determine the rotation.
- Use the **Page Range** options to determine the page range of rotated pages:
  - Select **All** to rotate all pages.
  - Select **Selected Pages** to rotate the pages currently selected in the [Thumbnails](#) pane.
  - Select **Current Page** to rotate the current page.
  - Select **Pages** to specify a custom page range. Further information on the specification of page ranges is available [here](#).
  - Use the **Subset** dropdown menu to select a subset of the specified page range. Select **All Pages**, **Odd Pages Only** or **Even Pages Only** as desired.

Click **OK** to rotate pages.

---

10.4.7.11 Crop



Click **Crop** to view cropping options for the current document:

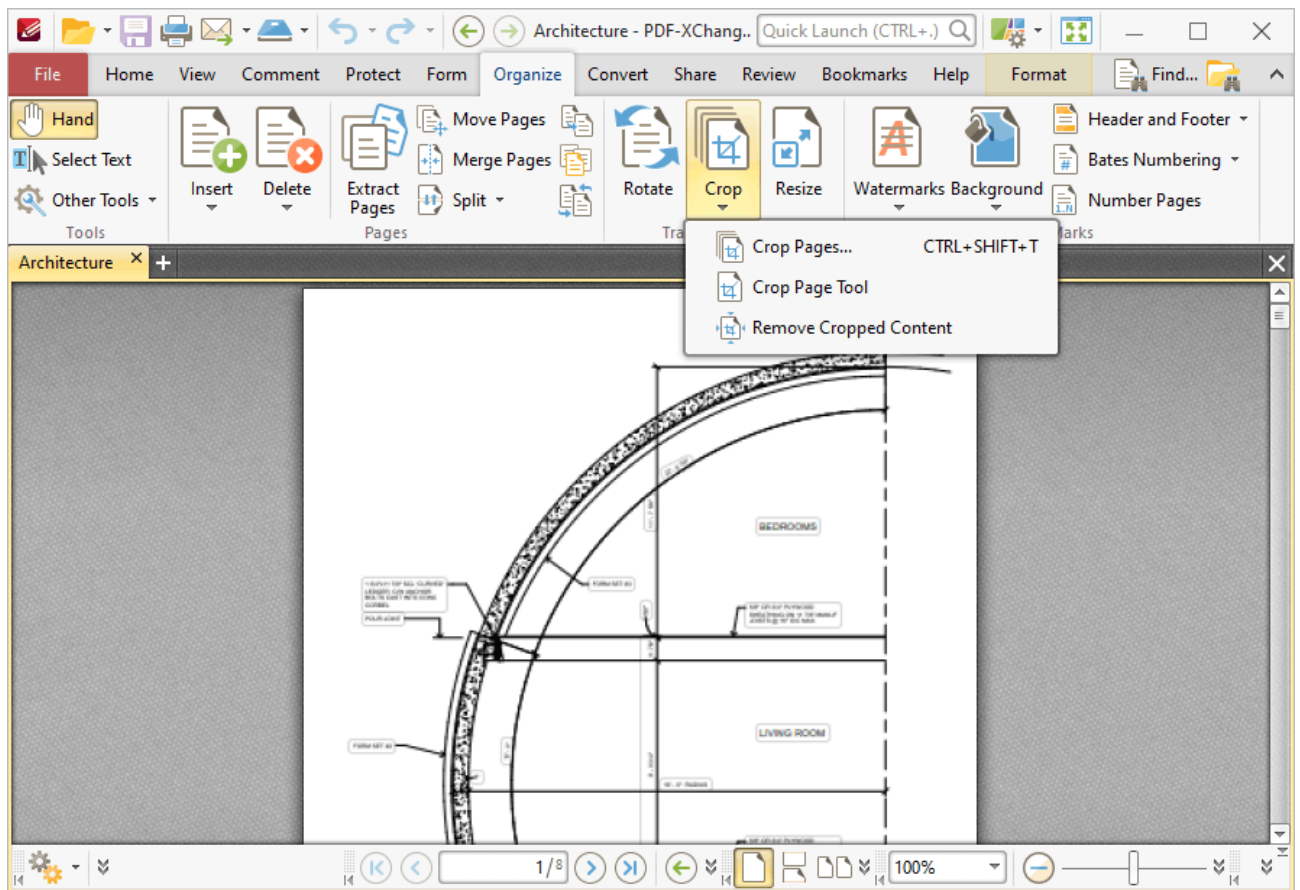

Figure 1. Document Tab Submenu. Crop Pages

Click **Crop Pages** to crop document pages:

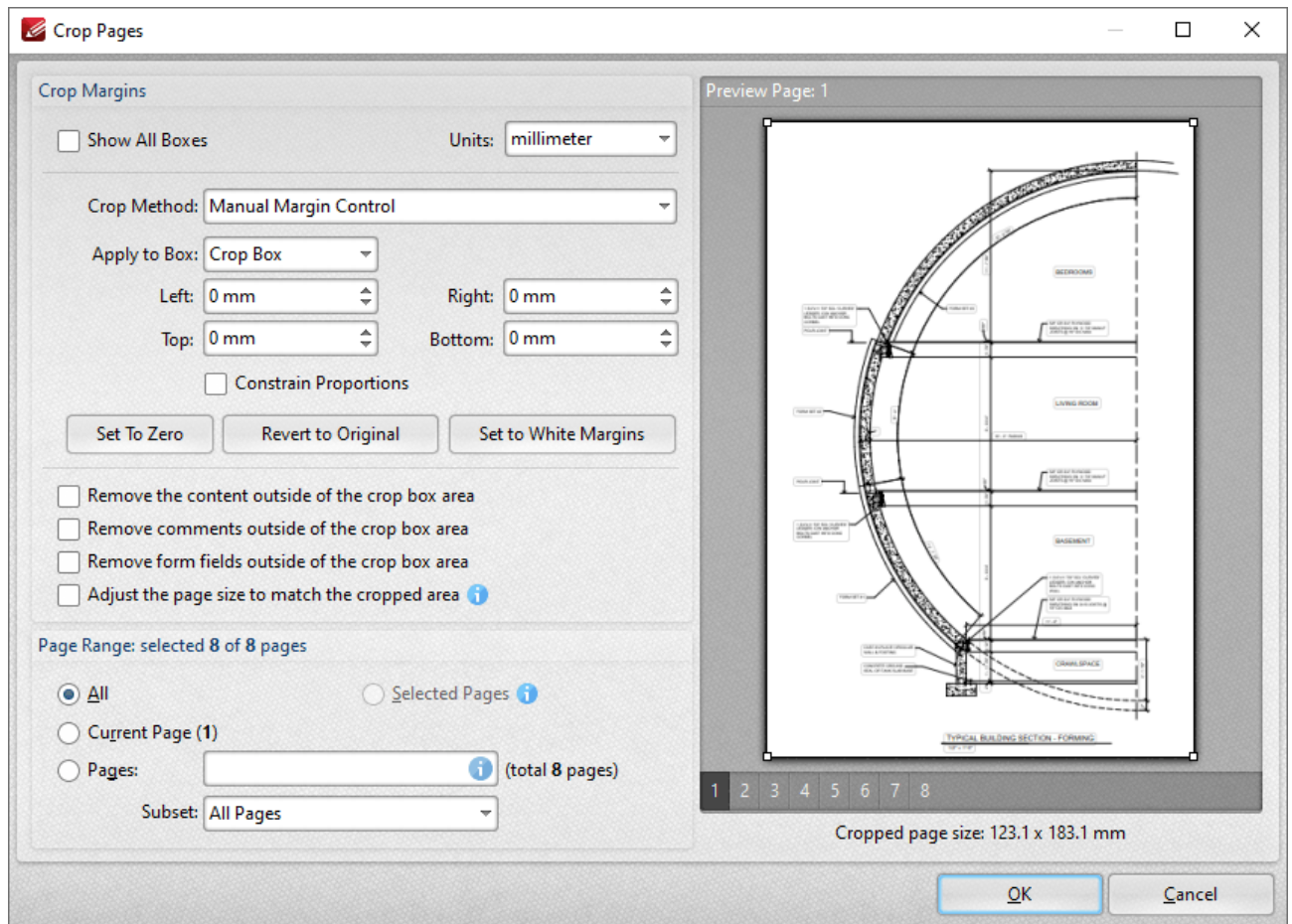



Figure 2. Crop Pages Dialog Box

PDF documents define five boundaries that control the imaging process: the **Crop Box**, **Bleed Box**, **Trim Box**, **Art Box** and **Media Box**. PDF-XChange Editor uses these boxes to determine areas when the **Crop Pages** feature is used. Use the **Apply to Box** dropdown menu, detailed below, to display the editing boxes in the preview pane, then click and drag boxes and/or use the number boxes to adjust their dimensions. Further information about editing boxes is available [here](#).<sup>1770</sup> The following options are available in the **Crop Pages** dialog box:

- Click **Show All Boxes** to view the **Crop Box**, **Bleed Box**, **Trim Box** and **Art Box** in the preview pane. (Please note that the **Bleed Box**, **Trim Box** and **Art Box** use the same dimensions as the **Crop Box** by default.
- Use the **Crop Method** dropdown menu to determine the crop method used:
  - **Manual Margin Control** enables the user to determine the cropping margins. Click the text of menu entries in the **Apply to Box** dropdown menu to view them in the preview pane. Click and drag boxes in the preview pane, or use the number boxes, to adjust their dimensions. Select the check boxes of menu entries in the **Apply to Box** dropdown menu to include them in the **Crop Pages** operation.
  - **Remove All White Space** is a predefined mode that removes all white space from documents.

- **Remove Horizontal White Space/Remove Vertical White Space** are predefined modes that remove horizontal/vertical white space as required.
- **None** adjusts the page size to the crop box without changing existing crop boxes.
- Select the **Constrain Proportions** box to maintain the ratio of margins. For example if the margin in the **Left** box is changed to 5mm then the margins in the **Right, Top** and **Bottom** boxes will also be changed to 5mm.
- Use **Set to Zero, Revert to Original** and **Set To White Margins** to apply these functions to boxes selected in the **Apply to Box** dropdown menu.
- Select the **Remove the content outside of the crop box area** box to remove content outside of the **Crop box**. Please note that cropping pages reduces the visible page content, but the cropped content is still present in the file's underlying code and, for example, will be visible if the document pages are increased in size. Select this option to remove cropped content from the file.
- Select the **Adjust the page size to match the cropped area** box to define the **Media box** with the same dimensions as the **Crop box**.
- Use the **Page Range** settings to determine the page range of cropped pages:
  - Select **All** to crop all pages.
  - Select **Current Page** to crop only the current page.
  - Select **Pages** to create a custom page range, as detailed [here](#).
  - Use the **Subset** option to select **All Pages, Odd Pages Only** or **Even Pages Only**.

Click **OK** to crop pages.

Click **Crop Page Tool** to crop documents manually. The **Crop Tool** dialog box will open:

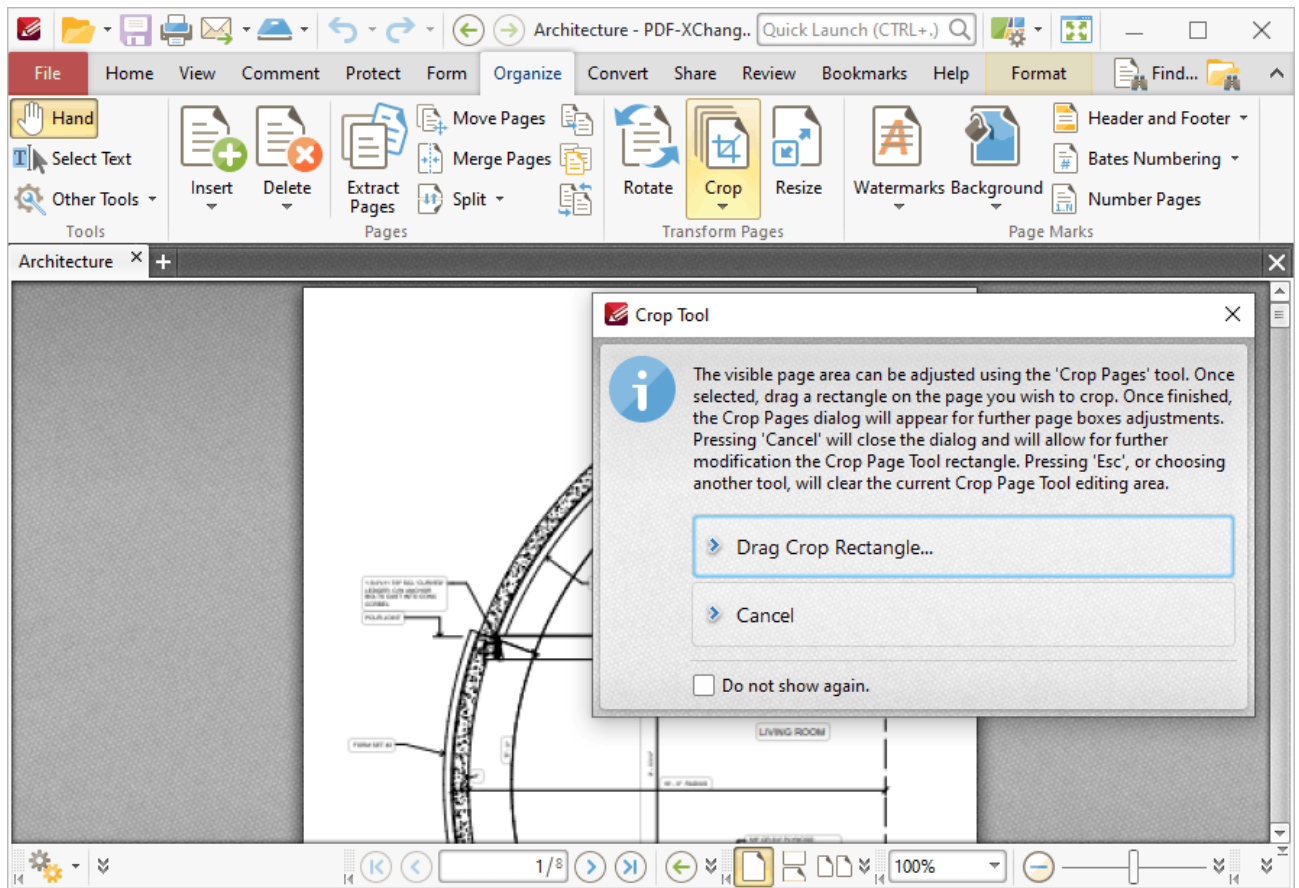

Figure 3. Crop Page Tool, Crop Tool Dialog Box

Click **Drag Crop Rectangle**. The pointer will become a crosshairs icon. Click and drag to select the area to be cropped. When the mouse button is released, the dialog box detailed in **(figure 2)** will launch. Configure the parameters as detailed above and then click **OK** to crop documents.

Click **Remove Cropped Content** to remove cropped content from documents. Please note that content is not removed by default. Cropping pages reduces the visible page content, but the content remains available (and takes up memory) unless the **Remove Cropped Content** option is used.

## 10.4.7.12 Resize



**Resize**

Click **Resize** to resize the pages of the current document:

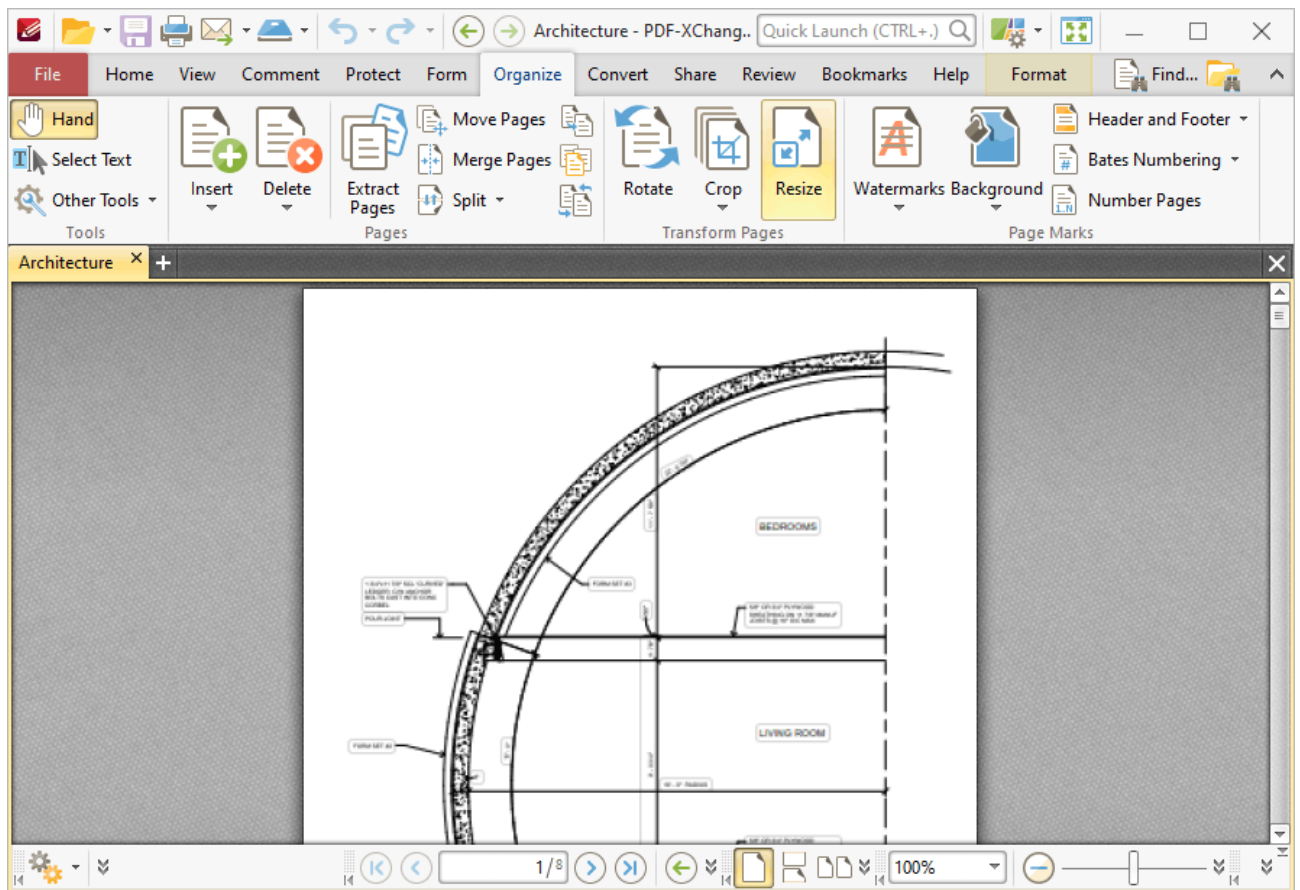

Figure 1. Organize Tab, Resize

The **Resize Pages** dialog box will open:



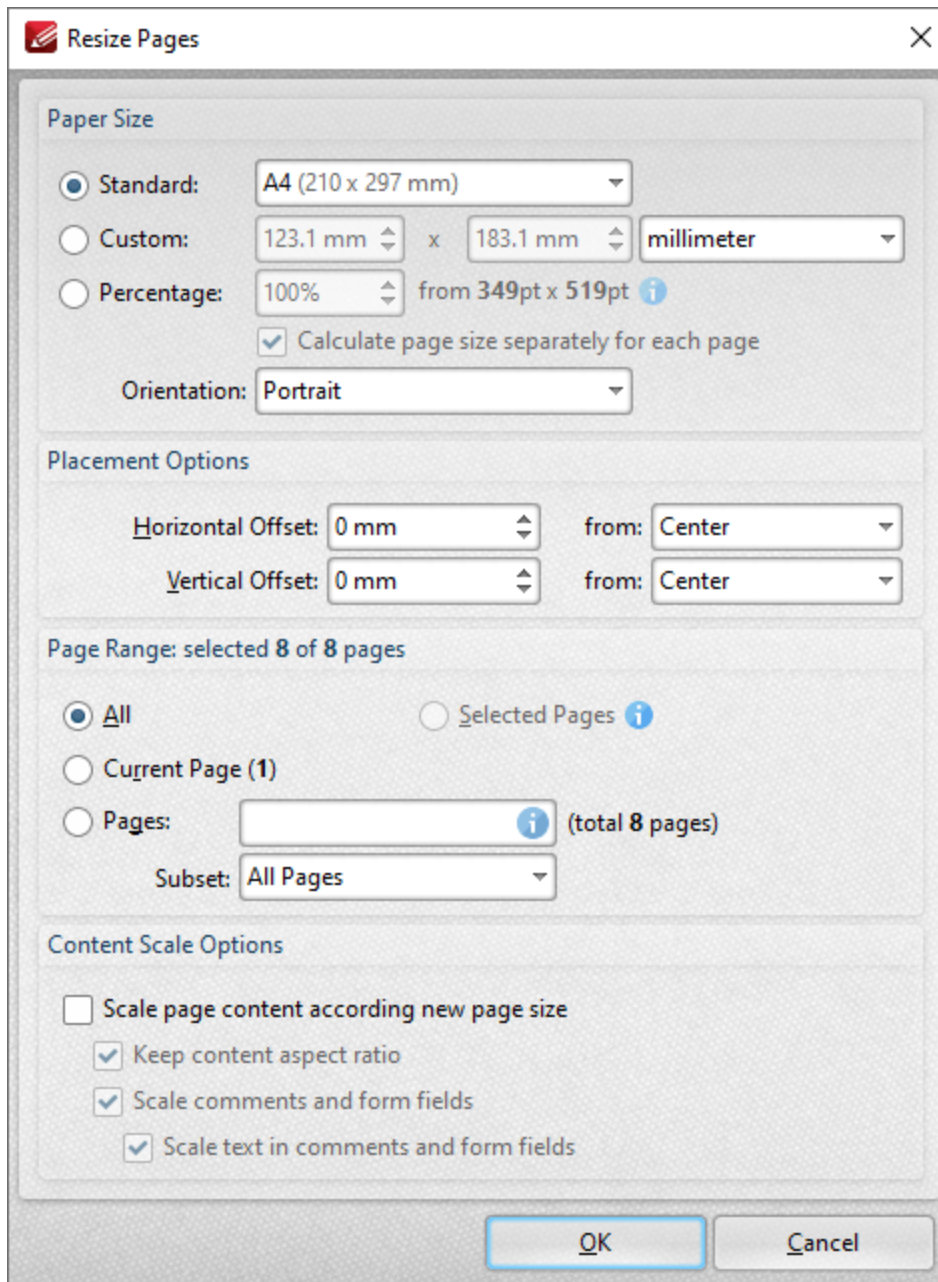



Figure 2. Resize Pages Dialog Box

- Use the **Paper Size** options to determine the size and layout of resized pages:
  - Click **Standard** to select a standard size, such as those used by the **ISO** and **ANSI**. Use the adjacent box to select either **Landscape** or **Portrait** as the page orientation.
  - Click **Custom** to enter custom dimensions. Enter the dimensions in the number boxes and select the units of measurement as desired.
- Use the **Placement** options to determine the horizontal/vertical offset of resized pages and the location from which the offset is made.
- Use the **Page Range** settings to determine the page range of resized pages:
  - Select **All** to resize all pages.

- Select **Current Page** to resize only the current page.
- Select **Pages** to specify a custom page range. Further information on the specification of page ranges is available [here.](#)
- Use the **Subset** option to specify a subset of the specified page range. Select **All Pages**, **Odd Pages Only** or **Even Pages Only**.
- Use the **Content Scale Options** to determine the scale of page content in relation to the new page size:
  - Select the **Scale page content according new page size** box to scale the content of resized pages to the new page size.
  - Clear the **Keep content aspect ratio** box to scale all content of resized pages to the new page size.
  - Select the **Scale comments and form fields** and **Scale text in comments and form fields** boxes as desired.

Click **OK** to resize pages.

---

## 10.4.7.13 Watermarks

**Watermarks**

Click **Watermarks** to view watermark options:

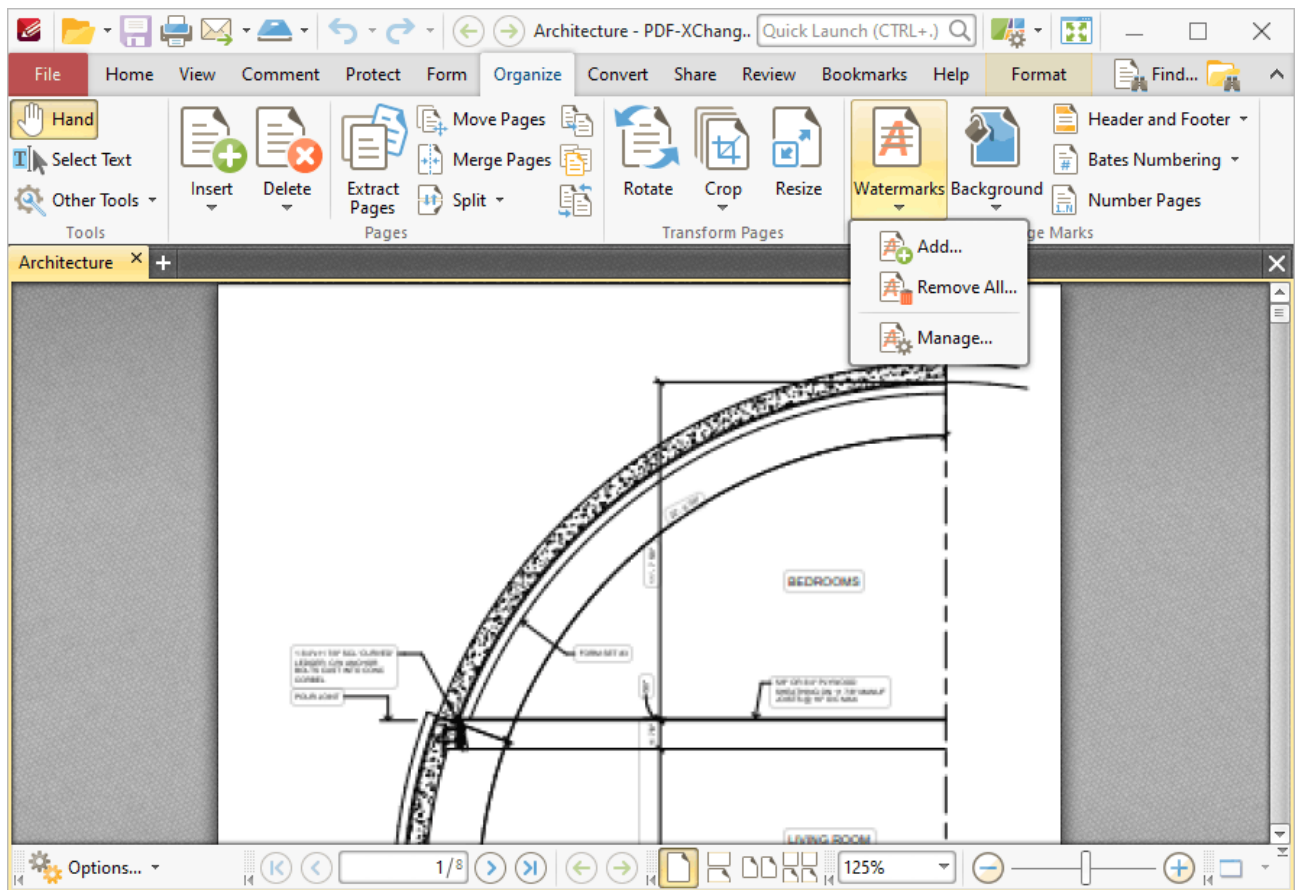

**Figure 1.** Organize Tab, Watermarks

- Click **Add** to add new watermarks. The **Add Watermark** dialog box will open, as detailed in **(figure 2)**.
- Click **Remove All** to remove all existing watermarks.
- Click **Manage** to manage existing watermarks.

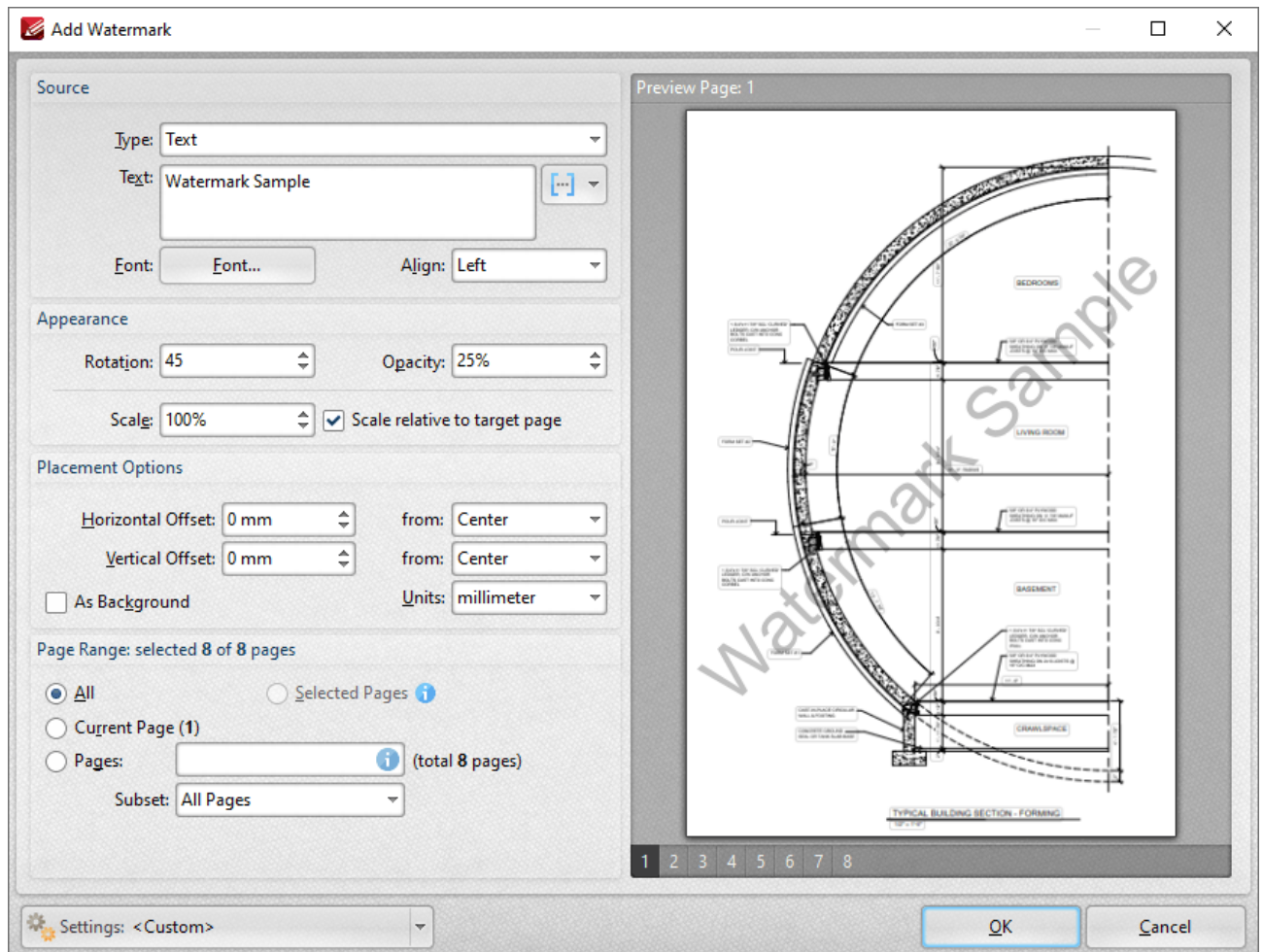

Figure 2. Add Watermark Dialog Box

- The **Source** options determine the source of watermarks. Enter text into the box or select a file. Use the font, [macro](#)<sup>1707</sup> and alignment options to customize watermarks when text is used.
- The **Appearance** options determine the rotation, opacity and scale of the watermark:
  - The **Rotation** value determines the rotation (in degrees) of watermarks.
  - The **Opacity** value determines the opacity (transparency) of watermarks.
  - The **Scale** value determines the scale of watermarks. Select the check box to scale watermarks to the target page. If this box is not selected then the scale is relative to the size of the original image used as the source for the watermark.
- The **Placement** options determine the horizontal and/or vertical offset of the watermark from the left, right or center of the document.
- Select the **As Background** box to insert watermarks into the background as opposed to the foreground of documents.
- The **Page Range** options are as follows:
  - Select **All** to add watermarks to all pages.
  - Select **Current Page** to add a watermark to only the current page.
  - Use the **Pages** box to determine watermarks for specific page ranges. Further information on this process is available [here](#).<sup>1773</sup>

- Use the **Subset** option to select **All Pages**, **Odd Pages Only** or **Even Pages Only**.
- The **Preview Page** pane displays a preview of pages. Select the numbers beneath the pane to preview the corresponding document pages.
- The **Settings** menu features two predefined watermarks: **Draft** and **Confidential**. The remaining options relate to customized settings:
  - Click **Save** to save settings.
  - Click **Delete** to remove settings.
  - Click **Manage** to manage settings.

Click **OK** to add watermarks.

---

## 10.4.7.14 Background

**Background**

Click **Background** to view background options:

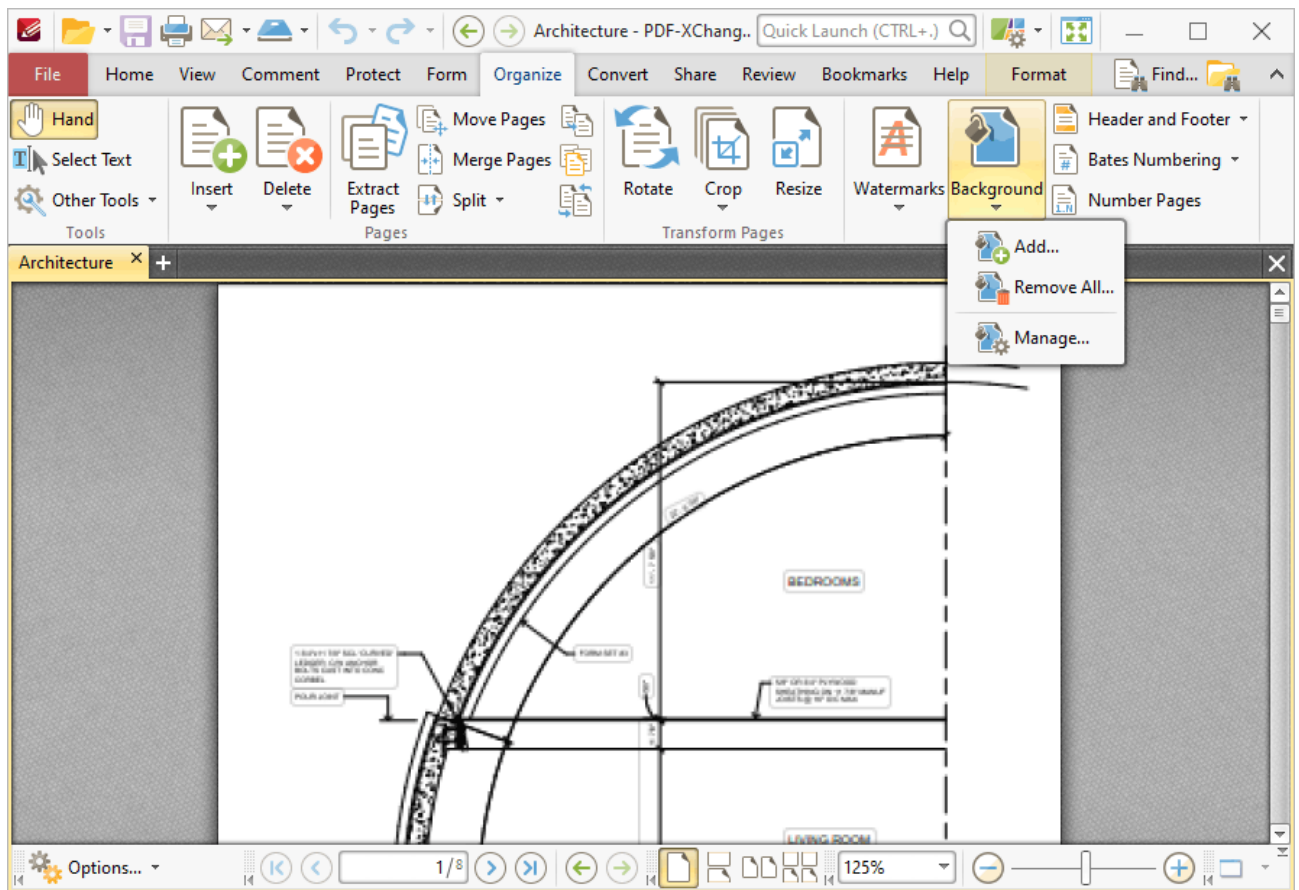

Figure 1. Organize Tab, Background

- Click **Add** to add new backgrounds. The **Add Background** dialog box will open, as detailed in *(figure 2)*.
- Click **Remove All** to remove all existing backgrounds.
- Click **Manage** to manage existing backgrounds.

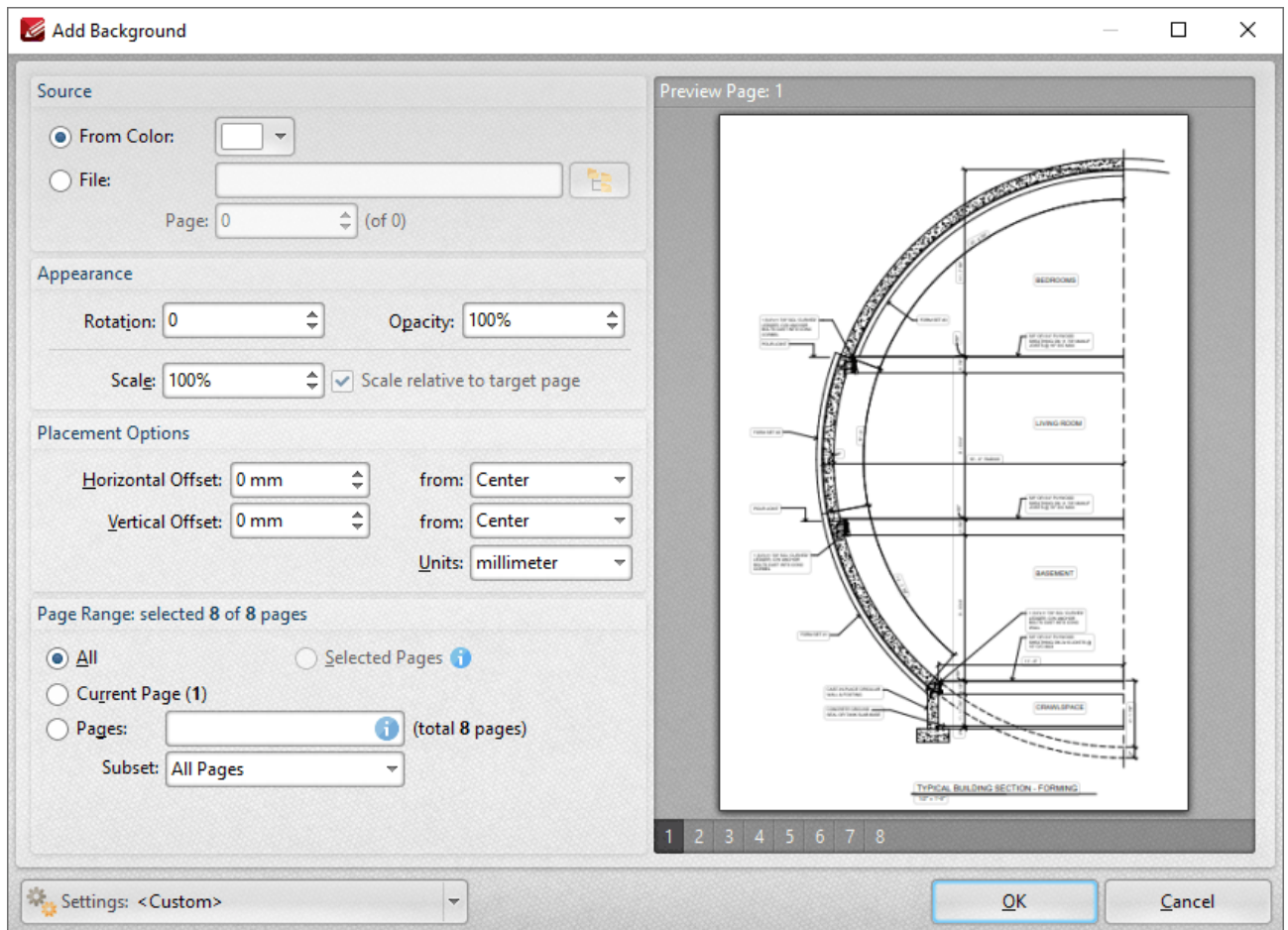

Figure 2. Add Background Dialog Box

- The **Source** options determine the source of the background:
  - Select **From Color** to add a color-based background.
  - Select **Name** to specify a file to be used as the background, or click the icon to select a file from the local computer. If you are using a document that contains multiple pages, then use the **Page** number box to specify the page number of the page/image to be used.
- The **Appearance** options determine the rotation, opacity and scale of the background:
  - The **Rotation** value determines the rotation (in degrees) of the background.
  - The **Opacity** value determines the opacity (transparency) of the background.
  - The **Scale** value determines the scale of backgrounds. Select the check box to scale backgrounds to the target page. If this box is not selected then the scale is relative to the size of the original image used as the source for the background.
- The **Placement** options determine the horizontal and/or vertical offset of the background from the left, right or center of the document.
- The **Page Range** options are as follows:
  - Select **All** to add backgrounds to all pages.
  - Select **Current Page** to add a background to only the current page.

- Use the **Pages** box to determine backgrounds for specific page ranges. Further information on this process is available [here](#).<sup>1773</sup>
- Use the **Subset** option to select **All Pages**, **Odd Pages Only** or **Even Pages Only**.
- Please note that it is possible to create more than one background for pages within the same document as long as they are not located within the same page/page range.
- The **Preview Page** pane displays a preview of pages. Select the numbers beneath the pane to preview the corresponding document pages.
- Use the **Settings** dropdown menu to save/delete customized settings and/or manage existing customized settings:
  - Click **Save** to save settings.
  - Click **Delete** to remove settings.
  - Click **Manage** to manage settings.

Click **OK** to add backgrounds.

---



## 10.4.7.15 Header and Footer



## Header and Footer

Click **Header and Footer** to view header and footer options:

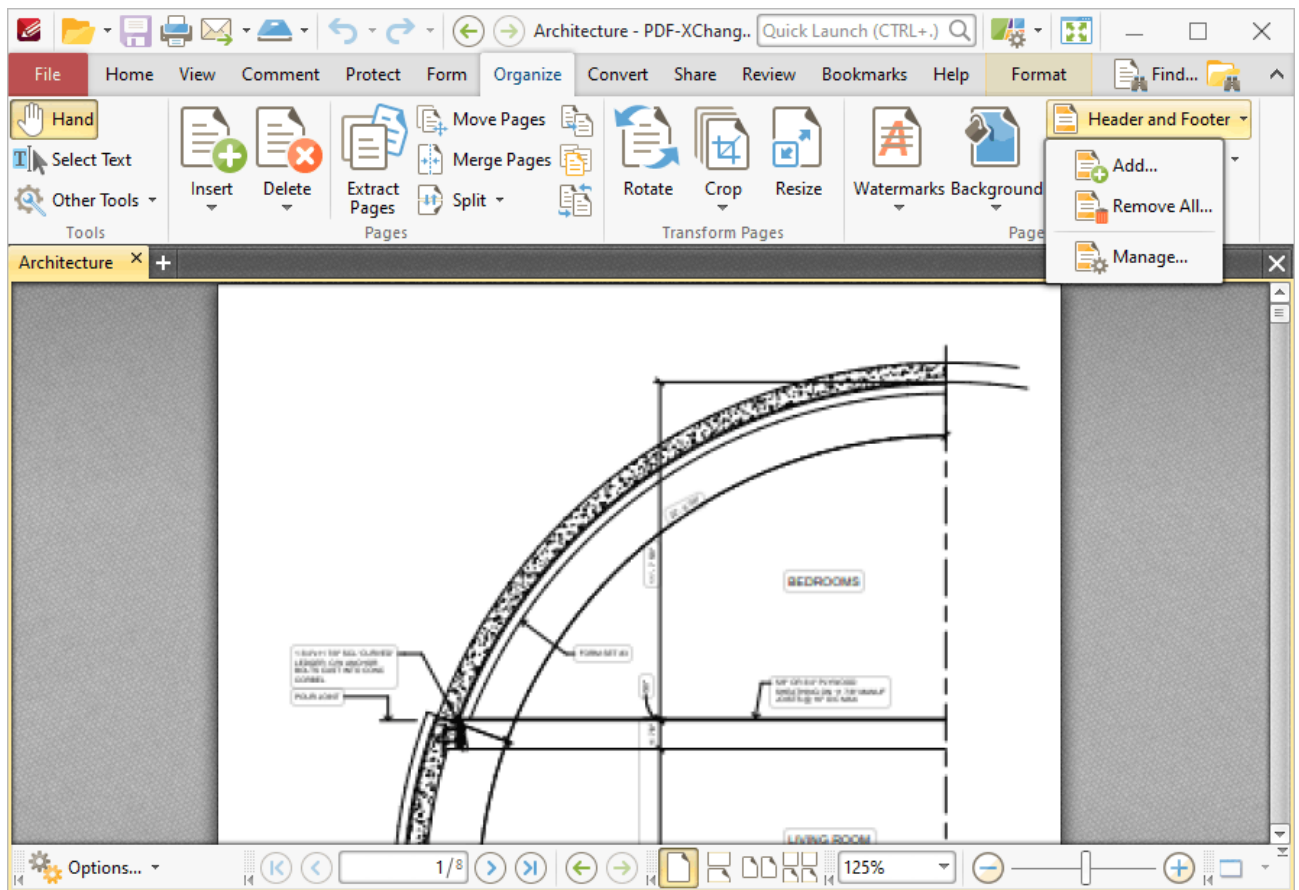

Figure 1. Organize Tab, Header and Footer

- Click **Add** to add new headers and footers. The **Add Header and Footer** dialog box will open, as detailed in **(figure 2)**.
- Click **Remove All** to remove all existing headers and footers.
- Click **Manage** to manage existing headers and footers.

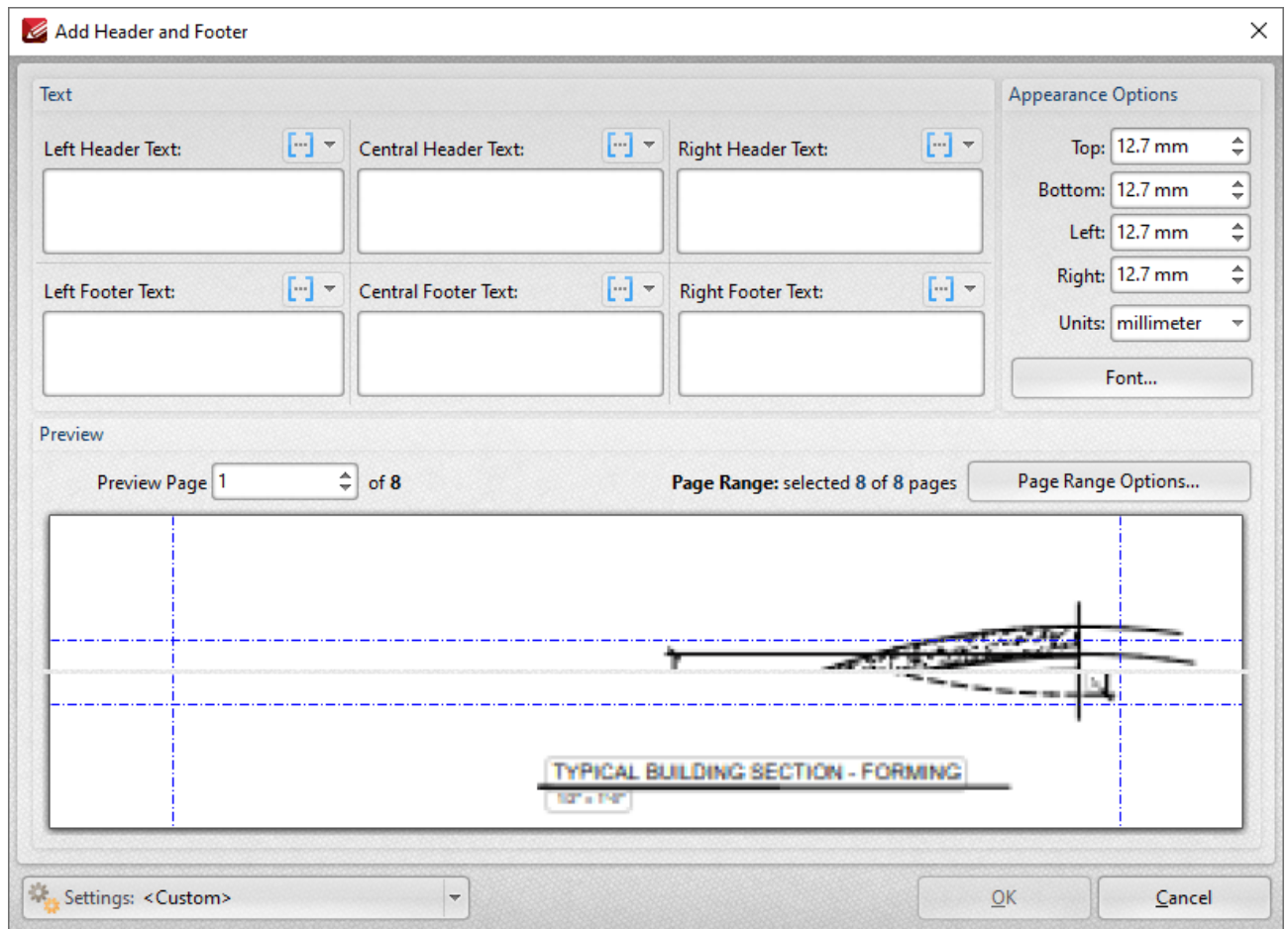





Figure 2. Add Header and Footer Dialog Box

- Enter text in the text boxes to insert headers/footers on the left/center/right of pages as desired. Alternatively, click the  macro icon to use macros as the source for header/footer text. Further information about macros is available [here](#).<sup>1707</sup>
- Click **Font** to determine the font settings for headers and footers, as detailed [here](#).<sup>825</sup>
- Use the **Appearance Options** settings to reposition the location of headers/footers.
- Enter page numbers in the **Preview Page** number box to view a preview of headers/footers in the preview window.
- Click **Page Range Options** to select the pages of the document that will feature headers/footers.
- Click the **Settings** dropdown arrow to save/delete customized settings and/or manage existing customized settings:
  - Click  to save settings.
  - Click  to remove settings.
  - Click  to manage settings.

Click **OK** to create headers/footers.

---

## 10.4.7.16 Bates Numbering

**Bates Numbering**

Click **Bates Numbering** to view Bates numbering options:

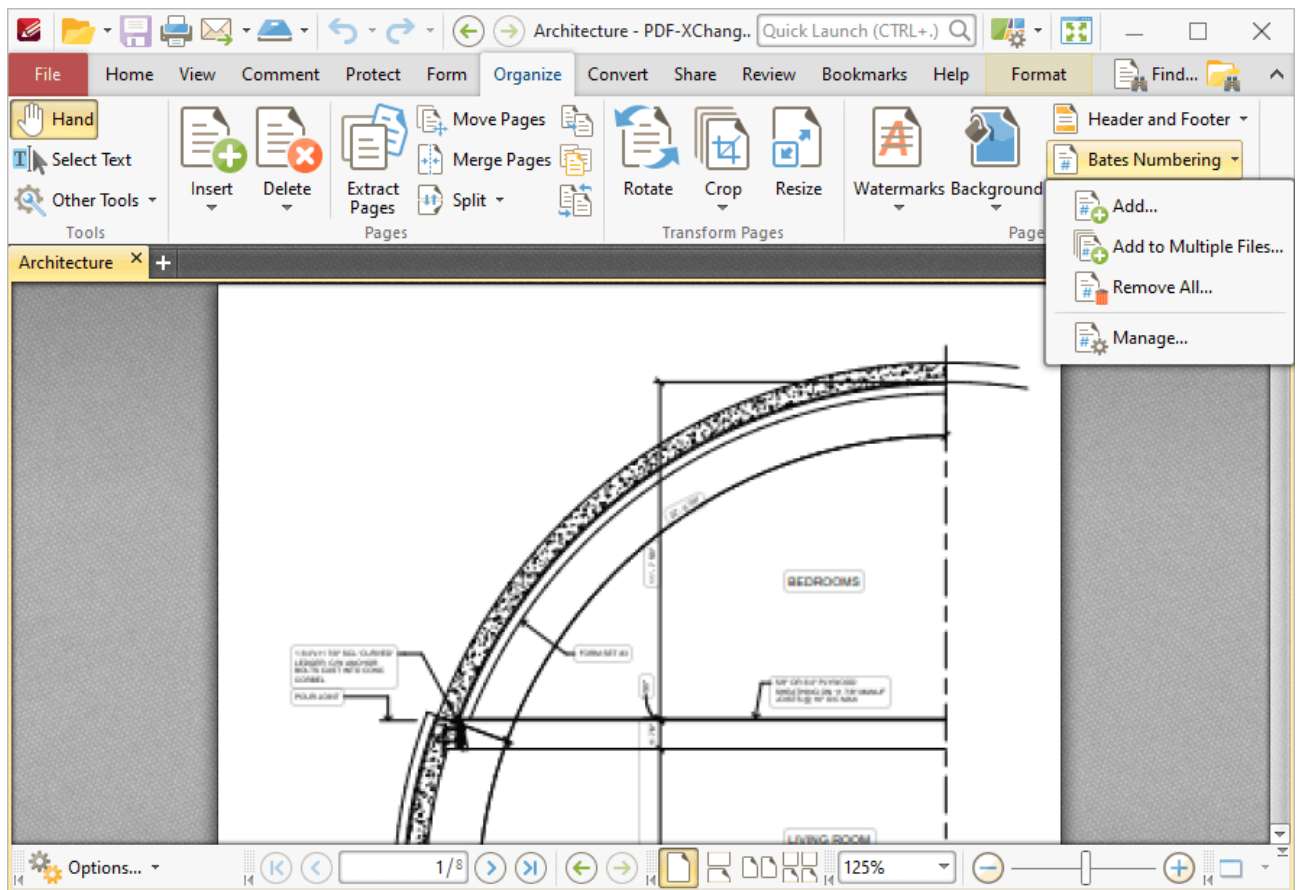

**Figure 1.** Organize Tab, Bates Numbering

Bates numbering is a dynamic way to provide identification, protection and automatic consecutive numbering within documents as they are processed/scanned.

- Click **Add** to add Bates numbering to documents. The **Add Bates Numbering** dialog box will open, as detailed in **(figure 2)**.

- Click **Add to Multiple Files** to add Bates numbering to multiple files. The **Add Bates Numbering to Files** dialog box will open, as detailed in *(figure 3)*.
- Click **Remove All** to remove all existing Bates numbering.
- Click **Manage** to manage existing Bates numbering.

## Add Bates Numbering

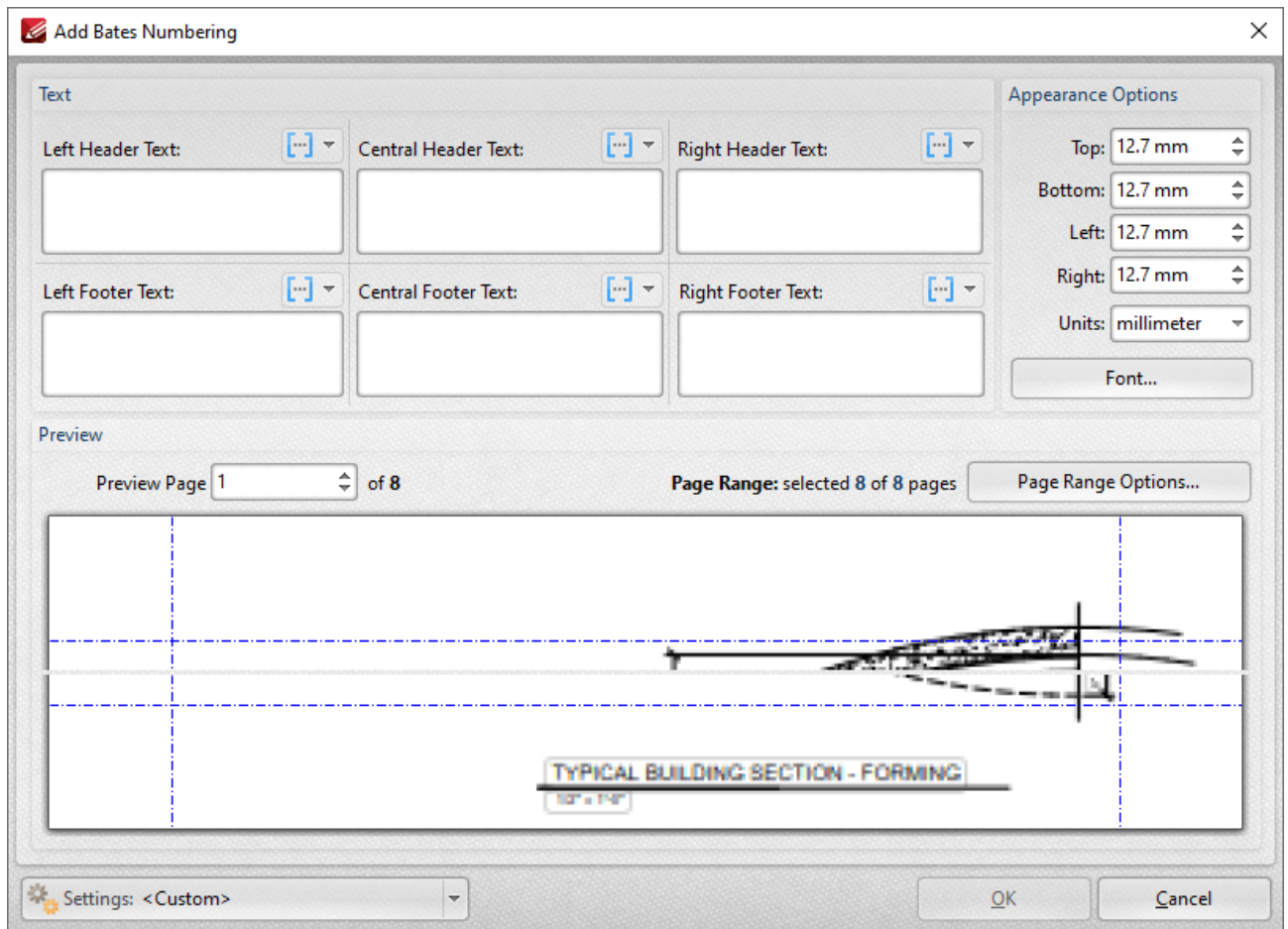





Figure 2. Add Bates Numbering Dialog Box

- Enter text in the text boxes to insert Bates numbering on the left/center/right and as a header/footer of pages as desired. Alternatively, click the  macro icon to source the content of Bates numbering with macros. Further information about macros is available [here](#).<sup>1707</sup>
- Click **Font** to determine the font settings for Bates numbering, as detailed [here](#).<sup>825</sup>
- Use the **Appearance Options** settings to reposition the location of Bates numbering.
- Enter page numbers in the **Preview Page** number box to view a preview of Bates numbering in the preview window.
- Click **Page Range Options** to select the pages of the document that will feature Bates numbering.

- Use the **Settings** dropdown menu to save/delete customized settings and/or manage existing customized settings:

- Click  to save settings.
- Click  to remove settings.
- Click  to manage settings.

Click **OK** to add Bates numbering.

### Add to Multiple Files

Click **Add to Multiple Files** to add continuous Bates numbering to multiple files. The following dialog box will open:

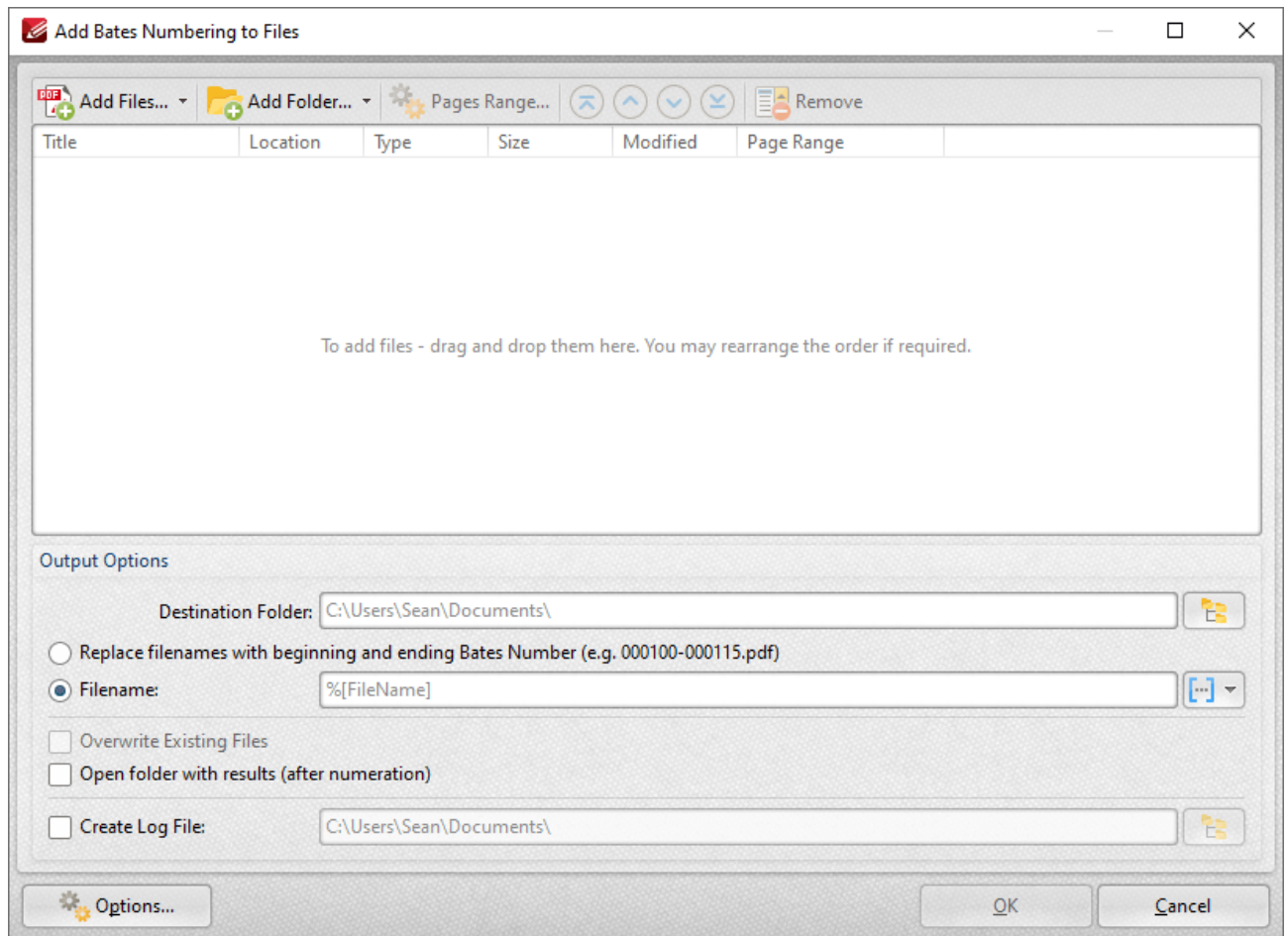

**Figure 3.** Add Bates Numbering to Files Dialog Box

- Click **Add Files** to add files from the local computer to the list of source files.
- Click **Add Folder** to add folders to the list of source files.

- Select files and then click **Page Range** to determine page ranges for Bates numbering.
- Use the blue arrow icons to move selected documents to the top/bottom of the list, or to move them up/down in the order of documents. The order in which documents are listed determines the order of Bates numbering throughout the documents.
- Click **Remove** to remove selected documents from the list.
- Select **Replace file names with starting and ending Bates number** as desired.
- Use the **Output Options** to determine options for output files:
  - Select the upper radio button to convert filenames to Bates numbering.
  - Select the lower radio button to enter a custom name for converted files. Enter the desired name/folder in the text boxes. Click the blue icon to use **macros**  as desired. Use the **Destination Folder** test box, or click the yellow icon, to determine the location of converted files.
  - Select the **Overwrite Existing Files, Open folder with results** and **Create Log File** boxes as desired..
- Click **Options** to determine the Bates numbering options as detailed in *(figure 2)* above.

Click **OK** to insert Bates numbering into the documents.

---

## 10.4.7.17 Number Pages



## Number Pages

Click **Number Pages** to number document pages and create number ranges:

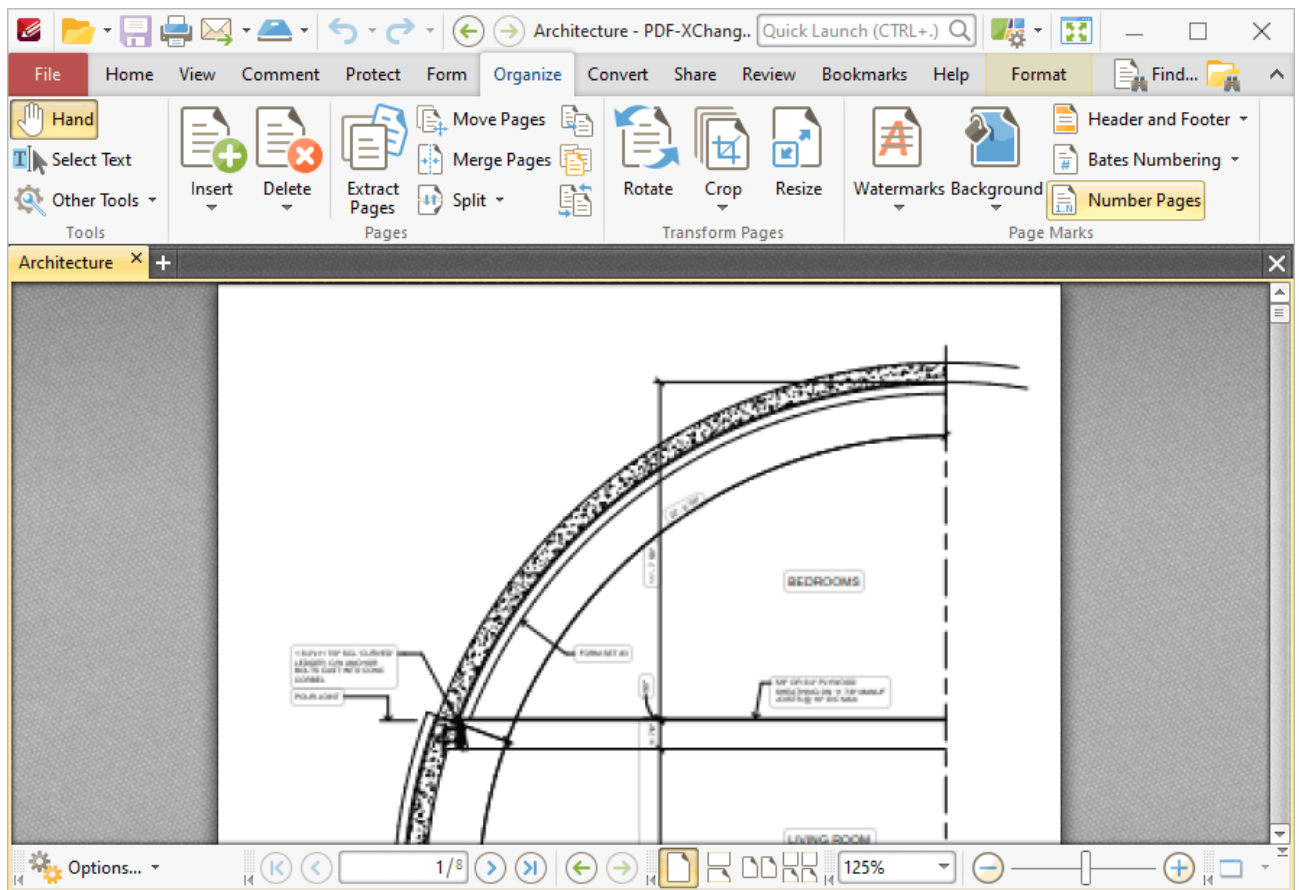

Figure 1. Organize Tab, Number Pages

Please note that this feature relates to page numbers/ranges as they appear in the [Thumbnails](#)<sup>1000</sup> pane and the [Page Navigation](#)<sup>1611</sup> toolbar. (The [Header and Footer](#)<sup>1497</sup> feature can be used to create/edit physical page numbers). The main purpose of this feature is to rectify cases where the page numbers on document pages do not match the page numbers that appear in the **Thumbnails** pane and the **Page Navigation** toolbar. This is often the case in documents that feature 'front matter' such as copyright pages and/or a table of contents and other similar pages. Additionally, it is necessary to



select the **Use logical page numbers** box in the **Page Display** preferences tab, as detailed in **(figure 7)**, in order for changes made with this feature to be visible.

When this option is selected, the following dialog box will open:

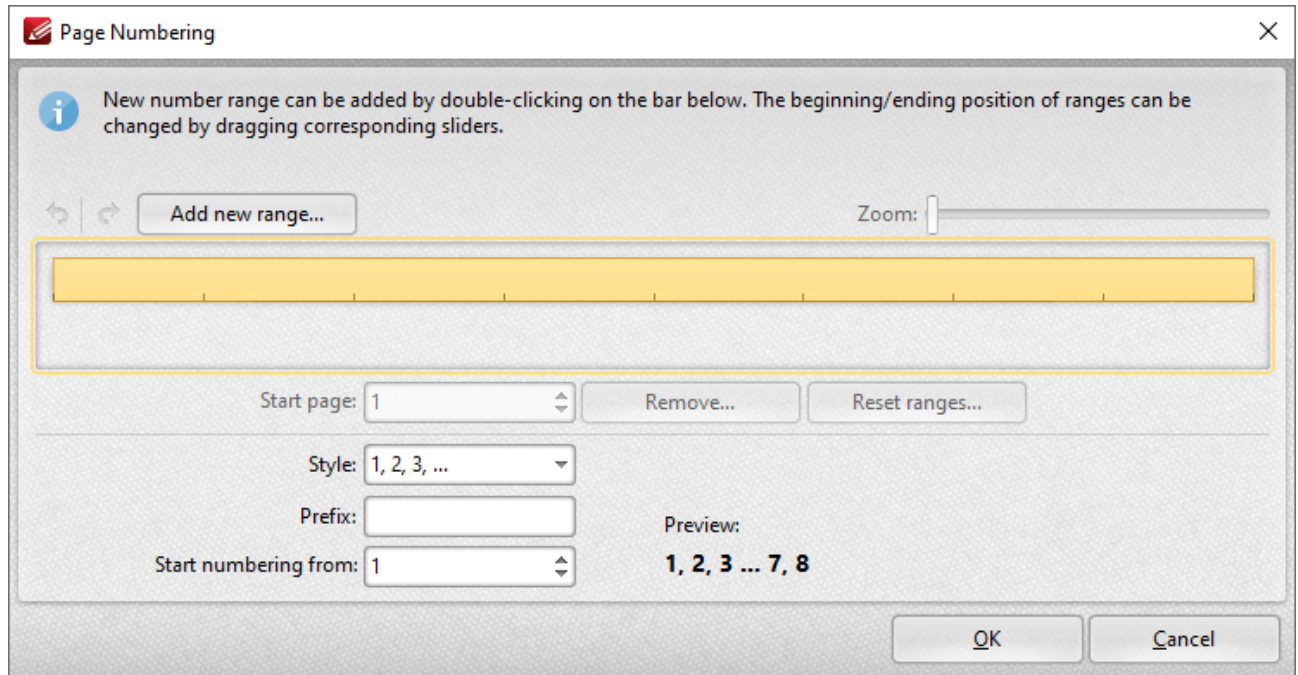

**Figure 2.** Page Numbering Dialog Box

- Existing page ranges are detailed in the dialog box. Click **Add new range** to add a new page range to the active document. The **Add new range** dialog box will open. Enter the number of the first page in the number box and click **OK** to create the page range.
- Use the sliders detailed in **(figure 2)** to adjust page ranges.
- Click **Remove** to remove the selected page range.
- Click **Reset ranges** to reset all page ranges.
- Use the **Style** menu to set the numbering style of the selected page range.
- Use the **Prefix** box to add a prefix to page numbers in the selected page range.
- Use the **Start numbering from** box to determine the first number of the selected page range.
- Use the arrow icons on the left of the **Add New Range** button to redo/undo operations.

Click **OK** to apply changes.

### Number Pages Example

The document detailed below contains a table of contents that results in a two-page difference between the page numbering of pages in the **Thumbnails** pane and the **Page Navigation** toolbar in comparison to the page numbers of the document:

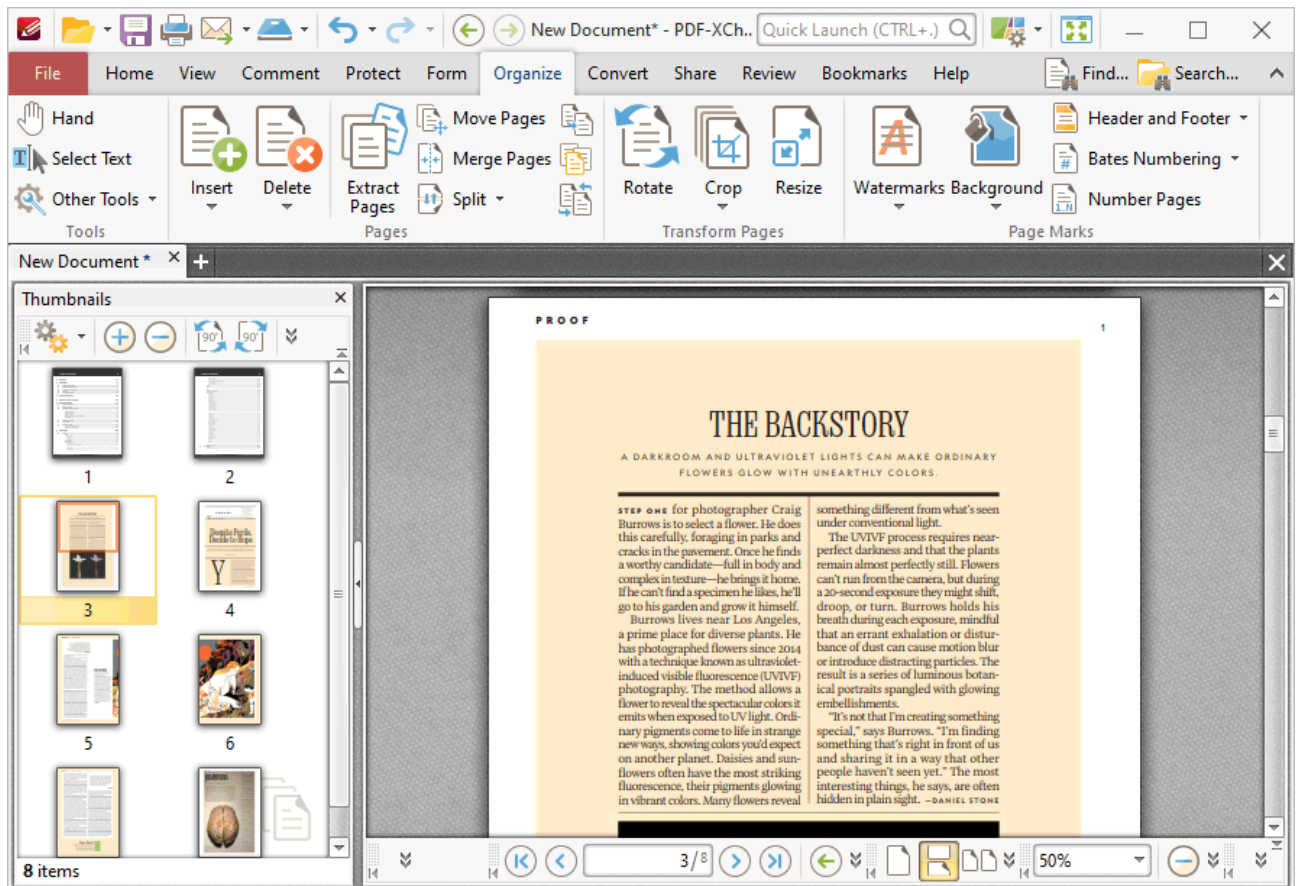

Figure 3. Number Pages Example. Page Number Disparity

Follow the steps below to resolve this issue:

1. Click the **Organize** tab, then click **Number Pages**:

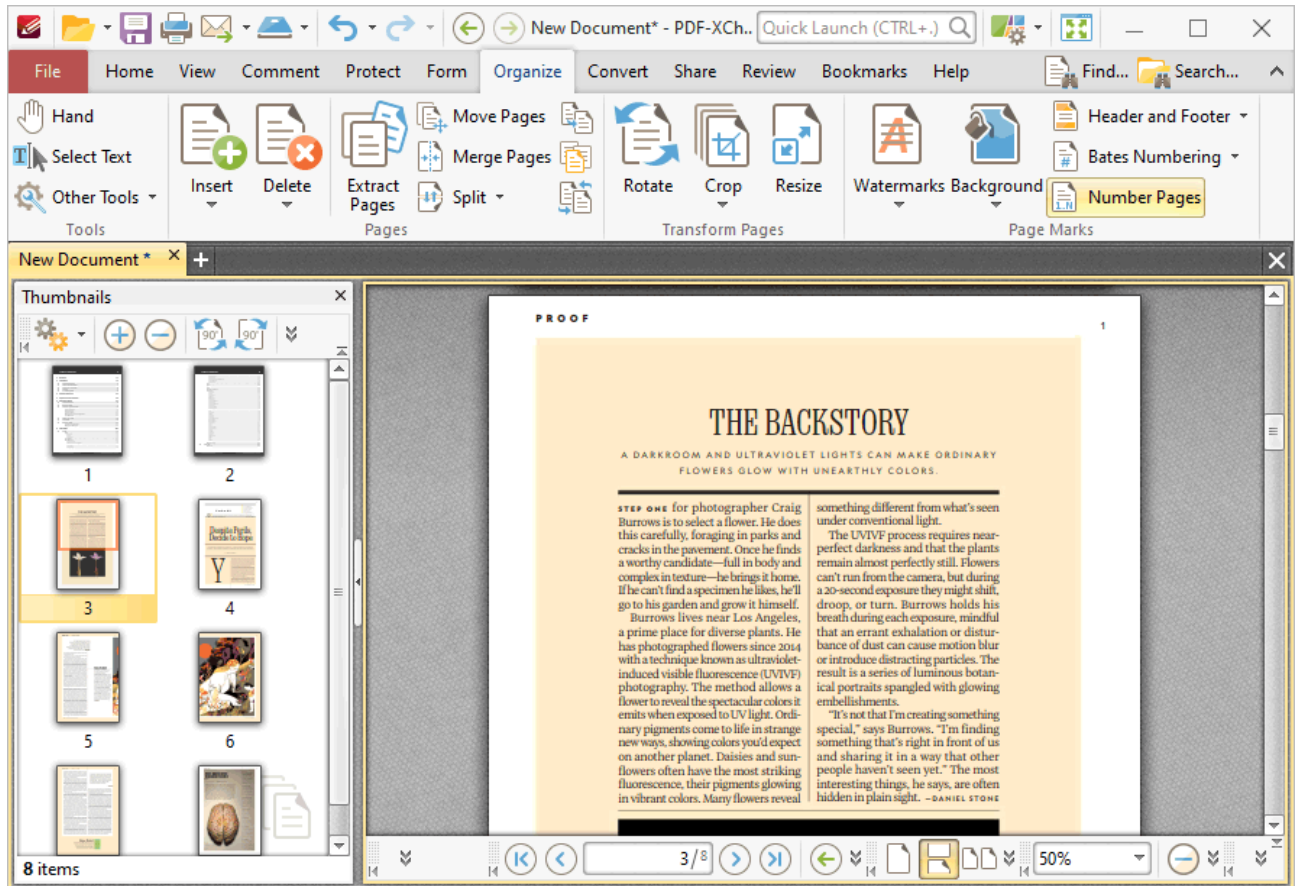

Figure 4. Number Pages Example. Organize Tab, Number Pages

The **Page Numbering** dialog box will open.

2. Click **Add new range**. The **Add New Range** dialog box will open:

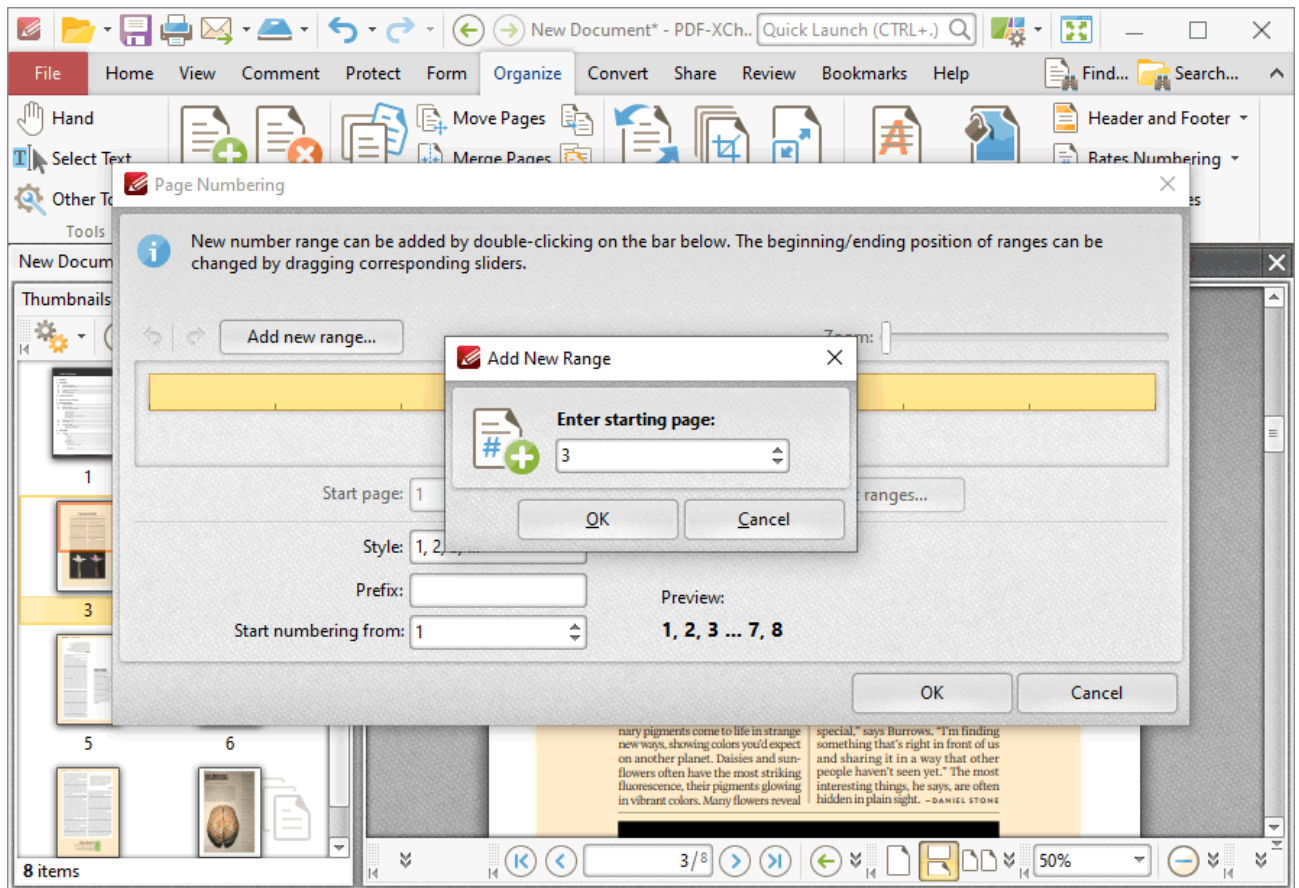

Figure 5. Page Numbering Feature, Add New Range Dialog Box

3. Enter the desired starting page for the new range. (Note that the issue detailed above requires page three to be the first page of the new range).
4. Click **OK** in the **Add New Range** and **Page Numbering** dialog boxes.
5. Click the **File** tab, then click **Preferences:**

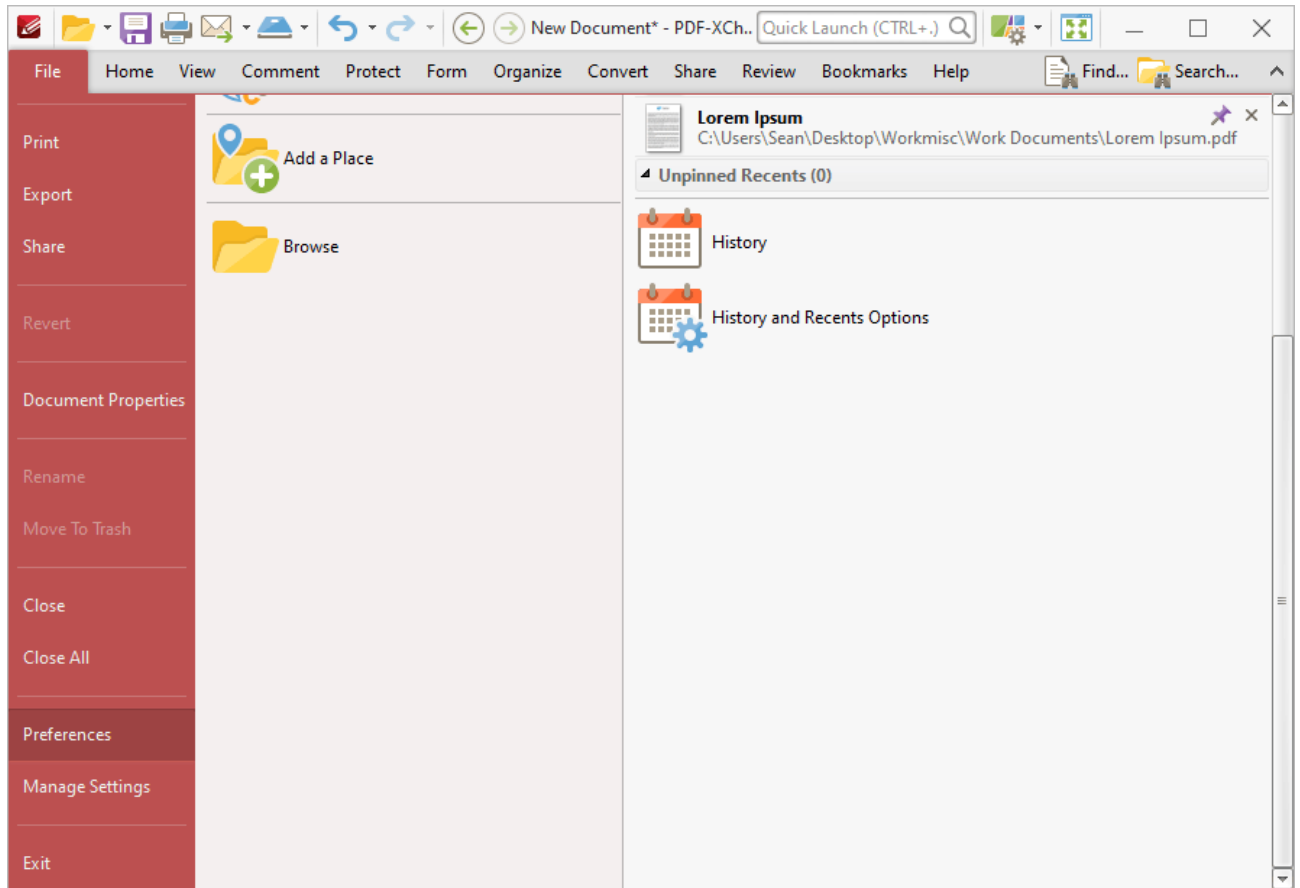

Figure 6. File Tab, Preferences

The **Preferences** dialog box will open.

6. Click **Page Display** in the **Categories** menu, then select the **Use logical page numbers** box:

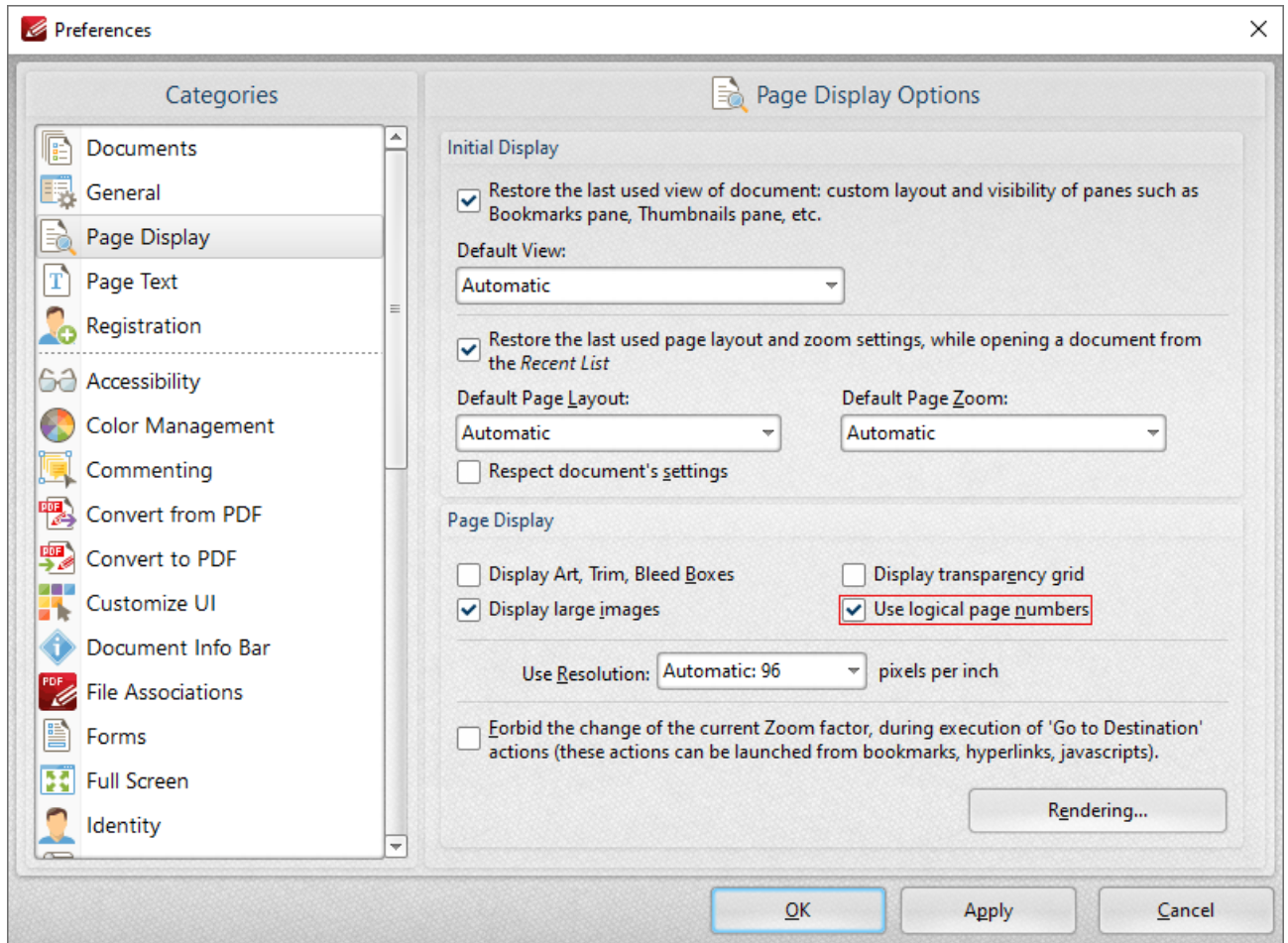

Figure 7. Page Display Preferences, Use Logical Page Numbers Highlighted

7. Click **Apply** and then click **OK**.

The page numbering of pages in the **Thumbnails** pane and the **Page Navigation** toolbar will then match the page numbering of the main document:

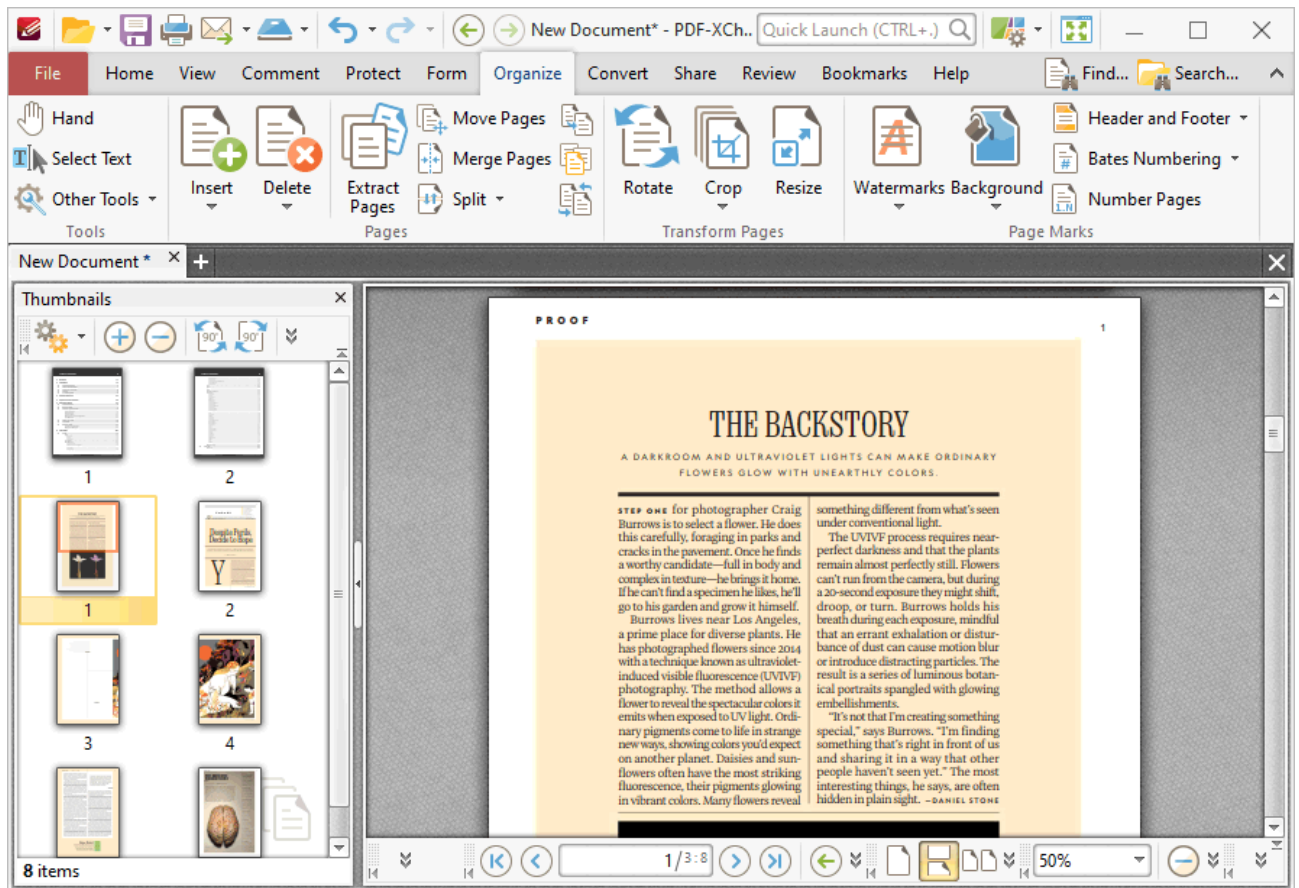

Figure 8. New Page Range

Note that the physical page numbers are also displayed in the **Page Navigation** toolbar. Additionally, the copyright and table of contents pages retain their existing page numbering. If desired, this can be adjusted as follows:

1. Click the **Organize** tab, then click **Number Pages**:

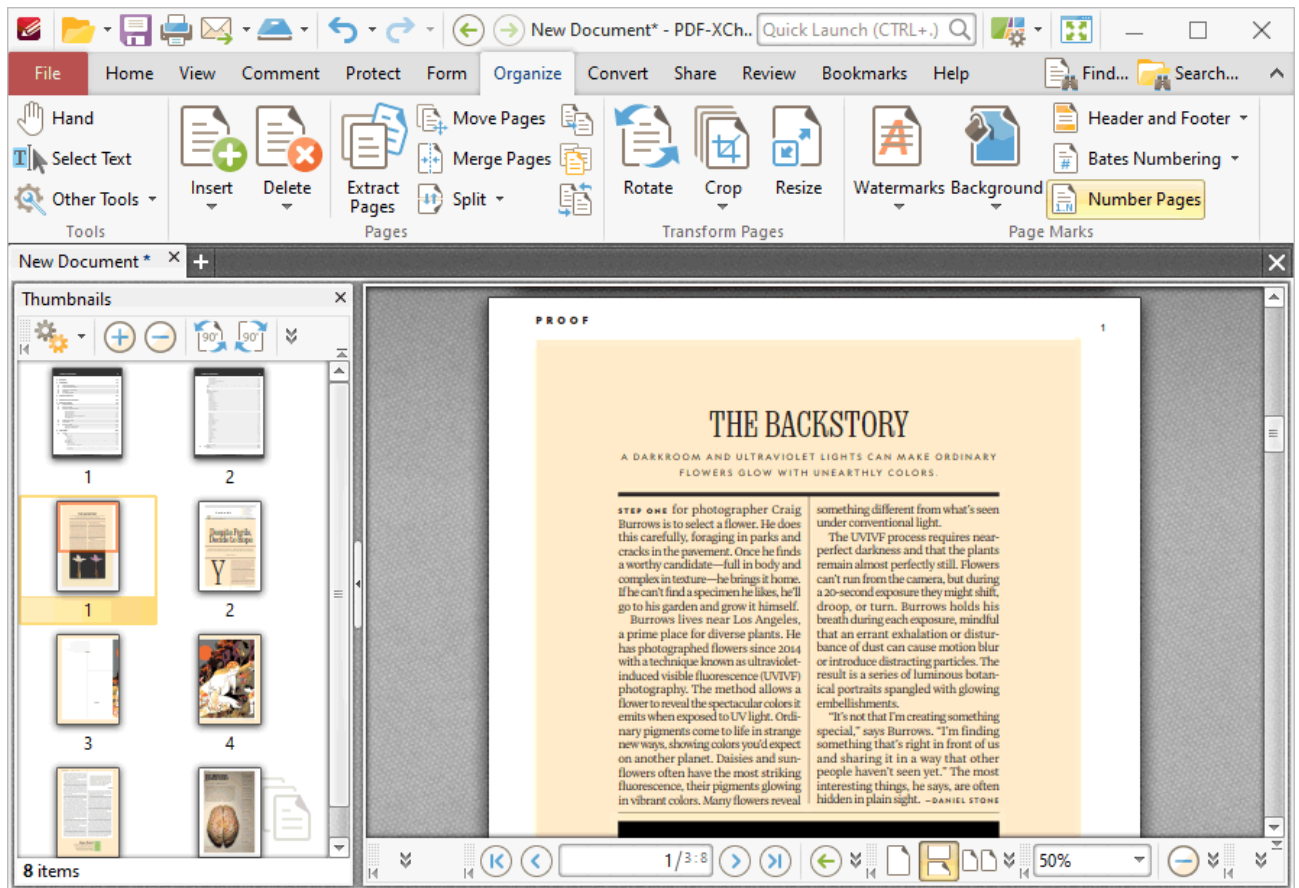

Figure 9. Organize Tab, Number Pages

The **Page Numbering** dialog box will open.

2. Click the page range that contains the copyright and table of contents pages, then click the **Style** dropdown menu and select a new style, such as Roman numerals:



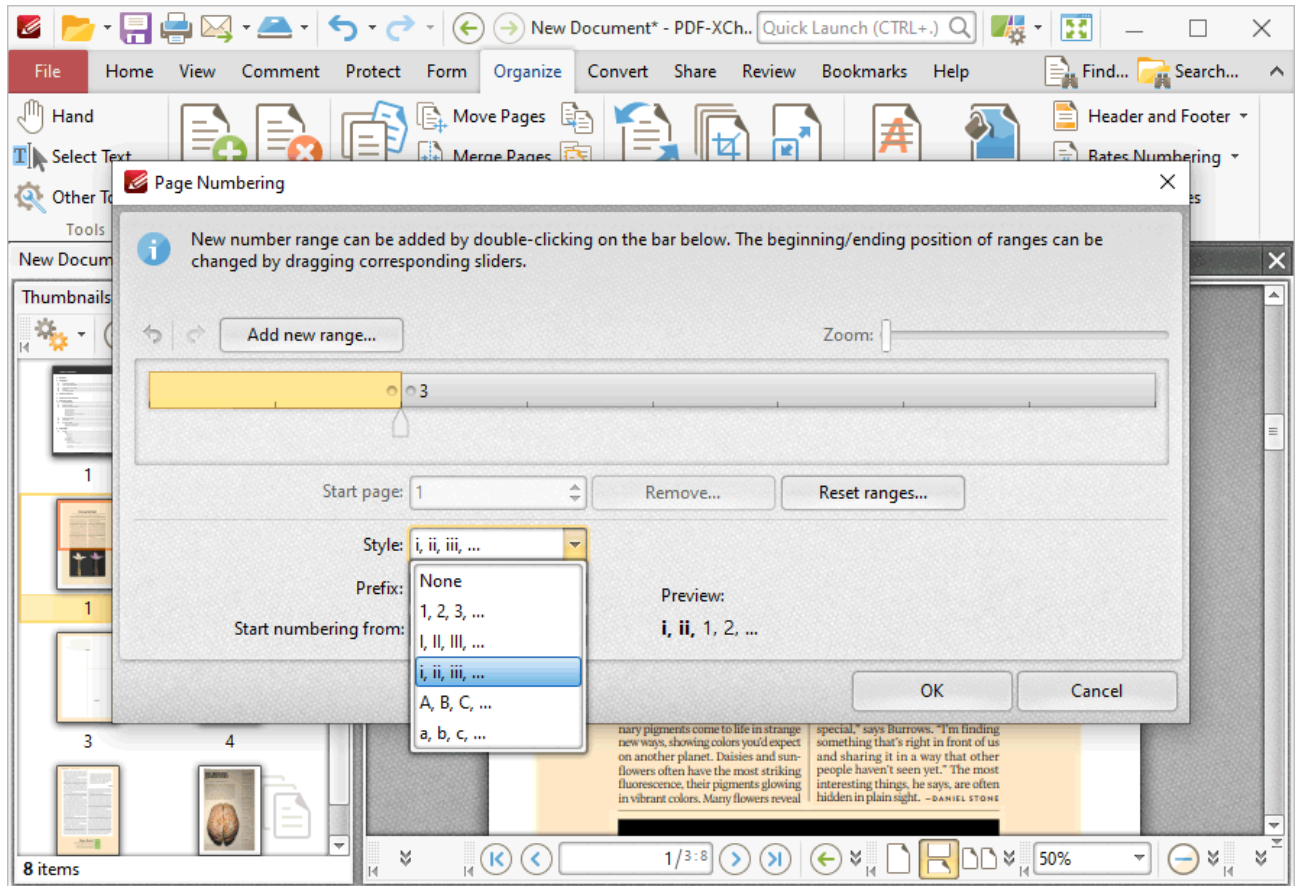

Figure 10. Page Numbering Dialog Box, Roman Numerals Selected

3. Click **OK**. The process is then complete:

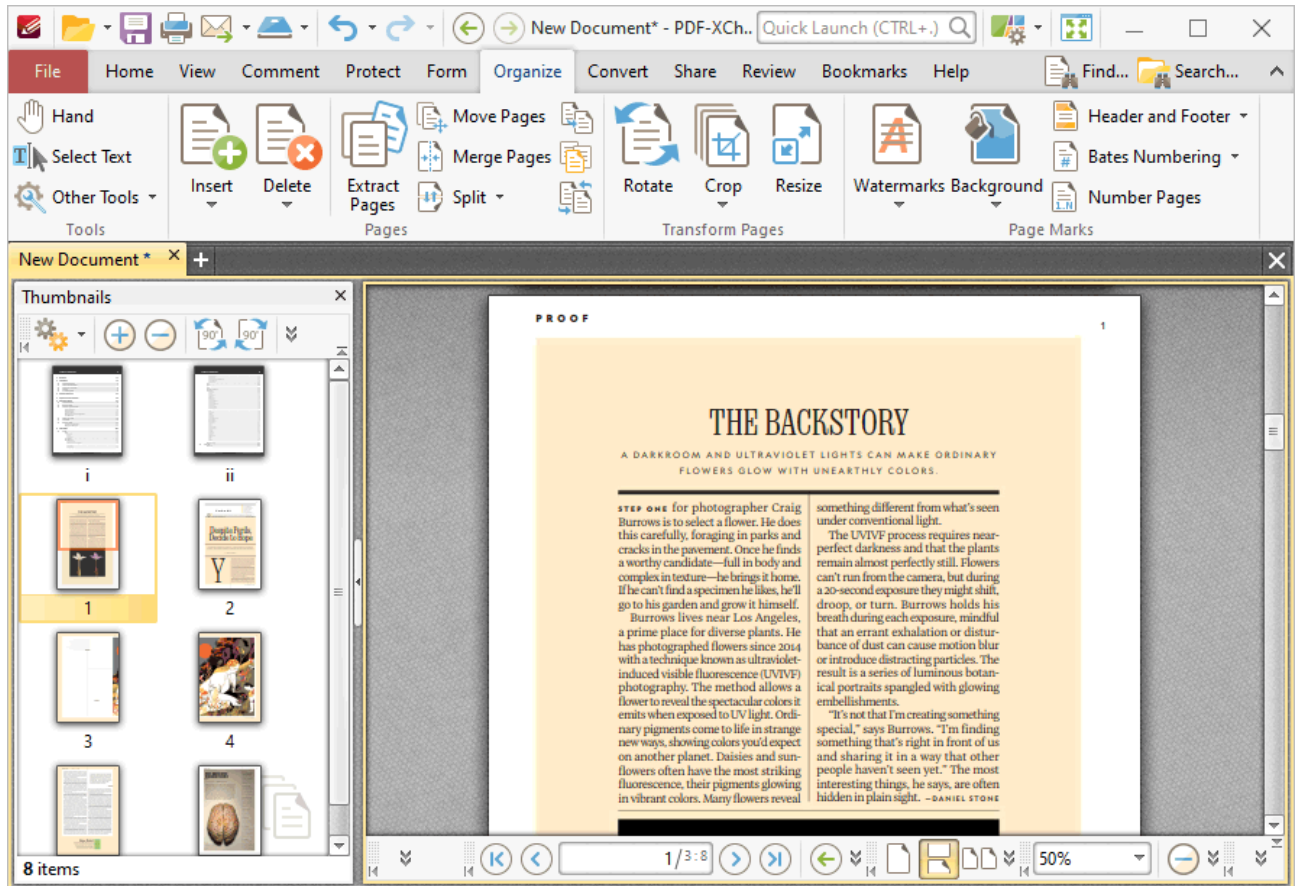

Figure 11. Number Pages Process Complete

10.4.8 Convert Tab



Convert Tab

When the **Convert** tab is selected, the following options are available:

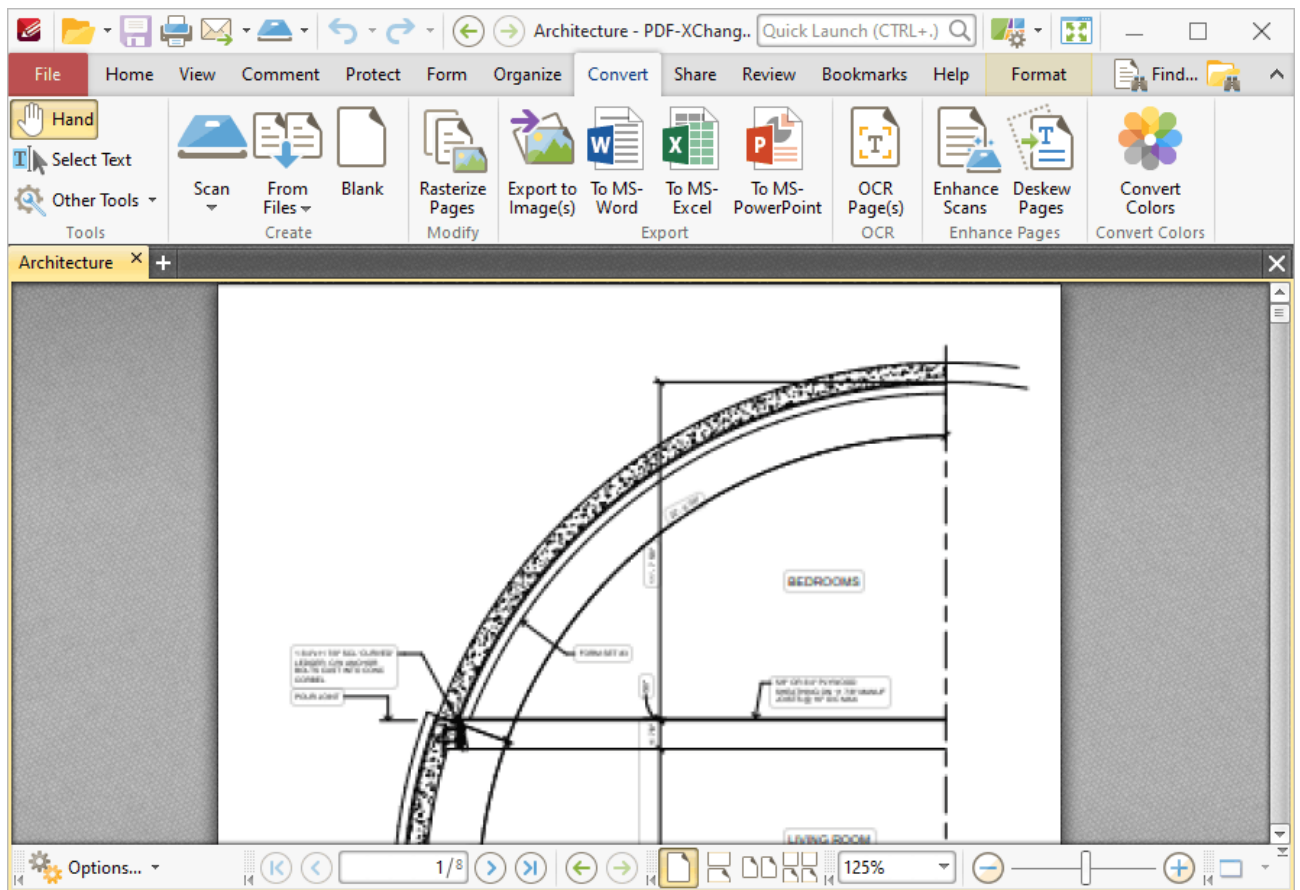
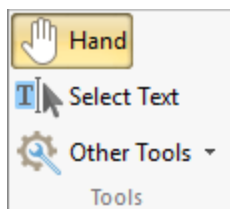

Figure 1. Convert Tab

The options in the **Convert** tab are used to convert content into different formats. There are four groups in the **Convert** tab:

**Tools**

The **Tools** group contains shortcuts to tools and other features:



- The **Hand Tool** is used as a basic scrolling device and navigation aid when browsing through documents. Click to enable the **Hand Tool**, then click and drag the page in the desired scrolling direction in order to browse through documents. Further information about the **Hand Tool** and its settings is available [here](#).<sup>943</sup>
- The **Select Text Tool** is used to select base-content text. Click to enable the **Select Text Tool**, then click and drag the pointer to select text. Double-click to select words, triple-click to select paragraphs and quadruple-click to select all text on the current page. Right-click selections for editing options, as detailed [here](#).<sup>1651</sup>
- Click the **Other Tools** dropdown menu to view/select additional tool options:
  - The **Select Comments Tool** is used to select and edit comments. Click to enable the **Select Comments Tool**, then click to select comments. Click and drag to select multiple comments. Selected comments can be edited, as detailed [here](#).<sup>1087</sup>
  - The **Snapshot Tool** is used to take screenshots of pages/selected page content. Click to enable the **Snapshot Tool**, then click or click and drag to take snapshots. Further information about this tool is available [here](#).<sup>926</sup>
  - The options in the **Clipboard** dropdown menu is used to interact with the current content of the clipboard. Click the dropdown menu to cut/copy/paste clipboard content.
  - The **Find** feature is used to [Find](#)<sup>1688</sup> or [Search](#)<sup>1776</sup> text, or to search the internet for text selected with the **Select Text Tool** in the current document.

## Create

The **Create** group contains options for creating new documents:

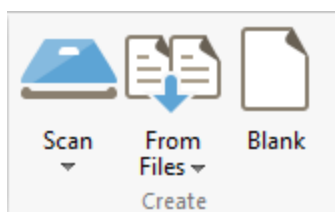

- Click **Scan** to create a new document from the local scanner, as detailed [here](#).<sup>829</sup> Click the **Scan** dropdown menu to view/select/configure preset scanning modes.
- Click the **From Files** dropdown menu to view options for creating new document from existing files:

- Click **Combine Files into a Single PDF** to combine existing files into a new document, as detailed [here](#).<sup>799</sup>
- Click **From Text Files** to create a new document from text files, as detailed [here](#).<sup>807</sup>
- Click **From Rich Text Format (RTF) Files** to create a new document from RTF files, as detailed [here](#).<sup>816</sup>
- Click **From Image Files** to create a new document from image files, a detailed [here](#).<sup>819</sup>
- Click **Blank** to create a new empty document.

## Modify

The **Modify** group contains the rasterize pages option:

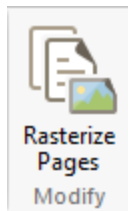

Click **Rasterize Pages** to rasterize document pages, as detailed [here](#).<sup>1534</sup>

## Export

The **Export** group contains options for exporting the current document to different formats:



- Click **Export to Images** to export documents to image format, as detailed [here](#).<sup>838</sup>
- Click **To MS-Word** to export documents to **MS Word** format. Note that files exported to this format are compatible with **MS Word 2010** and later.
- Click **To MS-Excel** to export documents to **MS Excel** format.
- Click **To MS-PowerPoint** to export documents to **MS Powerpoint** format.

## OCR

The **OCR** group contains options for interacting with scanned content:

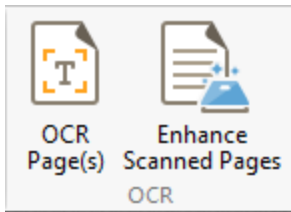

- Click **OCR Pages** to perform OCR on documents, as detailed [here.](#)<sup>1519</sup>

## Enhance Pages

The **Enhance Pages** group contains options for enhancing the quality of document pages:

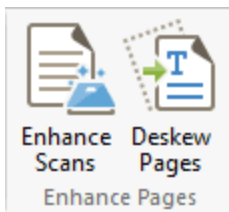

- Click **Enhance Scanned Pages** to enhance the quality of scanned pages, as detailed [here.](#)<sup>1526</sup>
- Click **Deskew Pages** to deskew pages that have been scanned crookedly. The **Deskew Pages** dialog box will open. Enter the page range of the pages that you want to deskew and then click **OK** to deskew pages.

## Convert Colors

The **Convert Colors** group contains the **Convert Colors** option:

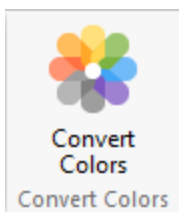

Click **Convert Colors** to convert document colors, as detailed [here.](#)<sup>1529</sup>

---

## 10.4.8.1 OCR Pages



## OCR Pages

Click **OCR Pages** to perform optical character recognition on documents:

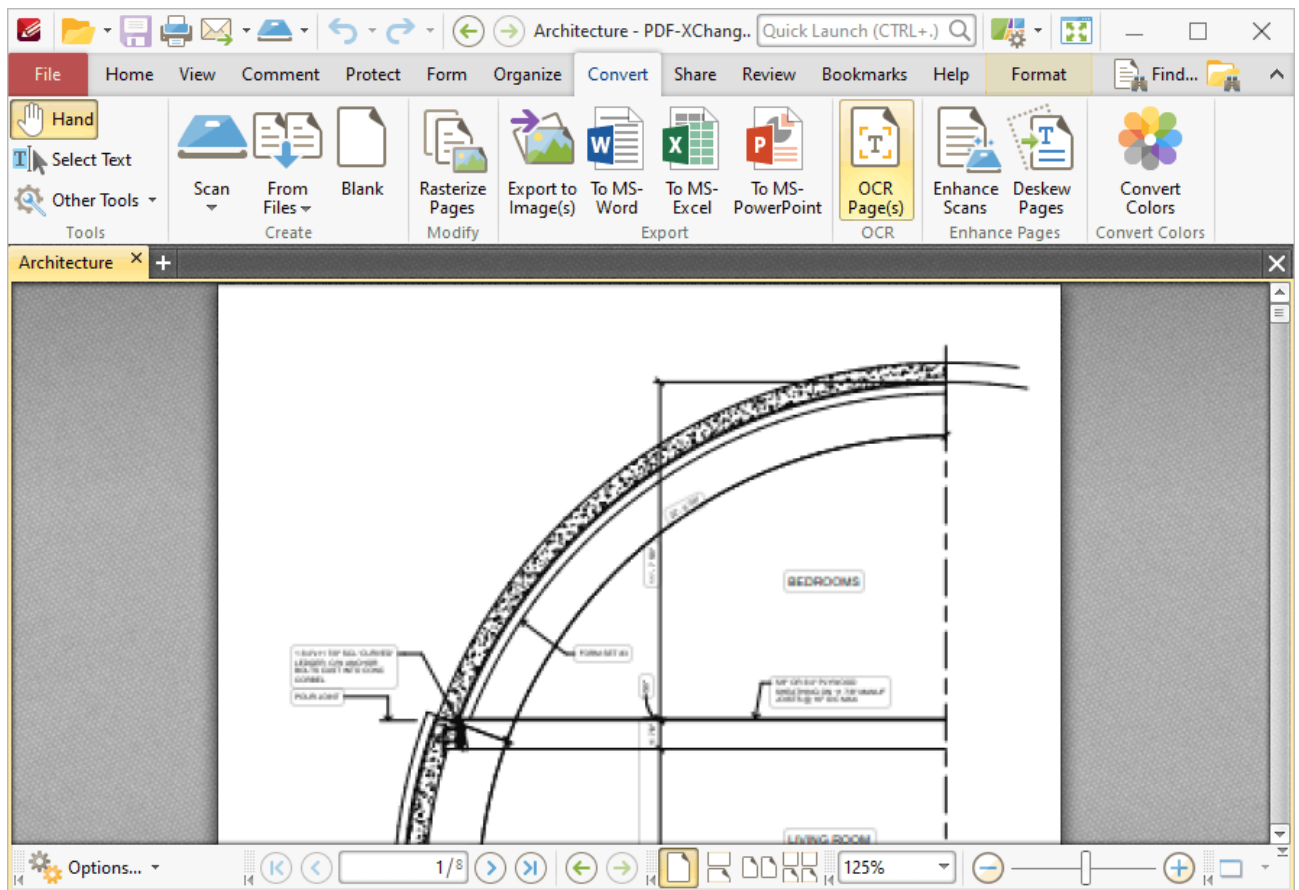

Figure 1. Convert Tab, OCR Pages

Note that two OCR engines are available in **PDF-XChange Editor** - the default OCR engine, which is available to all users, and the **Enhanced OCR** engine, which is available as an optional plugin. The **Enhanced OCR** engine is significantly faster and more accurate than the default OCR engine and it contains several extra features. Further information and purchasing options for the **Enhanced OCR** engine are available [here](#). You can use the **OCR Preferences** (available via the **Preferences** option in the **File** tab) to switch between default and enhanced OCR:

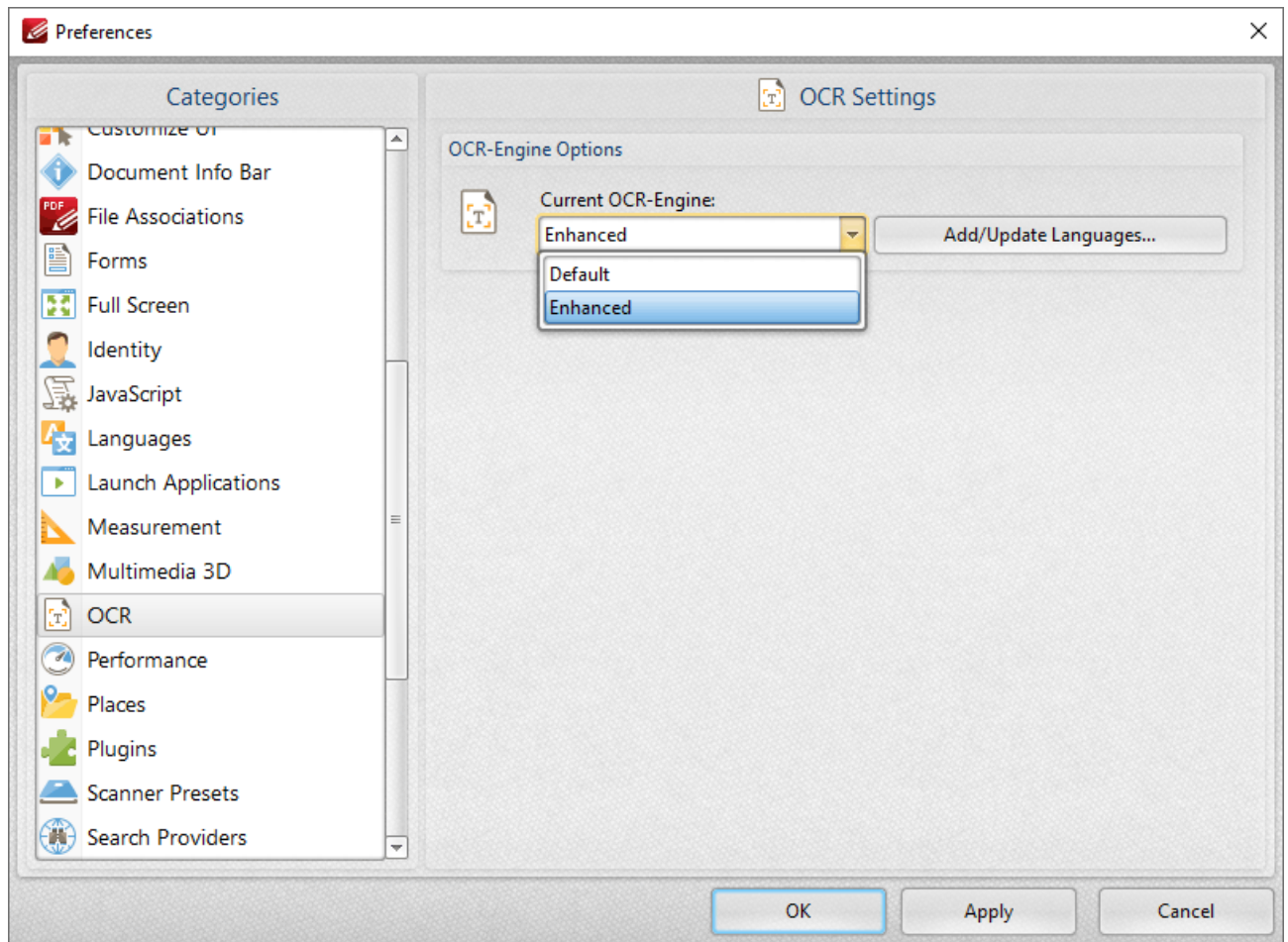

Figure 2. Preferences Dialog Box, OCR Category, OCR Engine Dropdown Menu

## Default OCR Engine

The default engine's OCR process in **PDF-XChange Editor** analyzes image-based documents, recognizes text and then places a duplicate, invisible text layer on top of it, which makes the source text selectable and searchable in the same manner as ordinary text. When this option is selected the **OCR Pages** dialog box will open:



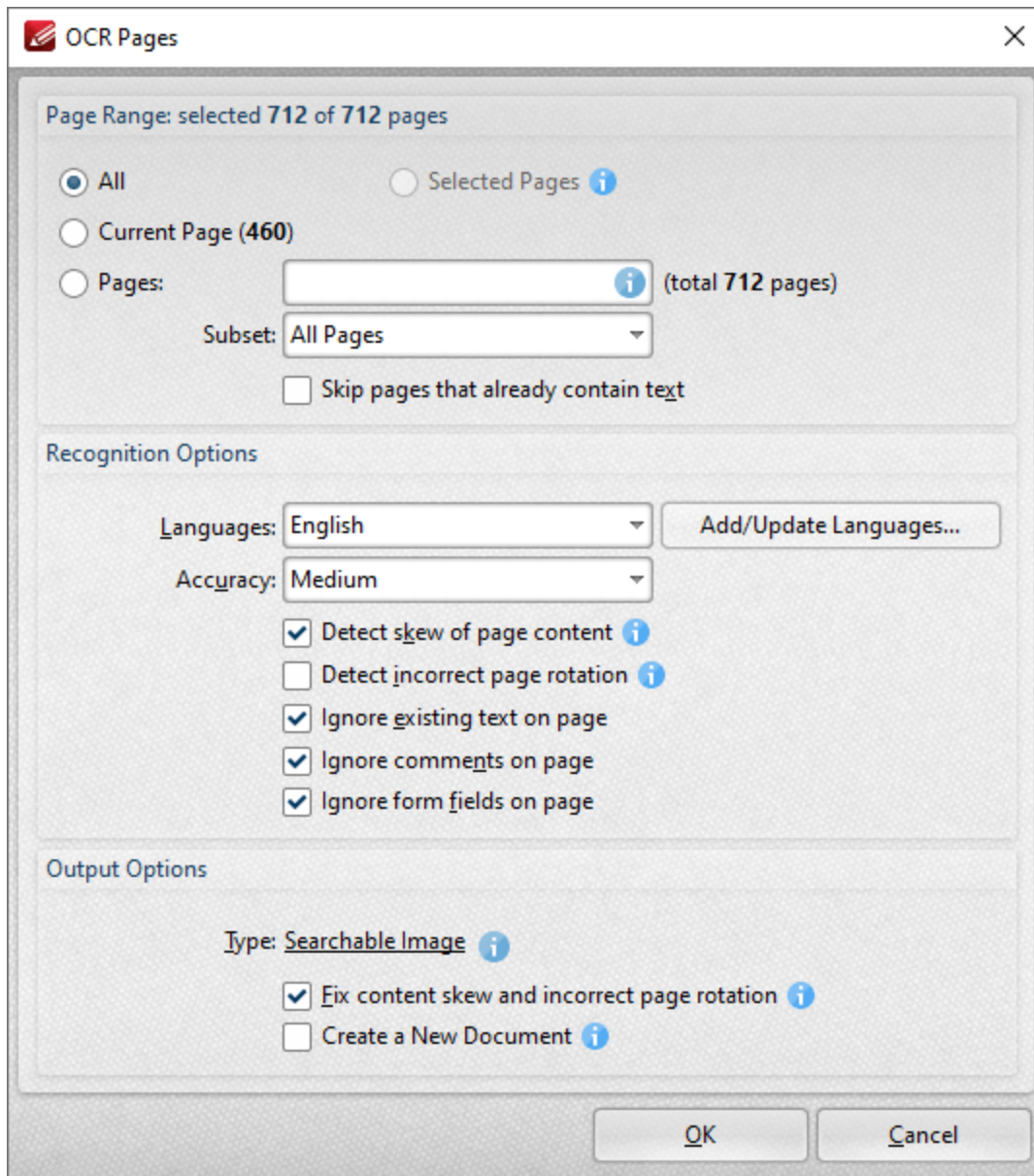

Figure 3. OCR Pages Dialog Box

Use the **Page Range** settings to determine the page range for OCR:

- Select **All** to specify all pages.
- Select **Current Page** to specify the current page.
- Select **Pages** to specify a custom page range. Further information on defining page ranges is available [here](#). Use the **Subset** dropdown menu to specify a subset of page ranges. Select **All Pages**, **Odd Pages Only** or **Even Pages Only** as desired.

Use the **Recognition Options** to determine the language and accuracy of the OCR process. Please note that increasing the accuracy also increases the time that the process takes and vice versa. Additionally, it should be noted that setting the accuracy to high may result in unusual output if the document

contains imperfections. This is because the software will search to a greater depth and may attempt to recognize imperfections as text. Click **Add/Update Languages** to add/update the language packs used for OCR.

- Select the **Detect skew of page content** box to enable automatic detection of skewed pages, which happens when documents are scanned crookedly.
- Select the **Detect incorrect page rotation** box to enable the automatic detection of incorrect page rotation in documents.
- Select the **Ignore existing text on page** box to omit existing text from the process of optical character recognition.
- Select the **Ignore comments on page** box to omit comments from the process of optical character recognition.
- Select the **Ignore form fields on page** box to omit form fields from the process of optical character recognition.

Use the **Output Options** to determine the format and quality of output from the OCR process:

- Select the **Fix content skew and incorrect page rotation** box to deskew pages that are scanned crookedly and auto-correct page rotation issues.
- Select the **Create a New Document** box to create a new document for the output of the optical character recognition. If this box is not selected, then the original document will be updated with the output instead.

Click **OK** to OCR documents.

## Enhanced OCR Engine

The **Enhanced OCR** dialog box appears as detailed below:

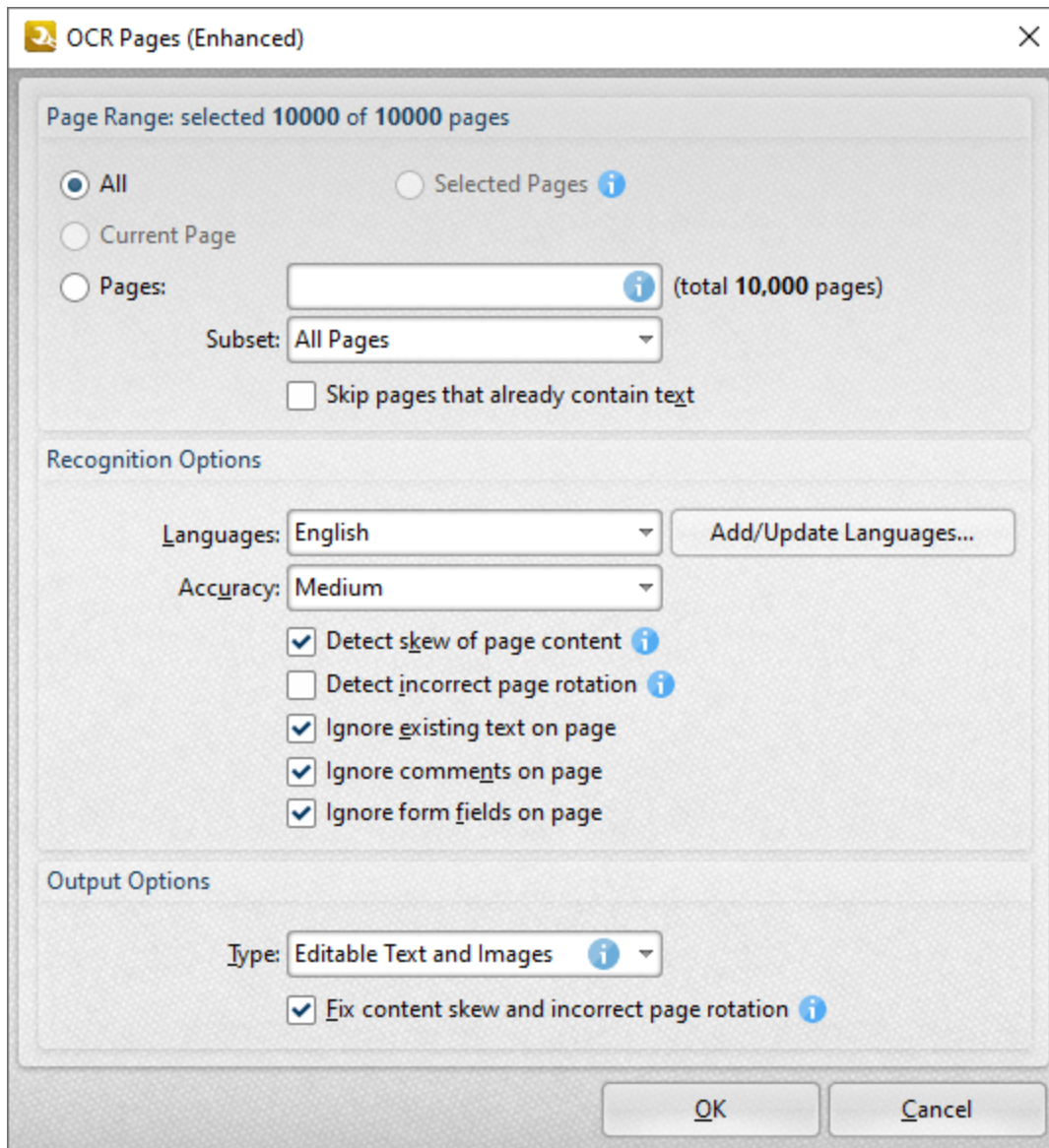

Figure 4. OCR Pages (Enhanced) Dialog Box

The options in this dialog box are the same as those detailed in **(figure 3)** but with additional **Output Options**, which are available in the dropdown menu:

- Select **Searchable Image** to retain the image-based content on which OCR is performed and insert a duplicate, invisible text layer on the text recognized during the operation. This will make the source text selectable and searchable in the same manner as ordinary text.
- Select **Editable Text and Images** to replace image-based text in source documents with the text recognized in the process of optical character recognition. This will convert image-based text into editable text, and retain existing content such as text and images.
- Select **Fine Page Content** to replace the content of source documents with new content that contains only the text and images recognized during optical character recognition.

Please note that in some cases (for example documents that contain one large graphic zone that takes up the whole page area and has some text zones over it) the visual output for **Editable Text and Images** and **Fine Page Content** will be very similar.

Click **OK** to OCR documents.

## OCR Selected Region

It is also possible to perform OCR on selected regions of documents. This is possible after either the [Snapshot Tool](#)<sup>926</sup> or the [Crop Page Tool](#)<sup>1486</sup> has been used to define a page area, and the option is available in the right-click shortcut menu. For example, click **Other Tools** in the **Organize** tab, then click **Snapshot Tool** and click and drag the mouse to define a snapshot area:

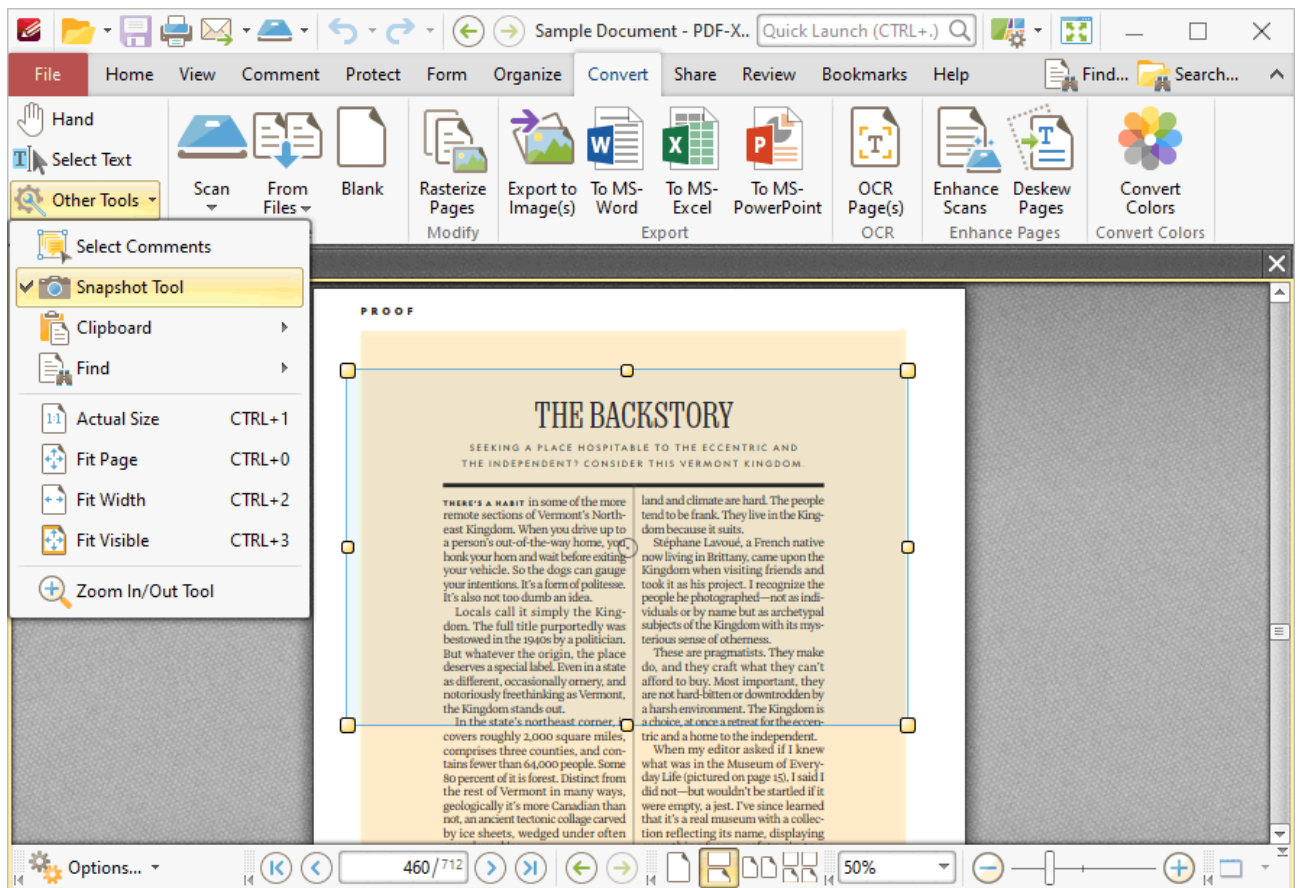

Figure 5. Active Snapshot Tool

When the area has been defined, right-click it and then click **OCR Selected Region** in the shortcut menu:

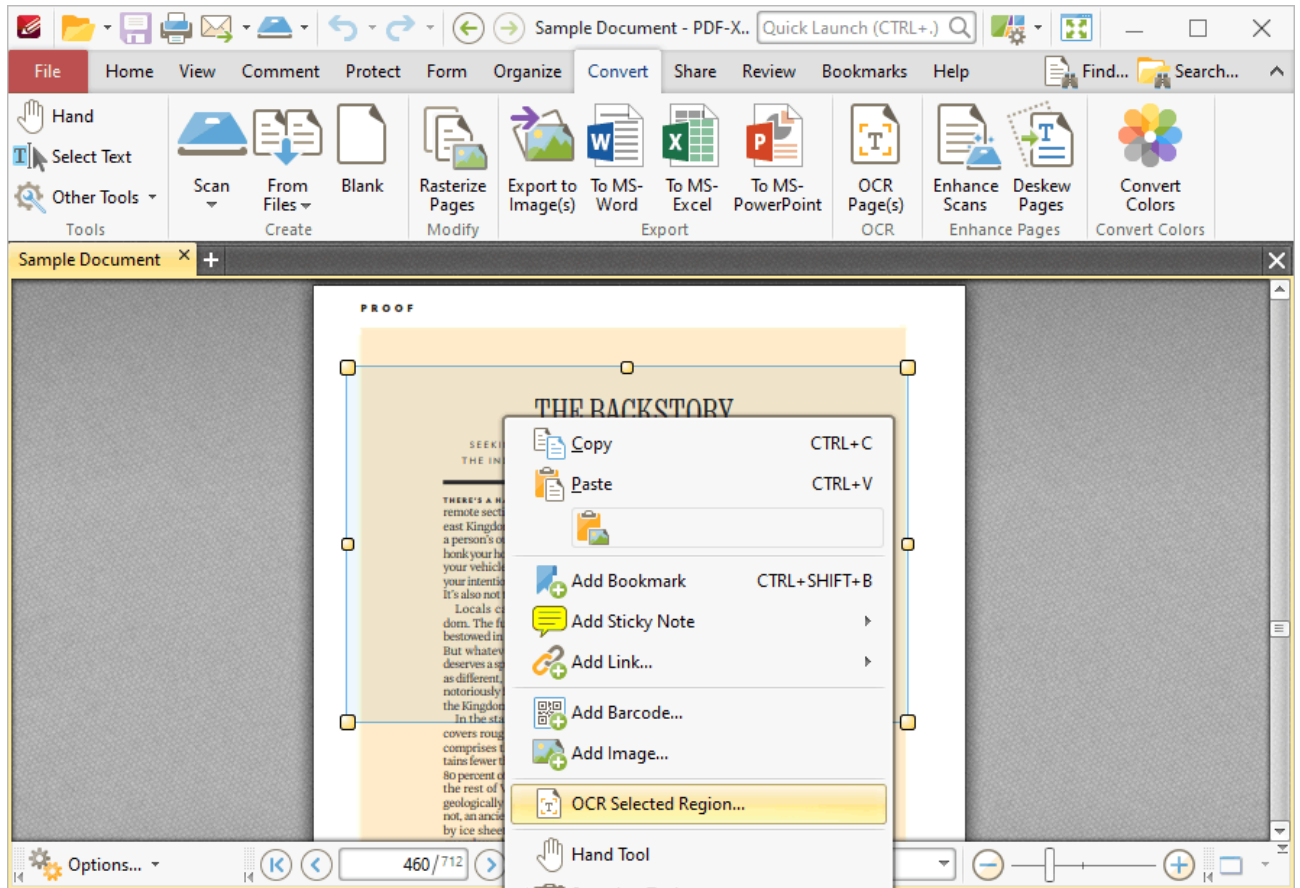

Figure 6. Right-Click Shortcut Menu, OCR Selected Region Highlighted

The **OCR Options** dialog box will open. Determine parameters as detailed above and then click **OK** to perform OCR on the selected region of the document.

10.4.8.2 Enhance Scanned Pages



Enhance Scanned Pages

Click **Enhance Scanned Pages** to enhance the quality of scanned pages:

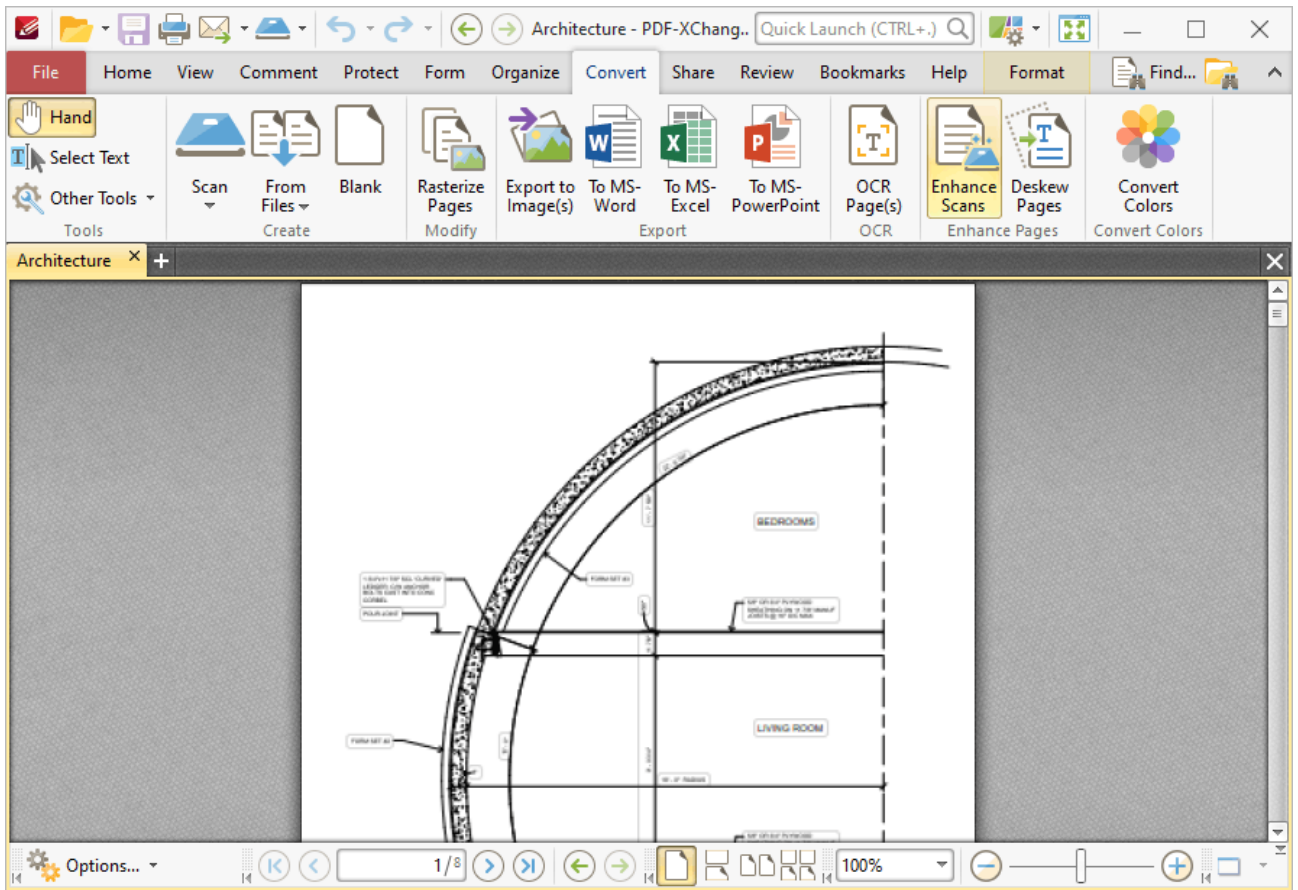

Figure 1. Convert Tab, Enhance Scanned Pages

The **Enhanced Scanned Pages** dialog box will open:

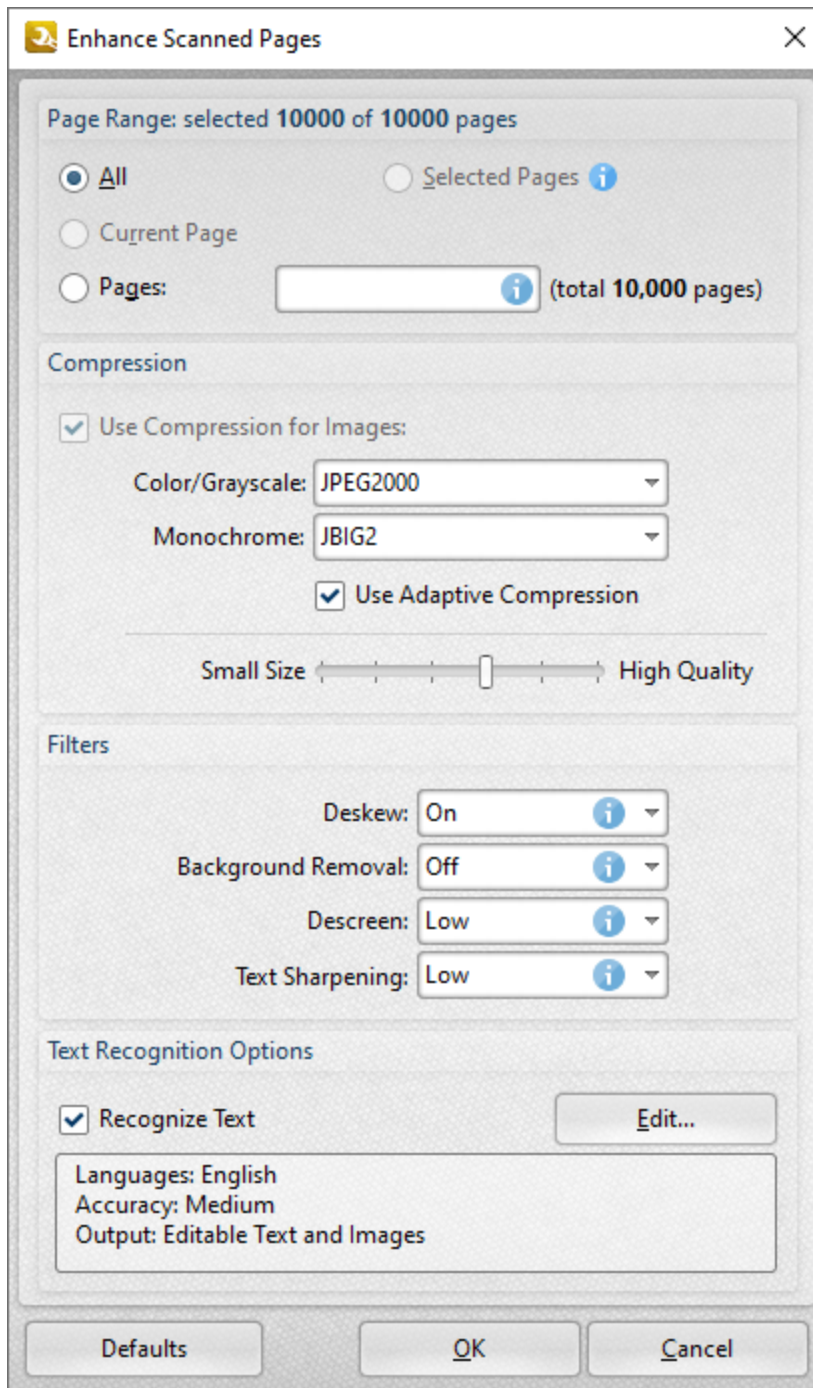

Figure 2. Enhance Scanned Pages Dialog Box

- Use the **Page Range** options to determine the page range to be enhanced. Page range options are detailed [here](#).
- Select the **Use Compression for Images** box to compress images, then use the **Color/Grayscale** and **Monochrome** dropdown menus to determine the type of compression for these formats.
- Select/clear the **Apply Adaptive Compression** box to enable/disable adaptive compression.

- Use the slider to select between **Small Size** and **High Quality** as desired.
- Use the **Filters** dropdown menus to set options for deskewing, background removal, descreening and text sharpening as desired.
- Select the **Recognize Text** box to perform [OCR](#) on pages.
- Click **Edit** to change the language and/or accuracy of the OCR operation. Note that increasing the accuracy will also increase the time taken to perform the operation and vice versa. Additionally, the OCR options available depend on the OCR engine currently in use, as **PDF-XChange Editor** now has an optional **Enhanced OCR** plugin that contains additional features to the default OCR engine. The differences between these engines are detailed [here](#).

Click **OK** to enhance pages.

---



10.4.8.3 Convert Colors



Convert Colors

Click **Convert Colors** to convert document colors:

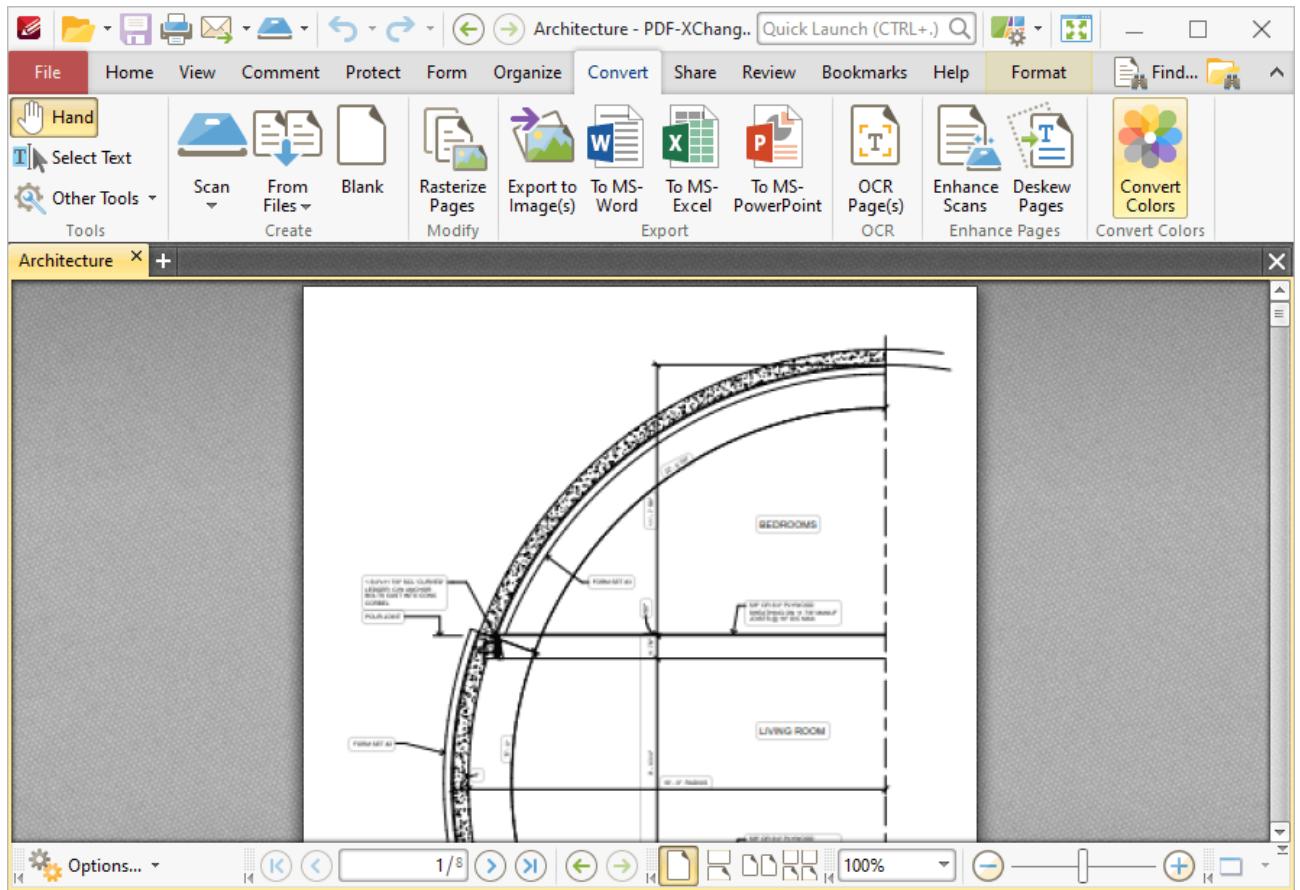

Figure 1. Convert Tab, Convert Colors

The **Convert Colors** dialog box will open:

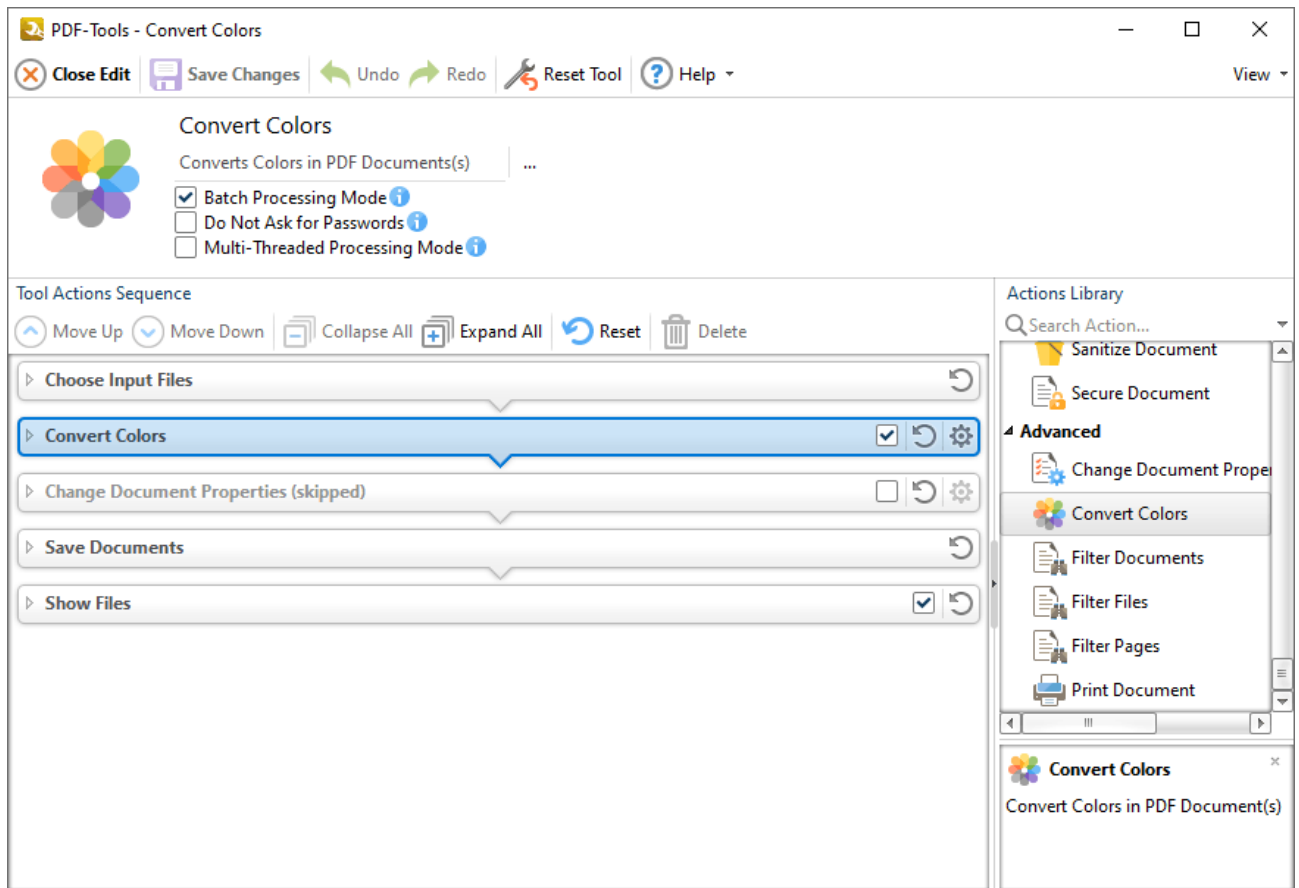

Figure 2. Convert Colors Dialog Box

- The default settings profile for color conversion are available in the pane on the left. If you want to create customized settings for color conversion, then click **Add** and customize the settings as detailed below:
  - Use the **Matching Criteria** section to determine the characteristics of content that will have its color converted:
    - Use the **Object Type** dropdown menu to specify the type of objects that you want to convert.
    - Use the **Color Type** dropdown menu to specify the color space you want to convert.
    - Use the **Minimum/Maximum Text Size** dropdown menus to specify the minimum/maximum size for converted text.
  - Use the **Conversion Attributes** to determine how the colors of objects in the document that meet the **Matching Criteria** are converted:
    - Use the **Convert Command** dropdown menu to determine the conversion operation performed:
      - **Preserve** preserves objects from conversion.
      - **Convert to Profile** converts objects to the destination colorspace using the profile selected in the **Conversion Profile** dropdown menu.

- **Decalibrate** removes embedded profiles from objects.
- Use the **Conversion Profile** dropdown menu to determine the profile to which objects are converted. Select the **Embed** box to tag objects with the selected **ICC** profile to calibrate color, which is useful when PDFs are shared between users on different devices.
- Use the **Rendering Intent** dropdown menu to determine the rendering intent used during color conversion.
- Use the **Convert Options** to determine additional options:
  - Select the **Convert Colors to Output Intent** box to convert document colors to the **Output Intent** specified in the **Rendering Intent** dropdown menu. Note that documents must contain the output intent profile in order for their colors to be converted.
  - Select the **Preserve Black** box to preserve black objects in **CMYK, RGB** or **Grayscale** content of converted documents, for example to prevent **RGB** text from converting into rich black **CMYK** when conversion is performed.
  - Select the **Preserve CMYK Primitives** to preserve colors that contain only one colorant.
  - Select the **Promote Gray to CMYK Black** to convert device gray to CMYK black with only a black component.
- Use the **Page Range** options to determine the page range on which color conversion takes place in input documents. Further information on the specification of page ranges is available [here](#).<sup>1772</sup>
- Click **Document Colors** to view a breakdown of colors in the current document and determine which colors are converted, as detailed below.
- Click the **Settings** dropdown arrow to save/manage/delete custom settings:
  - Click **Save Current Settings** to save the current settings as a profile for subsequent use.
  - Click **Delete** to delete selected profiles. Note that this option is only available for customized profiles.
  - Click **Manage** to manage preset/customized profiles. The **Manage Presets** dialog box will open:

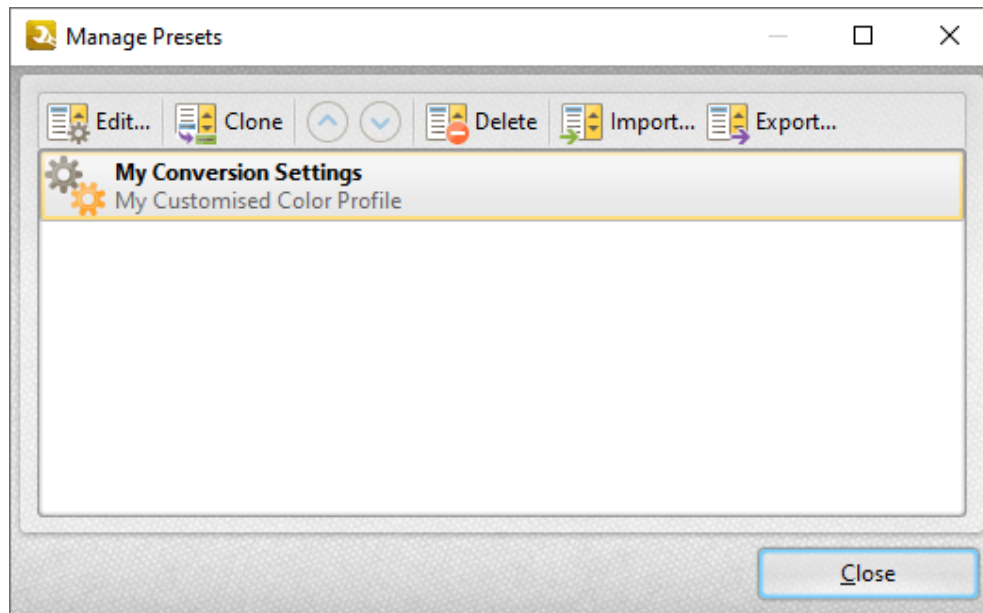

Figure 3. Manage Presets Dialog Box

- Click **Edit** to edit selected profiles. Note that this option is only available for customized profiles.
- Click **Clone** to clone selected profiles. This option can be used to customize the settings of preset profiles, which cannot be customized in the default state.
- Use the up and down arrows to move selected profiles up or down in the list.
- Click **Delete** to delete selected profiles. Note that this option is only available for customized profiles.
- Click **Import** to import profiles from a saved file.
- Click **Export** to export profiles to file.

## Document Colors

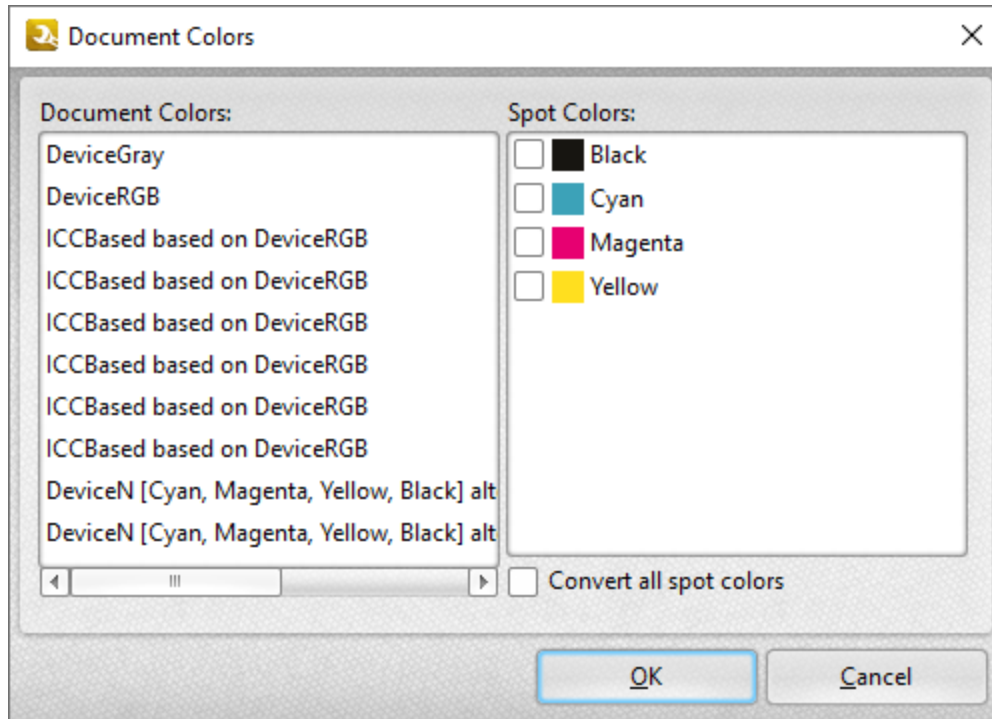

Figure 4. Document Colors Dialog Box

All colors contained in the document are detailed in this dialog box. Select the boxes of spot colors to include them in the conversion, or select the **Convert all spot colors** box to convert all spot colors.

---

#### 10.4.8.4 Rasterize Pages



### Rasterize Pages

Click **Rasterize Pages** to rasterize document pages:

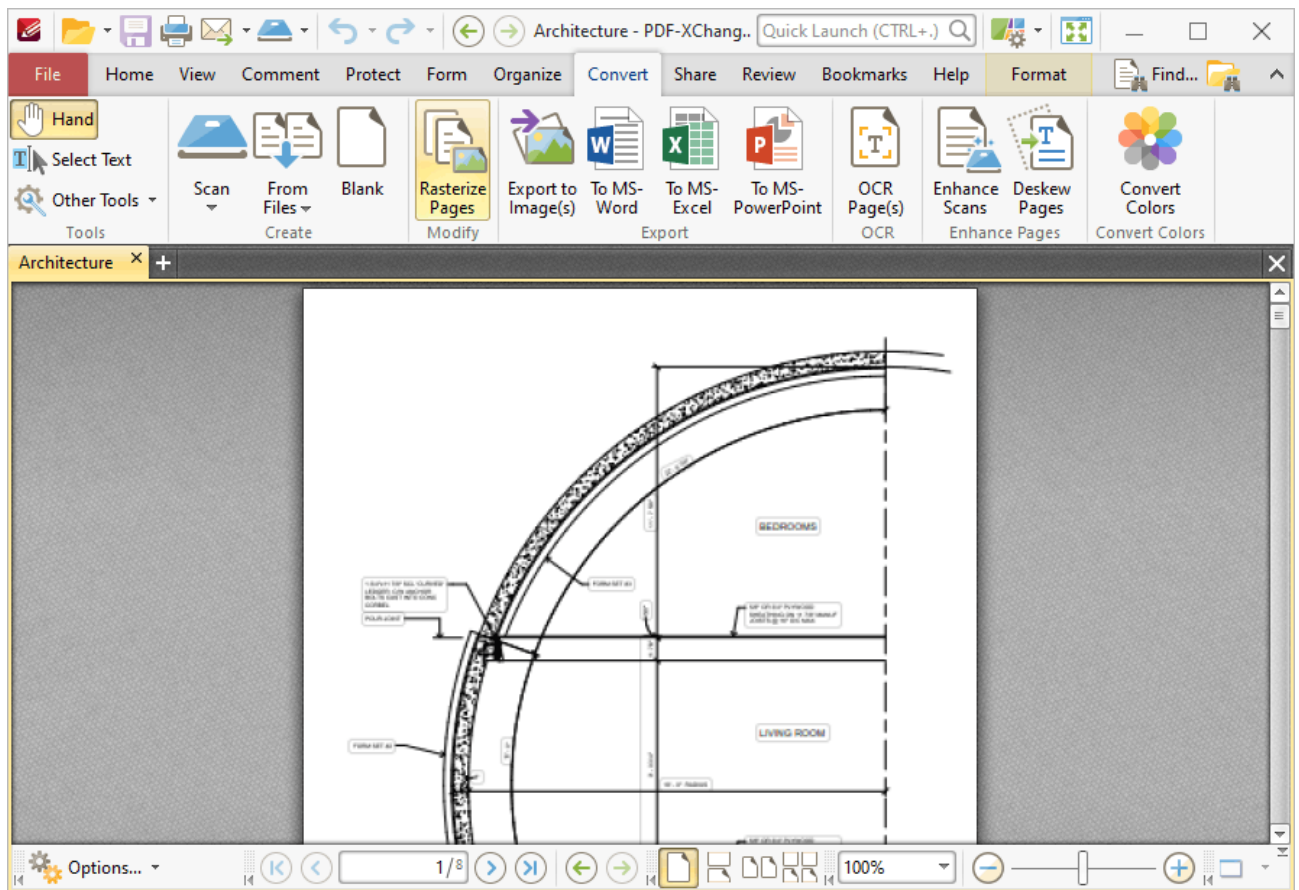

Figure 1. Convert Tab, Rasterize Pages Highlighted

Rasterization converts vector graphics into raster images. The main purpose of this process is to preserve resolution, as rasterized images always display in the the same manner regardless of their size. Vector images may not scale or print to an acceptable standard, and many printers use dots in order to print - which means they must first rasterize the content. This can become a problematic process, and if you instead perform the rasterization before printing then you can avoid these issues.

When this feature is selected, the **Rasterize Pages** dialog box will open:

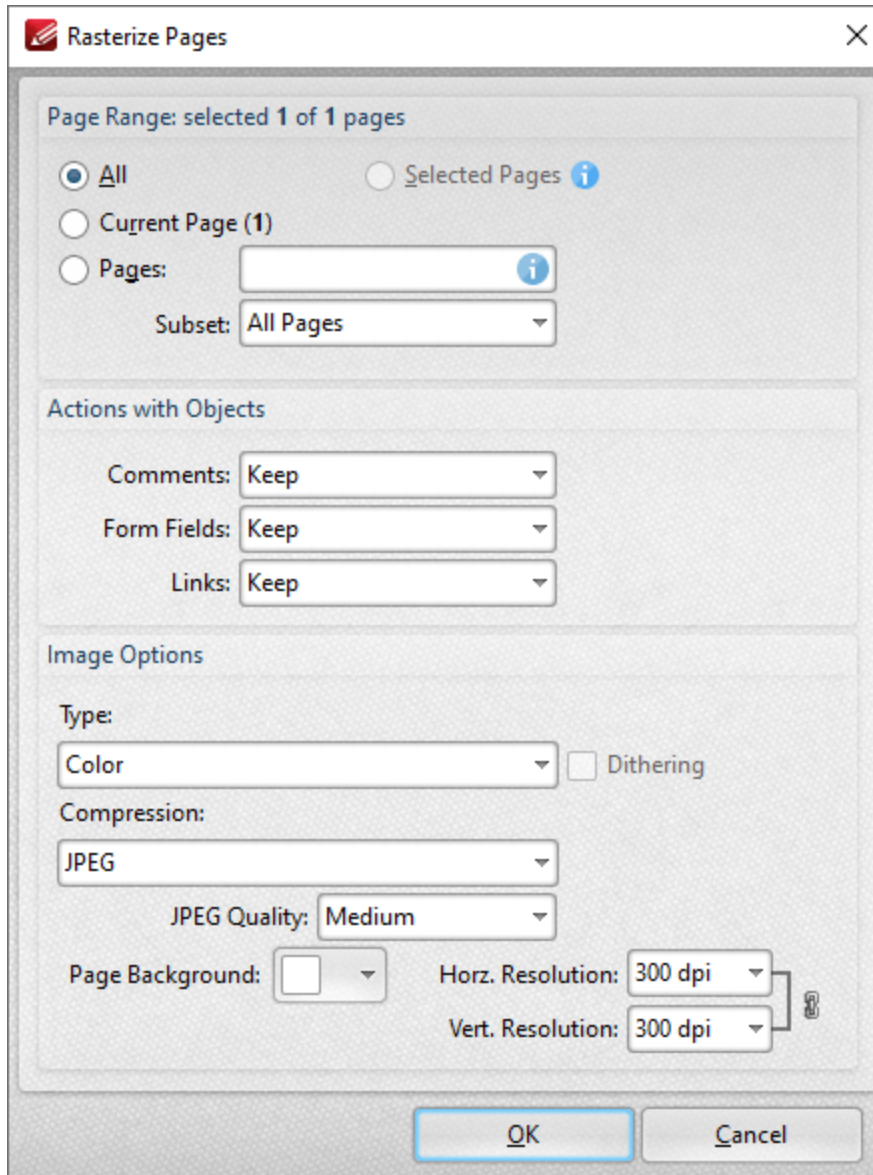

Figure 2. Rasterize Pages Dialog Box

- Use the **Page Range** options to determine the page range to be rasterized. Page range settings are detailed [here](#).<sup>1773</sup>
- Use the **Actions with Objects** dropdown menus to determine the action taken for comments, form fields and links when rasterization is performed.
- Use the **Type** dropdown menu to determine the type of rasterization performed on the document.
- Use the **Compression** dropdown menu to determine the type of compression used for the rasterization.

- Use the **Page Background** dropdown menu to determine the fill color for transparent sections of the document when rasterization takes place.
- Use the **JPEG Quality** dropdown menu to determine the JPEG quality when JPEG compression is used.
- Use the **Horizontal and Vertical Resolution** number boxes to determine the resolution of rasterized images.

Click **OK** to rasterize pages.

---



10.4.9 Share Tab



Share Tab

When the **Share** tab is selected, the following options are available:

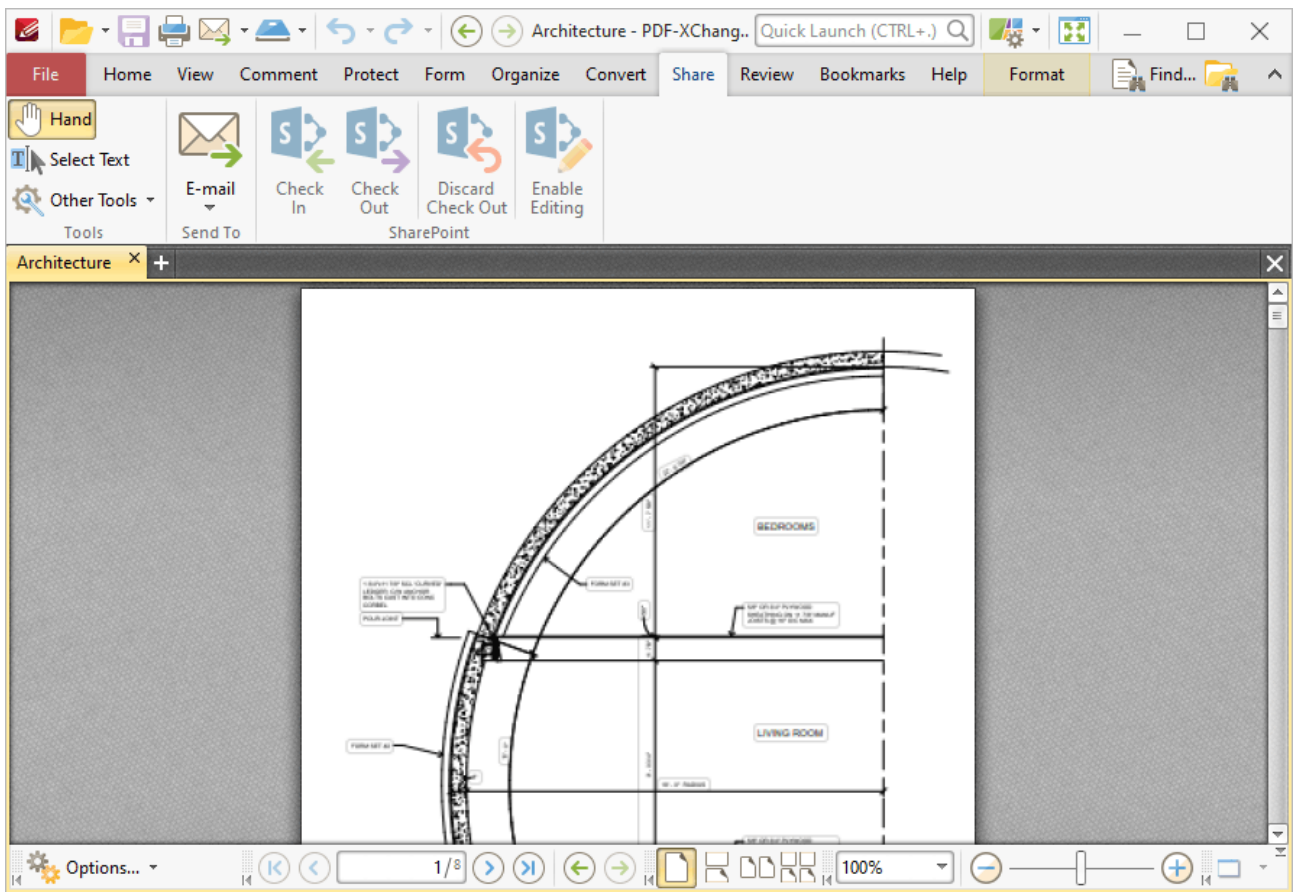
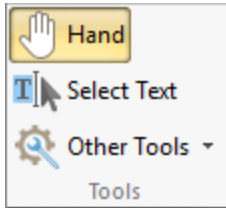

Figure 1. SharePoint Submenu

The options in the **Share** tab are used to interact with **SharePoint** files and email documents from **PDF-XChange Editor**. **SharePoint** facilitates the convenient sharing of files for group viewing/editing. There are three groups in the **Share** tab:

**Tools**

The **Tools** group contains shortcuts to tools and other features:



- The **Hand Tool** is used as a basic scrolling device and navigation aid when browsing through documents. Click to enable the **Hand Tool**, then click and drag the page in the desired scrolling direction in order to browse through documents. Further information about the **Hand Tool** and its settings is available [here](#).<sup>[943]</sup>
- The **Select Text Tool** is used to select base-content text. Click to enable the **Select Text Tool**, then click and drag the pointer to select text. Double-click to select words, triple-click to select paragraphs and quadruple-click to select all text on the current page. Right-click selections for editing options, as detailed [here](#).<sup>[1651]</sup>
- Click the **Other Tools** dropdown menu to view/select additional tool options:
  - The **Select Comments Tool** is used to select and edit comments. Click to enable the **Select Comments Tool**, then click to select comments. Click and drag to select multiple comments. Selected comments can be edited, as detailed [here](#).<sup>[1087]</sup>
  - The **Snapshot Tool** is used to take screenshots of pages/selected page content. Click to enable the **Snapshot Tool**, then click or click and drag to take snapshots. Further information about this tool is available [here](#).<sup>[926]</sup>
  - The options in the **Clipboard** dropdown menu is used to interact with the current content of the clipboard. Click the dropdown menu to cut/copy/paste clipboard content.
  - The **Find** feature is used to [Find](#)<sup>[1688]</sup> or [Search](#)<sup>[1776]</sup> text, or to search the internet for text selected with the **Select Text Tool** in the current document.

## Send To

The **Send To** group contains only the **Email** feature:



- Click **Email** to email the current document in **PDF-XChange Editor**. This feature uses the settings determined in the **Email** preferences, which are detailed [here](#).<sup>[919]</sup>
- Click the **Email** dropdown menu to select/manage presets for the **Email** feature.

## SharePoint

The **SharePoint** group contains options for interacting with documents located in a **SharePoint** server:

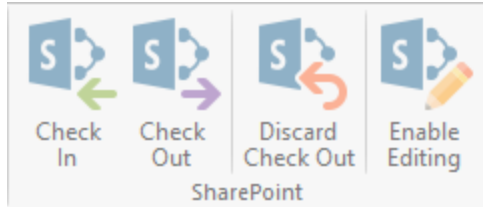

- Click **Check In/Out** to check the current document in to/out from a **SharePoint** server.
- Click **Discard Check Out** to discard documents currently checked out from a **SharePoint** server. Note that unsaved changes are lost when this option is used.
- Click **Enable Editing** to enable editing for **SharePoint** files.

## Opening SharePoint Files in PDF-XChange Editor

Follow the steps below to open **SharePoint** files:

1. Click the **File** tab.
2. Click **Add a Place**, then click **SharePoint**:

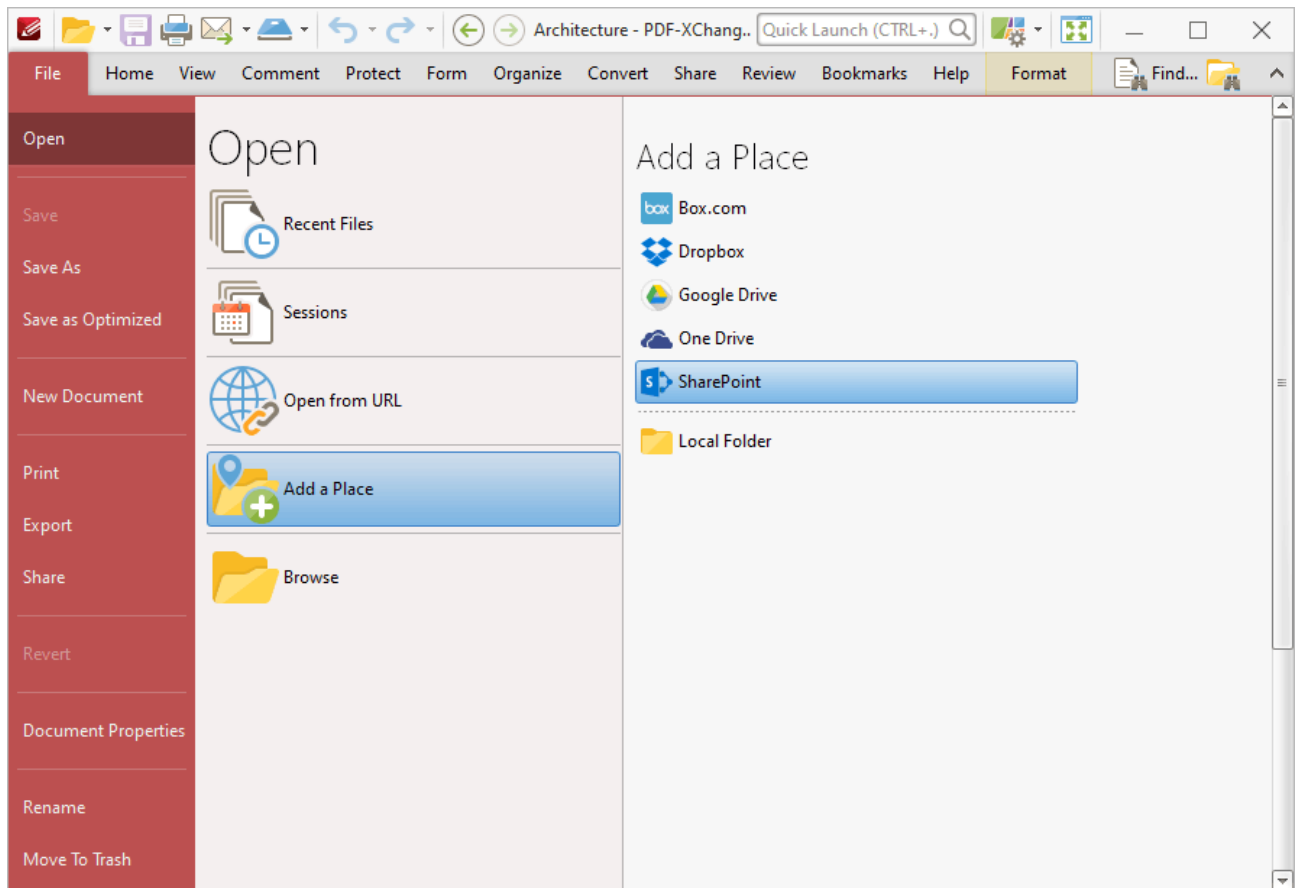

Figure 2. File Tab, Add a Place, SharePoint

The **PDF-XChange Editor** dialog box will open.

3. Enter the URL for the **SharePoint** file, then click **Connect**.

The **Authentication Required** dialog box will open.

4. Enter the **SharePoint** credentials and click **OK**.

The **Open File** dialog box will open.

5. Select the desired file from the list and click **Open** or **Open with Check Out**. Click **Open** to make the file both available and editable for other users. Click **Open with Check Out** to make the file editable for the current user only, and read-only for other users. Further information on **SharePoint** files is available [here](#).

10.4.10 Review Tab



**Review Tab**

When the **Review** tab is selected, the following options are available:

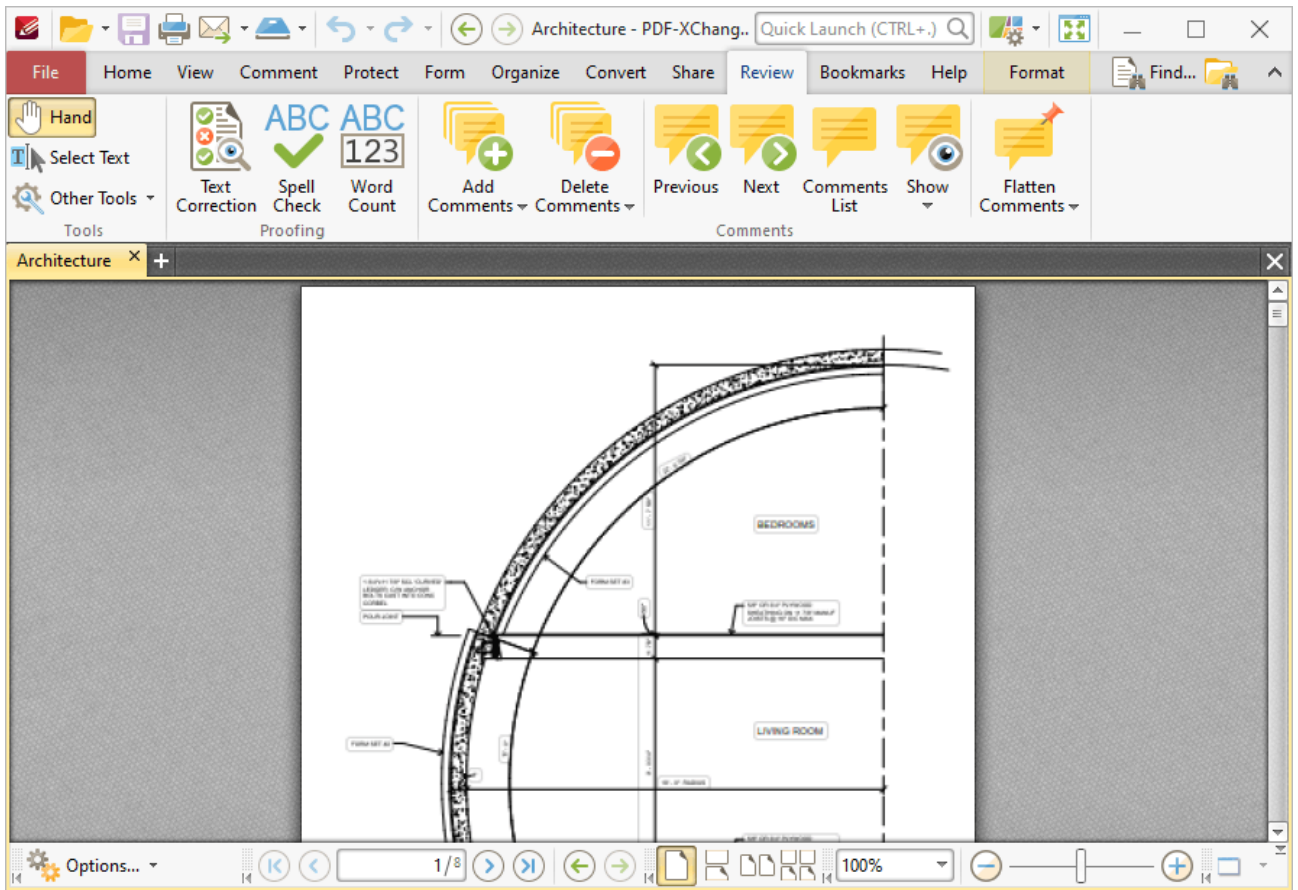
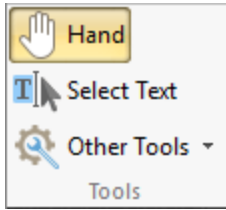

Figure 1. Review Tab

The options in the **Review** tab are used to edit, analyze and update documents and document comments. There are three groups in the **Review** tab:

**Tools**

The **Tools** group contains shortcuts to tools and other features:



- The **Hand Tool** is used as a basic scrolling device and navigation aid when browsing through documents. Click to enable the **Hand Tool**, then click and drag the page in the desired scrolling direction in order to browse through documents. Further information about the **Hand Tool** and its settings is available [here](#).<sup>943</sup>
- The **Select Text Tool** is used to select base-content text. Click to enable the **Select Text Tool**, then click and drag the pointer to select text. Double-click to select words, triple-click to select paragraphs and quadruple-click to select all text on the current page. Right-click selections for editing options, as detailed [here](#).<sup>1651</sup>
- Click the **Other Tools** dropdown menu to view/select additional tool options:
  - The **Select Comments Tool** is used to select and edit comments. Click to enable the **Select Comments Tool**, then click to select comments. Click and drag to select multiple comments. Selected comments can be edited, as detailed [here](#).<sup>1087</sup>
  - The **Snapshot Tool** is used to take screenshots of pages/selected page content. Click to enable the **Snapshot Tool**, then click or click and drag to take snapshots. Further information about this tool is available [here](#).<sup>926</sup>
  - The options in the **Clipboard** dropdown menu is used to interact with the current content of the clipboard. Click the dropdown menu to cut/copy/paste clipboard content.
  - The **Find** feature is used to [Find](#)<sup>1688</sup> or [Search](#)<sup>1776</sup> text, or to search the internet for text selected with the **Select Text Tool** in the current document.

## Proofing

The **Proofing** group contains options for proofing documents:

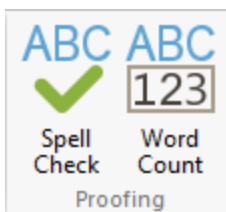

- Click **Spell Check** to perform a spell check on the current document. This feature is detailed [here](#).<sup>1545</sup>
- Click **Word Count** to perform a word count on the current document.

## Comments

The **Comments** tab contains options for adding, deleting and editing comments:

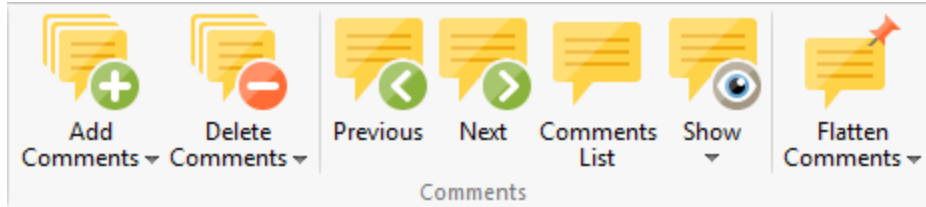

- Click the **Add Comments** dropdown menu to add comments to the current document:
  - Click **Add Sticky Note** to add a sticky note comment. The **Sticky Note** feature is detailed [here](#).<sup>1105</sup>
  - Click **Highlight Text** to add highlights to selected text. Use the **Select Text Tool**, detailed above, to select text to highlight with this feature. The **Highlight Text** tool is detailed [here](#).<sup>1120</sup>
  - Click **Underline Text** to add underlines to selected text. Use the **Select Text Tool**, detailed above, to select text to underline with this feature. The **Underline Text** tool is detailed [here](#).<sup>1125</sup>
  - Click **Crossout Text** to strike out selected text. Use the **Select Text Tool**, detailed above, to select text to strike out with this feature. The **Strikeout Text** tool is detailed [here](#).<sup>1130</sup>
- Click the **Delete Comments** dropdown menu to view/select options for deleting comments:
  - Click **Delete Selected Comments** to delete comments currently selected in the document. Use the [Select Comments](#)<sup>1087</sup> tool to select comments to delete with this feature.
  - Click **Delete Visible Comments** to delete all comments that are visible in the document. Use the **Show** feature detailed below to determine which comments are shown/hidden. Hidden comments are not deleted when the **Delete Visible Comments** feature is used.
  - Click **Delete All Comments** to delete all comments in the current document.
- Click **Previous/Next** to move to the previous/next comment.
- Click **Comments List** to show/hide the [Comments](#)<sup>1007</sup> pane.
- Click the **Show** dropdown menu to determine which comments are shown/hidden in the current document:
  - Click **Show All Comments** to display all comments, in both the **Comments** pane and the active document.
  - Click **Hide All Comments** to hide all comments, in both the **Comments** pane and the active document.
  - Hover over **By Type, By Author, Checked or By Status** to determine the display status of comments according to their type, author, checked/unchecked value in the **Comments** pane, or status. A submenu will be displayed that details all available options for the selected method. Select an option from the list as desired.
  - Click **Open/Close All Pop-ups** to open/close all comment pop-ups.

- Click the **Flatten Comments** dropdown menu for options to flatten comments in the current document. Comments are moved to the base content layer of documents when they are flattened and can no longer be edited:
    - Click **Flatten Selected Comments** to flatten the comments selected in the current document. Use the [Select Comments](#)<sup>1087</sup> tool to select comments to flatten with this feature.
    - Click **Flatten Comments** to flatten all comments from a user-specified page range in the current document. This feature is detailed [here](#).<sup>1236</sup>
-



10.4.10.1 Spell Check



Spell Check

Click **Spell Check** to launch the spell check feature:

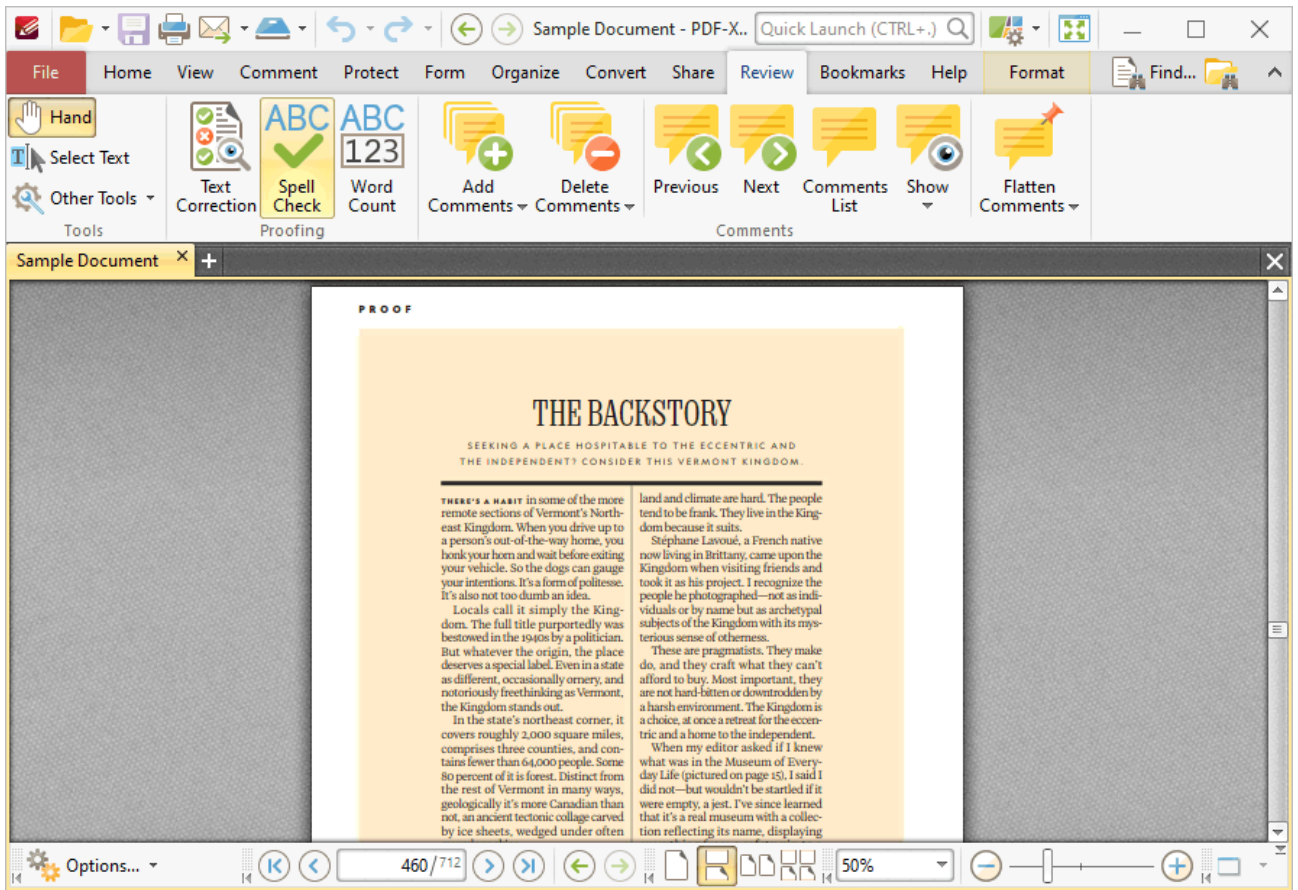

Figure 1. Review Tab, Spell Check

The **Spell Check** pane will open:

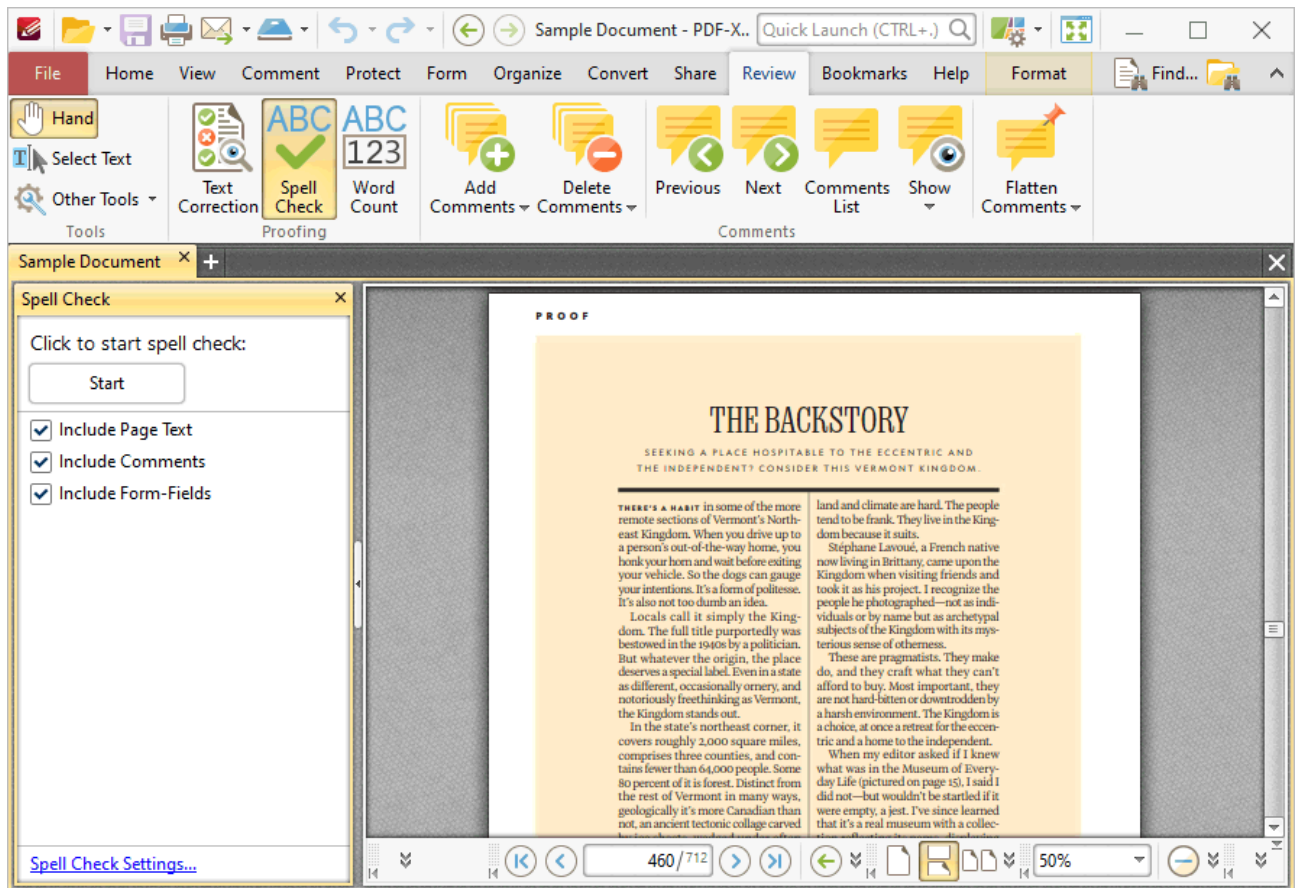
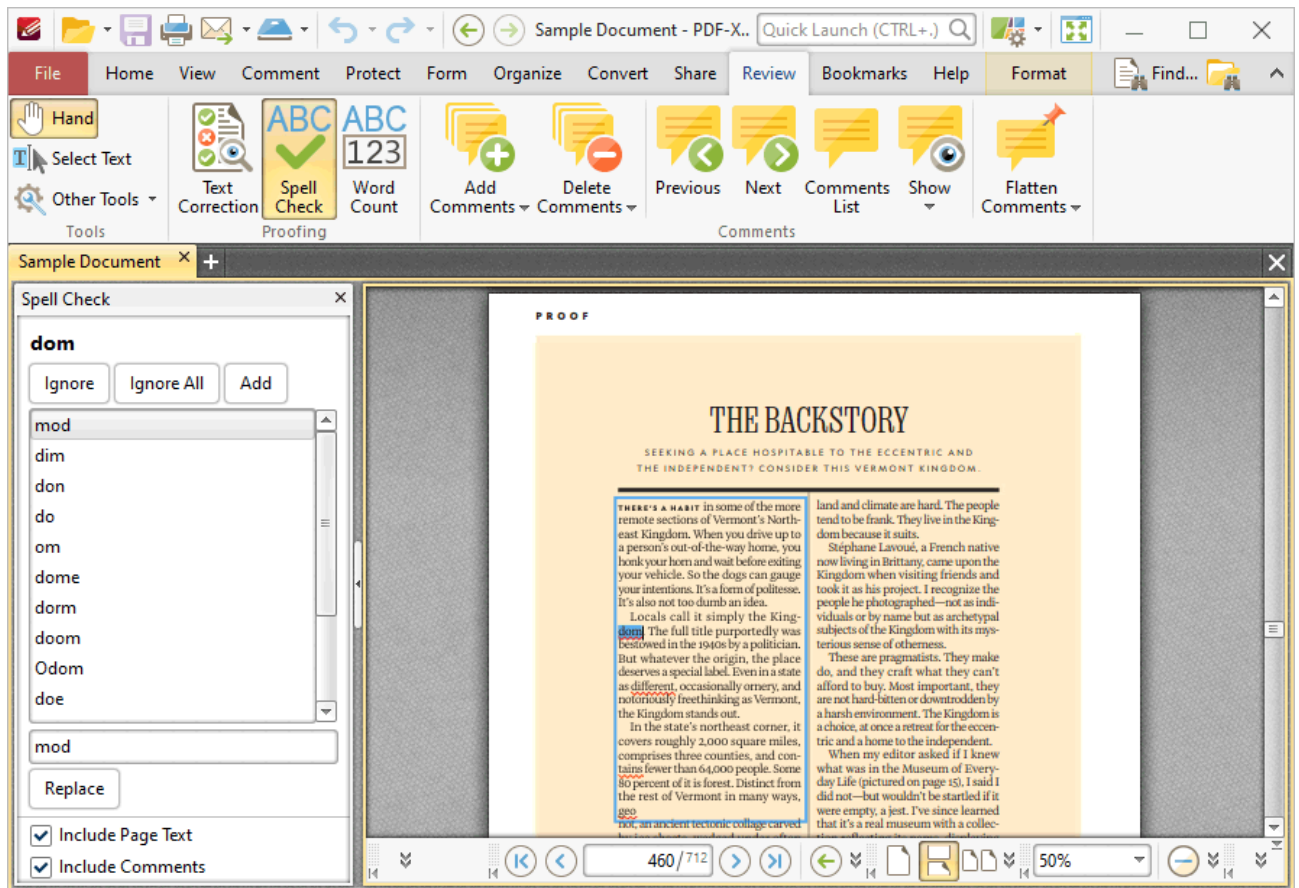

Figure 2. Spell Check Pane

Note that the default settings of the spell check include page text, comments and form fields. Clear the text boxes to exclude elements from the spell check as desired. Click **Spell Check Settings** to determine the settings for the spell check, as detailed below. Click **Start** to perform the spell check. Words that are not contained in its dictionary will be underlined in the document and displayed one at a time in the spell check pane:



The **Spell Check** feature is correcting the word "dom" in this example.

- A list of potential candidates for the correct word is displayed.
- Select the desired word from the list and click **Replace** to replace the word in the active document with the word from the list.
- Click **Ignore** to ignore the selected word and continue to the next misspelled word.
- Click **Ignore All** to ignore all remaining instances of the selected word.
- Click **Add** to add the selected word to the custom word list. The **Spell Check** feature includes the words in the custom word list in its dictionary.
- Use the check boxes to determine which document elements are included in the spell-check process.
- Press F7 to enable the spell check feature. F7 is also used to move to the next misspelled word when moving through the results of spell checks. Press Alt+F7 to move to the previous misspelled word.

## Spell Checker Settings

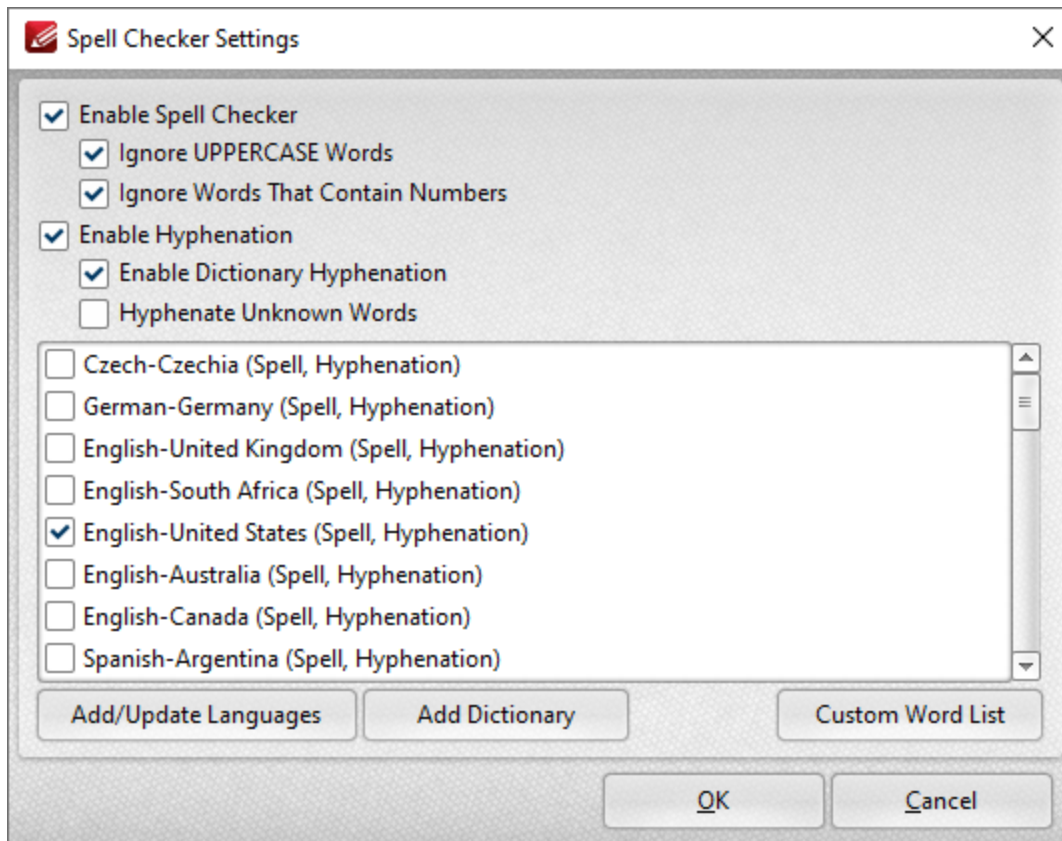

Figure 3. Spell Checker Settings Dialog Box

- Select/clear the check boxes to customize the spell check as desired.
- Select the check boxes of the languages that you want to spell check.
- Click **Add Dictionary** to add a new dictionary to the list of available options. Note that dictionaries must be in the **(\* .oxt)** format.
- Click **Custom Word List** to view/edit the list of custom words added by the user to the spell checker feature.

Click **OK** to save settings.

---

10.4.11 Bookmarks Tab



**Bookmarks Tab**

When the **Bookmarks** tab is selected, the following options are available:

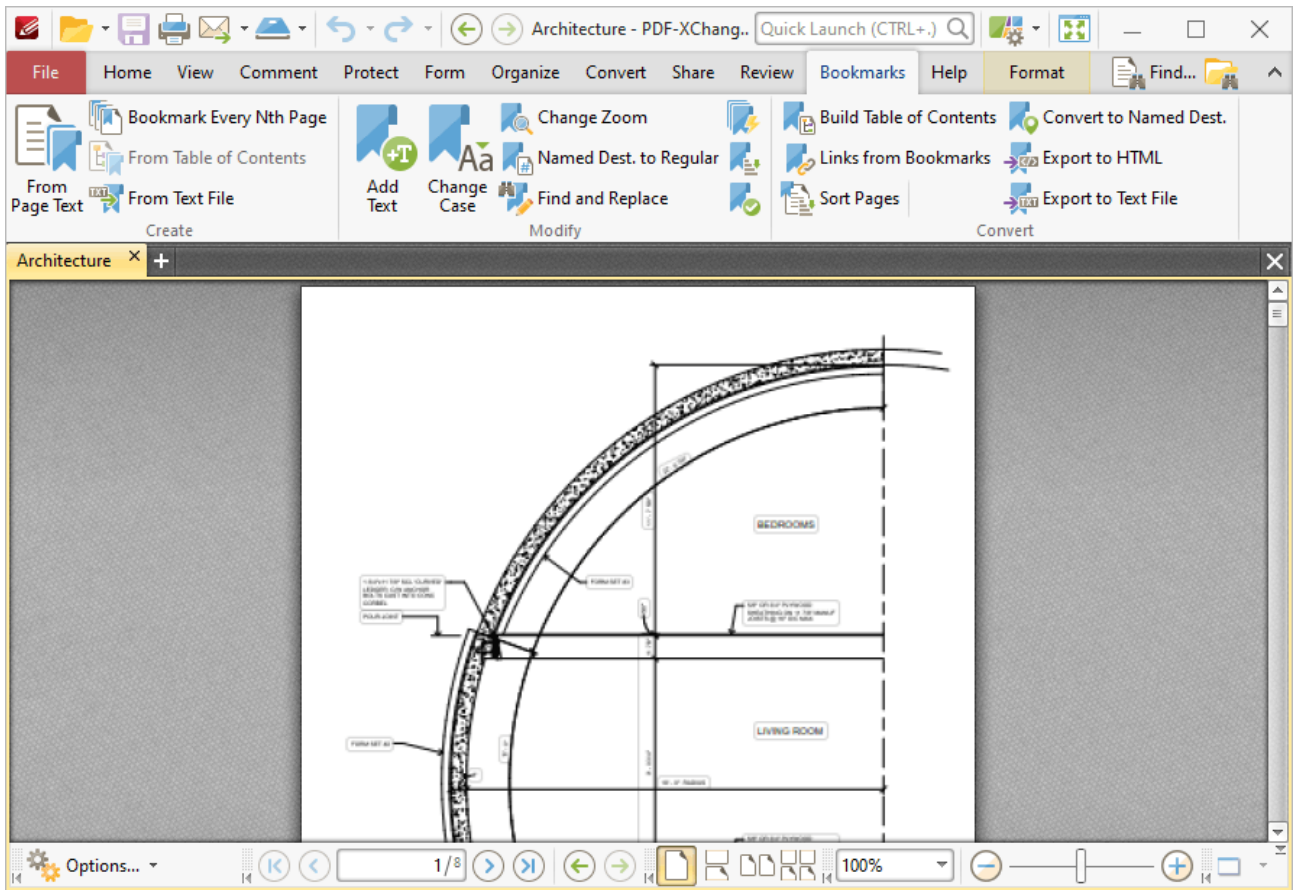
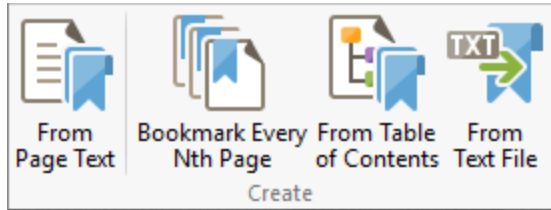

Figure 1. Bookmarks Tab

The options in the **Bookmarks** tab are used to create, modify and convert bookmarks. There are three groups in the **Bookmarks** tab:

**Create**

The options in the **Create** group are used to create bookmarks:



- Click **From Page Text** to create bookmark generators that create bookmarks from document text, as detailed [here.](#)<sup>1550</sup>
- Click **Bookmark Every Nth Page** to create bookmarks from pages at user-defined intervals, as detailed [here.](#)<sup>1560</sup>
- Click **From Table of Contents** to create bookmarks from the table of contents in the current document, as detailed [here.](#)<sup>1562</sup>
- Click **From Text File** to create bookmarks from text-based files, as detailed [here.](#)<sup>1564</sup>

## Modify

The options in the **Modify** group are used to modify existing bookmarks:

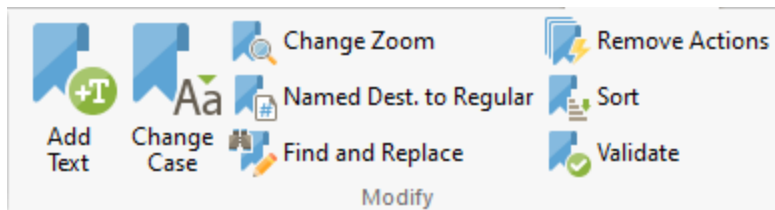

- Click **Add Text** to add prefixes/suffixes to bookmark titles, as detailed [here.](#)<sup>1567</sup>
- Click **Change Case** to change the case of bookmark titles, as detailed [here.](#)<sup>1569</sup>
- Click **Change Zoom** to change the zoom level of bookmarks, as detailed [here.](#)<sup>1571</sup>
- Click **Named Dest. to Regular** to convert named destinations to regular destinations, as detailed [here.](#)<sup>1573</sup>
- Click **Find and Replace** to locate specified text in bookmarks and replace it with custom text, as detailed [here.](#)<sup>1575</sup>
- Click **Remove Actions** to remove actions from bookmarks, as detailed [here.](#)<sup>1577</sup>
- Click **Sort** to sort bookmarks, as detailed [here.](#)<sup>1580</sup>
- Click **Validate** to validate the functionality of bookmarks, as detailed [here.](#)<sup>1582</sup>

## Convert

The options in the **Convert** group are used to convert bookmarks:

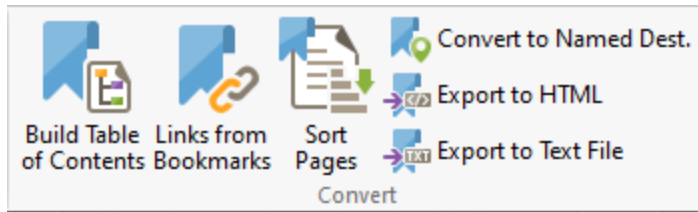

- Click **Build Table of Contents** to create a table of contents from bookmarks, as detailed [here.](#)<sup>1584</sup>
- Click **Links from Bookmarks** to create links in document text from bookmarks, as detailed [here.](#)<sup>1586</sup>
- Click **Sort Pages** to sort pages by bookmarks, as detailed [here.](#)
- Click **Convert to Named Destinations** to convert bookmarks to named destinations, as detailed [here.](#)<sup>1590</sup>
- Click **Export to HTML** to export a copy of the bookmarks' structure to an **HTML** file, as detailed [here.](#)<sup>1592</sup>
- Click **Export to Text File** to export a copy of bookmarks to a text file, as detailed [here.](#)<sup>1593</sup>

The [Bookmarks Guide](#)<sup>624</sup> is a useful resource for bookmarks and bookmark operations. Additionally, please note that several of the keyboard shortcuts relate to bookmarks. See [here](#)<sup>1691</sup> for a comprehensive list of available keyboard shortcuts.

---

### 10.4.11.1 Generate Bookmarks from Page Text



## Generate Bookmarks from Page Text

Click **Generate Bookmarks from Page Text** to create bookmark generators that create bookmarks from document text:

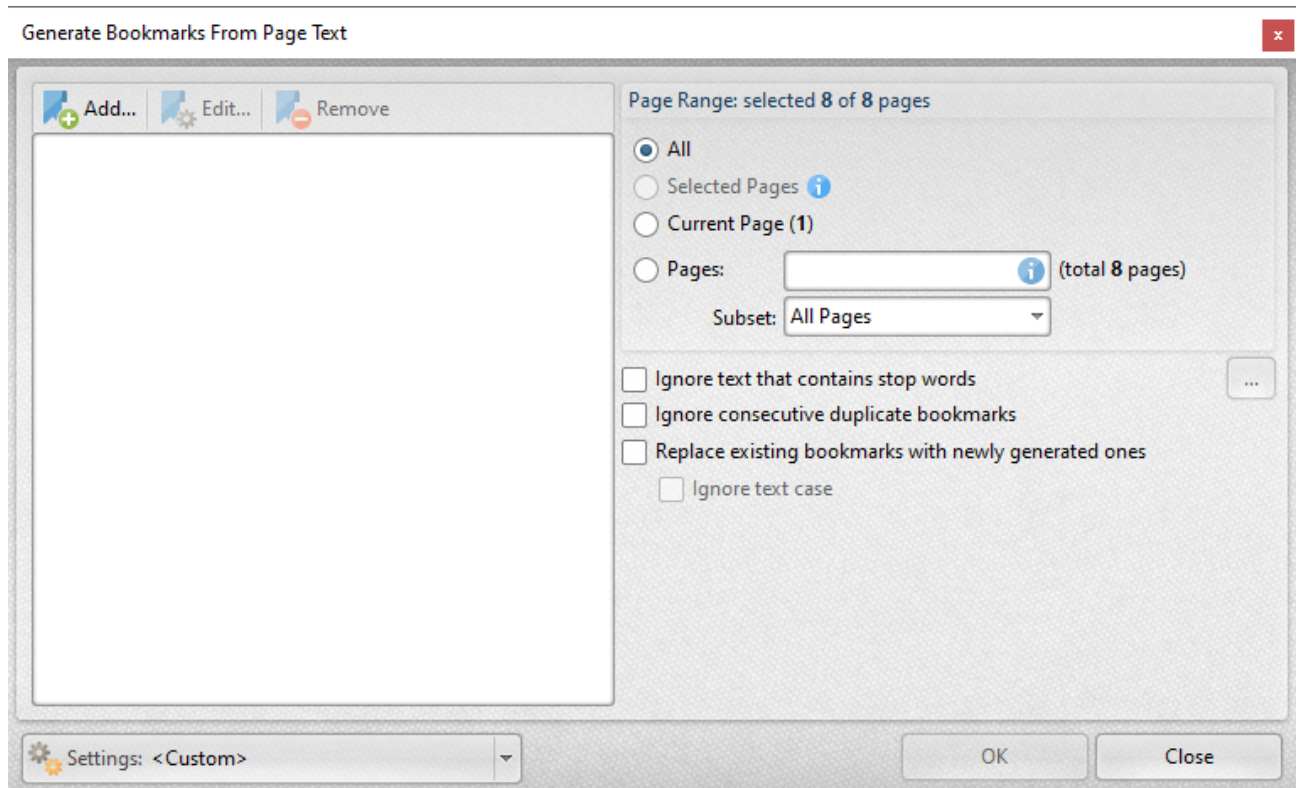



Figure 1. Generate Bookmarks From Page Text Dialog Box

- Click **Add** to add a new bookmark generator. The dialog box displayed in **(figure 4)** will open.
- Click **Edit** to edit the selected bookmark generator.
- Click **Remove** to remove the selected bookmark generator.
- The **Page Range** options determine the pages included in the generation of bookmarks:
  - Select **All** to use all document pages.
  - Select **Selected Pages** to use the pages currently selected in the [Thumbnails](#)  pane.
  - Select **Current Page** to use only the current page.



- Use the **Pages** box to determine specific pages/page ranges. Further information on the specification of page ranges is available [here](#).
- Use the **Subset** option to select **All Pages**, **Odd Pages Only** or **Even Pages Only** for specified page ranges.
- Select the **Ignore text that contains stop words** box as desired. Text containing stop words will be excluded from the bookmark generation process when this option is enabled. Click the ellipsis icon to view/edit the list of stop words.
- Select the **Ignore consecutive duplicate bookmarks** box to prevent the creation of consecutive identical bookmarks.
- Click the **Settings** dropdown arrow to save/manage/delete bookmark generator settings:

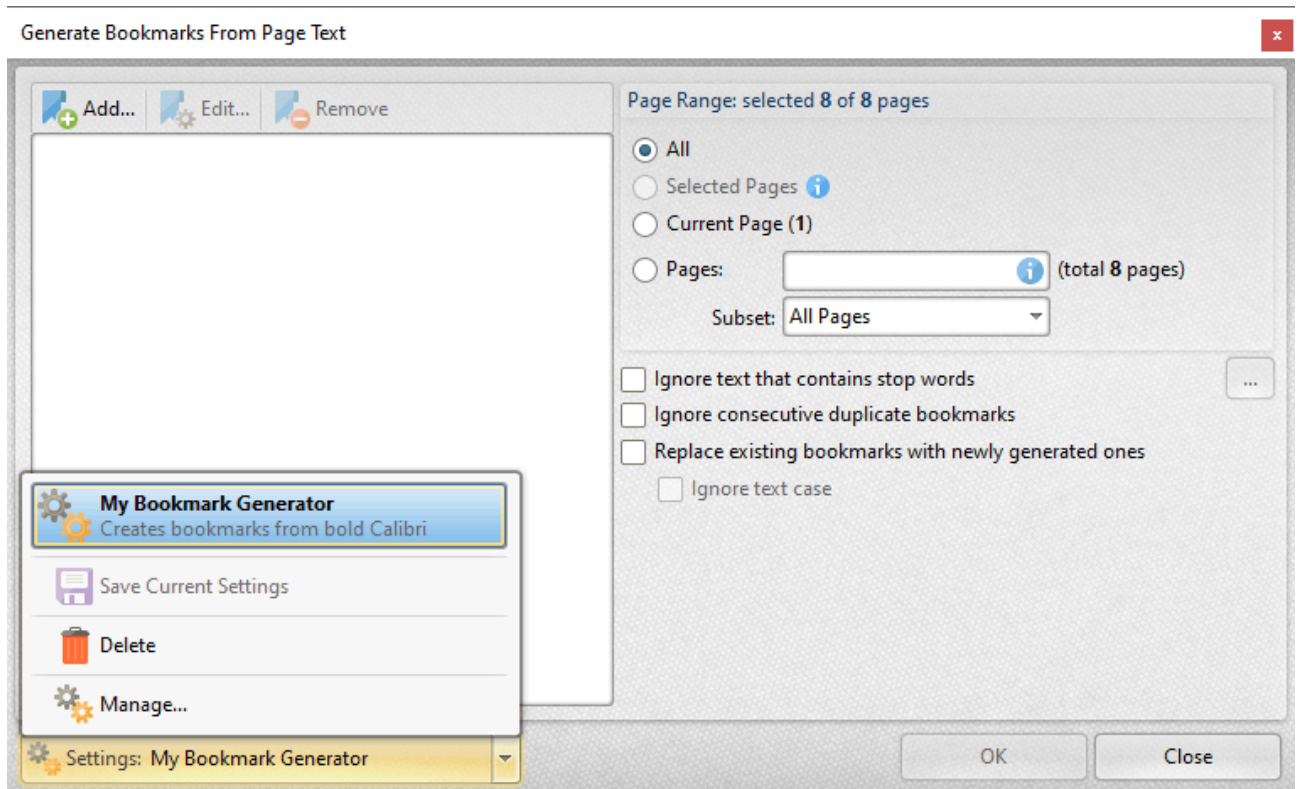

Figure 2. Generate Bookmarks from Page Text Dialog Box, Save/Manage/Delete Options

- Click **Save Current Settings** to save the current settings as a profile for subsequent use.
- Click **Delete** to delete the current profile.
- Click **Manage** to manage saved profiles. The **Manage Presets** dialog box will open:

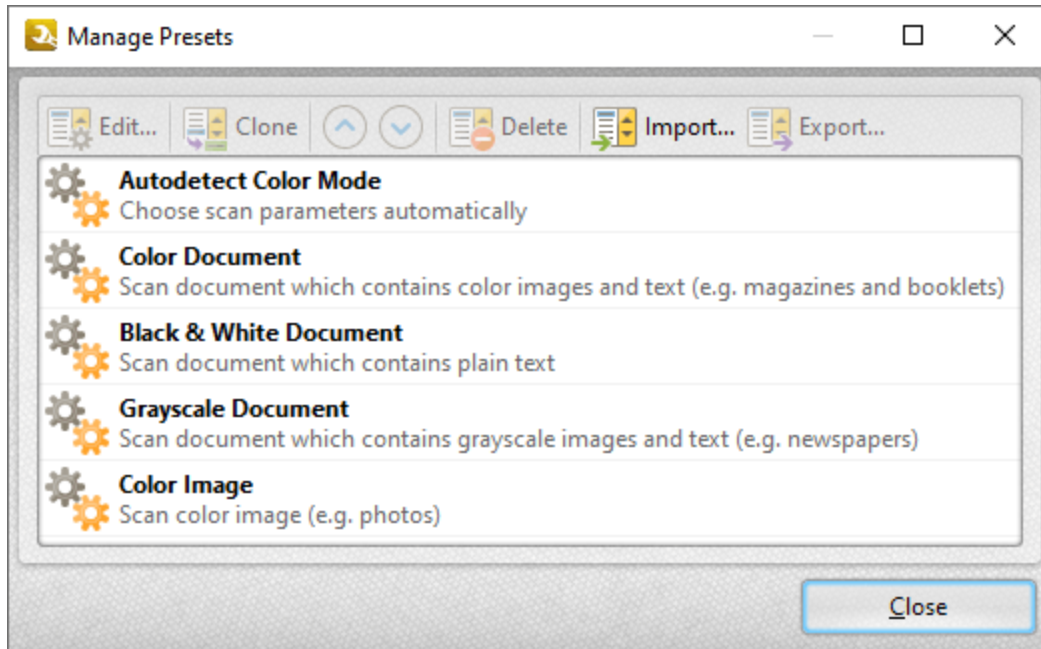

Figure 3. Manage Presets Dialog Box

- Click **Edit** to edit selected profiles.
- Click **Clone** to clone selected profiles.
- Use the up and down arrows to move selected profiles up or down in the list.
- Click **Delete** to delete selected profiles.
- Click **Import** to import profiles from a saved file.
- Click **Export** to export profiles to file.

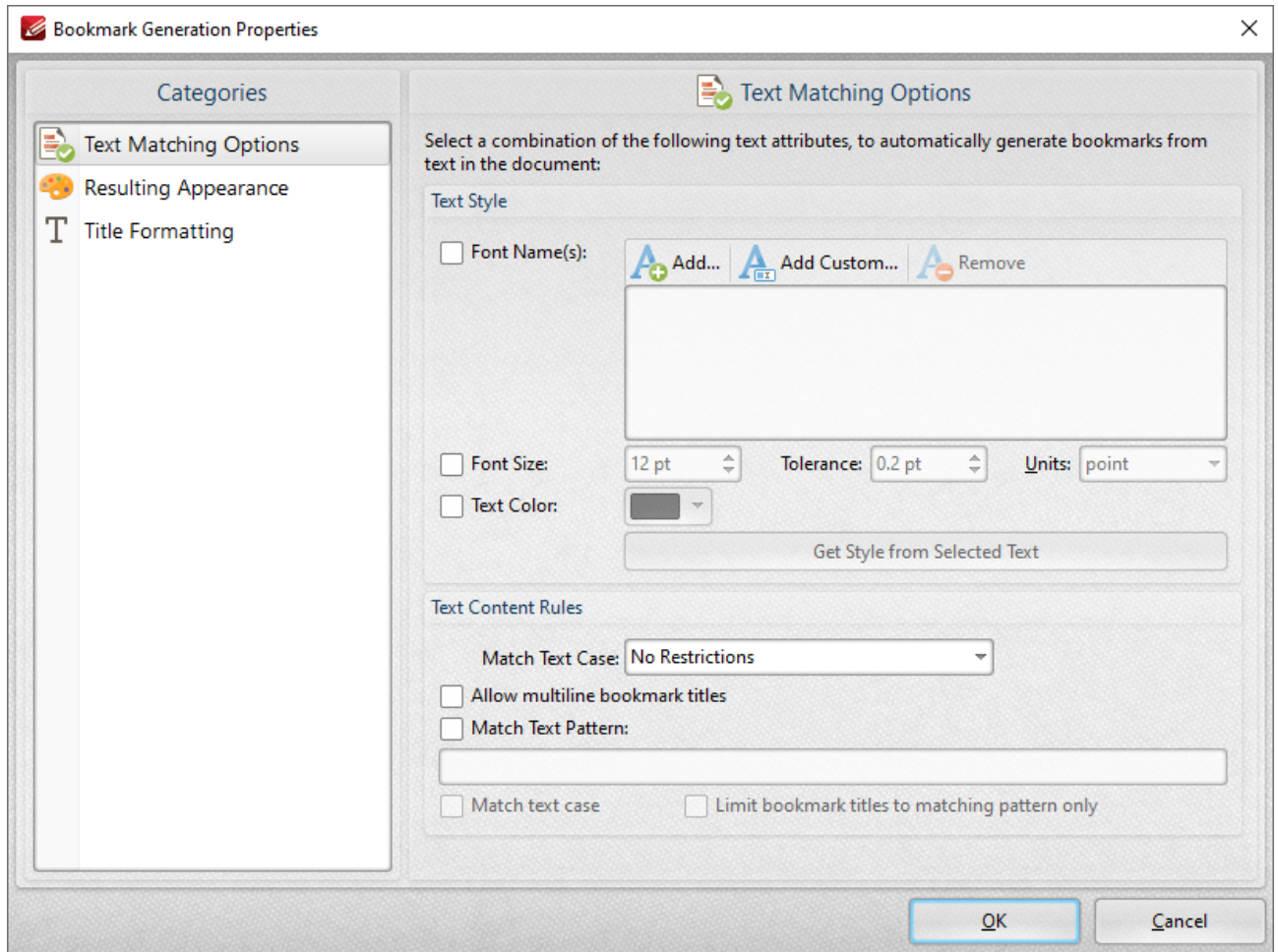

Figure 4. Bookmark Generation Properties Dialog Box

The options selected in the **Bookmark Generation Properties** dialog box determine the text used to generate bookmarks, and the style of the generated bookmarks:

### Text Matching Options

These options determine text used in the generation of bookmarks according to font, size and color:

- Select the **Font Names** box to include text of specific fonts in the generation of bookmarks. Click **Add** to add fonts to the list, **Add Custom** to add custom fonts, or **Remove** to remove selected fonts.
- Select the **Font Size** box to include text of a specific size in the generation of bookmarks. Use the number boxes to determine the **Size**, **Tolerance** and **Units** of text included in the generation of bookmarks. The **Tolerance** value determines the degree to which selected text can differ from the specified **Font Size** and remain included in the generation of bookmarks.
- Select the **Text Color** box to include text of of a specific color in the generation of bookmarks, then select a color in the dropdown menu.

- Click **Get Style from Selected Text** to determine the font settings detailed above according to text currently selected in the active document. Use the **Select Text** tool in the [Home](#)<sup>938</sup> tab to select text for this purpose.
- The option selected in the **Match Text Case** dropdown menu determines text used in the generation of bookmarks according to text case:
  - Select **No Restrictions** to include text of all cases in the generation of bookmarks.
  - Select **All Characters Are Capital** to include only upper-case text in the generation of bookmarks.
  - Select **First Character is Capital** to include only text that starts with a capital letter in the generation of bookmarks.
  - Select **First Character is Digit** to include only text that starts with a digit in the generation of bookmarks.
- Select the **Allow multiline bookmark titles** box to allow bookmark titles to exceed one line in length. This is useful in cases where it is not possible to shorten bookmark titles.
- Select the **Match Text Pattern** box to specify a sequence of words that document text must match in order to be included in the generation of bookmarks. Enter the desired text pattern in the text box.
- Select the **Match text case** box to include only text that matches the case of the text entered in the **Match Text Pattern** box. If this box is not selected then all matching text will be included regardless of its case.
- Select the **Limit bookmark titles to matching pattern only** box to determine that only text matching the specified pattern will be included in the generation of bookmarks.

### Resulting Appearance

These options determine characteristics of generated bookmarks:

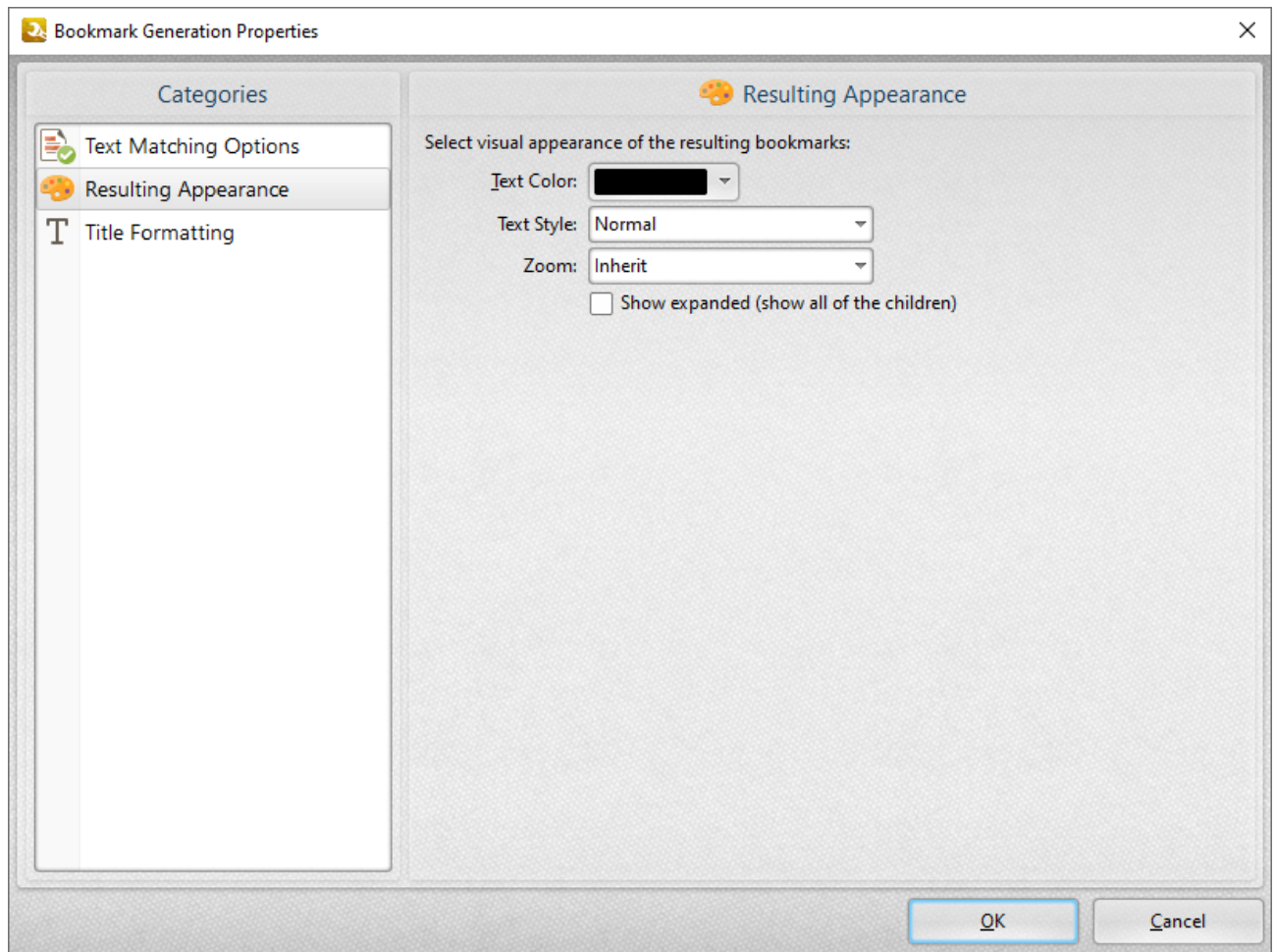

Figure 5. Resulting Appearance Dialog Box

- Use the **Text Color** menu to determine the text color of bookmarks.
- Use the **Text Style** menu to determine the text style of bookmarks.
- Use the **Zoom** menu to determine the zoom level when bookmarks are clicked. Select **Inherit** to use the current zoom level.
- Select the **Show expanded** box to expand all generated bookmarks.

## Title Formatting

These options are used to format bookmark titles:

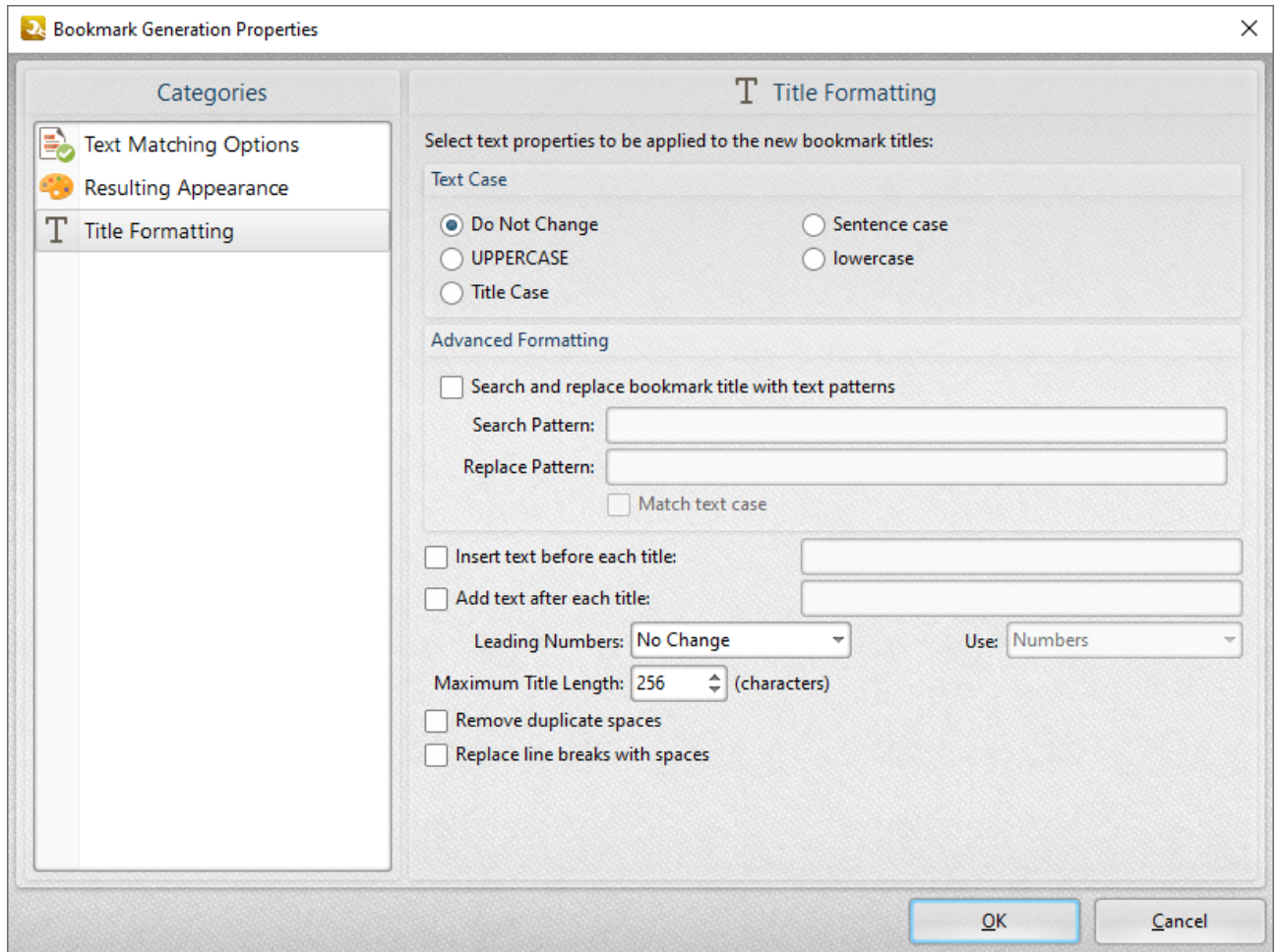

Figure 6. Bookmark Generation Properties Dialog Box

- Select a **Text Case** option to determine the text case of generated bookmark titles.
- Select the **Search and replace bookmark title with text patterns** box to search for specific text in bookmark titles and replace it with customized text:
  - Enter the text to be replaced in the **Search Pattern** text box.
  - Enter the replacement text in the **Replace Pattern** text box.
  - Select the **Match text case** box as desired.
- Select the **Insert text before each title** box to add text before bookmark titles. Enter the desired text in the text box.
- Select the **Add text after each title** box to add text after bookmark titles. Enter the desired text in the text box.
- The **Leading Numbers** dropdown menu is used to add/remove/retain leading numbers for bookmarks. Select **No Change**, **Add** or **Remove** as desired. If leading numbers are being added then use the **Use** dropdown menu to select **Numbers**, **Letters** or **Roman Numerals**.
- Use the **Maximum Title Length** text box to set the maximum number of characters for generated bookmarks.
- Select the **Remove duplicate spaces** box to remove instances of adjacent blank characters.

- Select the **Replace line breaks with spaces** box to use spaces instead of line breaks for bookmarks.

Click **OK** to generate bookmarks.

---

## 10.4.11.2 Bookmark Every Nth Page



## Bookmark Every Nth Page

Click **Bookmark Every Nth Page** to create bookmarks from pages at user-defined intervals:

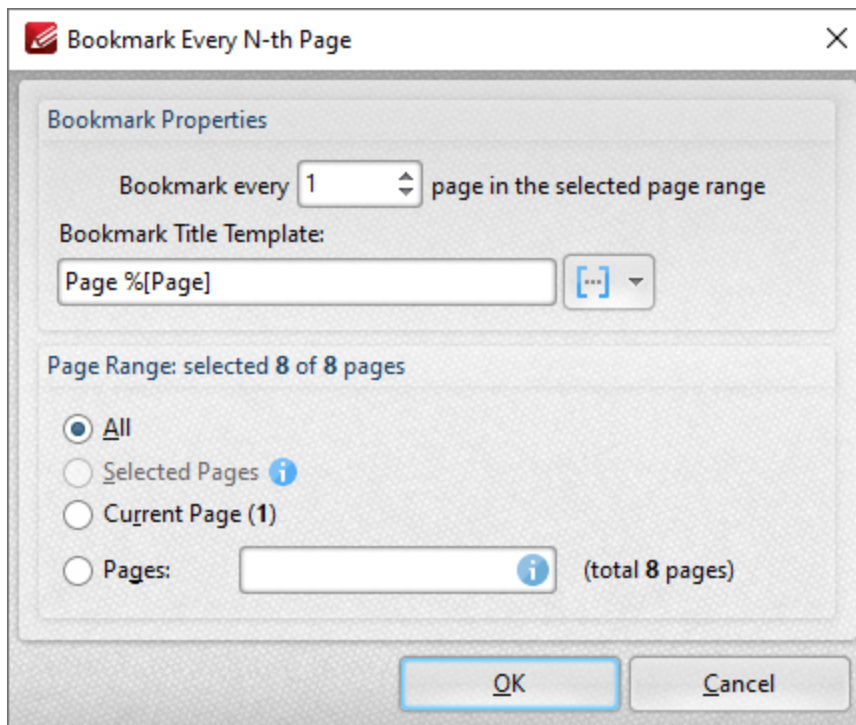



Figure 1. Bookmark Every N-th Page Dialog Box

- Enter a figure in the number box to determine the interval at which bookmarks are created. For example, if 2 is entered then a bookmark will be created from every second document page.
- Enter a value for the **Bookmark title template** as desired. This value determines the template for bookmark titles. Click the blue icon to add [macros](#).<sup>1707</sup> The default value is 'Page %[Page]', which will result in the bookmark titles 'Page 1', 'Page 2', 'Page 3' etc.
- The page range options for bookmark generation are as follows:
  - Select **All** to include all pages.
  - Select **Selected Pages** to include only the pages selected in the [Thumbnails](#)<sup>1000</sup> pane.
  - Select **Current Page** to include only the current page.



- Use the **Pages** box to specify a custom range. Instructions on the specification of page ranges are available [here](#).

Click **OK** to create bookmarks.

---

### 10.4.11.3 Generate Bookmarks from Table of Contents



## Generate Bookmarks from Table of Contents

Click **Generate Bookmarks from Table of Contents** to create bookmarks from an existing table of contents. Please note that the table of contents must first be selected using the **Select Text Tool** for this feature to be available. When it is selected, the following dialog box will open:

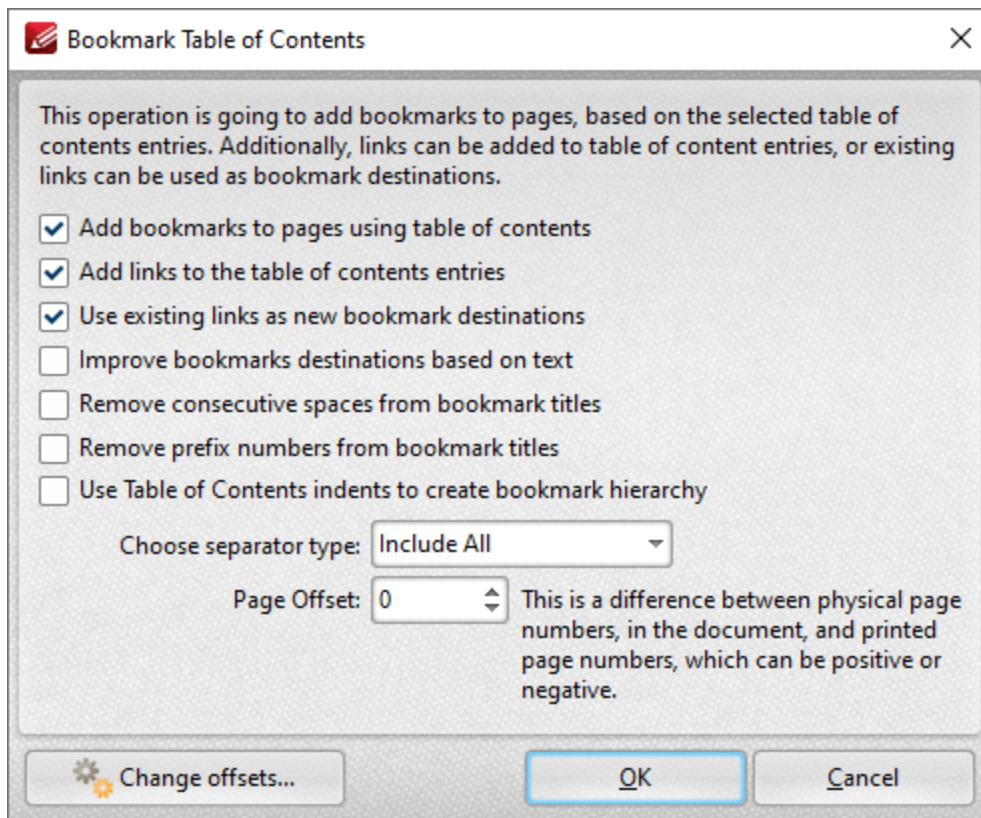

Figure 1. Bookmark Table of Contents Dialog Box

- Select check boxes to enable/disable parameters.
- Use the **Choose separator type** dropdown menu to select a separator for bookmarks.
- Use the **Page Offset** box to set a page offset as desired.
- Click **Change Offsets** to adjust top and/or bottom offsets.

Click **OK** to generate bookmarks.



#### 10.4.11.4 Generate Bookmarks from Text File

---



### Generate Bookmarks from Text File

---

Click **Generate Bookmarks from Text File** to create bookmarks from a text file:

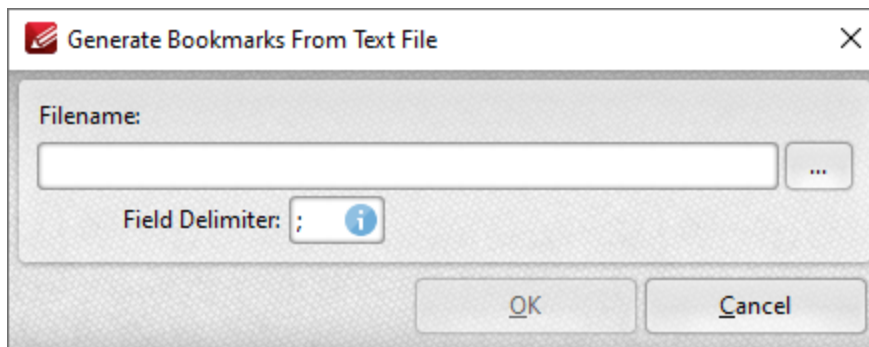

**Figure 1.** Generate Bookmarks From Text File Dialog Box

- Enter the name of the source text file in the **File Name** text box. Alternatively, click the ellipsis icon to select a file from the local computer. (Please note that the file used must be plain text (\*.txt) format).
- Use the **Field Delimiter** box to determine the field delimiter as required. **PDF-XChange Editor** will use the delimiter to define bookmarks in the source file.

Click **OK** to generate bookmarks.

Please note that the format of source files for this feature must be the same as that of files created using the [Export Bookmarks to Text File](#) <sup>1593</sup> feature.

### Example

The following file can be used to create bookmarks in documents:

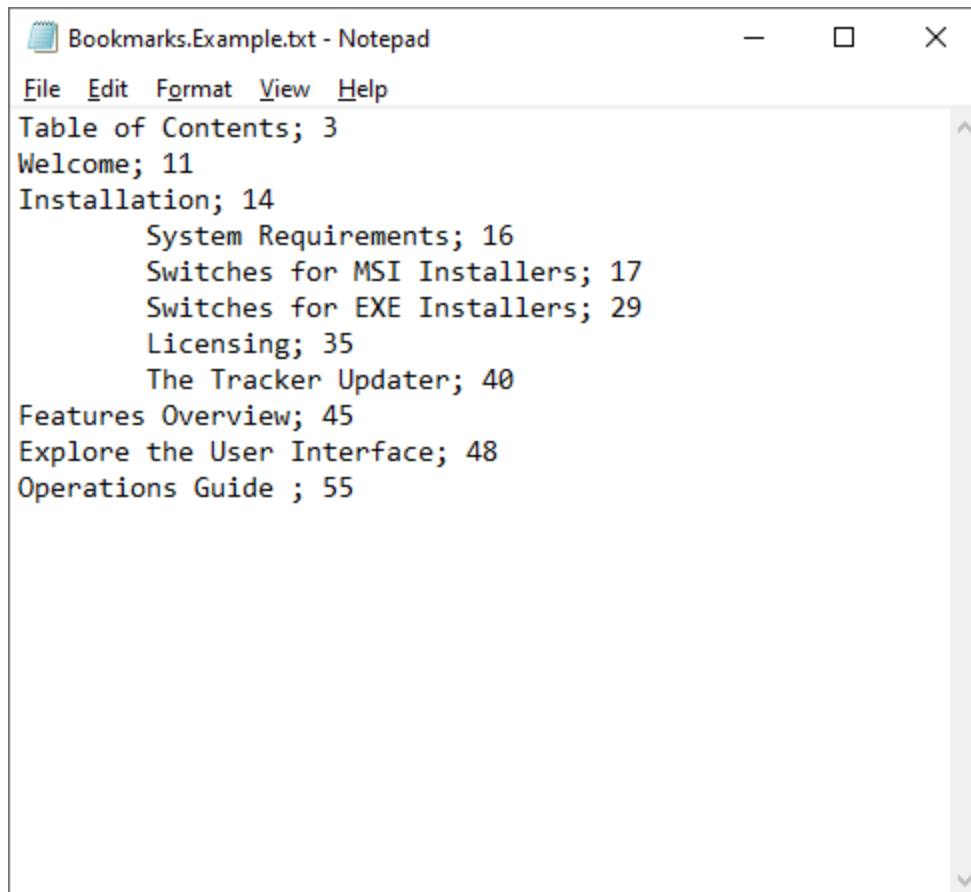

Figure 2. Example Bookmarks Text File

When this file is selected for use in conjunction with the **Generate Bookmarks from Text File** feature, bookmarks are created as detailed below:

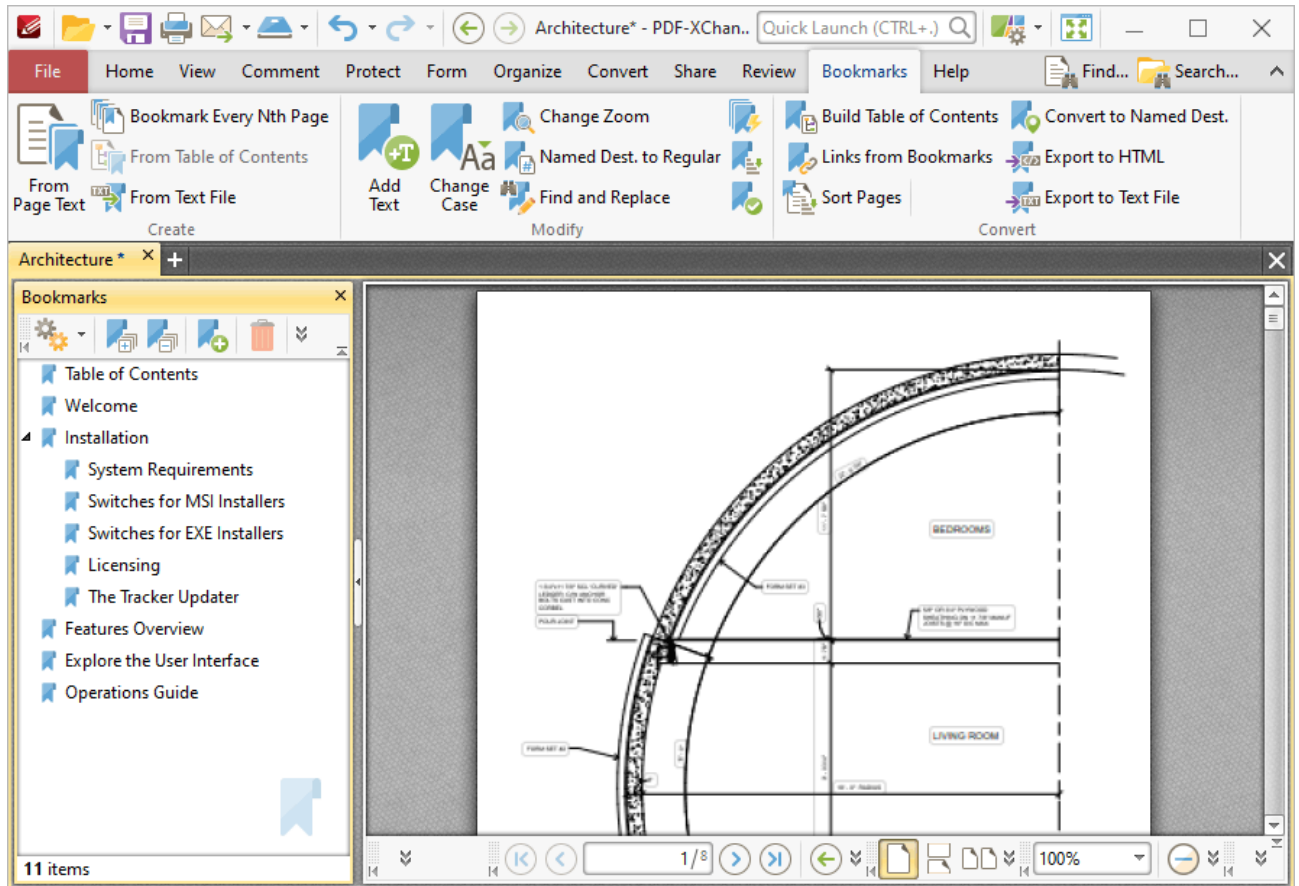
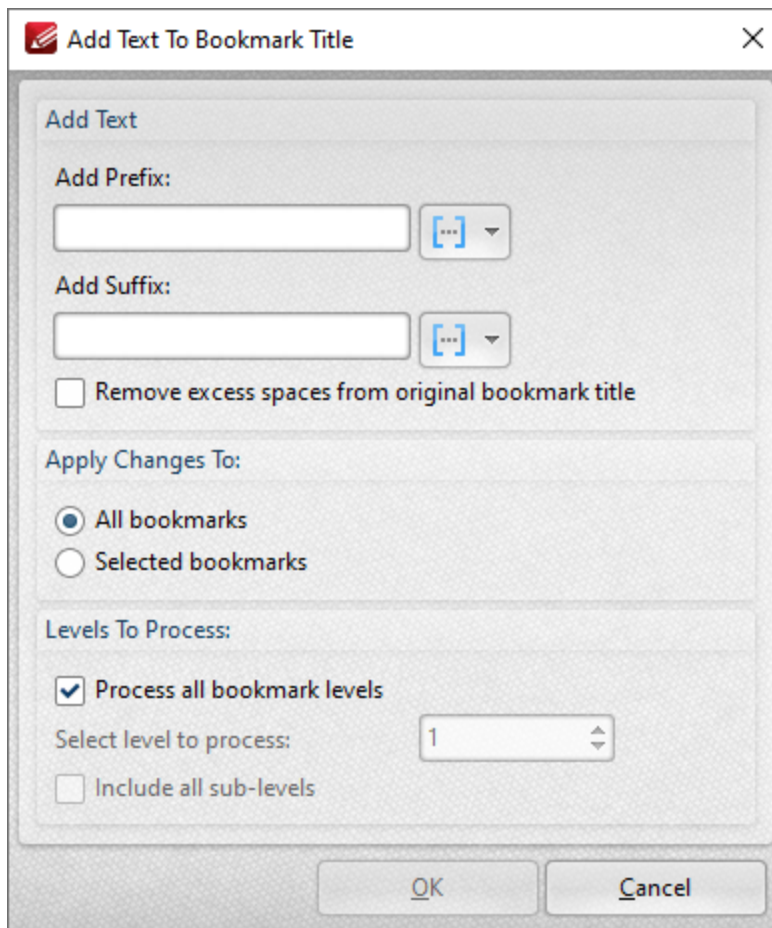

Figure 3. Bookmarks Created from Text File

## 10.4.11.5 Add Text to Bookmark Titles

**Add Text to Bookmark Titles**

Click **Add Text to Bookmark Titles** to add text to bookmark titles:



**Figure 1.** Add Text to Bookmark Title Dialog Box

- Use the **Add Prefix/Suffix** text boxes to add prefixes/suffixes to bookmark titles. Click the icon to add [macros](#).
- Select the **Remove excess spaces from original Bookmark Title** box to remove additional spaces from bookmark titles.

- Select either **All Bookmarks** or **Selected Bookmarks** in the **Use Bookmarks** dropdown menu to determine which bookmarks are updated. Select bookmarks in the **Bookmarks**  pane in order to use the **Selected Bookmarks** option.
- Select the **Process all bookmark levels** box to process all bookmark levels. Alternatively, clear the box and select a customized level. The number entered in the number box determines the level of bookmarks that are processed. Select the **Include all sub-levels** box to include all bookmark levels.

Click **OK** to add text to bookmarks.

---



10.4.11.6 Change Bookmark Case



**Change Bookmark Case**

Click **Change Bookmark Case** to edit the case of bookmark text:

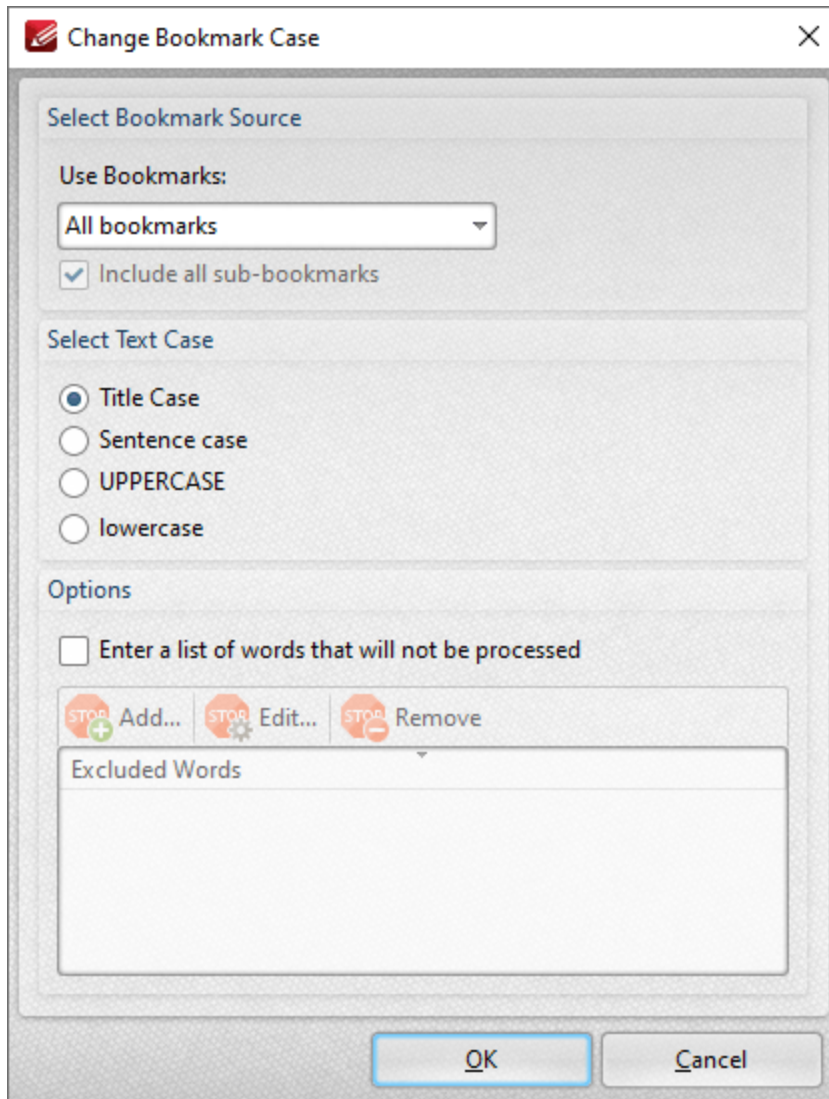



Figure 1. Change Bookmark Case Dialog Box

- Select either **All Bookmarks** or **Selected Bookmarks** in the **Use Bookmarks** dropdown menu to determine which bookmarks are updated. Select bookmarks in the **Bookmarks**  pane in order to use the **Selected Bookmarks** option.
- Select the **Include all sub-bookmarks** box to include sub-bookmarks.
- Select an option from the **Select Text Case** option buttons to determine the new case for bookmark text.
- Select the **Enter a custom list of words that will not be processed** box to create/edit the list of words excluded from the process. Use the **Add**, **Edit** and **Remove** buttons to add, edit and remove words.

Click **OK** to update bookmark text.

---

## 10.4.11.7 Change Bookmarks Zoom Factor

**Change Bookmarks Zoom Factor**

Click **Change Bookmarks Zoom Factor** to edit the zoom factor of document bookmarks:

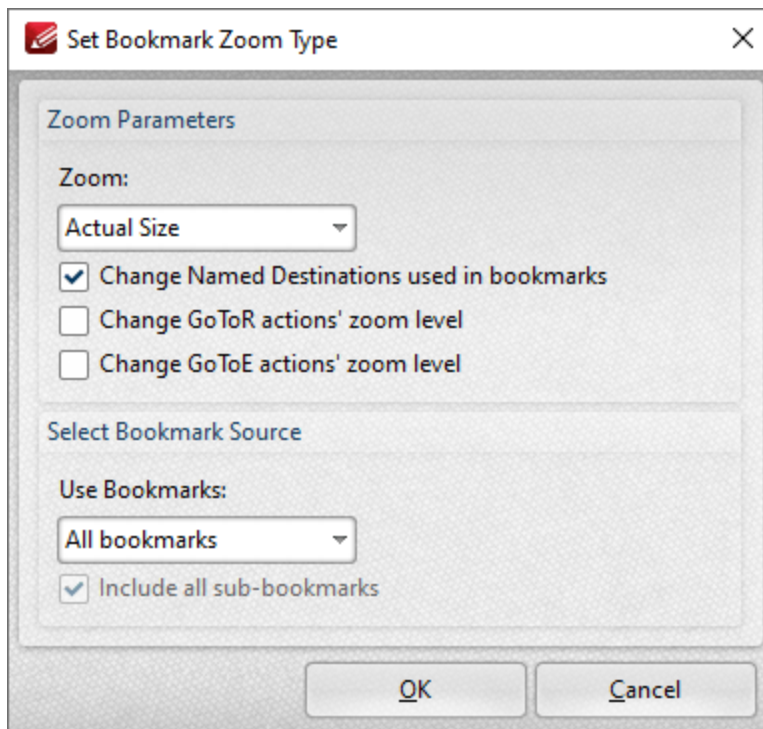

**Figure 1.** Set Bookmark Zoom Type Dialog Box

- Select an option in the **Zoom** dropdown menu to determine the new zoom level for bookmarks.
- Select the **Change Named Destinations used in Bookmarks** box to include named destinations in the operation.
- Select the **Change GoToR actions' zoom level** box to include links to other documents in the operation.
- Select the **Change GoToE actions' zoom level** box to include links to embedded documents in the operation.

Click **OK** to update the bookmark zoom settings.



#### 10.4.11.8 Convert Named Destinations to Regular Destinations



### Convert Named Destinations to Regular Destinations

Click **Convert Named Destinations to Regular Destinations** to convert named destinations into regular destinations. Named destinations are user-defined locations in documents that are created using the current view of the document at the time of their creation. They can be used in conjunction with [Bookmarks](#), [Go To Page](#) actions and the [/Open](#) command line. Existing named destinations can be viewed in the [Named Destinations pane](#). This feature converts named destinations into regular destinations, which means a different set of data is referenced to link to the destination. Named destinations use the current view at the time of their creation, whereas regular destinations use page numbers, page coordinates and either zoom level or a custom-sized rectangle. This means that regular destinations are not affected when document pages are moved or deleted, which is their main benefit in comparison to named destinations. When this feature is selected the following dialog box will open:

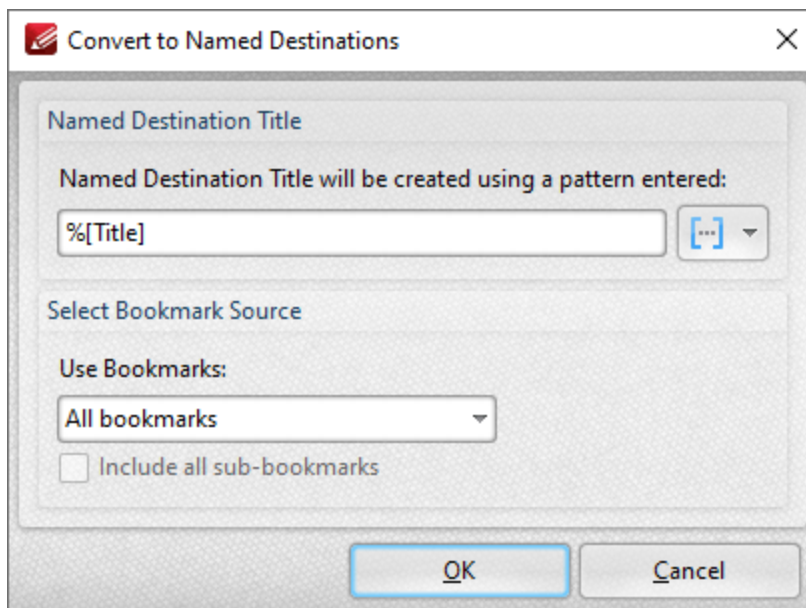

Figure 1. Convert Named Destinations To Regular Destinations Dialog Box

- Select either **All Bookmarks** or **Selected Bookmarks** in the **Use Bookmarks** dropdown menu to determine which bookmarks are updated. Select bookmarks in the [Bookmarks](#) pane in order to use the **Selected Bookmarks** option.

- Select the **Include all sub-bookmarks** and **Remove converted named destinations from document** boxes as desired.

Click **OK** to convert named destinations to regular destinations.

---

### 10.4.11.9 Find and Replace Bookmark Text

---



## Find and Replace Bookmark Text

---

Click **Find and Replace Bookmark Text** to locate and replace text in bookmark titles:

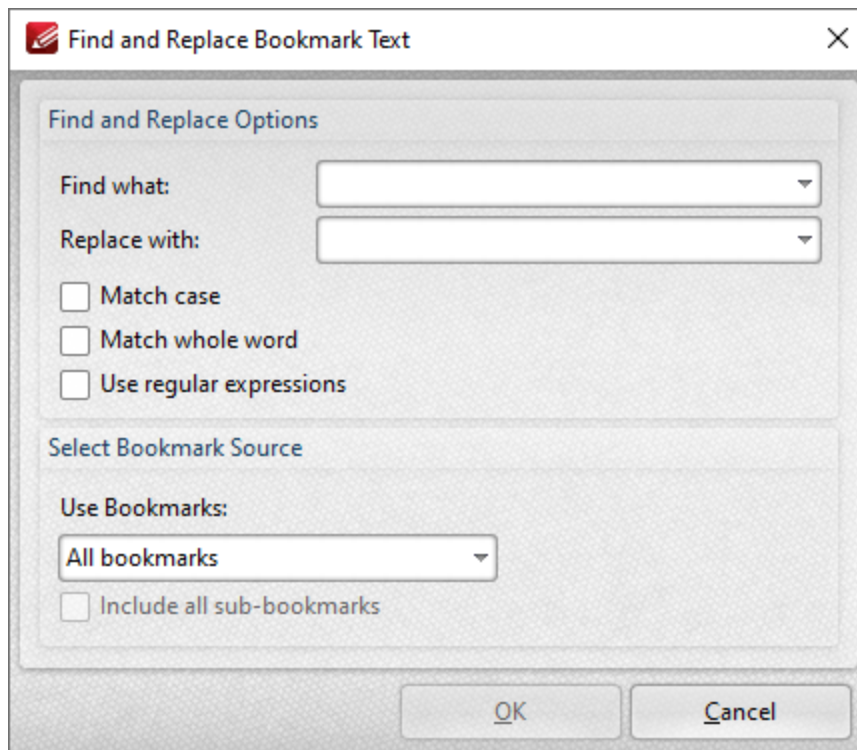

**Figure 1.** Find And Replace Bookmark Text Dialog Box

- Enter the terms to be replaced in the **Find what** text box.
- Enter the replacement terms in the **Replace with** text box.
- Select the **Match case**, **Match whole word** and **Use regular expressions** boxes as desired. Further information on regular expressions is available [here](#).
- Select either **All Bookmarks** or **Selected Bookmarks** in the **Use Bookmarks** dropdown menu to determine which bookmarks are updated. Select bookmarks in the [Bookmarks](#)<sup>994</sup> pane in order to use the **Selected Bookmarks** option.
- Select the **Include all sub-bookmarks** box as desired.

Click **OK** to find and replace bookmark text.





## 10.4.11.1 Remove Actions from Bookmarks

---



### Remove Actions from Bookmarks

---

Click **Remove Actions** to remove actions from bookmarks:

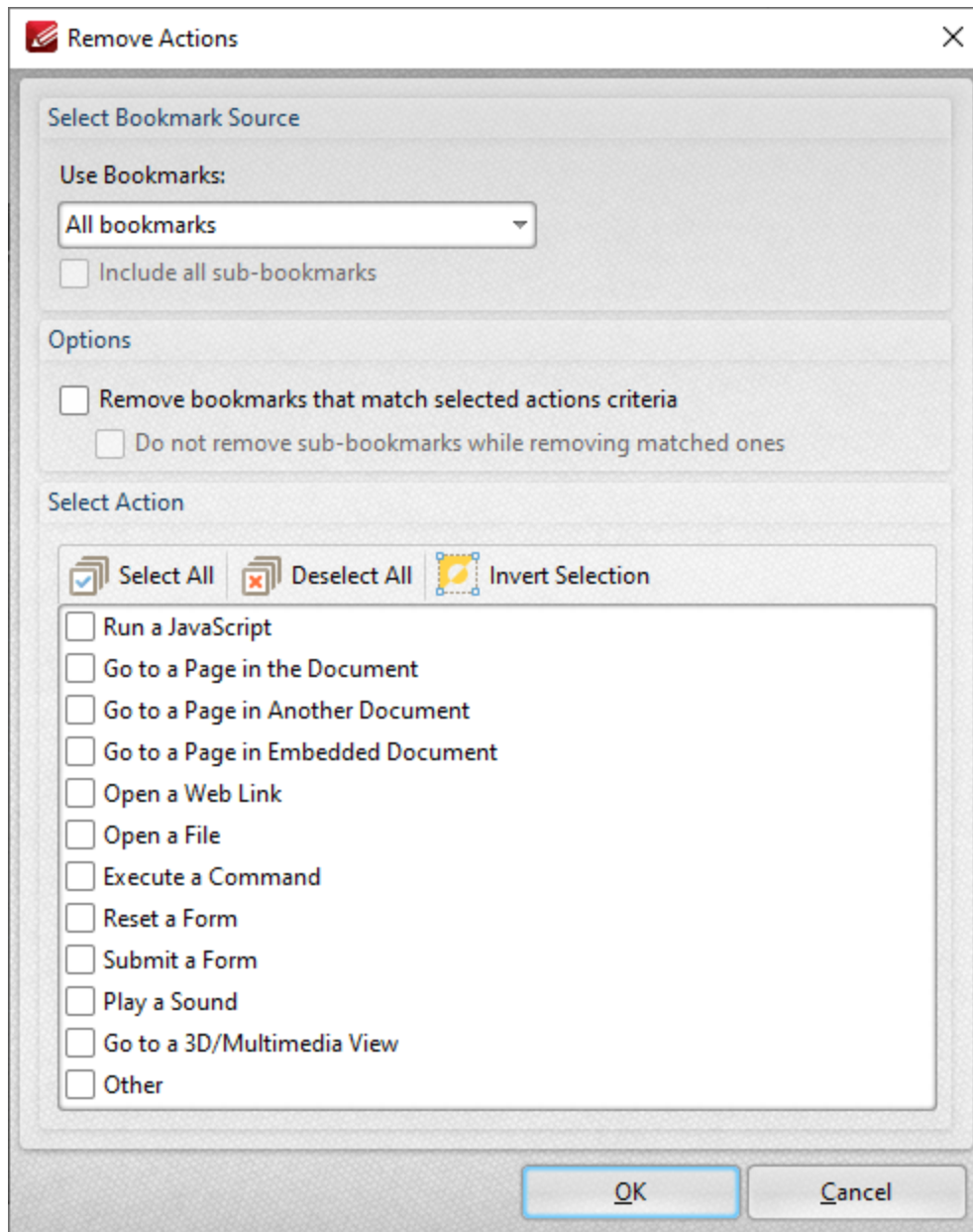

Figure 1. Remove Actions Dialog Box

- Use the dropdown menu to determine the bookmarks from which actions are removed.
- Select the **Include all sub-bookmarks** box to include sub-bookmarks.
- Select the **Remove bookmarks that match selected action criteria** box to remove bookmarks that match the criteria specified in the **Select Actions** pane when the **Remove Actions** command is executed.
- Select the **Do not remove sub-bookmarks while removing matched ones** box to retain sub-bookmarks in cases where parent bookmarks are removed.
- Use the **Select Actions** pane to determine which actions are removed from bookmarks.
- Click **Select All/Deselect All** to select/deselect all bookmark actions.
- Click **Invert Selection** to invert the current selection of actions.

Click **OK** to remove actions from bookmarks.

---

### 10.4.11.1: Sort Bookmarks

---



## Sort Bookmarks

---

Click **Sort Bookmarks** to sort existing document bookmarks:

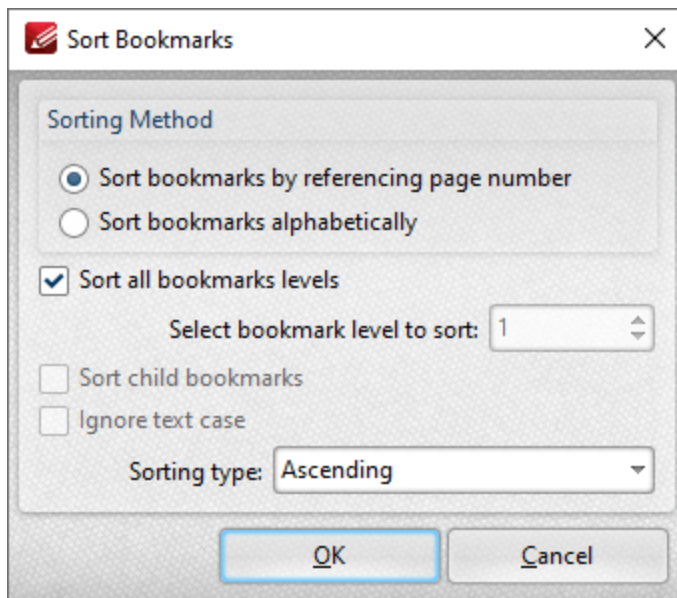

Figure 1. Sort Bookmarks Dialog Box

- Select either **Sort bookmarks by referencing page number** or **Sort bookmarks alphabetically** as desired.
- Select the **Sort all bookmarks levels** box to include all bookmark levels.
- Select the **Sort all bookmark levels** box as desired. Clear this box to customize the book levels sorted:
  - Use the **Select bookmark level to sort** dropdown menu to set the sorted bookmark level.
  - Select the **Sort child bookmarks** box to include child bookmarks in the sort.
  - Select the **Ignore text case** box to ignore the text case when the sort is performed.
  - Use the **Sorting type** dropdown menu to select either **Ascending** or **Descending** as the sort mode for bookmarks.

Click **OK** to sort bookmarks.

---



### 10.4.11.1/Validate Bookmarks

---



## Validate Bookmarks

---

Click **Validate Bookmarks** to determine the validity of bookmarks. The **Validate Bookmarks** dialog box will open, which contains a list of bookmark elements that can be validated:

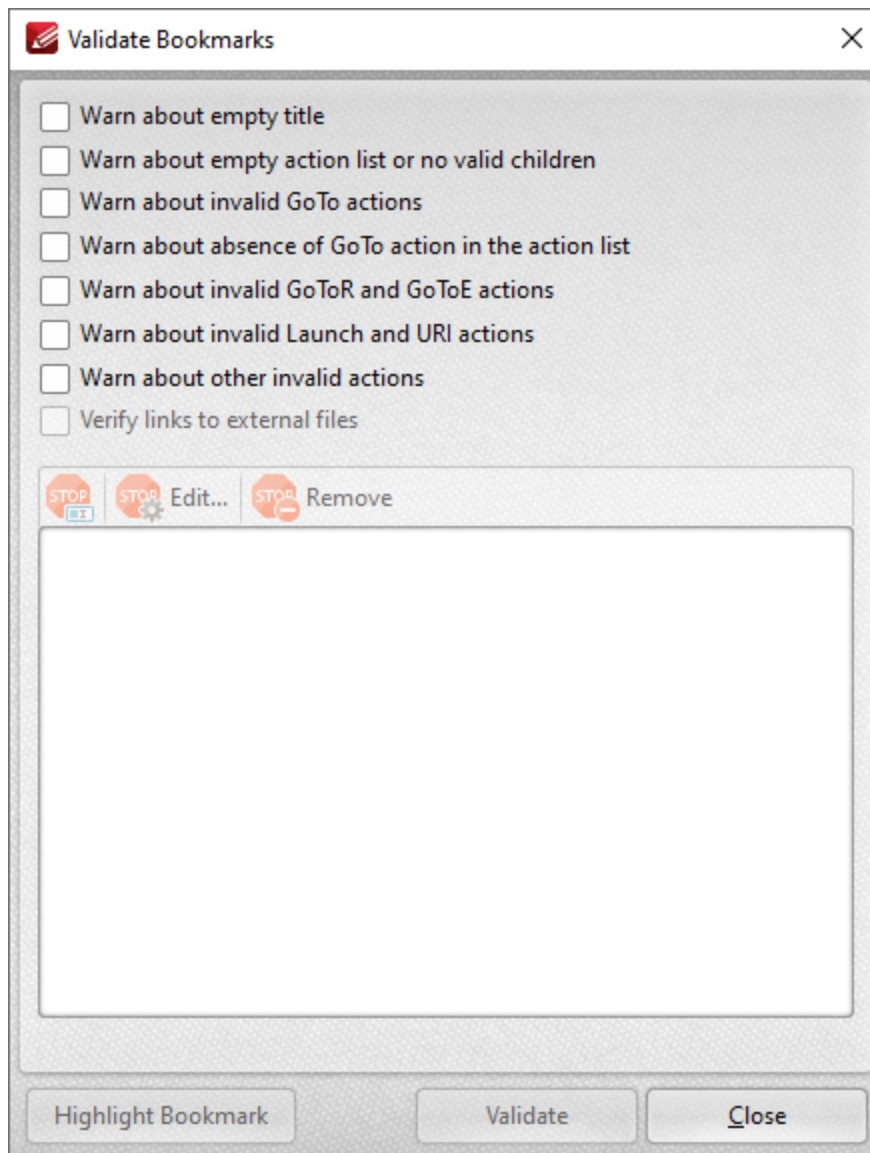

**Figure 1.** Validate Bookmarks Dialog Box

- Select boxes as desired to determine the elements of bookmarks to be validated.
- Click **Validate** to validate bookmarks. Bookmarks that fail validation are displayed in the pane. Select bookmarks in the pane and then click **Rename**, **Edit** or **Remove** as desired. If the option to edit bookmarks is selected then the **Action List** will be displayed for the bookmark. Use this list to determine the actions that take place when bookmarks are clicked. Note that the [Bookmarks](#)<sup>994</sup> pane can also be used to view/edit the **Action List** for bookmarks. Right-click bookmarks in the pane and then click **Properties** to view bookmark properties. The **Bookmark Properties** pane will open. Existing bookmark actions are detailed in the **Actions** tab:

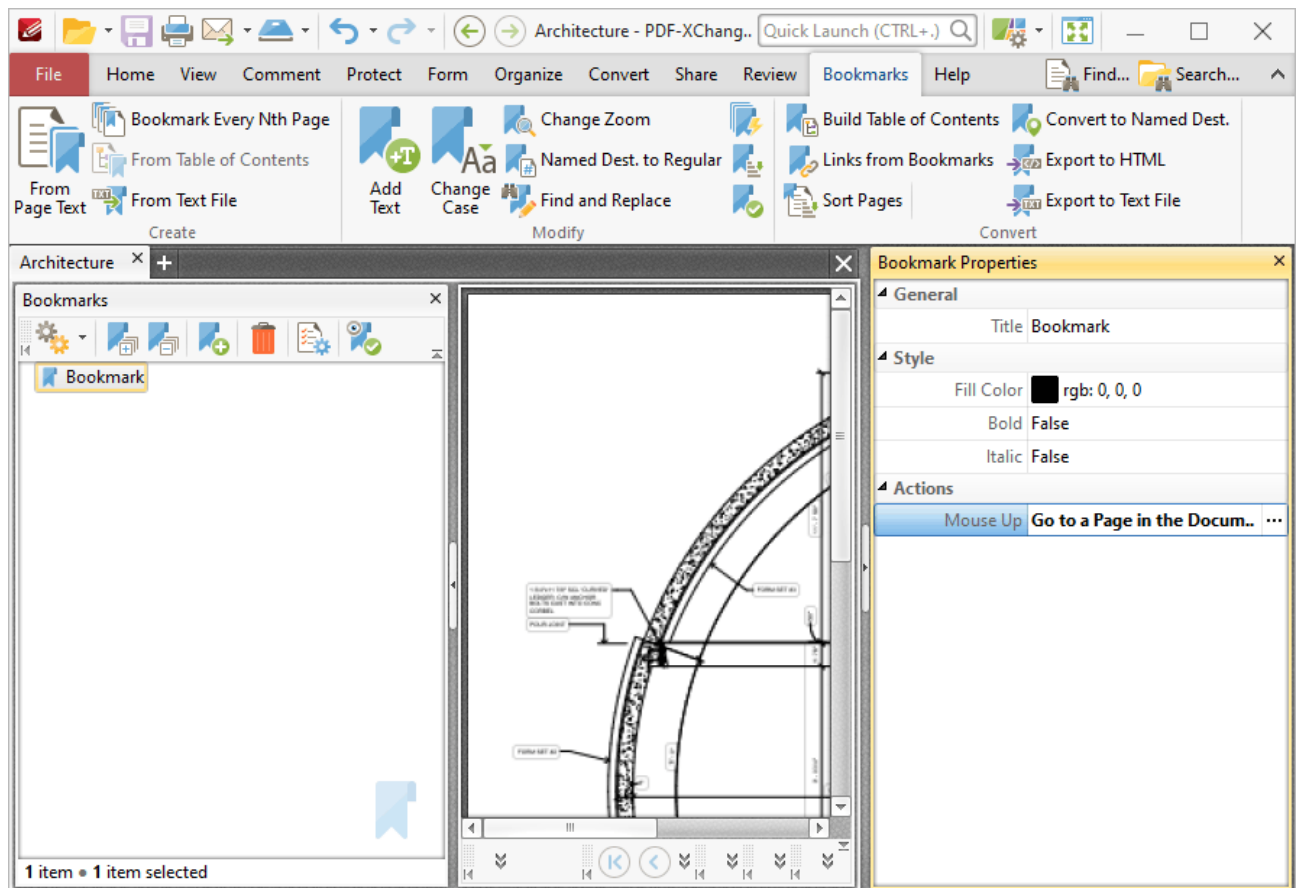

Figure 2. Bookmark Properties Pane, Action Tab

Click the ellipsis icon on the right of the tab to edit bookmark actions. Further information on adding/editing actions is available [here](#).<sup>959</sup>

## 10.4.11.1: Build Table of Contents

**Build Table of Contents**

Click **Build Table of Contents** to create a table of contents from the current document bookmarks:

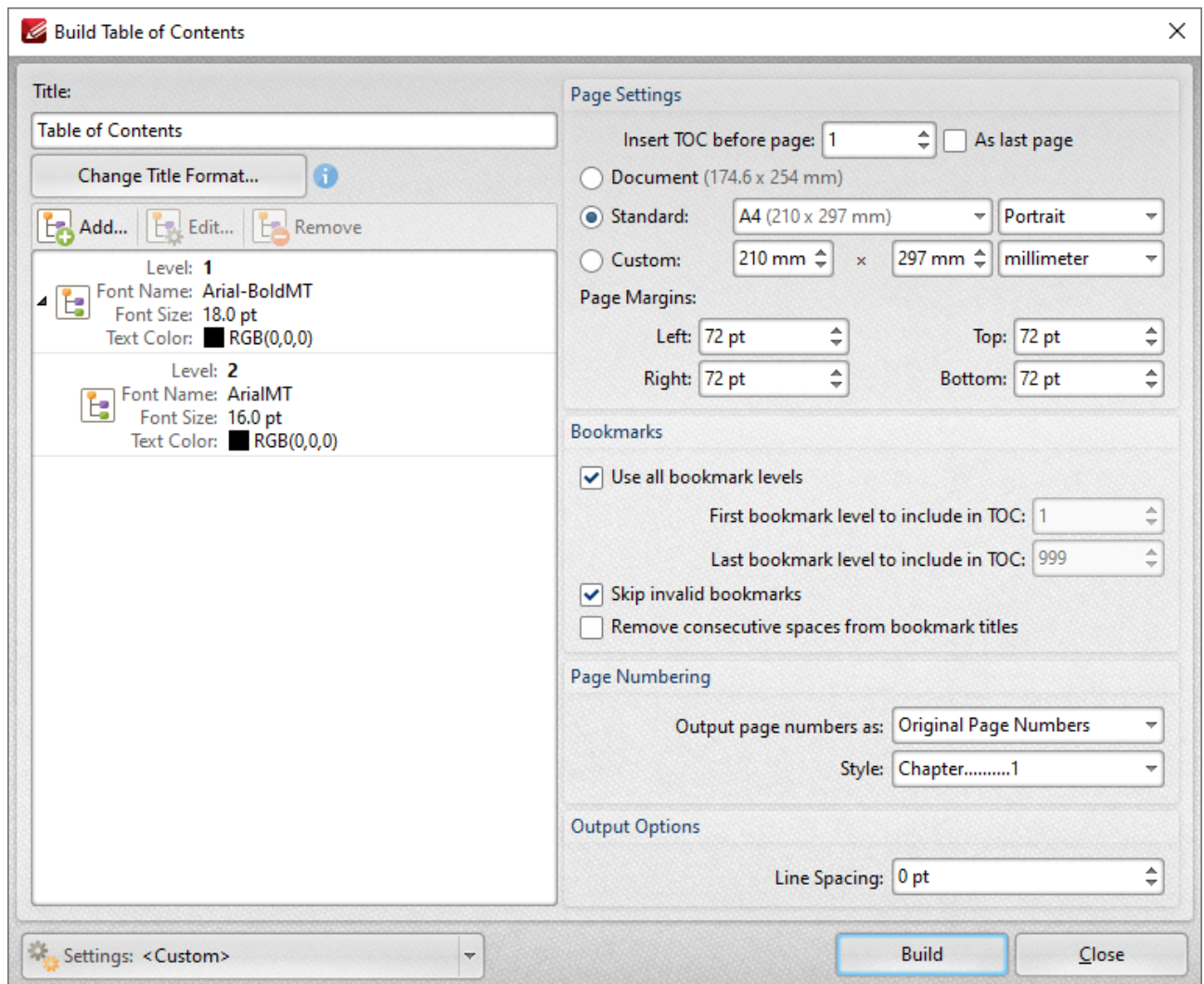

**Figure 1.** Build Table of Contents Dialog Box

- Enter a title for the table of contents in the **Title** text box.
- Click **Change Title Format** to edit the font and style of the title.



- The style for each level in the table of contents is detailed in the pane on the left. The levels correspond to the levels of the bookmark tree. Click **Add**, **Edit** or **Remove** to add, edit or remove levels.
- Use the **Insert TOC before page** number box to set the location of the table of contents, or select the **As last page** box to insert it at the end of the document.
- Select an option button to determine the page size of the table of contents:
  - **Document** uses the same page size as the pages of the source document.
  - **Standard** contains a list of standard page sizes, such as those used by the **ISO** and **ANSI**. Select an option from the list and then select **Portrait** or **Landscape** as desired in the dropdown menu on the right.
  - **Custom** uses custom page dimensions. Enter the desired dimensions in the number boxes and select a unit of measurement from the dropdown menu.
- Use the **Page Margins** number boxes to determine the page margins used for the table of contents.
- Select the **Use all bookmark levels** to include all bookmark levels in the creation of the table of contents. Alternatively clear the box and use the number boxes to determine the first and last bookmark levels to be included.
- Select the **Skip invalid bookmarks** box to exclude invalid bookmarks from the table of contents.
- Select the **Remove consecutive spaces from bookmark titles** box to rectify instances of consecutive white spaces.
- Select an option from the **Output page numbers as** dropdown menu to determine the format of page numbers in the table of contents.
- Select an option from the **Style** menu to determine the style of the table of contents.
- Click the arrow in the **Settings** dropdown menu to save/manage/delete customized settings.

Click **Build** to create the table of contents.

---

## 10.4.11.1 Create Links from Bookmarks

---



### Create Links from Bookmarks

---

Click **Create Links from Bookmarks** to create links in document text from bookmarks:

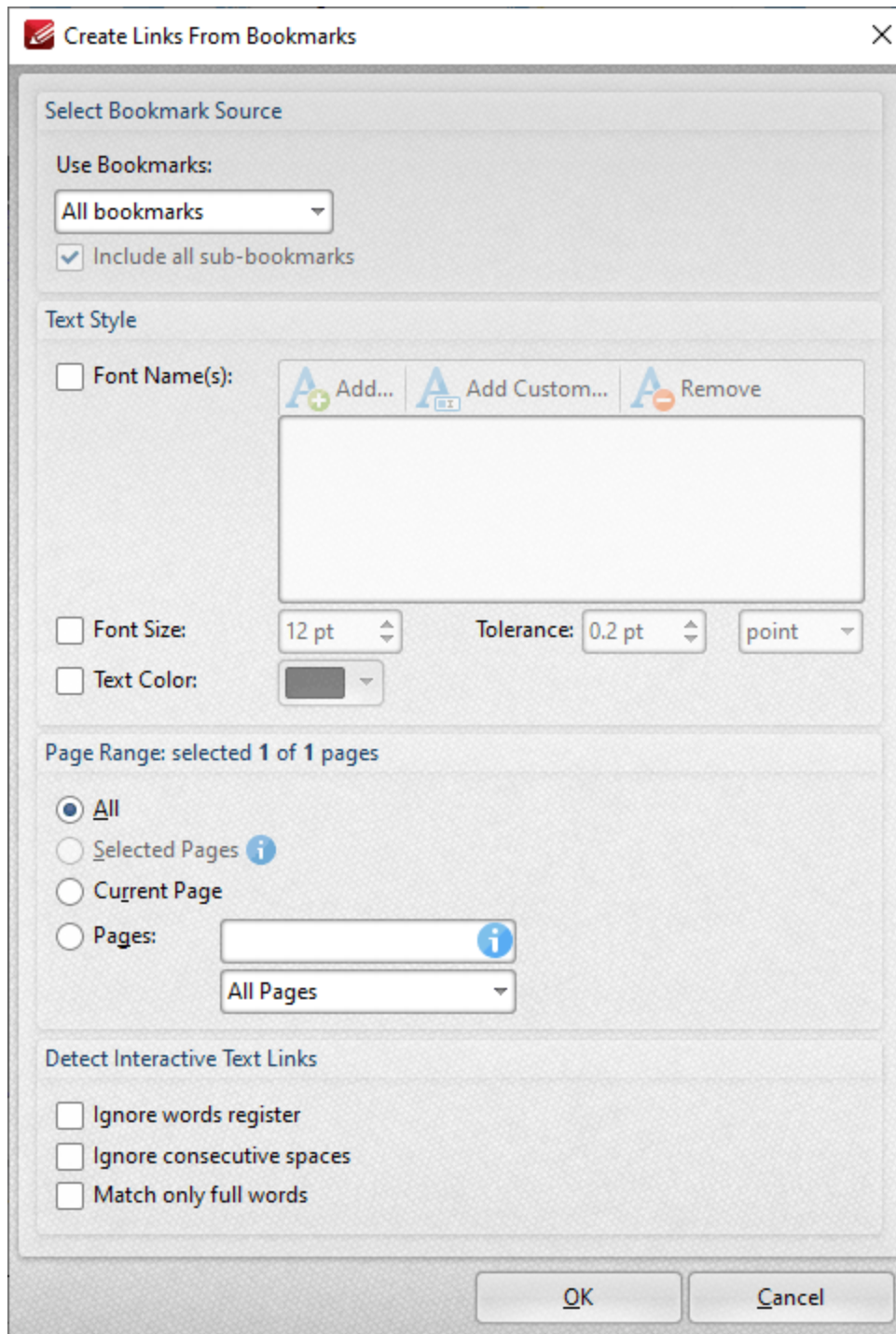



Figure 1. Create Links from Bookmarks Dialog Box

- Use the **Use Bookmarks** dropdown menu to determine the bookmarks used to create links.
- Select the **Include all sub-bookmarks** box to include sub-bookmarks.
- Use the **Text Style** options as necessary in order to specify the size and style options of document text that you want to convert to links. These options are included in order to make it

possible to distinguish between several instances of the same text within documents. If there is only a single instance of the text then it is not necessary to use these options.

- Use the **Page Range** options to determine the page range from which links are created. Further information about page range specification is available [here](#).
- Use the **Detect Interactive Text Links** boxes to enable/disable options for creating links.

Click **OK** to create links from bookmarks.

---

### 10.4.11.1!Sort Pages by Bookmarks



## Sort Pages by Bookmarks

Click **Sort Pages by Bookmarks** to sort document pages according to the order of bookmarks:

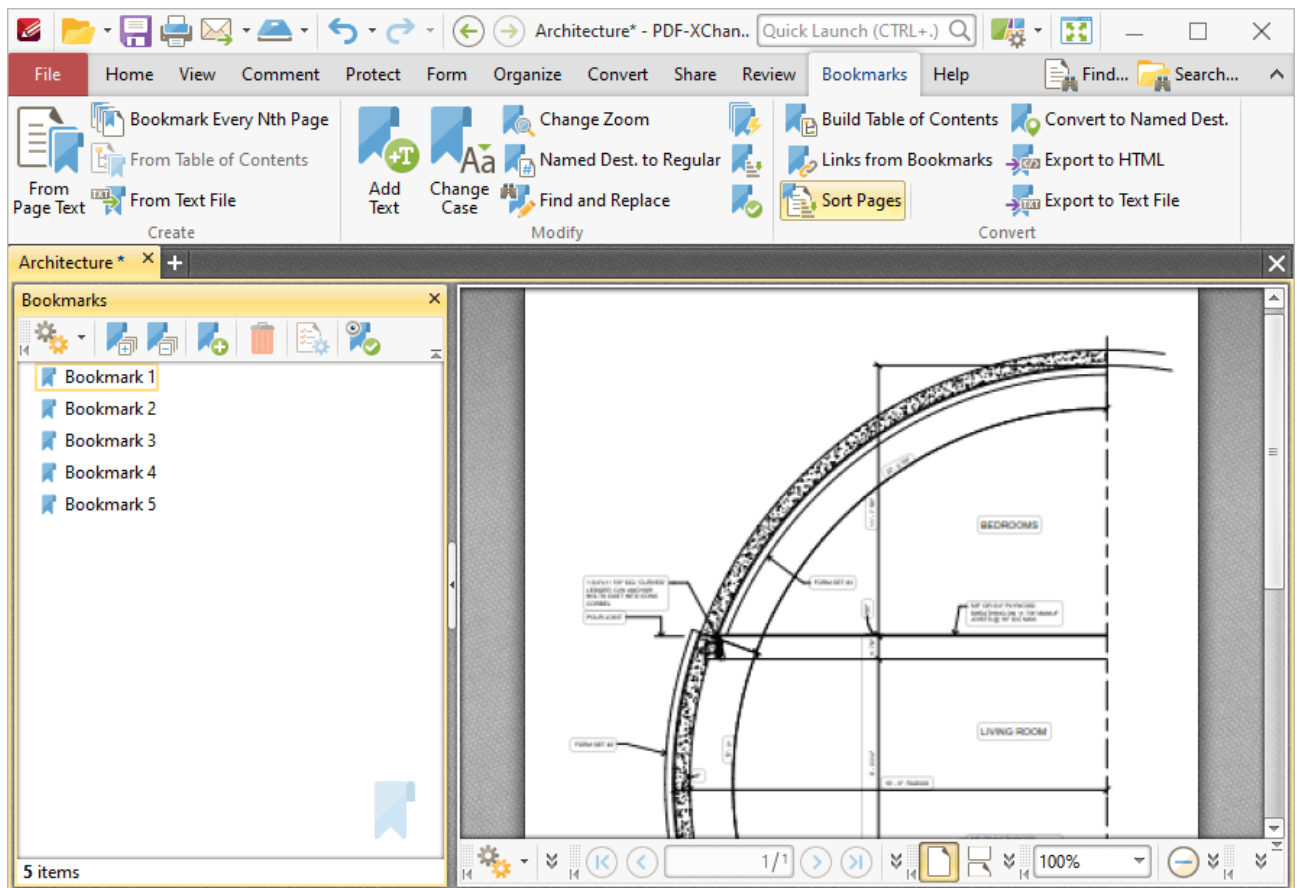

Figure 1. Bookmarks Tab, Sort Pages by Bookmarks Highlighted

PDF-XChange Editor will then reorder document pages to match the order of bookmarks.

### 10.4.11.1 Convert to Named Destinations



## Convert to Named Destinations

Click **Convert to Named Destinations** to convert regular bookmark destinations into named destinations. Regular bookmark destinations reference a page number, page coordinates and either a zoom level or a custom-sized rectangle when they are used. Named destinations are user-defined locations in documents that are created using the current view of the document at the time of their creation. They can be used in conjunction with [Bookmarks](#), [Go To Page](#) actions and the [/Open](#) command line. This feature converts regular destinations into named destinations, which means the associated bookmark will reference the same page view after pages are moved/reordered, which is their main benefit in comparison to regular destinations. When this feature is selected the following dialog box will open:

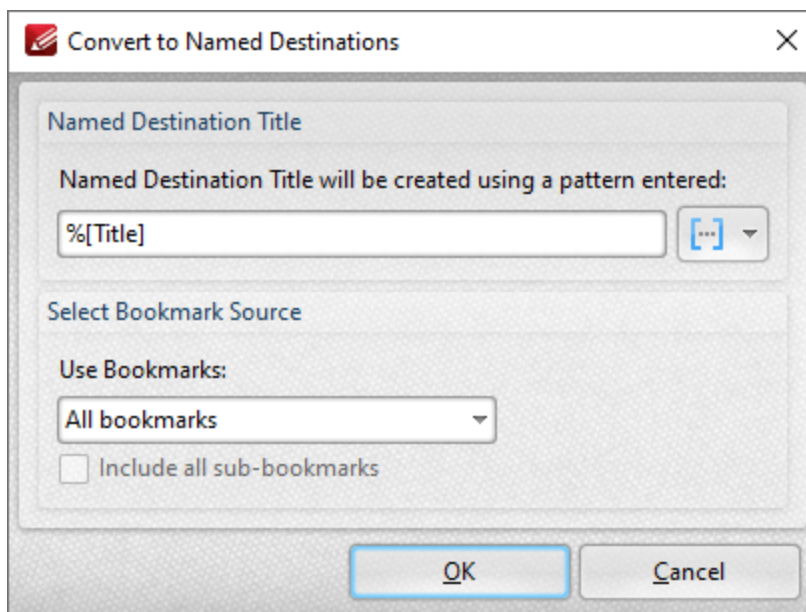

Figure 1. Convert to Named Destinations Dialog Box

- Enter a name for the new named destination in the **Named Destination Title** box. The default value is **%[Title]**, which means the name of the associated bookmark is used. Click the blue icon to add [macros](#) as desired.

- Select either **All Bookmarks** or **Selected Bookmarks** in the **Use Bookmarks** dropdown menu to determine which bookmarks are updated. Select bookmarks in the [Bookmarks](#)<sup>994</sup> pane in order to use the **Selected Bookmarks** option.
- Select the **Include all sub-bookmarks** box as desired.

Click **OK** to convert regular destinations to named destinations. Note that named destinations can be viewed in the [Named Destinations](#)<sup>1036</sup> pane.

---

#### 10.4.11.1 Export Bookmarks to HTML

---



#### Export Bookmarks to HTML

---

Click **Export Bookmarks to HTML** to export document bookmarks to an HTML file. The **Save File** dialog box will open. Enter the desired name for the file in the **file Name** text box and click **Save** to export the file.

---



## 10.4.11.1 Export Bookmarks to Text File

**Export Bookmarks to Text File**

Click **Export Bookmarks to Text File** to export bookmarks to a (\*.txt) text file:

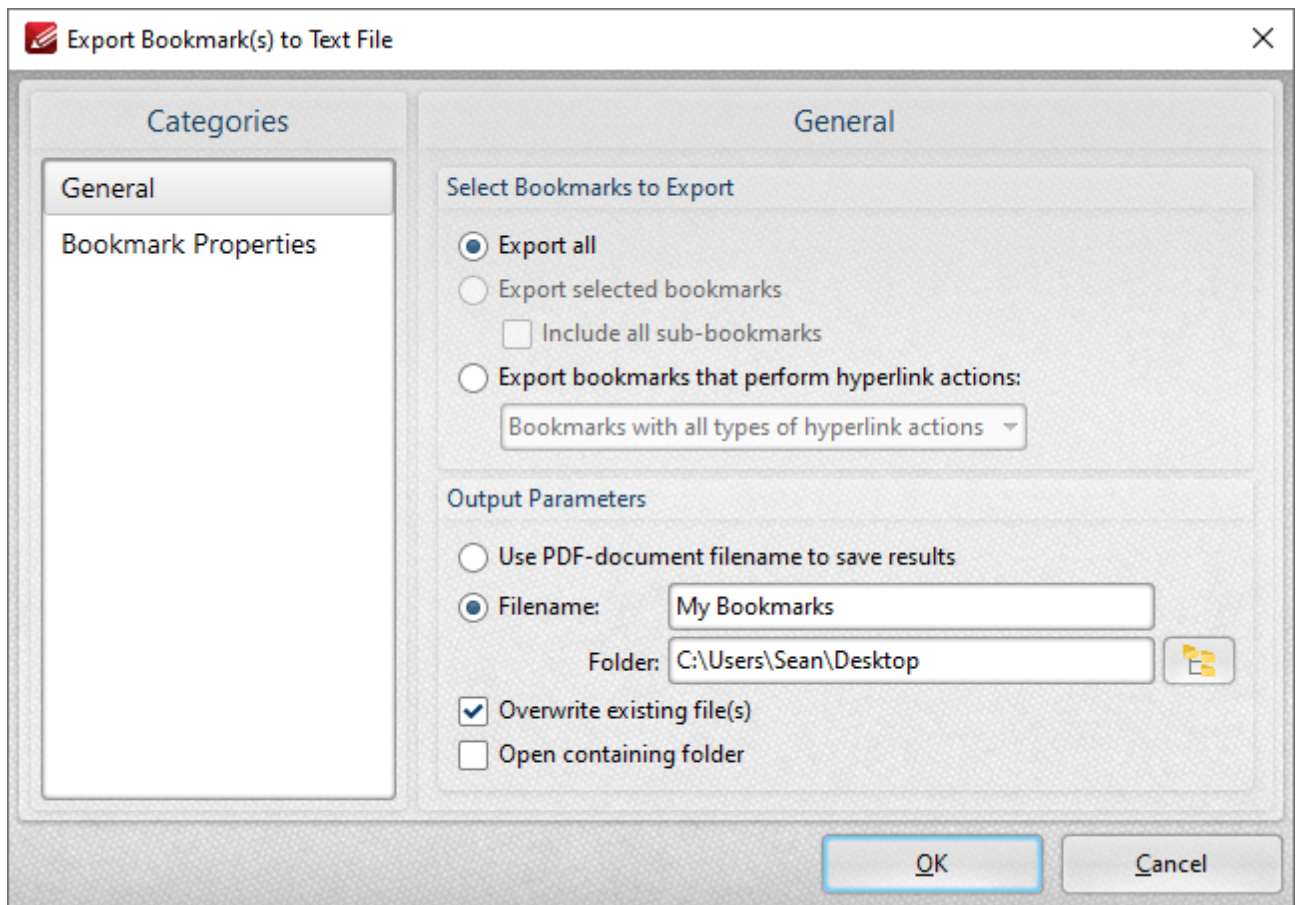

Figure 1. Export Bookmarks to Text File Dialog Box, General Tab Selected

Select the **General** tab to determine general export options:

- Select the **Export all** option button to export all bookmarks.
- Select the **Export selected bookmarks** option button to export only selected bookmarks. Select bookmarks in the [Bookmarks](#) <sup>994</sup> pane to use this option. Select the **Include all sub-bookmarks** box as desired.

- Select the **Export bookmarks that perform hyperlink actions** option button to export only bookmarks that perform hyperlink actions. Use the dropdown menu to determine which bookmarks are included in the process.
- Select the **Use PDF-document filename to save results** option button to use the name of the current document as the name of the text file.
- Alternatively, enter a name in the **Filename** text box. Use the **Folder** text box to determine the destination folder, or click the icon to select the folder manually.
- Select the **Overwrite existing files** box to overwrite files that have the same name in the destination folder.
- Select the **Open containing folder** box to open the containing folder at the end of the operation.

Select the **Bookmark Properties** tab to determine which bookmark properties are exported:

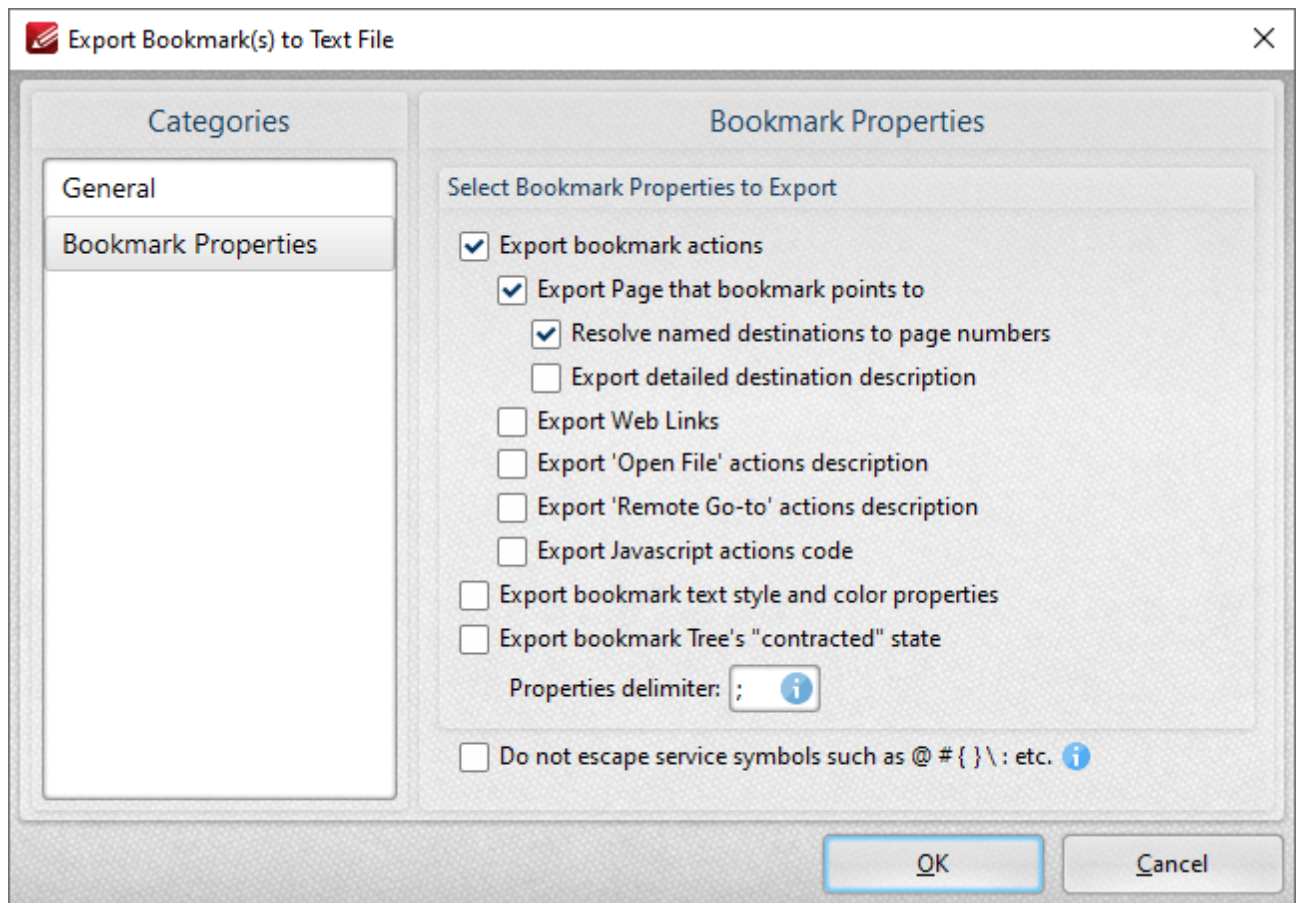

Figure 2. Export Bookmarks to Text File Dialog Box, Bookmark Properties Tab Selected

- Select the **Export bookmark actions** box to include bookmark actions in the export.
- Select the **Export Page that bookmark points to** box to include the page number of bookmark links.
- Select the **Resolve named destinations to page numbers** box to display named destinations as page numbers in the created text file. If this box is not selected then the name of the named

destination will be exported instead. Further information on named destinations is available [here](#).<sup>1036</sup>

- Select the **Export detailed destination description** box to export a more detailed description of named destinations.
- Select the **Export Web Links** box to include weblinks in the export file.
- Select the **Export 'Open File' actions description** to include a description of **'Open File'** actions in the export file. These actions open files when bookmarks are clicked. Further information on bookmark actions is available [here](#).<sup>994</sup>
- Select the **Export 'Remote Go-to' actions description** box to include a description of **'Go-To'** actions in the export file. These actions navigate to a document page when bookmarks are clicked. Document pages can be located in the current document, a different document or an embedded document. Further information on bookmark actions is available [here](#).<sup>994</sup>
- Select the **Export JavaScript actions code** box to include bookmark JavaScript actions in the export file. These actions execute JavaScript when bookmarks are clicked. Further information on bookmark actions is available [here](#).<sup>994</sup>
- Select the **Export Bookmark text style and color properties** box as desired.
- Select the **Export bookmark tree's "contracted" state** box to export bookmarks in collapsed format.
- Use the **Properties delimiter** box to set the delimiter that separates bookmark properties in the text file.
- Select the **Do not escape service symbols** box as desired. If the files that the **Export Bookmarks to Text Files** feature creates will be used in conjunction with the **Generate Bookmarks from Text File** feature then it is advisable to select this box.

Click **OK** to export bookmarks to text file.

---

10.4.12 Help Tab



**Help Tab**

When the **Help** tab is selected, the following options are available:

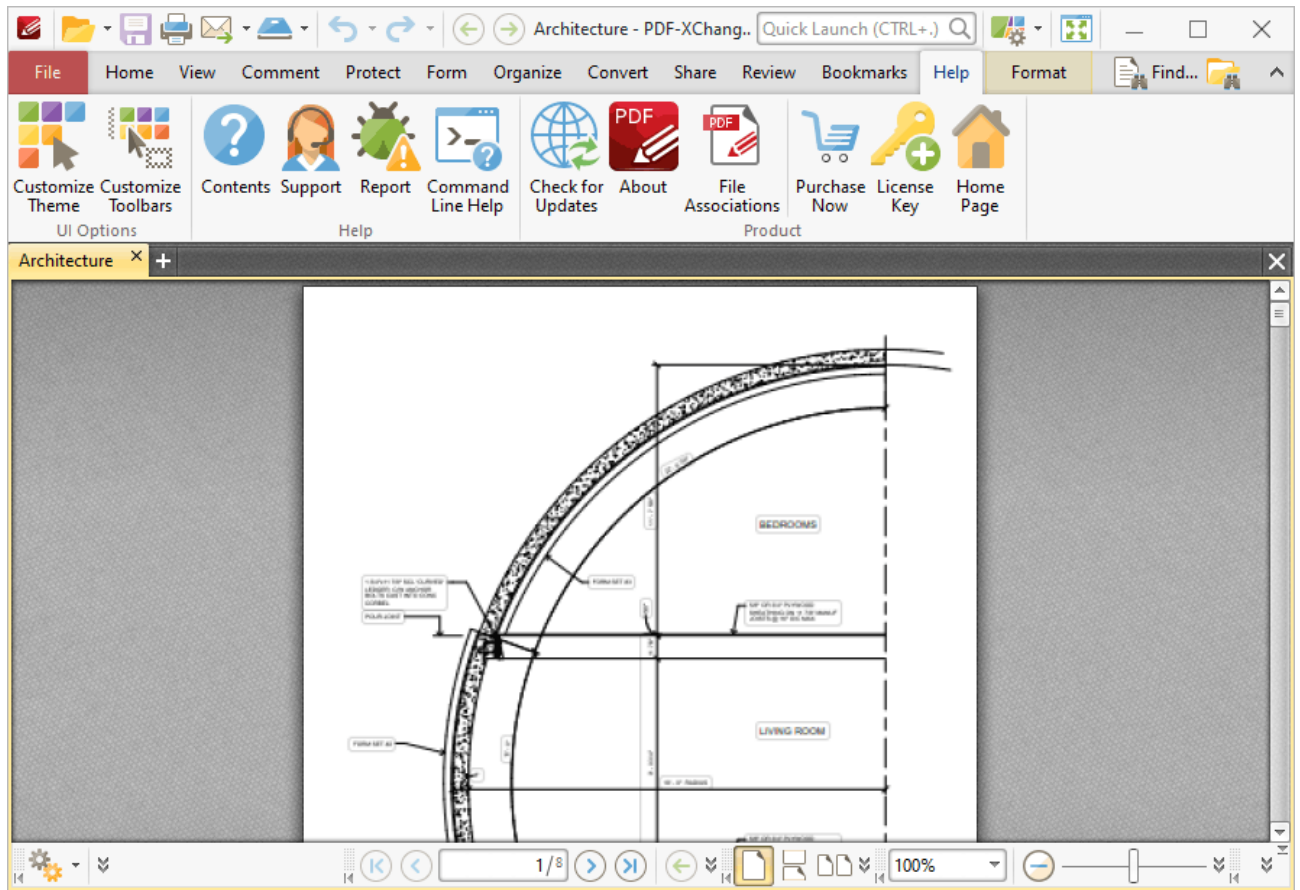
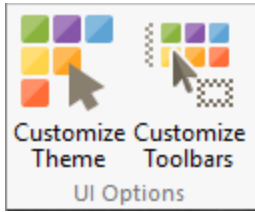

Figure 1. Help Tab

The options in the **Help** tab are used to customize **PDF-XChange Editor** and access help and other options associated with the software. There are three groups in the **Help** tab:

**UI Options**

The options in the **UI Options** group are used to customize the layout and content of the user interface:



- Click **Customize Theme** to customize the fonts, colors and backgrounds used in the user interface, as detailed [here](#).<sup>[879]</sup>
- Click **Customize Toolbars** to customize the content, display and interactive options of the toolbars in **PDF-XChange Editor**, as detailed [here](#).<sup>[1599]</sup>

## Help

The options in the **Help** group are used to access assistance when using **PDF-XChange Editor**:

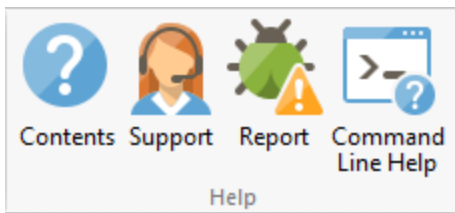

- Click **Contents** (or press F1) to access the online manual.
- Click **Support** to launch the **PDF-XChange Editor** support forum.
- Click **Report** to reports bugs and other issues with the software, as detailed [here](#).<sup>[1622]</sup>
- Click **Command Line Help** to view command line options for the software.

## Product

The options in the **Product** tab contain further options for **PDF-XChange Editor**:

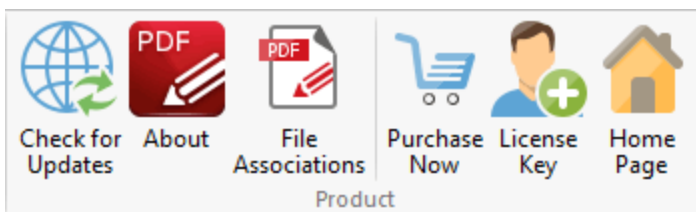

- Click **Check for Updates** to check for updates to the **PDF-XChange** family of products.
- Click **About** to view further details about **PDF-XChange Editor**.
- Click **File Associations** to view/edit file associations for **PDF-XChange Editor**, as detailed [here](#).<sup>[883]</sup>
- Click **Purchase Now** to purchase a license for the software.

- Click **License Key** to view/edit/add license keys, as detailed [here](#).
  - Click **Home Page** to launch the **PDF-XChange Editor** page of the **PDF-XChange** website.
-

10.4.12.1 Customize Toolbars



Customize Toolbars

Click **Customize Toolbars** to customize the ribbon tabs and their settings in **PDF-XChange Editor**:

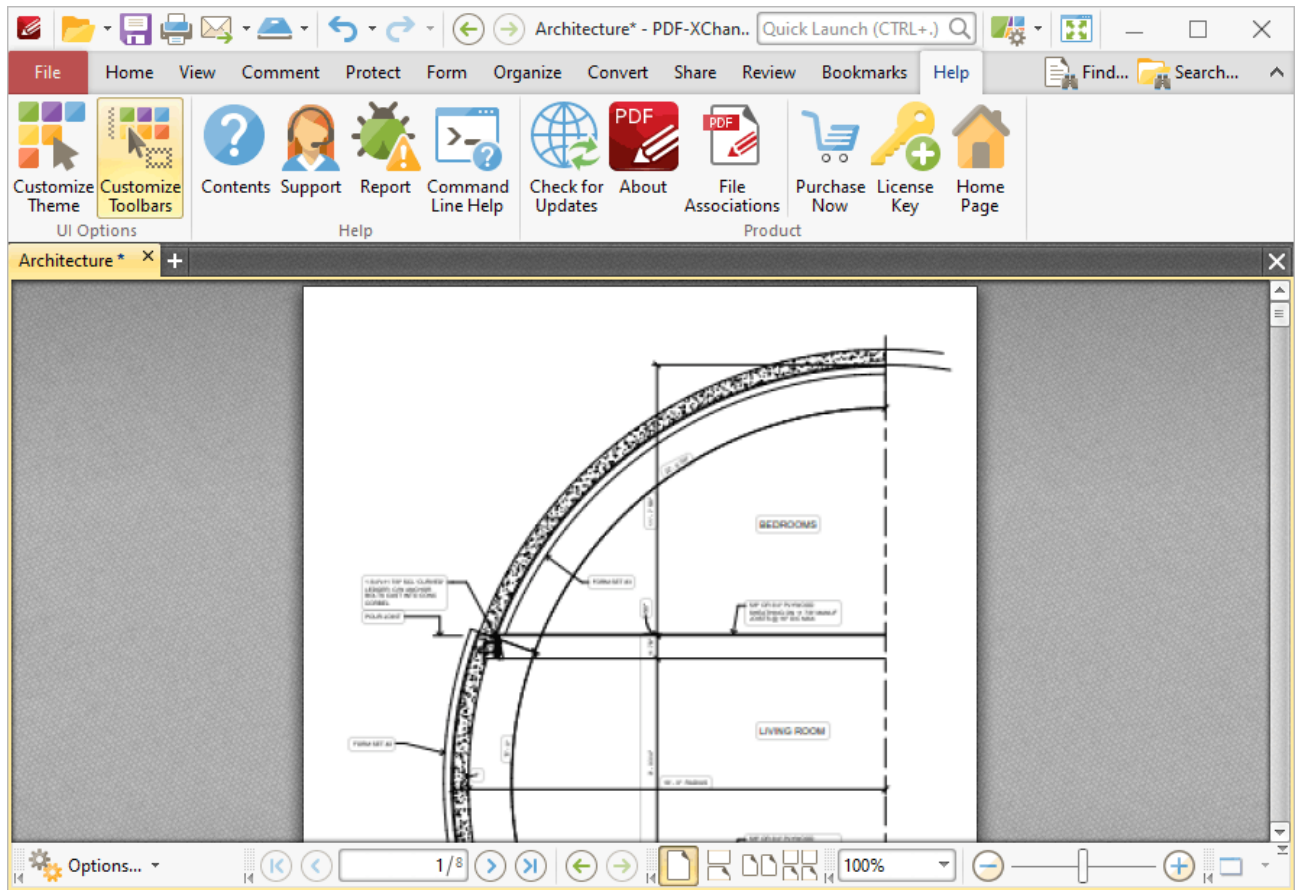

Figure 1. Help Tab, Customize Toolbars

The **Customize Toolbars** dialog box will open:

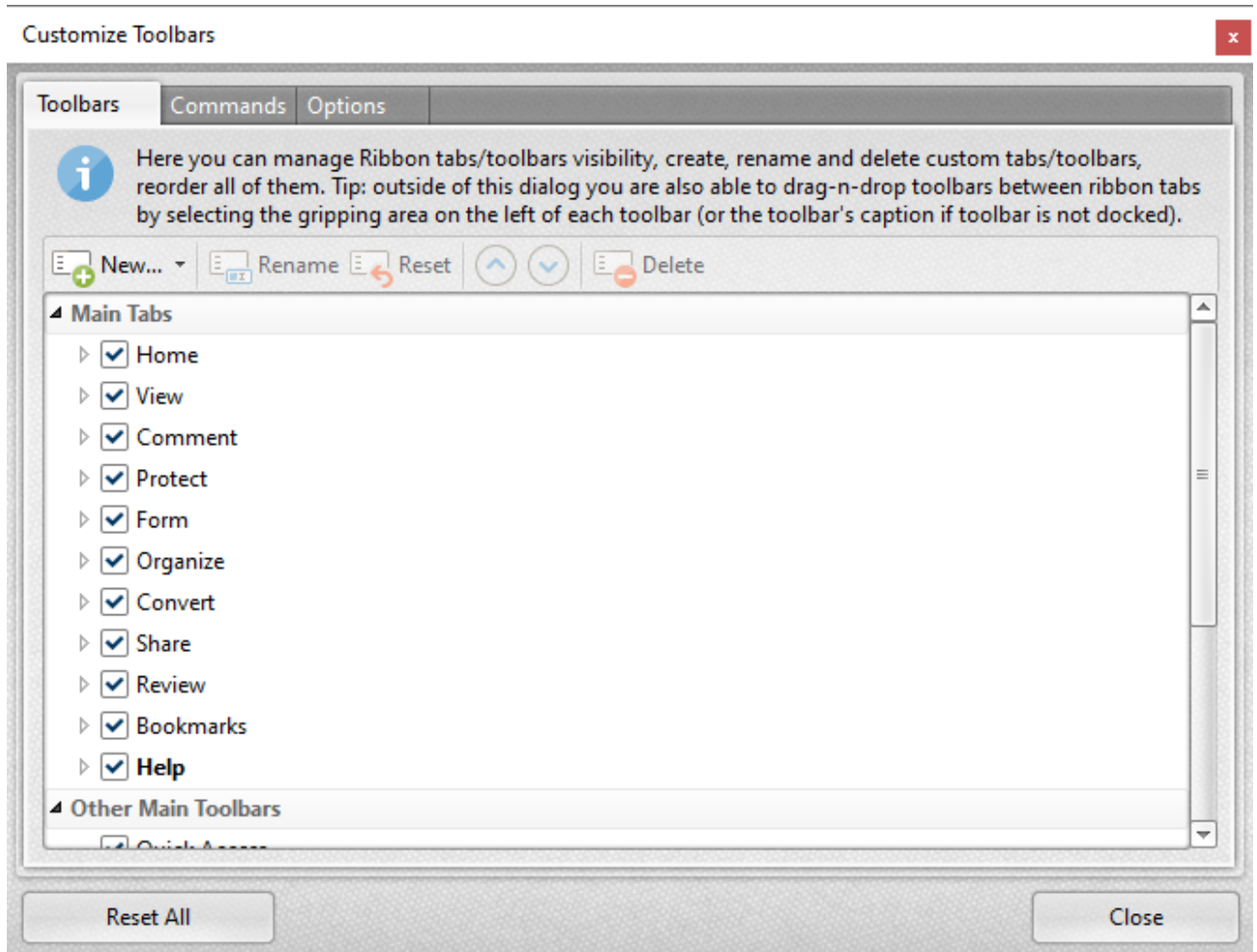

Figure 2. Customize Toolbars Dialog Box, Toolbars Tab

Use the options in the **Toolbars** tab to determine the ribbon tabs that are visible in the user interface and the commands that they contain, and **Rename/Reset/Delete** selected toolbars/ribbon tabs. Note that the [Reset Settings](#)<sup>933</sup> feature can be used to revert to the default settings and layout of **PDF-XChange Editor** at any time.

The tabs in the ribbon (with the exception of the **File** tab) each have a corresponding box in the **Customize Toolbars** dialog box. Select/clear the boxes in the dialog box to show/hide the corresponding tab:



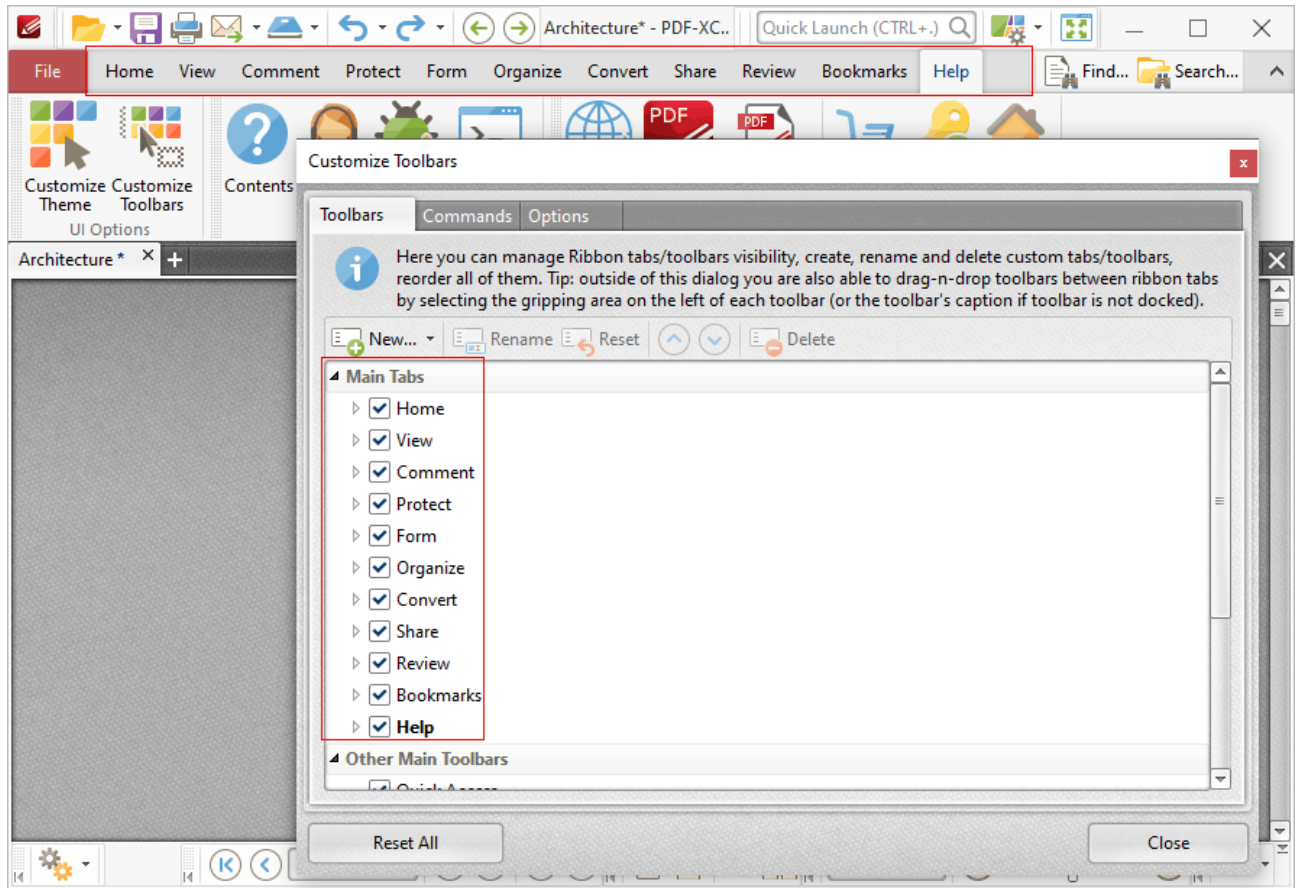

Figure 3. Customize Toolbars Dialog Box, Ribbon Tabs and Check Boxes Highlighted

Expand the boxes to view a breakdown of the groups that the associated ribbon contains, then select/clear boxes to show/hide the corresponding group in the ribbon tab:

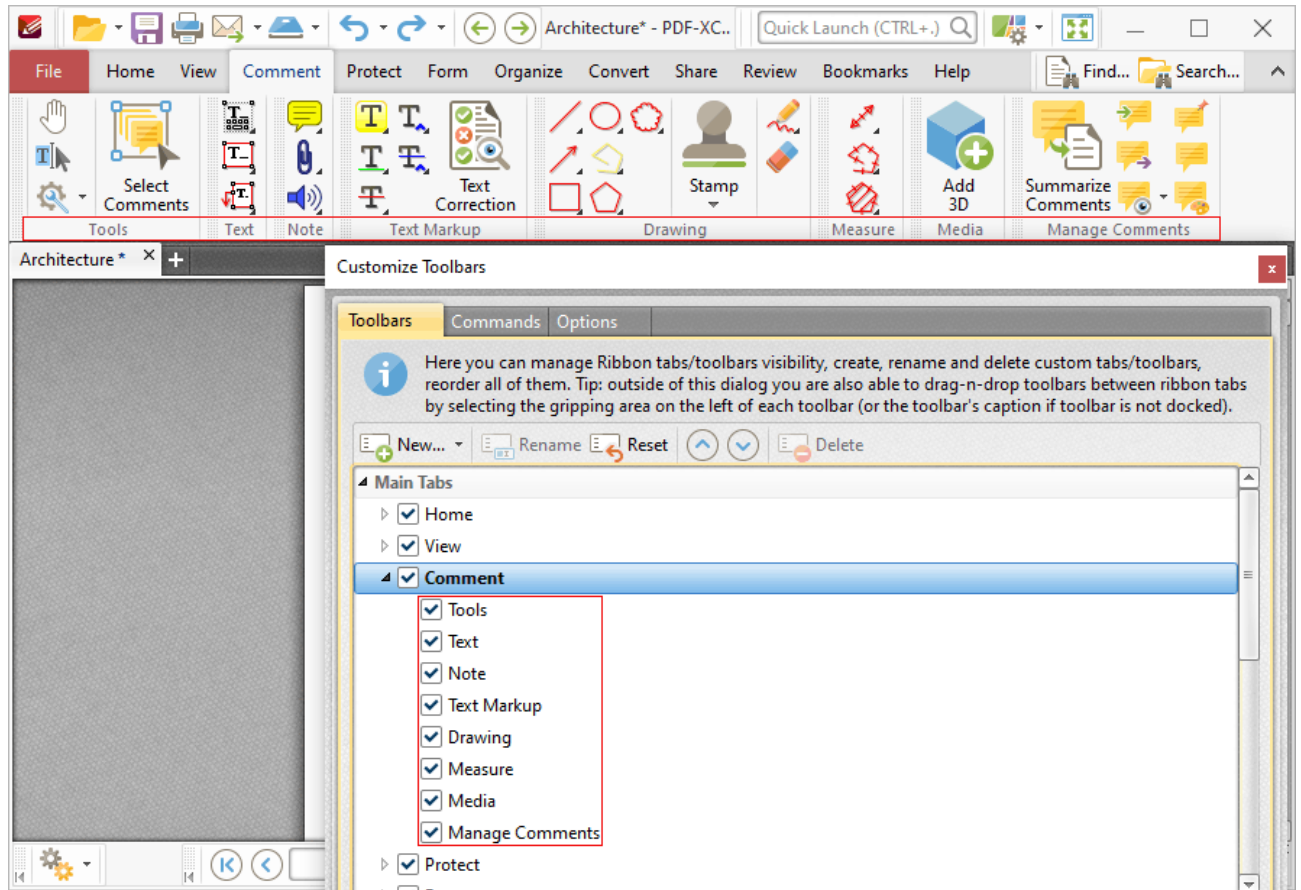

Figure 4. Customize Toolbars Dialog Box, Ribbon Groups and Check Boxes Highlighted

Note that it is also possible to right-click ribbon tabs in order to perform these operations:

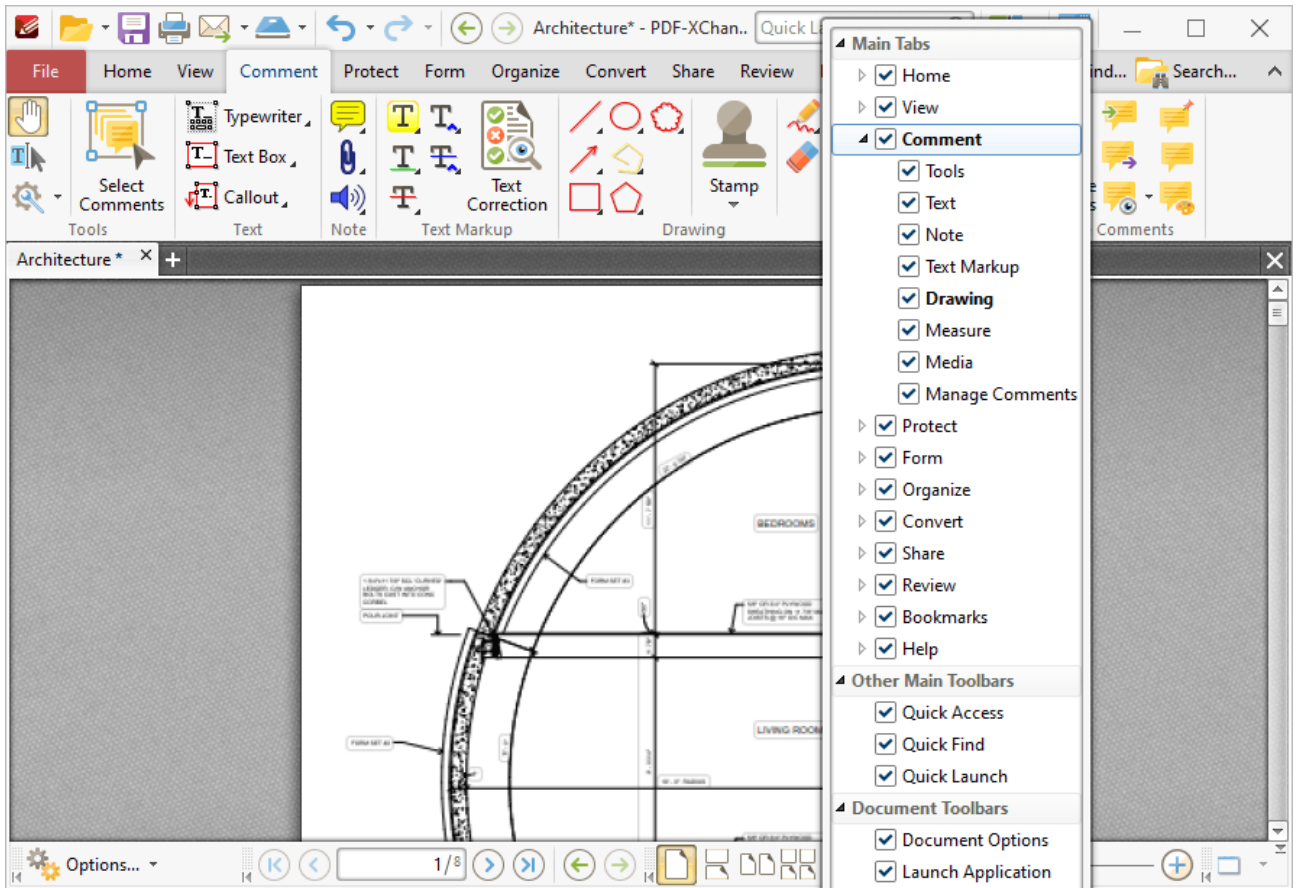

Figure 5. Ribbon Tab Right-Click Submenu Options

Additional options are available when the **Customize Toolbars** dialog box is open and ribbon items are right-clicked:

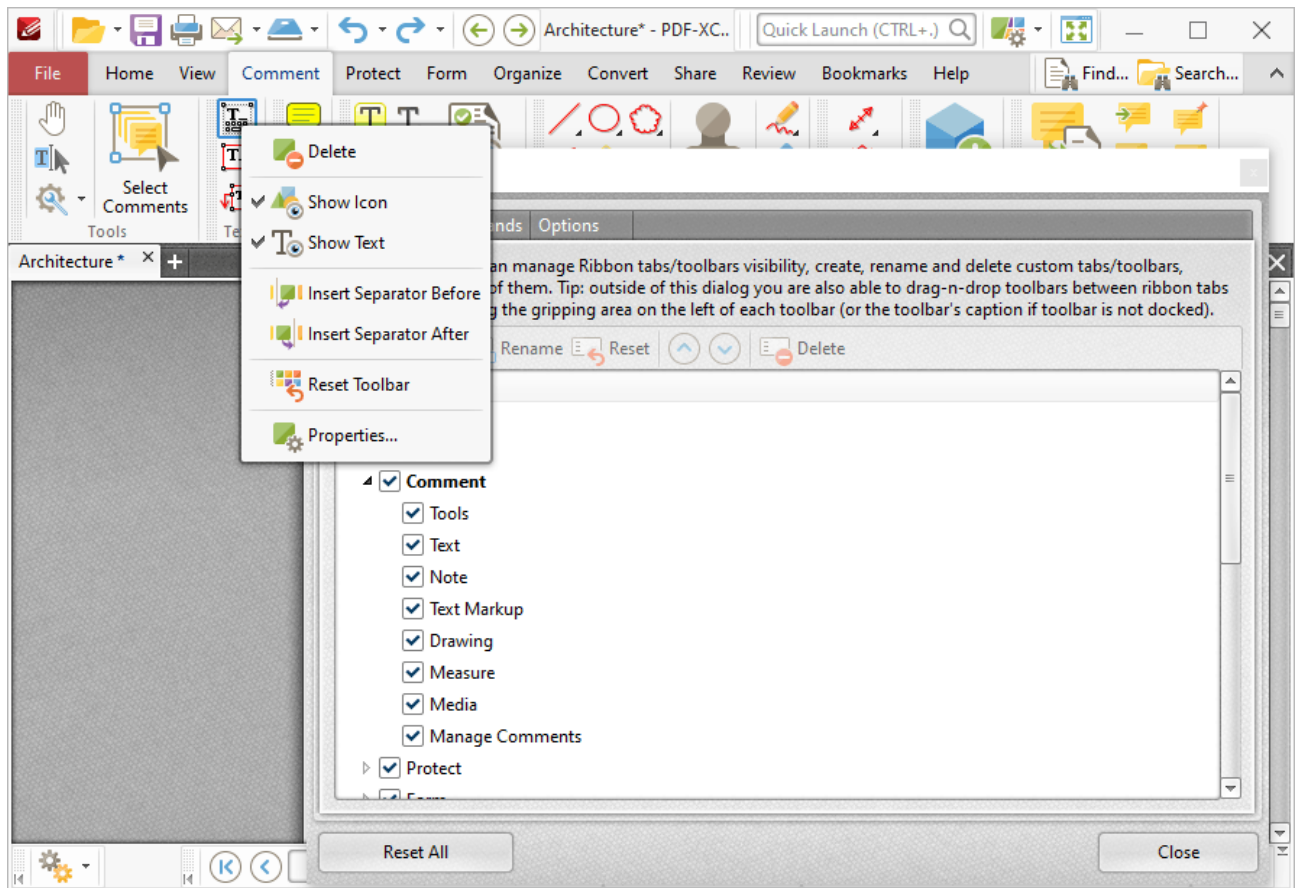

Figure 6. Shortcut Menu for Ribbon Items

- Click **Delete** to remove the selected item from the ribbon.
- Click **Show Icon** to show/hide the icon of the selected item.
- Click **Show Text** to show/hide the text for the selected item.
- Click **Insert Separator Before/After** to insert an item separator before/after the selected item. Separators are used to define areas in which ribbon items can be placed.
- Click **Reset Toolbar** to reset the selected ribbon group.
- Click **Properties** to view/edit the properties of the selected item. Please note that properties are read-only, except for those that relate to the keyboard shortcut for the item. The process of creating/editing keyboard shortcuts is detailed [here](#).<sup>1704</sup>

## Other Main Toolbars and Document Toolbars

Select/clear the boxes in the **Other Main Toolbars** and **Document Toolbars** sections to show/hide the associated toolbars in the user interface:

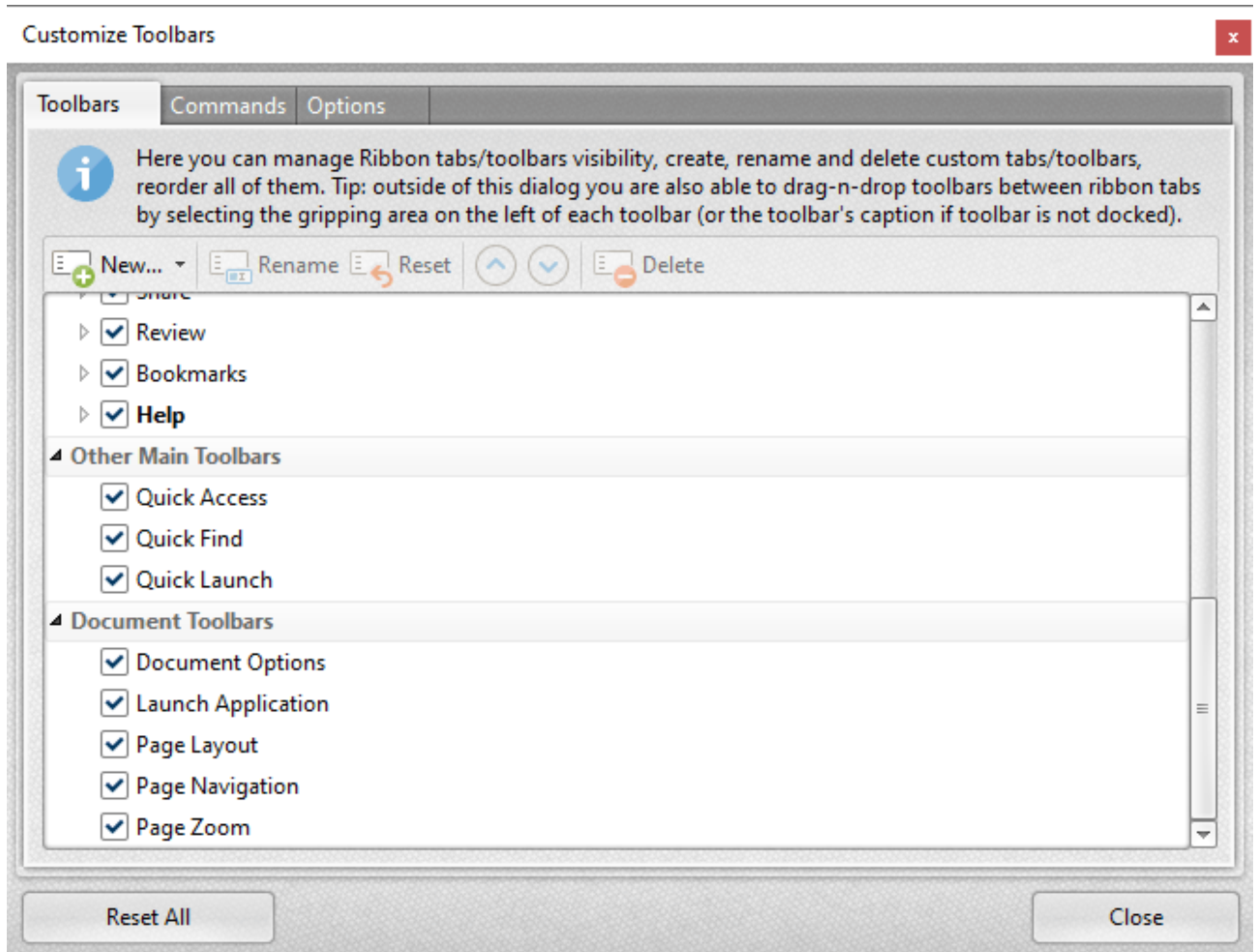

Figure 7. Customize Toolbars Dialog Box, Other Main Toolbars and Document Toolbars Options

### ▼ Quick Access, Quick Find and Quick Launch Toolbars

These toolbars are located in the upper section of the user interface:

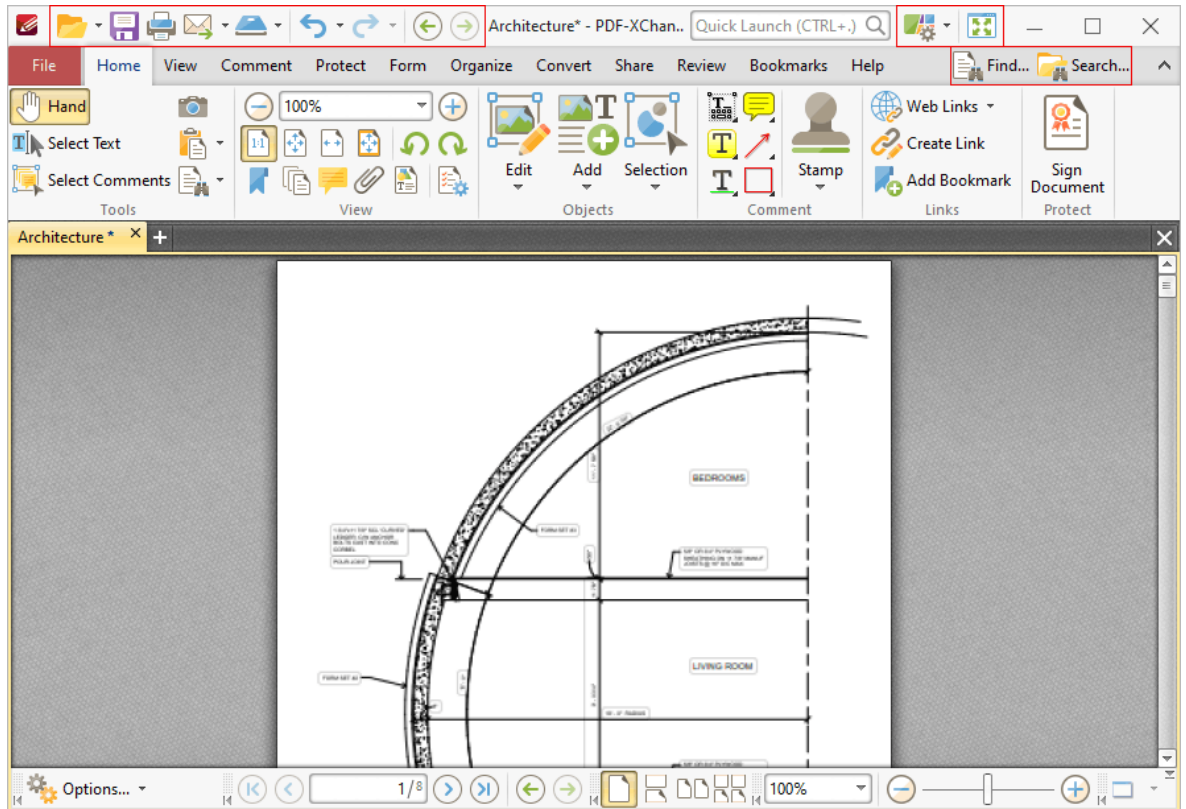

Figure 8. Quick Access, Quick Launch and Quick Find Toolbars

- Click **Undo** to undo the most recent editing action.
- Click **Redo** to reverse the most recent undo action.
- Click **Find** to activate the [Find](#) function and locate specified text in the active document.
- Click **Search** to open the [Search](#) pane and search documents open in **PDF-XChange Editor** or folders on the local computer.
- Click **Full Screen Mode** to view the active document in full screen mode.
- Click **UI Options** to toggle between the options for the display of the user interface:

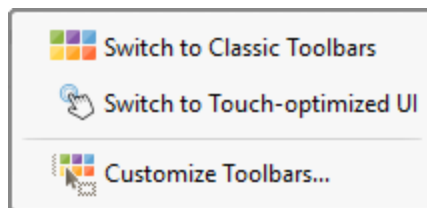

Figure 9. UI Options

- Click **Switch to Classic Toolbars** to switch to the classic toolbars layout of **PDF-XChange Editor**. The manual for this layout is available [here](#).

- Click **Switch to Touch-optimized UI** to switch from **Mouse-optimized UI** to **Touch-Optimized UI** and vice versa. The **Touch-optimized UI** features larger icons and is intended for use in conjunction with tablets, smartphones and similar devices.
- Click **Customize Toolbars** to customize the layout of toolbars, the commands that they contain and their display/locking options.

### ▼ Document Options Toolbar

The **Document Options Toolbar** is located in the lower left corner of the user interface:

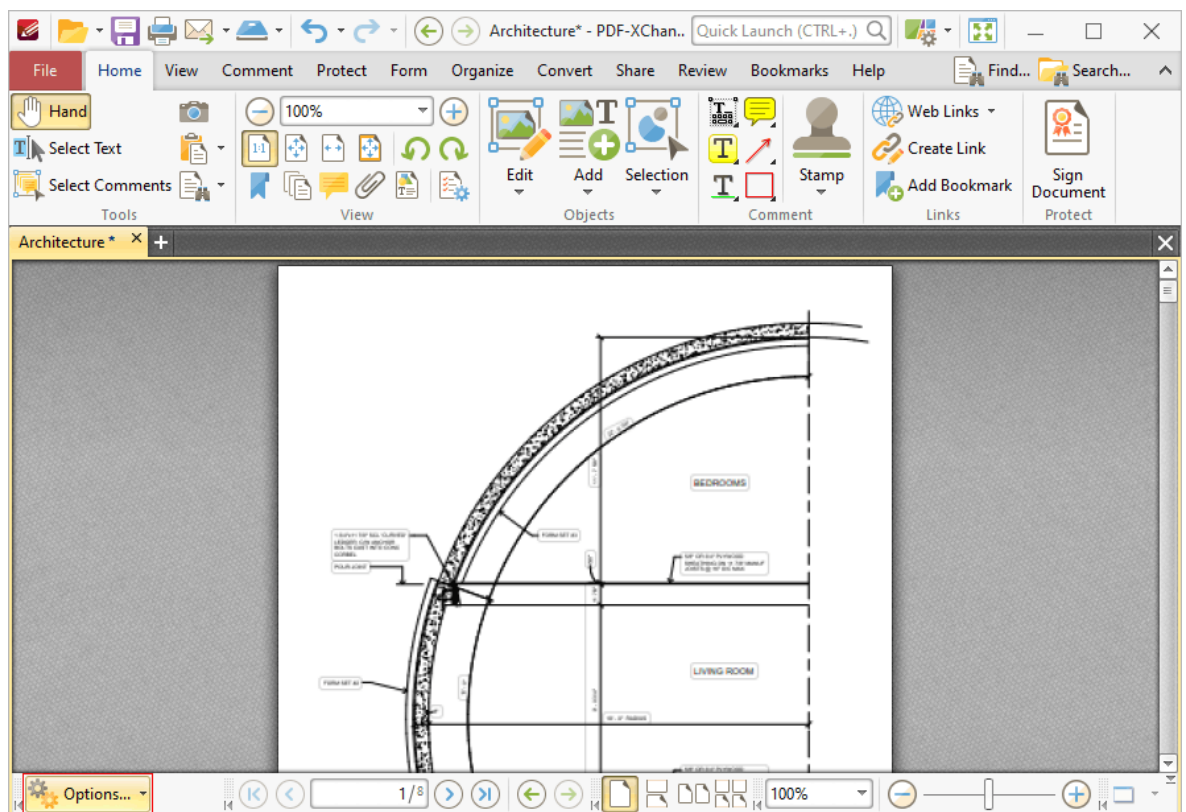

Figure 10. Document Options Toolbar

Click the dropdown arrow to access the options detailed in the submenu below:

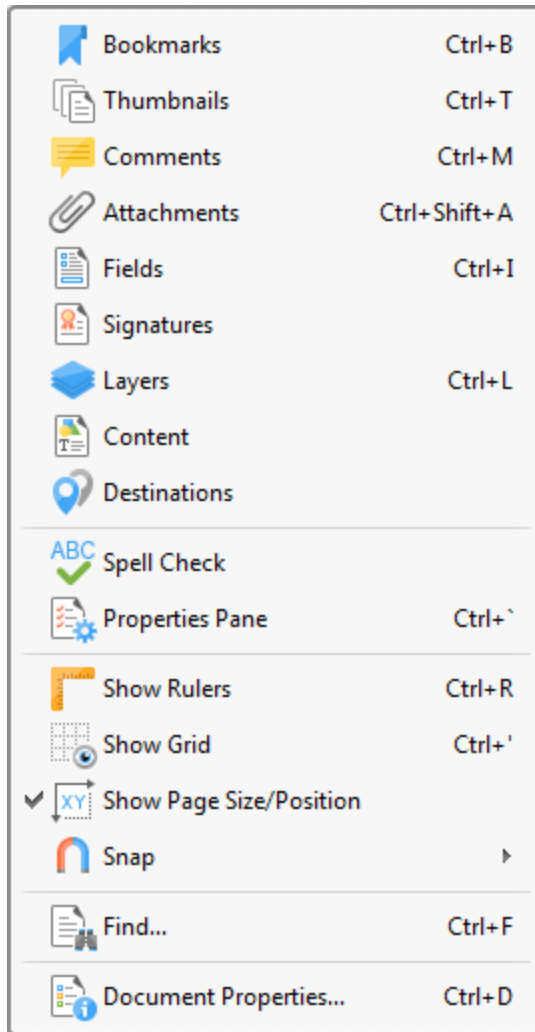

Figure 11. Document Options Menu

- Click **Bookmarks** to open the **Bookmarks** pane. See [here](#)<sup>994</sup> for further information.
- Click **Thumbnails** to open the **Thumbnails** pane. See [here](#)<sup>1000</sup> for further information.
- Click **Comments** to open the **Comments** pane. See [here](#)<sup>1007</sup> for further information.
- Click **Attachments** to open the **Attachments** pane. See [here](#)<sup>1014</sup> for further information.
- Click **Fields** to open the **Fields** pane. See [here](#)<sup>1016</sup> for further information.
- Click **Signatures** to open the **Signatures** pane. See [here](#)<sup>1248</sup> for further information.
- Click **Layers** to open the **Layers** pane. See [here](#)<sup>1024</sup> for further information.
- Click **Content** to open the **Content** pane. See [here](#)<sup>1032</sup> for further information.
- Click **Destinations** to open the **Destinations** pane. See [here](#)<sup>1036</sup> for further information.
- Click **Spell Check** to check the spelling of the active document. See [here](#)<sup>1545</sup> for further information.
- Click **Properties Pane** to open the **Properties** pane. See [here](#)<sup>1065</sup> for further information.



- Click **Show Rulers** to view/hide the document rulers. See [here](#)<sup>[1075]</sup> for further information.
- Click **Show Grid** to insert a grid behind the active document to assist in the accurate placement of document content. See [here](#)<sup>[1075]</sup> for further information.
- Click **Show Page Size/Position** to view/hide the **Page Measurement** information, which is detailed beneath (*figure 1*).
- Hover over **Snap** to view options for snapping:
  - Click **Enable Snapping** to enable/disable snapping.
  - Click **Snap to Grid** to enable/disable snapping to grids.
  - Click **Snap to Guides** to enable/disable snapping to guides.
  - Click **Snap to Objects** to enable/disable snapping to objects.
  - Further information about snapping is available [here](#)<sup>[898]</sup>
- Click **Find** to launch the find text function. See [here](#)<sup>[1688]</sup> for further information.
- Click **Document Properties** to launch the **Document Properties** dialog box. See [here](#)<sup>[843]</sup> for further information.

### ▼ Launch Application Toolbar

The **Launch Application Toolbar** is located on the lower-right corner of the main window:

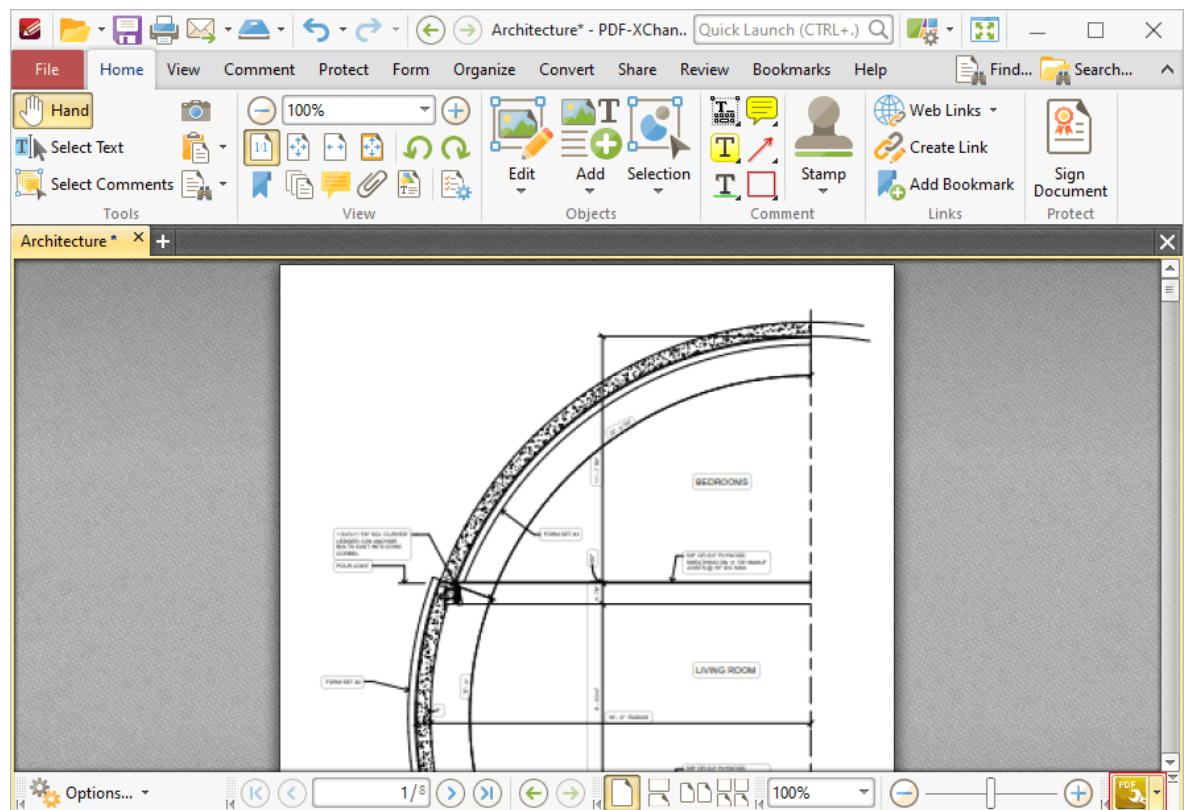

Figure 12. Launch Application Toolbar

This toolbar provides a convenient way to open active documents using third party applications. See [here](#)<sup>895</sup> for instructions on how to add applications to this toolbar.

### ▼ Page Layout Toolbar

The **Page Layout Toolbar** is located on the lower right side of the main window:

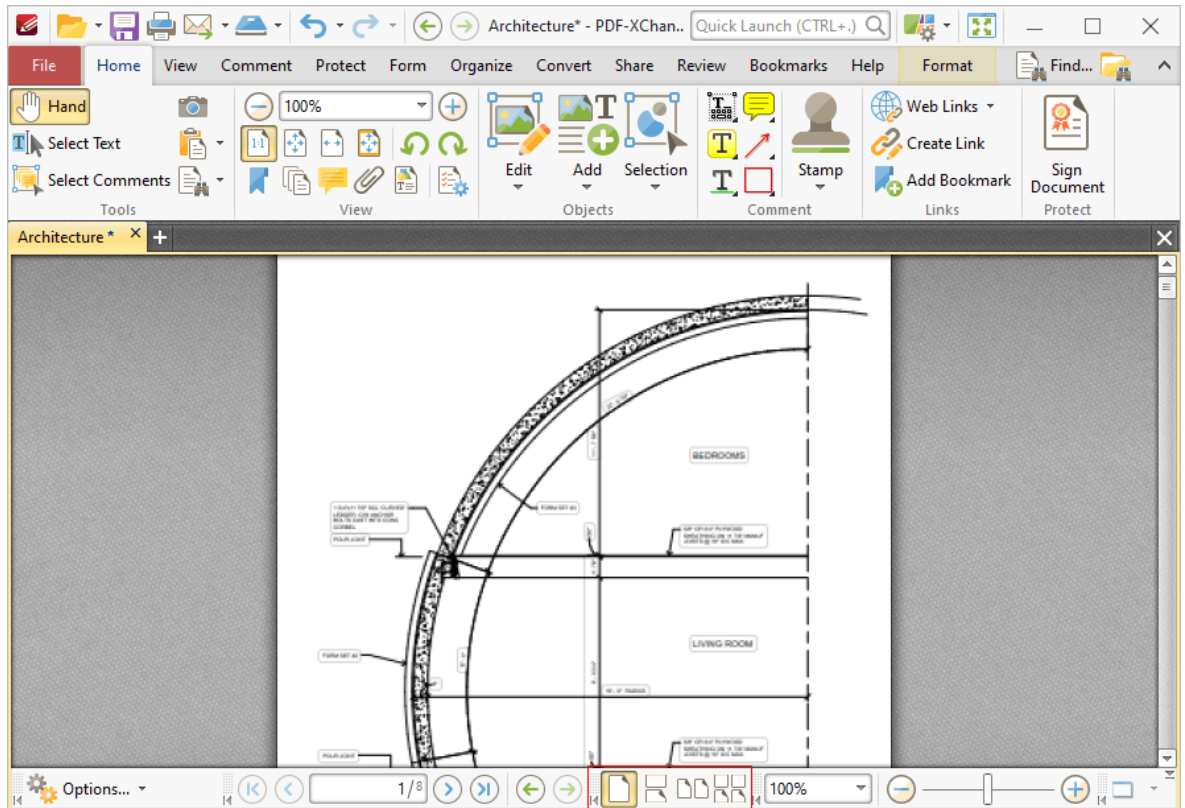

Figure 13. Page Layout Toolbar

- The page layout options determine how pages of active documents are displayed in the main window. The layouts correspond to those displayed in the icons of the toolbar:
  - **Single Page** displays documents a single whole page at a time.
  - **Continuous** displays documents as single pages continuously, which means consecutive pages can be viewed at the same time when scrolling.
  - **Two Pages** displays documents two whole pages at a time. Pages are placed adjacently in the main window.
  - **Two Pages Continuous** displays documents as two pages continuously, which means consecutive pairs of pages can be viewed at the same time when scrolling.

Further options relating to the page display are available [here](#).<sup>863</sup>

### ▼ Page Navigation Toolbar

The **Page Navigation Toolbar** is located at the bottom of the main window:

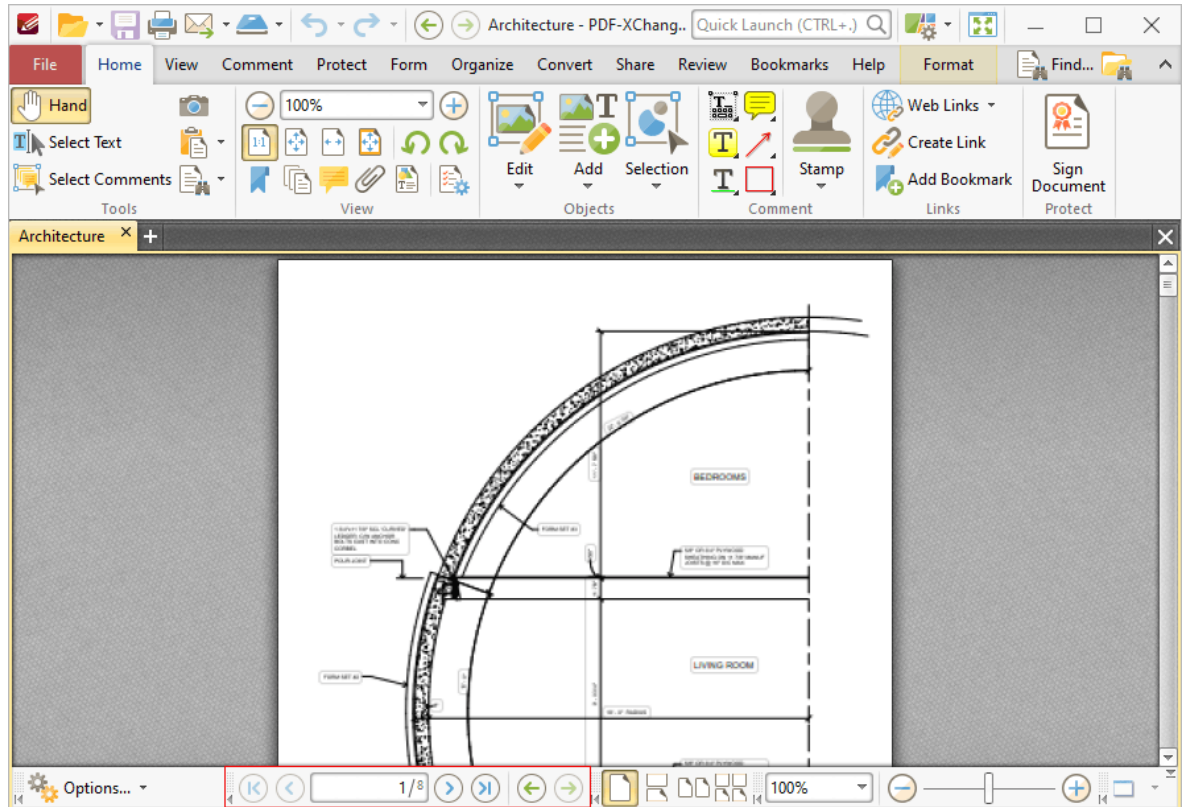

**Figure 14.** Page Navigation Toolbar

- Click the blue arrow icons to move to the first page, previous page, next page or last page of documents.
- Click the green arrow icons to move between the most recent document views.
- The number box at the center of the **Page Navigation** toolbar shows the current page and the total number of pages in the active document. Enter a page number and press **Enter** to move to it.

### ▼ Page Zoom Toolbar

The **Page Zoom Toolbar** is located in the lower-right section of the main window:

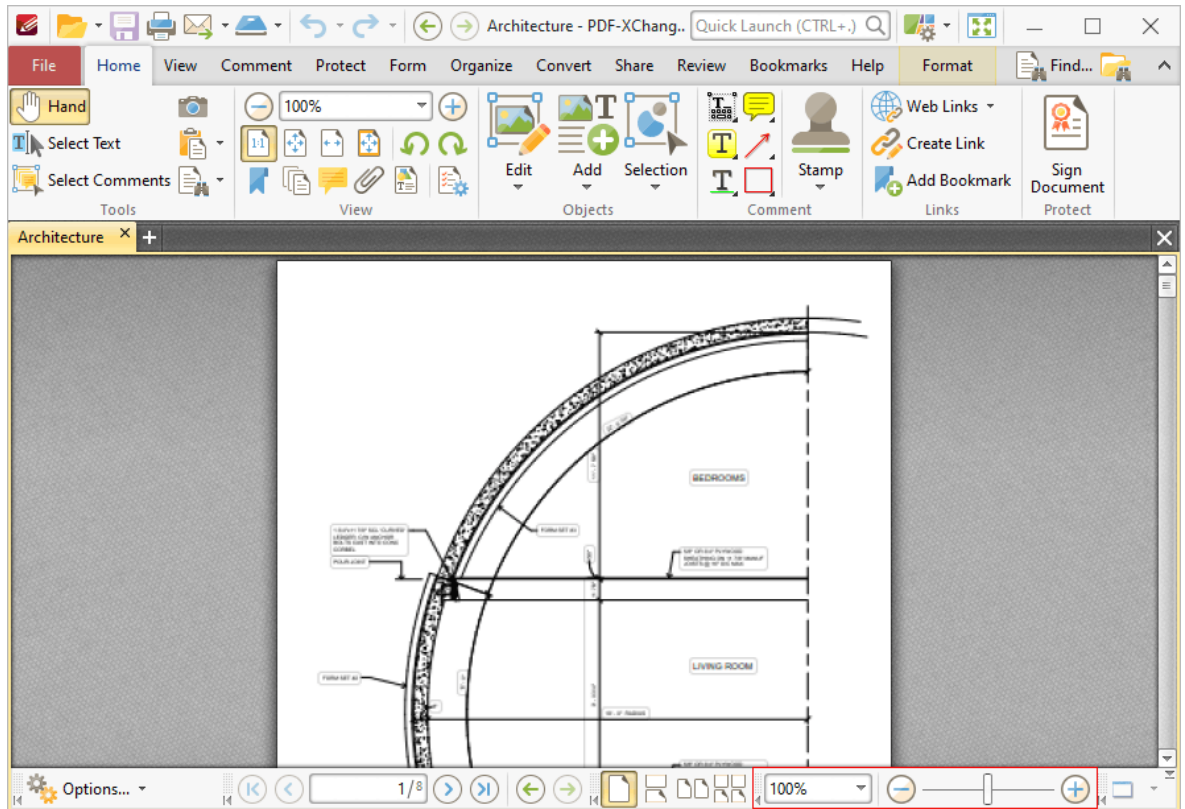

Figure 15. Page Zoom Toolbar

The **Page Zoom Toolbar** is used to zoom in on/out from the active document:

- Use the options in the dropdown menu to select a predefined zoom level.
- Clear the number box, then enter a custom zoom level and press Enter to zoom to a custom level.
- Click the plus and minus icons on either side of the zoom slider to move between predefined zoom levels.
- Click and drag the slider to move to a custom zoom level.

## Create New Toolbars

Follow the steps below to create new toolbars:

1. Click the **New** dropdown menu, then click **New Toolbar**:

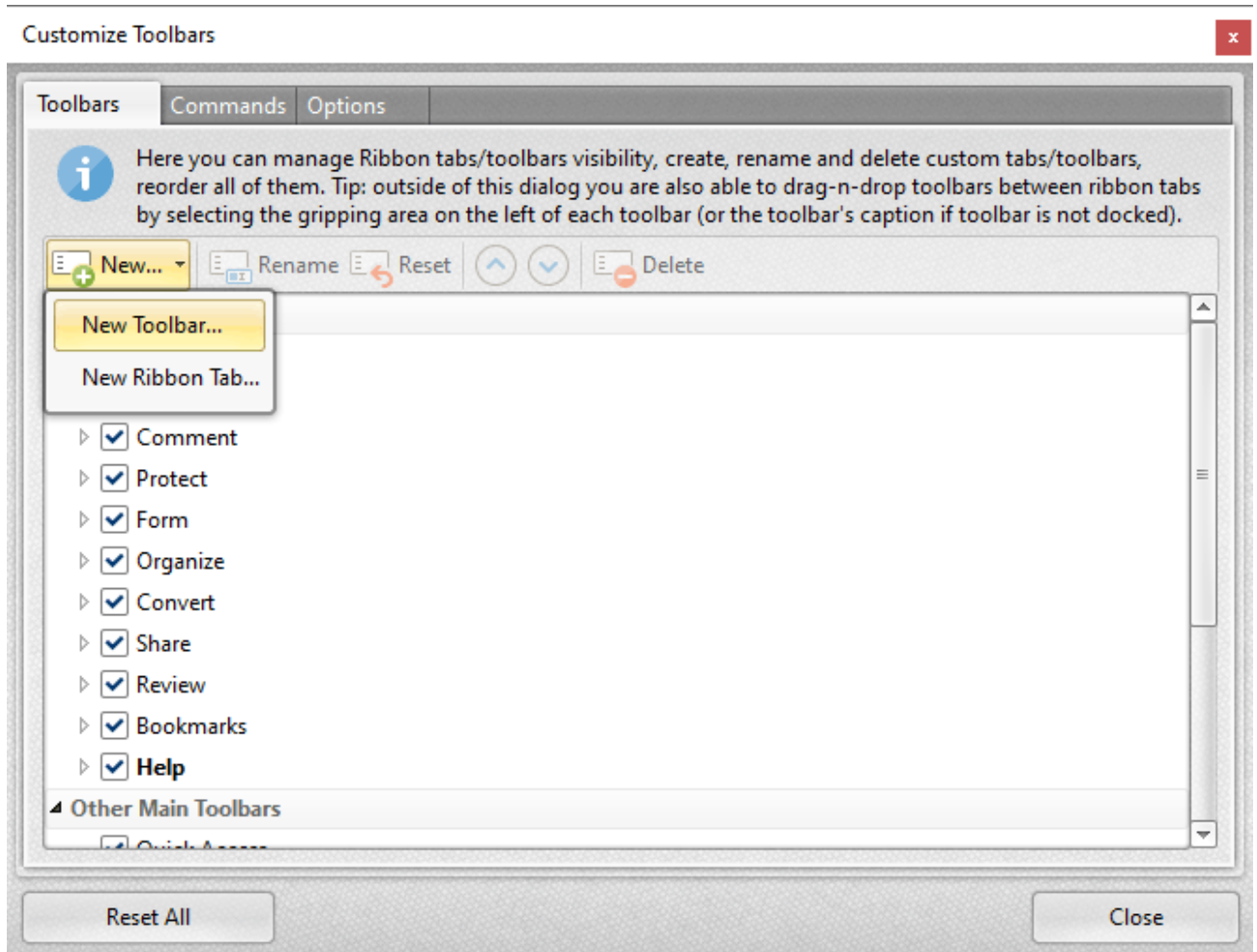

Figure 16. Customize Toolbars Dialog Box, New Toolbar

The **New Toolbar** dialog box will open.

2. Enter the title for the new toolbar, then click **OK**.

A new empty toolbar will then display in the upper-left section of the main window in the user interface.

3. Click the **Commands** tab in the **Customize Toolbars** dialog box, then click and drag the desired commands from the commands pane into the new toolbar:

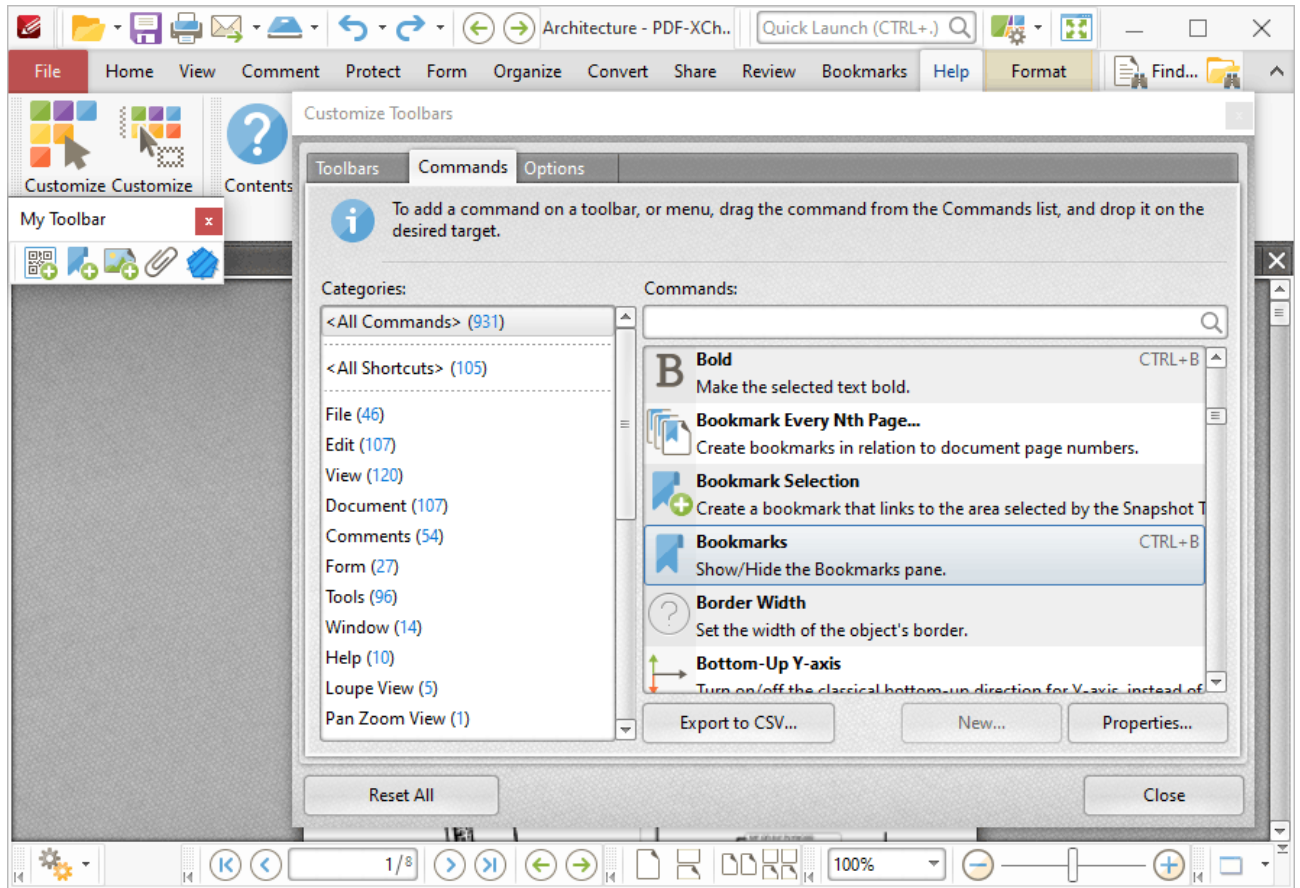

Figure 17. Customize Toolbars Dialog Box, Commands Tab. New Toolbar in Main Window

4. When all desired commands have been added to the new toolbar, click and drag it to the desired location in the user interface. New toolbars can be docked between ribbon groups or at the bottom of the user interface. The pointer will indicate that new toolbars can be docked when they are hovered over compatible areas of the user interface:

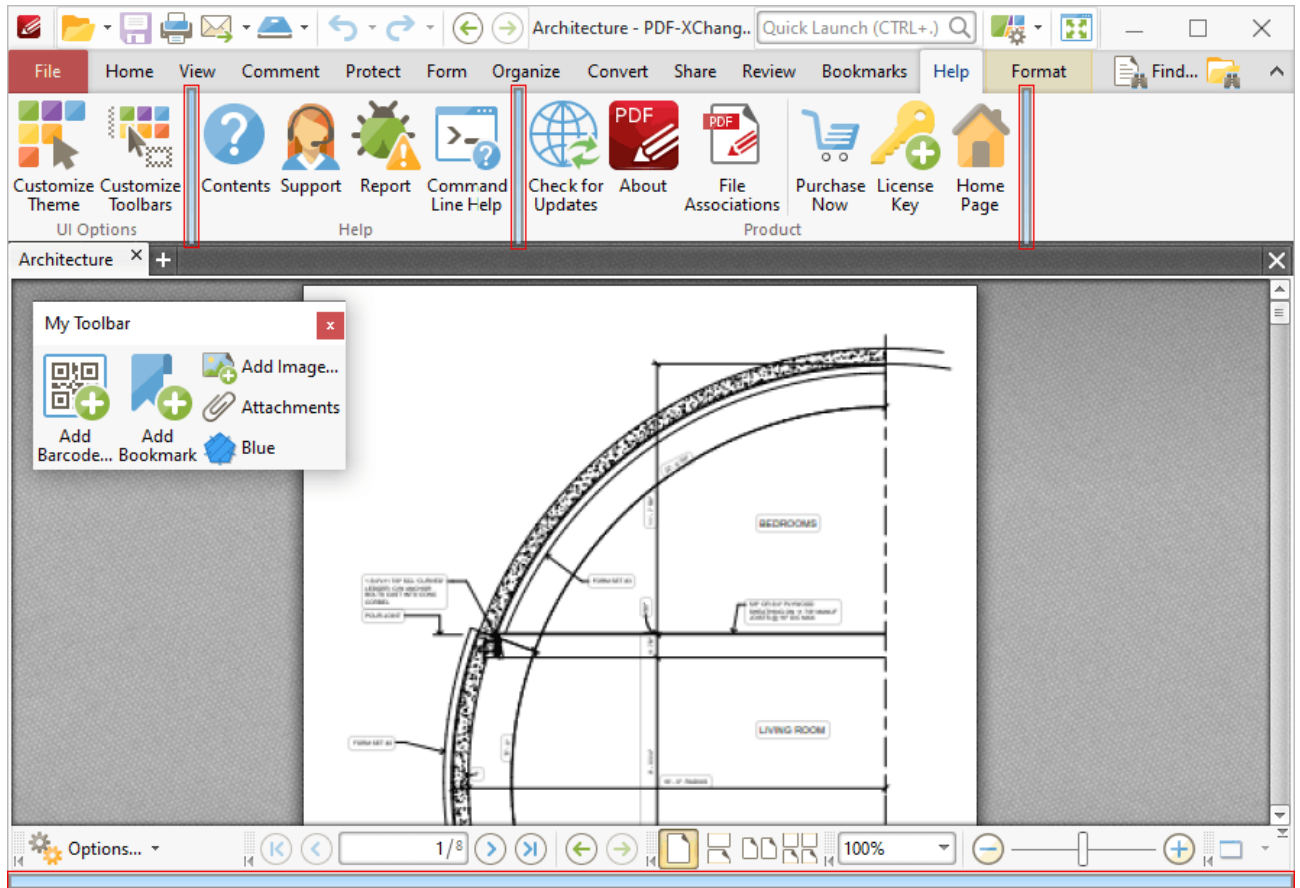

Figure 18. Example Toolbar Docking Points Highlighted

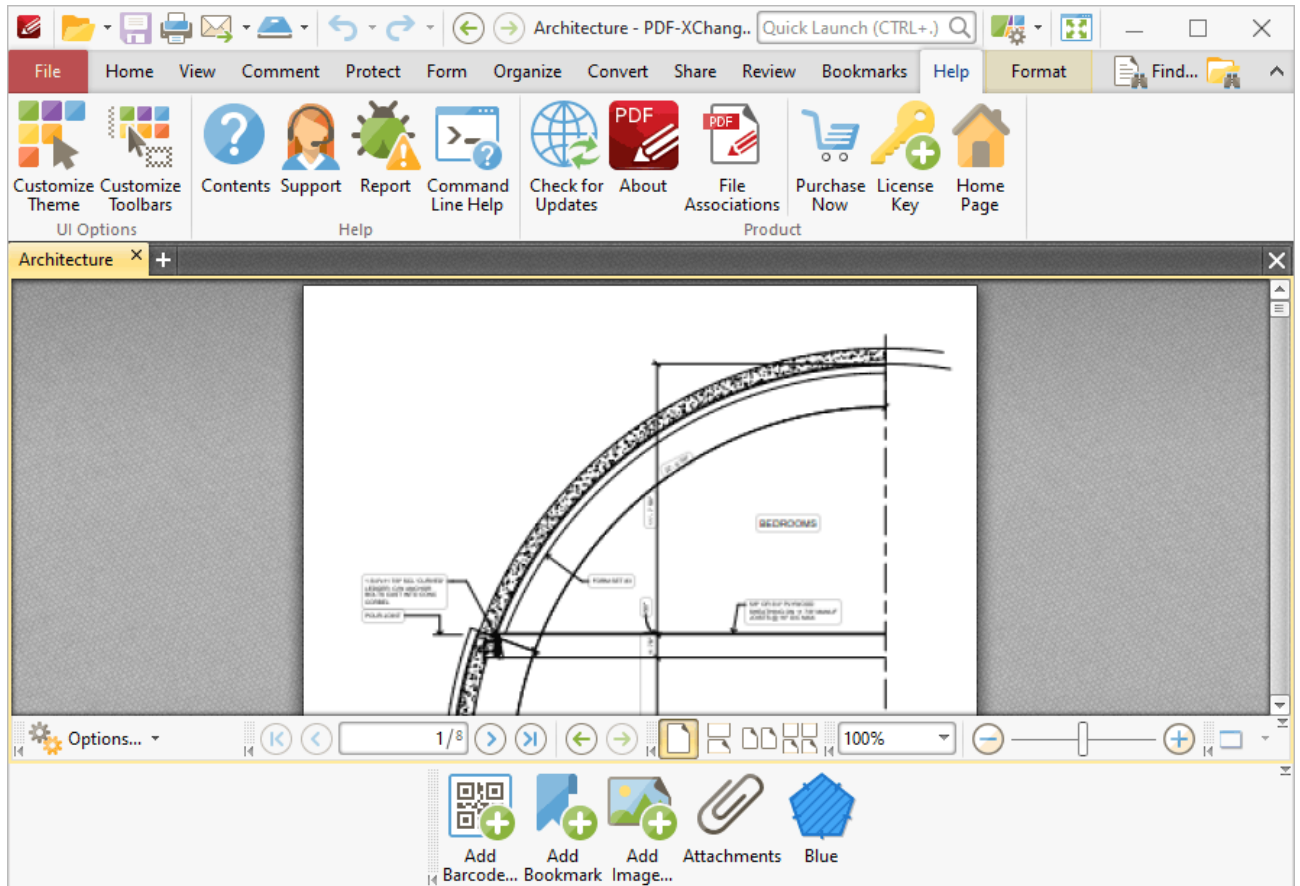

Figure 19. New Toolbar Docked

## Create New Ribbon Tabs

Follow the steps below to create a new ribbon tab:

1. Click the **New** dropdown menu, then click **New Ribbon Tab**:



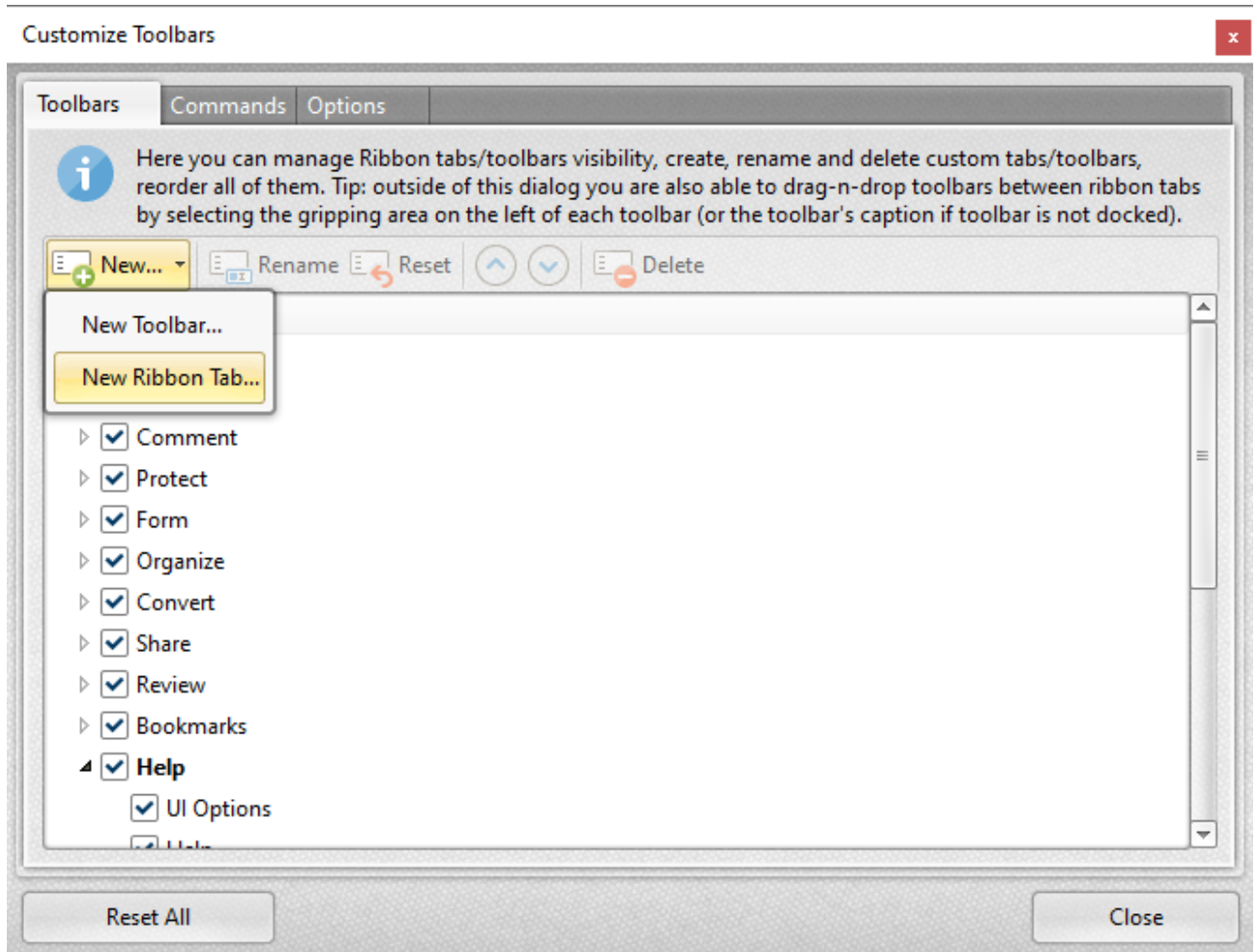

Figure 20. Customize Toolbars Dialog Box, New Ribbon Tab

The **New Ribbon Tab** dialog box will open.

2. Enter a name for the new ribbon tab, then click **OK**.

The new ribbon will be displayed in the user interface:

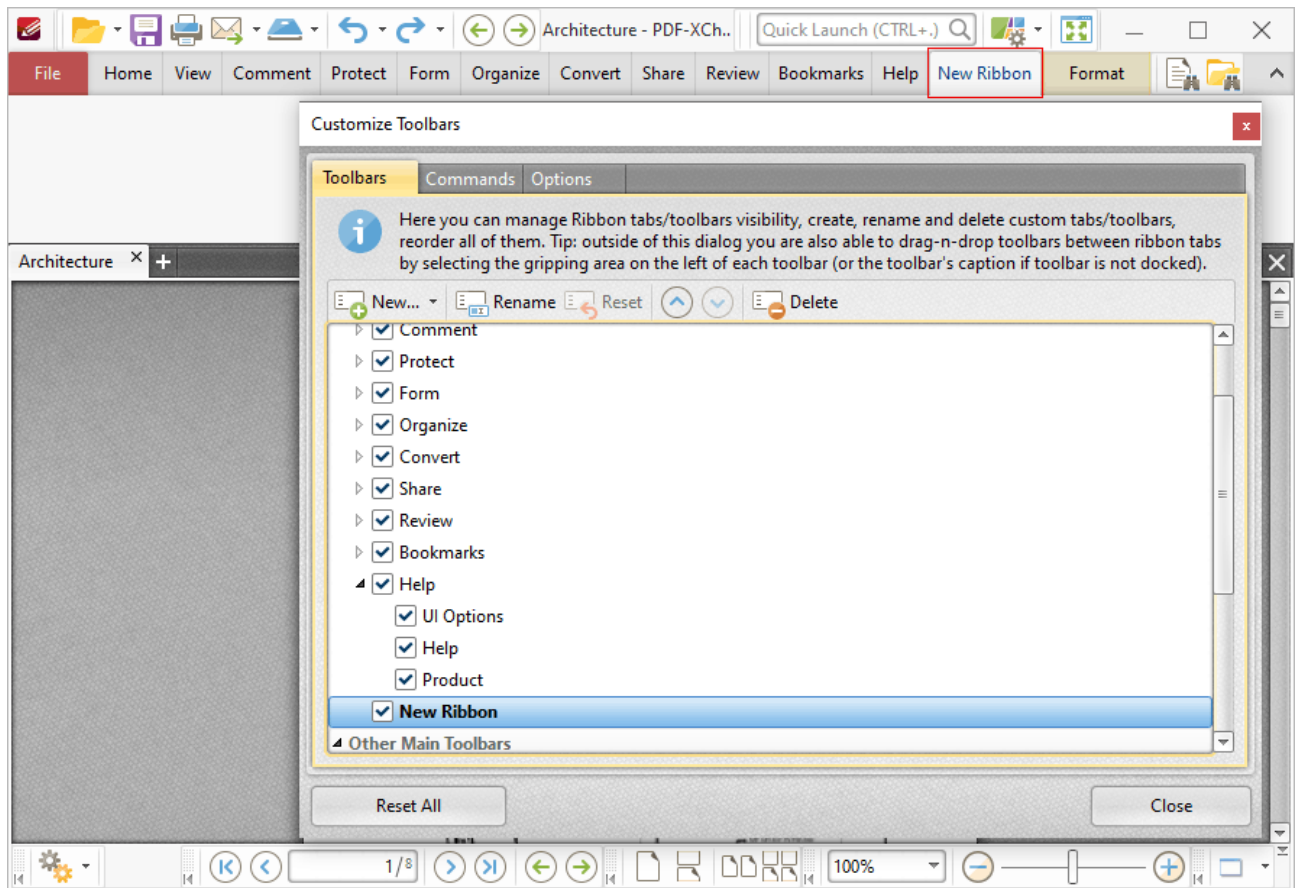

Figure 21. New Ribbon Created

3. Click the new ribbon, then click and drag commands from the **Commands** tab of the **Customize Toolbars** dialog box to add them to the ribbon:

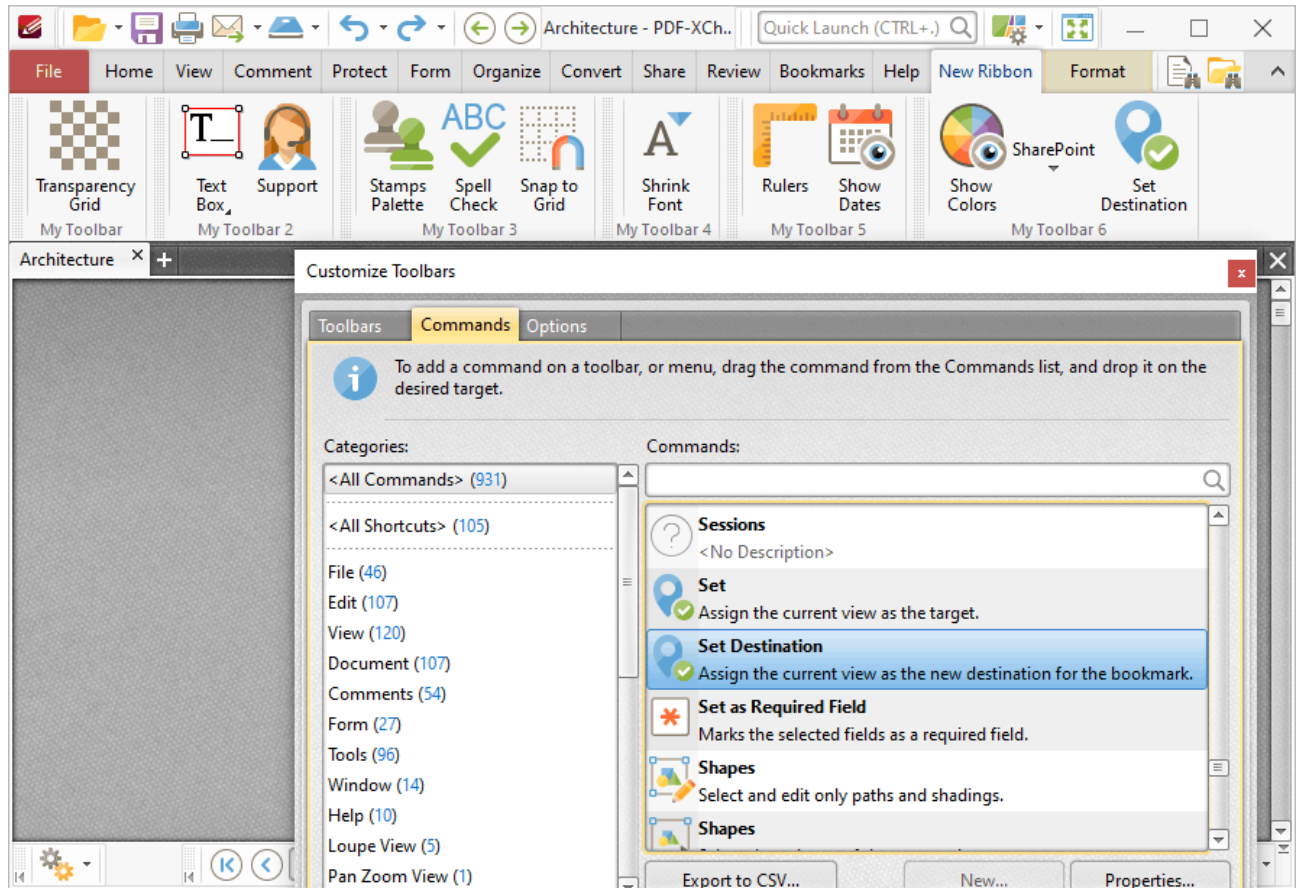

Figure 22. Commands Added to New Ribbon

Click and drag commands to reposition them in the ribbon, or to add multiple commands to the same ribbon group. Customized ribbon tabs can be edited in the same manner as default ribbon tabs, which is detailed above.

### Commands Tab

All the available commands in **PDF-XChange Editor** are contained in the **Commands** tab of the **Customize Toolbars** dialog box:

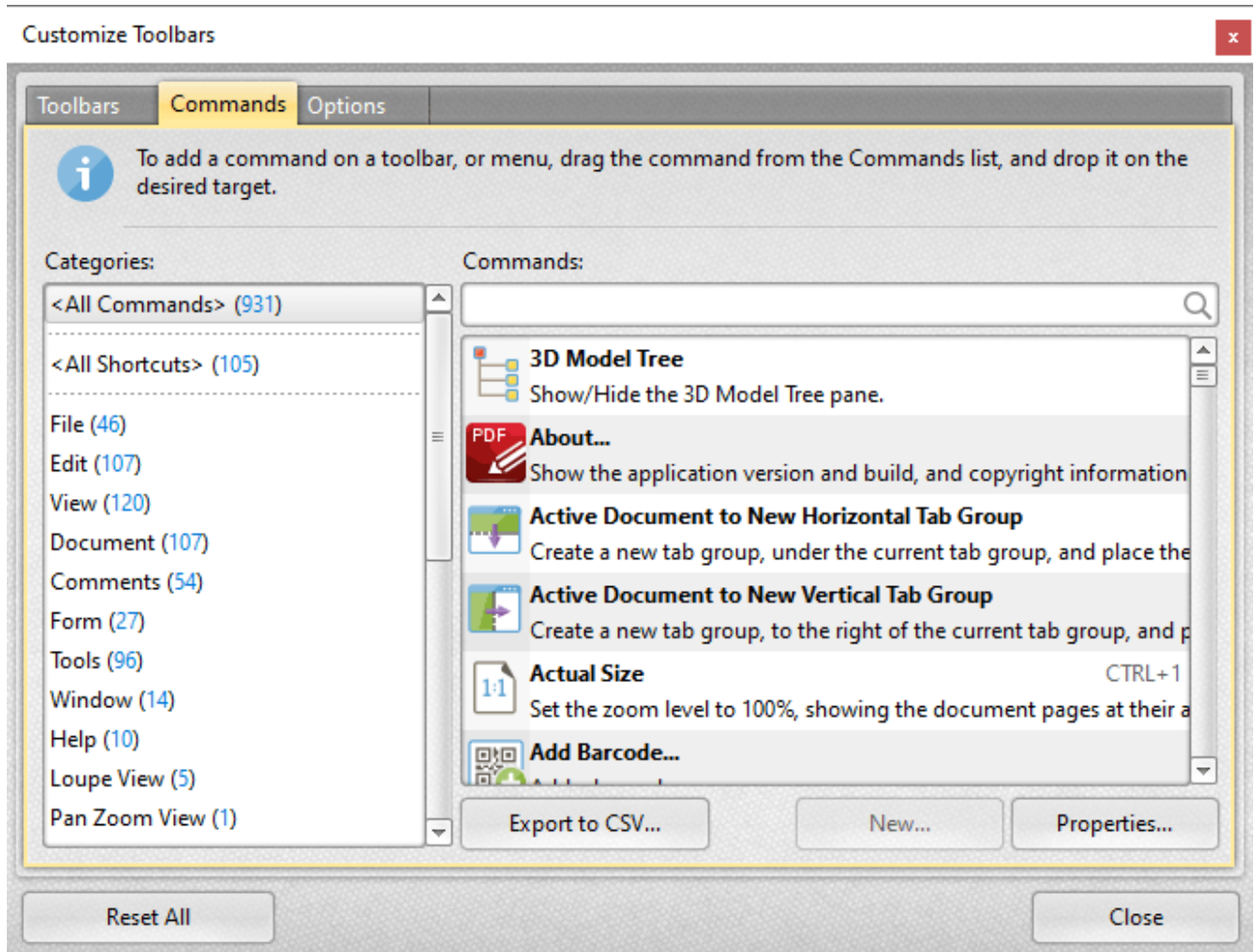
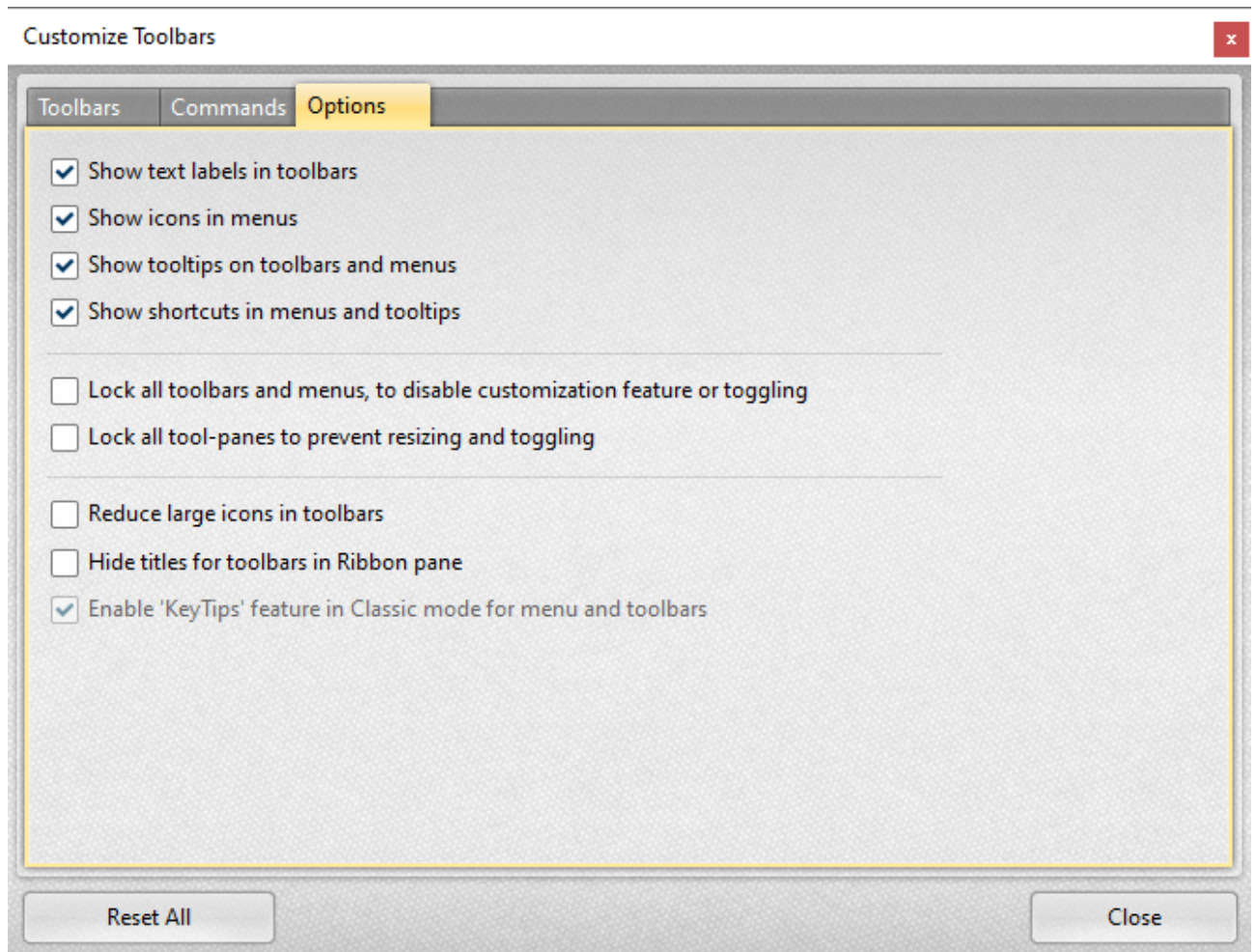

Figure 23. Customize Toolbars Dialog Box, Commands Tab

- Use the **Categories** menu to determine the group of commands displayed in the viewing pane.
- Use the **Commands** text box to search for commands.
- Click and drag commands to the desired toolbar/submenu in the main window of **PDF-XChange Editor**.
- Click **Properties** to view/edit the properties/tooltip/keyboard shortcuts and other variables for selected commands.
- Click **Export to CSV** to export a list of all available commands to a comma-separated-values file.
- Please note that [customized comment styles](#)<sup>1242</sup> are available in the **Custom Comment Styles** category.

## Options Tab

Click the **Options** tab to enable/disable toolbar options:



**Figure 24.** Customize Toolbar Options

10.4.12.2 Report a Problem



**Report a Problem**

Click **Report** to report bugs and other issues with **PDF-XChange Editor** to **PDF-XChange**:

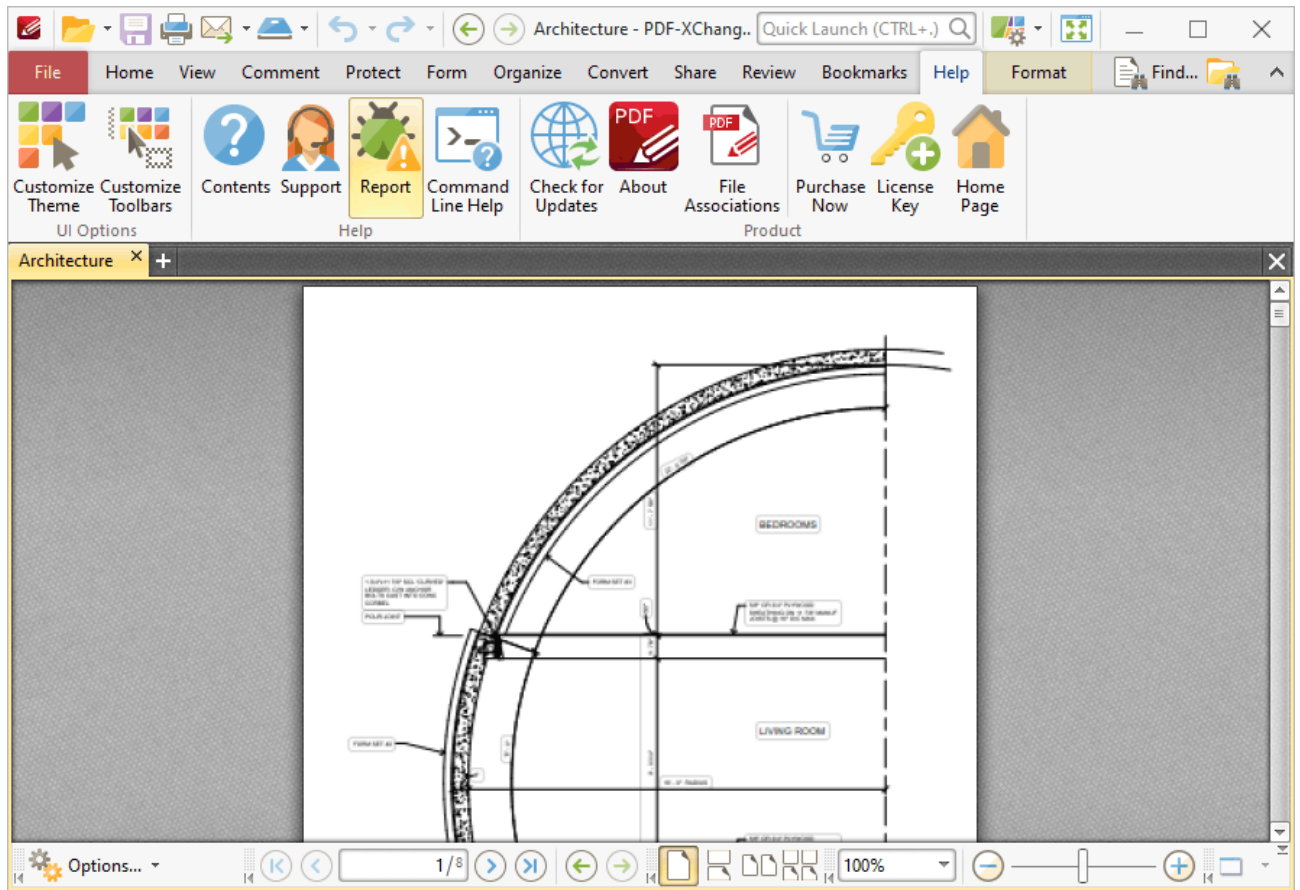

Figure 1. Help Tab, Report

The **Report a Problem** dialog box will open:

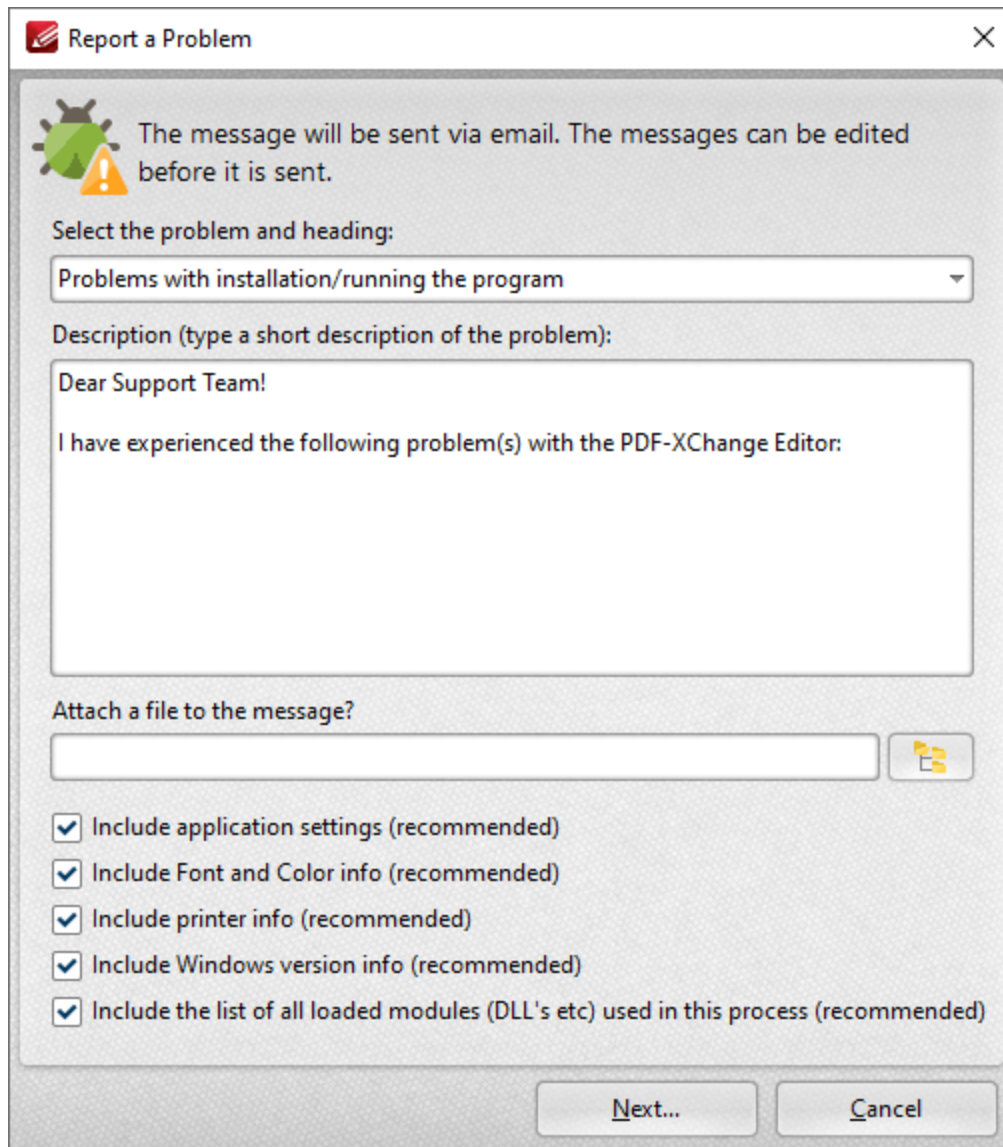

Figure 2. Report a Problem Dialog Box

- Use the dropdown menu to select the category that best describes the issue being experienced.
- Enter a short description of the issue in the **Description** text box.
- Use the **Attach a file** text box to add files to the bug report, such as screenshots. Click the icon to select files manually.
- Select the check boxes to determine additional information included in the report.

Click **Next** to launch the default mail client and send the report.

---

### 10.4.13 Format Tab



## Format Tab

The **Format** tab is used to edit content and comment and form field styles in **PDF-XChange Editor**:

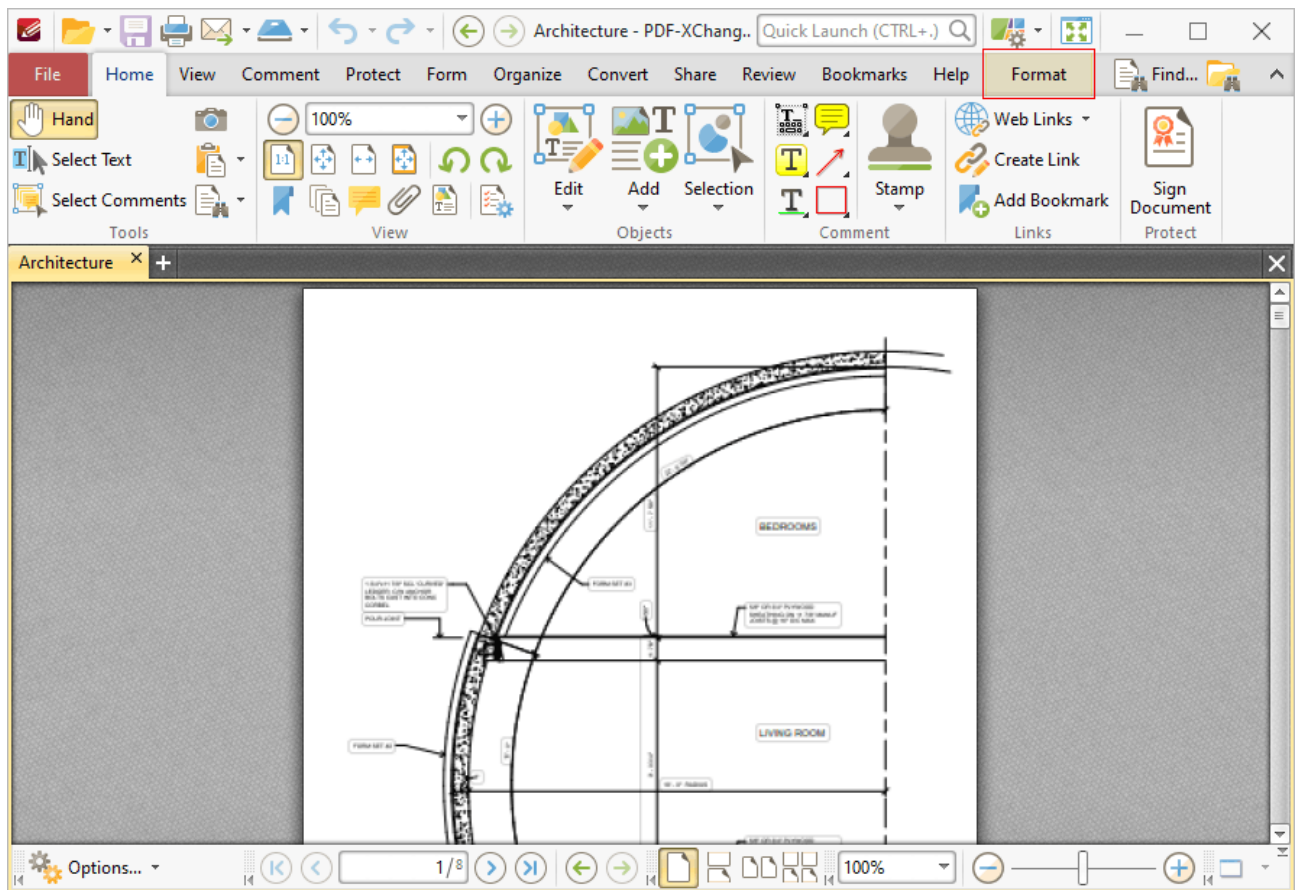



Figure 1. Format Tab

The options available in the **Format** tab depend on the format of selected content in documents:

- The options available when editing page content are detailed [here](#).<sup>1638</sup>
- The options available when editing comments are detailed in the [Comment](#)<sup>1082</sup> section of the manual.



- The options available when editing form fields are detailed in the [Form](#)  section of the manual.
-

## 10.4.14 Arrange Tab

**Arrange Tab**

The **Arrange** tab is used to arrange selected content in **PDF-XChange Editor**. It is enabled when comments, form fields or content items are selected:

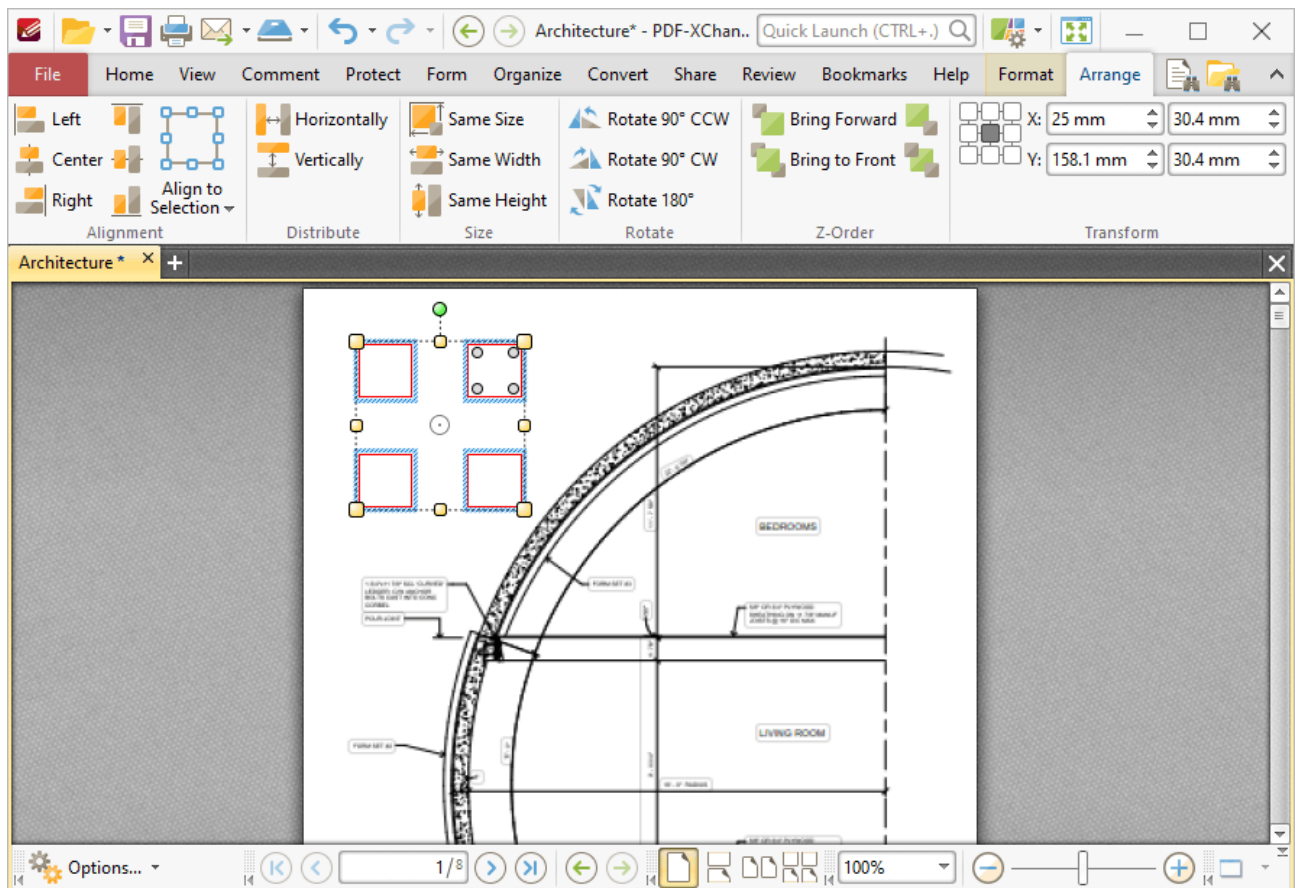
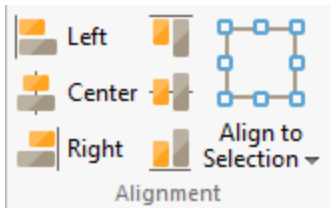

Figure 1. Arrange Tab

Please note that some of the options in the **Arrange** tab are only available when multiple items are selected. There are five groups in the **Arrange** tab and the commands in each group can be used to edit selected content items in different ways:

## Alignment

The options in the **Alignment** tab are used to align selected content items. Note that the first content item to be added to documents is used as the point from which all other content items are aligned:



- Click **Left**, **Center**, **Right**, **Top**, **Middle** or **Bottom** to align all content items to these locations as desired.
- Click the **Align to Selection** dropdown menu to specify the to alignment of selected items to **Selection Bounds**, **Key Object** or **Page** as desired.

## Distribute

The options in the **Distribute** tab are used to distribute content items. Note that the first content item to be added to documents is used as the point from which all other content items are distributed:

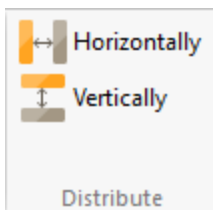

Click **Horizontally/Vertically** to distribute selected content items horizontally/vertically

## Size

The options in the **Size** group are used to resize selected content items. Note that the first content item to be added to documents is used as the point from which all other content items are resized:

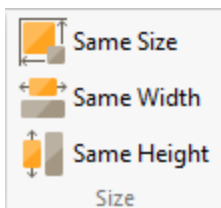

Click **Same Size/Width/Height** to make all content items the same size/width/height

## Rotate

The options in the **Rotate** group are used to rotate selected content items:

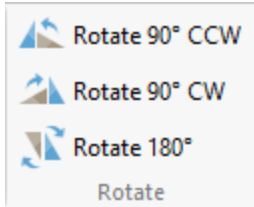

Click **Rotate 90° CCW**, **Rotate 90° CW** or **Rotate 180°** as desired. Please note that these commands are not available for form fields.

## Z-Order

The options in the **Z-Order** group determine the [Z-Order](#) of selected content items:

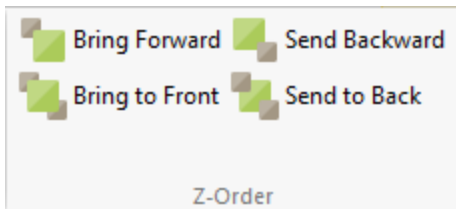

- Click **Bring Forward** to bring the selected item up a step in cases where multiple items overlap.
- Click **Send Backward** to send the selected item back a step in cases where multiple items overlap.
- Click **Bring to Front** to bring the selected item to the top in cases where multiple items overlap.
- Click **Send to Back** to send the selected item to the back in cases where multiple items overlap.

## Transform

The options in the **Transform** group are used to view/adjust the size and page location of selected content:

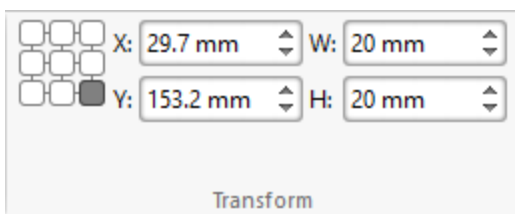

- Click the boxes in the grid to view the current location of the corresponding points of the selected content.
  - Use the **X** and **Y** number boxes to determine the new positioning of the selected content. The **X** value is the horizontal plane and the **Y** value is the vertical plane.
  - Use the **Width** and **Height** boxes to adjust the size of the selected content.
-

10.4.15 Portfolio Tab



**Portfolio**

PDF portfolio files are a unique format of PDF file in which multiple files are assembled into an integrated PDF unit. The **Portfolio** settings detailed below are for PDF portfolio files and are only available when these files are open in **PDF-XChange Editor**:

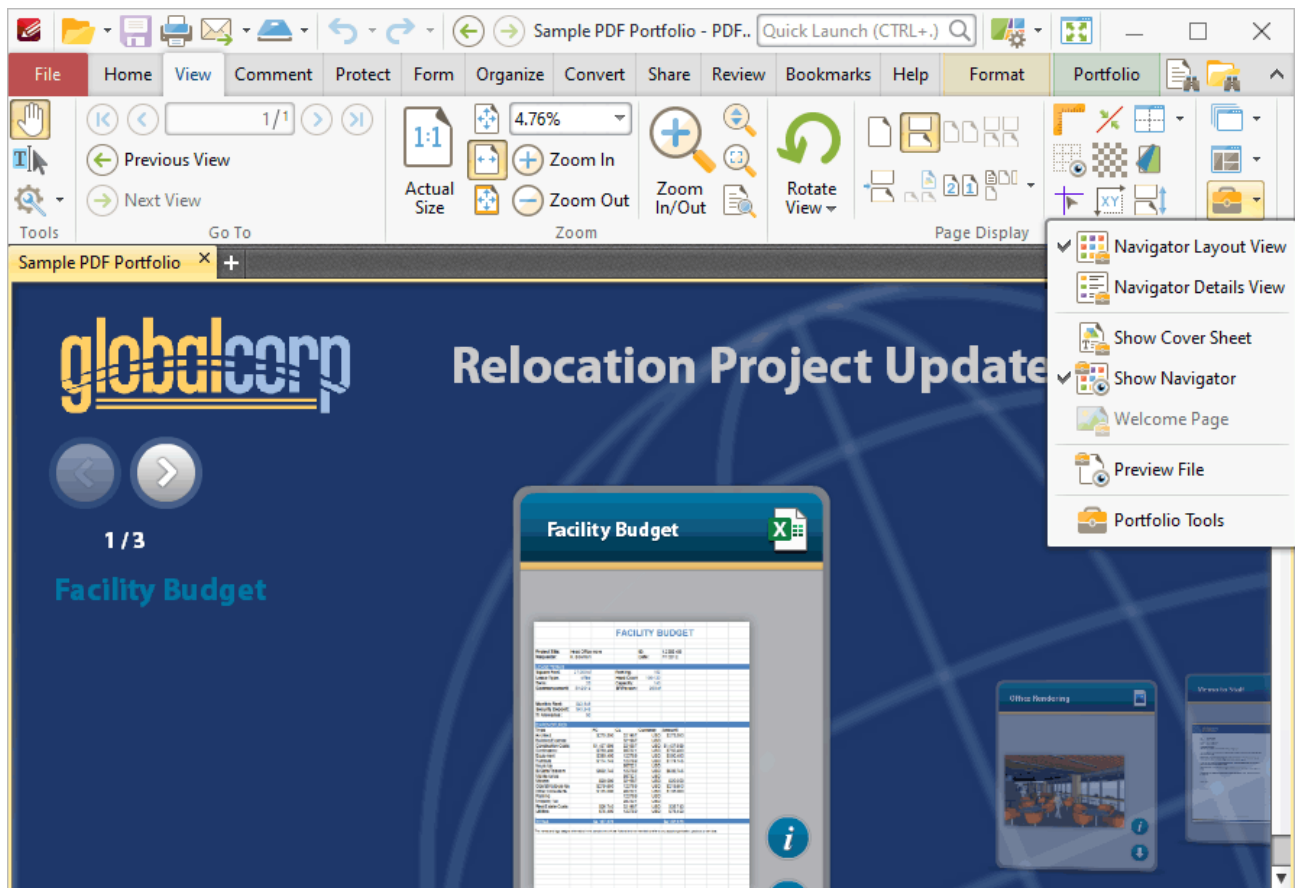

Figure 1. Portfolio Submenu

- Click **Navigator Layout View** to display the content of portfolio files in their expanded format, or **Navigator Details View** to display the content of portfolio files in list format.
- Click **Show Cover Sheet** to show/hide the portfolio cover sheet.

- Click **Show Navigator** to show/hide the navigator window, which is used to browse through the contents of portfolio files.
- The **Welcome Page** option is not yet available, but will be available in later builds of **PDF-XChange Editor**.
- Click **Preview File** to open the selected content of the portfolio file in its default application.
- Click **Portfolio Tools**, or click the **Portfolio tab**, to move to the **Portfolio** tab:

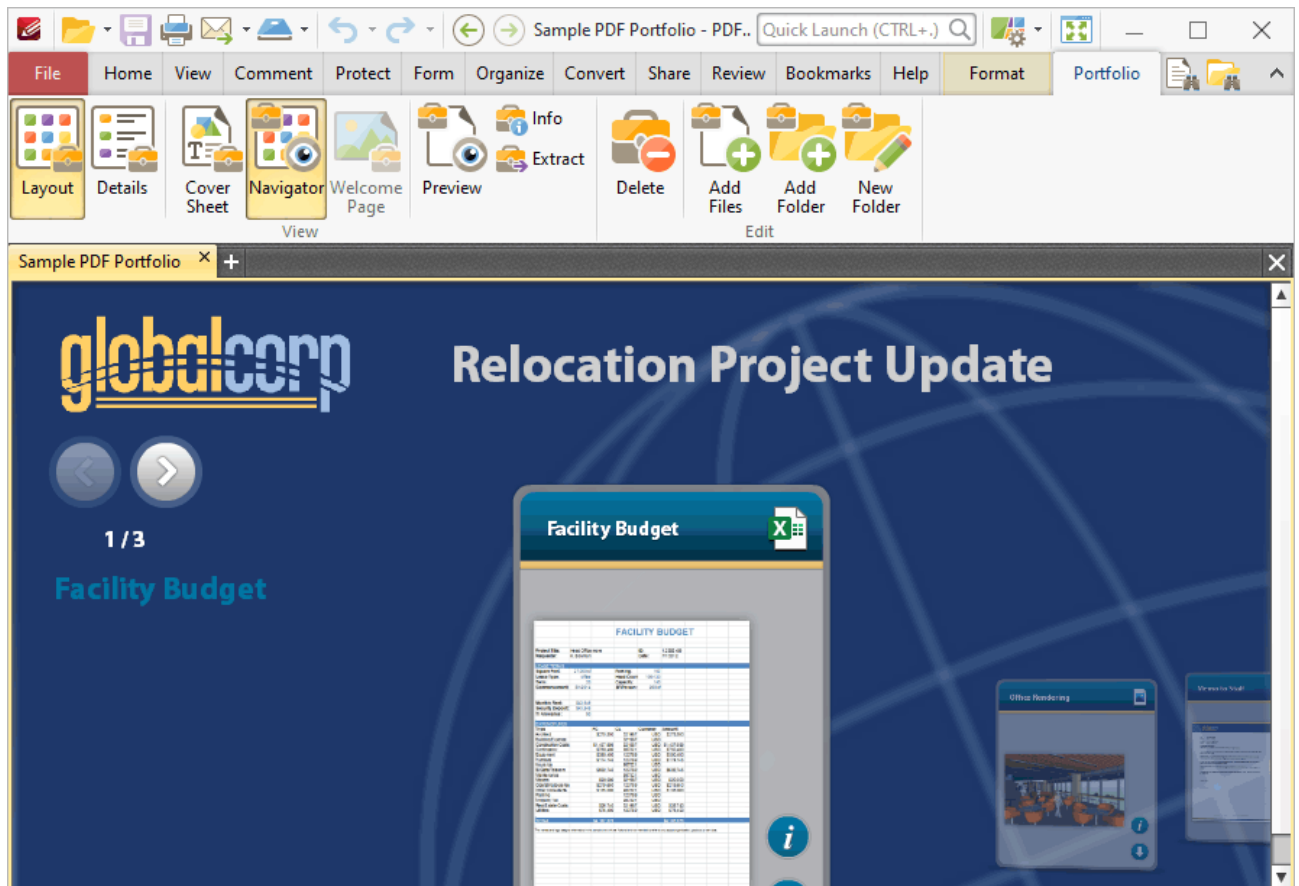

Figure 2. Portfolio Tab

- Click **Layout/Details** to switch between layout view and details view for the files that the PDF portfolio file contains, as detailed above
- Click **Cover Sheet** and/or **Navigator** to display the cover sheet and/or navigator, which is used to browse the files that the PDF portfolio file contains.
- Click **Preview** to open the section of the portfolio file currently displayed in the main window in its default application.
- Click **Info** to view the file properties of the section of the portfolio file currently displayed in the main window.
- Click **Extract** to extract the section of the portfolio file currently displayed in the main window.
- Click **Delete** to delete the section of the portfolio file currently displayed in the main window.
- Click **Add Files/Folder** to add files/folders to the portfolio file.
- Click **New Folder** to add a new folder to the portfolio file.

Right click the main window for additional options:

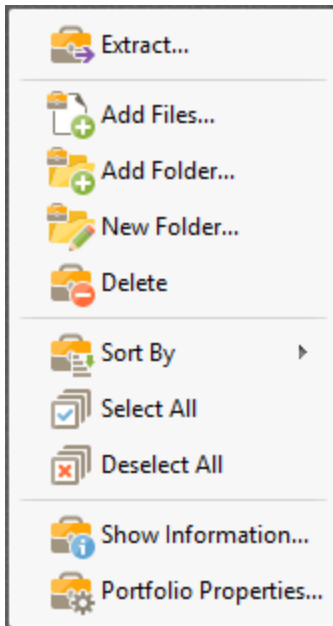

Figure 2. Portfolio File Right-Click Submenu

- Click **Sort by** to determine the criteria used to sort the content of portfolio files.
- Click **Select All/Deselect All** to select/deselect all files in portfolio files.
- Click **Show Information** to view the file properties of of portfolio files.
- Click **Portfolio Properties** to view/edit file properties for portfolio files.

You can create PDF portfolio files in **PDF-XChange Editor** via the **New Document** option detailed [here](#).<sup>803</sup>

---



## 10.5 Appendix

---



### Appendix

---

This section details additional information about settings and functions in **PDF-XChange Editor**:

- [Accessibility Check](#)<sup>1635</sup> - a breakdown of the rules that constitute the accessibility check that **PDF-XChange Editor** performs to ensure documents are accessible.
- [Add/Edit Content](#)<sup>1638</sup> - a breakdown of the ways in which it is possible to add/edit content in **PDF-XChange Editor**.
- [Blend Mode](#)<sup>1659</sup> - information about the blend mode feature and how it operates.
- [Changing the Layout of Panes](#)<sup>1662</sup> - an explanation of how to edit the panes in **PDF-XChange Editor**.
- [Command Line Options](#)<sup>1689</sup> - a list of the available command line options, which includes definitions and sample command lines.
- [Document Tab Options](#)<sup>1680</sup> - an explanation of the options in the right-click document tab shortcut menu.
- [Editing Document Pages](#)<sup>1682</sup> - a breakdown of the methods through which **PDF-XChange Editor** can be used to edit document pages.
- [Editing Text in Annotations](#)<sup>1683</sup> - an explanation of the options available for editing annotation text in **PDF-XChange Editor**.
- [Features Added in Version 8](#)<sup>1686</sup> - details all features added in version 8 of **PDF-XChange Editor**.
- [Find](#)<sup>1688</sup> - an explanation of the **Find** feature, which is used to find specified text in documents.
- [Keyboard Shortcuts](#)<sup>1681</sup> - a comprehensive list of keyboard shortcuts, and instructions on how to view/edit them in the software.
- [Macros](#)<sup>1707</sup> - an explanation of macros and macro-enabled operations.
- [Page Boxes](#)<sup>1770</sup> - an explanation about the use of page boxes in PDF documents and **PDF-XChange Editor**.
- [Page Range Settings](#)<sup>1773</sup> - a guide to the correct format for the specification of page ranges.
- [Read Out Loud Feature](#)<sup>1774</sup> - an explanation of this feature.
- [Search](#)<sup>1776</sup> - a profile of the **Search** feature, which is used to search documents open in **PDF-XChange Editor** or folders on the local computer:

- [Shell Extensions](#)<sup>1781</sup> - an explanation of the shell extensions and **ifilter** search tool.
  - [Tool Content Options](#)<sup>1783</sup> - an explanation of editing options for content created with the **PDF-XChange Editor** tools.
  - [Tool Properties](#)<sup>1788</sup> - a table that defines all available properties for the **PDF-XChange Editor** tools.
-

### 10.5.1 Accessibility Check

---



## Accessibility Check

---

The **Accessibility Check** feature in **PDF-XChange Editor** enables you to verify whether documents conform to international accessibility standards. Conformance with these standards ensures accessibility for people with disabilities who use technology such as screen readers, screen magnifiers and other equipment to navigate and read electronic content. The **Accessibility Check** contains thirty-two rules that are used to determine the accessibility of documents. They concern specific elements of documents and are therefore grouped into the following categories:

### Document

- **Accessibility Permission Flag** reports the need to enable the security settings that permit accessibility. This is because some documents contain permission settings that prevent them from being copied, edited, printed, extracted and/or annotated. These settings may interfere with a screen reader's ability to read the document, because screen readers must be able to copy or extract document text in order to read it to the user. The **Accessibility Permission Flag** reports whether or not it is necessary to turn on the security settings that allow accessibility for the screen reader.
- **Image-Only PDF** reports that documents contains only inaccessible, non-text content such as images. (Note that some images may be of text - in those cases, if the document does not contain fonts, then the text will not be recognized).
- **Tagged PDF** reports whether documents contain tags that specify the order in which document content should be read.
- **Logical Reading Order** must be checked manually and is included to ensure that the reading order in the **Tagged** panel follows the logical reading order of the document.
- **Document Language** reports whether the primary text language of documents is specified, and allows some screen readers to switch to the specified language.
- **Title** reports the title of documents as detailed in their document properties.
- **Bookmarks** reports whether documents that contain twenty-one or more pages also have bookmarks that match the document structure.
- **Color Contrast** reports whether documents are sufficiently accessible for colorblind users.

### Page Content

- **Tagged Content** reports the status of document content, which must be either tagged or marked as an artifact (such as graphics or decorative images) in order to conform to accessibility standards.
- **Tagged Annotations** reports the status of annotations in documents. Annotations must be either tagged or marked as artifacts to satisfy this rule.
- **Tab Order** reports whether the tab order of documents matches the document structure.
- **Character Encoding** reports whether documents contain the encoding required to display the fonts that they contain.
- **Tagged Multimedia** reports the status of document multimedia objects, which must be either tagged or marked as artifacts in order to conform to accessibility standards.
- **Screen Flicker** reports whether documents contain content that causes the screen to flicker. This type of content can be difficult to see when the screen is magnified and can cause seizures in people who have photosensitive epilepsy.
- **Scripts** reports whether documents contain scripts that interfere with keyboard navigation or prevent the use of input devices. Document content and functionality must not be script-dependent unless it is accessible to assisting technology.
- **Timed Responses** reports whether documents contain forms with JavaScript that require a response from users within a specified time frame.
- **Accessible Links** reports whether the URLs in documents are tagged correctly, as well as whether there are several identical links within the same document. URLs must be active and correctly tagged in order to be accessible to screen readers.

## Forms

- **Tagged Form Fields** reports whether all document form fields are tagged.
- **Field Descriptions** reports whether all form fields contain a text description, which is requirement for accessible documents.

## Alternate Text

- **Figures Alternate Text** reports whether document images either have alternate text or are marked as artifacts. All document images must fall into these categories in order to conform to accessibility standards.
- **Nested Alternate Text** reports whether documents contain nested alternate text, which screen readers do not read.
- **Associated with Content** reports whether alternate text is associated with page content. This rule is necessary because in cases where document elements have alternate text but do not contain page content it is not possible to determine the document page with which the alternate text is associated.
- **Hides Annotation** reports whether alternate text hides annotations, because screen readers are unable to read annotations in cases where they are nested under a parent element that has alternate text.

- **Other Elements Alternate Text** reports whether documents contain content (other than figures) that require alternate text, such as 3D models, annotations and multimedia.

## Tables

Please note that the structure of tables is often complex, and therefore it is advised that a manual check is performed in order to ensure that tables conform to accessibility standards.

- **Rows** reports whether each table row is a child of **Table**, **THead**, **TBody**, or **TFoot**.
- **TH and TD** reports whether **TH** and **TD** are children of **TR**.
- **Headers** reports whether tables have headers, as this is necessary for tables to conform to accessibility standards.
- **Regularity** reports whether tables contain the same number of columns in each row, and rows in each column - both of which are necessary in order to conform to accessibility standards.
- **Summary** reports whether tables have a table summary. Table summaries are not required for documents in order to conform to accessibility standards,

## Lists

- **List Items** reports whether each list item is a child of a list. List elements must contain list item elements, and list item elements must contain only label elements and list item body elements, in order to conform to accessibility standards.
- **Lbl and LBody** is identical to **List Items**.

## Headings

- **Appropriate Nesting** reports whether headings are nested correctly.
-

10.5.2 Add/Edit Content



Add/Edit Content

A range of options to add and edit content is available in **PDF-XChange Editor**. These options are available in the **Home** tab:

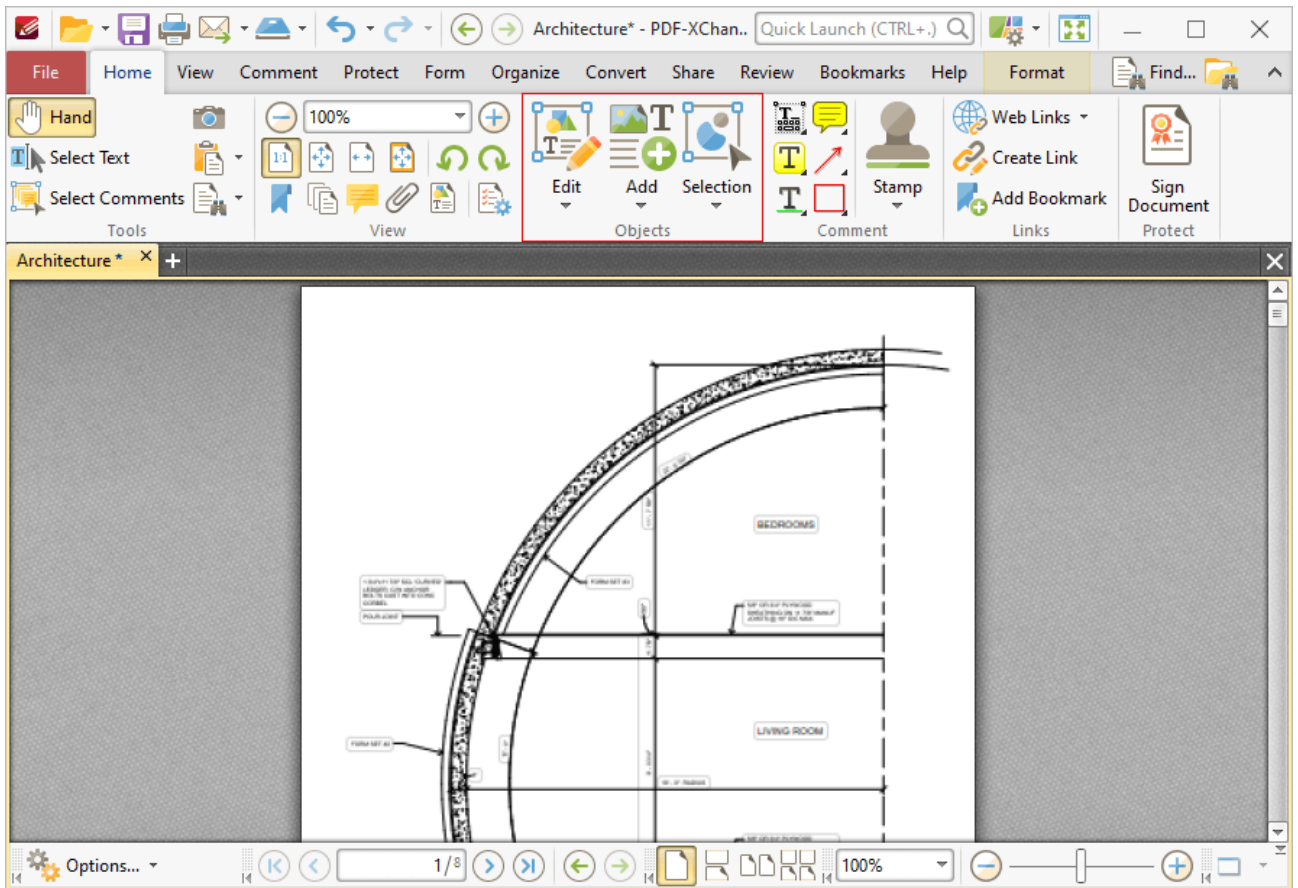

Figure 1. Home Tab, Content Editing Tools

These tools are used to edit the base content of documents and add text, images and barcodes to the base content layer of documents. Please note that the **Content** <sup>1032</sup> pane is a useful feature to use in conjunction with the content editing tools.

▼ Edit Content Tool

Click **Edit Content** to select and edit document content:

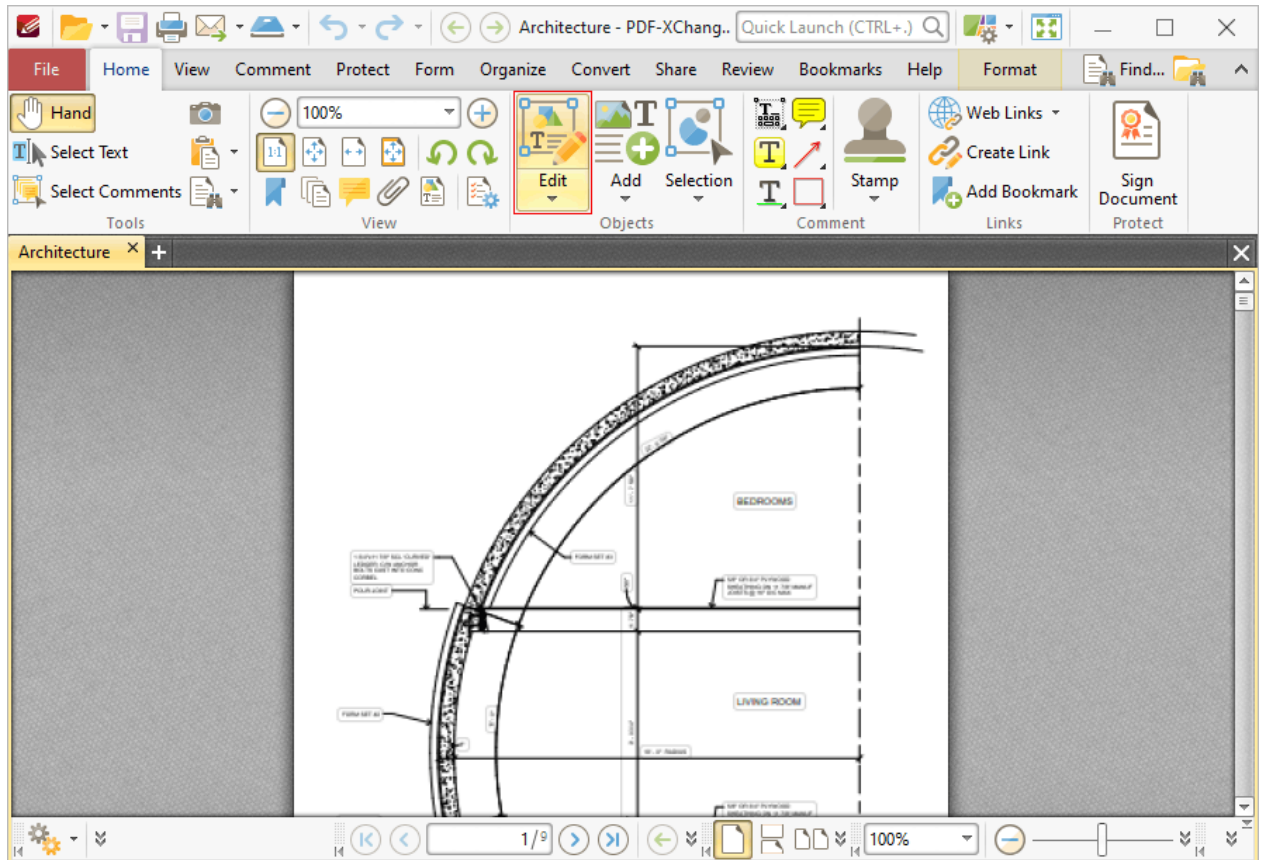

Figure 2. Edit Content Tool

Click the **Edit Content** dropdown menu to view content selection/editing options:

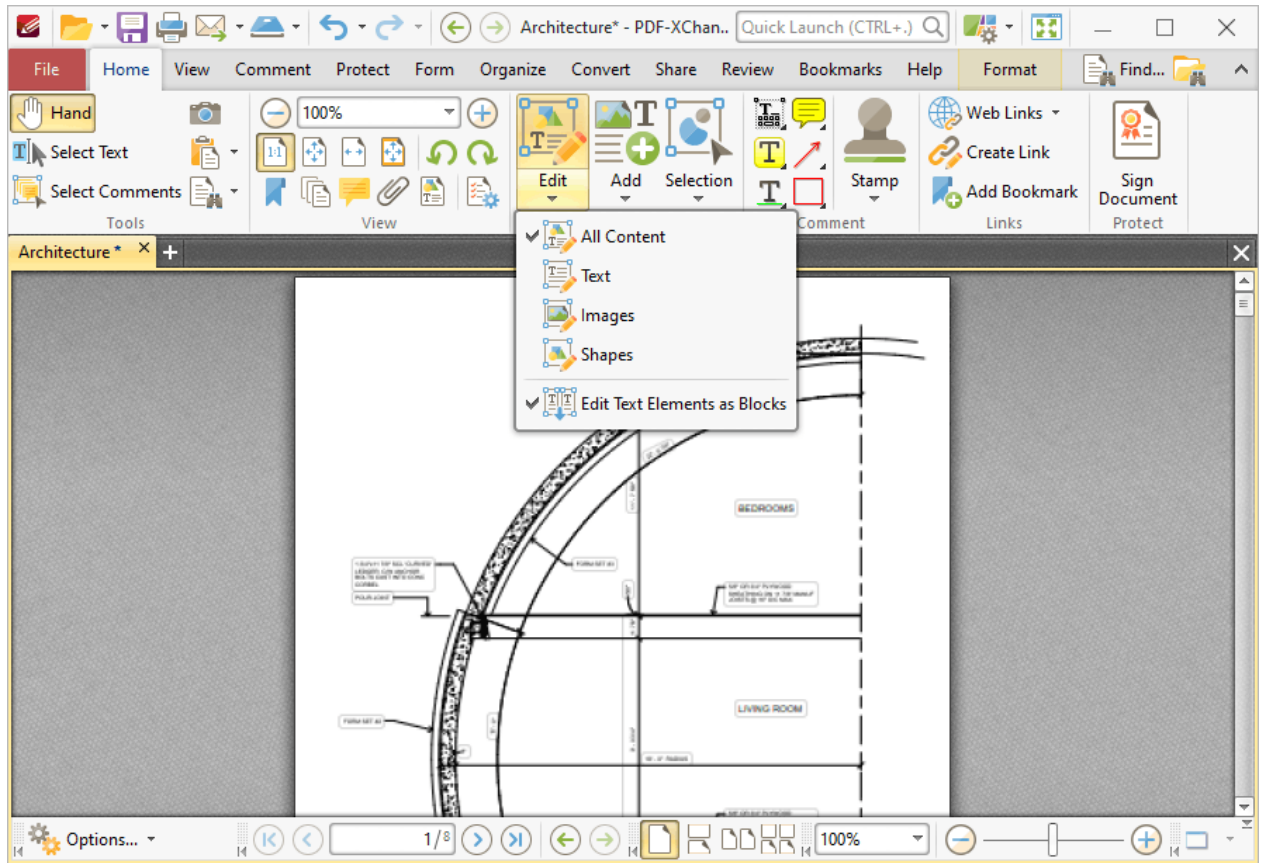

Figure 3. Home Tab, Edit Content Tool, Content Options

- Click **All Content** to select/edit text, images and shapes simultaneously when the **Edit Content** tool is enabled.
- Select **Text** to edit only text when the **Edit Content** tool is enabled.
- Select **Images** to edit only images when the **Edit Content** tool is enabled.
- Select **Shapes** to edit only shapes when the **Edit Content** tool is enabled. Shapes are defined as paths, shading, XForms and all other document base content that is neither text nor imaged-based.
- Enable/disable the **Edit Text Elements as Blocks** option as desired. This feature recognizes blocks of text and enables their group-selection for editing.

When the **Edit Content Tool** is selected, click to select content items, or click and drag to group-select content items. Note that group-selected items are edited simultaneously. Selected content items appear as below:



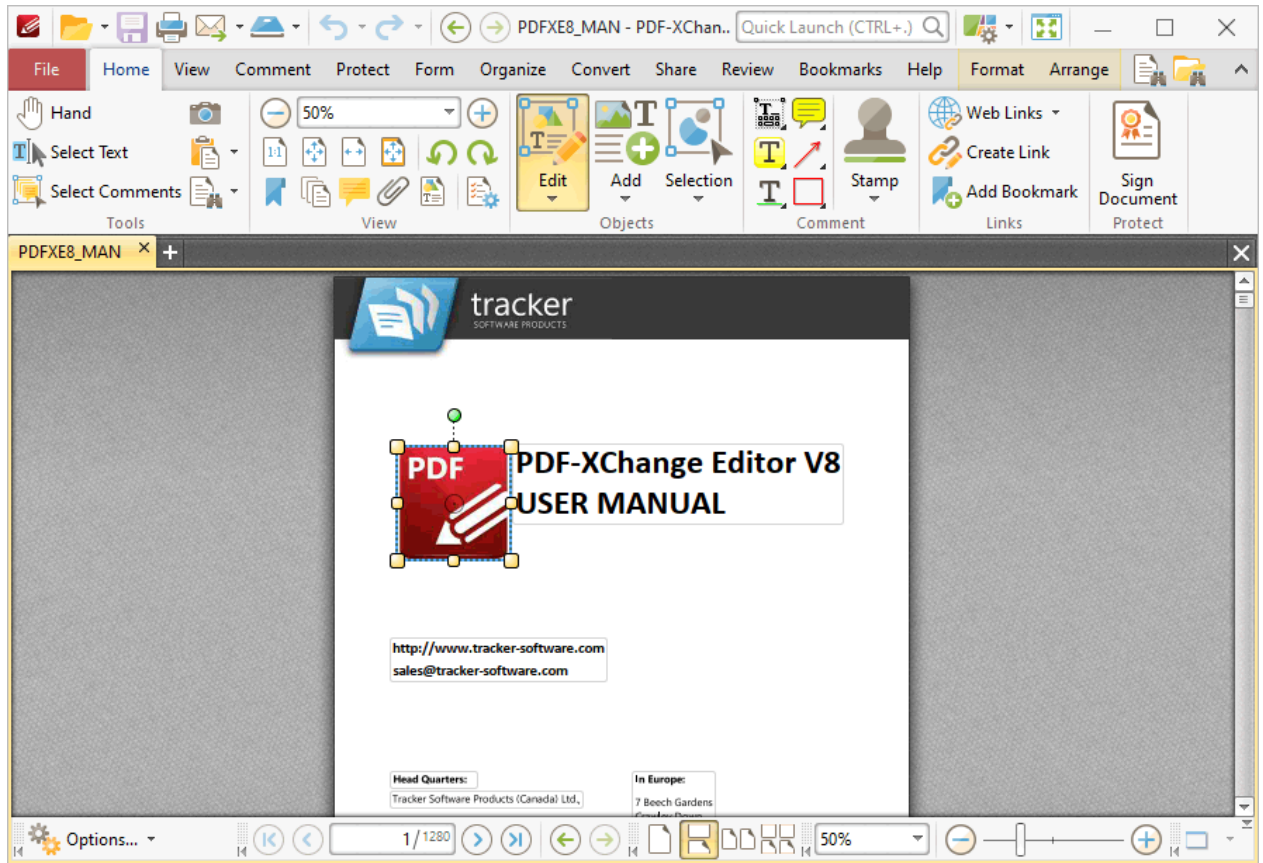

Figure 4. Selected Content Item

- Click and drag the yellow control points to resize content.
- Click and drag the circle at the center to reposition content.
- Click and drag the green control point at the top to rotate content items. Hold down Shift to rotate at increments of fifteen degrees.
- Use the arrow keys to reposition content. Hold down Shift to move at an increased increment.
- Use the editing aids detailed [here](#) to assist in the precise placement of document content.
- Press Ctrl+' to open the **Properties** pane for selected content and view/edit properties. Note that not all properties are editable.
- Click the **Format** tab to format selected content, as detailed below:

## Format Tab for Images

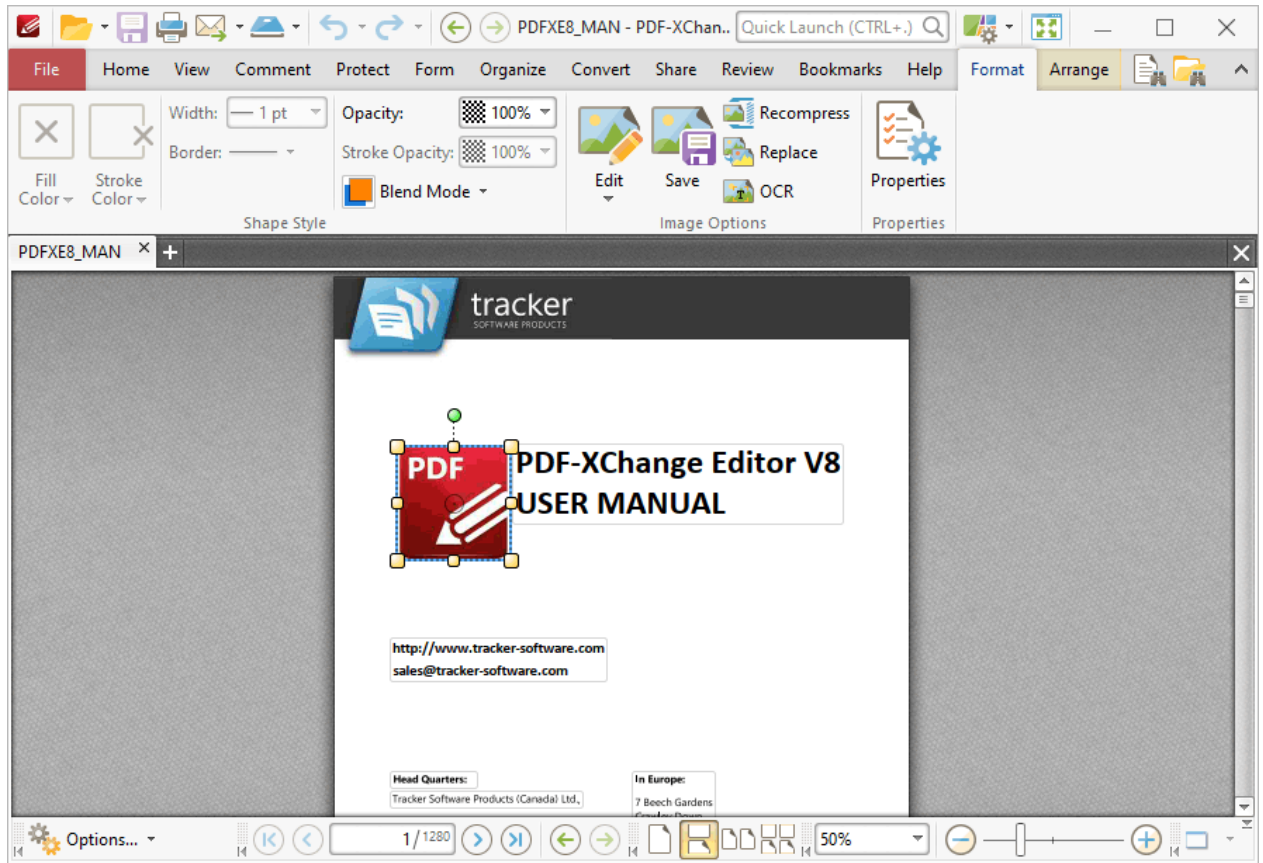

Figure 5. Format Tab for Images

- Use the **Opacity** dropdown menu to determine the transparency of the image.
- Use the **Blend Mode** to determine the blend mode used when content overlaps with other content, as detailed [here](#).
- Click **Edit** to edit the image in either the default application for editing images or an alternative application.
- Click **Save** to save the image to file.
- Click **Recompress** to recompress the image, as detailed below.
- Click **Replace** to replace the image with an alternative image.
- Click **OCR** to perform optical character recognition on the image.
- Click **Properties** to view/edit the properties of the image.

## Format Tab for Text

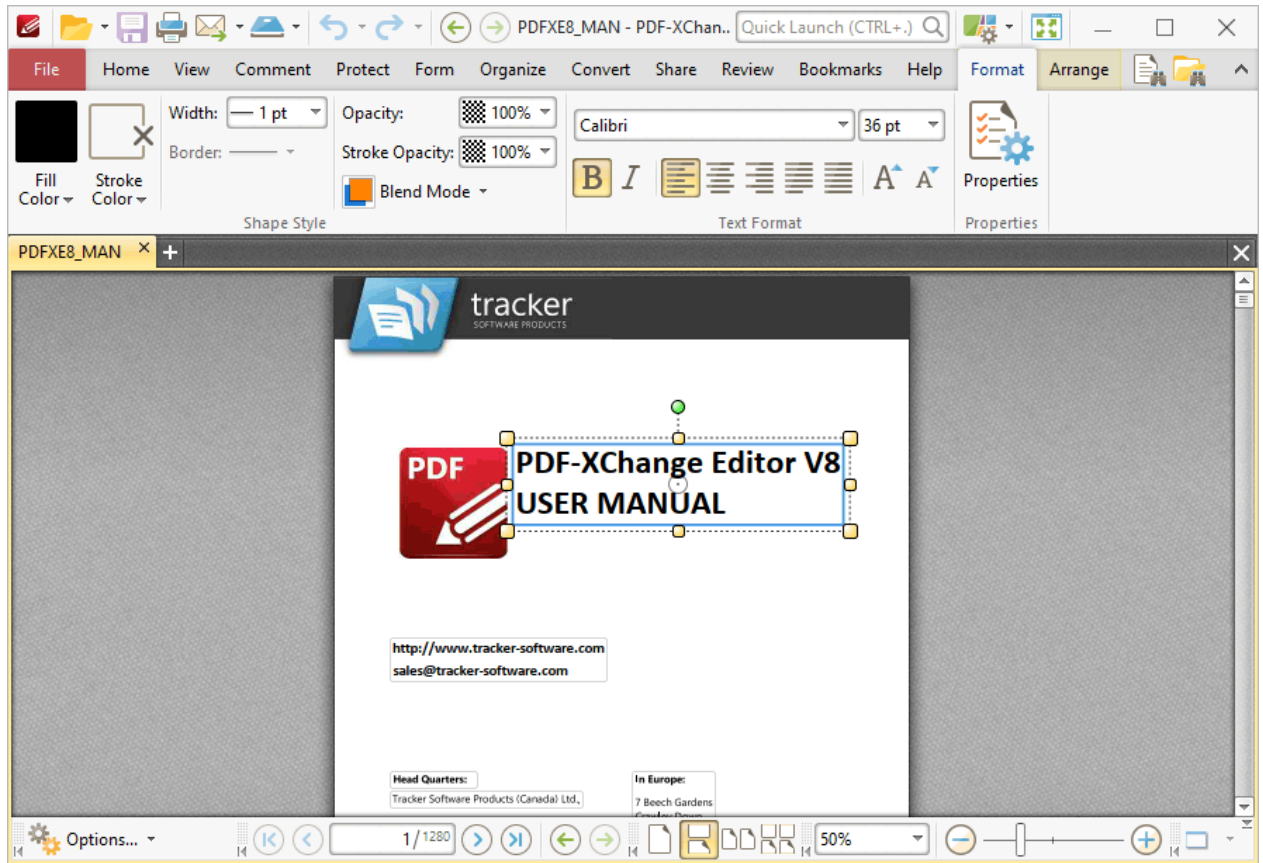

Figure 6. Format Tab for Text

- Use the **Fill Color** dropdown menu to determine the color of the text.
- Use the **Stroke Color** dropdown menu to determine the border color of the text.
- Use the **Width** dropdown menu to determine the width of the **Stroke Color**.
- The **Border** option is not available for text.
- Use the **Opacity** and **Stroke Opacity** dropdown menus to determine the level of transparency of the **Fill Color** and **Stroke Color** respectively.
- Use the **Blend Mode** to determine the blend mode used when text overlaps with other content, as detailed [here](#).<sup>1659</sup>
- Use the **Font** and **Font Size** settings to determine the font used and the size of the font.
- Use the **Bold**, **Italic** and **Alignment** options to enable/disable bold and italic and/or adjust the alignment of text as desired.
- Use the **Grow Font** and **Shrink Font** options to increase/decrease the size of the font.
- Click **Properties** to view/edit the properties of selected text.

## Format Tab for Shapes

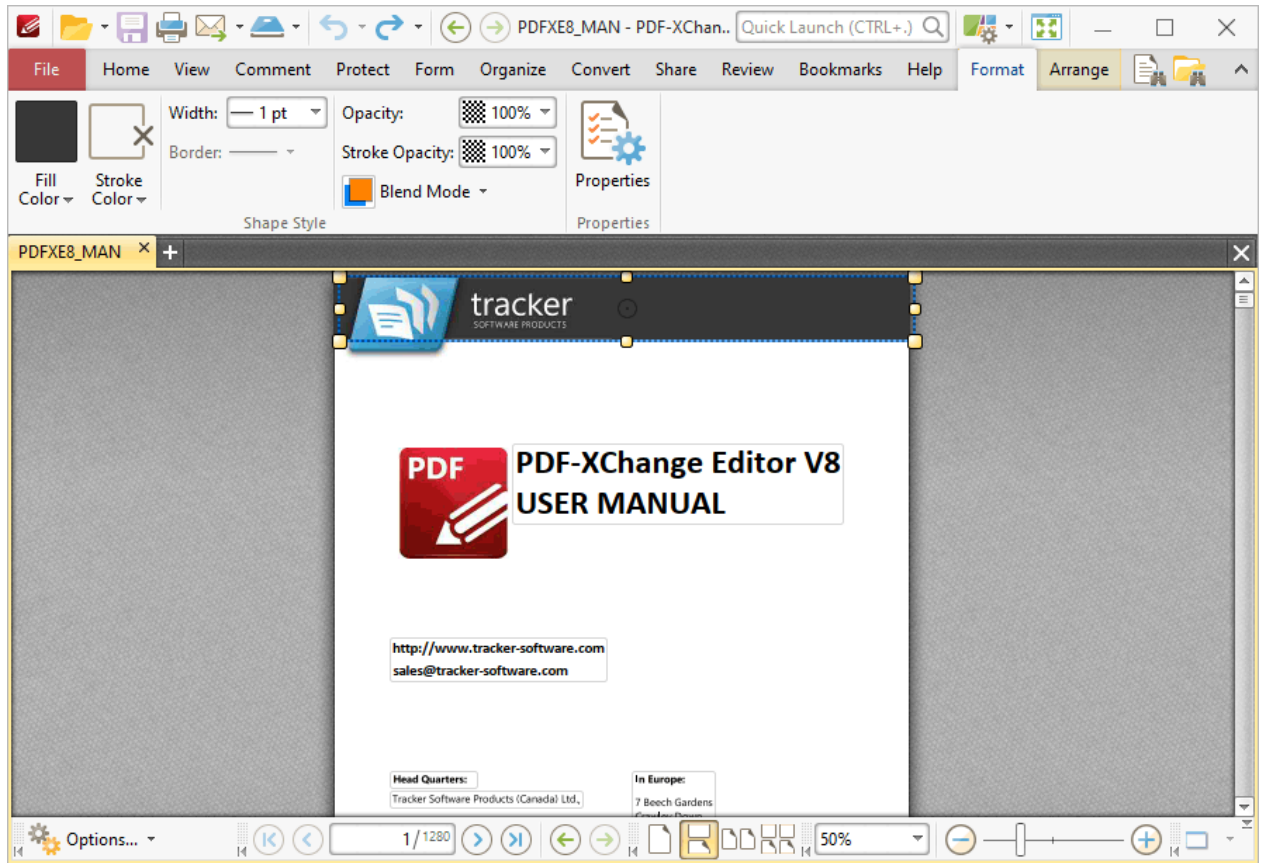

Figure 7. Format Tab for Shapes

- Use the **Fill Color** dropdown menu to determine the color of the shape.
- Use the **Stroke Color** dropdown menu to determine the border color of the shape.
- Use the **Width** dropdown menu to determine the width of the **Stroke Color**.
- The **Border** option is not available for shapes.
- Use the **Opacity** and **Stroke Opacity** dropdown menus to determine the level of transparency of the **Fill Color** and **Stroke Color** respectively.
- Use the **Blend Mode** to determine the blend mode used when shapes overlap with other content, as detailed [here](#).
- Click **Properties** to view/edit the properties of selected shapes.

## Right-Click Options Menu

Right-click content for further options. Please note that available options depend on the format of selected content. The menu below contains all available options:

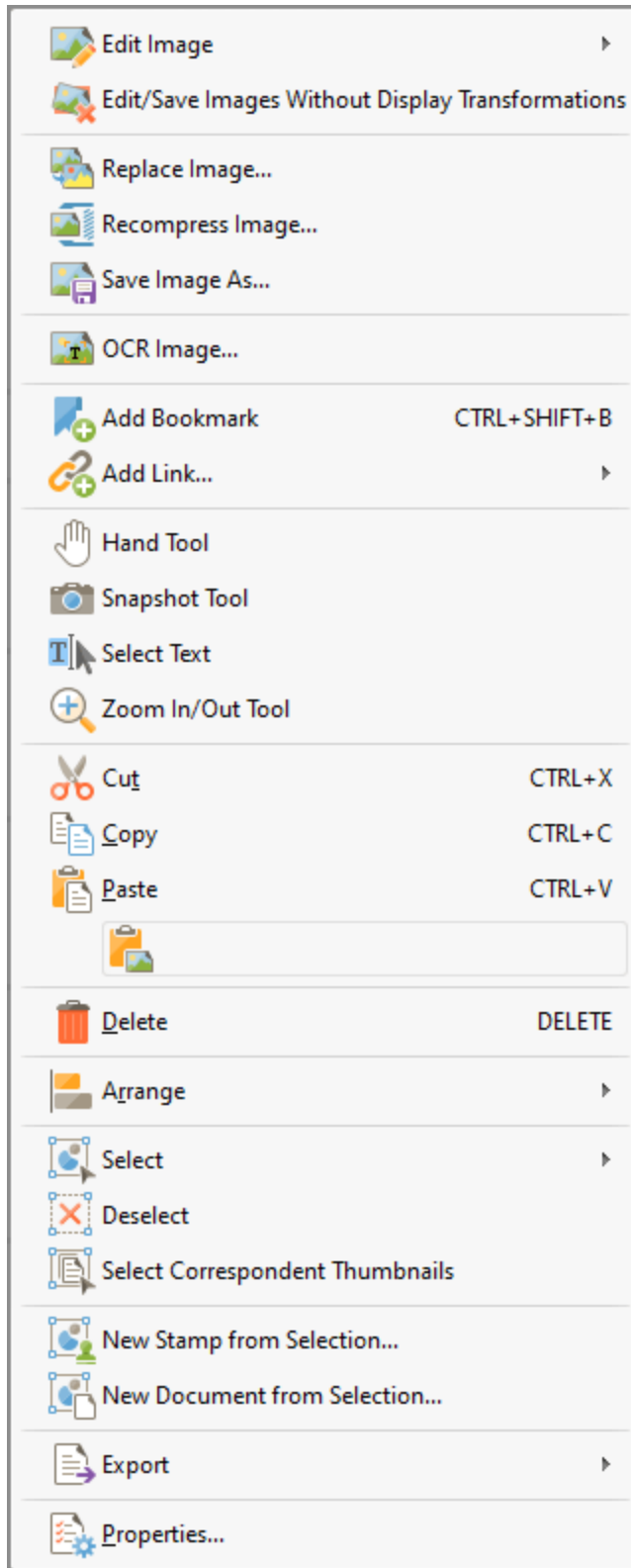

Figure 8. Content Items Right-Click Menu

- Hover over **Edit Image** to view editing options for images:

- Click **Default Application** to edit the image in the default application for editing images. Note that changes made to images in the application will be updated in the current document when the image is saved.
- Click **Open With** to select a non-default application with which to edit the image. The **Open with** dialog box will open. Selected the desired application and click **OK** to launch it.
- Click **Edit/Save Images Without Display Transformations** to enable/disable this feature. When it is enabled, images can be edited/saved in the state that they were in when added to the document. All subsequent rotations, transformations and scaling operations applied to the image/page are ignored.
- Click **Replace Image** to replace selected images with an image from file. Note that replacement images are automatically scaled to match the dimensions of images that they replace.
- Click **Recompress Image** to recompress images, as detailed below.
- Click **Save Image As** to save a copy of selected images to file. The **Save File As** dialog box will open. Enter a file name in the **File name** text box, then click **Save** to save the image.
- Click **OCR Image** to perform optical character recognition on selected images. The **OCR Image** dialog box will open. Select the desired language and accuracy then click **OK** to perform OCR.
- Click **Add Bookmark** to add a bookmark at the selected location. Further information on bookmarks is available [here](#).<sup>994</sup>
- Hover over **Add Link** to view the options for adding links:
  - Click **Add Goto Link** to create a link from the selected location to a location within the current document. The **Browse for Link Target** dialog box will open. Move to and select the desired document location and then click **Set Link** to create the link.
  - Click **Add Weblink** to create a link from the selected location to an internet location. The **Add Action: "Open a Web Link"** dialog box will open. Enter the desired **URL** in the text box and then click **OK** to create the link.
  - Click **Add Open File Link** to create a link from the selected location to a file on the local computer. The **Add Action: "Open a File"** dialog box will open. Determine options as detailed [here](#).<sup>970</sup> then click **OK** to create the link.
  - Click **Add Custom Link** to create a custom link. Custom links can be used to create a range of dynamic links, such as links that launch JavaScript actions, move to pages in other documents, open files, execute **PDF-XChange Editor** commands, reset/submit forms, play sounds and show/hide form fields. The **Edit Action List** dialog box will open. Determine options as detailed [here](#).<sup>959</sup> then click **OK** to create the link.
- Click **Hand Tool, Snapshot Tool, Select Text** or **Zoom In/Out Tool** to enable these tools.
- Click **Cut, Copy, Paste** or **Delete** to perform these actions on selected content. If you have selected text then additional options are available:

- Click **Paste as plain text** to paste text as plain text.
- Click **Paste as Rich Text** to paste text as rich text.
- Hover over **Arrange** to view arrangement options for selected content:
  - Use the **Align** options to align selected content items.
  - Use the **Distribute** options to distribute selected content items evenly on the horizontal or vertical axis as desired.
  - Click **Make Same Width/Height/Size** to make selected content items the same width/height/size as desired.
  - Use the **Rotate/Flip** options to rotate/flip selected content.
  - Click **Transform** to edit the position, size and/or rotation of selected content, as detailed [here.](#)<sup>948</sup>
  - Click **Duplicate** to duplicate selected content items, as detailed [here.](#)<sup>950</sup>
  - Click **Bring Forward** to bring content items forward one step in cases of multiple items overlapping.
  - Click **Send Backward** to send content items back one step in cases of multiple items overlapping.
  - Click **Bring to Front** to bring content items to the front in cases of multiple items overlapping.
  - Click **Send to Back** to send content items to the back in cases of multiple items overlapping.
- Hover over **Select** to view options for selecting all content of a specific format in documents:
  - Click **All** to select all content items in the document.
  - Click **Text** to select all text in the document.
  - Click **Images** to select all images in the document.
  - Click **Shapes** to select all shapes in the document.
  - Click **XForms** to select all XForms in the document.
- Click **Deselect** to deselect selected content.
- Click **Select Correspondent Thumbnails** to select the thumbnails of currently selected content. The corresponding thumbnails will then be selected in the [Thumbnails](#)<sup>1000</sup> pane.
- Click **New Stamp from Selection** to create a new stamp from selected content, as detailed [here.](#)<sup>1195</sup>
- Click **New Document from Selection** to create a new document from selected content. The new document will open in a new window in **PDF-XChange Editor**.
- Hover over **Export** to view export options for selected content, then click **Export Selection to Microsoft Word Document/Excel/Powerpoint Presentation** as desired. The **Save File** dialog box will open. Enter a name/location for the new file and then click **Save** to export the content.
- Click **Properties** to open the **Page Content Properties** pane for selected content. This pane is used to view/edit content properties, as detailed [here.](#)<sup>1033</sup>

## Recompress Images

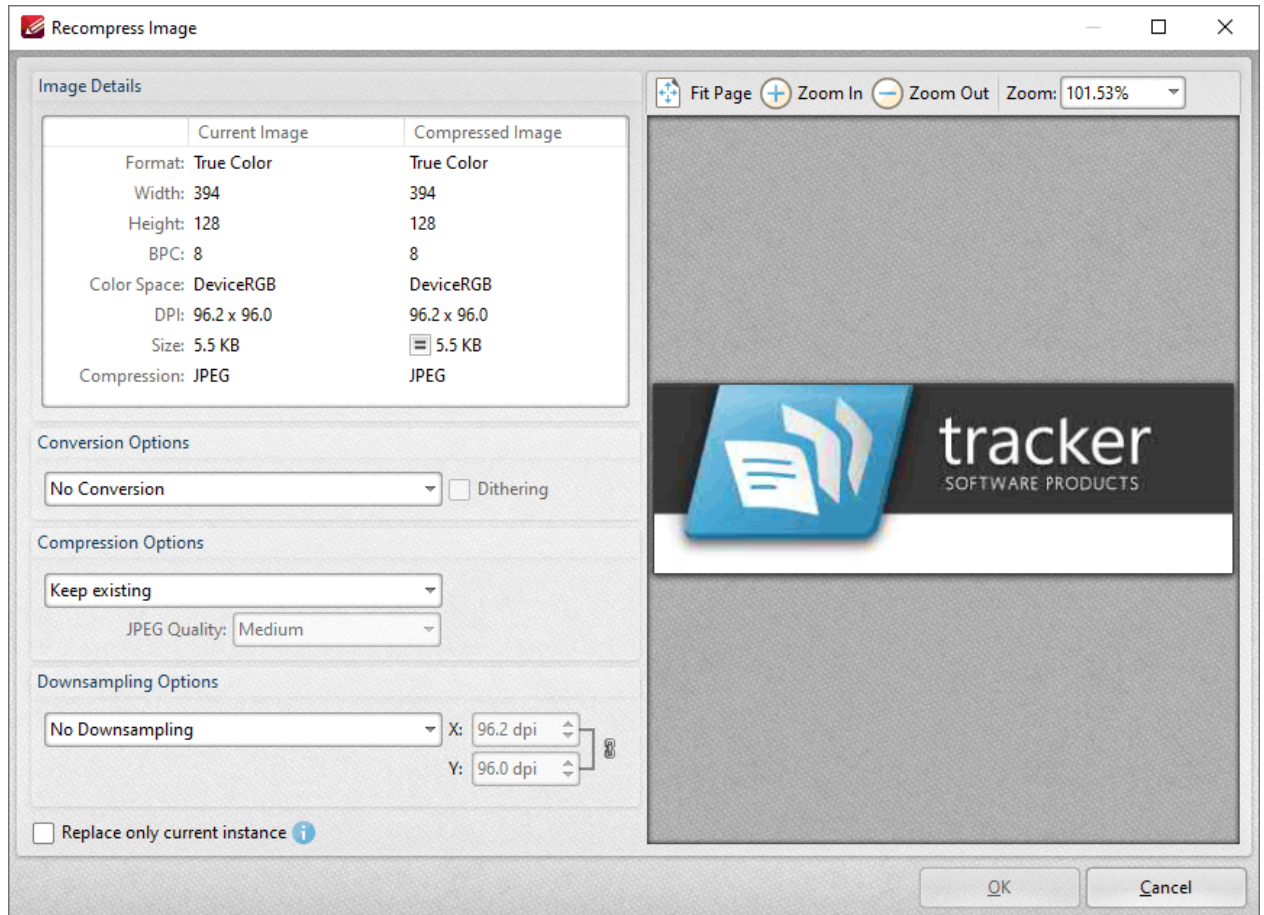

**Figure 9.** Recompress Image Dialog Box

- Use the **Conversion Options** dropdown menu to select a new compression format for images. Note that the selection made in this dropdown menu determines the options for the two dropdown menus below.
- Use the **Compression Options** dropdown menu to select a new compression format for images.
- Use the **Downsampling Options** dropdown menu to determine downsampling options as desired. The **X** and **Y** text boxes determine the downsampled resolution on the **X** and **Y** axes respectively.
- Select the **Replace current instance only** text box to replace only the current instance of the image in documents where the same image is used multiple times.

Note that the values in the **Image Details** pane display details about the current image and the image after compression has taken place using the values entered in the **Recompress Image** dialog box. Additionally, the preview pane will update according to any changes made.

### ▼ Add Text/Images/Barcodes to Documents



Click **Add** to add content to documents:

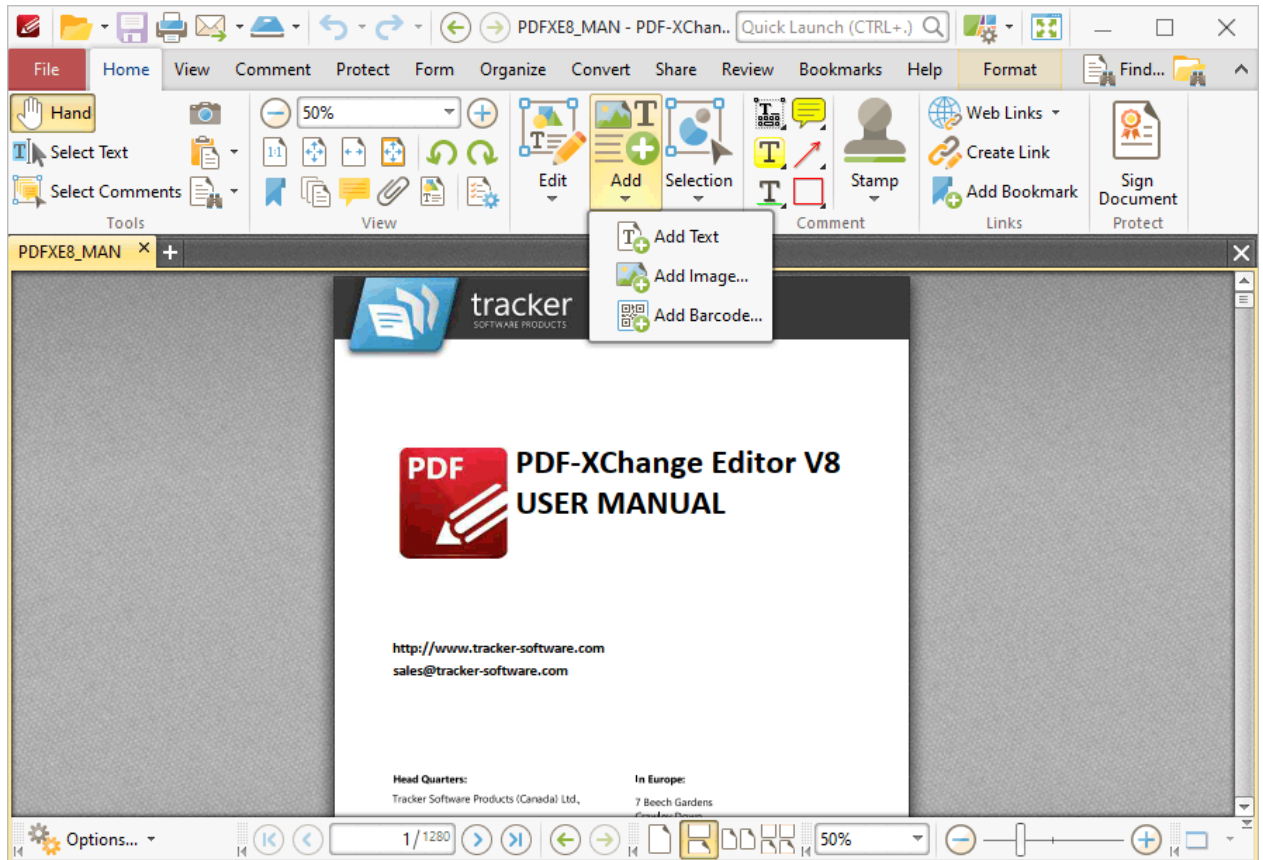
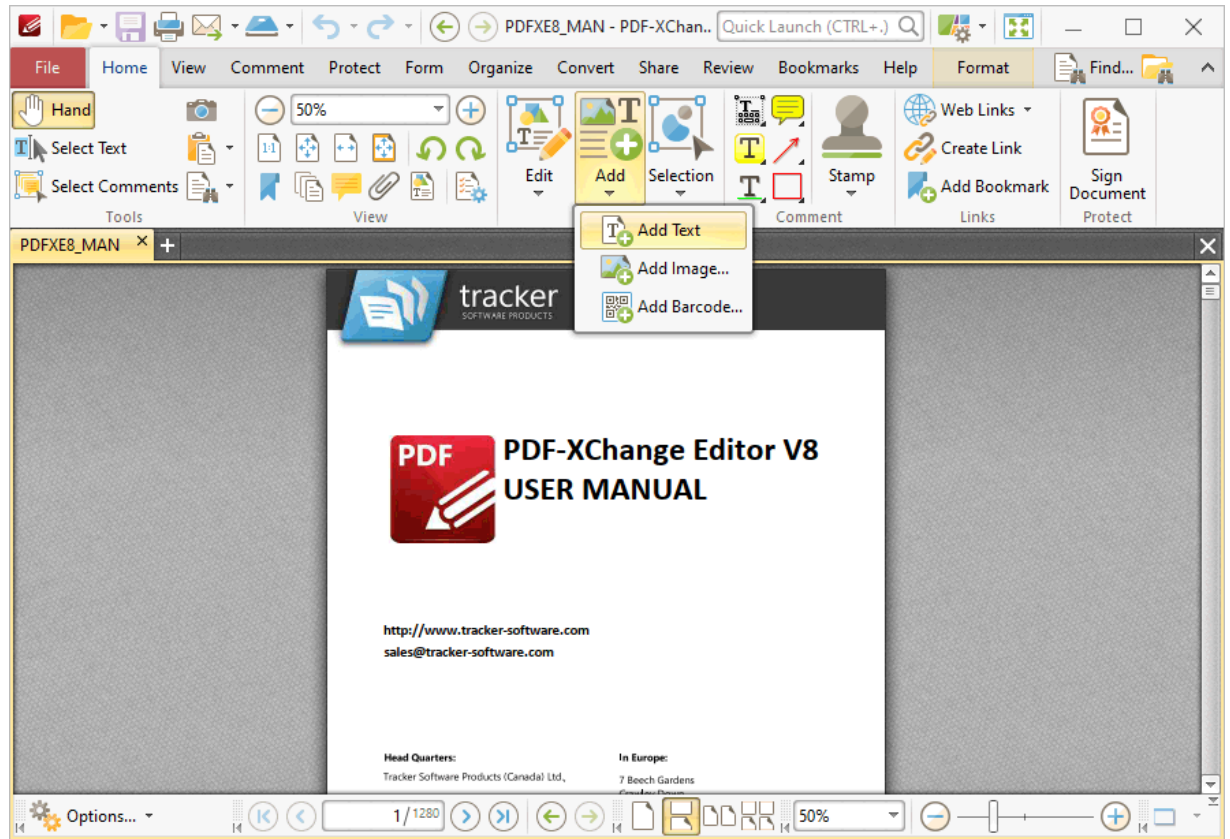

**Figure 10.** Tools Tab Submenu. Content Editing Tools, Add Options

These options are used to add text, images and barcodes to documents:

#### ▼ **Add Text**

Click **Add Text** to add text to documents:



**Figure 11.** Home Tab, Add Content Options

When this feature is selected the pointer will become a cross icon. Move the icon to the desired location and click to designate the location of the new text box. Text can then be entered as desired:

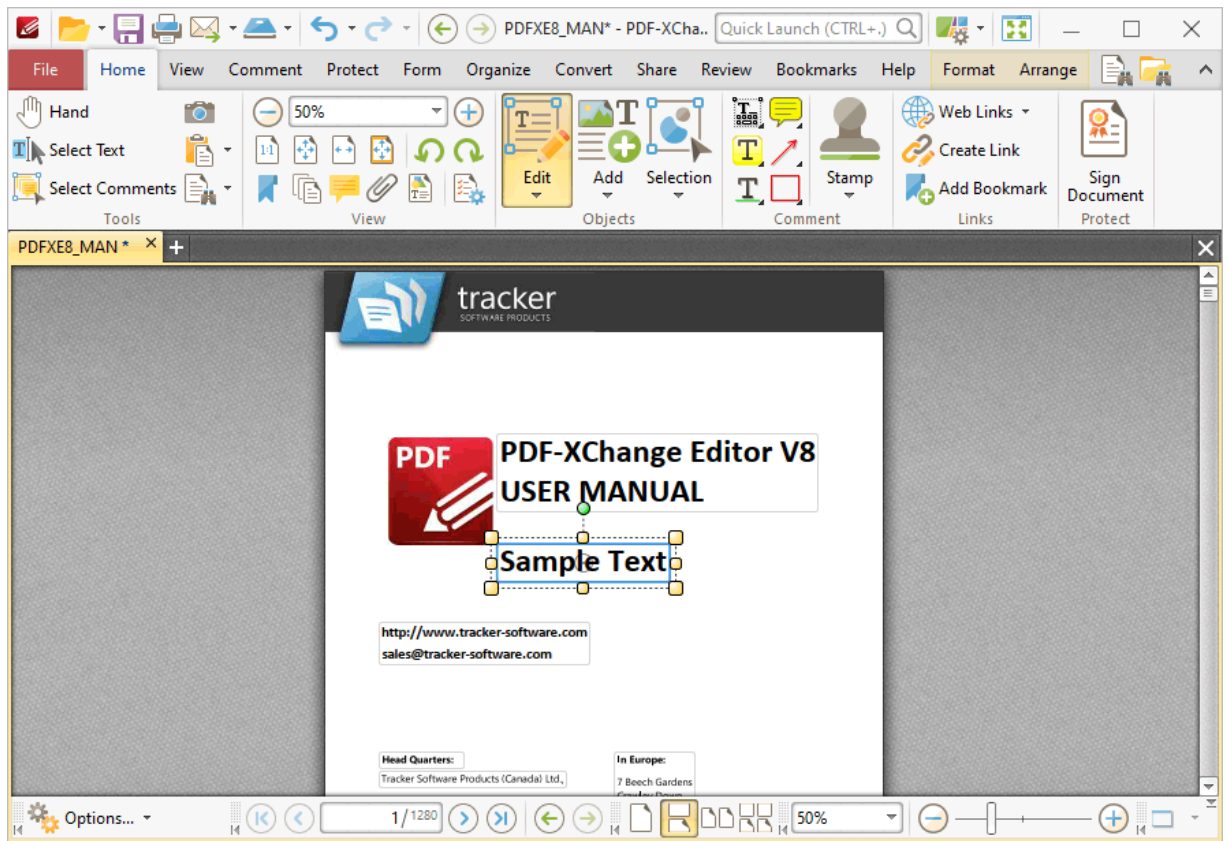

Figure 12. Add Text Tool Example

- Click and drag the central yellow control points on either side of text boxes to resize them horizontally. (Note that it is not possible to resize text boxes vertically until text has been entered into them).
- Click and drag the green control point to rotate text boxes. Hold down Shift to rotate at increments of fifteen degrees.
- Use the editing aids detailed [here](#) to assist in the precise placement of text boxes.
- Enter the desired text in the text box. Press **Enter** to start new lines. The options in the **Format** tab can be used to adjust the text style, as detailed above.
- Press **Insert** to enable/disable the 'overtyping' feature, which enters text over existing text.
- Right-click text for further options:

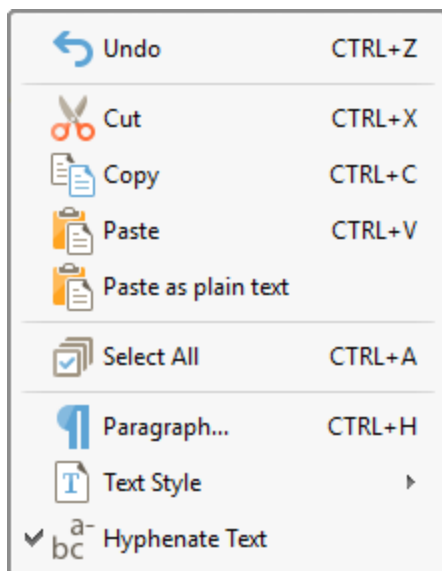

Figure 13. Editing Options

- Click **Undo** to reverse the most recent action.
- Click **Cut** to cut selected text to the clipboard.
- Click **Copy** to copy selected text to the clipboard.
- Click **Paste** to paste current clipboard text at the selected location.
- Click **Paste as plain text** to paste current clipboard text as plain text at the selected location.
- Click **Select All** to select all text in the selected area.
- Click **Paragraph** to edit paragraph settings, as detailed in *(figure 14)*.
- Click **Text Style** to update the style of selected text. The following options are available:
  - **Bold**
  - **Italic**
  - **Underline**
  - **Superscript** transforms selected text into superscript, which is used for specific purposes such as detailing chemical compounds.
  - **Subscript** transforms selected text into subscript, which is used for specific purposes such as detailing mathematical formulae.
  - **Clear Text Formatting** clears formatting from selected text.
  - **Make Current Text format Default** sets the format of selected text as the default format for subsequent text.
  - **Apply Default Text Format** applies the default text format to selected text.
- Select **Hyphenate Text** to hyphenate text automatically when it crosses line endings.

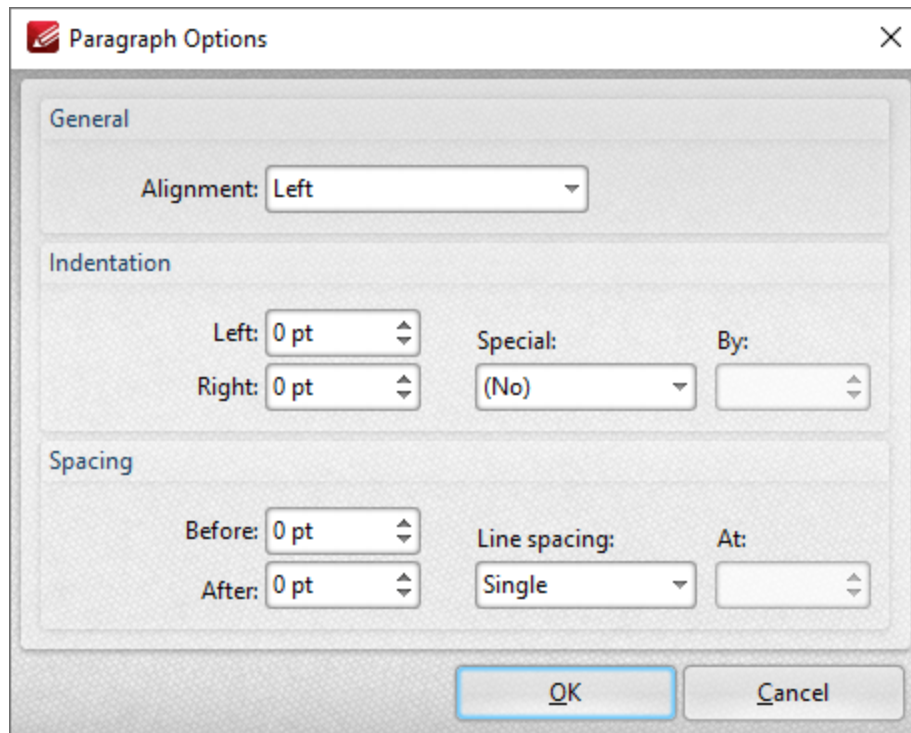

Figure 14. Paragraph Options

- Use the **Alignment** menu to determine the alignment of paragraphs.
- Use the **Indentation** number boxes to determine the indentation from the left and right margins, and the **Special** and **By** menus to determine hanging options.
- Use the **Spacing** options to determine line spacing.

Click **OK** to save paragraph settings.

#### ▼ Add Images

Click **Add Image** to add images to documents:

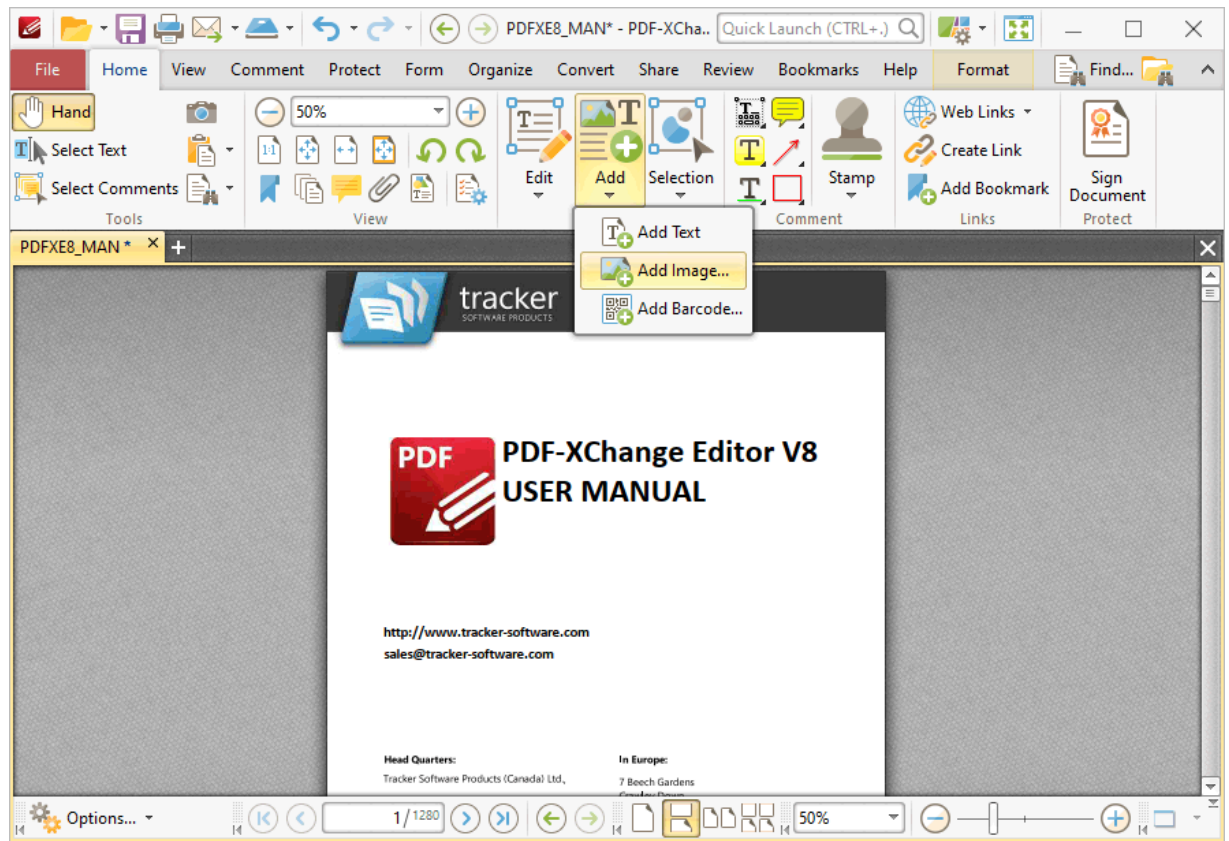

Figure 15. Tools Tab Submenu. Add Image Tool

The **Select Image Placement Tool** dialog box will open. Click **Drag Image Rectangle**, then click and drag to determine the location at which the image is inserted. The **Open Files** dialog box will open. Select an image from the local computer. The **Add Image** dialog box will open:



Figure 16. Add image Dialog Box

- Click the folder icon to select an alternative file.
- Select an option to determine how the image is added:
  - **As a Stamp** adds images as stamp annotations, as detailed [here](#).
  - **As a Content Item** adds images as content items.

Please note that stamps and content items feature different editing options.

Click **Place** to add images.

### ▼ Add Barcodes

Barcodes provide a useful method for the storage of information that barcode readers and mobile devices such as smartphones and tablets can access. Click **Add Barcode** to add barcodes to documents:

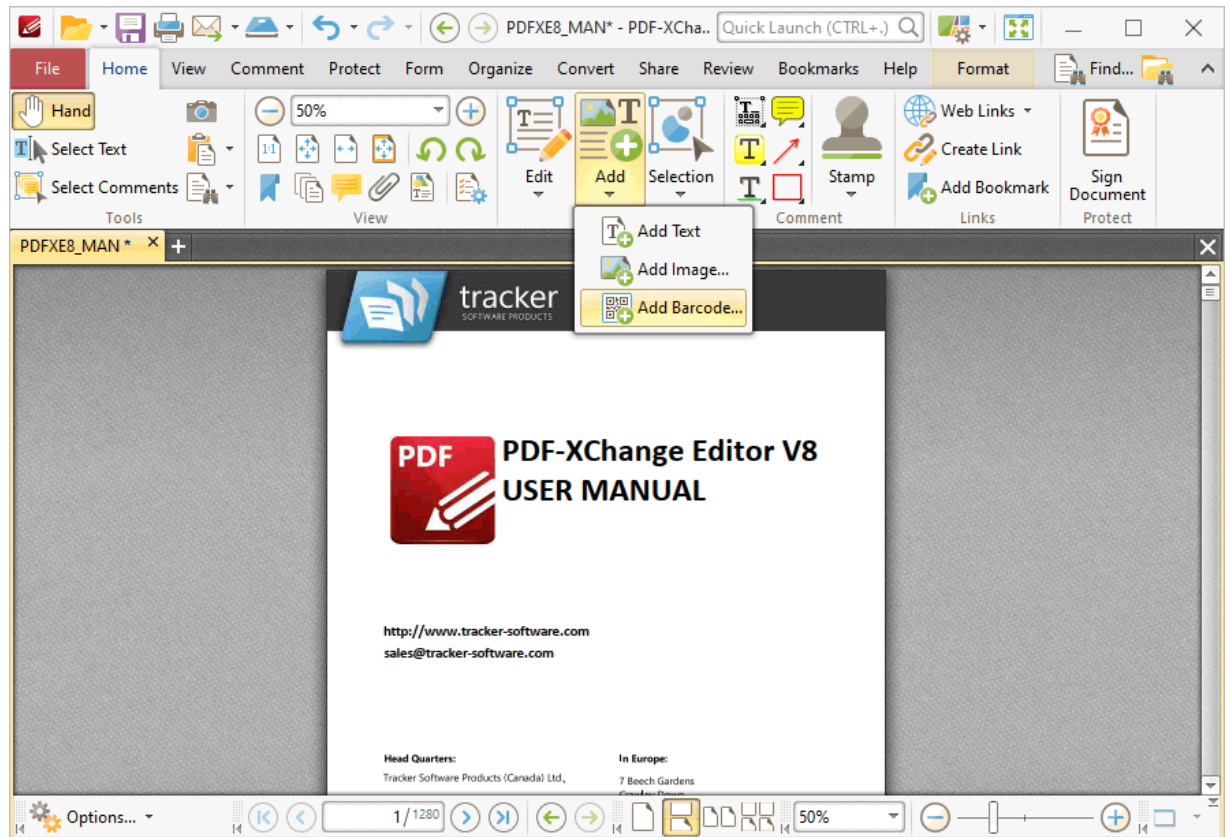

Figure 17. Add Submenu. Add Barcode

The **Select Barcode Placement Tool** dialog box will open when. Click **Drag Barcode Rectangle** to add a new barcode. The pointer will become a crosshairs icon. Click and drag to determine the size and location of the barcode. The **Add Barcode** dialog box will open:



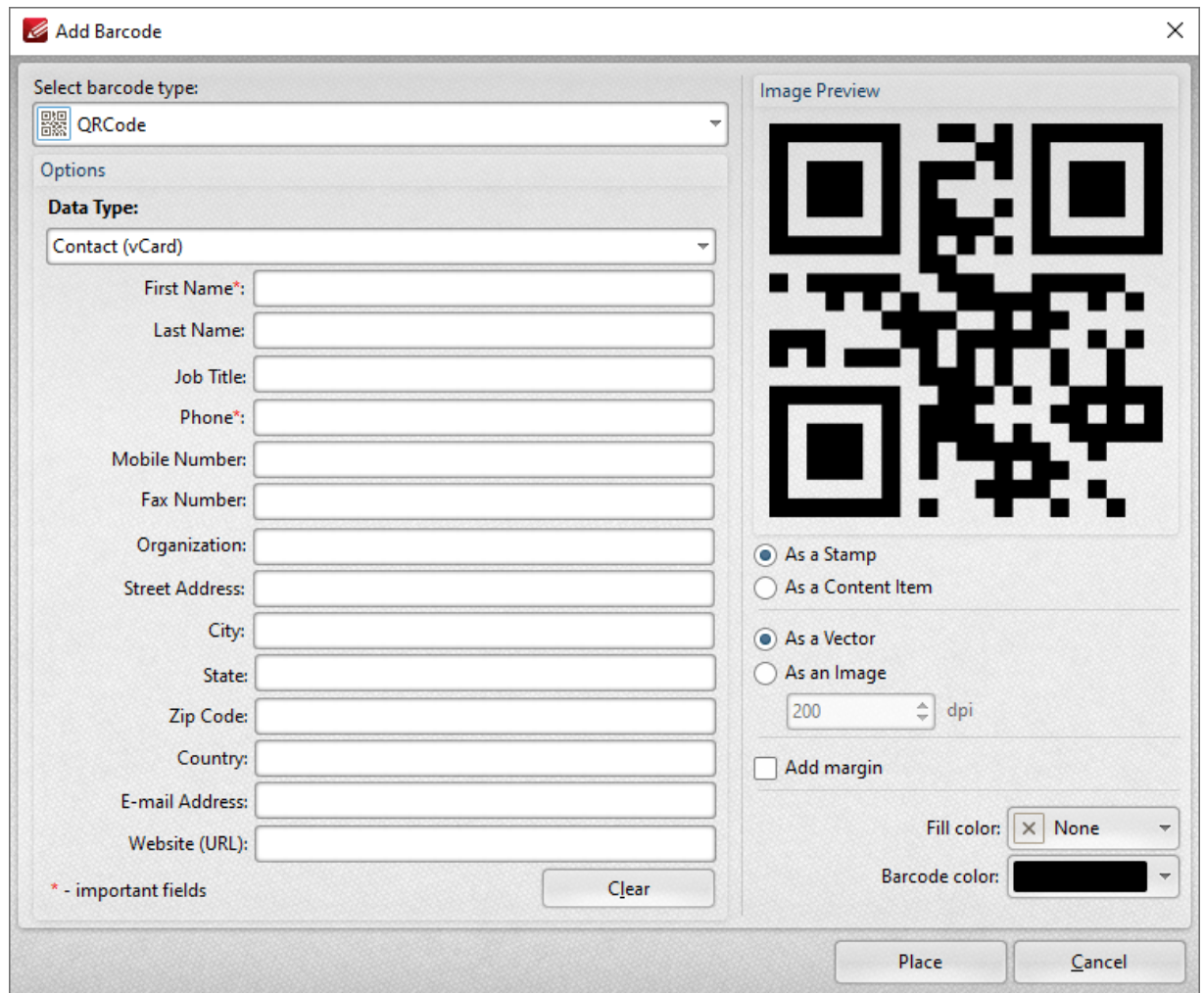

Figure 18. Add Barcode Dialog Box

- Use the **Data type** menu to set the format of the data contained in the barcode:
  - **Contact (vCard)** is a file format standard that is used to store electronic business cards.
  - **URL** is used to store internet addresses.
  - **Free Text** is used to store text-based content.
  - **Email** is used to store information in email format.
- Barcodes are created automatically when data is entered in the text fields, and can be viewed in the **Image preview** pane.
- Select either **As Stamp annotation** or **As part of page's content** to determine how barcodes are added to documents. Please note that stamp annotations and page content have different editing options.
- Select either **As Vector** or **As Image** as desired. If the **Image** option is selected then use the **DPI** number box to determine the barcode resolution.
- Select the **Add Margin** box to add a margin to barcodes.
- Use the **Fill color** and **Barcode color** palettes to determine the colors used for barcodes.

Click **Place** to add the barcode to the document.

---

10.5.3 Blend Mode



**Blend Mode**

The **Blend Mode** property is available for document content and many of the commenting features in **PDF-XChange Editor**. When the **Blend Mode** feature is available, it is displayed in the **Format** tab and the **Properties** pane:

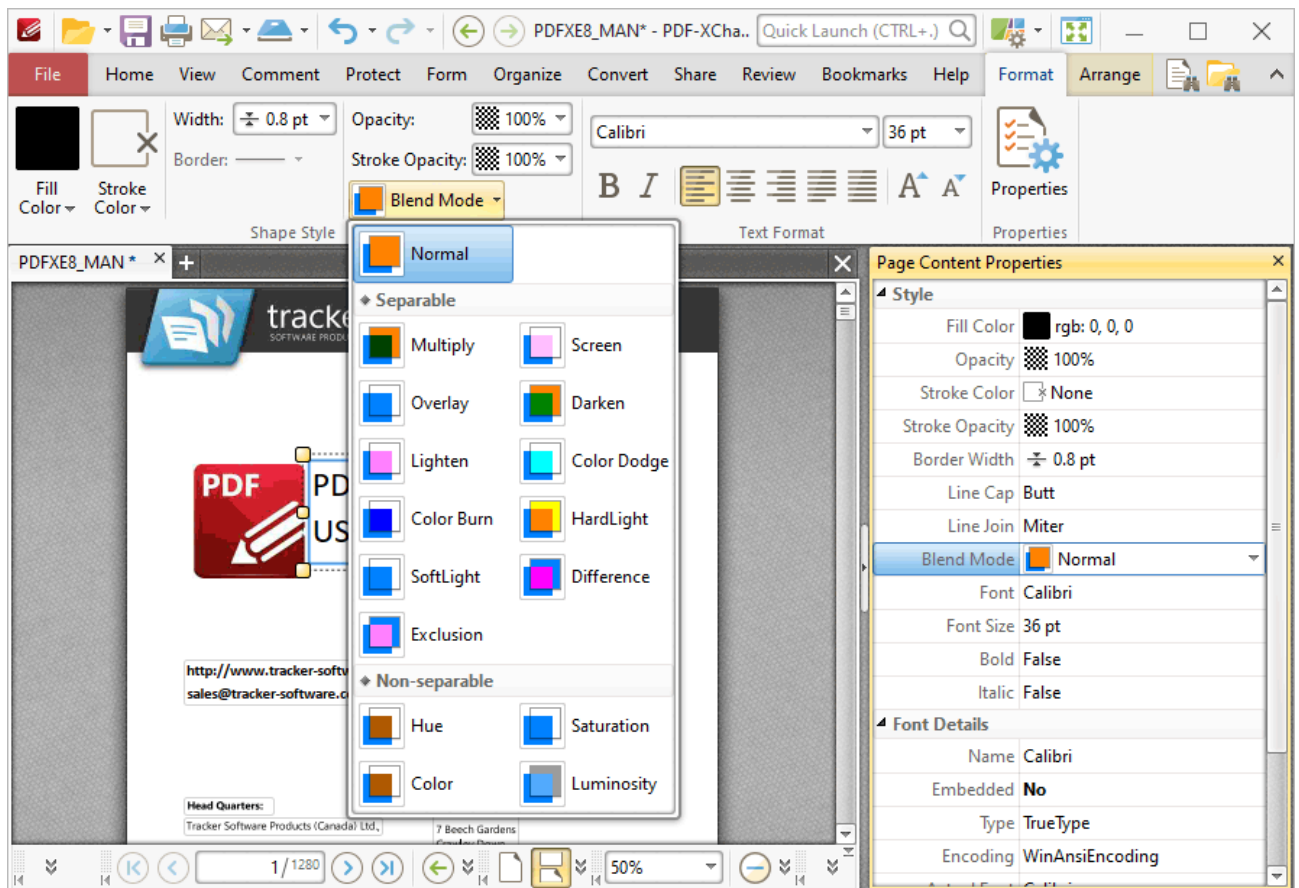

Figure 1. Blend Mode Locations

The **Blend Mode** feature determines how content blends with overlapping content. Note that the **Fill Color** property is referenced when **Blend Modes** are used. This property can be edited in the **Format** tab or the **Properties** pane.

- **Normal** maintains the selected **Fill Color**.
- **Multiply** multiplies the **Fill Color** value with the color value of the underlying content. Resultant colors are at least as dark as one of the source colors.
- **Screen** multiplies the complements of the **Fill Color** value with the color value of underlying content and then complements the result. The resulting color will be at least as light as one of the source colors.
- **Overlay** either multiplies or screens the **Fill Color** value with the color value of underlying content, depending on the color value of the latter. The **Fill Color** will overlay the underlying content while preserving its highlights and shadows. The color of underlying content will be blended with the **Fill Color** to reflect its shade.
- **Darken** selects the darker of the **Fill Color** value and the color value of underlying content.
- **Lighten** selects the lighter of the **Fill Color** value and the color value of underlying content.
- **Color Dodge** brightens the color of the underlying content to reflect the **Fill Color**. Note that if black is used as the **Fill Color** then there will be no effect.
- **Color Burn** darkens the color of the underlying content to reflect the **Fill Color**. Note that if white is used as the **Fill Color** then there will be no effect.
- **Hardlight** either multiplies or screens the **Fill Color** value with the color value of underlying content, depending on the **Fill Color** value. This creates the effect of shining a strong spotlight on the underlying color.
- **Softlight** either darkens or lightens colors, depending on the **Fill Color** value. This creates the effect of shining a diffused spotlight on the underlying color.
- **Difference** subtracts the darker of the constituent colors from the lighter color.
- **Exclusion** performs a less contrasted version of the **Difference** option.
- **Hue** combines the **Fill Color** value with the saturation and luminosity of the color value of the underlying content.
- **Saturation** combines the saturation of the **Fill Color** with the hue and luminosity color value of the underlying content.
- **Color** combines the the hue and saturation of the **Fill Color** with the luminosity color value of the underlying content.
- **Luminosity** combines the luminosity of the **Fill Color** with the hue and saturation of the color value of the underlying content.

Note that the **Arrange** tab can be used to change the layer order of overlapping content, which has a direct effect on the **Blend Mode**. The **Arrange** tab is available when compatible content is selected:

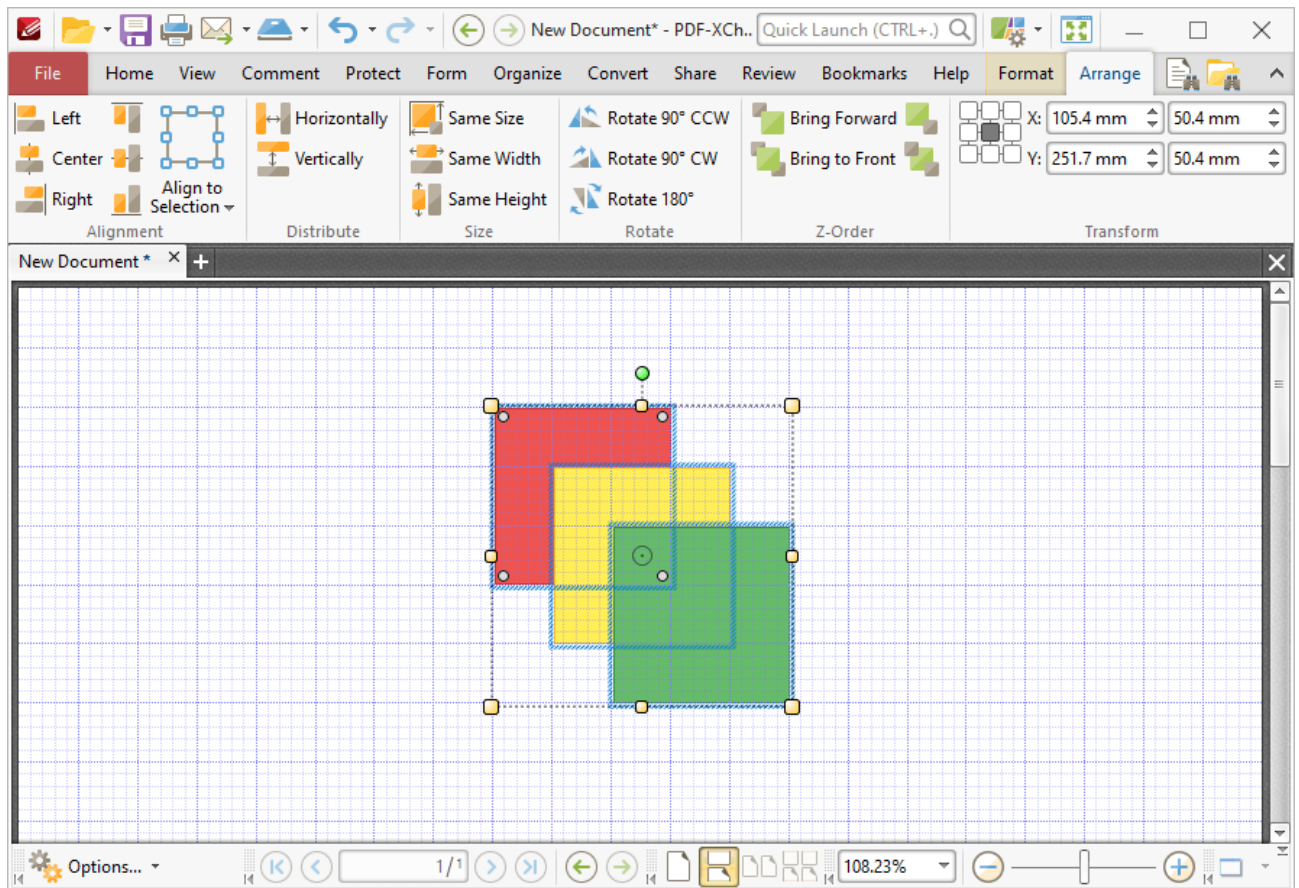

Figure 2. Arrange Tab, Selected Comments

- Click **Bring Forward** to bring the selected content up a step in cases where multiple items overlap.
- Click **Send Backward** to send the selected content back a step in cases where multiple items overlap.
- Click **Bring to Front** to bring the selected content to the top in cases where multiple items overlap.
- Click **Send to Back** to send the selected content to the back in cases where multiple items overlap.

10.5.4 Changing the Layout of Panes



Changing the Layout of Panes

The size and location of all panes in **PDF-XChange Editor** can be customized as desired.

**Editing Panes**

The editing panes are listed in the **Panes** dropdown menu in the **View** tab:

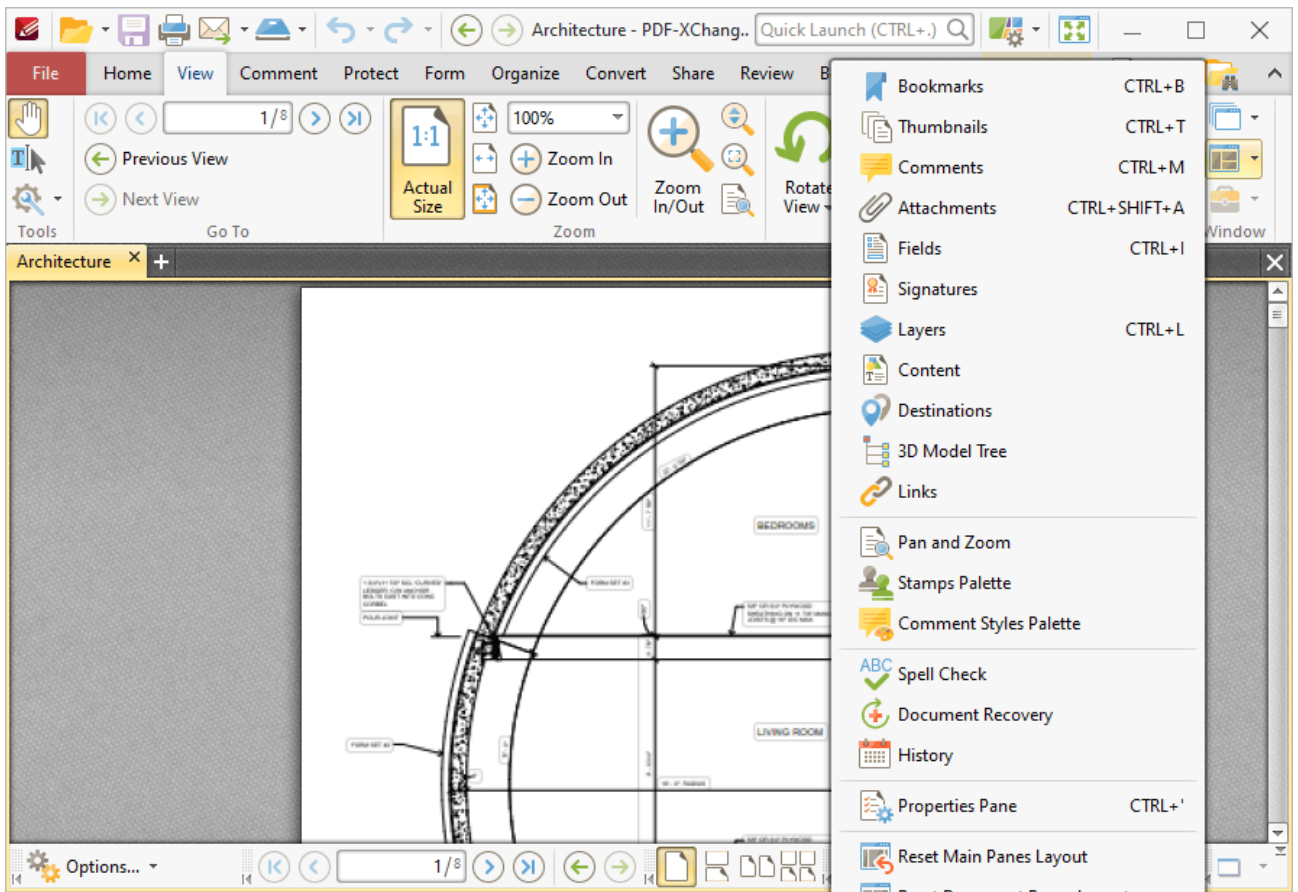

Figure 1. View Tab, Panes Dropdown Menu

Click to open panes:

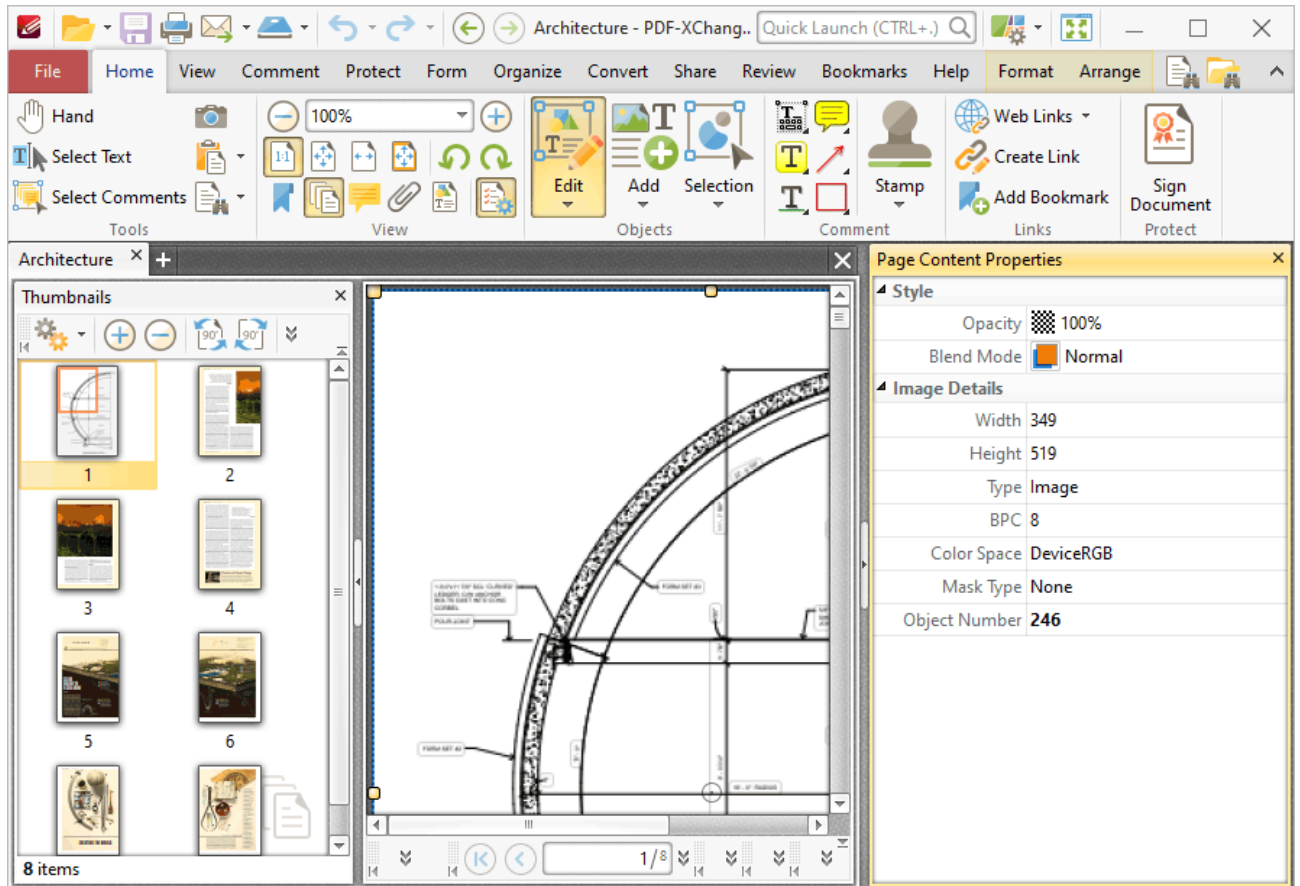

Figure 2. Thumbnails and Properties Panes Opened

Click and drag panes to undock them from the user interface, then move them to the desired location or to a new docking point. Available docking points will be displayed as detailed in **(figure 3)**. Drag panes onto docking points to dock them:

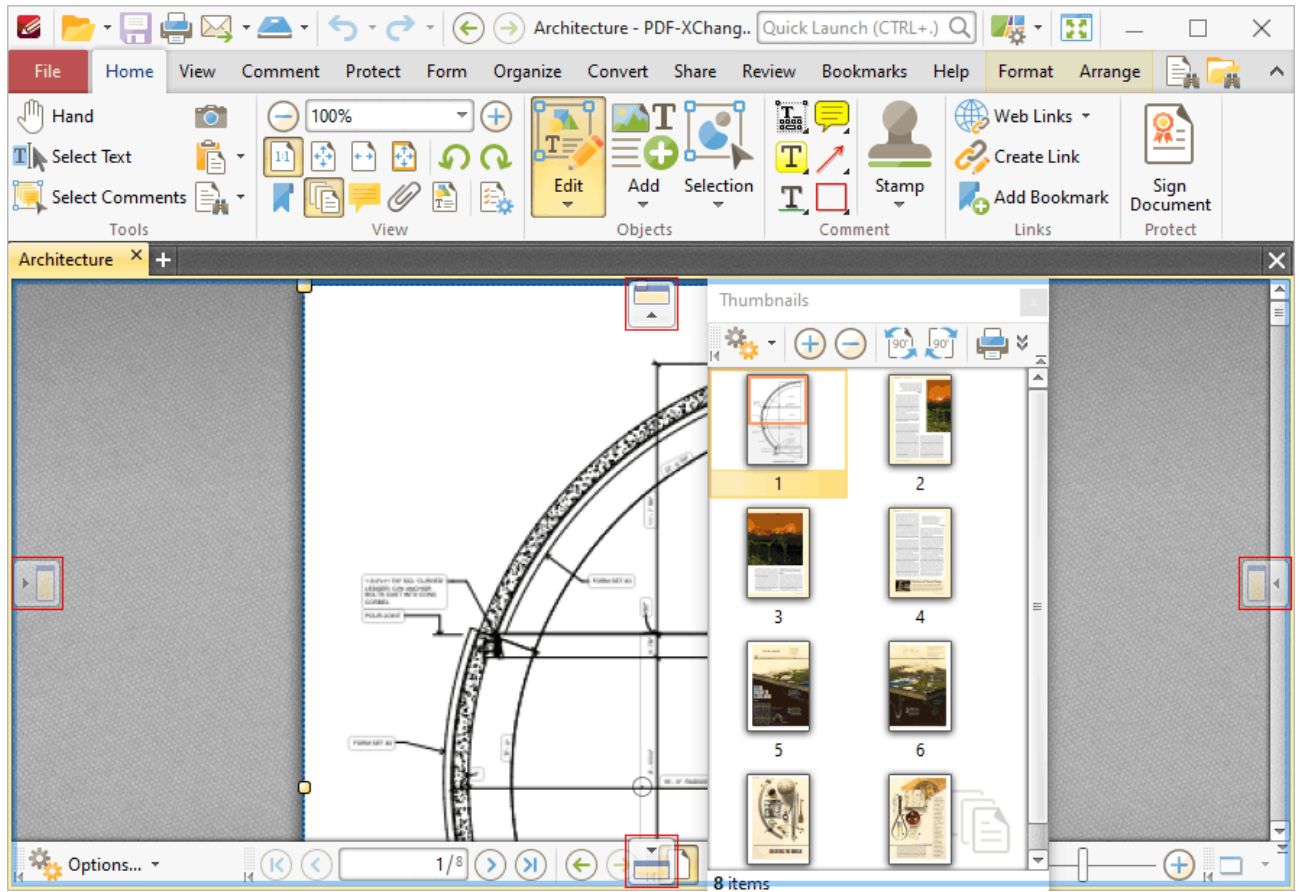

Figure 3. Example Docking Points



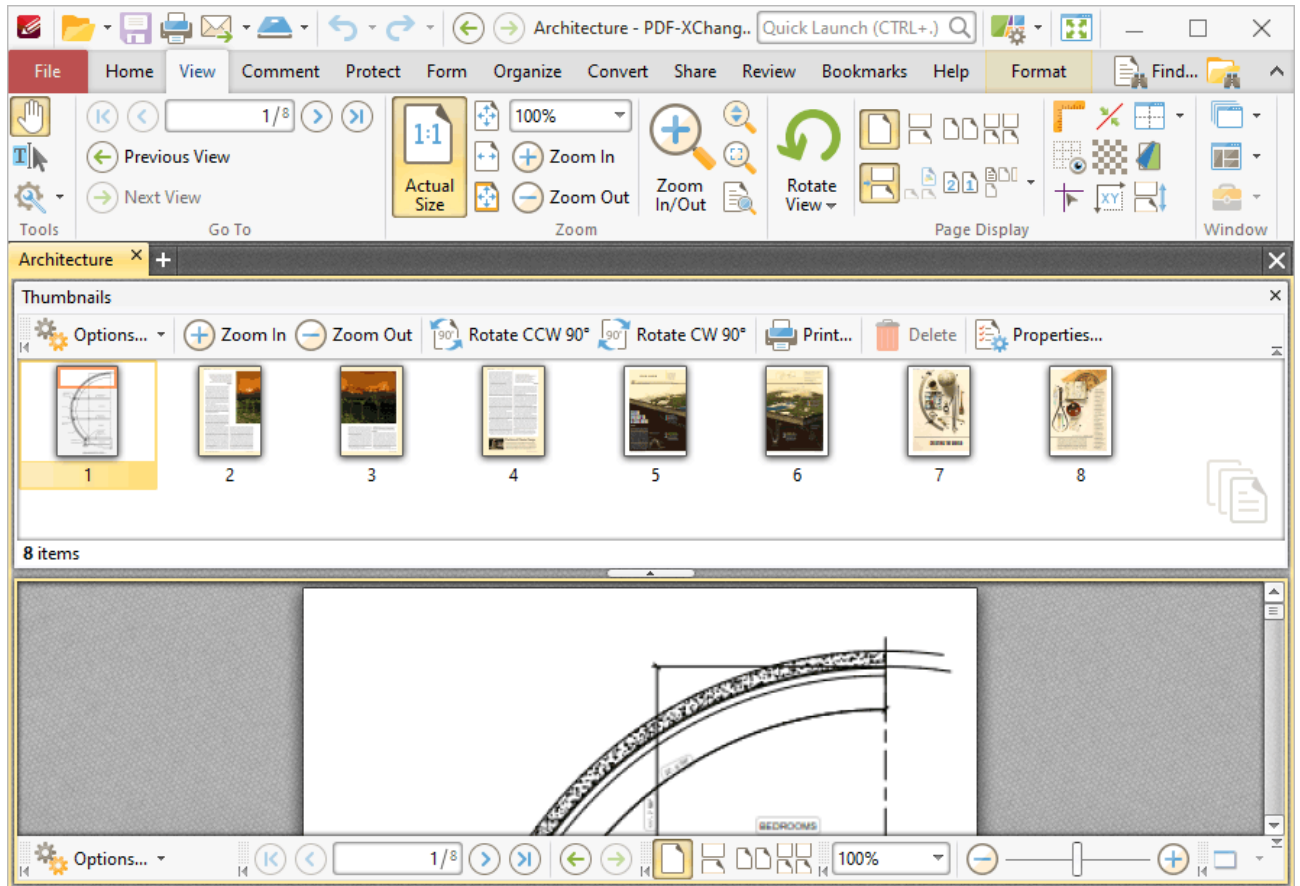

Figure 4. Repositioned Thumbnails Pane

Note that the minimize/maximize buttons can be used to minimize/maximize panes:

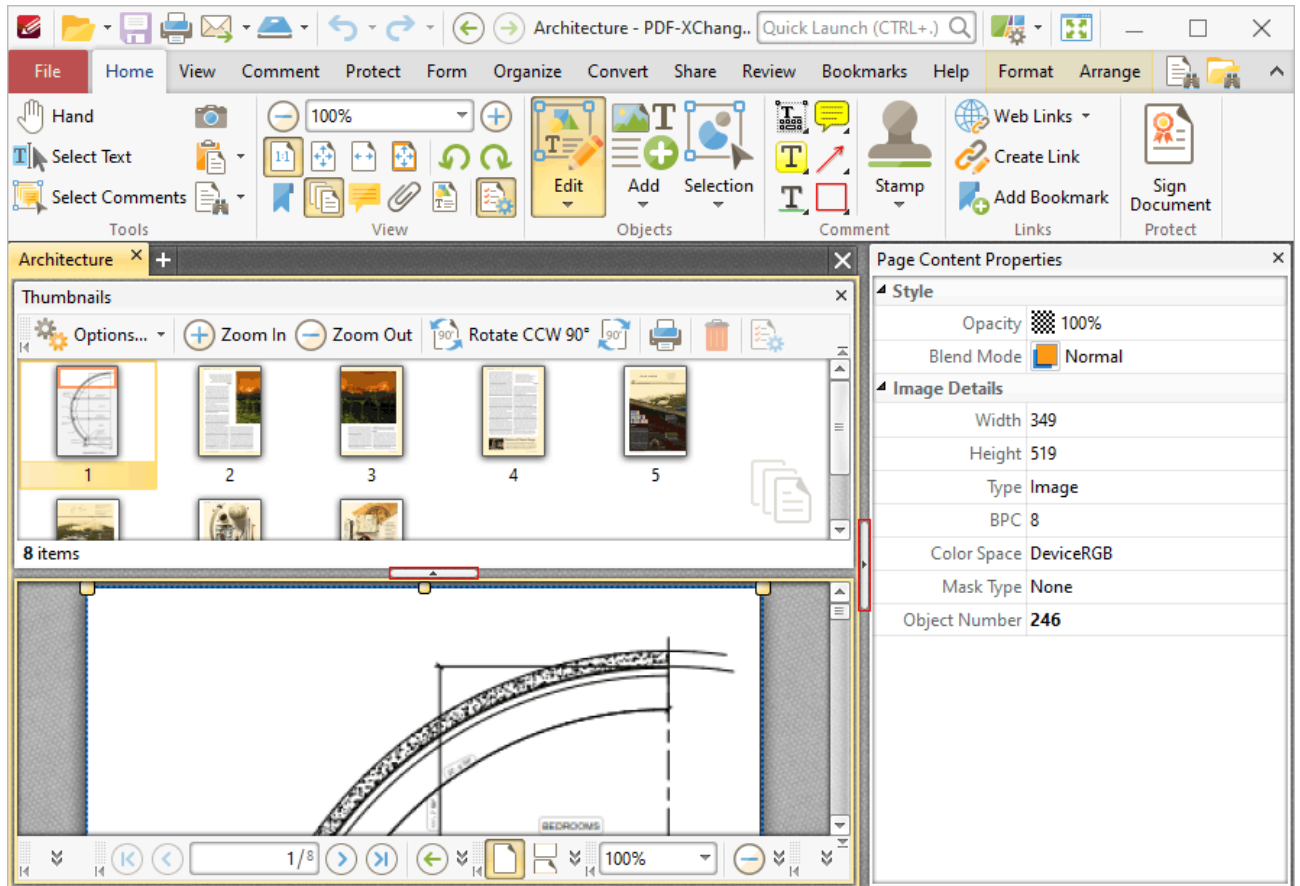

Figure 5. Minimize/Maximize Buttons

### Document Panes

Document panes can be edited in the same manner as editing panes. Click and drag document tabs to reposition document panes:

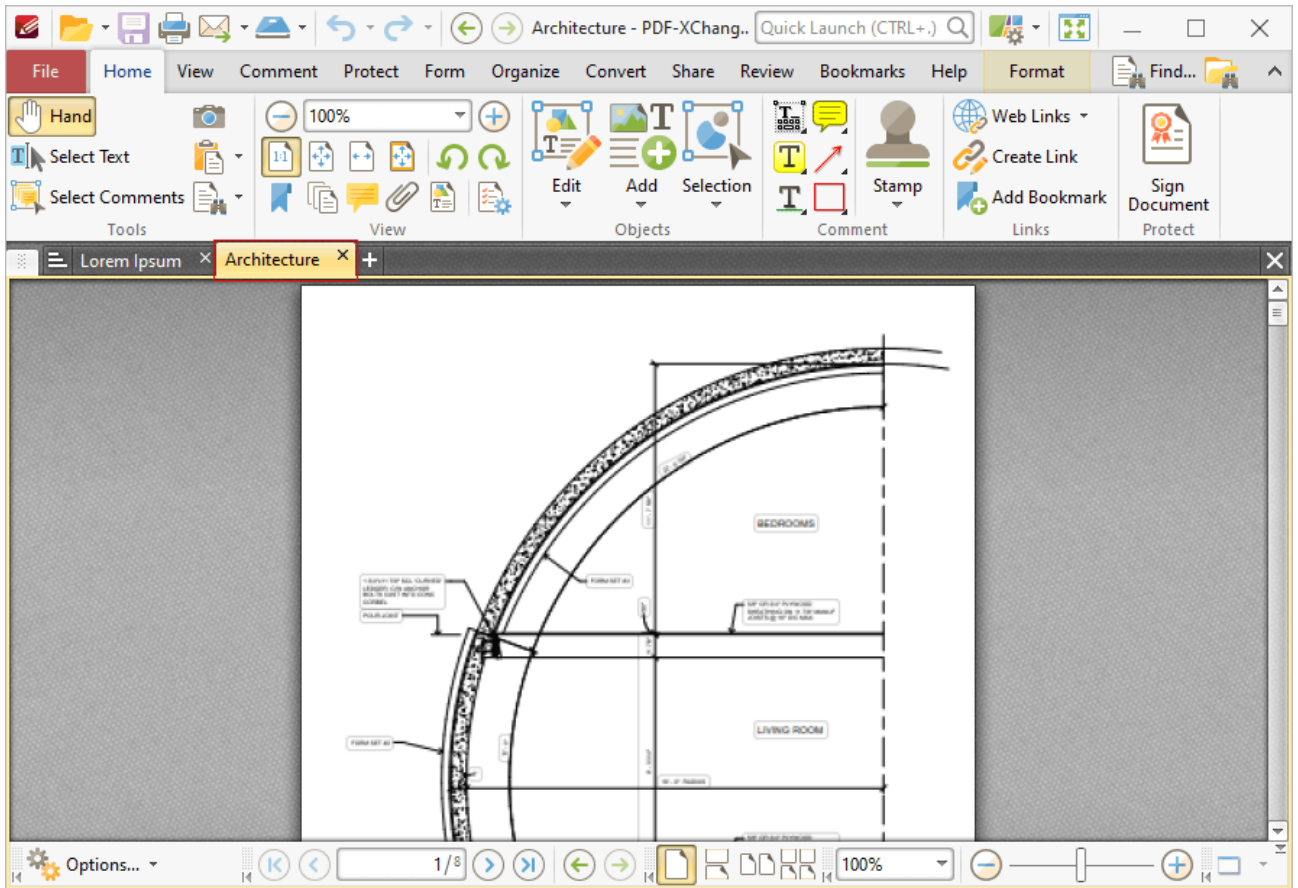

Figure 6. Document Tab Highlighted

Available docking points will be displayed in the center of the user interface:

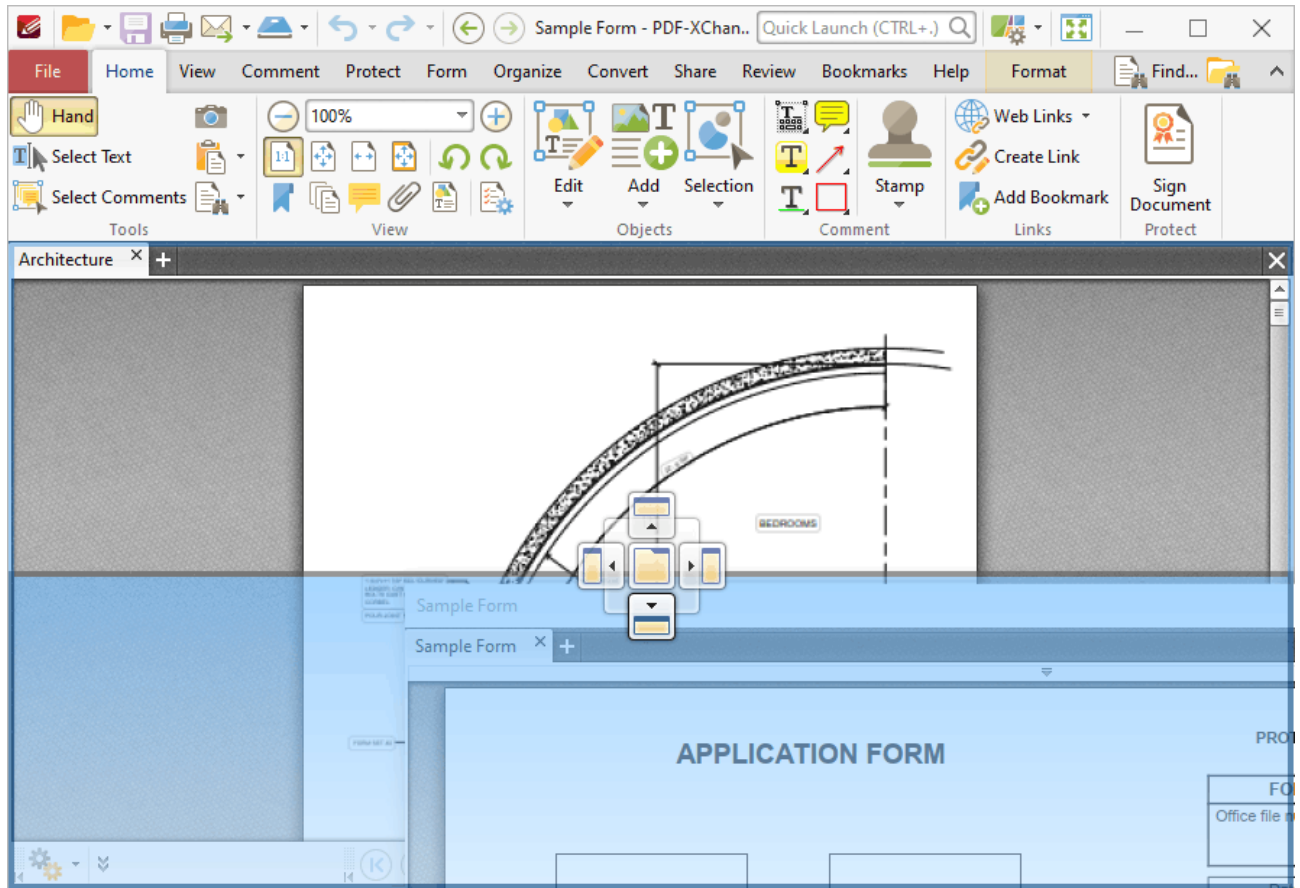

Figure 7. Document Pane Docking Points

Drag document panes onto docking points in order to open them in a new window above/below or to the left/right of the current pane. Dragging document panes to any other location will open them in a new instance of **PDF-XChange Editor**.

## 10.5.5 Command Line Options

---



### Command Line Options

---

The command line options detailed below are available in **PDF-XChange Editor**. Please note:

- If any values have spaces, backslashes or forwardslashes then the entire options list should be enclosed in quotation marks.
- If the **optionslistfile** contains spaces then it should be enclosed in quotation marks.
- If a profile is specified then changes will be made to that profile. If a profile is not specified then the changes will apply only to the current printer's settings.
- These options are for the **PDFXEdit.exe** executable, the default location of which is:

```
"C:\Program Files\Tracker Software\PDF Editor"
```

- Unless the path to **PDFXEdit.exe** is added to the system %path% variable, the full path to **PDFXEdit.exe** must be specified.
  - Use semicolons to delimiter options when more than one option is being used.
- 

### Formal Syntax

---

<anytext> means any text string.

<a>|<b> means <a> **or** <b>.

[expression] is the optional part of the command line. For example if the syntax is: **/print:[default[=yes|no]][;showui[=yes|no]] <filename>** then the following examples are correct:

```
/print "c:\example.pdf"  
/print:default "c:\example.pdf"  
/print:default;showui "c:\example.pdf"  
/print:default=yes;showui=yes "c:\example.pdf"
```

**<filename>** means full or relative path to file. When the path contains white spaces it should be enclosed in quotation marks. For example: c:\MyDocuments\MyTestDocument.pdf should be "c:\My Documents\My Test Document.pdf".

**<pagesrange>** specifies the range of pages to be processed. See [here](#) for further information on the specification of page ranges.

---

## Command Line Options

---

### **/addlang**

This command installs new UI-languages from a special UI-languages pack. The UI-languages pack is a zip-archive that contains one or more \*.xcl files. The format of the file will be .xclpack. See [here](#) for a list of available language packs for **PDF-XChange Editor**.

#### **Syntax**

```
/addlang[:[mode=]ask[user|all]] <filename>
```

#### **Parameters**

- **mode=ask** – asks user about installing mode: “for this user only” or “for all users on this machine”. This is the default mode.
- **mode=user** – installs new UI-languages silently, for only the current user.
- **mode=all** – installs new UI-languages silently, for all users on the target machine.

Please note that system administrator privileges are required when making changes that affect all users.

#### **Example**

```
PDFXEdit.exe /addlang:mode=user "c:\Users\John\Downloads\German.xclpack"
```

---

### **/close**

This command closes open documents according to the specified source file name.

#### **Syntax**

**/close[:[mode=]save|discard|ask]**

### Parameters

- **mode=ask** – if the document has been edited then the software will prompt the user about saving changes before it closes. This is the default mode.
- **mode=discard** – closes the document silently, i.e. without prompting the user about saving changes.
- **mode=save** – if the document has been edited then the software saves changes silently before closing.

### Examples

```
PDFXEdit.exe /close "c:\example.pdf"  
PDFXEdit.exe /close:mode=save "c:\example.pdf"  
PDFXEdit.exe /close:discard "c:\example.pdf"
```

---

### /exportp

This command exports all the application settings to a specified file. It creates a new file with a special format that contains all the non-default options.

### Syntax

**/exportp <filename>**

### Parameters

There are no available parameters for this command.

### Example

```
PDFXEdit.exe /exportp "c:\PXCEditor.MySettings.Backup.dat"
```

---

### /exportsettings

This command exports settings of the application to a file on the local computer. This operation can also be achieved via the [Export Settings](#)<sup>933</sup> feature.

### Syntax

**/exportsettings[:<parameters>] <filename>**

## Parameters

Note that all parameters support the values **yes**, **no**, **1**, **0**, **true** and **false**.

- **common** - exports common program options (but does not include presets lists, trusted/untrusted locations and names or places). The default value is **true**.
- **presets** - exports the preset lists of the application, such as color management and scanner presets. The default value is **true**.
- **trustedlist** - exports the list of the trusted/untrusted locations and names. The default value is **true**.
- **places** - exports the list of places (user-defined locations that are used to open files, such as **Dropbox** folders). The default value is **true**.
- **history** - exports the list of recently opened files. The default value is **true**.
- **stamps** - exports all custom stamps collections. The default value is **false**.
- **dsatemplates** - exports the digital signature appearance templates. The default value is **false**.
- **pluginsdata** - exports the advanced plugins data. The default value is **false**.
- **signatures** - exports the list of signatures and initials. The default value is **false**.
- **all** - exports all settings. Note that this command line option can be customized using any of the available parameters. For example, **"/exportsettings:all=yes;stamps=0"** exports all settings except stamps, and **"/exportsettings:all=no;stamps=1"** exports only stamps. This command line does not have a default value because it is a combined option, but each option has its own default value, as detailed above.
- **settings** - exports all application settings (**common**, **presets**, **trustedlist** and **places**). This command line does not have a default value because it is a combined option, but each option has its own default value, as detailed above.

## Examples

```
PDFXEdit.exe /exportsettings "c:\PDFXChangeEditorSettings.xces"  
PDFXEdit.exe /exportsettings:history=no "c:\PDFXChangeEditorSettings.xces"  
PDFXEdit.exe /exportsettings:history=no;stamps=yes;pluginsdata=yes "c:  
\PDFXChangeEditorSettings.xces"
```

---

## /fileassoc

This command determines the file associations for **PDF-XChange Editor**.

## Syntax



**/fileassoc[:user=no|yes]**

### Parameters

- **user=no** - then file associations will be placed in **HKEY\_LOCAL\_MACHINE**.
- **user=yes** - then file associations will be placed in **HKEY\_CURRENT\_USER** and **HKEY\_LOCAL\_MACHINE**.

### Example

**PDFXEdit.exe /fileassoc:user=yes**

---

### **/importp**

This command launches **PDF-XChange Editor** and imports application settings from the specified file to the system registry or, in the case of portable applications, to a special settings file. The input file must be in the same format as the **/ExportP** command detailed below.

### Syntax

**/importp <filename>**

### Parameters

There are no available parameters for this command.

### Example

**PDFXEdit.exe /importp "c:\PXCEditor.MySettings.dat"**

---

### **/importsettings**

This command imports all settings from a file created by the **/exportsettings** command, or by the [Export Settings](#)<sup>[933]</sup> feature. This operation can also be achieved via the [Import Settings](#)<sup>[933]</sup> feature.

### Syntax

**/importsettings[:<parameters>] <filename>**

### Parameters

Note that all parameters support the values **yes**, **no**, **1**, **0**, **true** and **false**.

- **common** - imports common application options (but does not include the presets lists, trusted/untrusted locations and names or places). The default value is **true**.
- **presets** - imports the application presets lists, such as color management and scanner presets. The default value is **true**.
- **trustedlist** - imports the list of trusted/untrusted locations and names. The default value is **true**.
- **places** - imports the list of places (user-defined locations that are used to open files, such as **Dropbox** folders). The default value is **true**.
- **history** - imports the list of recently opened files. The default value is **true**. The value **merge** can be used to combine the existing history with the imported history.
- **stamps** - imports all custom stamps collections. The default value is **true**.
- **dsatemplates** - imports the digital signature appearance templates. The default value is **true**.
- **pluginsdata** - imports advanced plugins data. The default value is **true**.
- **signatures** - imports the list of signatures and initials. The default value is **true**.
- **all** - imports all settings. Note that this command line option can be customized using any of the available parameters. For example, **"/importsettings:all=yes;stamps=0"** imports all settings except stamps, and **"/importsettings:all=no;stamps=1"** imports only stamps. This command line does not have a default value because it is a combined option, but each option has its own default value, as detailed above.
- **settings** - imports all application settings (**common**, **presets**, **trustedlist** and **places**). This command line does not have a default value because it is a combined option, but each option has its own default value, as detailed above.

## Examples

```
PDFXEdit.exe /importsettings "c:\PDFXChangeEditorSettings.xces"  
PDFXEdit.exe /importsettings:history=merge "c:\PDFXChangeEditorSettings.xces"  
PDFXEdit.exe /importsettings:history=merge;stamps=yes;settings=no "c:  
\PDFXChangeEditorSettings.xces"
```

---

**/open** - please note that **/A** can also be used for this command.

This command opens documents from a specified file and determines the custom view location, search words and highlight rectangles as necessary.

## Syntax

```
/A <param1> = <value1> [;<param2> = <value2> [...]] [=OpenParameters] <filename>
```

## Parameters

- **nameddest= <destName>** – specifies a named destination in the PDF document.
- **page= <pageNum>** – uses an integer value to specify a numbered page in the document. The document's first page has a pageNum value of 1.
- **comment= <commentID>** – specifies a comment on a given page in the PDF document. Use the **page** parameter before this command. For example:
  - **page= 1;comment=452fde0e-fd22-457c-84aa-2cf5bed5a349**
- **zoom= <scale> [, <left>, <top>]** – sets the zoom and scroll factors using float or integer values. For example, a scale value of 100 indicates a zoom value of 100%. Scroll values left and top are in a coordinate system where 0,0 represents the top left corner of the visible page regardless of document rotation.
- **view= Fit|FitH[, <top>]|FitV[, <left>]|FitB|FitBH[, <top>]|FitBV[, <left>]** – sets the view of the displayed page using the keyword values defined in the PDF language specification. For more information, see the PDF Reference. Scroll values left and top are floats or integers in a coordinate system where 0,0 represents the top left corner of the visible page, regardless of document rotation. Use the **page** parameter before this command.
- **viewrect= <left>, <top>, <width>, <height>** – sets the view rectangle using float or integer values in a coordinate system where 0,0 represents the top left corner of the visible page, regardless of document rotation. Use the **page** parameter before this command.
- **pagemode= <bookmarks|thumbs|none>** – displays bookmarks or thumbnails. The default setting is **none**.
- **scrollbar= 1|0** – turns scrollbars on or off.
- **search= <wordList>** – opens the **Search** pane and performs a search for the words in the specified word list. All matching words are highlighted in the document. The words list must be enclosed in quotation marks and separated by spaces. It is only possible to search for single words. For example: **search= "sample search words"** will locate and highlight the words sample, search and words. When searching for multiple terms they must be adjacent in the content, i.e. separated by only white space/simple punctuation, or they will not be identified.
- **highlight= <left>, <right>, <top>, <bottom>** – highlights a specified rectangle on the displayed page. Use the **page** parameter before it. The rectangle values are integers in a coordinate system where 0,0 represents the top left corner of the visible page, regardless of document rotation.
- **fullscreen[=yes|no]** – when enabled, the document will open in full screen mode.
- **password= <password>** – specifies the password string to open silently a password-protected document.
- **usept[=yes|no]** – when specified, all values for positioning are absolute and measured in points (1/72 inch).

## Examples

**PDFXedit.exe /A zoom= 1000 "c:\example.pdf"**

```
PDFXedit.exe /A "page=255;zoom=200;pagemode=thumbs;search=lazy dog" "c:\example.pdf"
```

---

## /print

This command prints pages from specified documents.

### Syntax

```
/print[:[default[=yes|no]][;showui[=yes|no [;printer= <printername>]
[;pages= <pagesrange>]] <filename1> [<filename2> ... <filenameN>]
```

### Parameters

- **default** - if specified then default parameters will be used for printing. **PDF-XChange Editor** uses the most recently used print parameters by default.
- **showui** - if specified then the standard print dialogue will be displayed before printing. The default setting is that the application prints pages silently (without user interaction).
- **printer** - is used to specify the printer to be used. The default printer will be used when this option is not enabled.
- **pages** - is used to specify the page range to be printed. All pages of the active document will be printed when this option is not enabled.

### Example

```
PDFXedit.exe /print:default=yes;showui=yes;printer="PDF-XChange Printer" "c:\example.pdf"
```

---

## /resetsettings

This command resets the settings for **PDF-XChange Editor** on the local computer.

### Syntax

```
/resetsettings[:<parameters>]
```

### Parameters

Note that all parameters support the values **yes**, **no**, **1**, **0**, **true** and **false**.

- **common** - resets common application options (but does not include the presets lists, trusted/untrusted locations and names or places). The default value is **true**.
- **presets** - resets the application presets lists, such as color management and scanner presets. The default value is **true**.
- **trustedlist** - resets the list of trusted/untrusted locations and names. The default value is **true**.
- **places** - resets the list of places (user-defined locations that are used to open files, such as **Dropbox** folders). The default value is **true**.
- **prompts** - resets prompts and warning messages (the "do not show this message again" dialog boxes). The default value is **false**.
- **uilang** - resets the language of the user interface. The default value is **false**.
- **history** - resets the list of recently opened files. The default value is **true**.
- **stamps** - resets all custom stamps collections. The default value is **true**.
- **dsatemplates** - resets the digital signature appearance templates. The default value is **true**.
- **pluginsdata** - resets advanced plugins data. The default value is **false**.
- **signatures** - resets the list of signatures and initials. The default value is **false**.
- **all** - resets all settings. Note that this command line option can be customized using any of the available parameters. For example, **"/resetsettings:all=yes;stamps=0"** resets all settings except stamps, and **"/resetsettings:all=no;stamps=1"** resets only stamps. This command line does not have a default value because it is a combined option, but each option has its own default value, as detailed above.
- **settings** - resets all application settings (**common**, **presets**, **trustedlist**, **places**, **UILang** and **history**). This command line does not have a default value because it is a combined option, but each option has its own default value, as detailed above.

## Examples

```
PDFXEdit.exe /resetsettings "c:\PDFXChangeEditorSettings.xces"  
PDFXEdit.exe /resetsettings:history=yes "c:\PDFXChangeEditorSettings.xces"  
PDFXEdit.exe /resetsettings:stamps=yes;settings=no;history=yes "c:  
\PDFXChangeEditorSettings.xces"
```

---

## /runjs

This command launches JavaScript.

## Syntax

```
/runjs[:log[=yes|no]] <scriptfilename> [<filename1> ... <filenameN>]
```

## Parameters

- **log=yes|no** – if specified without a value, or the value is **yes**, then the application creates a log when this command is executed. The log file **\_RunJSLog.txt** will be added to the program folder on the local computer.
- **<scriptfilename>** – specifies the full path to the file that contains the JavaScript.

### Example

The following command line launches the JavaScript contained in the file "AddDraftStamp.js":

```
PDFXEdit.exe /runjs "c:\AddDraftStamp.js" "c:\example.pdf"
```

---

### /usep

This command instructs the application to use the input file as the source for all settings.

### Syntax

```
/usep[:readonly[=yes|no]] <filename>
```

### Parameters

- **readonly** – if specified then the input file with the application settings will be used as "read-only" and will not be changed when the application is closed.

### Example

```
PDFXEdit.exe /usep:readonly "c:\PXCEditor.MySettings.dat"
```

---

### /webassoc

This command determines the mime type (web browser) associations for **PDF-XChange Editor**.

### Syntax

```
/webassoc[:user=no|yes]
```

### Parameters

- **user=no** - then mime type associations will be placed in **HKEY\_LOCAL\_MACHINE**.

- **user=yes** - then mime type associations will be placed in **HKEY\_CURRENT\_USER** and **HKEY\_LOCAL\_MACHINE**.

## Example

**PDFXEdit.exe /webassoc:user=yes**

---

## 10.5.6 Document Tab Options



### Document Tab Options

Document tab options are available in the right-click shortcut menu of document tabs:

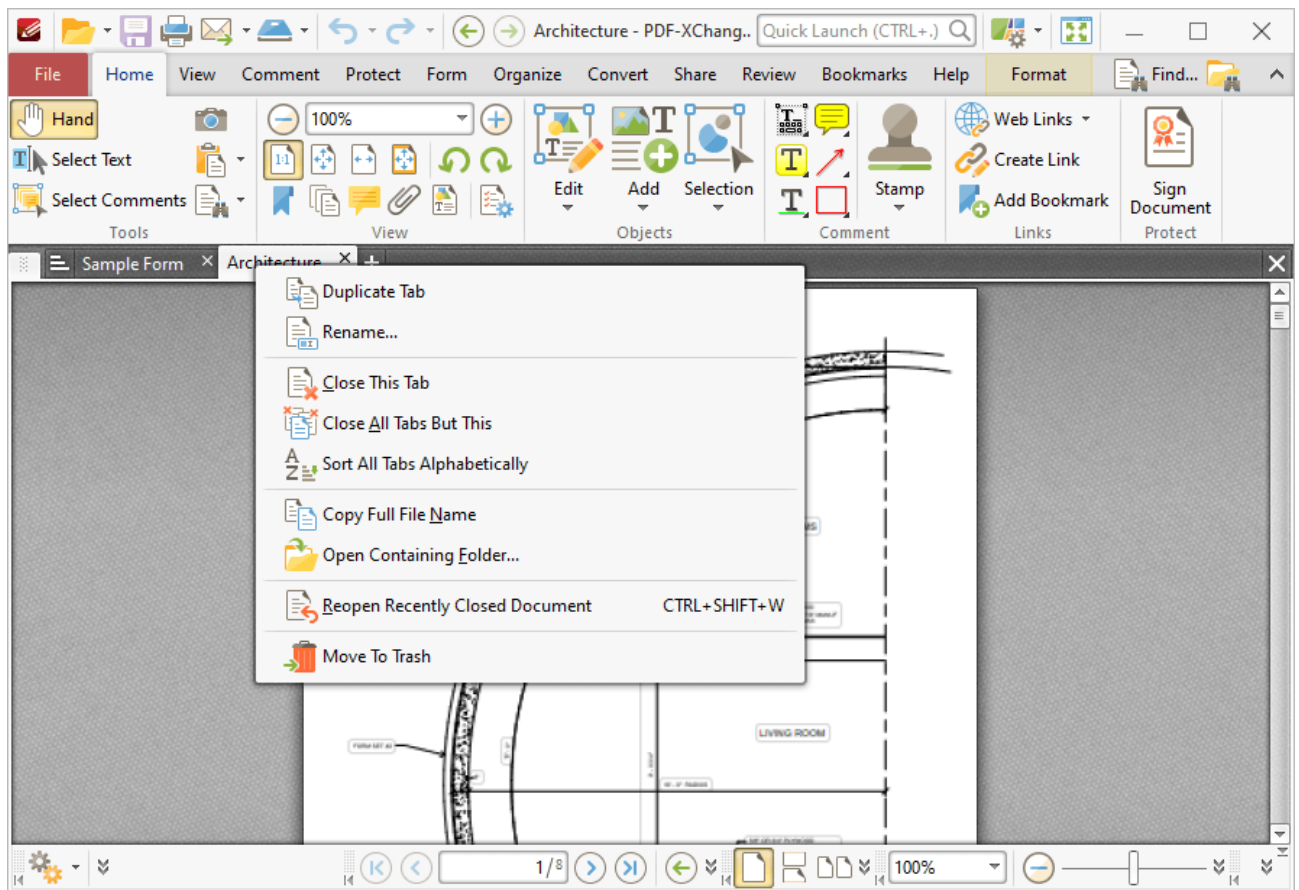

Figure 1. Document Tab Right-Click Shortcut Menu

- Click **Duplicate Tab** to duplicate the selected tab. A new window will open for the same document and the current page and layout options will be inherited.
- Click **Rename** to rename the document.
- Click **Close This Tab** to close the selected tab.
- Click **Close All Tabs But This** to close all tabs except the selected tab.
- Click **Close Tabs to the Right** to close all tabs on the right of the selected tab.



- Click **Close Tabs to the Left** to close all tabs on the left of the selected tab.
  - Click **Sort All Tabs Alphabetically** to sort all open tabs alphabetically.
  - Click **Copy Full File Name** to copy the full name of the selected file to the clipboard.
  - Click **Open Containing Folder** to open the containing folder of the selected file.
  - Click **Reopen Recently Closed Document** to reopen documents that were recently closed.
  - Click **Move to Trash** to move documents into the **Windows** recycle bin.
-

## 10.5.7 Editing Document Pages

---



### Editing Document Pages

---

Use the options detailed below to edit documents:

- The [Edit Content Tool](#)<sup>1638</sup> is used to select/edit document content such as images and text.
- The [Add Tool](#)<sup>1649</sup> is used to add text, images and barcodes to documents.
- The [Select Fields Tool](#)<sup>1265</sup> is used to select/edit form fields.
- The [Select Comments Tool](#)<sup>1067</sup> is used to select/edit comments and annotations.
- The [Content](#)<sup>1032</sup> pane is used to view/edit page content.
- The [Selection](#)<sup>946</sup> feature is used to edit selected content.

The [Edit Documents](#)<sup>643</sup> section contains comprehensive, step-by-step instructions on editing operations in **PDF-XChange Editor**.

---

## 10.5.8 Editing Text in Annotations



### Editing Text in Annotations

When tools that contain text options are being used, text settings are detailed in the **Format** tab. Available properties depend on the tool in use. All available properties are detailed below:

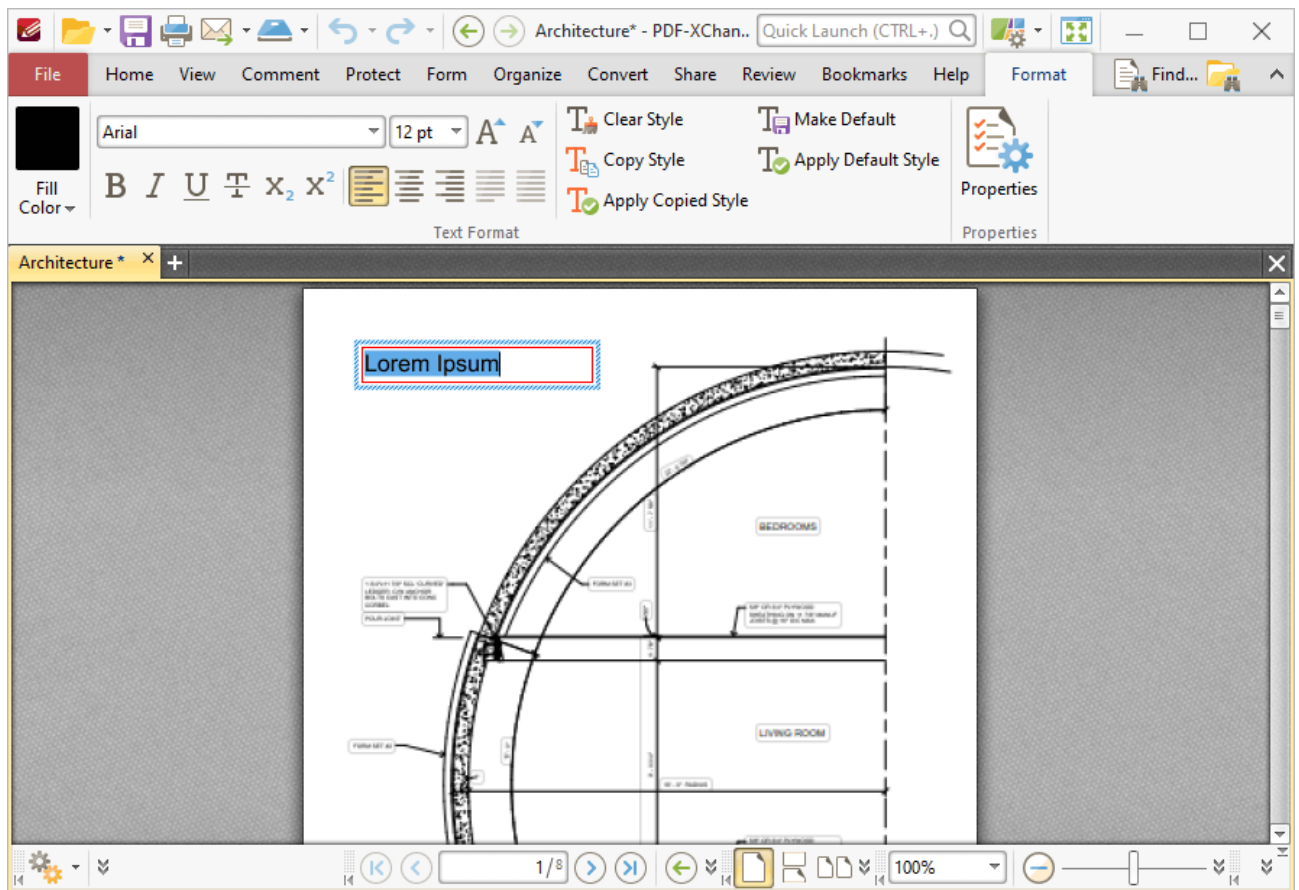



Figure 1. Format Tab, Text Editing Options

- Select an option in the **Fill Color** dropdown menu to determine the fill color of the text.
- Enter a font in the **Font** combo box, or use the dropdown menu, to determine the font of the text.
- Enter a value in the **Font Size** combo box, or use the dropdown menu, to determine the size of the text.

- Click **Grow Font/Shrink Font** to increase/decrease the size of the text.
- Click **Bold, Italic, Underline, Strikethrough, Subscript** or **Superscript** to enable/disable these text options.
- Click **Align Text Left, Center Text, Align Text Right** or **Justify Text** to adjust the alignment of text.
- Click **Clear Style** to revert text to the default style for the current tool.
- Click **Make Default** to set the current style as the default style for the current tool.
- Click **Copy Style** to copy the style properties of selected text. Use the **Apply Copied Style** feature detailed below to apply copied styles to text.
- Click **Apply Default Style** to apply the default text style for the current tool to selected text.
- Click **Properties** to open the [Properties](#)  pane, which can be used to view/edit the properties of selected text. The **Properties** pane contains two additional properties for editing text:
  - **Script Style** determines the script style of text:
    - **No** means that the text does not have a script style.
    - **Superscript** transforms selected text into superscript, which is used for specific purposes such as detailing chemical compounds.
    - **Subscript** transforms selected text into subscript, which is used for specific purposes such as detailing mathematical formulae.
  - **Char Spacing** determines how characters are spaced within the annotation. Enter a numerical value between 1 and 1000 in the number box to determine the spacing used.

Right-click text for further editing options:

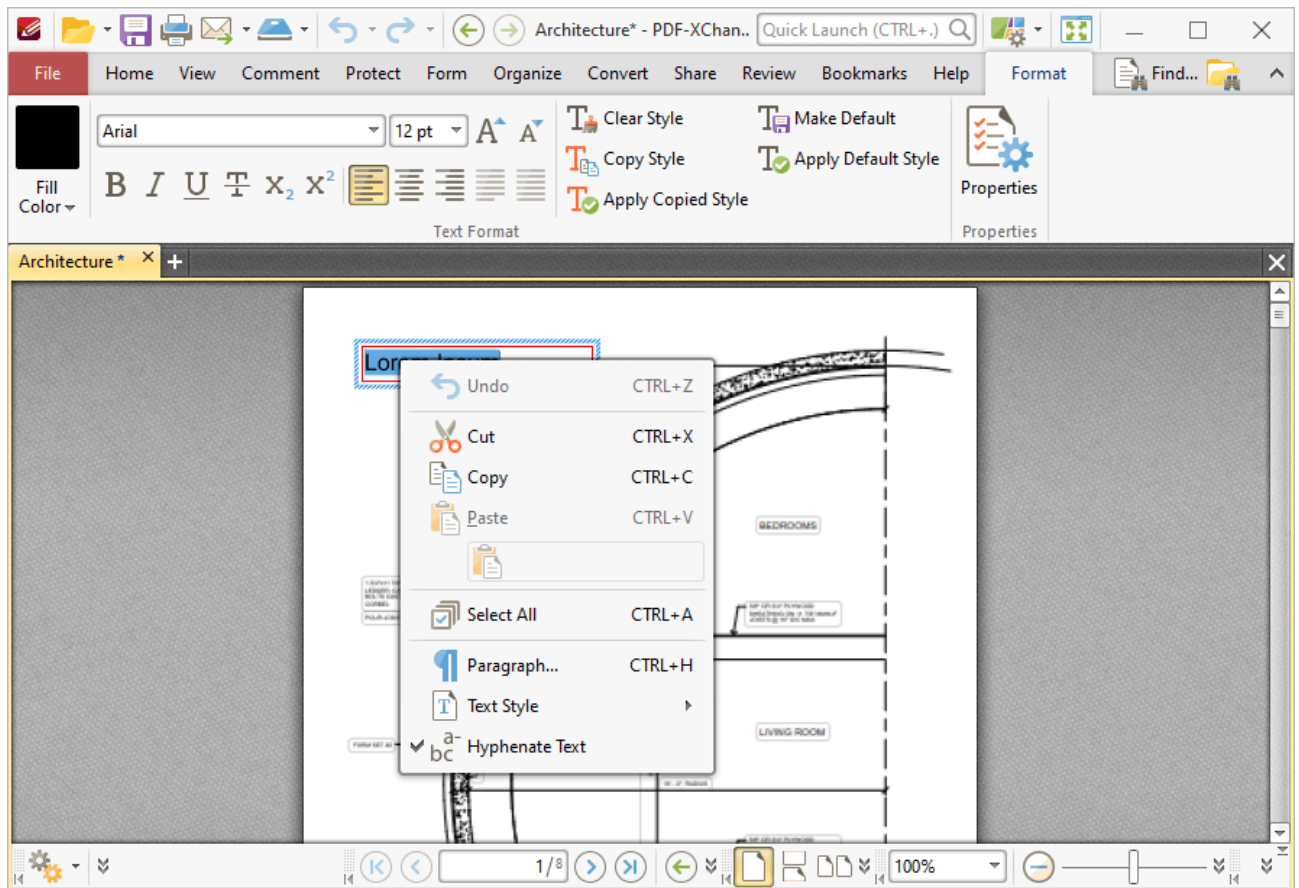

Figure 2. Text Editing Right-Click Submenu

- Click **Undo** to undo the most recent editing action.
- Click **Cut**, **Copy**, **Paste** or **Select All** to perform these editing options on selected text.
- Click **Paste as plain text** to paste text in the clipboard as plain text in the document.
- Click **Paragraph** to view/edit paragraph options:
  - Use the **Alignment** options to align text to the left/center/right or justify text.
  - Use the **Left** and **Right** indentation number boxes to determine the left and right indentation.
  - Use the **Special** dropdown menu to add indentation for the first line/hanging indentation.
  - Use the **Spacing** options to determine paragraph spacing.
- Click **Text Style** edit the style of selected text. These options are detailed in **(figure 1)**.
- Click **Hyphenate Text** to enable/disable text hyphenation for words at the end of lines.

## 10.5.9 Features Added in V8

---



### Features Added in V8

---

The following features were added in version 8 of **PDF-XChange Editor**:

#### Version 8.0.330.0

- Commands that convert line annotations to distance annotations, and polyline annotations to perimeter annotations. These commands are detailed [here](#)<sup>[1154]</sup> and [here](#)<sup>[1176]</sup> respectively.
- A new cropping method that enables the adjustment of the page size to the size of the crop box without changing the existing crop boxes. This feature is detailed [here](#)<sup>[1484]</sup>
- The **Move to Trash** feature, which moves open documents to the **Windows** recycle bin. This feature is detailed [here](#)<sup>[772]</sup>
- Simplified content transformation functionality added to the **Arrange** tab, as detailed [here](#)<sup>[1626]</sup>
- The **CSVtoPDF** plugin, which enables the conversion of CSV file data to PDF tables.
- The **Resource Updater** feature, which updates OCR languages, **Spell Check** dictionaries, and other resources.
- The **Overtyp**e mode for text edits, which is activated with the **Insert** key, as detailed [here](#)<sup>[1638]</sup>
- **Spell Check** dictionaries updated for the [Spell Check](#)<sup>[1545]</sup> feature.
- The **Paste as Plain Text** command for text edits, as detailed [here](#)<sup>[1638]</sup>
- Functionality that enables the creation/modification of '**Document Open**' actions to be different from '**GoTo**' actions, as detailed [here](#)<sup>[956]</sup>
- The **Quick Launch** toolbar, which is used to search for and execute commands, as detailed [here](#)<sup>[599]</sup>
- The **Enhanced OCR** module - an optional extra in **PDF-XChange Editor** that is much faster, provides better quality, recognizes text styles and tables, supports creating PDF files with editable text and images, and more. This feature is detailed [here](#)<sup>[1519]</sup> and you can read more about it [here](#).
- The "**OCR Selected Region**" feature, which makes it possible to perform optical character recognition on sections of documents selected via the **Snapshot** or **Crop** tools, as detailed [here](#)<sup>[1524]</sup>
- New **SharePoint** features that enable the specification of a default version and comment used during automatic check-in, and an option to auto-create the necessary folders when saving files to non-existing paths.

### Version 8.0.331.0

- Updated the **Enhance Scanned Pages** feature, which now has the option of avoiding the recompression of existing images when only deskew is used, as detailed [here](#).

### Version 8.0.332.0

- The **Rename Opened Document** feature, which makes it possible to rename open documents, as detailed [here](#).
- The **Create PDF Portfolio** feature, which makes it possible to create PDF portfolio files, as detailed [here](#).
- Information bar added at the bottom of the **Comments**, **Attachments**, **Bookmarks**, **Thumbnails** and **Links** pane.
- The **Sort Pages by Bookmarks** feature, as detailed [here](#).
- The **Remove Actions from Bookmarks** feature, as detailed [here](#).
- The **Create Links from Bookmarks** feature, which uses bookmarks to create links in document text, as detailed [here](#).
- Experimental PRC (Product Representation Compact) support added to the software, which enables the embedding of 3D content, as detailed [here](#).
- The ability to create new/modify existing 3D annotations, as detailed [here](#).
- Inline caption support added for line and dimensions annotations, as detailed [here](#).
- The option to make digital signatures long-term-validation enabled, as detailed [here](#).
- The **History** pane, which displays a list of the most recently opened documents and features advanced display/grouping options, as detailed [here](#).
- The **Enhanced OCR** module was updated to support vertical text and have the ability to skip check marks when scanning, as detailed [here](#).
- Functionality to reorder document tabs alphabetically, as detailed [here](#).

### Version 8.0.333.0

- Russian language added to the **Enhanced OCR** plugin.

### Version 8.0.334.0

- Functionality to save/open session files with relative paths, as detailed [here](#).
- Updated page selection options in the **Thumbnails** pane, as detailed [here](#).
- **Continuous Zoom** tool added to the software, as detailed [here](#).
- Added the ability to show/hide groups in the **History** pane.
- Functionality added to convert simultaneously from **PowerPoint** to PDF in **PDF-XChange Editor** and multiple instances of **PDF-Tools**.
- Functionality added to show 'actual' page numbers in dialog boxes. This is displayed in brackets on the right of the **Current Page** label.

- **Find and Redact** feature, which finds and redacts user-specified search terms in document text, as detailed [here](#).<sup>[1261]</sup>
- Functionality added that enables the opening of files from SharePoint via links in browsers and the **Open from URL** feature of **PDF-XChange Editor**.

### Version 8.0.335.0

- Functionality added to the **Hand Tool**.<sup>[943]</sup> that enables the selection of text and images.
- **Quick Launch** feature updated - it now highlights matching search results.
- The **Rasterize Pages** feature, which enables the customized rasterization all page content, comments and form fields, as detailed [here](#).<sup>[1534]</sup>
- **Google Send** and **Google Webmail** email providers added to the email features of the software, as detailed [here](#).<sup>[919]</sup>
- Added functionality that enables the marquee selection of text blocks in the **Edit Text Elements as Blocks** feature, as detailed [here](#).<sup>[1638]</sup>

### Version 8.0.336.0

- Added functionality that enables the use of drag and drop for moving commands from the **Quick Launch** toolbar to toolbars/menus.

### Version 8.0.337.0

- Functionality added that enables the flattening of layers, as detailed [here](#).<sup>[1024]</sup>
- Functionality added that enables the populating of forms from CSV data sheets, as detailed [here](#).<sup>[1431]</sup>
- **Outlook Webmail** added as an email provider, as detailed [here](#).<sup>[919]</sup>
- **Paste Special** feature implemented in the software, which enables the pasting of text in the clipboard to plain text and rich text formats.
- Added the **%[FolderTitle]** macro to the software, which is used for filename generation and inserts the title of the folder that contains the source file, as detailed [here](#).<sup>[1735]</sup>
- Added functionality that enables the pasting of text, rtf and images as new document pages. This can be performed via the **Thumbnails** pane, as detailed [here](#).<sup>[1000]</sup>

### Version 8.0.340.0

- Implemented support for custom cursor pointer sizes, which can be determined [here](#).<sup>[871]</sup>

---

## 10.5.10 Find

---





Click **Find** (or press Ctrl+F) to launch the **Find** function:

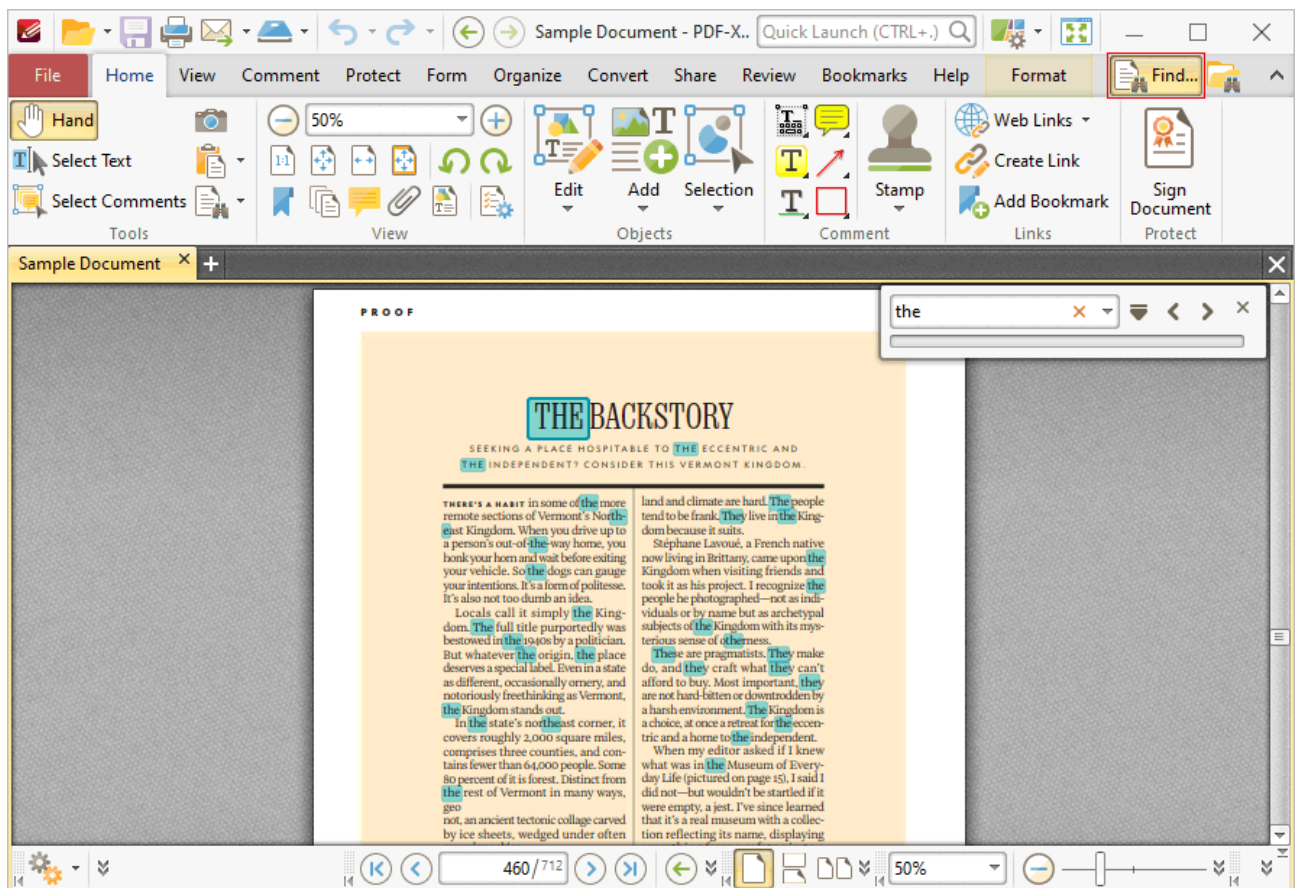

Figure 1. Find Function

The **Find** function is used to find specified text in the current document:



Figure 2. Find Function

- Enter the search terms in the text box and press enter to search the active document. Text that matches the search terms will be highlighted. Click the red 'x' icon, detailed in **(figure 1)**, to reset the search.

- Use the arrow in the text box to browse previous searches.
  - Use the second arrow to customize the parameters and location of searches.
  - Use the left and right arrow icons, or press F3/Shift+F3, to move backwards and forwards between search results.
-

### 10.5.11 Keyboard Shortcuts

---



## Keyboard Shortcuts

---

**PDF-XChange Editor** supports a number of keyboard shortcuts that can be used to activate commands:

| COMMAND  | SHORTCUT     |
|--|--------------|
| <b>Actual Size</b><br>Set the zoom level to 100% and show document pages at their actual size. | Ctrl+1       |
| <b>Add Bookmark</b><br>Create a new bookmark that points to the current page.                  | Ctrl+Shift+B |
| <b>Align Text Left</b><br>Align text to the left.  | Ctrl+L       |
| <b>Align Text Right</b><br>Align text to the right.  | Ctrl+R       |
| <b>Attachments</b><br>Show/Hide the <b>Attachments</b> pane.                                   | Ctrl+Shift+A |
|  |              |

|   |              |
|---|--------------|
| <p><b>Auto-Scroll</b><br/>Enable/Disable the auto-scroll feature.</p>   | Ctrl+Shift+H |
| <p><b>Back</b><br/>Navigate Backward.</p>   | Alt+Left     |
| <p><b>Bold</b><br/>Make the selected text bold.</p>   | Ctrl+B       |
| <p><b>Bookmarks</b><br/>Show/Hide the <b>Bookmarks</b> pane.</p>  | Ctrl+B       |
| <p><b>Calibrate Measurement</b><br/>Create a new scale for use with the measurement tools.</p>  | Ctrl+Shift+C |
| <p><b>Center Text</b><br/>Center selected text.</p>   | Ctrl+E       |
| <p><b>Close</b><br/>Close the active document.</p>  | Ctrl+W       |
| <p><b>Comments</b><br/>Show/Hide the <a href="#">Comments pane</a>. </p> | Ctrl+M       |
| <p><b>Contents</b><br/>Launch online manual.</p>  | F1           |
| <p><b>Copy</b><br/>Copy the selection to the clipboard.</p>   | Ctrl+C       |

|   |              |
|---|--------------|
| <b>Create New Document</b><br>Create a new, blank document.                               | Ctrl+N       |
| <b>Crop Pages</b><br>Redefine the visible area of the document.                           | Ctrl+Shift+T |
| <b>Cut</b><br>Copy the selection to the clipboard and remove it from the active document. | Ctrl+X       |
| <b>Delete</b><br>Delete the selection.  | Delete       |
| <b>Delete Pages</b><br>Delete pages from the active document.                             | Ctrl+Shift+D |
| <b>Demote Bookmarks</b><br>Demote the selected bookmarks.                                 | Alt+Right    |
| <b>Document Info Bar</b><br>Show/Hide the Document Info Bar.                              | Ctrl+Alt+I   |
| <b>Document Properties</b><br>Show the properties of the active document.                 | Ctrl+D       |
| <b>Edit Code Snippets</b>   | Ctrl+J       |

|   |                      |
|---|----------------------|
| Manage JavaScript code snippets.  |                      |
| <b>Edit Form</b><br>Edit/create form fields.  | Ctrl+Shift+7         |
| <b>Enable Hand Tool Temporarily</b><br>Override the active tool with the <b>Hand Tool</b>   | Press and hold Space |
| <b>Enable Snapping</b><br>Enable the snapping feature.  | Ctrl+Shift+;         |
| <b>Exclusive Mode</b><br>Enable/Disable exclusive mode for the active tool. Hold Shift to enable <b>Exclusive Mode</b> temporarily. | Ctrl+G, Ctrl+E       |
| <b>Exit</b><br>Exit the application.  | Ctrl+Q               |
| <b>Extract Pages</b><br>Extract pages from the active document.   | Ctrl+Shift+E         |
| <b>Fields</b><br>Show/Hide the <b>Fields</b> pane.  | Ctrl+I               |
| <b>Find</b><br>Find text in the active document.  | Ctrl+F               |

|  |           |
|--|-----------|
| <b>First Page</b><br>Move to the first page of the document.                               | Home      |
| <b>Fit Page</b><br>Fit the active page(s) to the document window.                          | Ctrl+0    |
| <b>Fit Visible</b><br>Fit the active page(s) according to width and exclude white margins. | Ctrl+3    |
| <b>Fit Width</b><br>Fit the active page(s) according to width and include white margins.   | Ctrl+2    |
| <b>Forward</b><br>Navigate forward.  | Alt+Right |
| <b>Full Screen Mode</b><br>View document in full screen.                                   | F11       |
| <b>Go to Bookmark</b><br>Move to the selected bookmark.                                    | Space     |
| <b>Go to Destination</b><br>Move to the selected bookmark.                                 | Space     |
| <b>Go to Next Entry</b>  | F3        |

|  |              |
|--|--------------|
| <p>Move to the next found item.<br/>(This is intended for use with the <a href="#">Find</a>  feature).</p>  |              |
| <p><b>Go to Page</b><br/>Move to specific page of the active document.</p>   | Ctrl+Shift+N |
| <p><b>Go to Previous Entry</b><br/>Move to previous found item.<br/>(This is intended for use with the <a href="#">Find</a>  feature).</p>                                      | Shift+F3     |
| <p><b>Hide All Comments</b><br/>Hide all comments in the active document.</p>  | Ctrl+Shift+8 |
| <p><b>Highlight Form Fields</b><br/>Highlight required form fields.<br/>A color background will be inserted.</p>   | Ctrl+Alt+H   |
| <p><b>Insert Pages</b><br/>Insert pages into the active document.</p>  | Ctrl+Shift+I |
| <p><b>Invert Selection</b><br/>Deselect the current selection and select unselected items.<br/>This shortcut is intended for use with the <a href="#">Editing Panes</a> .</p> | "Num **"     |
| <p><b>Italic</b><br/>Italicize selected text.</p>  | Ctrl+I       |
| <p><b>Justify Text</b></p>   | Ctrl+J       |



|   |          |
|---|----------|
| Justify selected text.  |          |
| <p><b>Last Page</b><br/>Move to the final page of the document.</p>   | End      |
| <p><b>Layers</b><br/>Show/Hide the Layers pane. The Layers pane shows the structure of the document's layers, allowing for their visibility to be altered.</p>                          | Ctrl+L   |
| <p><b>Menu Toolbar</b><br/>Show/Hide the <a href="#">Menu Toolbar</a>. Note that this toolbar is visible only in the Classic UI layout and not present in the Ribbon UI.</p>            | F9       |
| <p><b>Move Down</b><br/>Move the selected bookmark(s) down.</p>   | Alt+Down |
| <p><b>Move Up</b><br/>Move the selected bookmark(s) up.</p>   | Alt+Up   |
| <p><b>New Attachment</b><br/>Add a new attachment.</p>  | Insert   |
| <p><b>New Bookmark After Selected</b><br/>Creates a new bookmark after the selected bookmark. If no bookmark is selected then a new one is created at the end of the bookmark list.</p> | Insert   |

|  |                        |
|--|------------------------|
| <p><b>New Bookmark Before Selected</b><br/>Creates a new bookmark before the selected bookmark. If no bookmark is selected then a new one is created at the end of the bookmark list.</p>          | <p>Alt+Insert</p>      |
| <p><b>New Child Bookmark</b><br/>Creates a new bookmark as the first child of the selected bookmark. If no bookmark is selected then a new one is created at the end of the bookmark list.</p>     | <p>Ctrl+Alt+Insert</p> |
| <p><b>New Last Child Bookmark</b><br/>Creates a new bookmark as the last child of the selected bookmark. If no bookmark is selected then a new one is created at the end of the bookmark list.</p> | <p>Ctrl+Insert</p>     |
| <p><b>New Destination</b><br/>Assign the the current view as a new destination.</p>  | <p>Insert</p>          |
| <p><b>Next Document</b><br/>Move to the next open document.</p>  | <p>Ctrl+Tab</p>        |
| <p><b>Next Page</b><br/>Move to the next page of the active document.</p>  | <p>Ctrl+Right</p>      |
| <p><b>Open</b><br/>Open an existing document.</p>  | <p>Ctrl+O</p>          |

|   |                |
|---|----------------|
| <b>Override Document Colors</b><br>Display document colors according to the selected color scheme.  | Ctrl+Shift+6   |
| <b>Paste</b><br>Paste the clipboard content into the active document.   | Ctrl+V         |
| <b>Preferences</b><br>Launch the <b>Preferences</b> dialog box.   | Ctrl+K         |
| <b>Previous Document</b><br>Move to the previous document.  | Ctrl+Shift+Tab |
| <b>Previous Misspelling</b><br>Move to the previous misspelling. (This shortcut is intended for use with the <b>Spell Check</b> feature). | Alt+F7         |
| <b>Previous Page</b><br>Move to the previous page of the active document.   | Ctrl+Left      |
| <b>Print</b><br>Print the active document.  | Ctrl+P         |
| <b>Promote Bookmark</b><br>Promote the selected bookmark(s).  | Alt+Left       |
|   |                |

|  |                          |
|--|--------------------------|
| <p><b>Properties Pane</b><br/>Show/Hide the <b>Properties</b> pane for the selected object(s).</p>   | <p>Ctrl+`</p>            |
| <p><b>Properties Toolbar</b><br/>Show/Hide the <a href="#">Properties Toolbar</a>. Please note that the contents of this toolbar depends on selected content and/or active tool. Additionally, this toolbar is visible only in the Classic UI layout and not present in the Ribbon UI.</p> | <p>Ctrl+E</p>            |
| <p><b>Redo</b><br/>Reverse the most recent <i>undo</i> action.</p>   | <p>Ctrl+Y</p>            |
| <p><b>Rename</b><br/>Rename the selected item. Please note that this shortcut only works with items that have editable names, such as forms.</p>   | <p>F2</p>                |
| <p><b>Reopen Recently Closed Document</b><br/>Reopen closed documents.</p>   | <p>Ctrl+Shift+W</p>      |
| <p><b>Rotate Counterclockwise</b><br/>Rotate the current view counterclockwise. Please note that this feature is intended for viewing purposes - the original document is not modified.</p>  | <p>Ctrl+Shift+"Num-"</p> |
|  |                          |

|  |                          |
|--|--------------------------|
| <p><b>Rotate Clockwise</b><br/>         Rotate the current view clockwise. Please note that this feature is intended for viewing purposes - the original document is not modified.</p> | <p>Ctrl+Shift+"Num+"</p> |
| <p><b>Rotate Pages</b><br/>         Rotate pages of the active document.</p>   | <p>Ctrl+Shift+R</p>      |
| <p><b>Run</b><br/>         Run the script written in the console window.</p>   | <p>Ctrl+Enter</p>        |
| <p><b>Run Selection</b><br/>         Run selected script.</p>  | <p>Ctrl+Shift+Enter</p>  |
| <p><b>Save</b><br/>         Save the active document.</p>  | <p>Ctrl+S</p>            |
| <p><b>Save As</b><br/>         Save the active document with a new name/location.</p>  | <p>Ctrl+Shift+S</p>      |
| <p><b>Search Pane</b><br/>         Show/Hide the <b>Search</b> pane.</p>   | <p>Ctrl+Alt+F</p>        |
| <p><b>Select All</b><br/>         Select all text.</p>   | <p>Ctrl+A</p>            |
| <p><b>Show All Comments</b><br/>         show all comments in the active document.</p>   | <p>Ctrl+8</p>            |

|  |                     |
|--|---------------------|
| <p><b>Show Gaps Between Pages</b><br/>Show/Hide gaps between pages.</p>  | <p>Ctrl+Shift+G</p> |
| <p><b>Show Grid</b><br/>Inserts a grid into the document background to assist in content placement.</p>  | <p>Ctrl+'</p>       |
| <p><b>Show Guides</b><br/>Show/Hide guides to assist in content placement. Click and drag from rulers (see <b>Show Rulers</b>, below) to create guides.</p>  | <p>Ctrl+;</p>       |
| <p><b>Show JavaScript Console</b><br/>Show the JavaScript Console.</p>   | <p>Ctrl+J</p>       |
| <p><b>Show Rulers</b><br/>Show/Hide rulers. These can be used to determine the size of document content. The units of measurement for the rulers can be determined in the <a href="#">Measurement</a> preferences.</p> | <p>Ctrl+R</p>       |
| <p><b>Spell Check</b><br/>Activate the <b>Spell Check</b> feature and move to the first misspelling.</p>   | <p>F7</p>           |
| <p><b>Strikethrough</b><br/>Insert a line through selected text.</p>   | <p>Ctrl+Shift+S</p> |

|   |              |
|---|--------------|
| <b>Thin Lines</b><br>Enable/Disable the <b>Thin Lines</b> feature, which displays all lines used for editing purposes at a thickness of one pixel.                          | Ctrl+5       |
| <b>Thumbnails</b><br>Show/Hide the <b>Thumbnails</b> pane. This pane displays miniature previews of each page within active documents and enables simple document browsing. | Ctrl+T       |
| <b>Toggle All Command Panes</b><br>Show/Hide all toolbars and menus.  | Ctrl+F8      |
| <b>Toggle All Toolbars</b><br>Show/Hide all toolbars.   | F8           |
| <b>Underline</b><br>Underline selected text.  | Ctrl+U       |
| <b>Undo</b><br>Undo the most recent action.   | Ctrl+Z       |
| <b>Zoom In</b><br>Zoom in on the page.  | Ctrl+"Num+"  |
| <b>Zoom Out</b><br>Zoom out from the page.  | Ctrl+"Num-"  |
| <b>Zoom To</b>  | Ctrl+Shift+M |

|                         |  |
|-------------------------|--|
| Zoom to a custom level. |  |
|-------------------------|--|

Follow the steps below to customize keyboard shortcuts:

1. Click **Customize Toolbars** in the **Help** tab:

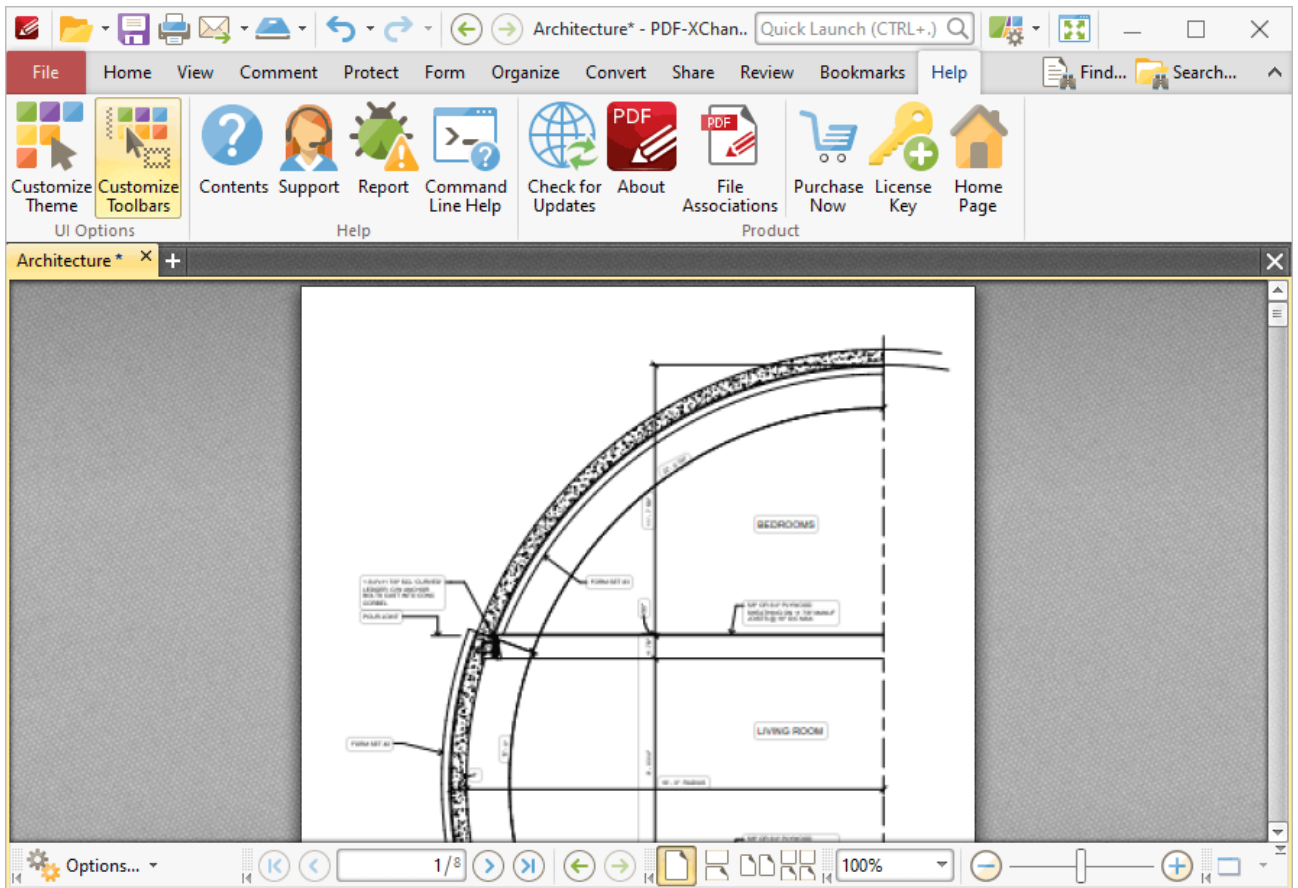
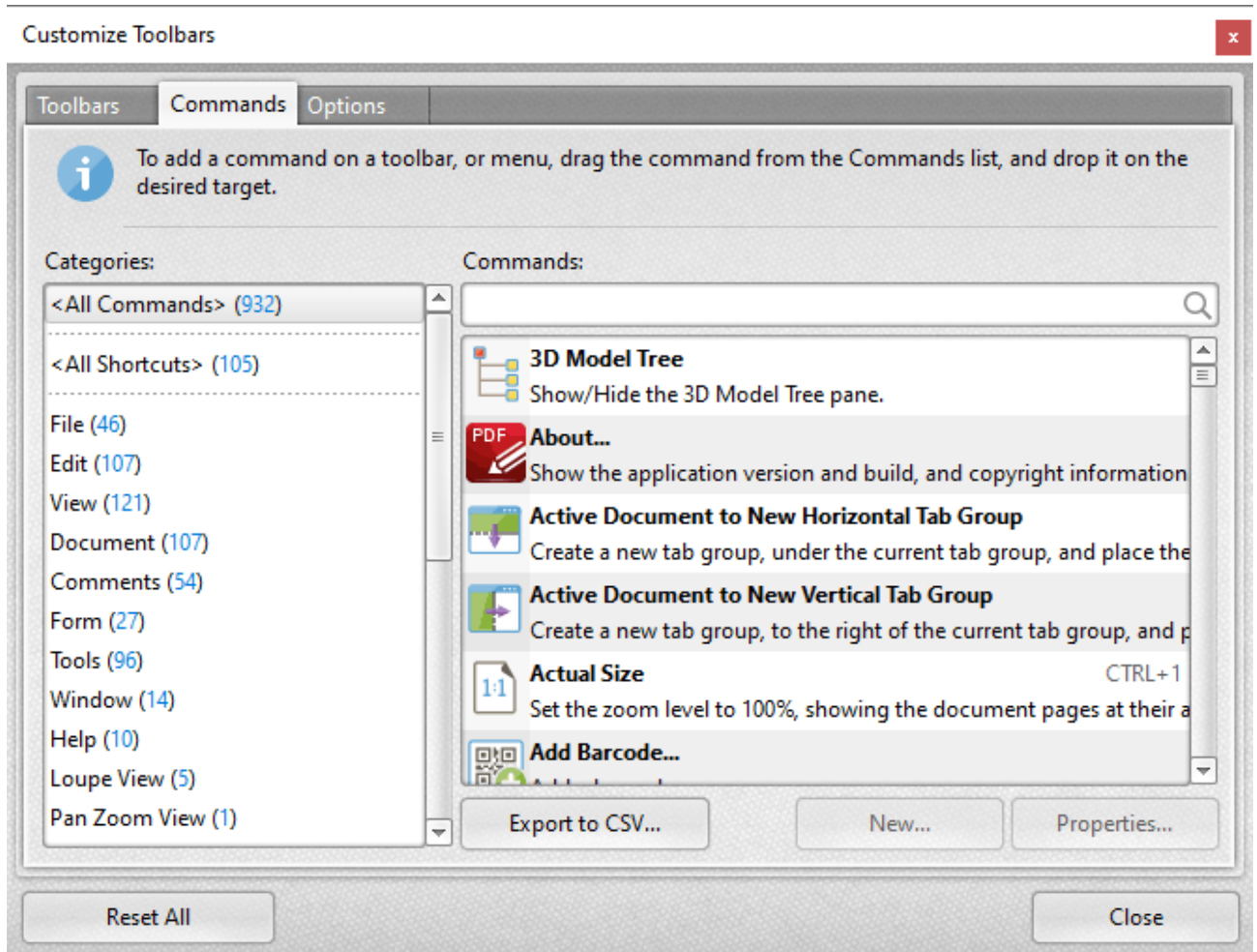

Figure 1. Help Tab, Customize Toolbars

The **Customize Toolbars** dialog box will open:

2. Click the **Commands** tab:





3. Use the **Categories** list to select a section of the application. (The default selection is **<All Commands>**, which means all available keyboard shortcuts are displayed). When sections are selected their actions and associated keyboard shortcuts are displayed in the list on the right.
4. Select an action and click **Properties**. The **Command Properties** dialog box for the selected action will open. The **Command Properties** dialog box for the **Add Bookmark** function is detailed below:

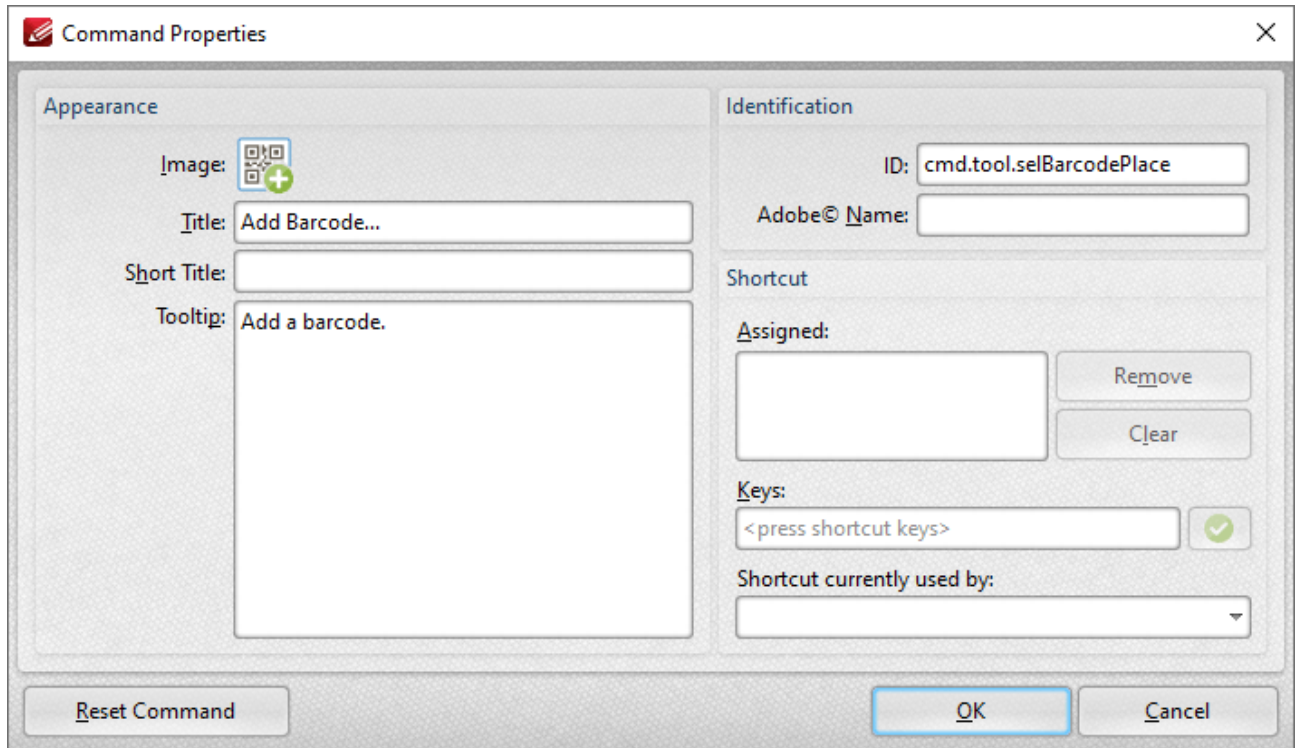

5. Assigned shortcuts are detailed in the **Assigned** pane. Use the **Keys** text box to determine new shortcuts and then press **OK**. (If entered key combinations are already in use then the associated feature will be displayed in the **Shortcut currently used by** text box).

## 10.5.12 Macros

---



### Macros

---

Macros are used throughout **PDF-XChange Editor**. 'Macro' is an abbreviation of 'macroinstruction' - a term in computer science for a rule that specifies how input characters should be entered to create corresponding output. This means that components of the output process can be simplified during the input process, which makes the work involved less intensive and more dynamic. Multiple macros can be used simultaneously as desired. The format for macros is:

**%[<Macro Name>]** or, when it is customizable: **%[<Macro Name>:<Parameter>]**. The **<Parameter>** step is optional.

For example, the **Page Number** macro can be used to specify the page numbering format. The syntax for the **Page Number** macro is **%[Page:<Parameter>]** and the following parameters are available:

- **'r'** specifies the use of lower-case roman numerals - **%[Page:r]**.
- **'R'** specifies the use of upper-case roman numerals - **%[Page:R]**.
- **'L'** specifies page labels as the page numbering format in cases where page labels have been specified. If page labels have not been specified then standard page numbers are used - **%[Page:L]**.
- **'<integer>** specifies the minimum number of digits used. This value can be any positive integer from 1 to 12 - for example **%[Page:4]** starts the page numbering as **"0001, 0002, 0003..."**.

When macros are available the macro icon is displayed:

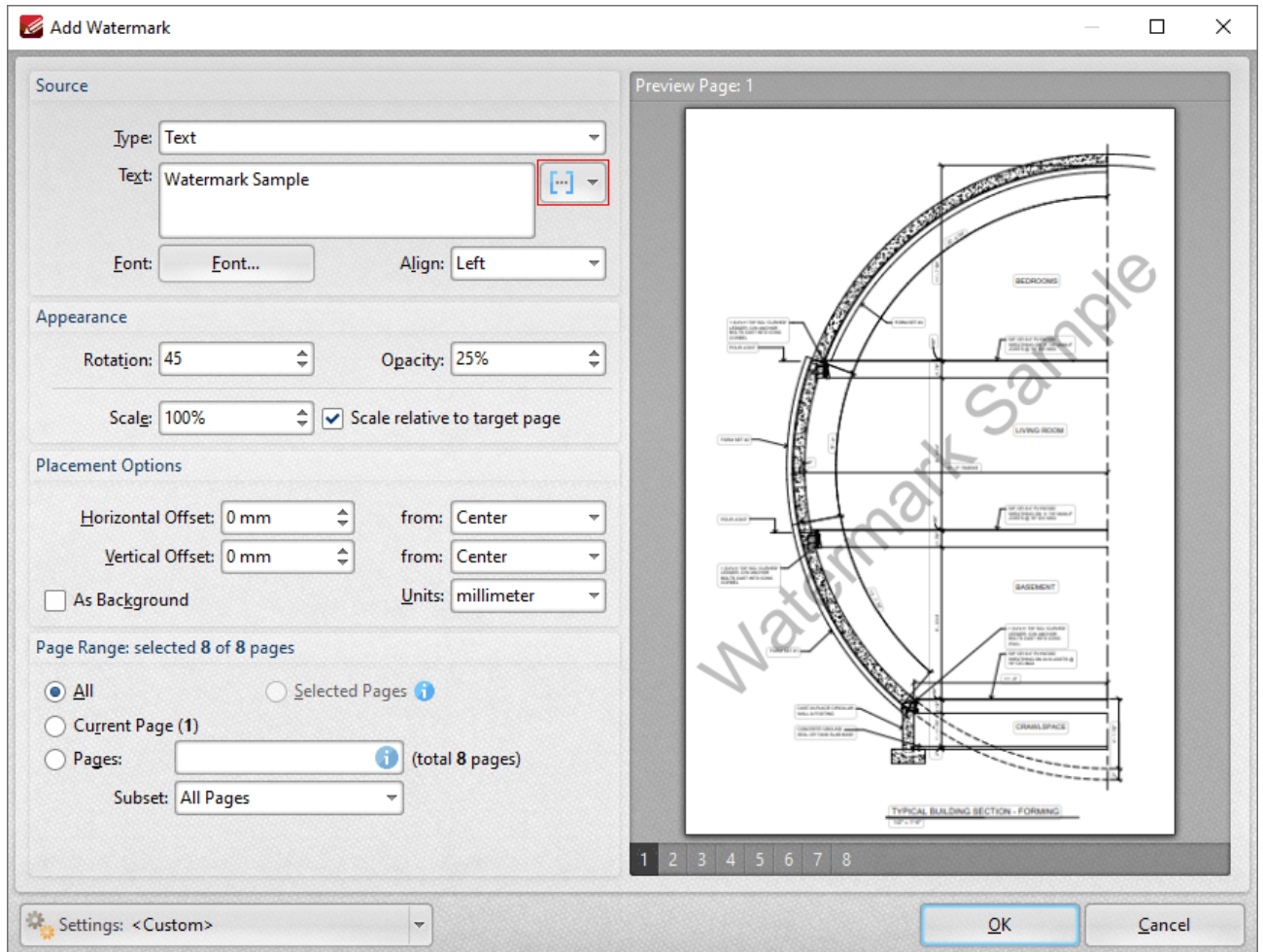























Figure 1. Macro Icon

Click the macro icon to view a list of available options, then click macros to add them to the associated text box. All available macros are detailed below:

- [Document Title](#)  1710
- [Document Index](#)  1718
- [Document Info](#)  1712
- [Page Number](#)  1721
- [Number of Pages](#)  1726
- [Filename](#)  1729
- [Folder Name](#)  1733
- [Folder Title](#)  1735
- [Date](#)  1737
- [Year](#)  1740
- [Month](#)  1742
- [Day](#)  1744
- [Time](#)  1746
- [Hour](#)  1749

- [Minute](#) 
- [Seconds](#) 
- [Computer Name](#) 
- [User Name](#) 
- [Environment Variable](#)  which has multiple options relating to the [environment variables](#) of the file.
- [Auto Number](#) 
- [Application Version](#) 

A list of macro-enabled operations is available [here](#). 

Please note that certain symbols are not compatible with macros and therefore are not permitted in document names. If inconsistencies occur between the name used when files are saved and the final file name then it is advised to change the name used when files are saved.

---

### 10.5.12.1 Document Title

---



#### Document Title

---

The **Document Title** macro inserts the document title.

The syntax for the this macro is **%[DocTitle]**

#### Example

Follow the steps below to use the **Document Title** macro to create a watermark from the document title:

1. Click the **Organize** tab.
2. Click **Watermarks**, then click **Add**. The **Add Watermark** dialog box will open.
3. Enter **%[DocTitle]** in the **Text** text box. The document title is then used as the watermark text:

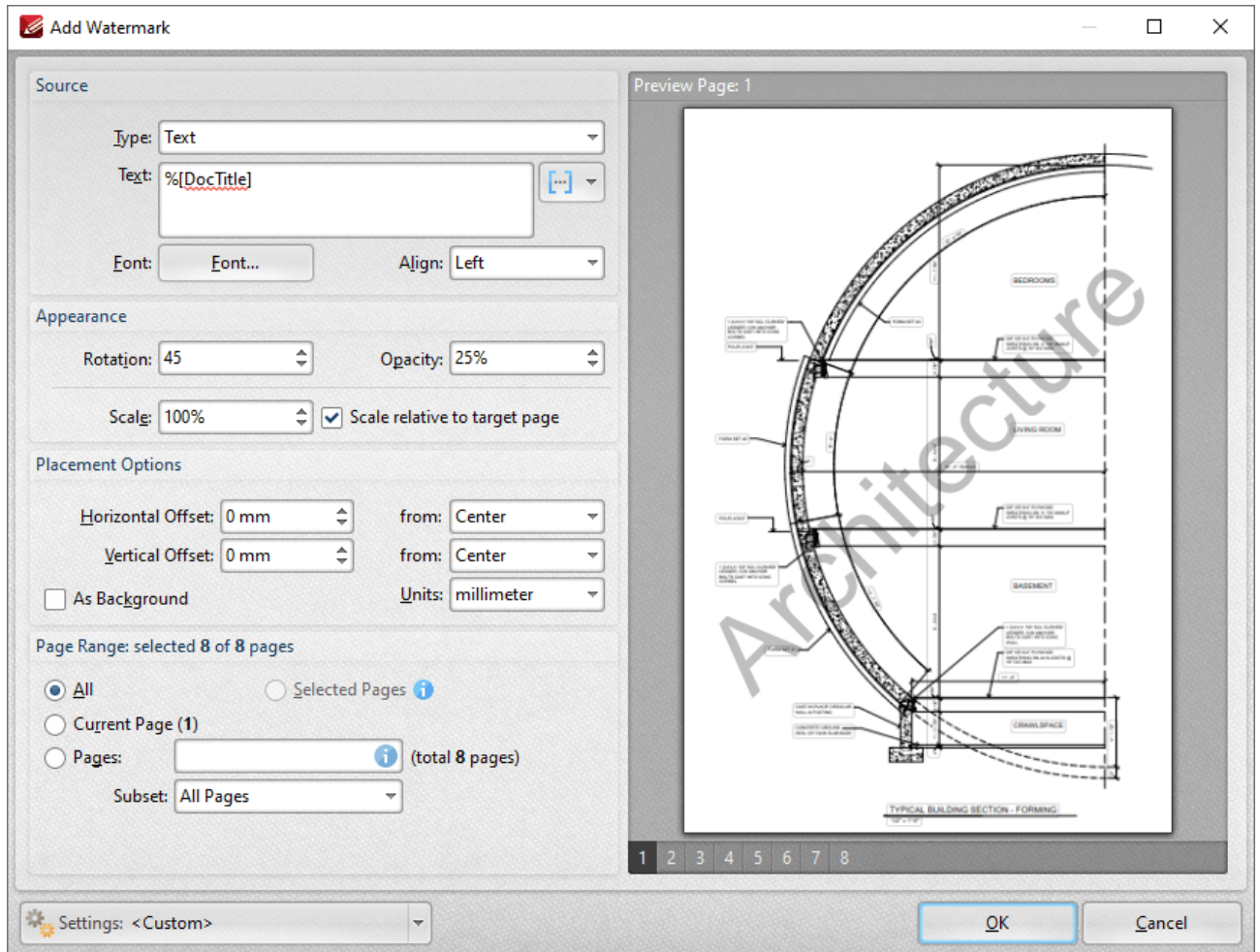

Figure 1. %[DocTitle] Macro Example

### 10.5.12.2 Document Info

---



## Document Info

---

The **Document Info** macro inserts document metadata information.

The syntax for this macro is **%[DocInfo]** and the following parameters are available:

- **Title** inserts the data in the **Document Title** field.
- **Author** inserts the data in the **Author** field.
- **Subject** inserts the data in the **Subject** field.
- **Keywords** inserts the data in the **Keywords** field.
- **Creator** inserts the name of the application used to create the document.
- **Producer** inserts the **PDF Producer** of the document.
- **CreationDate** inserts the date and time when the document was created, followed by the [UTC offset](#).
- **ModDate** inserts the date and time when the document was last modified, followed by the [UTC offset](#).

The syntax for this macro when parameters are used is **%[DocInfo:<Parameter>]** - see below for examples.

Note that the names of any standard fields from the document properties can be used as parameters for this macro. For example, entering the macro **%[DocInfo:Trapped]** inserts the current value of the **Trapped** field detailed [here](#).<sup>[850]</sup> Additionally, if parameters have been specified using the JavaScript console and custom names have been used to replace the standard names, then the custom names can be used.

Document properties can be viewed/edited in the **Document Properties** dialog box. Click the **File** tab, then click **Document Properties** to view this dialog box:



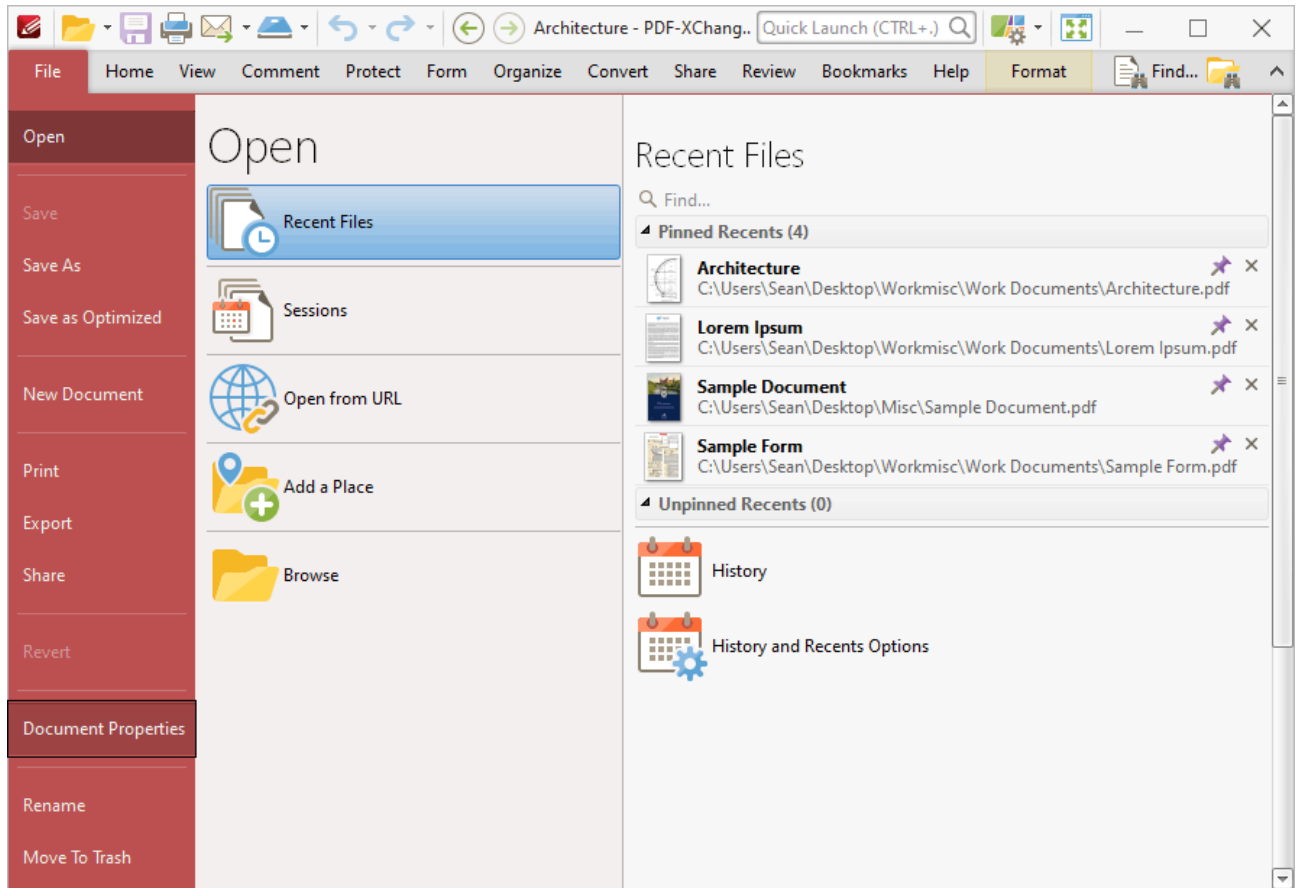

Figure 1. Document Properties Location

The **Document Properties** dialog box will open:

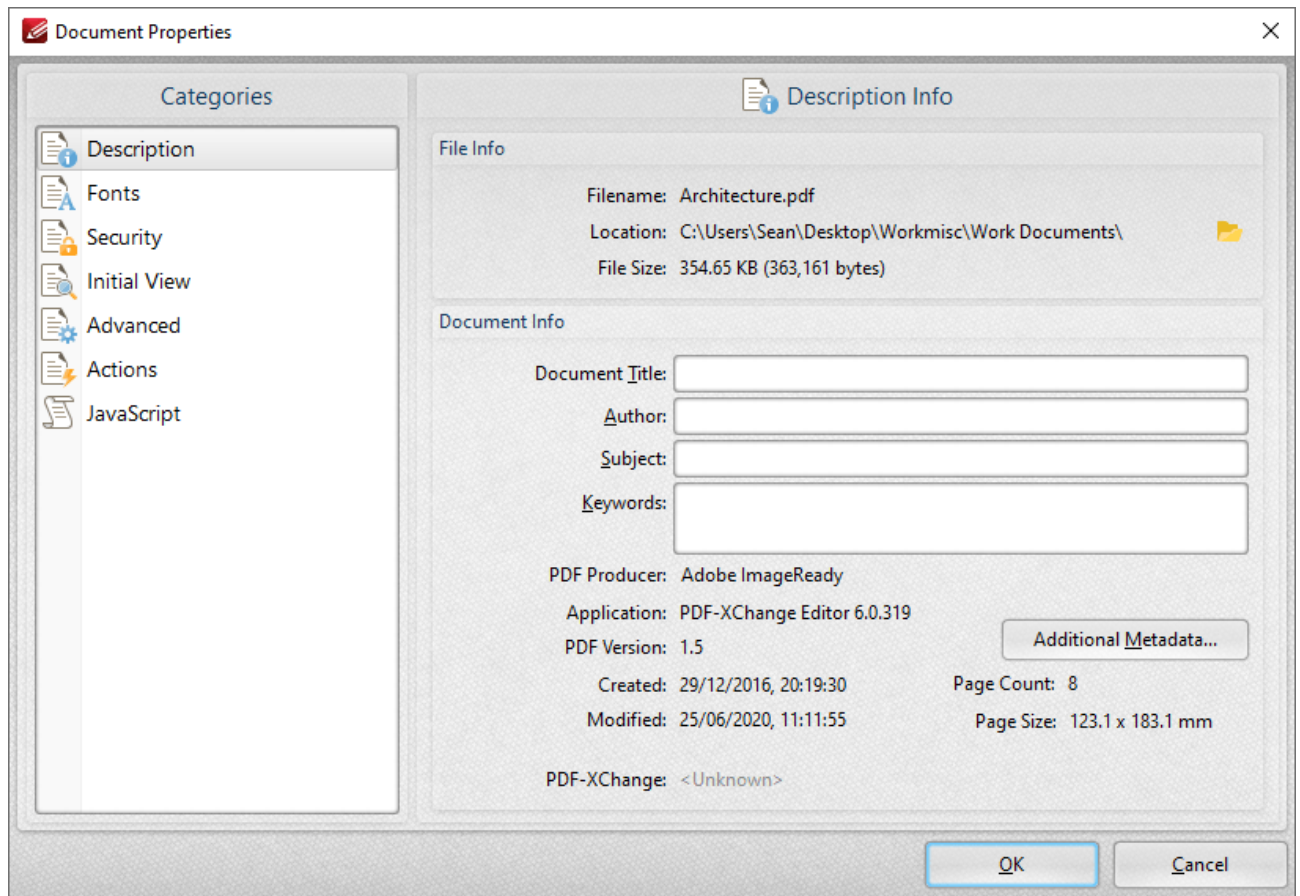

Figure 2. Document Properties Dialog Box

## Examples

Follow the steps below to use the **Document Info** macro to add Bates numbering that uses the date and time that the document was last modified:

1. Click the **Organize** tab.
2. Click **Bates Numbering**, then click **Add**. The **Add Bates Numbering** dialog box will open.
3. Enter **%[DocInfo:ModDate]** in the desired text box. The date and time the document was last modified is then inserted as Bates numbering:

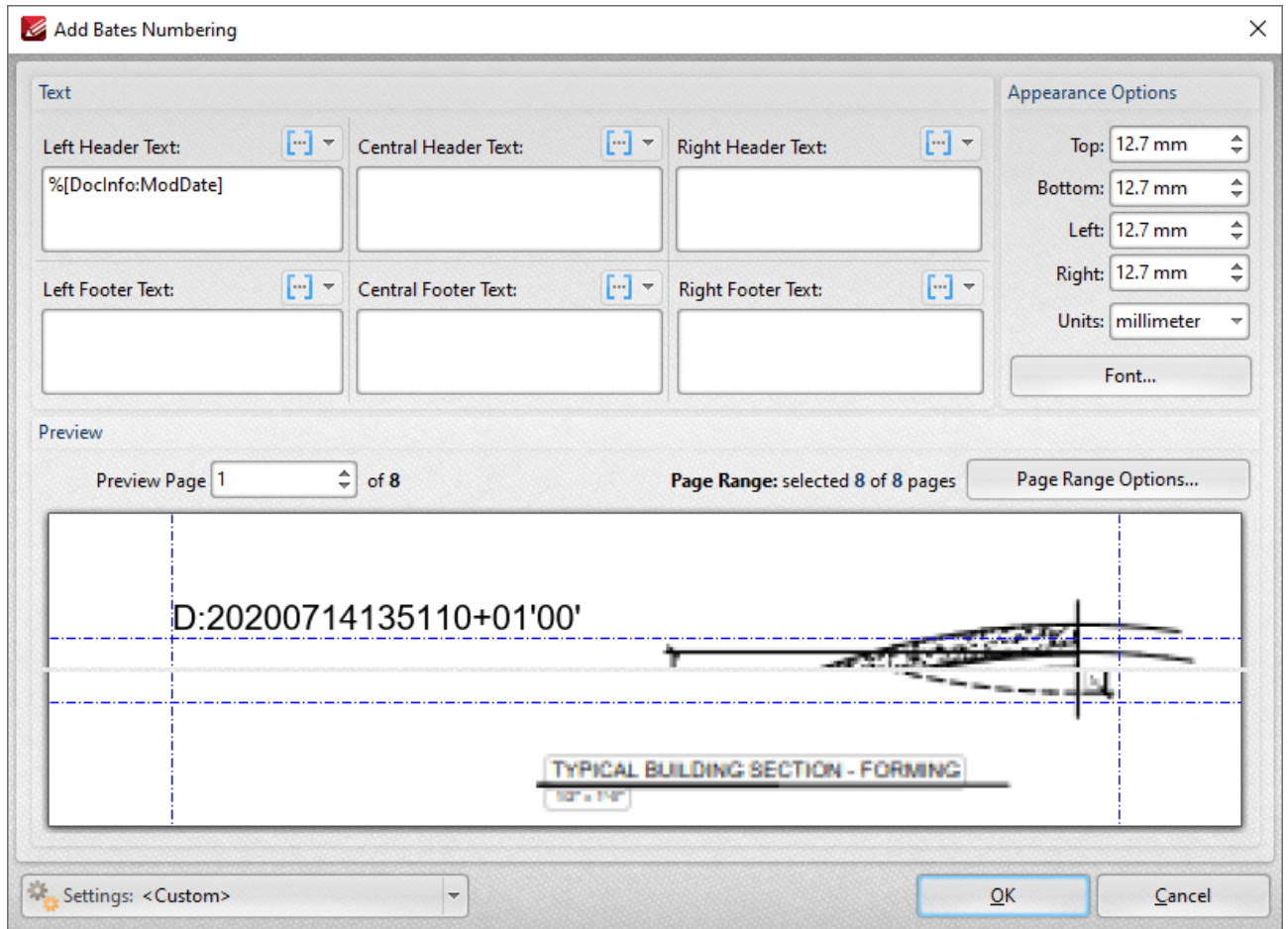

Figure 3. %[DocInfo] Macro Example

Alternatively, enter **%[DocInfo:Title]** to insert the document title:

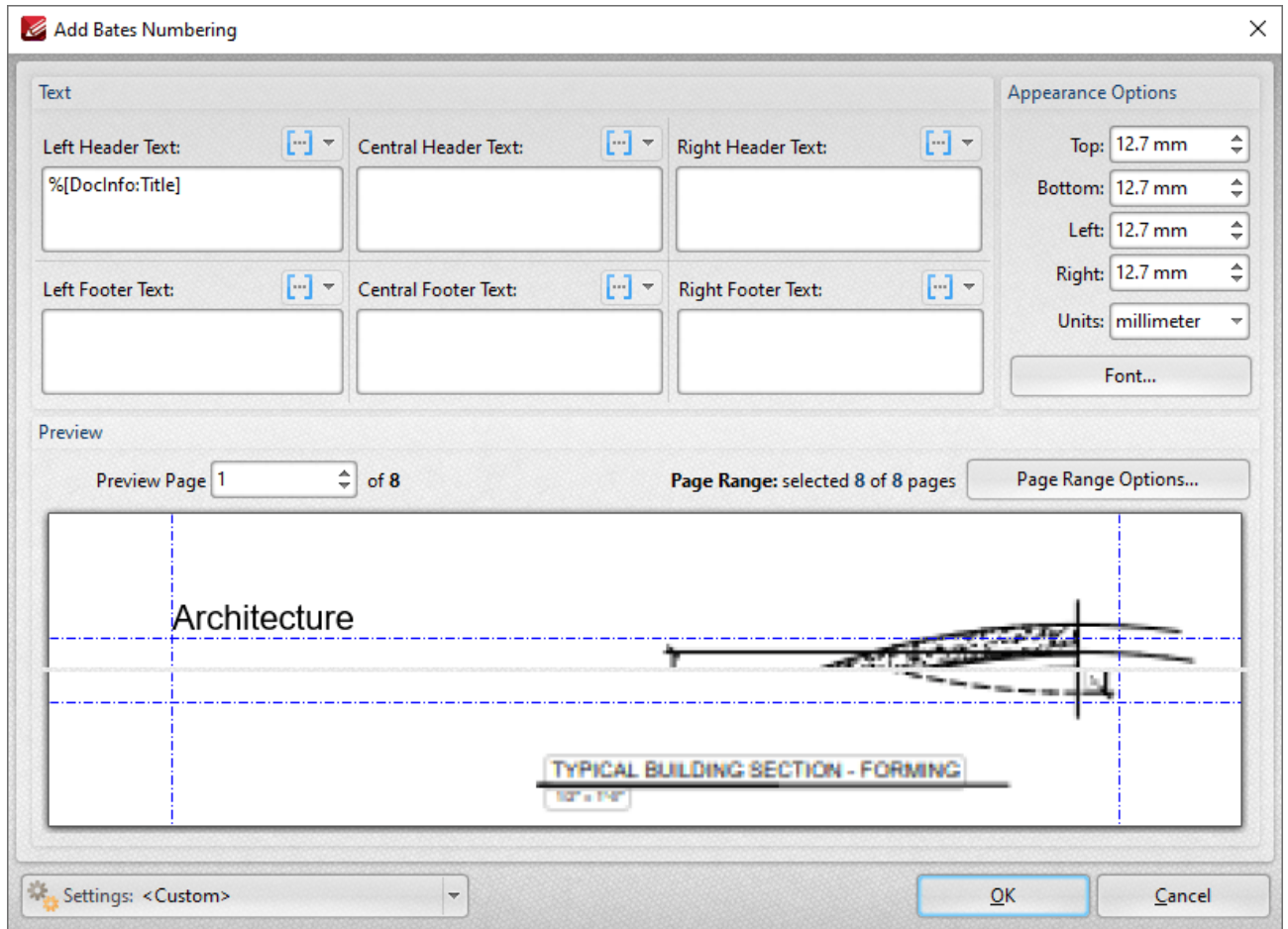

Figure 4. %[DocInfo] Macro Example Two

Note that it is possible to use more than one macro at a time. For example the text **%[DocInfo:Title]**, **%[DocInfo:Author]** returns both the document name and the author name:

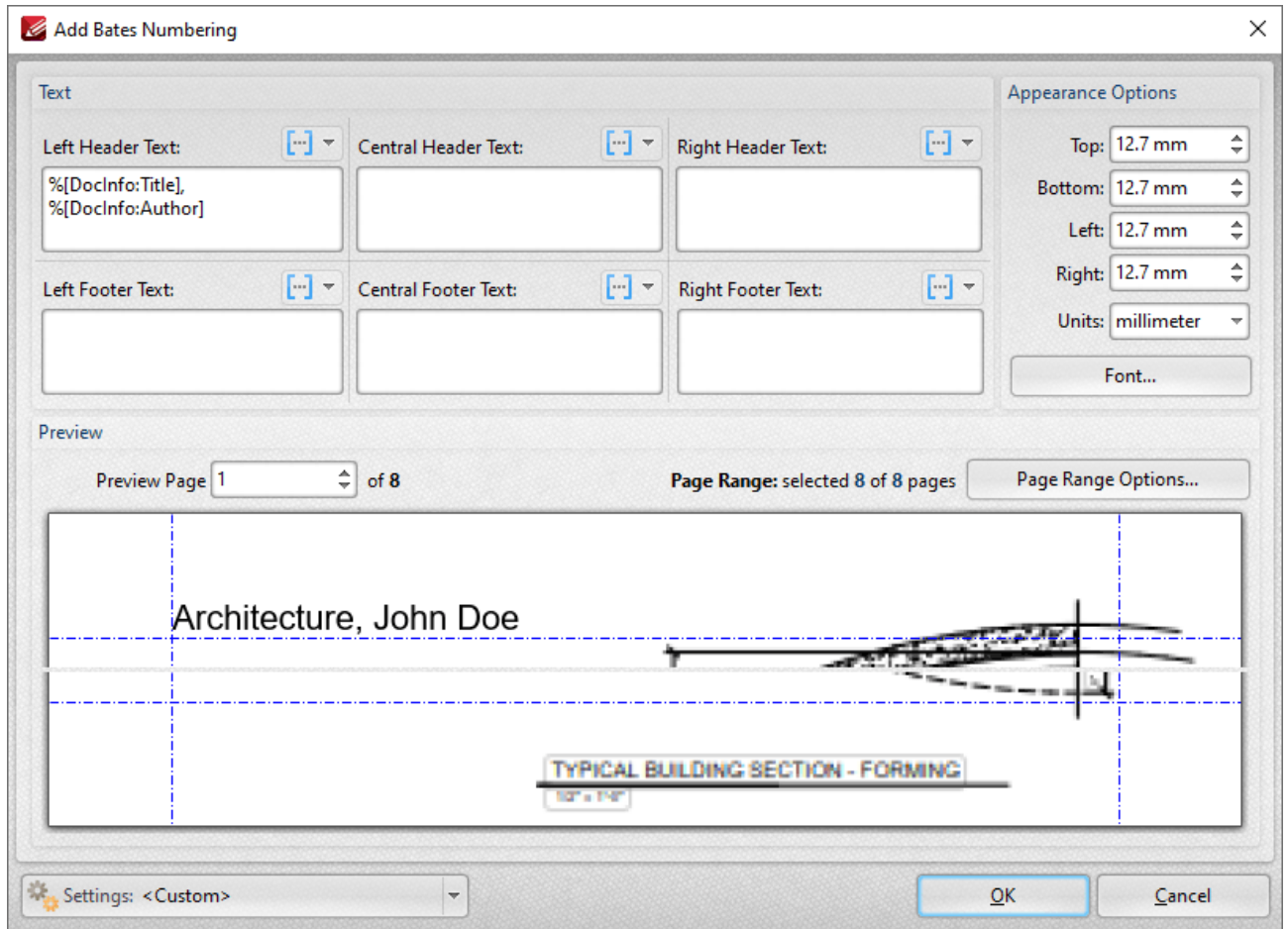

Figure 5. %[DocInfo] Macro Example Three

### 10.5.12.3 Document Index

---



## Document Index

---

The **Document Index** macro inserts the index value of pages, which is the input/output order of the content in the context of a group of input/output content items.

The syntax for this macro is **%[DocNumber]** and a parameter is available for the specification of the minimum amount of digits used for numbering output. This value can be any positive integer from 1 to 12. If the parameter is not used then the output is numbered with the default settings, which uses the page number of source files as the output number.

The syntax for this macro when parameters are used is **%[DocNumber:<Parameter>]** - for example **%[DocNumber:4]** starts the numbering as "0001, 0002, 0003...".

### Example

Follow the steps below to use the **Document Index** macro to extract each page of a document to a new document that uses the page number of source pages as the title of the output documents:

1. Click the **Organize** tab, then click **Extract Pages**. The **Extract Pages** dialog box will open.
2. Specify a page range to be extracted. This example will extract pages 6-10 of a ten page document.
3. Select **Save each page to a separate file** in the **Type** dropdown menu, then enter the macro **%[DocNumber:5]** in the **Filename** text box:

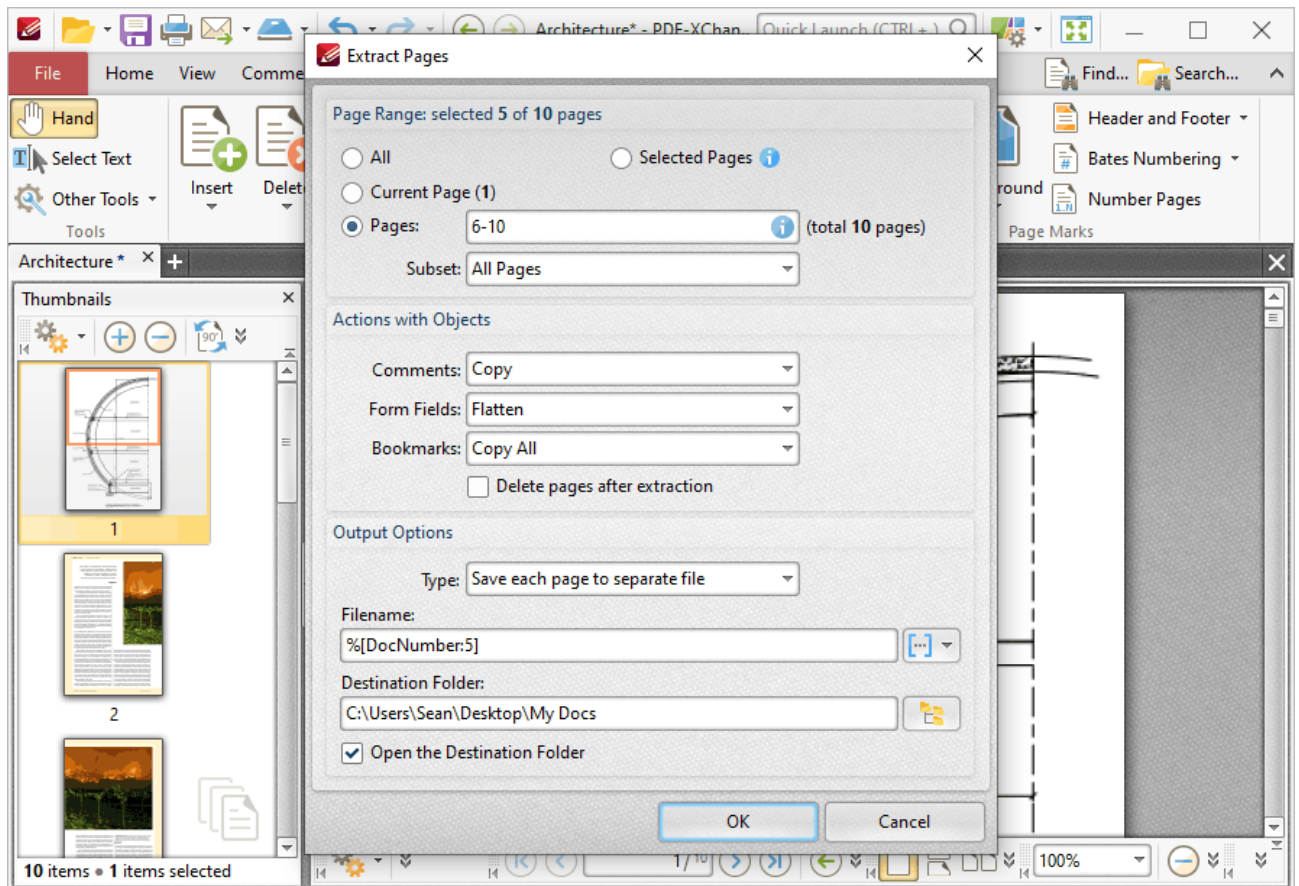
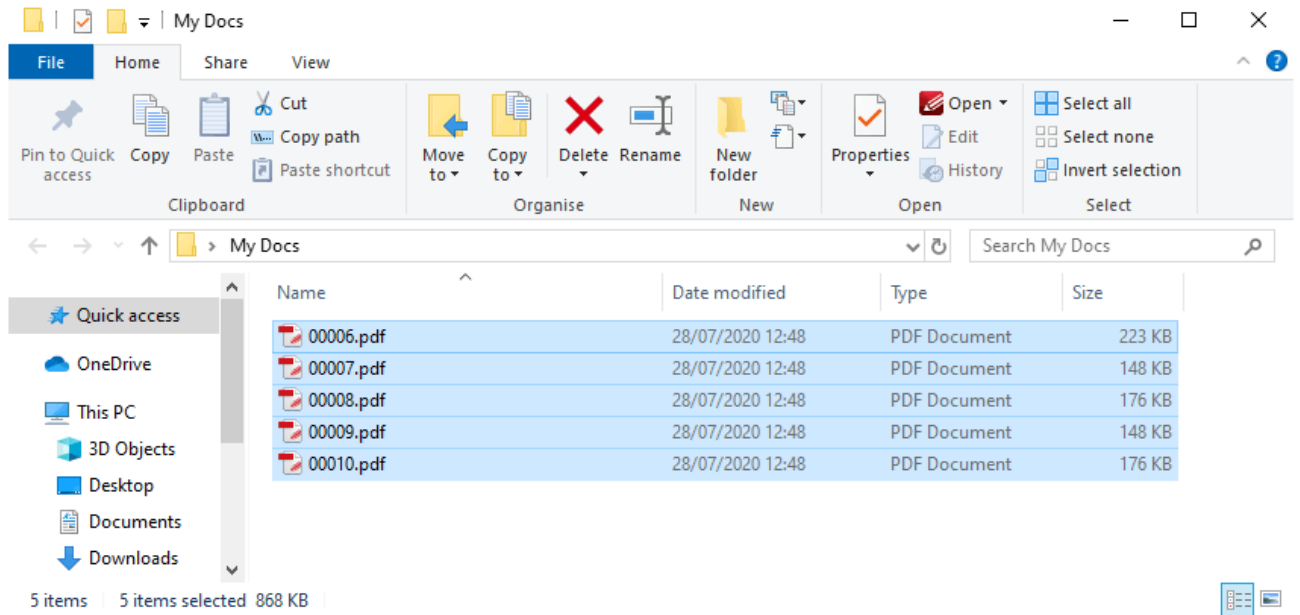

Figure 1. Extract Pages Dialog Box, Organize Tab

4. Click **OK**.

A new document will then be made for each specified page of the source document. The names of the new documents will be the page numbers of the source pages. The parameter '5' was used, therefore five digits are used for each document title:



**Figure 2.** %[DocNumber] Macro Output Folder



#### 10.5.12.4 Page Number

---



### Page Number

---

The **Page Number** macro inserts the page number of source pages.

The syntax for this macro is **%[Page]** and two sections of parameters are available.

The first section determines the format of page numbers:

- 'r' specifies the use of lower-case roman numerals.
- 'R' specifies the use of upper-case roman numerals.
- 'L' specifies page labels as the page numbering format in cases where page labels have been specified. If page labels have not been specified then standard page numbers are used.
- '<integer>' specifies the minimum number of digits used. This value can be any positive integer from 1 to 12 - for example **%[Page:4]** starts the numbering as "0001, 0002, 0003...".

The second section determines the starting value for page numbers, and must therefore be an integer.

Please note that a semicolon must be used to delimit the sections of parameters. If the second section is not used then the semicolon can be omitted. However, if the first section is not used and the second section is used, then it is necessary to use a semicolon.

The syntax for this macro when both parameters are used is **%[Page:<Parameter 1>;<Parameter 2>]**

The syntax for this macro when only the second parameter is used is **%[Page;;<Parameter 2>]**

### Examples

Follow the steps below to use the **Page Number** macro to insert page numbers as Bates numbering:

1. Click the **Organize** tab.
2. Click **Bates Numbering**, then click **Add**. The **Add Bates Numbering** dialog box will open.
3. Enter **%[Page]** in the desired text box. Page numbers are then inserted as Bates numbering:

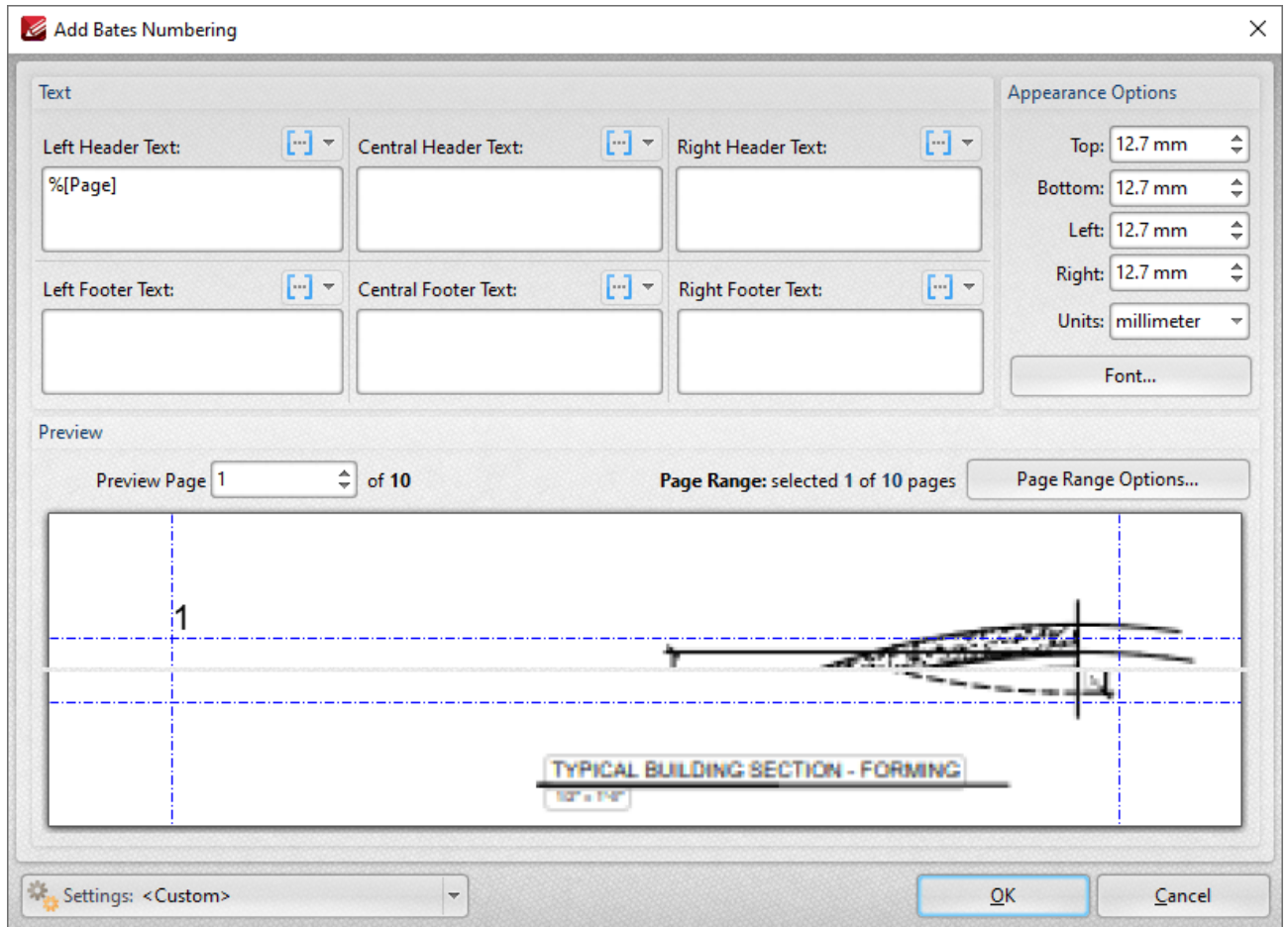

Figure 1. %[Page] Macro Example

Alternatively, enter **%[Page:R]** to specify the use of upper-case roman numerals:

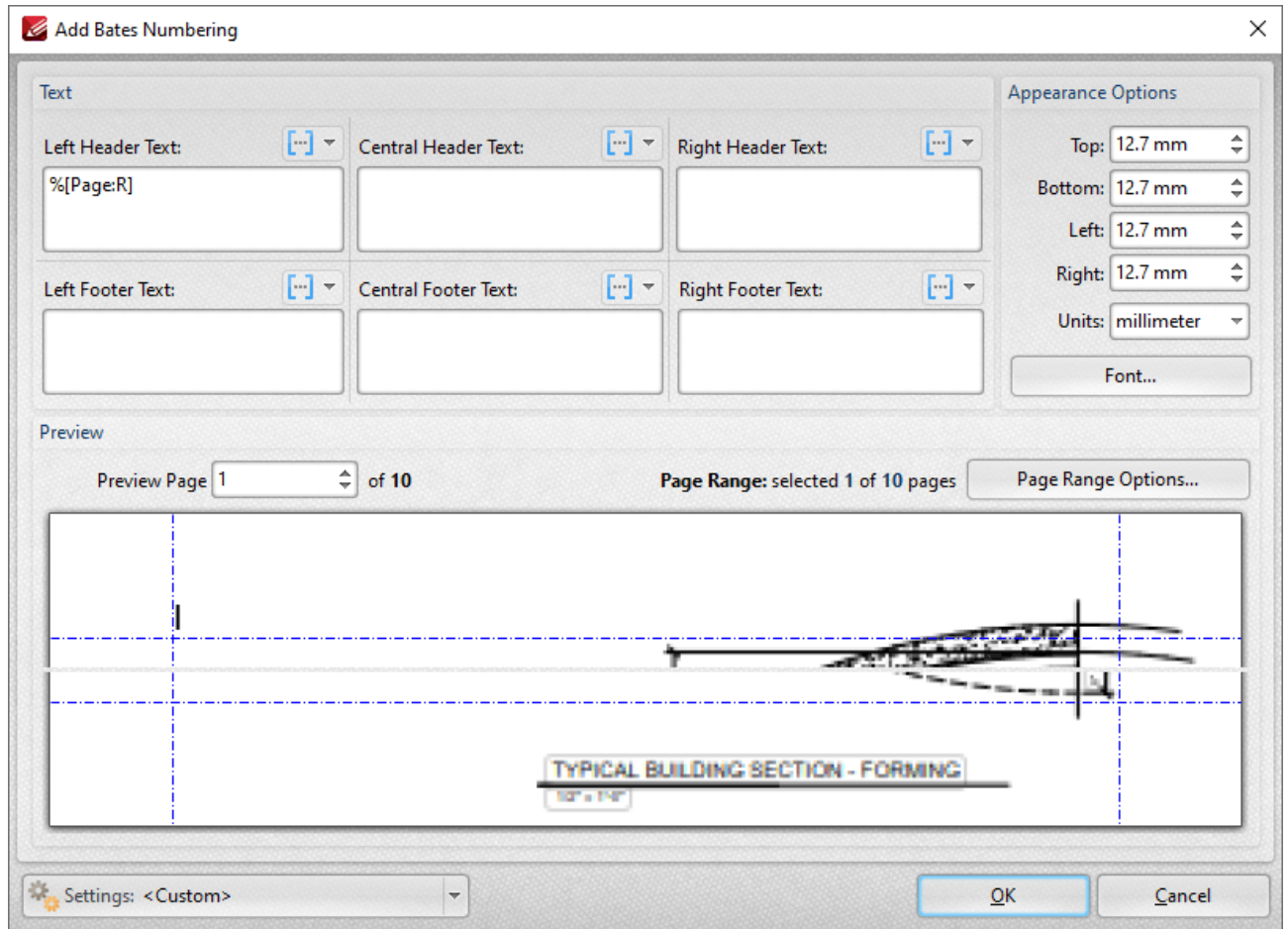

Figure 2. %[Page] Macro Example Two

Alternatively, enter **%[Page:4;10]** to specify a minimum of four digits for output values and a starting value of ten:

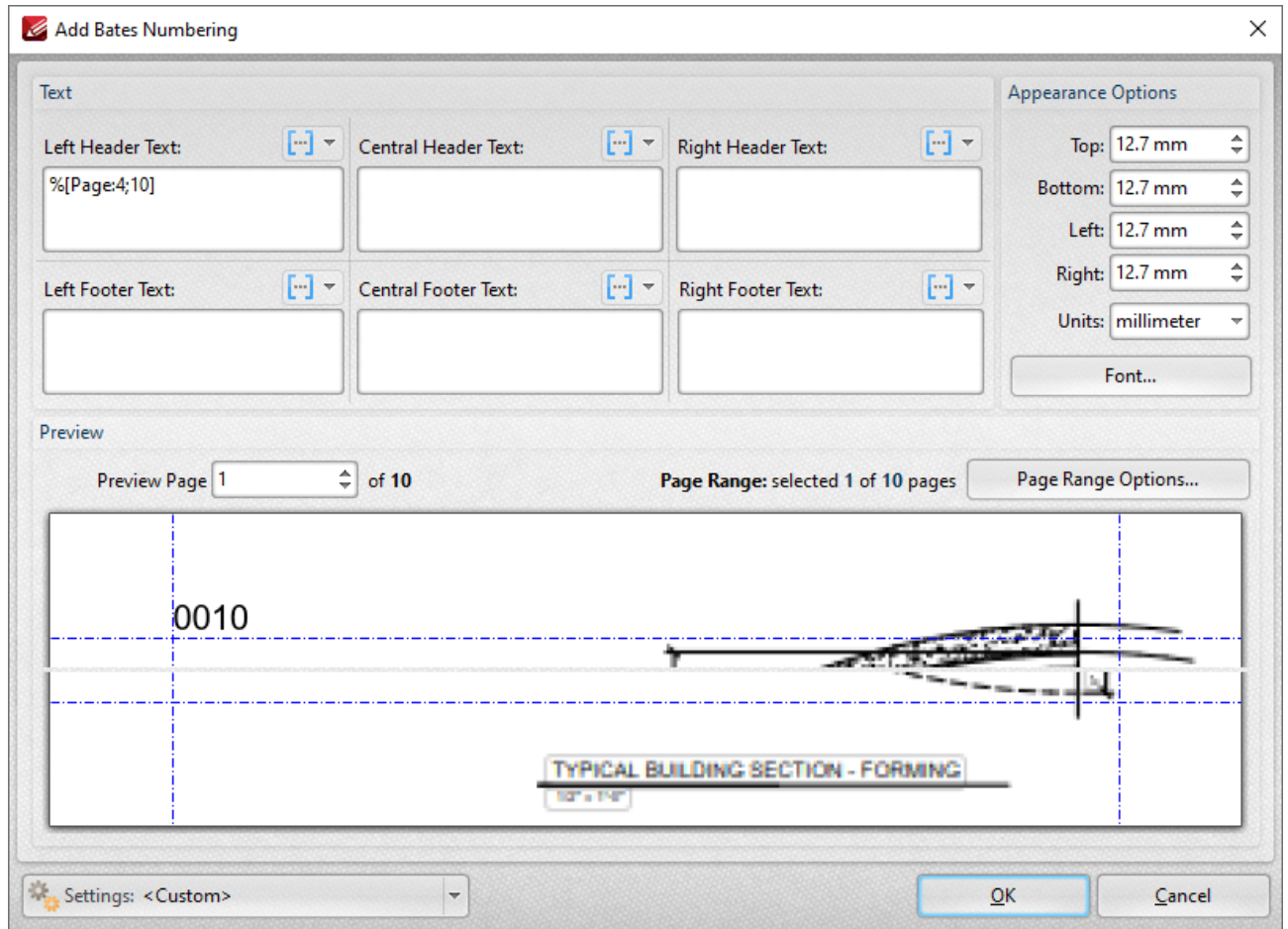

Figure 3. %[Page] Macro Example Three

Alternatively, enter **%[Page::5]** to omit the first parameter and specify a starting value of five:

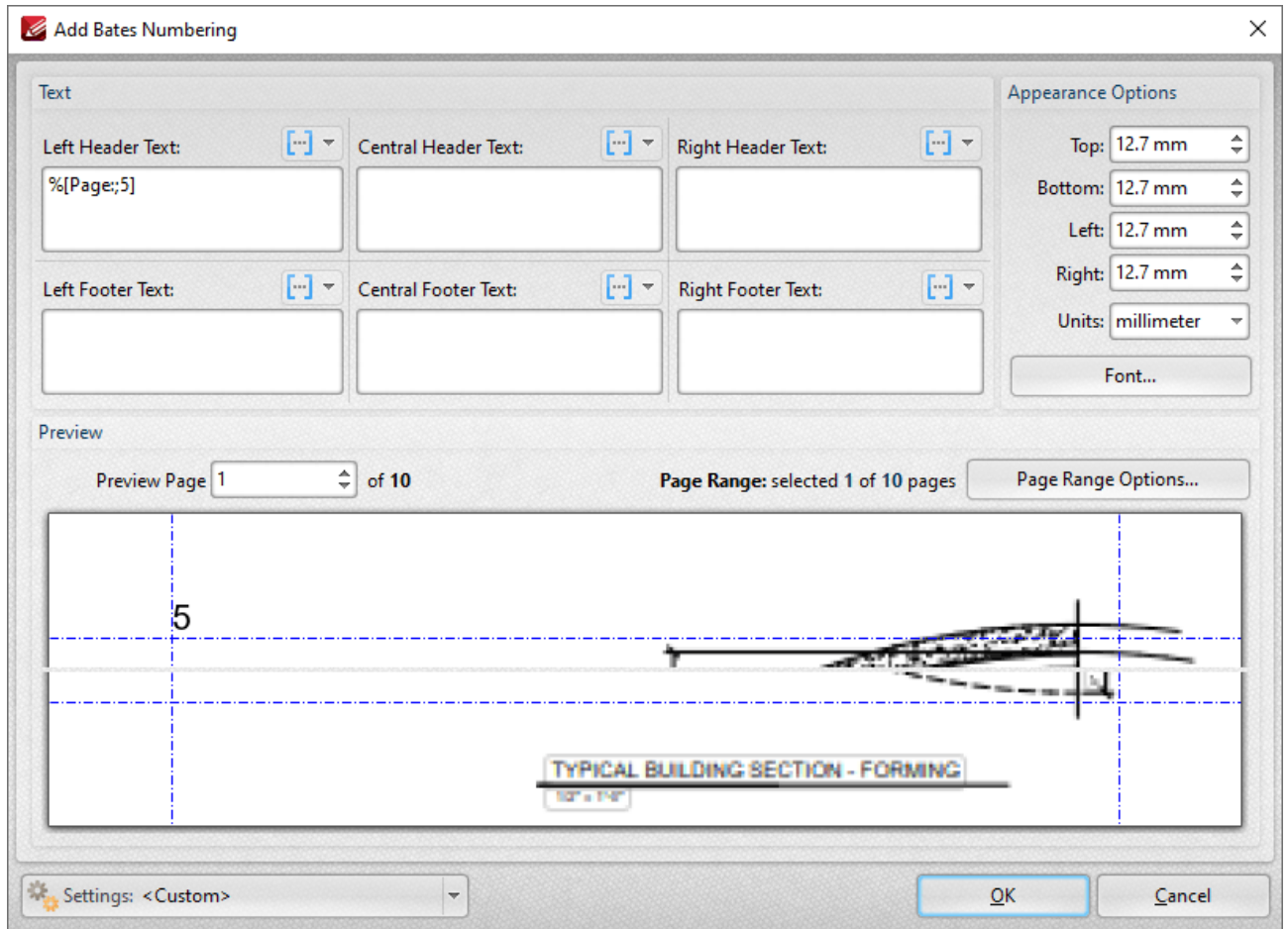

Figure 4. %[Page] Macro Example Four

### 10.5.12.5 Number of Pages

---



## Number of Pages

---

The **Number of Pages** macro inserts the total number of document pages.

The syntax for this macro is **%[Pages]** and the following parameters are available

- 'r' specifies the use of lower-case roman numerals.
- 'R' specifies the use of upper-case roman numerals.
- 'L' specifies page labels as the page numbering format in cases where page labels have been specified. If page labels have not been specified then standard page numbers are used.
- '<integer>' specifies the minimum number of digits used. This value can be any positive integer from 1 to 12 - for example **%[Pages:4]** starts the numbering as "0001, 0002, 0003..."

The syntax for this macro when parameters are used is **%[Pages:<Parameter>]**

### Examples

Follow the steps below to use the **Page Number** macro to insert the total number of document pages as a watermark:

1. Click the **Organize** tab.
2. Click **Watermarks**, then click **Add**. The **Add Watermark** dialog box will open.
2. Enter **%[Pages]** in the **Text** text box. The total number of document pages is then inserted as a watermark:

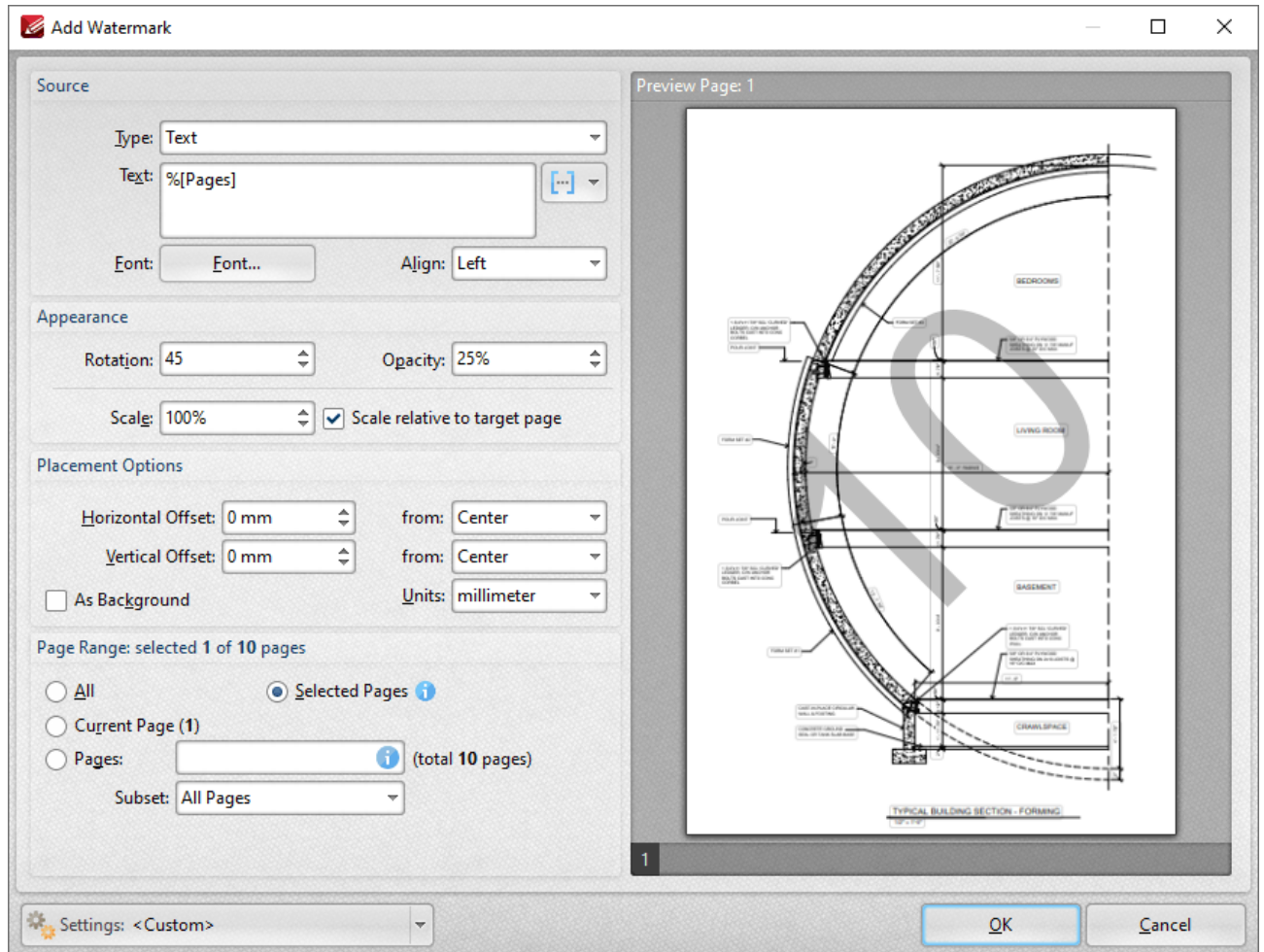

Figure 1. Add Watermark Dialog Box, %[Pages] Macro Example

Alternatively, enter **%[Pages:R]** in the **Filename** text box to insert the total number of document pages as a watermark and specify the use of upper-case roman numerals:

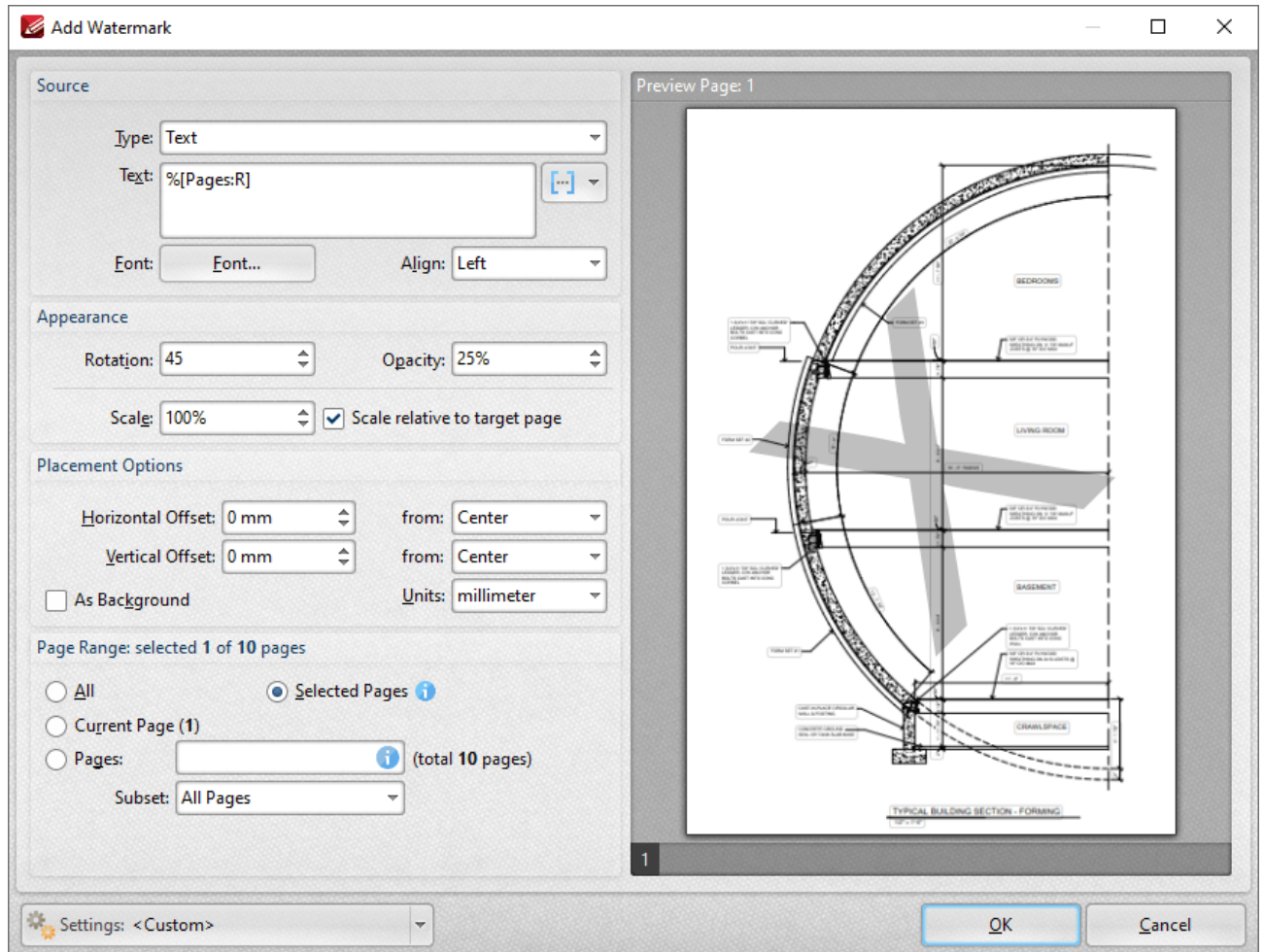

Figure 2. Add Watermark Dialog Box, %[Pages] Macro Example Two



### 10.5.12.6 FileName

---



**FileName**

---

The **FileName** macro inserts the name of the source file.

The syntax for this macro is **%[FileName]**

#### **Example**

Follow the steps below to use the **FileName** macro to insert the name of the source file as the stamp title when creating a new stamp:

1. Click the **Stamp** dropdown menu in the **Home** tab, then click then click **Stamps Palette**. The **Stamps Palette** will open.
2. Click **Add New**, then click **Add New Stamp from File**:

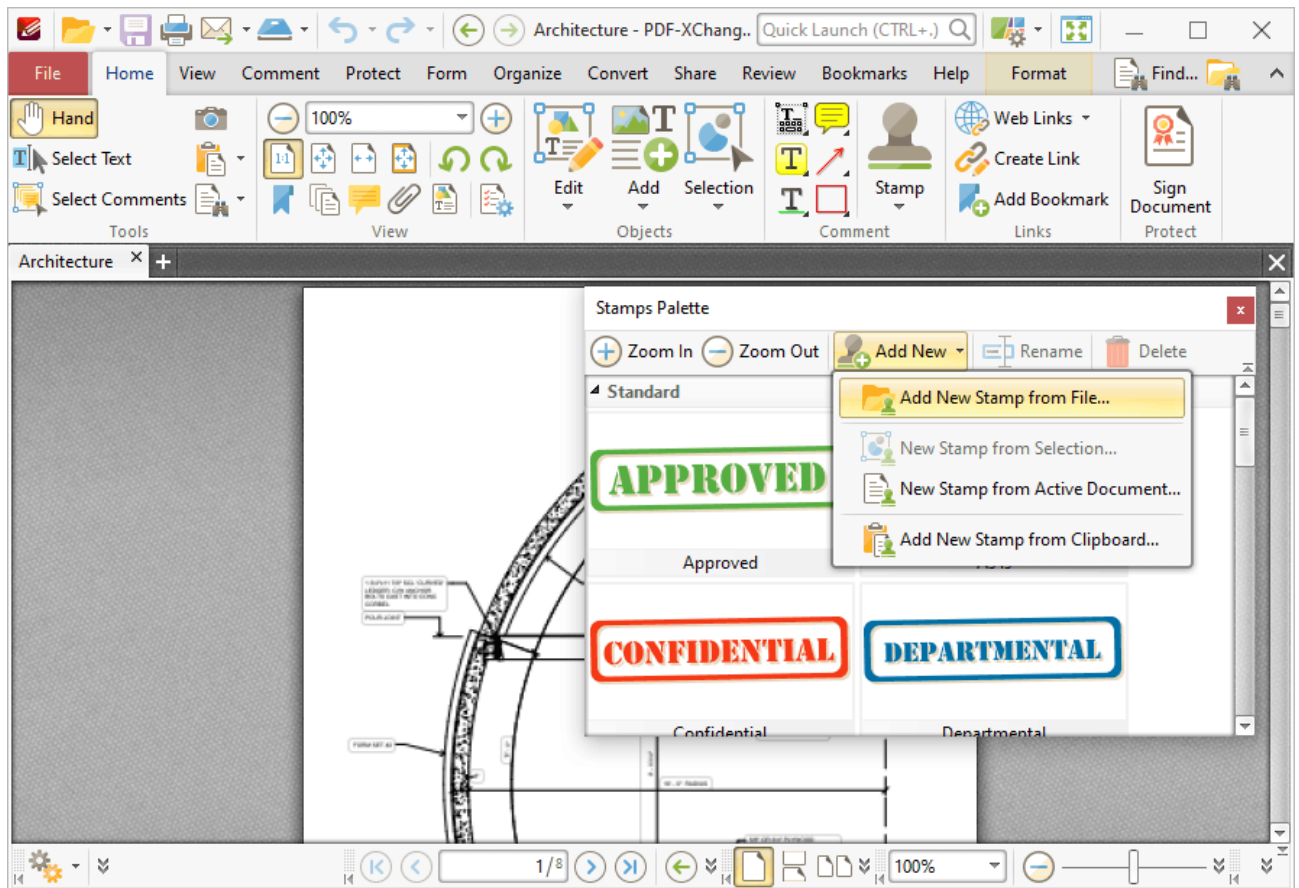

Figure 1. Stamps Palette, Add New Stamp From File

The **Open Files** dialog box will open.

3. Select a file to use as the stamp and then click **Open**. The **Add New Stamp** dialog box will open.
4. Enter **%[FileName]** in the **Stamp Title** dialog box and select a target collection:



Figure 2. Add New Stamp Dialog Box

5. Click **OK**.

A new stamp will then be created and the name of the source file will be used as the title:

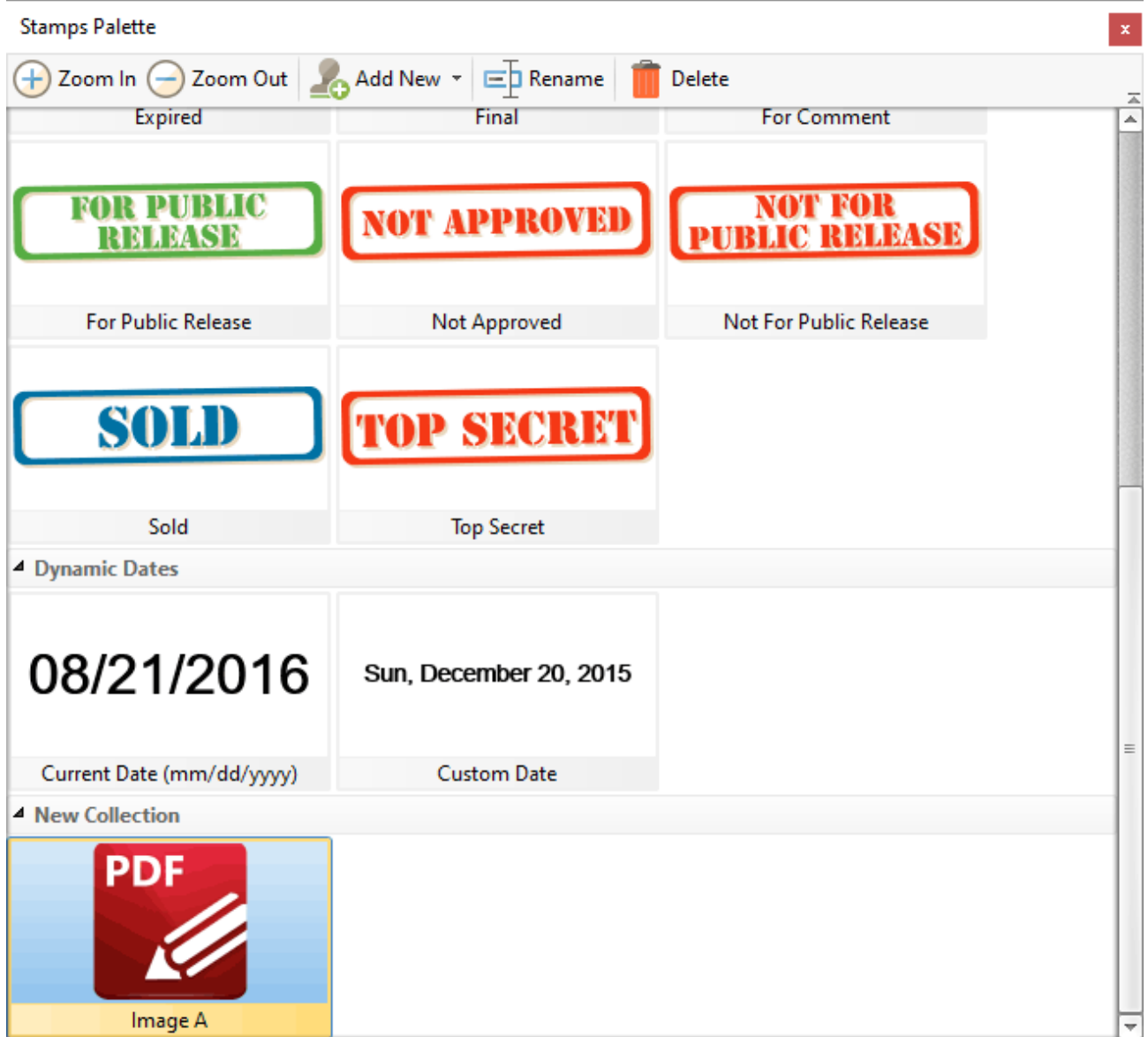

Figure 3. New Stamp

### 10.5.12.7 Folder Name

---



#### Folder Name

---

The **Folder Name** macro inserts the path of the folder that contains the source file. Note that folder names end with a backslash when local files are used.

The syntax for this macro is **%[FolderName]**

#### Example

Follow the steps below to use the **Folder Name** macro to insert the path of the folder that contains the source file when a new watermark is created:

1. Click the **Organize** tab.
2. Click **Watermarks**, then click **Add**. The **Add Watermark** dialog box will open.
3. Enter **%[FolderName]** in the **Text** text box. The path of the folder that contains the source file is then used as the watermark text:

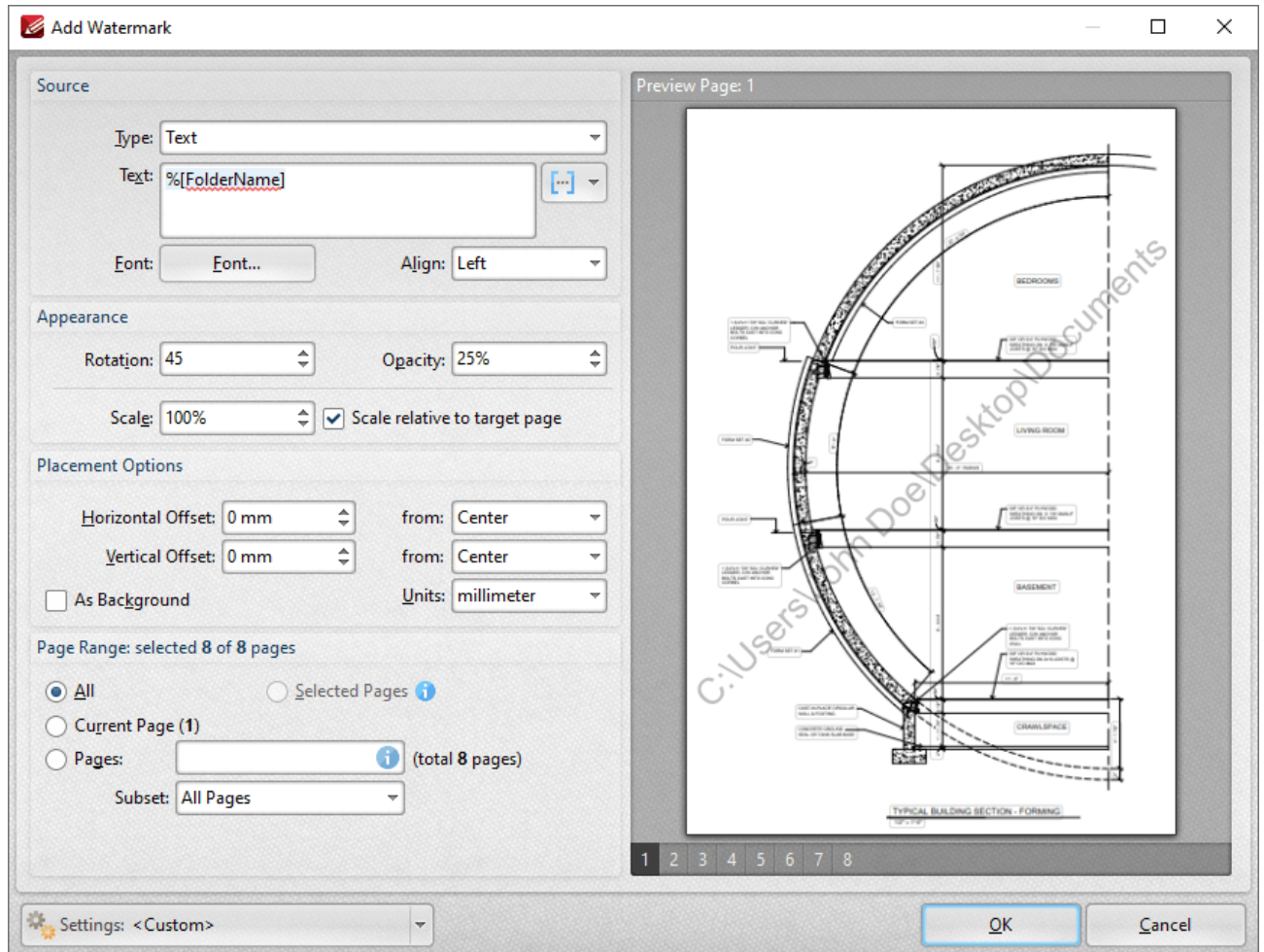

Figure 1. %[FolderName] Macro Example

### 10.5.12.8 Folder Title

---



#### Folder Title

---

The **Folder Title** macro inserts the title of the folder that contains the source file.

The syntax for this macro is **%[FolderTitle]**

#### Example

Follow the steps below to use the **Folder Title** macro to insert the title of the folder that contains the source file when a new watermark is created:

1. Click the **Organize** tab.
2. Click **Watermarks**, then click **Add**. The **Add Watermark** dialog box will open.
3. Enter **%[FolderTitle]** in the **Text** text box. The title of the folder that contains the source file is then used as the watermark text:

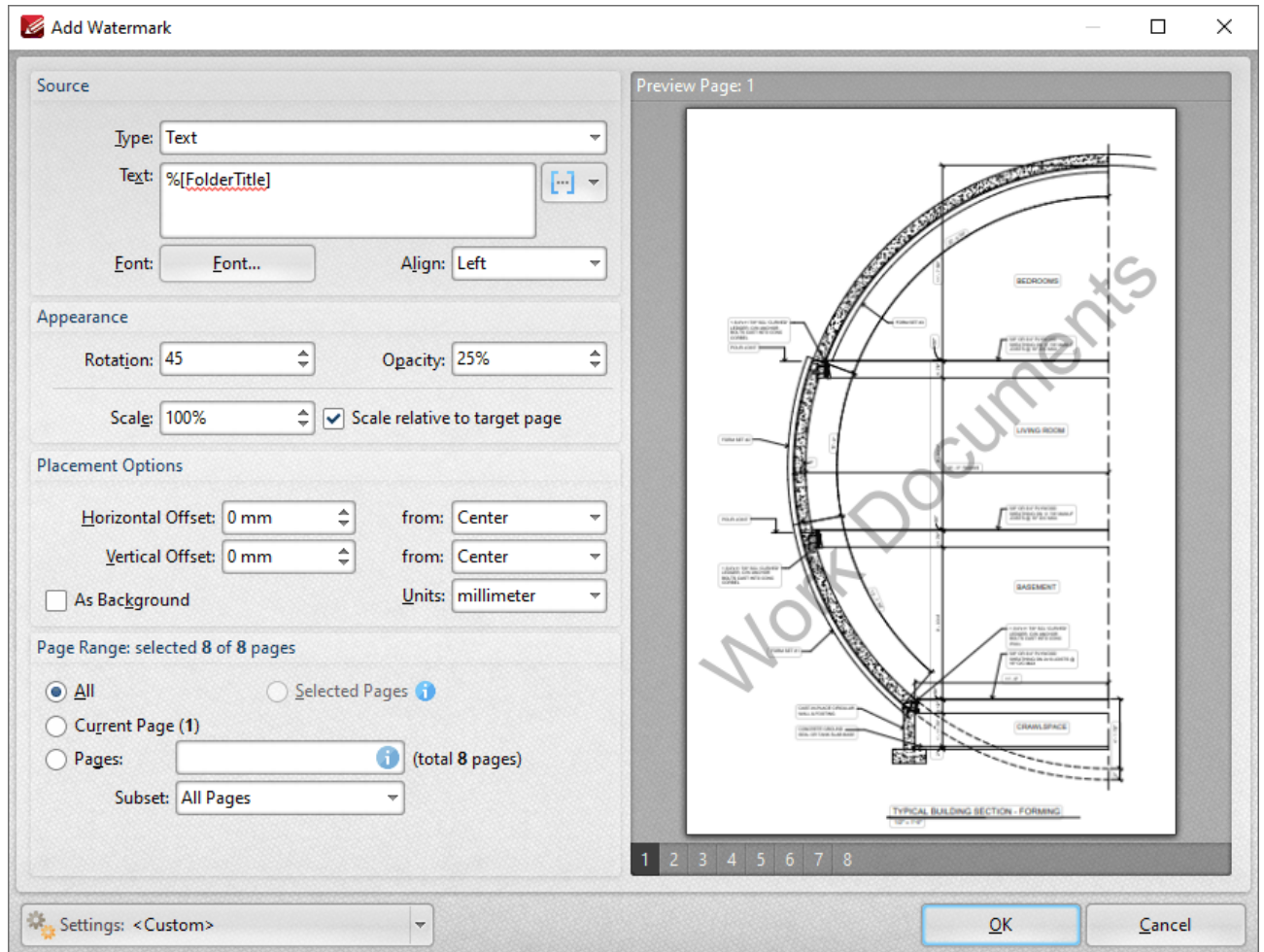

Figure 1. %[FolderTitle] Macro Example



### 10.5.12.9 Date

---



### Date

---

The **Date** macro inserts the current date. Multiple date formats are available, as detailed below.

The syntax for this macro is **%[Date]** and the following parameters are available:

- **d** inserts the day of the month and omits the zero in cases of single-digit values.
- **dd** inserts the day of the month and includes a zero in cases of single-digit values.
- **ddd** inserts the day of the week as a three-letter abbreviation.
- **dddd** inserts the day of the week.
- **M** inserts the month and omits the zero in cases of single-digit values.
- **MM** inserts the month and includes a zero in cases of single-digit values.
- **MMM** inserts the month as a three-letter abbreviation.
- **MMMM** inserts the month.
- **yy** inserts the year as two digits and adds a zero in cases of values lower than 10.
- **yyyy** inserts the year.

The syntax for this macro when parameters are used is **%[Date:<Parameter>]**

Note that several parameters can be used in sequence in order to insert a customized date. For example, **%[Date:dddd, dd MMMM yyyy]** inserts the day of the week followed by the day of the month, the month name in full and the year as four digits (as detailed below). If parameters are not specified then output values revert to default, which is the date on the local machine in the format **dd/MM/yyyy**.

### Example

Follow the steps below to use the **Date** macro to add a header that uses a customized version of the current date:

1. Click the **Organize** tab.
2. Click **Header and Footer**, then click **Add**. The **Add Header and Footer** dialog box will open.

3. Enter **%[Date:dddd, dd MMMM yyyy]** in a header text box. A customized version of the current date is then added to the document:

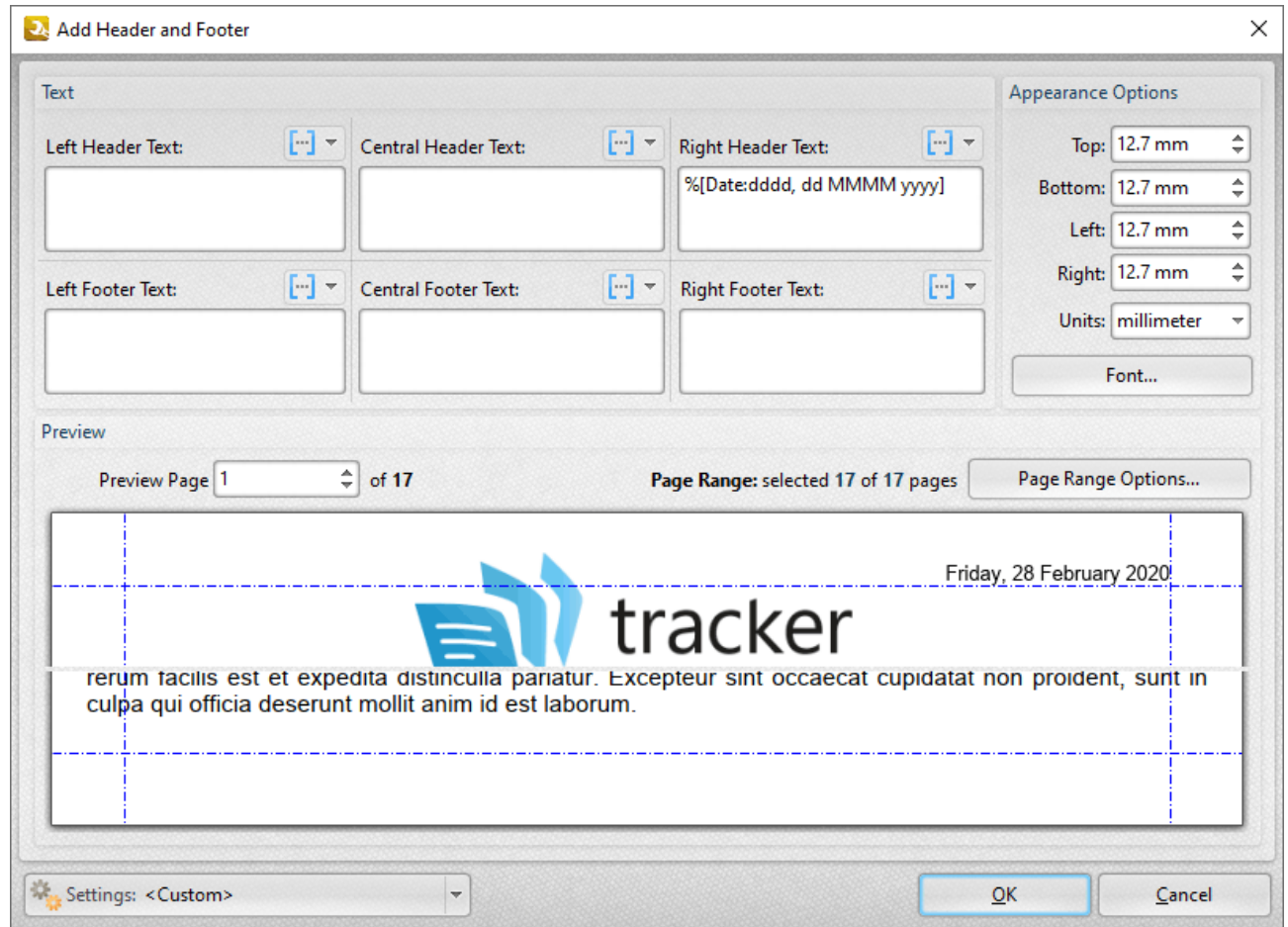

Figure 1. %[Date] Macro Example

Note that a range of preset date formats are provided in **PDF-XChange Editor**:

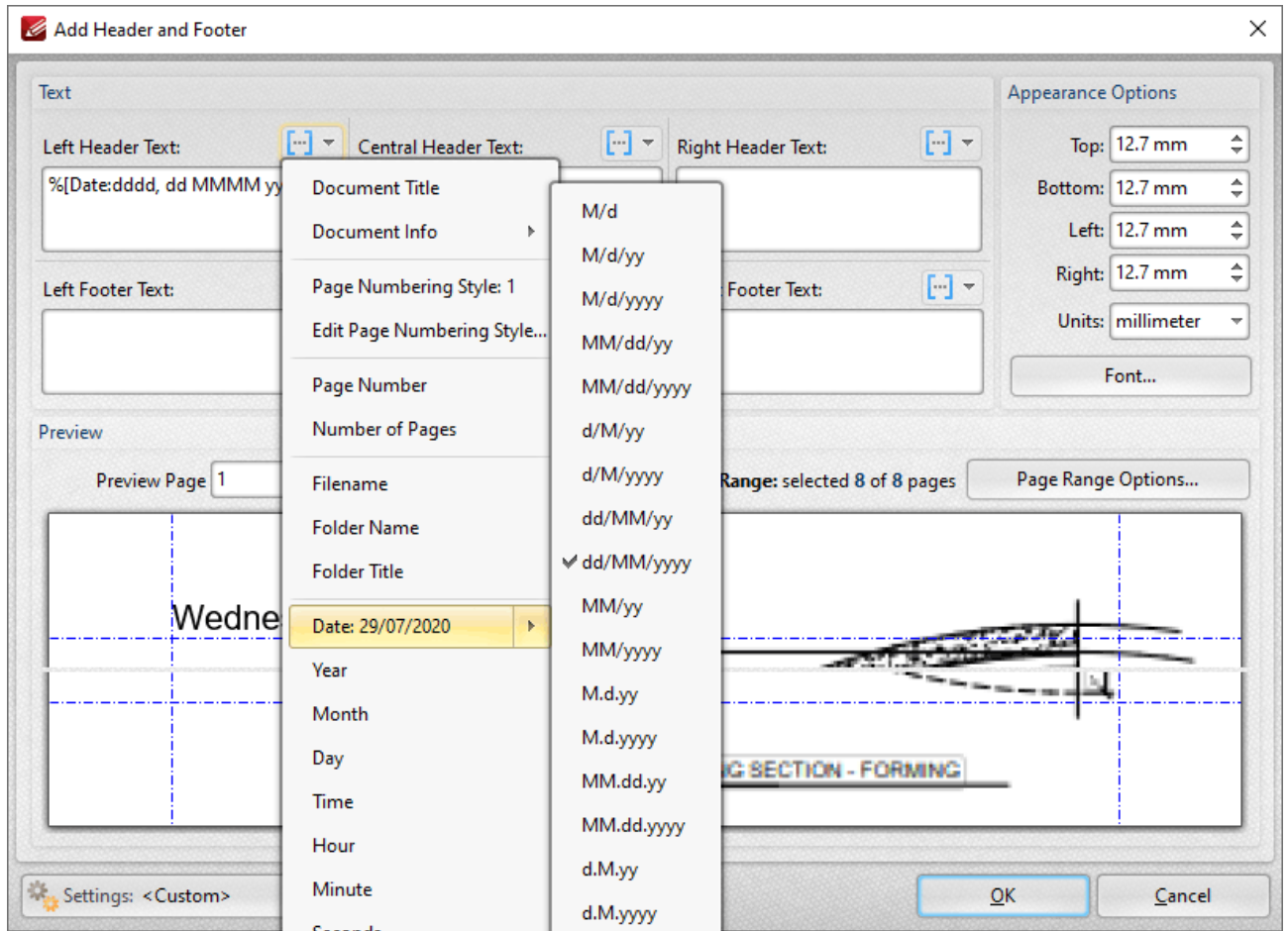

Figure 2. Default Date Macro Formats

10.5.12.1Year



The **Year** macro inserts the current year as a four-digit value.

The syntax for this macro is **%[Year]**

**Example**

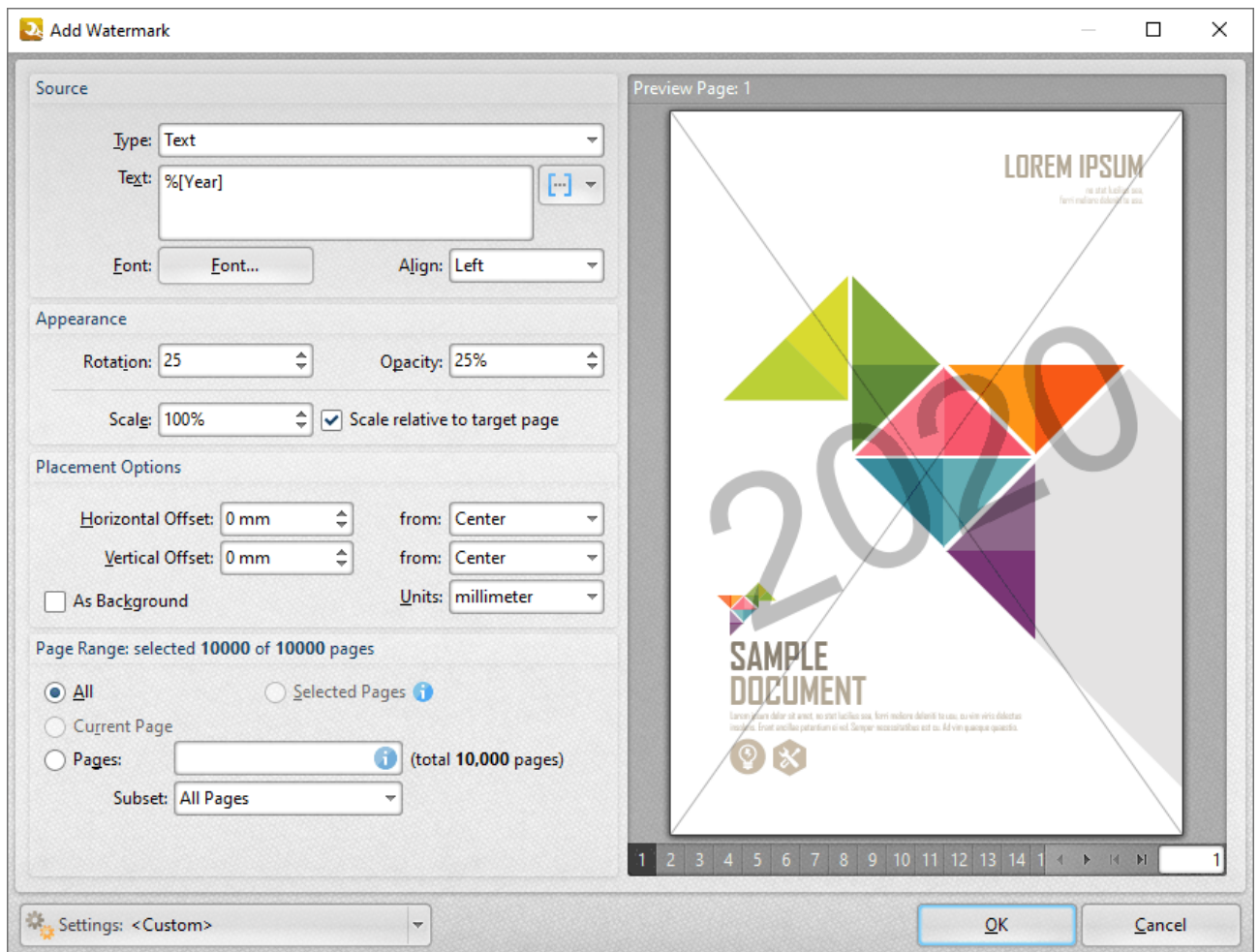

Figure 1. %[Year] Macro Example

Note that this macro is often used in conjunction with other macros in order to create combined output. For example the combined macros  **%[Time:H:mm] %[Date:dd MMMM] %[Year]** output the current time, date and year:

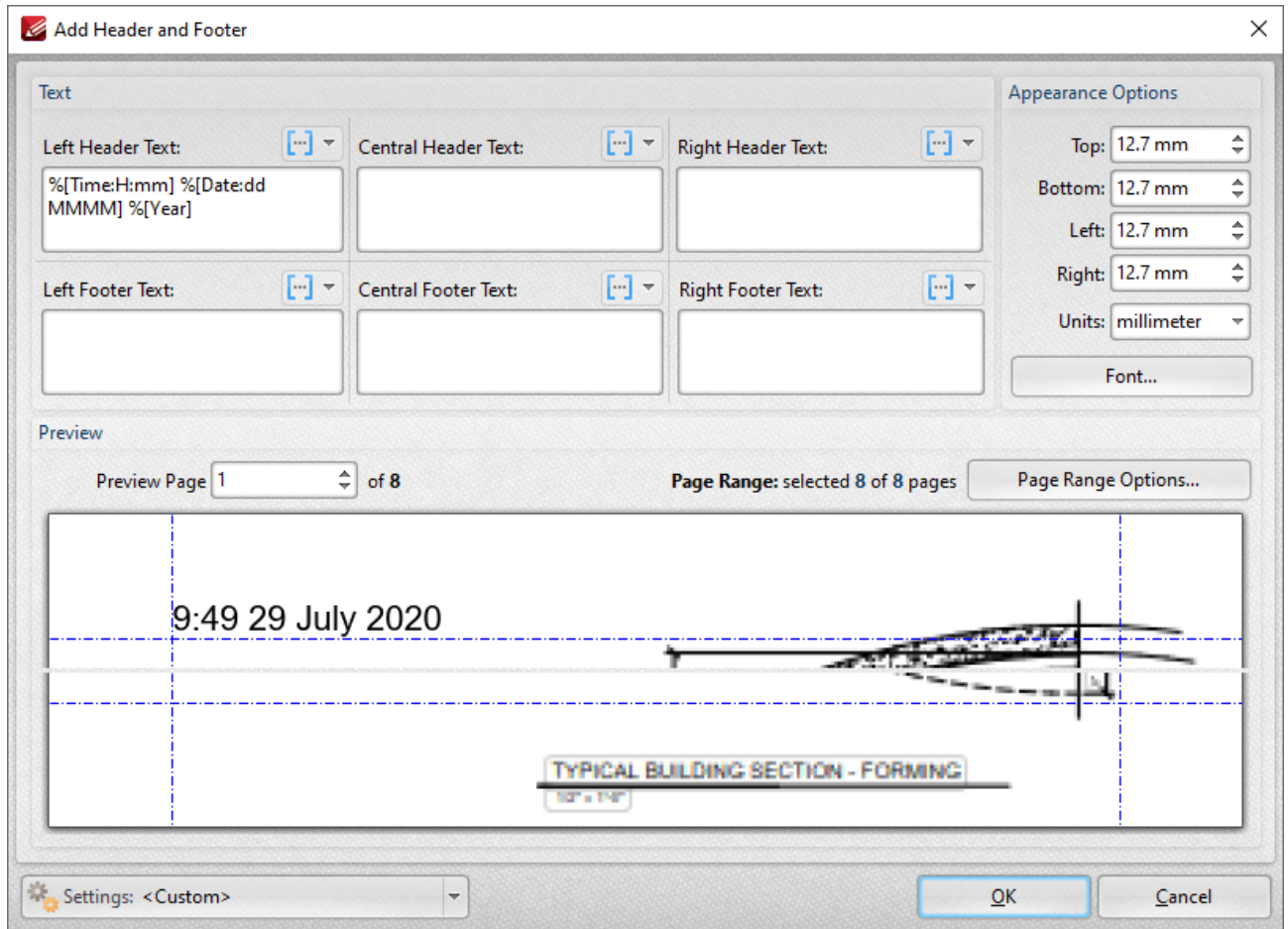

Figure 2. %[Year] Combined Macro Example

10.5.12.1:Month



**Month**

The **Month** macro inserts the current month as a numerical value from 1-12.

The syntax for this macro is **%[Month]**

**Example**

If the current month is July then the **%[Month]** macro inserts "07":

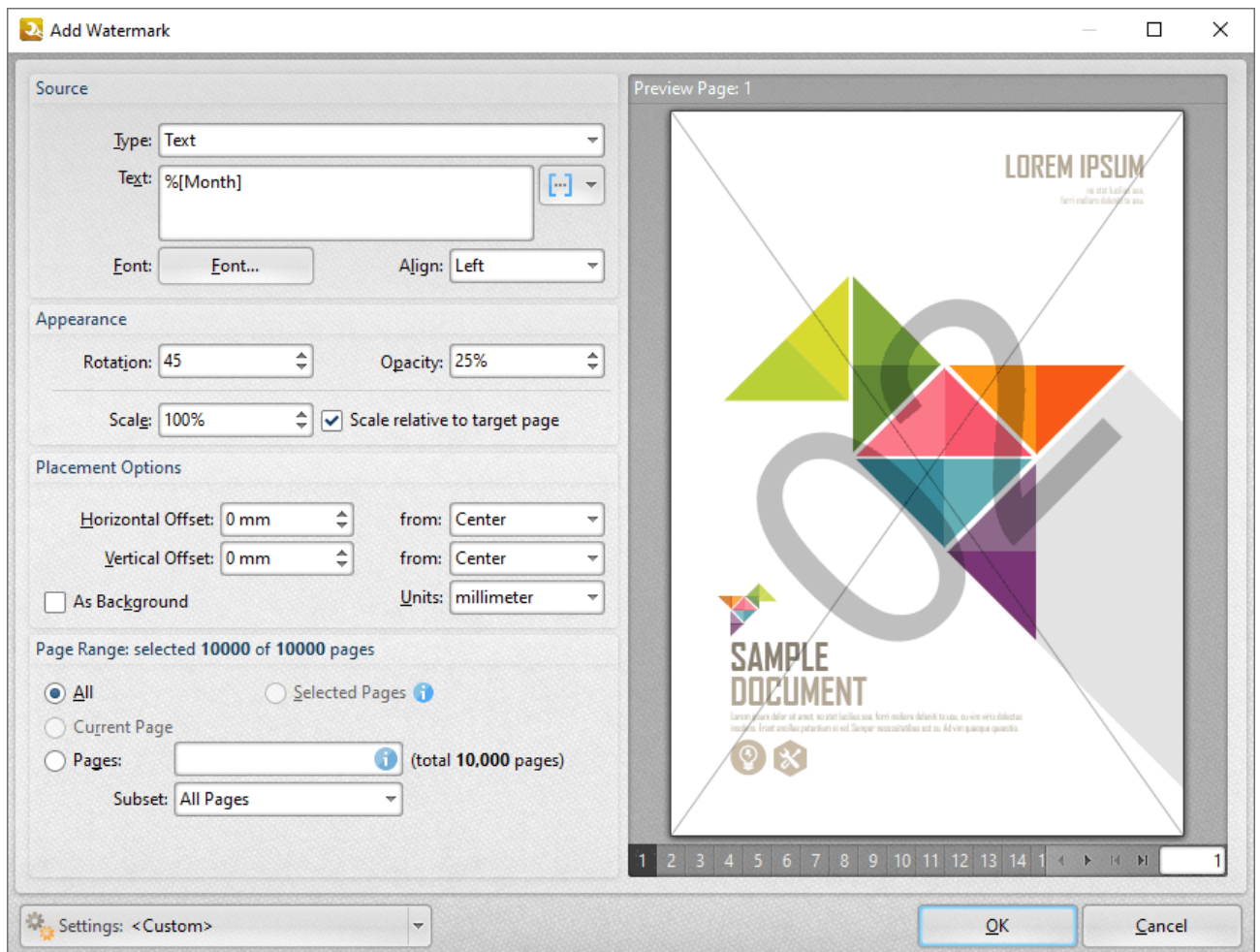

Figure 1. %[Month] Macro Example

Note that this macro is often used in conjunction with other macros in order to create combined output. For example the combined macros **%[Time:H:mm] %[Month]/%[Day]** output the current time followed by the month and the day of the month:

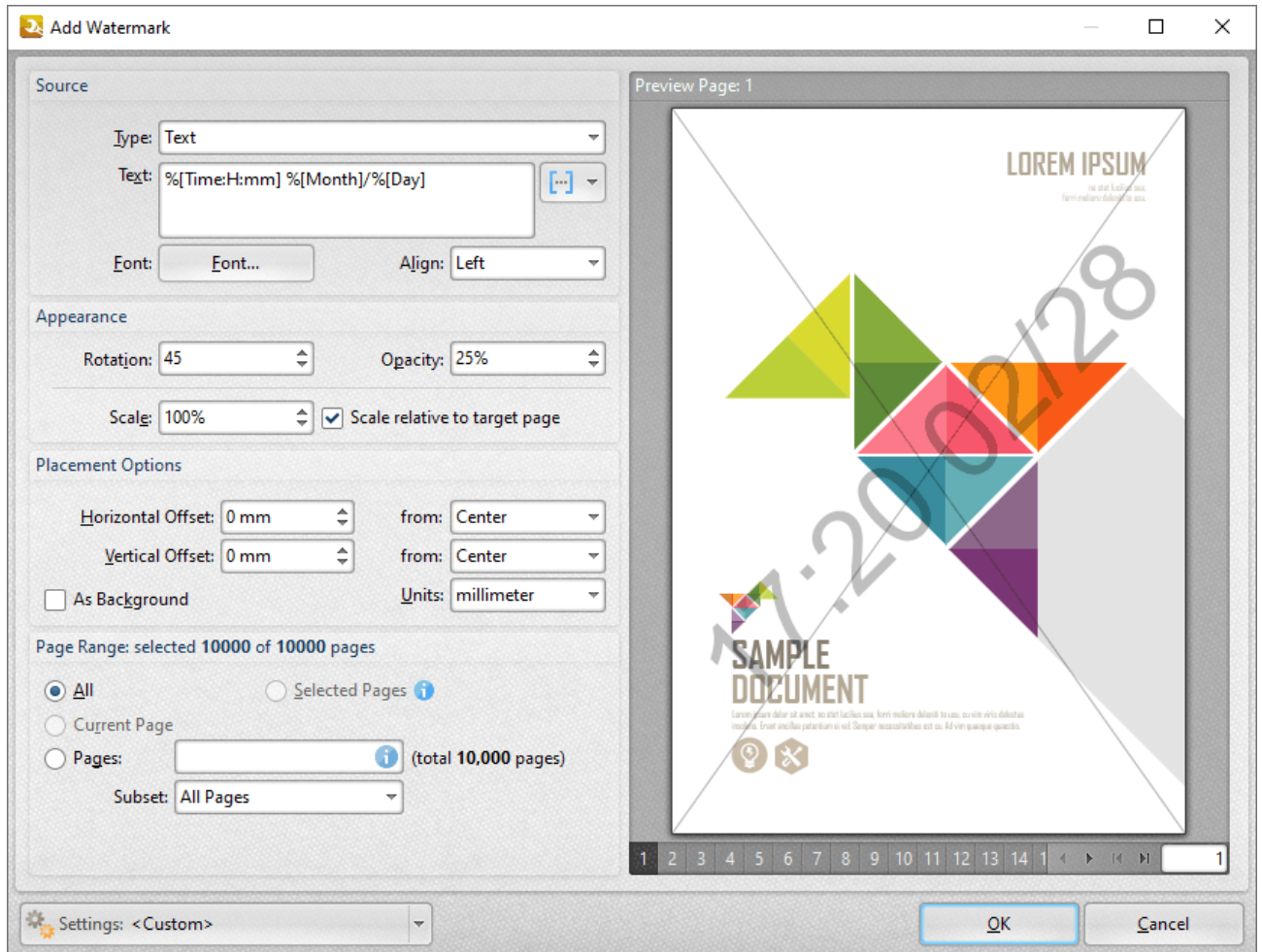

Figure 2. %[Month] Combined Macro Example

10.5.12.1:Day



The **Day** macro inserts the current day of the month.

The syntax for this macro is **%[Day]**

**Example**

If the date is 29th July then the **%[Day]** macro inserts "29":

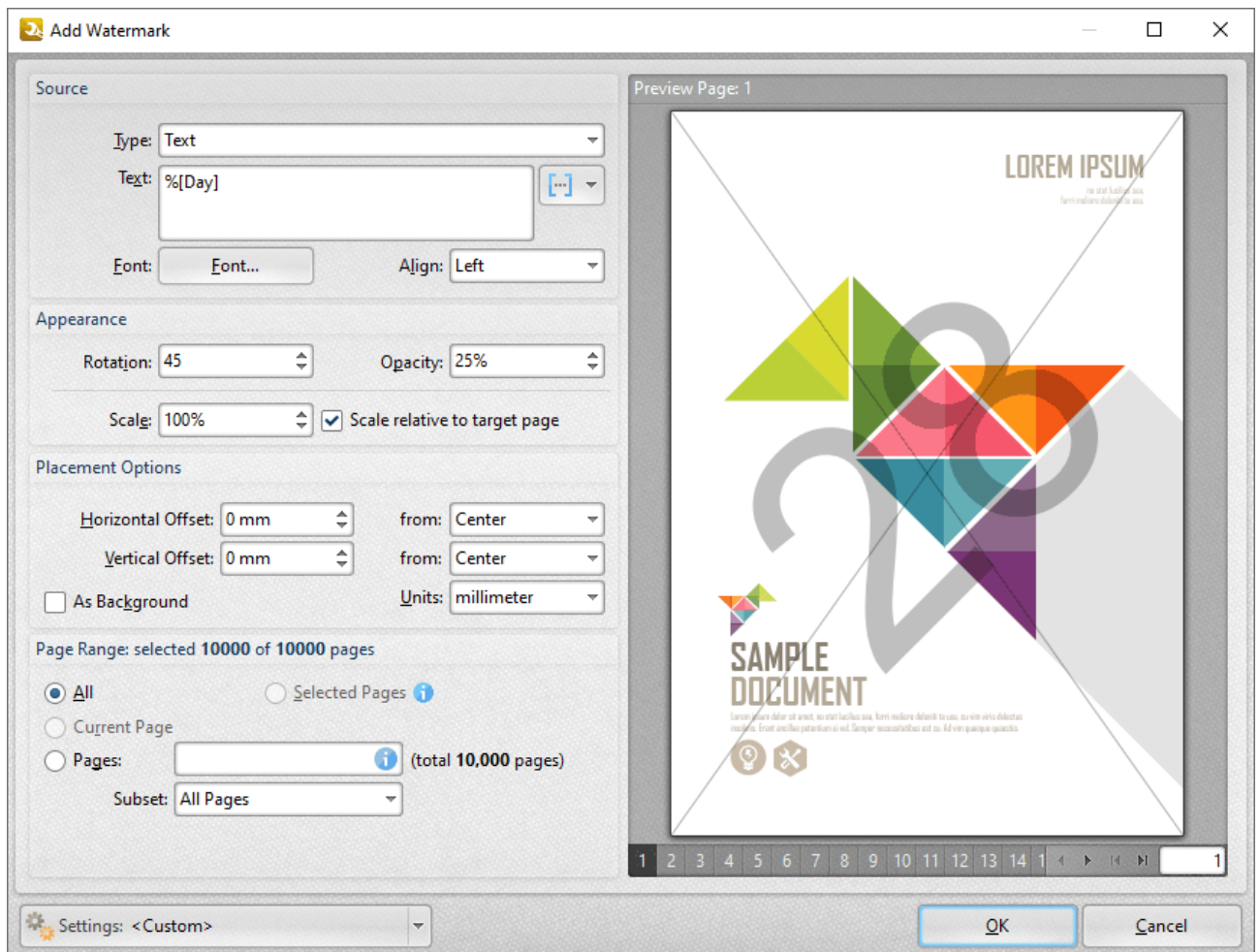



Figure 1. %[Day] Macro Example

Note that this macro is often used in conjunction with other macros in order to create combined output. For example the combined macros **%[Time:H:mm] %[Month]/%[Day]** output the current time followed by the month and the day of the month:

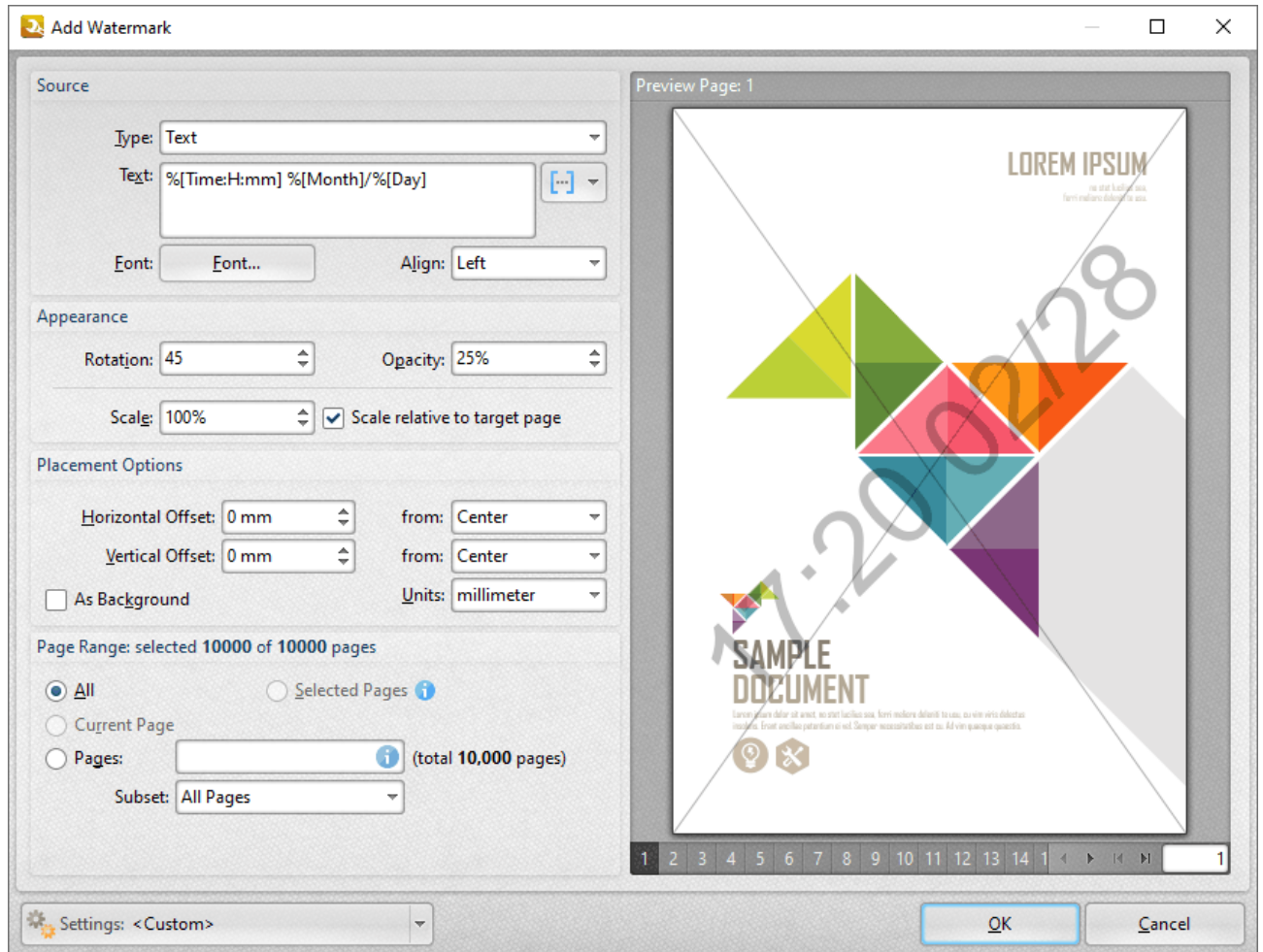

Figure 2. %[Day] Combined Macro Example

### 10.5.12.1:Time

---



---

The **Time** macro inserts the current time. Multiple time formats are available, as detailed below.

The syntax for this macro is **%[Time]** and the following parameters are available:

- **h** inserts the hour and omits the zero in cases of single-digit values.
- **hh** inserts the hour and includes a zero in cases of single-digit values.
- **H** inserts the hour, includes a zero in cases of single-digit values and uses a 24 hour-clock.
- **m** inserts the minutes and omits the zero in cases of single-digit values.
- **mm** inserts the minutes and includes a zero in cases of single-digit values.
- **s** inserts the seconds and omits the zero in cases of single-digit values.
- **ss** inserts the seconds and includes a zero in cases single-digit values.
- **t** inserts a single character to reference the a.m./p.m. variable: **a** or **p**.
- **tt** inserts two characters to reference the a.m/p.m. variable: **AM** or **PM**.

The syntax for this macro when parameters are used is **%[Time:<Parameter>]**

Note that several parameters can be used in sequence in order to insert a customized time. For example, **%[Time:H:mm tt]** inserts the current hour and minutes, and inserts two characters to reference the a.m./p.m. variable (as detailed below).

#### Example

Follow the steps below to use the **Time** macro to create a watermark that inserts a customized version of the current time:

1. Click the **Organize** tab.
2. Click **Watermarks**, then click **Add**. The **Add Watermark** dialog box will open.
3. Enter **%[Time:H:mm tt]** in the **Text** text box. A customized version of the time is then added as a watermark:

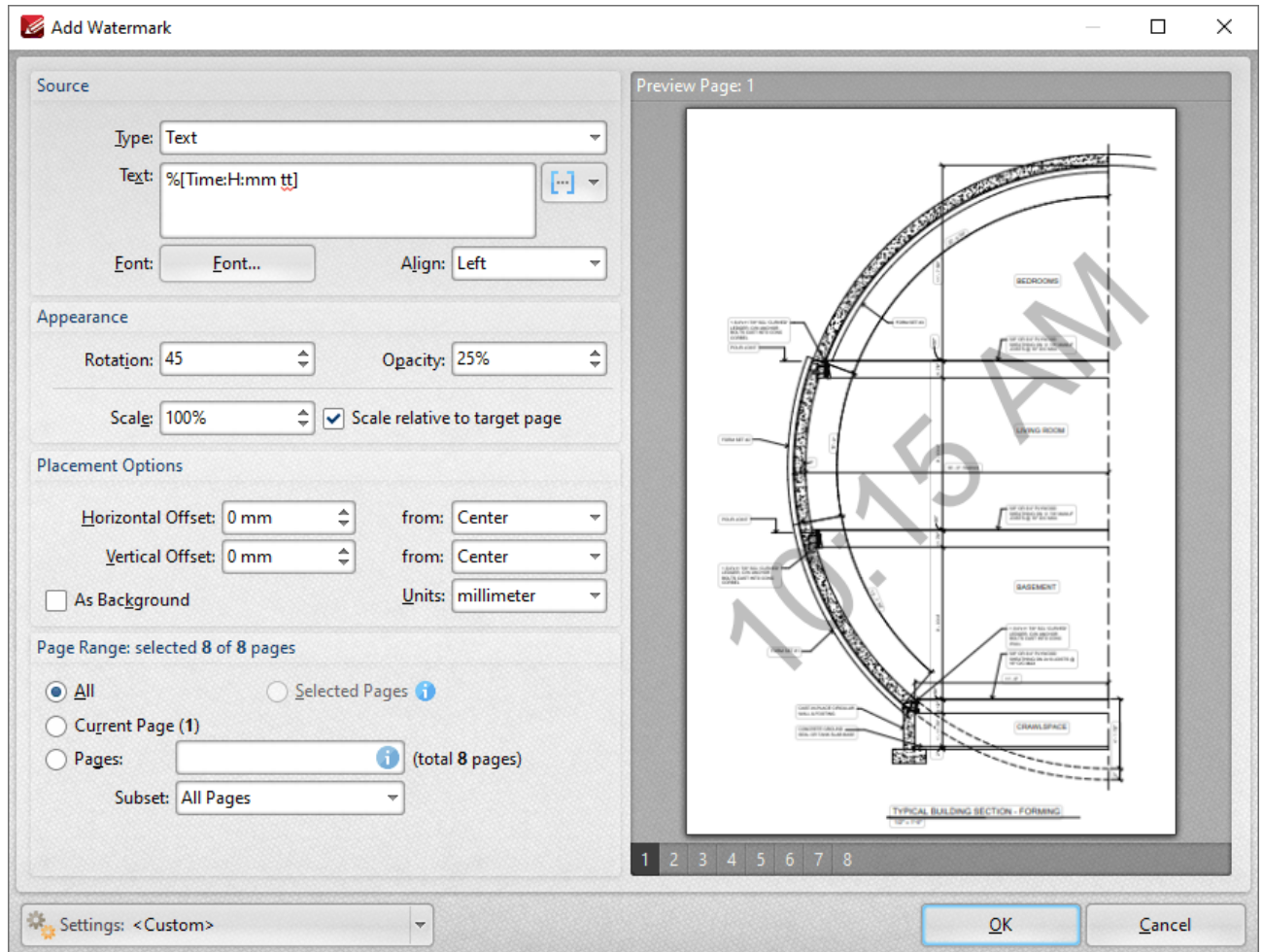

Figure 1. %[Time] Macro Example

Note that this macro is often used in conjunction with other macros in order to create combined output. For example the combined macros **%[Time:H:mm] %[Month]/%[Day]** output the current time followed by the month and the day of the month:

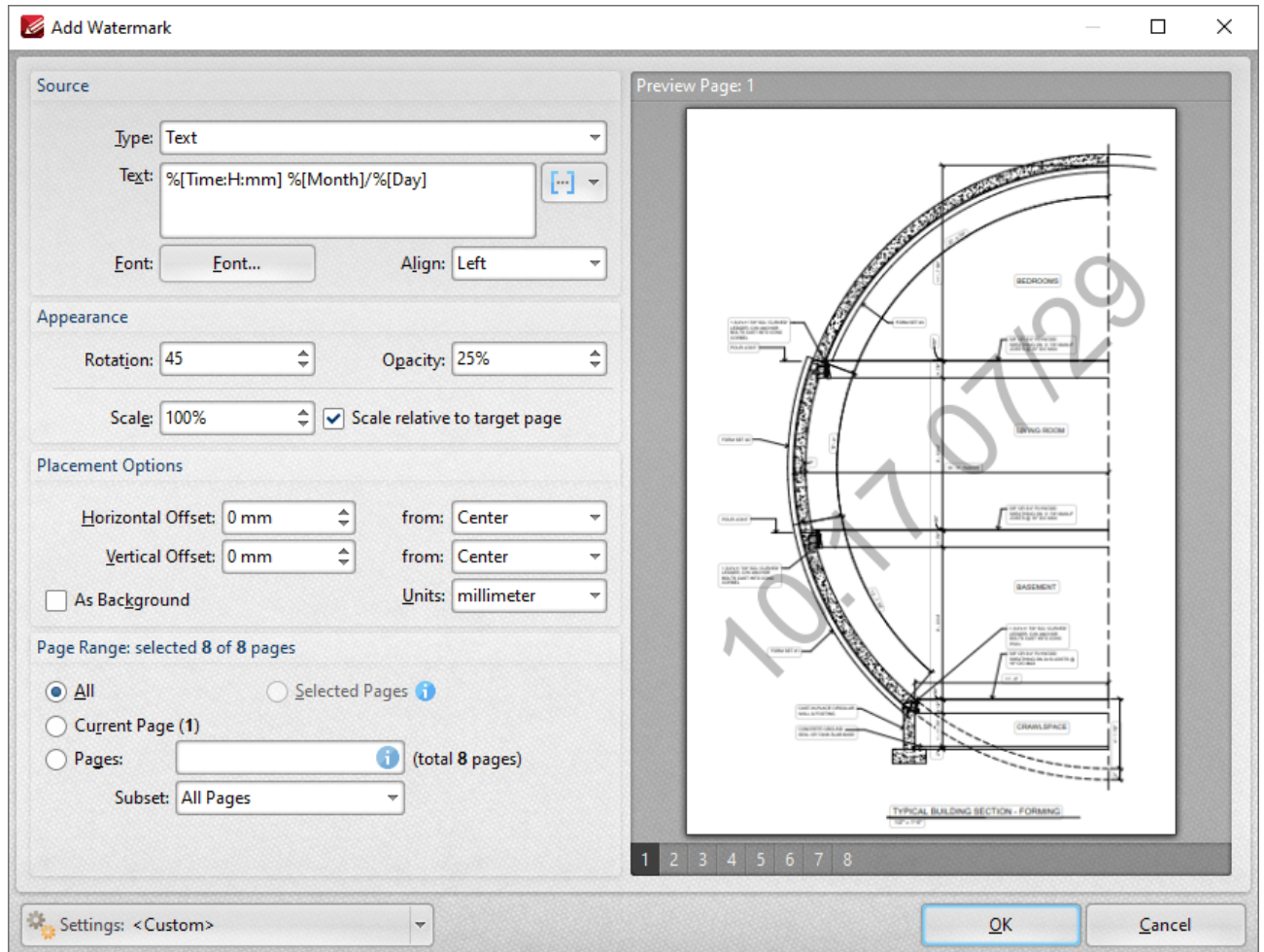

Figure 2. %[Time] Combined Macro Example

10.5.12.1 Hour



**Hour**

The **Hour** macro inserts the hour value from the current time.

The syntax for this macro is **%[Hour]**

**Example**

If the current time is 10:22 then the **[Hour]** macro inserts '10':

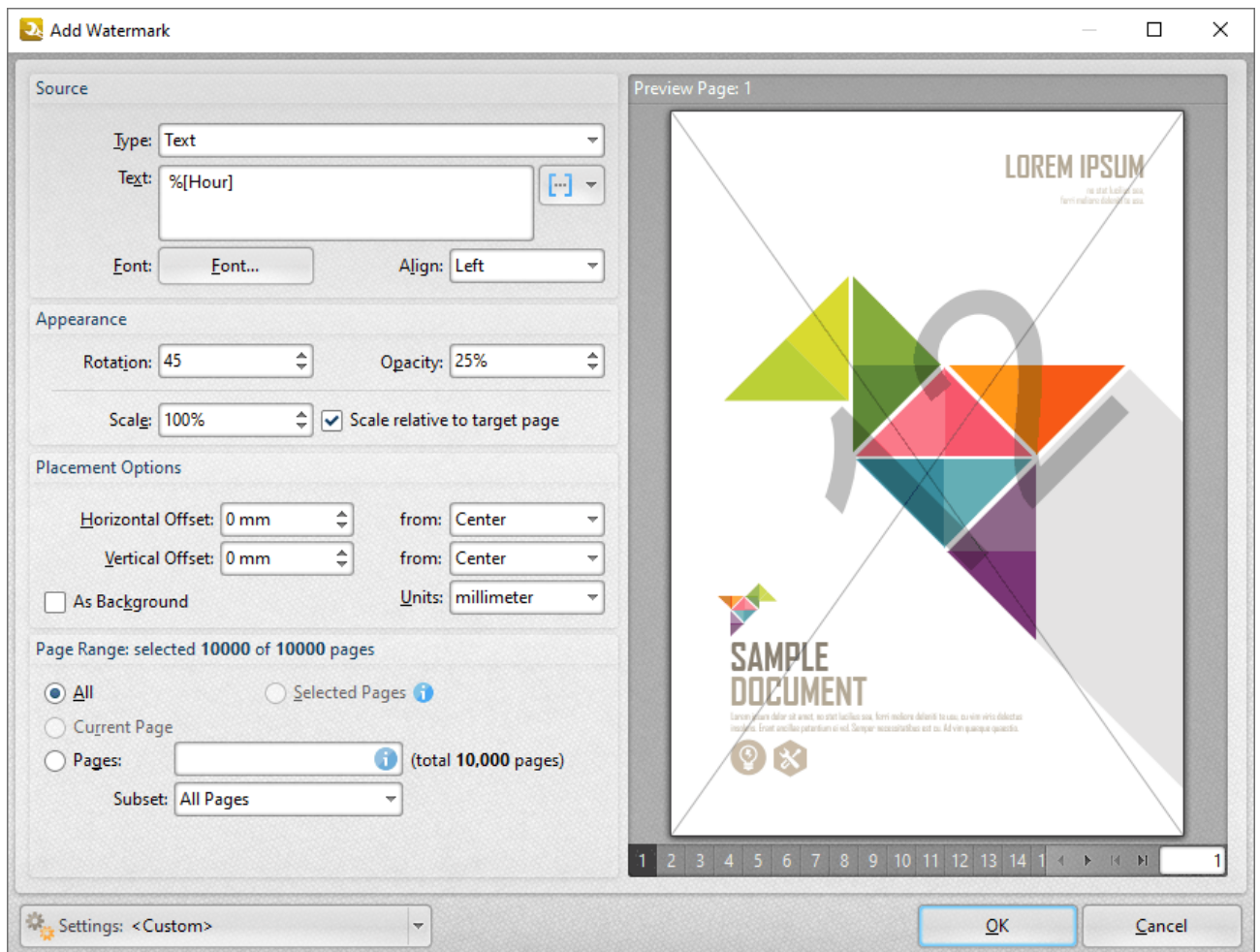

Figure 1. %[Hour] Macro Example

Note that this macro is often used in conjunction with other macros in order to create combined output. For example the combined macros **%[Hour]:%[Minute]** output the hour followed by the minutes of the hour:

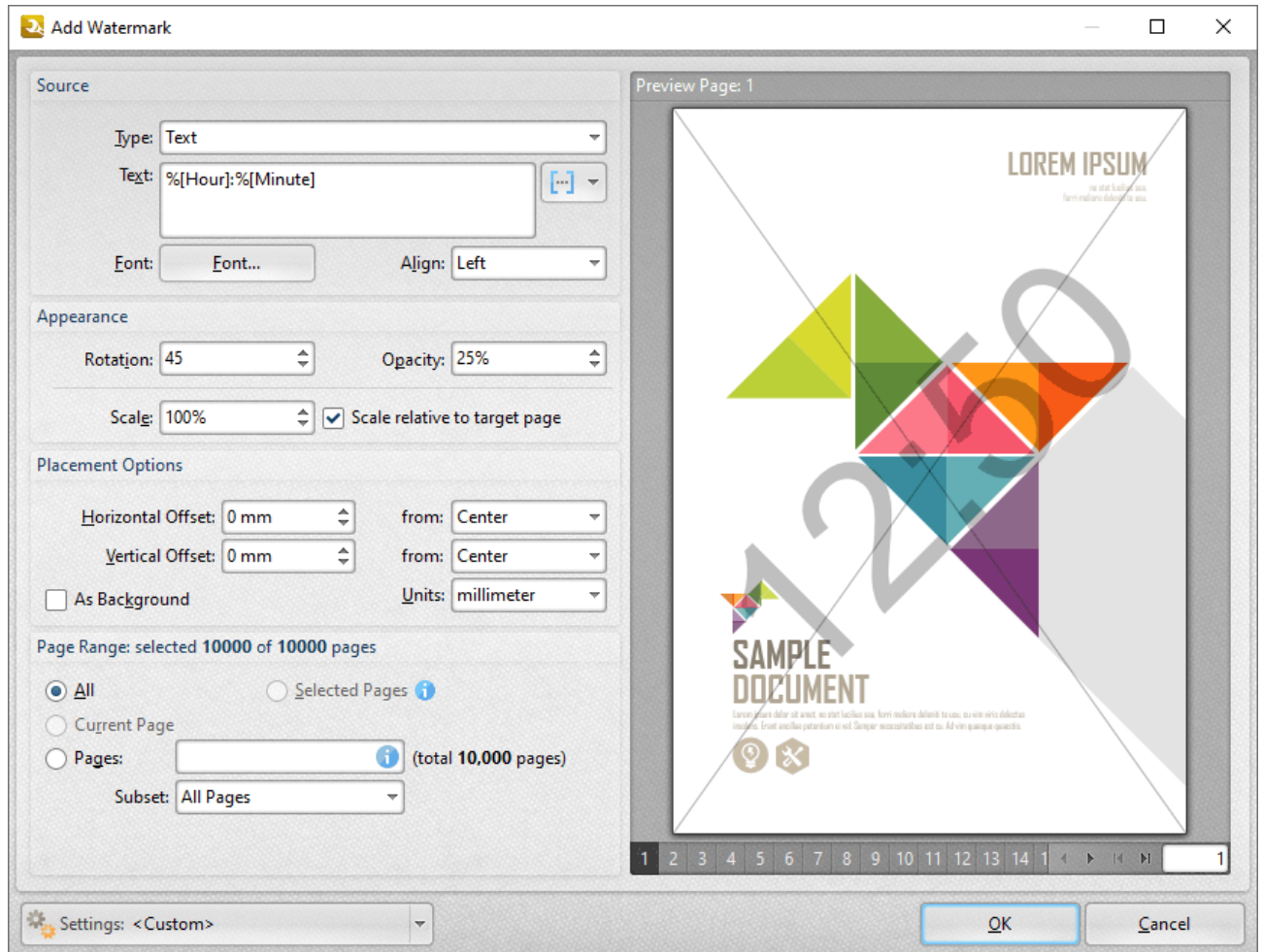

Figure 2. %[Hour] Combined Macro Example

10.5.12.1!Minute



**Minute**

The **Minute** macro inserts the minute value from the current time.

The syntax for this macro is **%[Minute]**

**Example**

If the current time is 11:28 then the **%[Minute]** macro inserts '28':

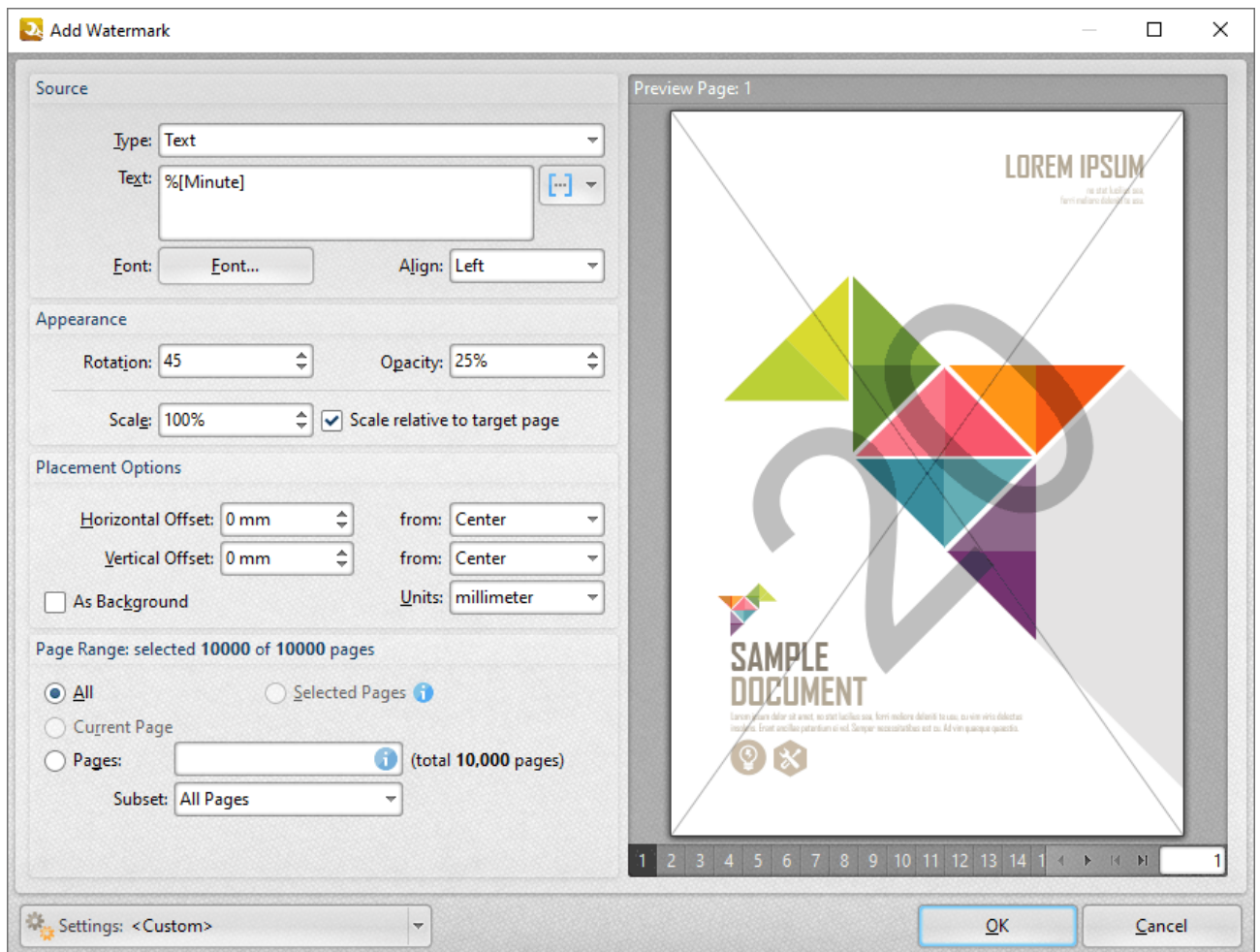

Figure 1. %[Minute] Macro Example

Note that this macro is often used in conjunction with other macros in order to create combined output. For example the combined macros **%[Hour]:%[Minute]** output the hour followed by the minutes of the hour:

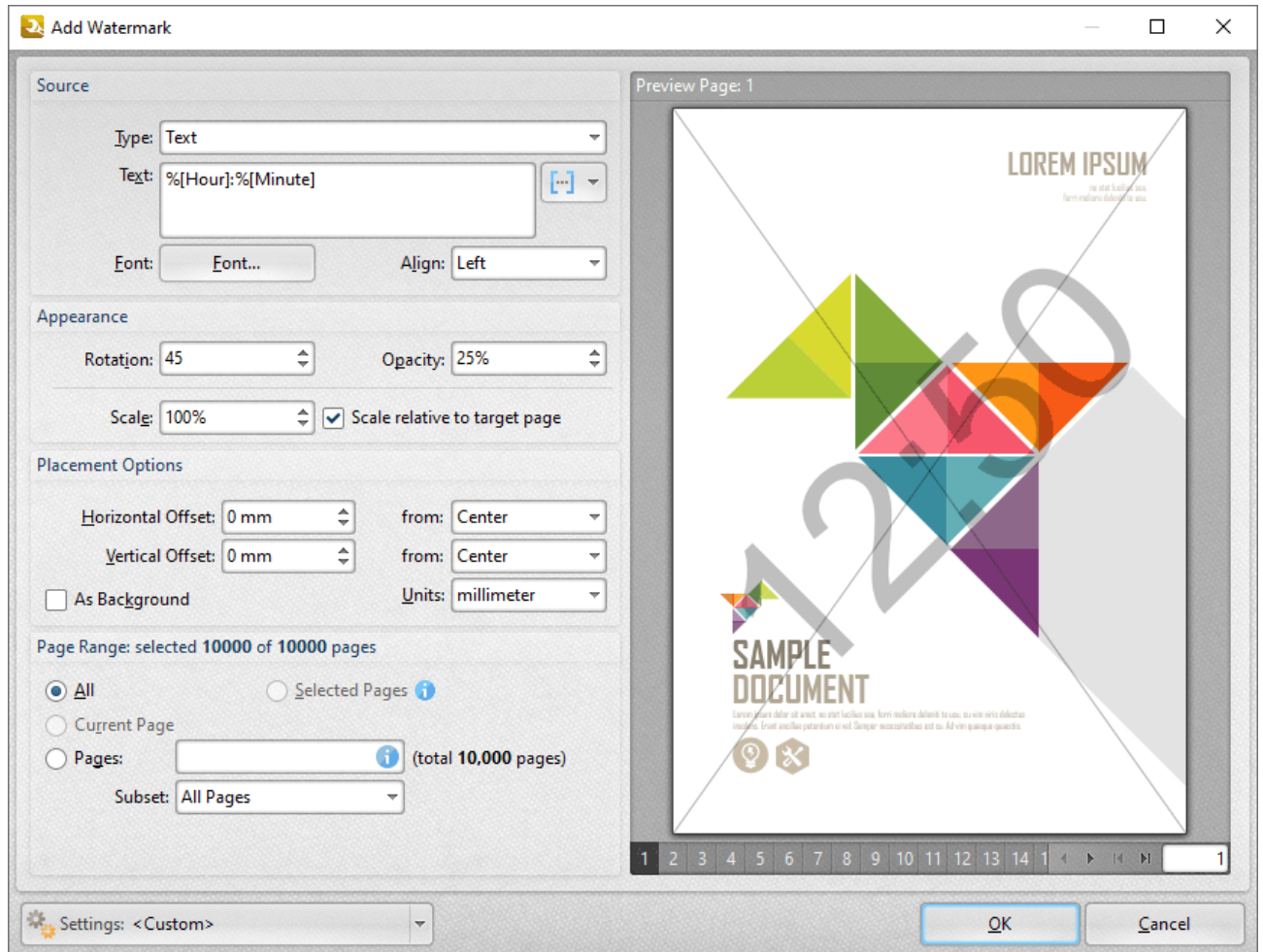

Figure 2. %[Minute] Combined Macro Example



## 10.5.12.1 Seconds

**Seconds**

The **Seconds** macro inserts the seconds value from the current time.

The syntax for this macro is **%[Seconds]**

**Example**

If the current time is 11:32 and 30 seconds then the **%[Minute]** macro inserts '30':

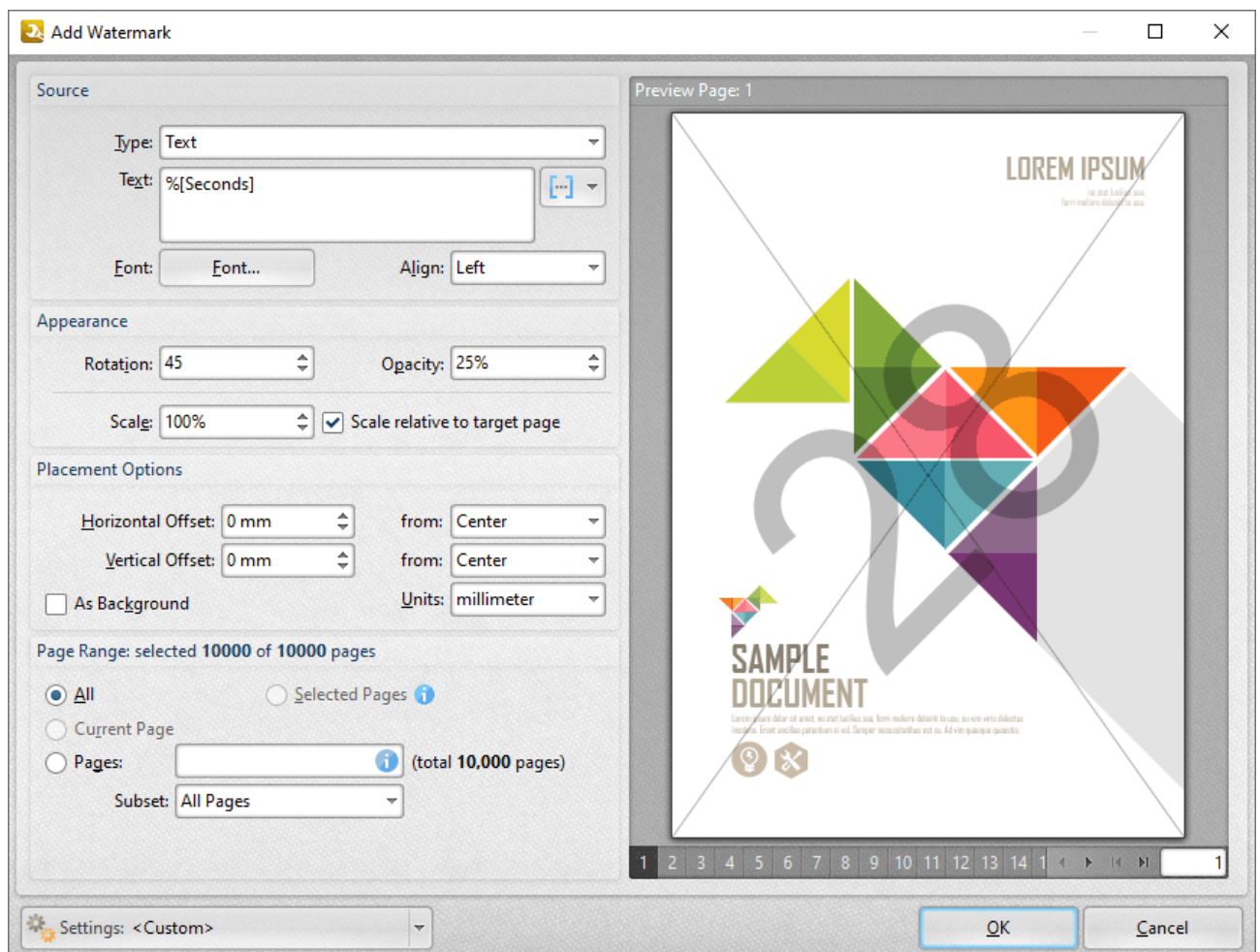

Figure 1. %[Seconds] Macro Example

Note that this macro is often used in conjunction with other macros in order to create combined output. For example the combined macros **%[Hour]:%[Minute],%[Seconds]** output the hour followed by the minutes of the hour and the seconds of the minute:

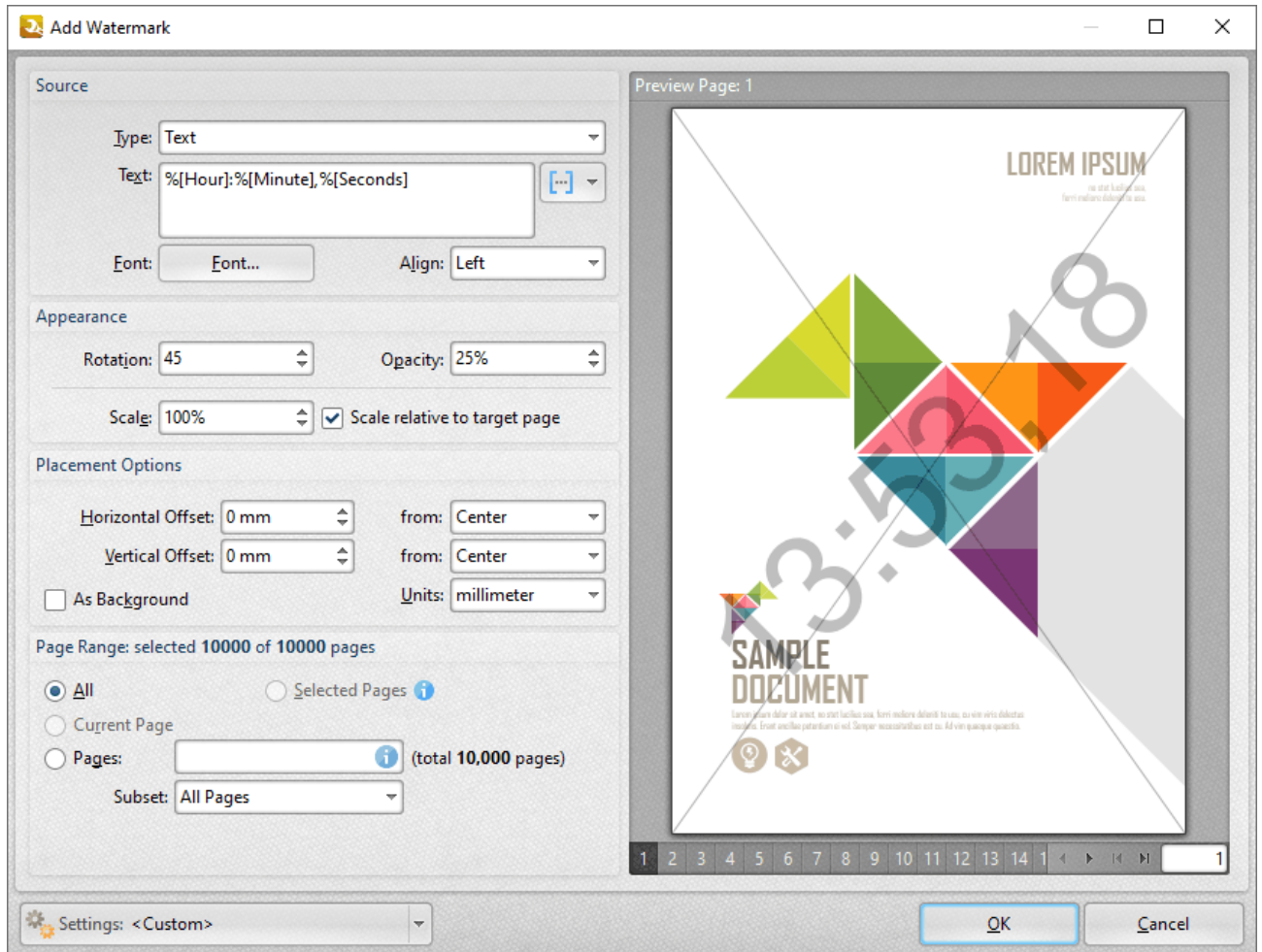

Figure 2. %[Seconds] Combined Macro Example

10.5.12.1:Computer Name



Computer Name

The **Computer Name** inserts the name of the local computer as defined by the **Windows Computer Name**.

The syntax for this macro is **%[Computer]**

Example

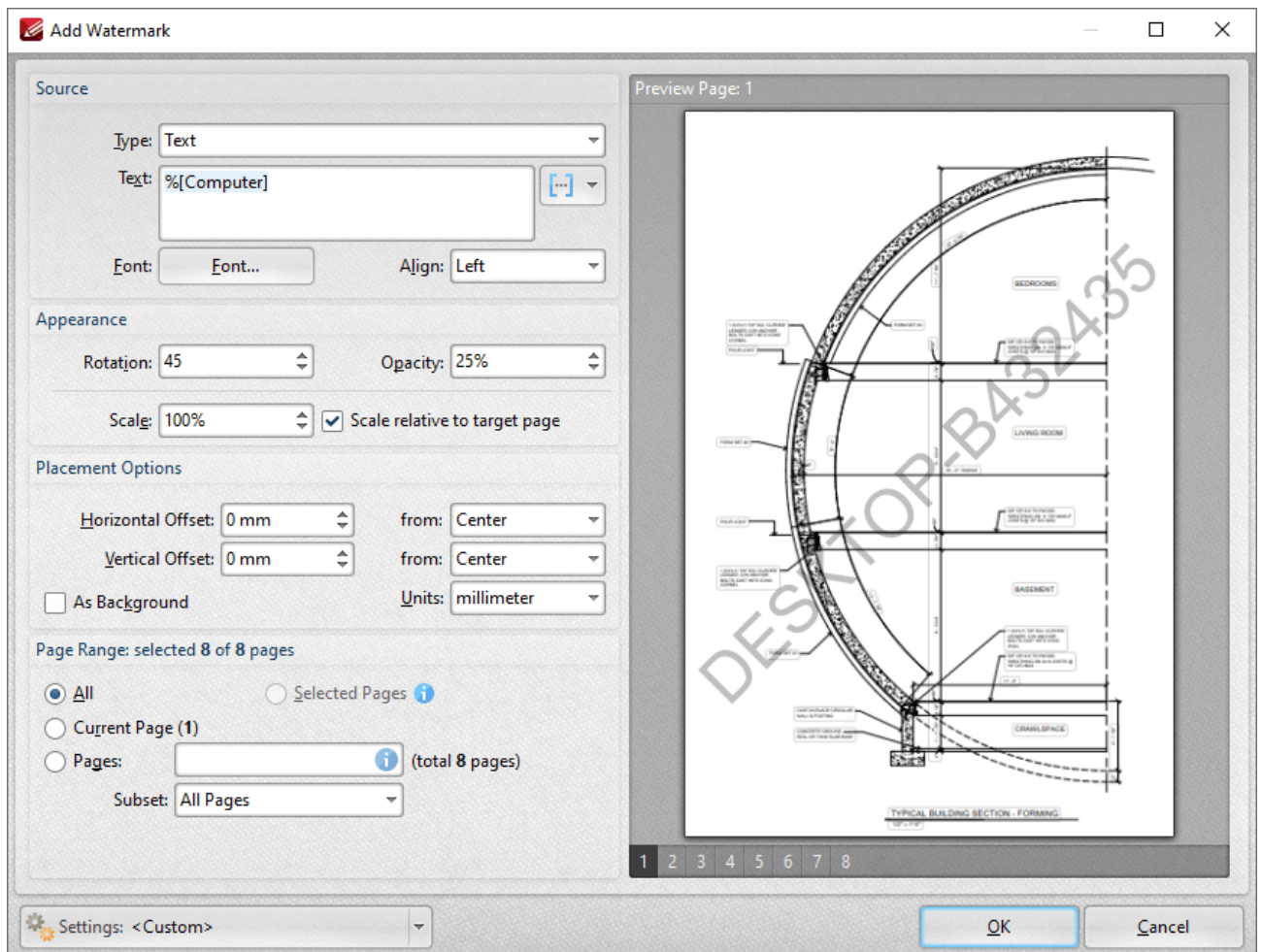

Figure 1. %[Computer] Macro Example



10.5.12.1 Username



**Username**

The **Username** macro inserts the name of the current user.

The syntax for this macro is **%[User]**

**Example**

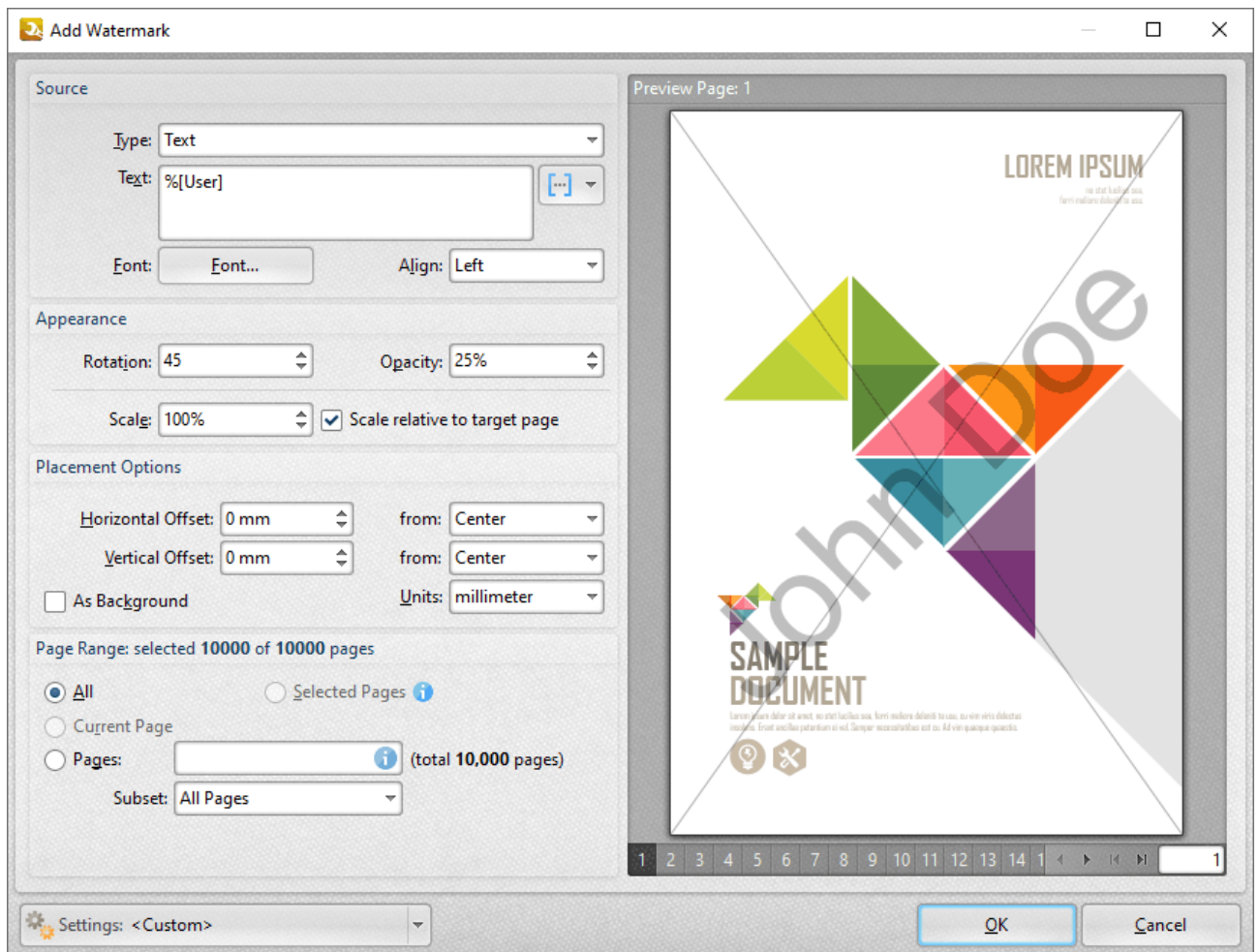

**Figure 1.** %[Username] Macro Example



### 10.5.12.1 Environment Variable

---



## Environment Variable

---

The **Environment Variable** macro inserts information taken from user-specified environment variables.

The syntax for this macro is **%[Env:<Parameter>]**

Note that a parameter must be used in order for this macro to return information. The following parameters are available:

#### **ALLUSERSPROFILE**

Inserts the full path to the *All Users* profile directory.

#### **APPDATA**

Inserts the full path to the *Application Data* directory of the current user.

#### **CommonProgramFiles**

Inserts the full path to the *Common Files* directory.

#### **CommonProgramFiles(x86)**

Inserts the full path to the *(x86) Common Files* directory in 64-bit versions of **Windows**.

#### **CommonProgramFilesW6432**

Inserts the full path to the *Common Files* directory in 64-bit versions of **Windows**.

#### **COMPUTERNAME**

Inserts the computer name.

#### **HOMEDRIVE**

Inserts the drive letter on the local computer that is connected to the user's home directory.

### **HOMEPATH**

Inserts the complete path of the current user's *Home* directory, as defined by the user's account properties.

### **LOCALAPPDATA**

Inserts the complete path to the current user's *Application Data* directory.

### **LOGONSERVER**

Inserts the name of the domain controller that authenticated the client's logon request.

### **OS**

Inserts the name of the operating system.

### **PROCESSOR\_ARCHITECTURE**

Inserts the chip architecture of the CPU.

### **ProgramData**

Inserts the full path to the *All Users* profile directory.

### **ProgramFiles**

Inserts the full path to the *Program Files* directory.

### **ProgramFiles(x86)**

Inserts the full path to the *(x86) Program Files* directory in 64-bit versions of **Windows**.

### **ProgramFilesW6432**

Inserts the full path to the *Program Files* directory in 64-bit versions of **Windows**.

### **PUBLIC**

Inserts the full path to the *Public* directory.



**SESSIONNAME**

Inserts the session name and number when a client is connected via a terminal server.

**SystemDrive**

Inserts the name of the drive on which the system folder was placed.

**SystemRoot**

Inserts the name of the system folder.

**TEMP**

Inserts the name of the default temporary folder used by the operating system and applications available to the current user.

**TMP**

Inserts the name of the default temporary folder used by the operating system and applications available to the current user. (Note that some applications require the **TEMP** environment variable, whilst others require **TMP**. The values for both should be identical).

**USERDOMAIN**

Inserts the name of the user domain that contains the account of the current user.

**USERDOMAIN\_ROAMINGPROFILE**

Inserts the name of the user domain for RDS or standard roaming profile paths.

**USERNAME**

Inserts the name of the current user.

**USERPROFILE**

Inserts the location of the current user's profile directory.

**windir**

Inserts the full path to the *Windows* directory.

**Example**

**%[Env:CommonProgramFiles]** inserts the full path to the *Common Files* directory:

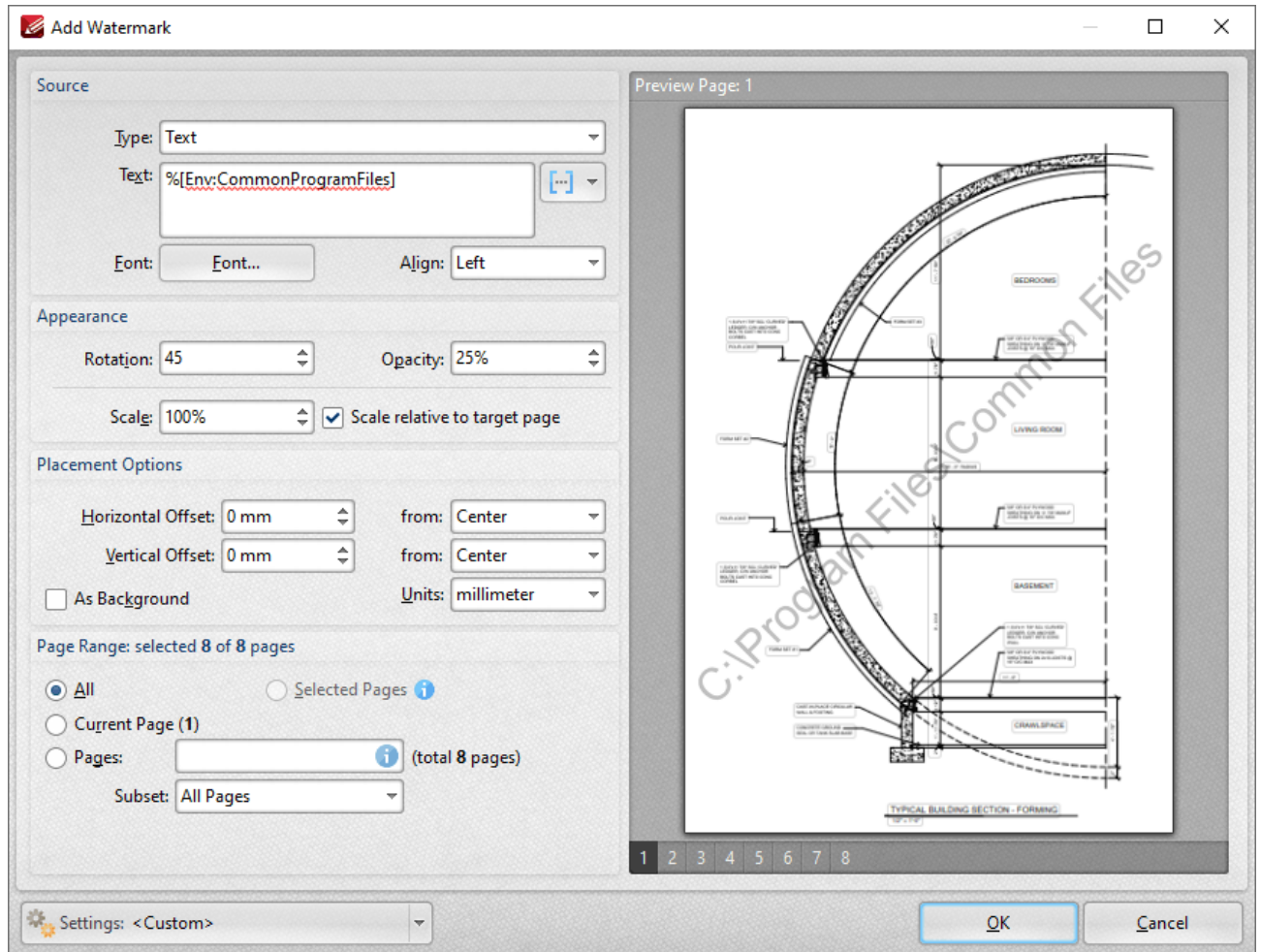

**Figure 1.** [Env:CommonProgramFiles] Macro Example

Further information on environment variables is available [here](#).

### 10.5.12.2 Auto Number

---



## Auto Number

---

The **Auto Number** macro inserts a numerical value as the name for output files.

The syntax for this macro is **%[AutoNumber]** and two sections of parameters are available.

The first section determines the format of page numbers:

- **'r'** specifies the use of lower-case roman numerals.
- **'R'** specifies the use of upper-case roman numerals.
- **'L'** specifies page labels as the page numbering format in cases where page labels have been specified. If page labels have not been specified then standard page numbers are used.
- **'<integer>'** specifies the minimum number of digits displayed for page numbers. This value can be any positive integer from 1 to 12 - for example **%[Autonumber:4]** starts the numbering as **"0001, 0002, 0003..."**.

The second section determines the offset for the start value. Note that the default offset is zero and the default starting value is 1. This means that if, for example, you want to start from 5, then you must specify '4'.

Please note that a semicolon must be used to delimit the sections of parameters. If the second section is not used then the semicolon can be omitted. However, if the first section is not used and the second section is used, then it is necessary to use the semicolon.

The syntax for this macro when both parameters are used is **%[Autonumber:<Parameter 1>;<Parameter 2>]**

The syntax for this macro when only the second parameter is used is **%[Autonumber;;<Parameter 2>]**. For example, **'%[AutoNumber;;3]'** sets the start value as four.

Note that the starting value for output files depends on files contained in the destination folder. If the folder is empty, or does not contain files with names that match the output parameters detailed above, then the default values are used. If the folder does contain files that match the output parameters detailed above, then the starting value will be the lowest possible integer.

## Example

Follow the steps below to use the **Auto Number** macro to name extracted document pages:

1. Open a multi-page document in **PDF-XChange Editor**.
2. Click the **Organize** tab, then click **Extract Pages**. The **Extract Pages** dialog box will open.
3. Enter the desired page range for extraction in the **Page Range** section.
4. Enter the desired **[AutoNumber]** macro in the **Filename** text box:

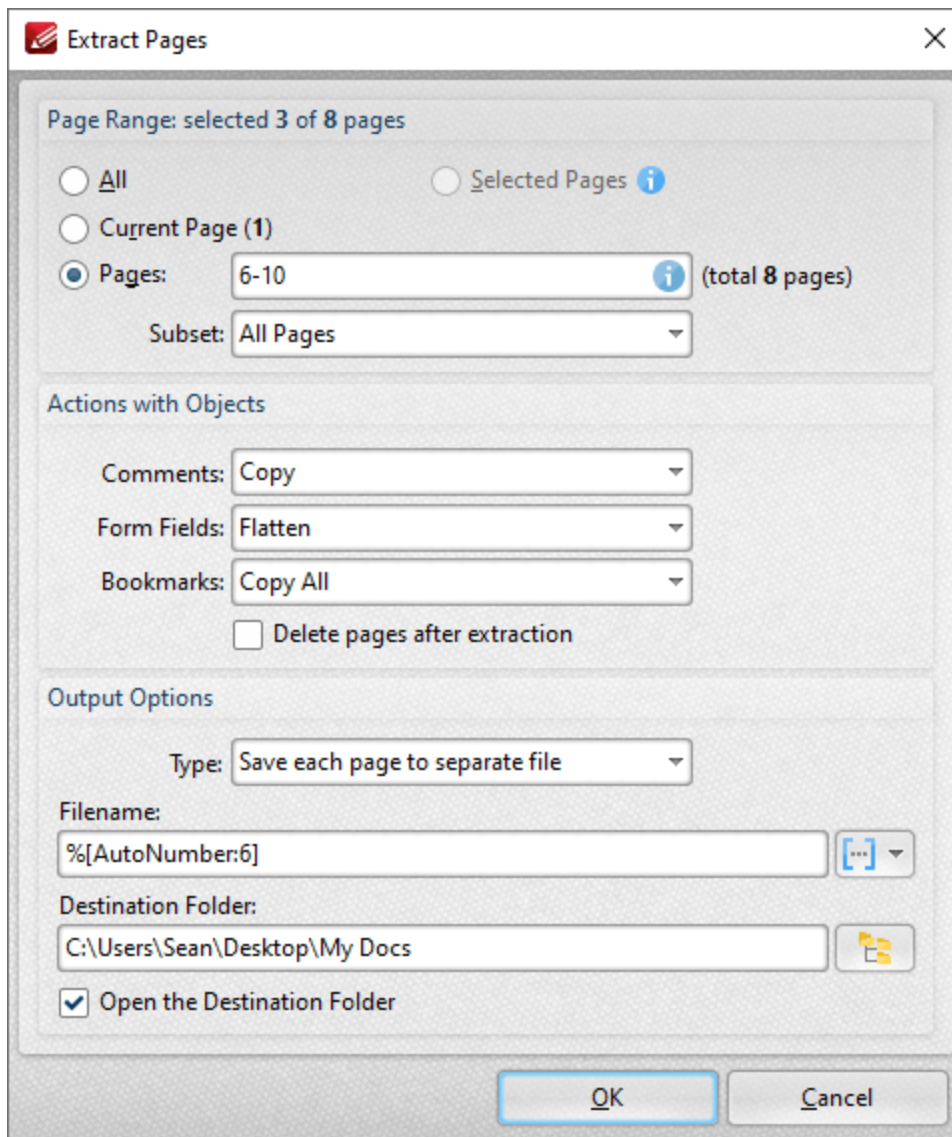
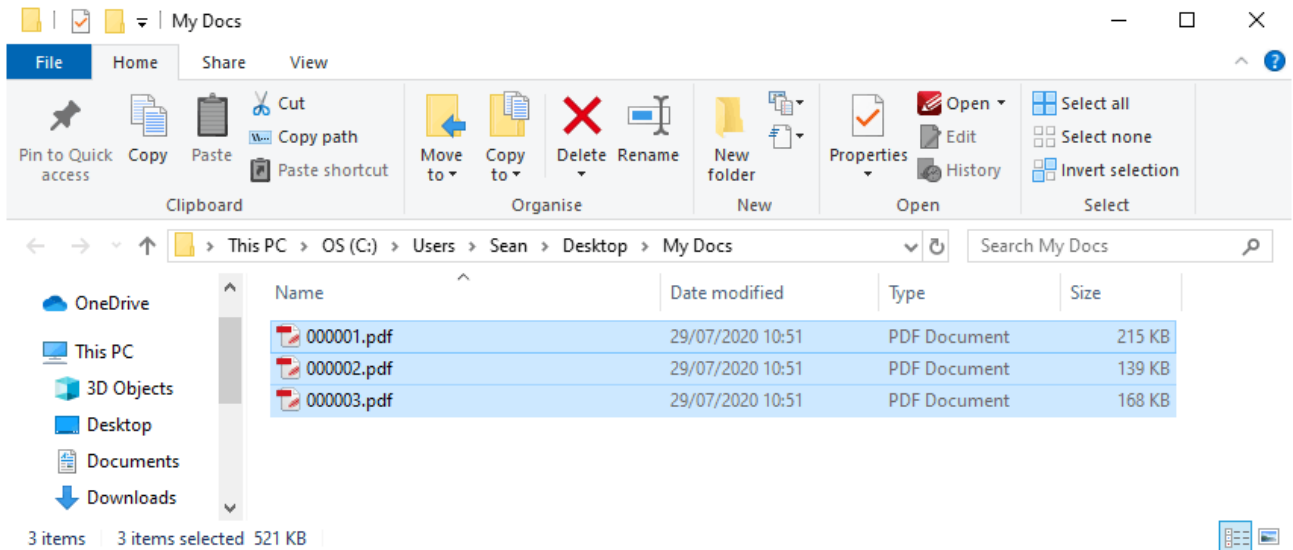

Figure 1. Extract Pages Dialog Box

5. Click **OK**. The pages will then be extracted from the document and autonumbered:



**Figure 2.** Output Files

Note that each file name uses six digits as the parameter '6' was used.

---

10.5.12.2:Application Version



Application Version

The **Application Version** macro inserts the build and version of **PDF-XChange Editor** on the local computer.

The syntax for this macro is **%[AppVersion]**

Example

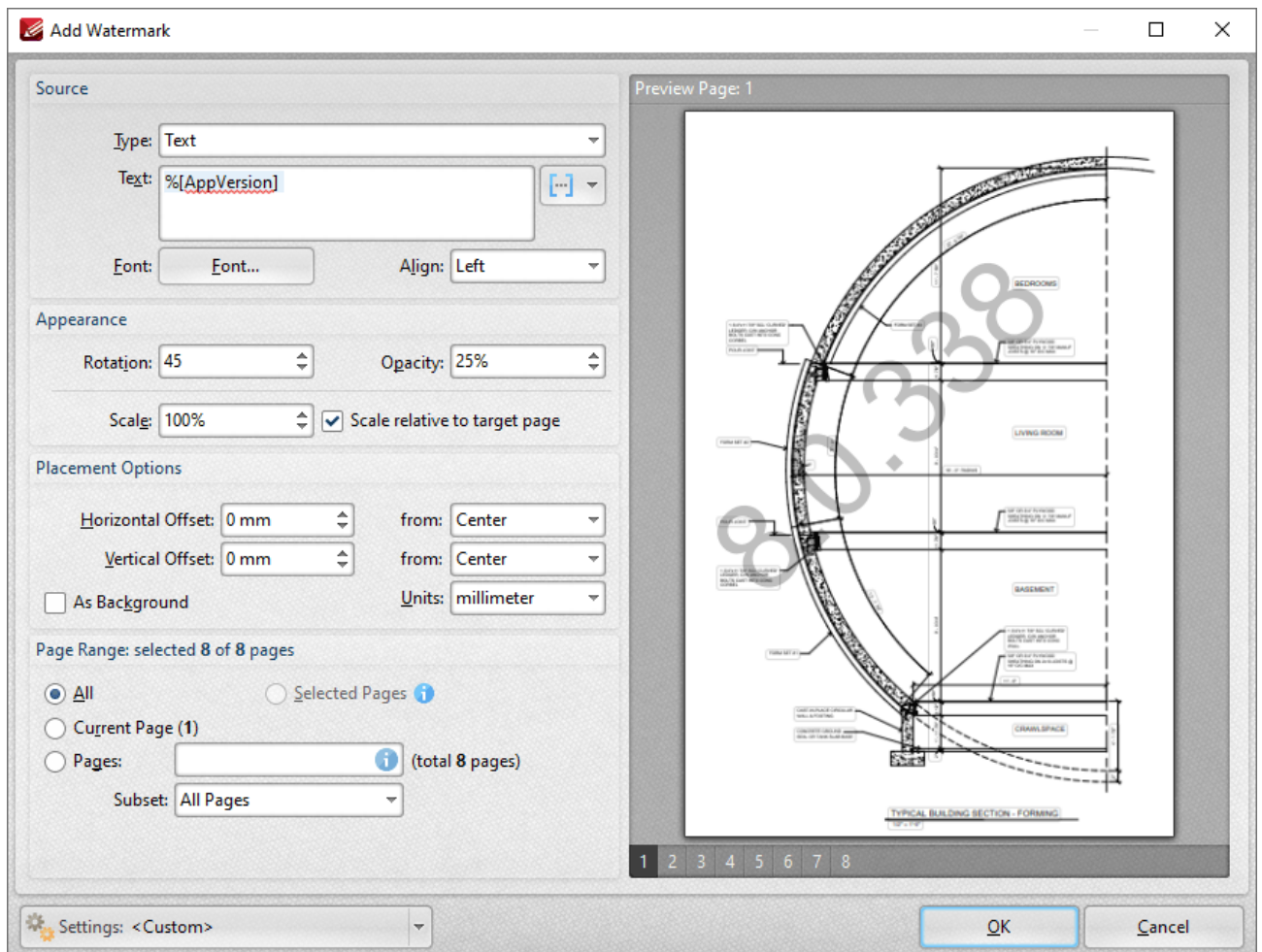

Figure 1. %[Application Version] Macro Example



10.5.12.2:Macro-Enabled Operations



**Macro-Enabled Operations**

Macros are available for the following operations:

| OPERATION                    | LOCATION  |
|------------------------------|---|
| <b>Add Header and Footer</b> | <b>Document Tab&gt; Header and Footer&gt; Add</b>   |
| <b>Bates Numbering</b>       | <b>Document Tab&gt; Bates Numbering&gt; Add/Add to Multiple Files</b>   |
| <b>Extract Pages</b>         | <b>Document Tab&gt; Extract Pages</b>   |
| <b>Export to Images</b>      | <b>File Tab&gt; Export to Images</b>  |
| <b>From Image File(s)</b>    | <p>1. <b>File Tab&gt; New Document&gt; From Image File(s)</b> then click <b>Options</b>. The <b>Images to PDF</b> dialog box will open. Select <b>Image Labels</b> in the <b>Categories</b> menu. Macros can be used in the text box.</p> <p>2. <b>Document Tab&gt; Insert Pages &gt; Insert Images</b> then click <b>Options</b>. The <b>Images to PDF</b> dialog box will open. Select <b>Image Labels</b> in the <b>Categories</b> menu. Macros can be used in the text box.</p> |
| <b>From Text Files</b>       |   |



|                                  |   |
|----------------------------------|---|
|                                  | <p>1. <b>File Tab &gt; New Document &gt; From Text Files</b> then click <b>Options</b>. The <b>Options</b> dialog box will open. Select <b>File Separator</b> in the <b>Categories</b> menu. Macros can be used in the text box.</p> <p>2. <b>Document Tab &gt; Insert Pages &gt; Insert Text</b> then click <b>Options</b>. The <b>Options</b> dialog box will open. Select <b>File Separator</b> in the <b>Categories</b> menu. Macros can be used in the text box.</p> |
| <p><b>Launch Application</b></p> | <p><b>Edit Tab &gt; Preferences &gt;</b> then select <b>Launch Applications</b> in the <b>Categories</b> menu and click <b>New</b>. The <b>New Launch Application</b> dialog box will open. Macros can be used in the <b>Parameters</b> text box. Note that a different set of macros is used for this feature. See <a href="#">here</a><sup>[895]</sup> for further information.</p>   |
| <p><b>Stamps Palette</b></p>     | <p><b>Tools Tab &gt; Comment And Markup Tools &gt; Stamps Palette</b> then click <b>Add New</b> and select a file to be used as a stamp, or click <b>New Stamp from Active Document</b>. The <b>Add New Stamp</b> dialog box will open. Macros can be used in the <b>Stamp Title</b> text box.</p>  |
| <p><b>Summarize Comments</b></p> | <p><b>Comments Tab &gt; Summarize Comments</b>. Macros can be used in the <b>Filename</b> text box.</p>   |
| <p><b>Watermarks</b></p>         | <p><b>Document Tab &gt; Watermarks &gt; Add &gt;</b>. Macros can be entered in the <b>Text</b> text box.</p>  |

10.5.13 Page Boxes



Page Boxes

PDF documents feature five boxes that determine their content and appearance. They are the **Media Box**, **Crop Box**, **Bleed Box**, **Trim Box** and **Art Box**:

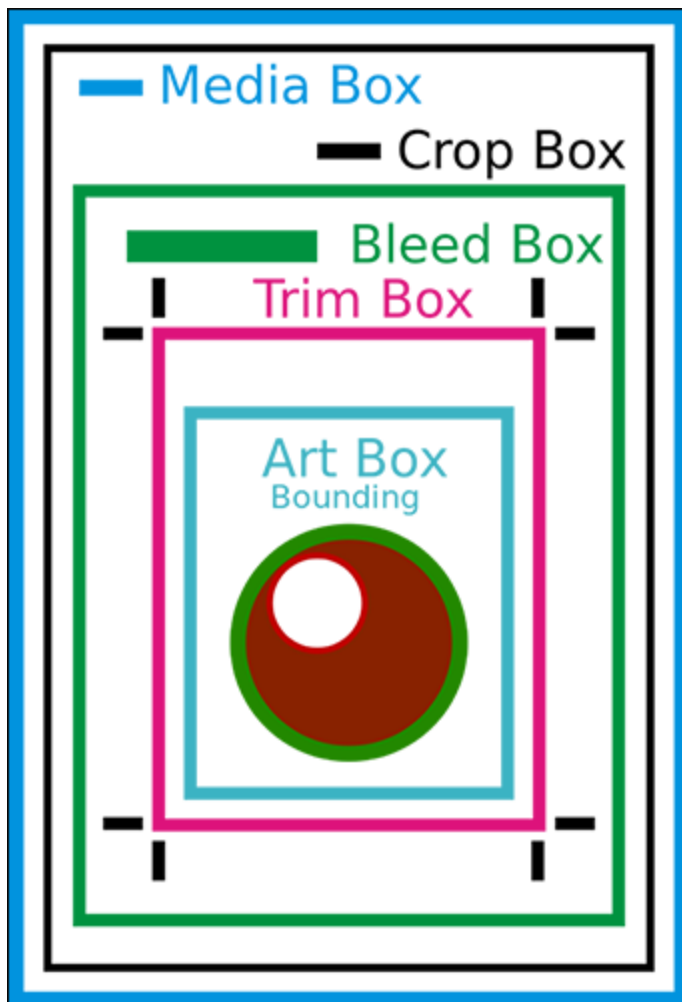

Figure 1. Document Boxes

PDF-XChange Editor uses four of these boxes:

## Crop Box

The **Crop Box** defines the region to which page contents are clipped when displayed or printed. Programs use the dimensions of this box for screen display and printing. Unlike the other boxes, the **Crop Box** has no defined meaning in terms of physical page geometry or intended use - it merely imposes clipping on page contents. However, in the absence of additional information, the **Crop Box** determines how the page contents will be positioned on the output medium.

## Bleed Box

The **Bleed Box** defines the region to which the contents of the page are clipped when output in a production environment. This may include the "bleed area" needed to accommodate the physical limitations of cutting, folding and trimming equipment. Usually the **Bleed Box** is three to five millimeters larger than the **Trim Box**. When a page is printed it may include printing marks that fall outside the **Bleed Box**. The default value of the **Bleed Box** is the value of the **Crop Box**.

## Trim Box

The **Trim Box** defines the intended dimensions of the finished page after trimming has taken place. As opposed to the **Crop Box**, the **Trim Box** is very important because it defines the actual page size. Programs use the **Trim Box** as the basis for positioning pages on a press sheet. The default value of the **Trim Box** is the value of the **Crop Box**.

## Art Box

The **Art Box** defines the extent of the page's meaningful content (including potential white space) as intended by the page's creator. The default value for the **Art Box** is the value of the **Crop Box**.

These boxes can be viewed/edited in the **Crop Pages** dialog box:

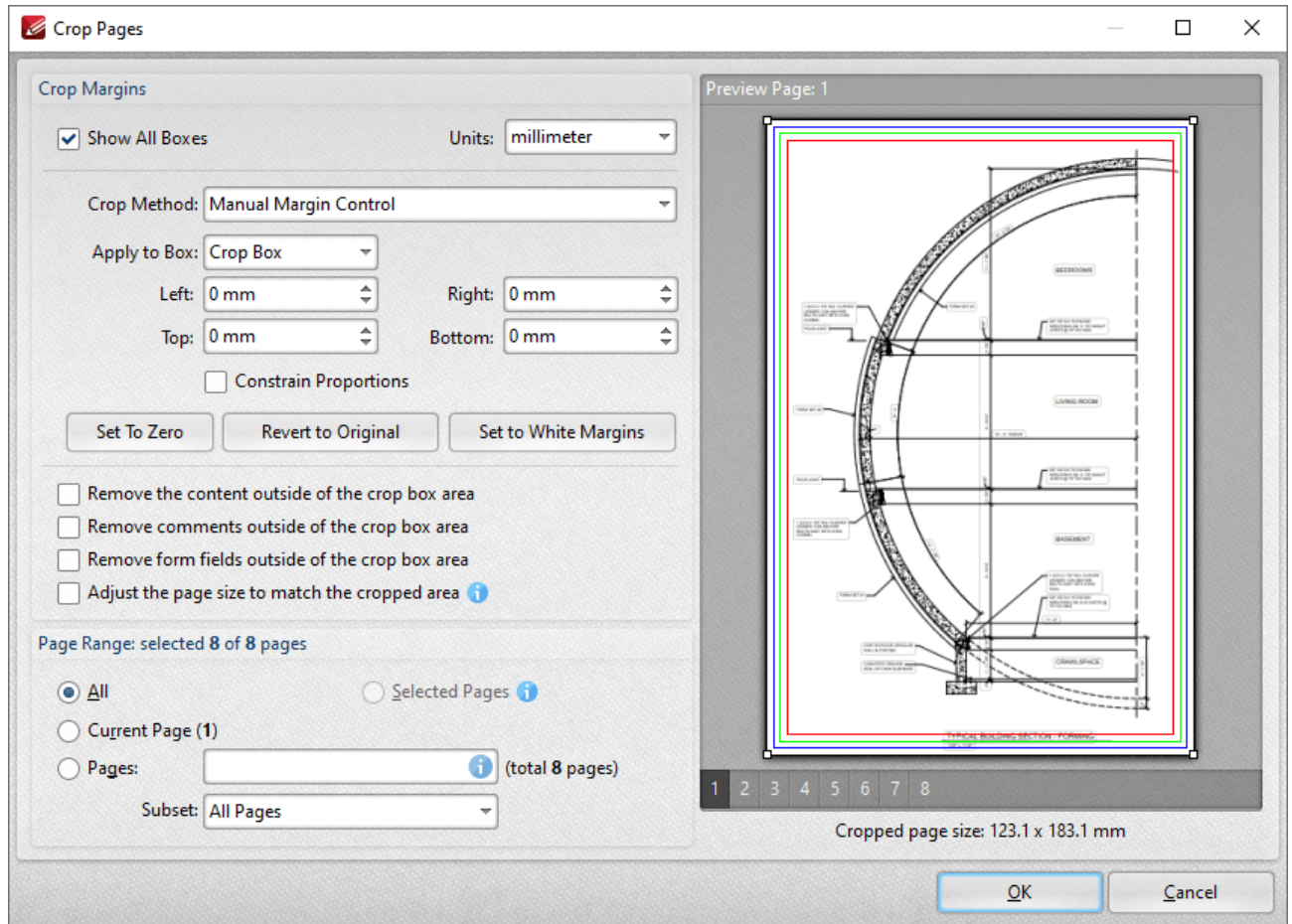

Figure 2. Crop Pages Dialog Box

Click **Crop Pages** in the **Crop** dropdown menu of the **Organize** tab to access these settings. Further information on page boxes is available [here](#).

Note that the [Loupe Tool](#)  contains a feature that can be used to display page boxes.

#### 10.5.14 Page Range Settings

---



### Page Range Settings

---

Page range settings are available in many of the **PDF-XChange Editor** dialog boxes. Follow the rules detailed below to customize page ranges:

- Use commas to delimit individual pages.
  - Use hyphens to delimit page ranges.
  - Use commas to delimit page ranges if multiple page ranges are being defined.
  - Use a dash before a page number to determine all pages from the beginning of the document to the specified page. For example **-7** defines all pages from the beginning of the document to page seven.
  - Use a dash after a page number to determine all pages from the specified page to the end of the document. For example **7-** defines all pages from page seven to the end of the document.
-

### 10.5.15 Read Out Loud Feature

---



### Read Out Loud Feature

---

This feature of **PDF-XChange Editor** enables the software to "read out loud" document text. Follow the steps below to use this feature:

1. Click the **Home** tab, then click **Select Text**.
2. Select the text to be read out loud.
3. Right-click the text.
4. Click **Read Selected Text Out Loud** in the submenu:

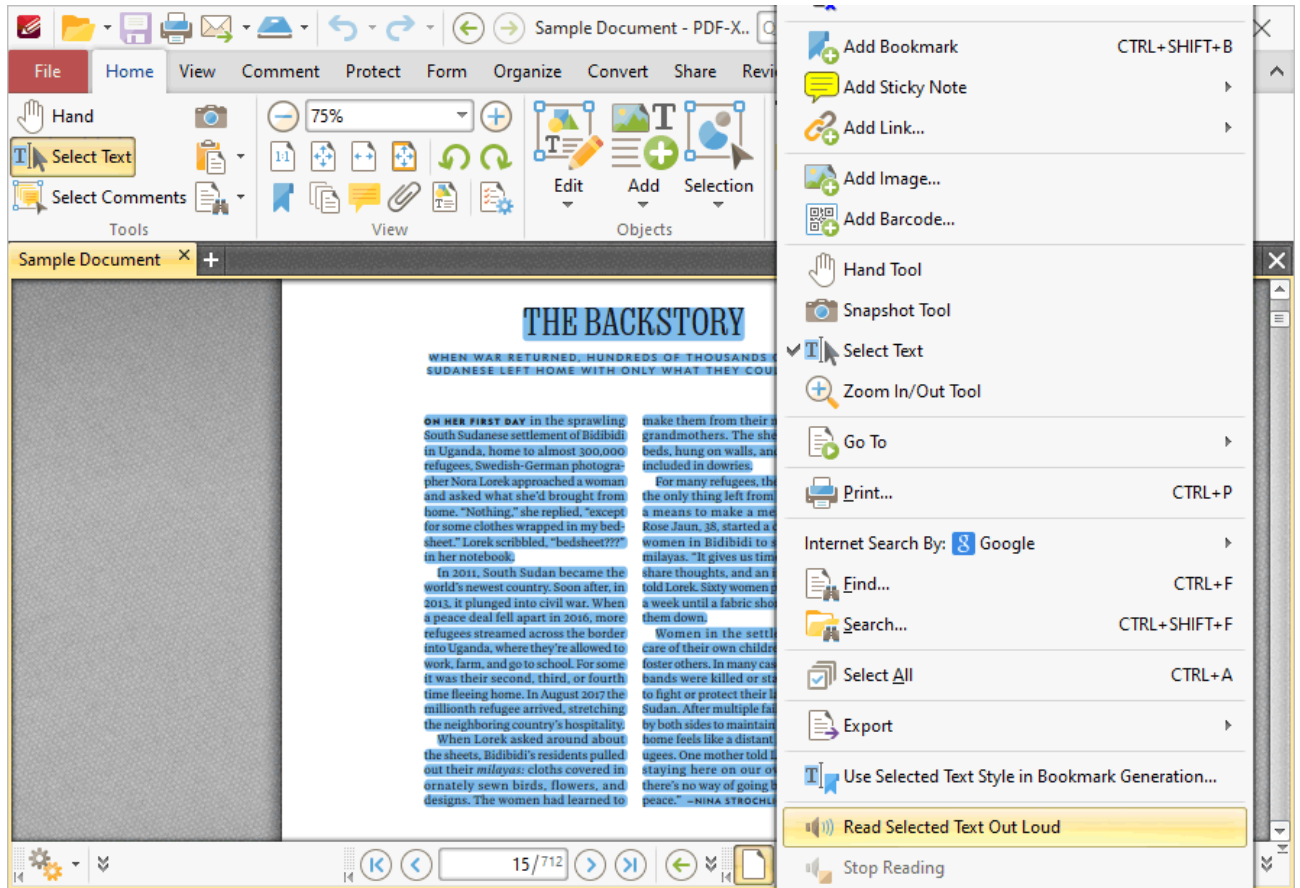

Figure 1. Home Tab, Select Text Tool, Read Selected Text Out Loud

The selected text will be read out loud according to the settings determined [here](#).<sup>928</sup> Click **Stop Reading** to cancel the process.

10.5.16 Search



**Search**

Click **Search** (or press Ctrl+Alt+F) to launch the **Search** pane:

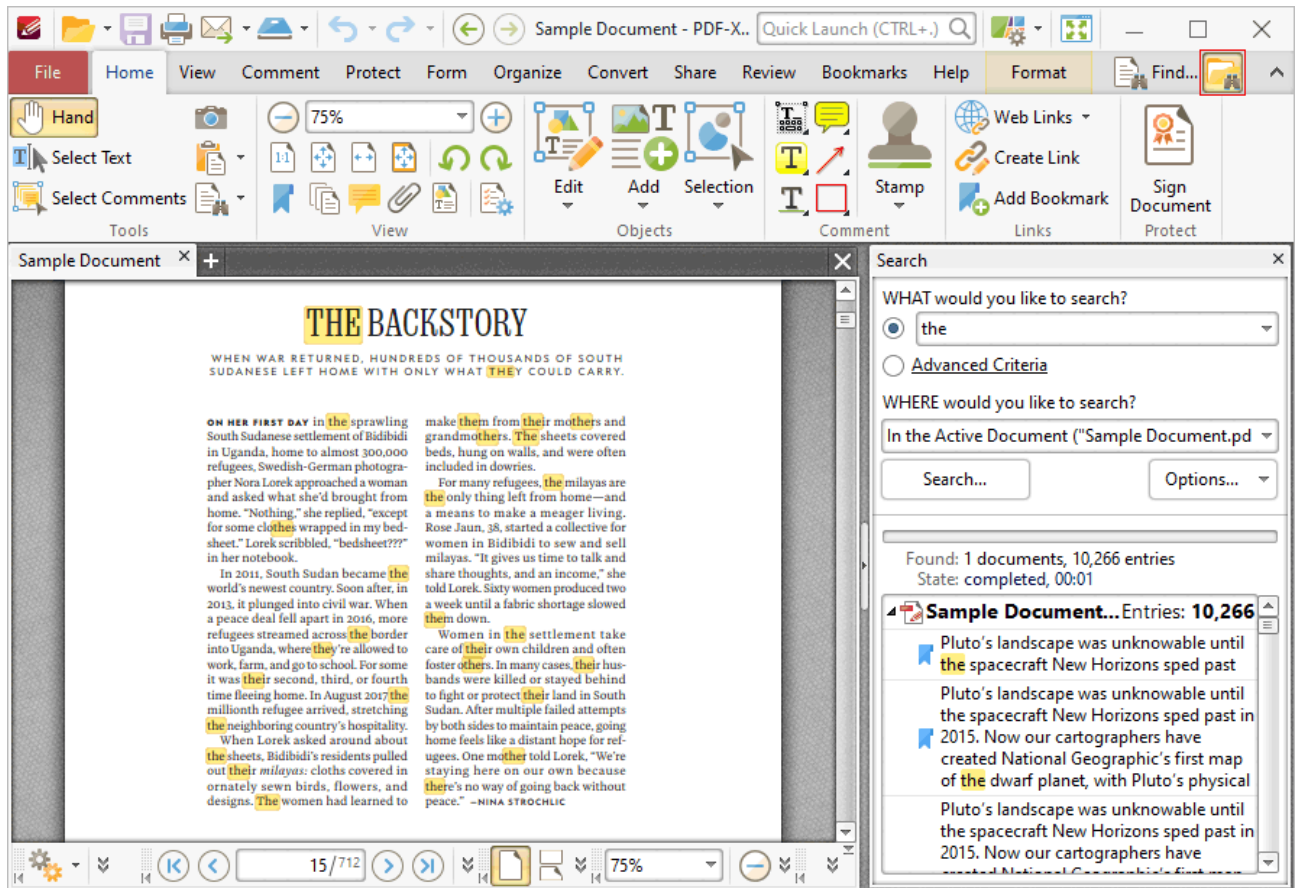

Figure 1. Search Function

The **Search** pane is used to search documents open in **PDF-XChange Editor** or folders on the local computer:



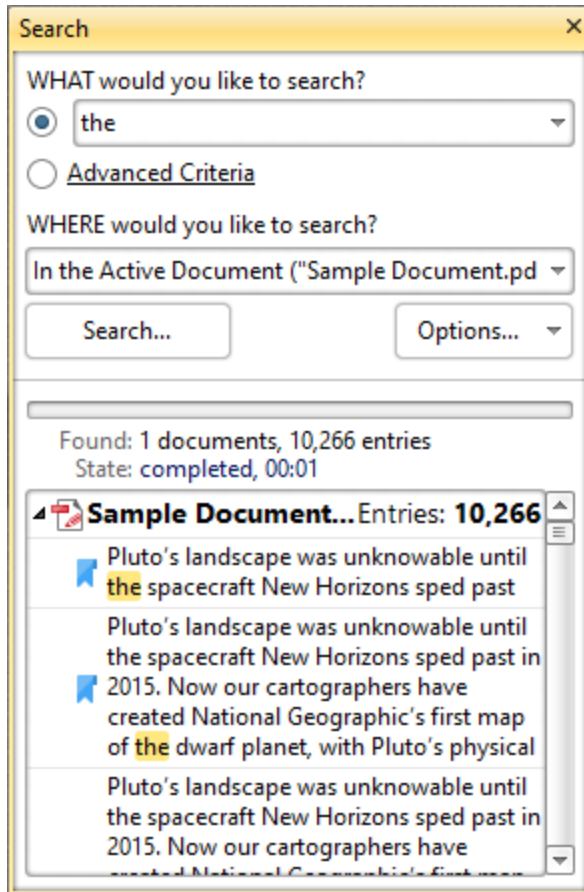

Figure 2. Search Pane

- Enter the search terms in the upper text box or select **Advanced Criterion**, which is explained below.
- Use the lower text box to select where the search will take place:
  - **In the Active Document** searches only the active document.
  - **In All Open Documents** searches all documents currently open in **PDF-XChange Editor**.
  - **Browse for Folder** launches the **Select Folder** dialog box. Select the desired folder on the local computer and then click **Select**. The folder will be added to the search location box.
- Click the **Options** button to determine further search variables. These are explained beneath (**figure 4**) below.
- Click the **Search** button to execute the search. The results will be displayed in the lower section of the pane.

Click **Advanced Criteria** to enable additional search options:

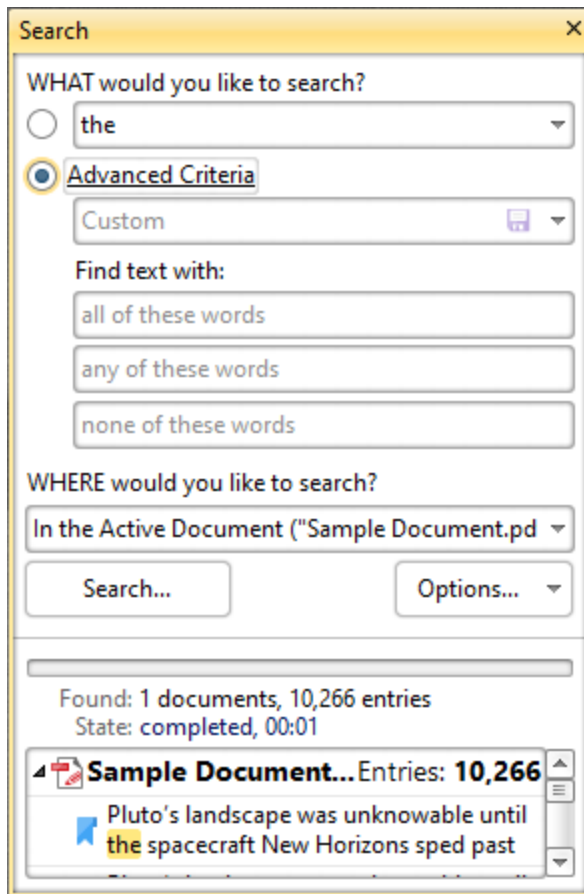

Figure 3. Advanced Criterion Options

- Use the arrow on the right side of the **Custom** text box to select a predefined search. If no searches have been predefined then the **Custom** option is not available.
- Use the three **Find text with:** text boxes to determine the search parameters:
  - If search terms are entered in the **all of these words** text box, then the results will include only text strings that contain all the entered search terms.
  - If search terms are entered in the **any of these words** text box, then the results will include text strings that contain any of the entered search terms.
  - If search terms are entered in the **none of these words** text box, then the results will exclude text strings that contain any of the entered search terms.

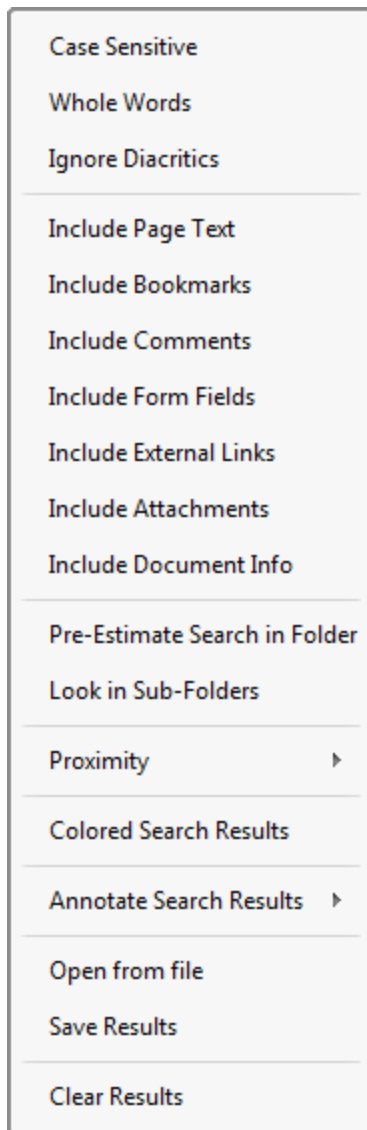



Figure 4. Search Options

- Select **Case Sensitive** to include the case of search terms in the search.
- Select **Whole Words** to return only whole words.
- Select **Ignore Diacritics** to ignore accents, cedillas and other similar symbols in the search.
- Select **Include Page Text** to include text on pages of the document in the search.
- Select **Include Bookmarks** to include bookmark names in the search.
- Select **Include Comments** to include comment text in the search.
- Select **Form Fields** to include form field text in the search.
- Select **Include External Links** to include links to external locations/files in the search.
- Select **Include Attachments** to include embedded documents in the search.
- Select **Include Document Info** to include document metadata/information in the search.
- Select **Pre-Estimate Search in Folder** to have **PDF-XChange Editor** perform a folder count prior to the search. This facilitates exact search progress in the progress bar when searches take place.

- Select **Look in Sub-Folders** to include all directory subfolders in the search.
  - Select **Proximity** to determine the proximity of returned results. The options are:
    - **Only Adjacent Words**
    - **Words from the Same Paragraph**
    - **Words from the Same Page**
    - **Words from the Same Document**
  - Select **Colored Search Results** to highlight matching terms after the search has taken place.
  - Click an option in the **Annotate Search Results** submenu to enable annotation options after the search has taken place. The options are:
    - **Highlight Search Results**
    - **Underline Search Results**
    - **Strikeout Search Results**
    - **Redact Search Results**
    - Click **Comment Styles Palette** to launch the [Comment Styles Palette](#)  for further annotation options.
  - Click **Open from file** to open a previous search that was saved to file using the option below.
  - Click **Save Results** to save the results of the most recent search operation.
  - Click **Clear Results** to clear the search results list.
-

10.5.17 Shell Extensions



Shell Extensions

PDF-XChange Editor features a **Windows** shell extension that causes thumbnails of PDF files to display in **Windows Explorer** when thumbnails are selected as the file display mode. The first page of PDF documents is displayed, instead of the standard PDF document icon, which makes the process of viewing/selecting files more efficient. Note that the folders must set to display medium, large or extra-large icons for the thumbnails to be visible:

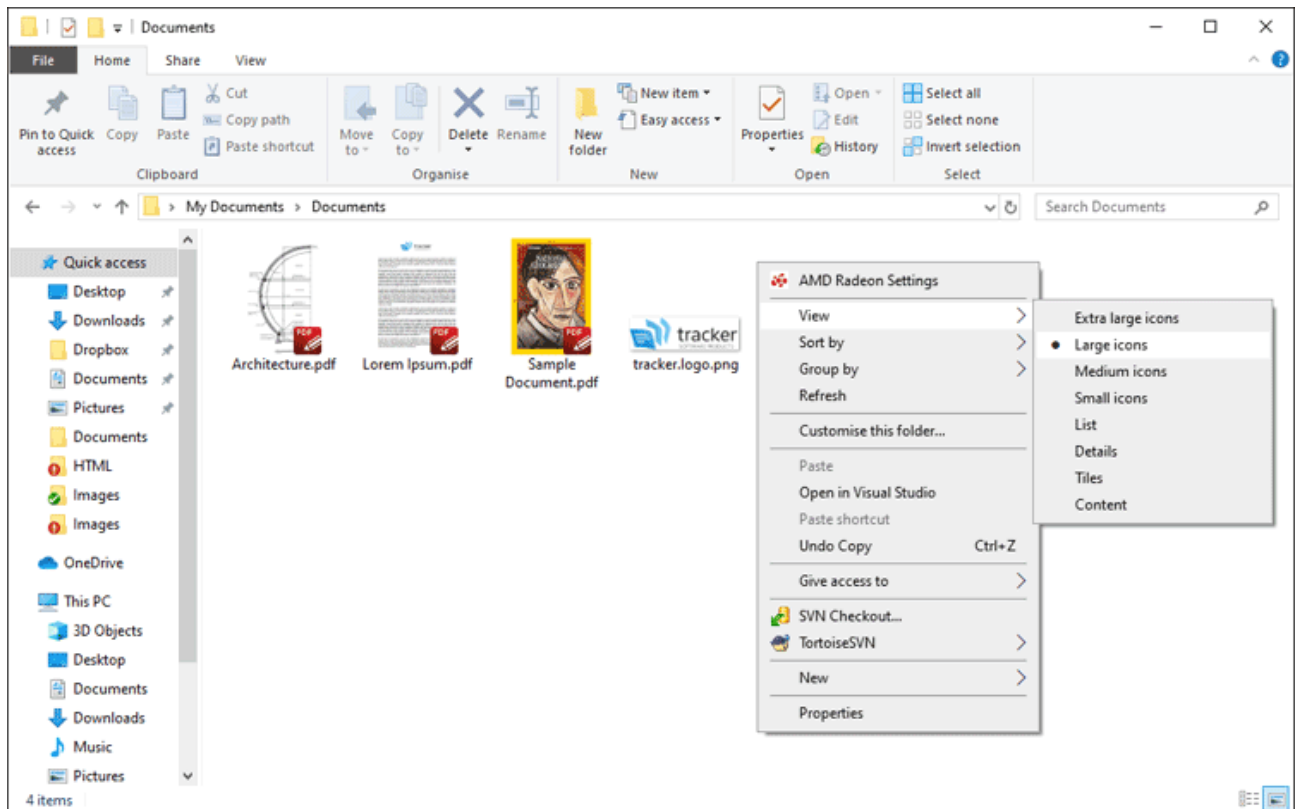

Figure 1. Shell Extensions Example

iFilter

The shell extension feature includes the **PDF iFilter**, which is a search tool. This tool can be used to index PDF documents with **Microsoft iFilter** indexing. This means that **Windows** will locate search

terms through not only document names, but also text within documents, annotations, bookmarks, document XMP information and files attached/embedded within documents. This process takes place automatically when the standard **Windows** search option is used. The **PDF iFilter** integrates into existing **Windows** operating systems and thus provides a convenient way to search text within PDF documents on the local computer and company network/intranet, as well as greatly increasing your ability to accurately locate many forms of information contained within your PDF documents.

---

### 10.5.18 Tool Content Options



---





#### Tool Content Options

---



A range of editing options are available for content created with the **PDF-XChange Editor** tools. The options available depend on the format of selected content. Right-click content to view editing options. The submenu below contains all options:

-  **O**pen Pop-Up Note
-  **H**ide Pop-Up Note
-  **R**eset Pop-Up Note Location

---

-  **C**ut Shift+Delete
-  **C**opy Ctrl+C
-  **P**aste Shift+Insert



---

-  **D**elete Delete
-  **F**latten Selected Comments

---

-  **F**it Box by Text Content

---

-  **A**dd Reply
-  **S**tatus ▶

---

-  **A**rrange ▶

---

-  **S**et Scale ▶



---

-  **E**xport Measurements to CSV File...

---

-  **R**estore Caption Placement

---

-  **E**dit Label...
-  **D**elete Label...

---

-  **D**eselect

---

-  **C**ontrol Points ▶

---

-  **A**uto Adjust Arm Position

---

-  **F**lip **L**ine

---

-  **C**onvert to Distance

---

-  **C**onvert to Perimeter

---

-  **T**ransform to Quadrilateral

---

-  **S**tyle Tools ▶

---

-  **E**xport ▶

---

-  **P**roperties...



Figure 1. Tool Content Right-Click Menu

- Click **Open Pop-Up Note** to view the content pop-up note. Pop-up notes are created automatically when content is created. (Note that in the case of the [Measuring Tools](#)<sup>1206</sup> it is necessary to use the **Edit Label** and **Delete Label** options, detailed below, to edit/delete note content). Highlight note content and then use the options in the [Format Tab](#)<sup>1624</sup> in edit its appearance.
- Click **Hide Pop-Up Note** to close the view/edit pane of content pop-up notes.
- Click **Reset Pop-Up Note Location** to reset the location of content pop-up notes.
- Click **Cut, Copy, Paste** or **Delete** to perform these operations on selected content.
- Click **Flatten Selected Comments** to flatten selected comments to the base content layer of documents.
- Click **Fit Box by Text Content** to fit the size of the selected box to the text that it contains. This feature is available for the **Text Box, Callout** and **Typewriter** tools.
- Click **Add Reply** to add replies to existing pop-up notes.
- Select an option from the **Status** submenu to define the status of content for subsequent editing. The options are **Accepted, Cancelled, Completed** and **Rejected**.
- Use the **Arrange** submenu arrange/edit selected content:
  - Click the **Align** options to align selected content items.
  - Click **Rotate 90° CCW, Rotate 90° CW** or **Rotate 180°** to rotate selected content.
  - Click **Flip Horizontal/Vertical** to flip selected content horizontally/vertically.
  - Click **Transform** to edit the position and/or size of selected content as detailed [here](#).<sup>948</sup>
  - Click **Duplicate** to duplicate selected content as detailed [here](#).<sup>950</sup>
  - Click **Bring Forward** to bring selected content items forward one step in cases of multiple objects overlapping.
  - Click **Send Backward** to send selected content back one step in cases of multiple objects overlapping.
  - Click **Bring to Front** to bring selected content to the front in cases of multiple objects overlapping.
  - Click **Send to Back** to send selected content to the back in cases of multiple objects overlapping.
- Use the **Set Scale** submenu to select a scale for selected content:
  - Click a scale to select a predefined scale from the list.
  - Click **Manage Measurements** to view/edit the list of predefined scales. Use **Delete** and **Edit** buttons to delete/edit selected scales. Use the **Clone** button to clone predefined scales. Cloned scales can be edited and saved for subsequent use.
  - Click **Calibrate Measurement** to create a new scale as detailed [here](#).<sup>1224</sup>
- Click **Export Measurements To CSV File** to export output of the [Measuring Tools](#)<sup>1206</sup> to a comma-separated-values file. Note that when documents that contain perimeter or area annotations are exported to comma-separated-values, the output document will contain an **"Alt. Value"** column for annotations. This value details the area of perimeter annotations and the perimeter of area annotations.
- The **Restore Caption Placement** feature will be added in a future build.

- Click **Edit Label** to edit the pop-up note of selected content. Please note that it is not possible to remove the scale reference figure that the [Measuring Tools](#)<sup>1206</sup> create.
- Click **Delete Label** to delete information that has been added to the label. Please note that it is not possible to remove the scale reference figure that the **Distance Tools** create.
- Click **Deselect** to deselected selected content.
- Use the **Control Points** submenu to add/delete control points as desired:
  - Click **Add Point** to add new control points.
  - Right-click control points and then select **Delete Point** to delete points.
- The **Auto Adjust Arm Position** option is used in conjunction with the callout arm of the **Callout Tool**. When this setting is enabled the control point from which callout arms originate changes automatically. The control point closest to the end of the callout arm is used. When this setting is disabled the control point from which the callout arm originates remains constant when callout text boxes are repositioned.
- Click **Flip Line** to flip content through one hundred and eighty degrees.
- Click **Convert to Distance** to convert selected line annotations into distance annotations.
- Click **Convert to Perimeter** to convert selected polygon line annotations into perimeter annotations.
- Click **Transform to Quadrilateral** to enable link shape editing when using the **Link Tool** or the **Redaction** feature. Click and drag the inner control points to edit the shape. When this option is enabled it is replaced in the submenu with the option to **Transform to Rectangle**. Click this option to revert to the default mode. Selected links will update automatically. Please note that the [Link Creation Tool](#)<sup>956</sup> must be selected in order to edit/delete links.
- Click **Style Tools** to view style options for selected content:
  - Click **Copy Comment Style** to copy the style properties of selected content, such as the **Fill Color**, **Border Style** and **Opacity** value. (Use the [Properties](#)<sup>1065</sup> pane to view/edit content properties).
  - Click **Apply Copied Comment Style** to apply copied comment and text properties to selected content.
  - Click **Apply Copied Comment Appearance** to apply copied comment properties to selected content.
  - Click **Apply Copied Text Style** to apply copied text styles to selected text. Right-click selected text to copy text styles, as detailed [here](#).<sup>1683</sup>
  - Click **Make Current Properties Default** to set the properties of selected content as the default properties for subsequent content of the same format.
  - Click **Apply Default Properties** to apply default content properties to selected content.
  - Click **Make Current Text Format Default** to set the current text properties as the default text properties for the selected annotation format.
  - Click **Apply Default Text Format** to apply the default text format to selected text. Note that each annotation format has a different default text format.
- Click **Export** to view export options for selected content. Available options depends on the format of selected content. All options are detailed below:
  - Click **Export selection to Microsoft Word Document** to export selected content to (\*.docx) format.

- Click **Export selection to Microsoft Excel** to export selected content to **(\* .xlsx)** format.
- Click **Export selection to Microsoft Powerpoint Presentation** to export selected content to **(\* .pptx)** format.
- Click **Properties** to view/edit content properties in the **Properties** pane, as detailed [here](#).<sup>1085</sup>

Note that the [Comment Styles Palette](#)<sup>1242</sup> is a useful resource that can be used to view/edit comment style properties.

---

10.5.19 Tool Properties



**Tool Properties**

The table below contains all properties available for the **PDF-XChange Editor** tools and comments. Click **Properties** in the [Format Tab](#) when tools are selected to view/edit tool properties in the [Properties](#) pane.

| GENERAL                |   |
|------------------------|---|
| PROPERTY               | DEFINITION  |
| <b>Diameter</b>        | The <b>Diameter</b> property determines the diameter of the <b>Eraser Tool</b> .  |
| <b>Exclusive Mode</b>  | The <b>Exclusive Mode</b> property simplifies the process of using tools. When it is enabled, the pointer ignores all interactive elements of documents other than base content. This makes it possible to create content on areas that overlap with other content without the risk of accidentally selecting undesired items. When <b>Exclusive Mode</b> is disabled, the pointer recognizes and interacts with all underlying elements in the usual manner. |
| <b>Inertial Scroll</b> | The <b>Inertial Scroll</b> property is a dynamic scrolling option. When it is enabled, document pages will continue to scroll and come to a stop gradually after scrolling actions are performed. When it is disabled document pages will scroll in synchronization with the pointer.   |
| <b>Keep Selected</b>   | The <b>Keep Selected</b> property is an editing convenience for tools. When it is enabled tools will remain selected after they are used.   |

|                            |  |
|----------------------------|--|
|                            | When it is disabled the active tool reverts to the designated default tool after a single use.   |
| <b>STYLE</b>               |  |
| <b>Border</b>              | The <b>Border</b> property determines the border style of content.   |
| <b>Blend Mode</b>          | The <b>Blend Mode</b> property determines how content blends with underlying/overlapping content. Further information on this property is available <a href="#">here</a> . |
| <b>Fill Color</b>          | The <b>Fill Color</b> property determines the fill color of content.   |
| <b>Highlight Mode</b>      | The <b>Highlight Mode</b> property determines the visual effect when links created using the <b>Link Tool</b> are selected.  |
| <b>Icon</b>                | The <b>Icon</b> property determines the icon that content uses.  |
| <b>Opacity</b>             | The <b>Opacity</b> property determines the transparency level of content.  |
| <b>Stroke Color</b>        | The <b>Stroke Color</b> property determines the border color of content.   |
| <b>Underline</b>           | The <b>Underline</b> property determines the underline style when the <b>Underline Text Tool</b> is used.  |
| <b>Width</b>               | The <b>Width</b> property determines the width of content.   |
| <b>DEFAULT TEXT FORMAT</b> |  |
|                            | The <b>Font</b> property determines the content font.  |

|                         |  |
|-------------------------|--|
| <b>Font</b>             |  |
| <b>Font Size</b>        | The <b>Font Size</b> property determines the content font size.  |
| <b>Text Alignment</b>   | The <b>Text Alignment</b> property determines the content text alignment.  |
| <b>Text Color</b>       | The <b>Text Color</b> property determines the content text color.  |
| <b>OTHER</b>            |  |
| <b>End</b>              | The <b>End</b> property determines the style of line endings.  |
| <b>End Scale</b>        | The <b>End Scale</b> property determines the scale used for line endings.  |
| <b>Inline Caption</b>   | The <b>Inline Caption</b> property determines whether or not captions are inline captions. If this option is enabled then captions are placed inside annotations instead of on top of annotations. |
| <b>Leader Extension</b> | The <b>Leader Extension</b> property determines the length of optional lines that extend from leader lines when using the <b>Line/Arrow/Distance Tool</b> .  |
| <b>Leader Length</b>    | The <b>Leader Length</b> property determines the length of leader lines.   |
| <b>Leader Offset</b>    | The <b>Leader Offset</b> property determines the length of the offset between the pointer and leader lines.  |
| <b>Scale</b>            | The <b>Scale</b> property determines the scale used for content.   |
| <b>Show Caption</b>     | The <b>Show Caption</b> property determines caption visibility in the <b>Line/Arrow/Distance Tool</b> . When it is enabled, the content of   |

|                     |   |
|---------------------|---|
|                     | <p>annotations pop-ups is displayed in text format above the baseline. When it is disabled, this content is not displayed.</p>  |
| <b>Start</b>        | <p>The <b>Start</b> property determines the style at the beginning of lines.</p>  |
| <b>Start Scale</b>  | <p>The <b>Start Scale</b> property determines the scale used at the beginning of lines.</p>   |
| <b>Subject</b>      | <p>The <b>Subject</b> property determines the content subject title. Note that it is not possible to edit this property in all tools.</p>   |
| <b>Subject Kind</b> | <p>The <b>Subject Kind</b> property determines the content subject value:</p> <ul style="list-style-type: none"> <li>• <b>Custom</b> renders a custom value for the subject. Enter the desired value in the <b>Subject</b> text box.</li> <li>• <b>Default</b> renders the default subject value.</li> <li>• <b>Global</b> renders the global subject value. Use the <b>Subject</b> text box to enter a new global subject value. All tools that feature a global option in their <b>Subject Kind</b> property will then be updated with the same information.</li> </ul> |

## 11 PDF-XChange Lite V8 User Manual

---



### PDF-XChange Lite V8 User Manual

---

**PDF-XChange Lite V8** is the lite version of our best-selling software for the creation and virtual printing of industry-standard PDF files - **PDF-XChange Standard V8**. It's compatible with files from almost all **Windows** applications such as **MS Word, Excel** and **AutoCAD**. **PDF-XChange Lite** features an optimized engine that significantly increases the quality of conversion for images and image-based text characters. Converted files are smaller in this version too - allowing for faster uploads/downloads, a reduction in storage space and increased data retention - even at high levels of compression.

**PDF-XChange Lite** installs as a virtual printer that generates fully-compatible, industry-standard, native PDF files. The files that **PDF-XChange Lite** creates feature searchable text, which greatly increases the efficiency of searching, selecting and editing files.

After **PDF-XChange Lite** has been installed, select files to print virtually and click **Print**. Select **PDF-XChange Lite** when prompted on which printer should be used. Files will then print virtually. There are several adjustable settings that determine the parameters of created documents. For example, it is now possible for documents to retain the name of the document from which they were created, and macros have been introduced to increase workflow efficiency.

The **PDF-XChange Lite User Manual** is composed of the following sections:

- **Features Overview** details the main features of the software.
  - **PDF-XChange Lite Printer Settings** details the product settings, and is structured to match the UI of the software.
- 

Note that the icons in the upper left of the screen can be used to browse/search the manual:



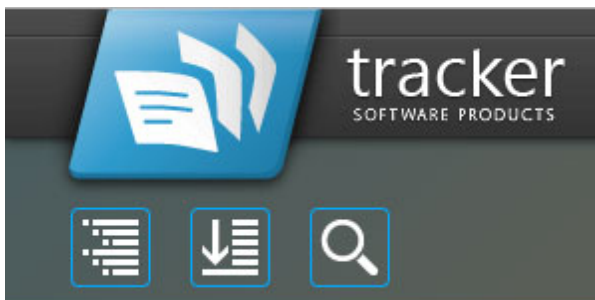

Click the **Table of Contents** to view/move to chapters of the manual.



Click the **Keyword Index** to view keywords, and click keywords to move to their location in the manual.



Click **Search Topics** to enter custom search terms.

---

## 11.1 Features Overview

---



### Features Overview

---

**PDF-XChange Lite** is a reduced version of **PDF-XChange Standard** that contains basic features for use when printing documents virtually. It combines high quality conversion with optimized compression to create professional documents that are comparatively small in size. The main features of **PDF-XChange Lite** are detailed below:

- **Hybrid Conversion Engine** that prints to both **GDI** and **XPS**. Use the **Driver Mode Rules** to designate **GDI** or **XPS** printing for specified printing applications as desired.
  - **Document Information** options that support both basic and advanced settings, including the option to add XMP Metadata, when documents are printed.
  - **Font Embedding** to ensure compatibility on all computers. Chinese, Japanese and Korean fonts are now also available.
  - **Enhanced Saving** options that determine how files are saved/named, including [macro](#)  functionality that increases workflow efficiency and dynamics.
  - **Language** options that support a wide range of languages.
  - **Paper Properties** that offer dynamic options for paper size, resolution, scaling and output.
  - **Custom Forms** can be created and saved for subsequent use.
  - **Mirrored Printing** and **Mixed Raster Content (MRC)** support.
-

## 11.2 PDF-XChange Lite Printer Settings

---



### PDF-XChange Lite Printer Settings

---

**PDF-XChange Lite** features many customizable settings. These are accessible from the printers list. Follow the steps below to adjust settings:

1. Click the **Windows Start Button**.
2. Click **Control Panel**. The **Control Panel** dialog box will open.
3. Click **Devices and Printers** in the **Control Panel** dialog box.
4. Move to the **Printers** tab and right-click **PDF-XChange Lite**.
5. Click **Printing Preferences**. The **PDF-XChange Lite Printing Preferences** dialog box will open:

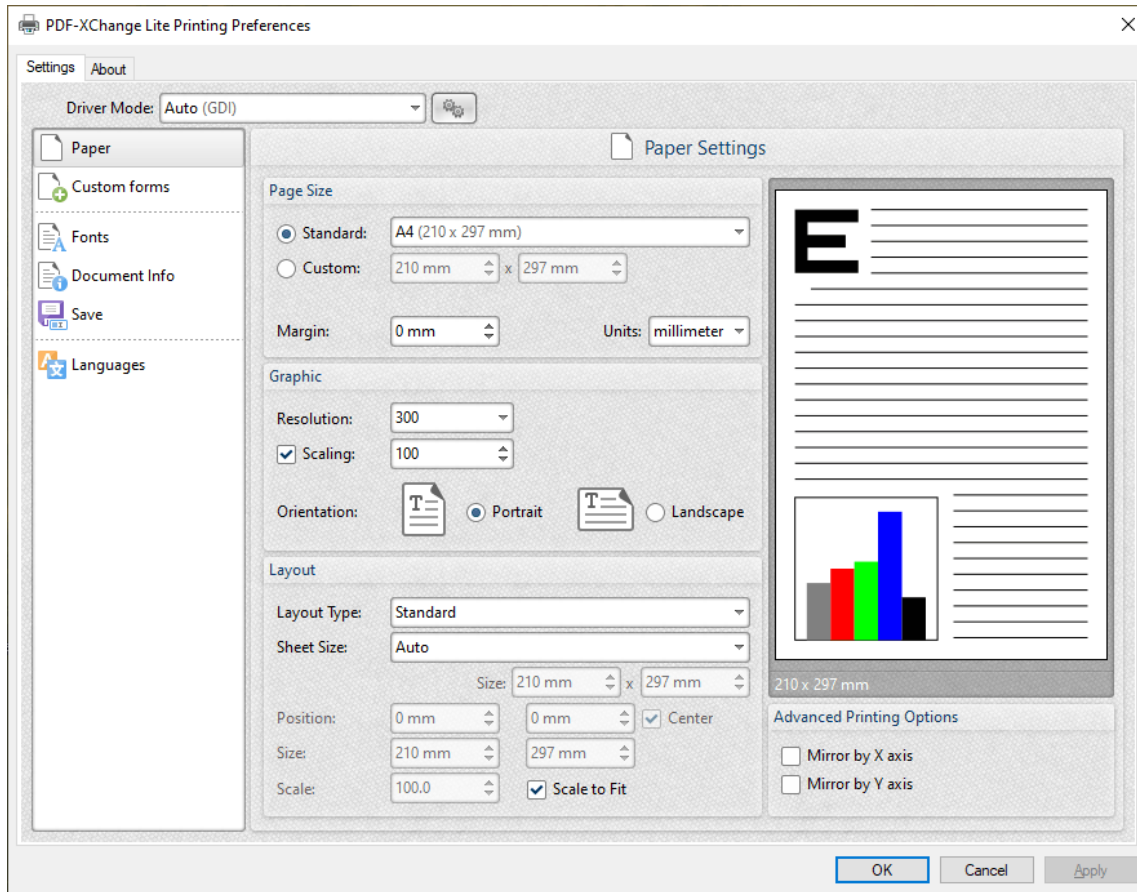







Figure 1. PDF-XChange Lite Printing Preferences Dialog Box, Settings Tab Highlighted

6. Use the **Settings** tab to view/edit settings. All sections are detailed below:

- [Paper](#)  1797
- [Custom Forms](#)  1806
- [Fonts](#)  1809
- [Document Info](#)  1811
- [Save](#)  1813
- [Languages](#)  1822

## About

The **About** tab can be used to access further information about the product, view help pages, check for updates and register new serial keys/activation codes.

11.2.1 Paper



**Paper**

The **Paper** settings are used to determine the size, orientation, margin, scaling factor, layout and printing order of pages, and the DPI (resolution) of images. Please note that some programs, such as **Microsoft Word**, override the properties determined in the **Paper** settings. This is because they use values determined within their own parameters and give those values priority over the options in **PDF-XChange Lite**.

Click **Paper** in the **Settings** tab to customize paper settings:

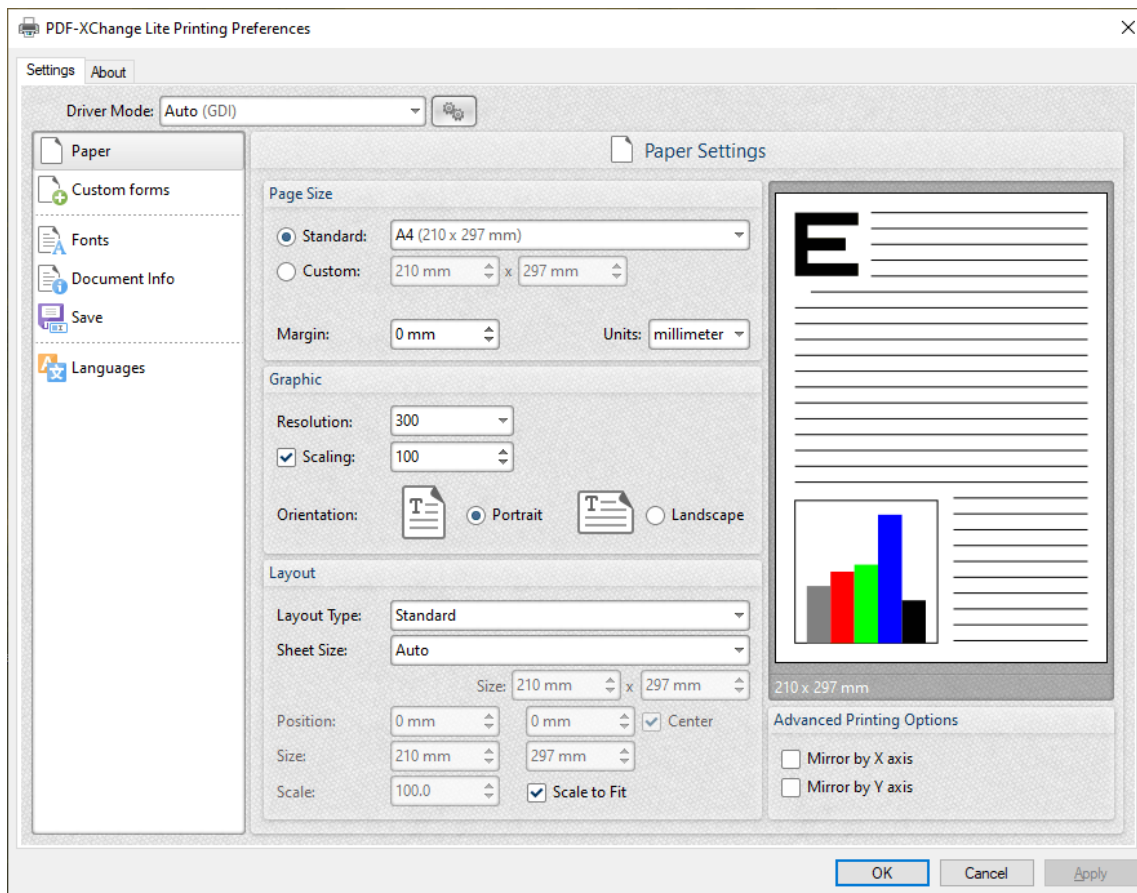

Figure 1. Paper Settings Dialog Box

## Page Size

- **Standard** features industry-standard standardized sizes.
- **Custom** enables custom dimensions (to a maximum of two hundred inches). Use the number boxes to determine document dimensions. Use the dropdown list to determine the units of measurement.
- **Margins** adjusts the size of document margins.

Please note that **AutoCAD** may present issues when printing, especially when it plots to virtual print drivers such as the **PDF-XChange Lite** print driver. If problems arise, especially in regard to portions of output exceeding the defined margin/page limits, we recommend setting a margin of at least 3.2mm.

## Graphic

- **Resolution** is measured in **DPI** (dots per inch). Use the **Resolution** number boxes to determine **DPI**. (Increasing **DPI** usually decreases file size).
- **Scaling** determines the size of converted documents in relation to original content.
- **Orientation** sets **Portrait** or **Landscape** as the page orientation.

## Page Layout

- **Standard** layout features one page per PDF page. See [here](#)<sup>1800</sup> for further options.
- **Booklet** layout features adjacent pages and is used for booklets and similar documents. See [here](#)<sup>1802</sup> for further options.
- **Multiple Pages Per Sheet** features multiple document pages per PDF page. Select a value to view the layout in the preview window. See [here](#)<sup>1804</sup> for further options.

## Sheet Size

- **Auto** sets sheet size automatically.
- **Custom** enables custom dimensions.
- The remaining options are industry-standard dimensions.

## Advanced Printing Options

- Select **Mirror by X Axis** to print a mirror version of the document that is reversed on the horizontal axis.
- Select **Mirror by Y Axis** to print a mirror version of the document that is reversed on the vertical axis.

Click **OK** to save changes.

---



### 11.2.1.1 Standard Layout



## Standard Layout

The **Standard** layout is used to print one document page per PDF page. The options detailed below are available when **Standard** is selected in the **Layout Type** dropdown menu:

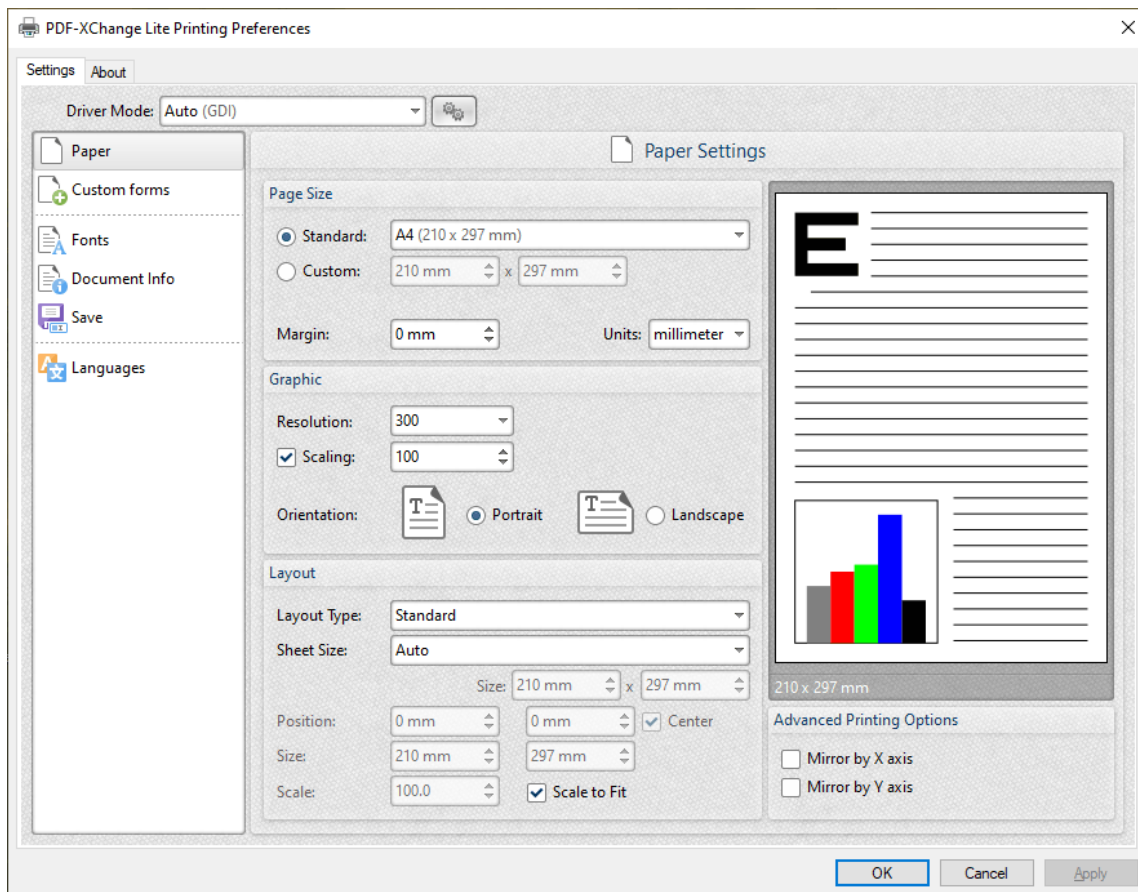

**Figure 1.** Paper Settings Dialog Box, Layout Type Dropdown Menu Selected, Standard Option

The **Sheet Size** options determine document dimensions:

- **Auto** sets sheet size automatically.



- **Custom** enables custom dimensions. Enter the desired dimensions in the **Size** boxes.
- The remaining options are industry-standard dimensions.

### Further Options

- If the **Scale To Fit** box is selected then layout options scale to the page size. Clear the box to disable this setting and then enter values in the **Size** and **Scale** number boxes or use the preview pane to resize pages.
- If the **Center** box is selected then documents are centered on the page and will remain centered when the size is adjusted. Clear the box to disable this setting and then enter values in the **Position** number boxes to determine page position.

Click **OK** to save changes.

---

### 11.2.1.2 Booklet Layout



## Booklet Layout

The **Booklet** layout is used to print booklets and similar documents. When it is selected in the **Layout Type** menu the following options are available:

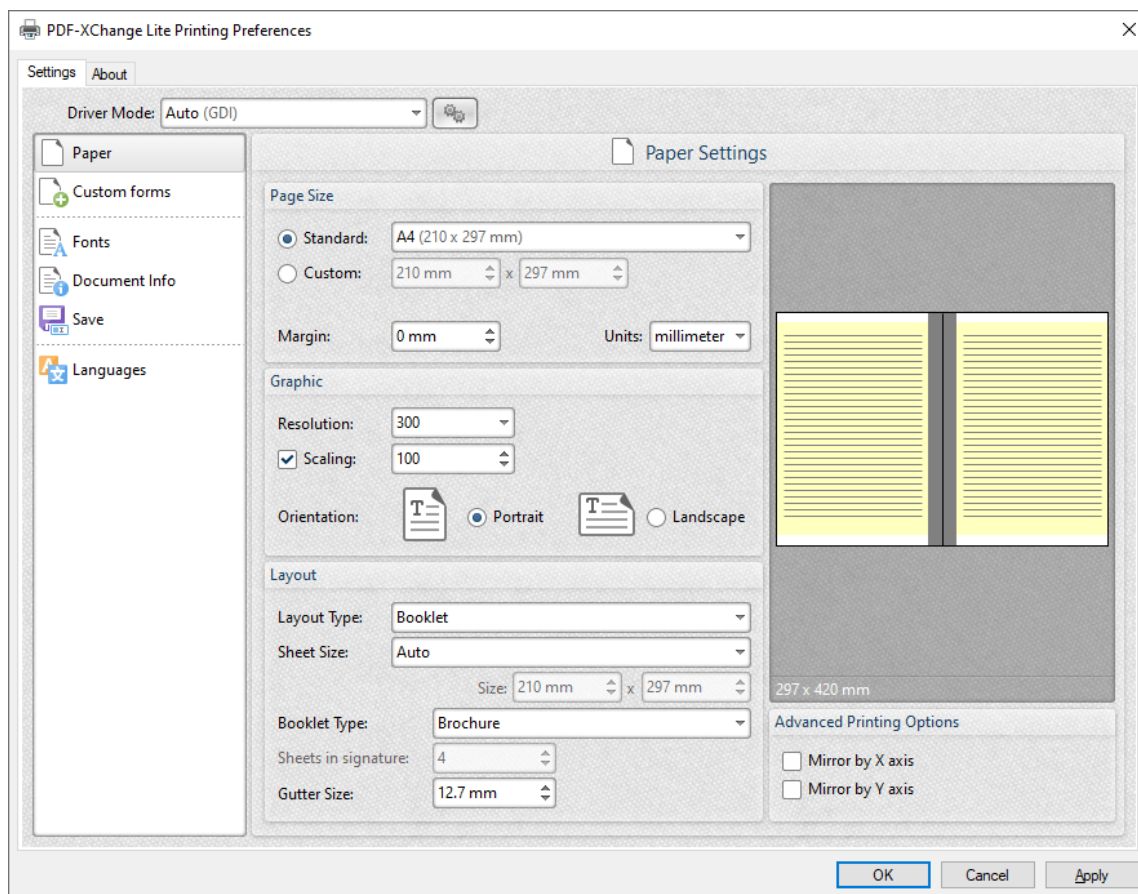

Figure 1. Paper Settings Dialog Box, Booklet Options

The **Sheet Size** options determine document dimensions:

- **Auto** sets sheet size automatically.
- **Custom** enables custom dimensions. Enter the desired dimensions in the **Size** boxes.

- The remaining options are industry-standard dimensions.

The **Booklet Type** options determine the booklet format:

- **Brochure** creates brochures, which are usually two or four pages in length and fit on a single sheet.
- **Books** have more pages than brochures and usually feature double-sided printing.
- Use the **Sheets in signature** number box to determine how sheets are folded.
- Use the **Gutter size** number box to determine the binding margin area, which the gray area in the preview pane represents. The default size is the industry-standard 12.7mm

Click **OK** to save changes.

---

### 11.2.1.3 Multiple Pages per Sheet



## Multiple Pages per Sheet

The **Multiple Pages per Sheet** layout is used to print multiple document pages per printed page. When it is selected in the **Layout Type** menu the following options are available:

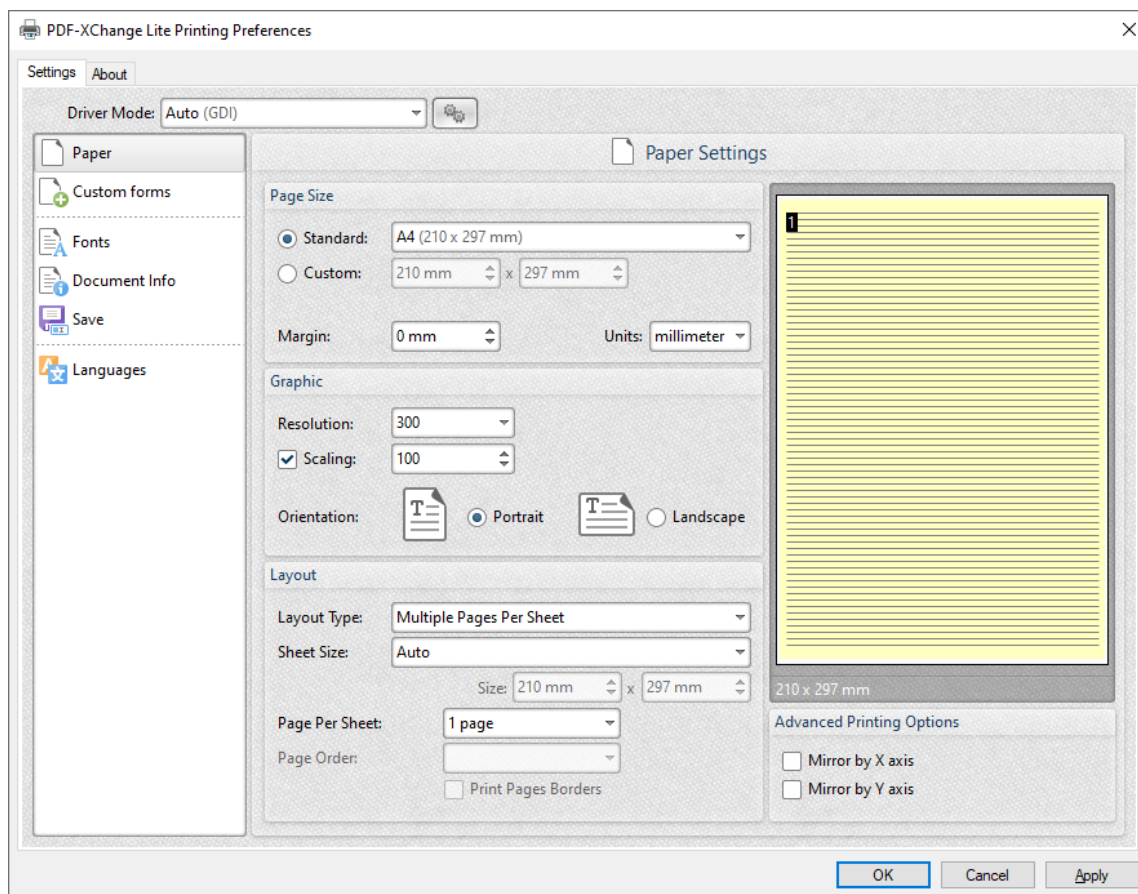

Figure 1. Paper Settings Dialog Box, Multiple Pages Per Sheet Options

The **Sheet Size** options determine document dimensions:

- **Auto** sets sheet size automatically.
- **Custom** enables custom dimensions. Enter the desired dimensions in the **Size** boxes.

- The remaining options are industry-standard dimensions.

## Page Options

- The **Page Per Sheet** dropdown menu determines how many pages feature on each sheet.
- The **Page Order** menu determines how pages are ordered in the PDF document. Select an option to view the layout in the preview pane.
- Select the **Print Pages Borders** box to print page borders.

Click **OK** to save changes.

---

## 11.2.2 Custom Forms



### Custom Forms

The **Custom Forms** settings are used to save custom forms for subsequent use:

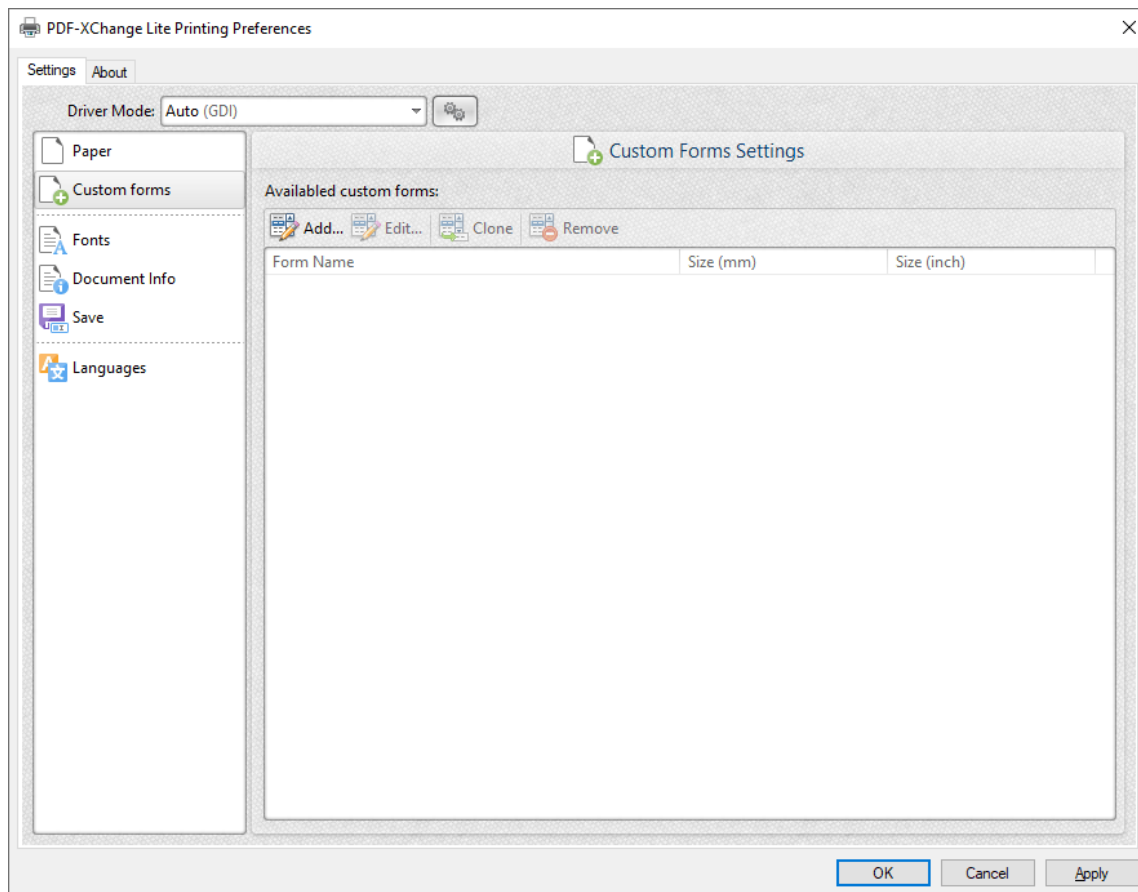

Figure 1. Custom Forms Dialog Box

- Click **Add** to add a new custom form. The **Add/Edit Custom Form** dialog box will open, as detailed below.
- Click **Edit** to edit selected forms.
- Click **Remove** to remove selected forms.

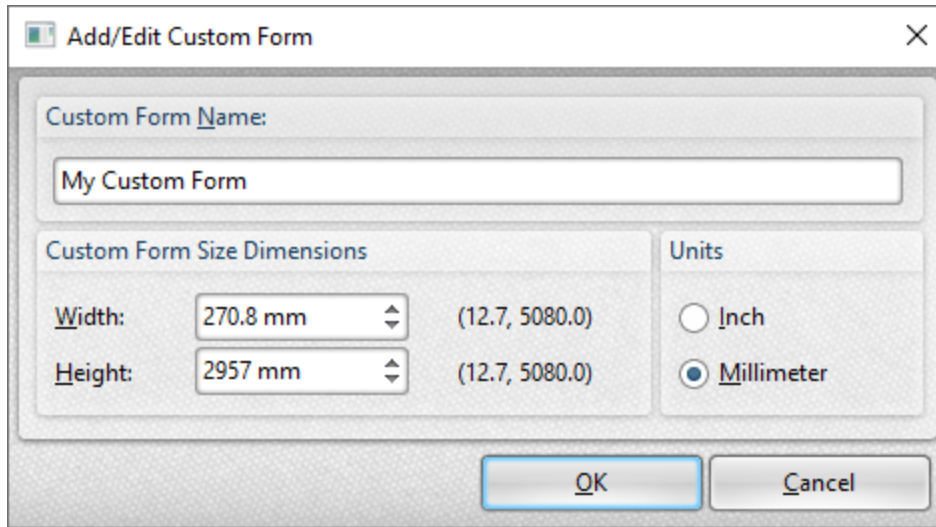
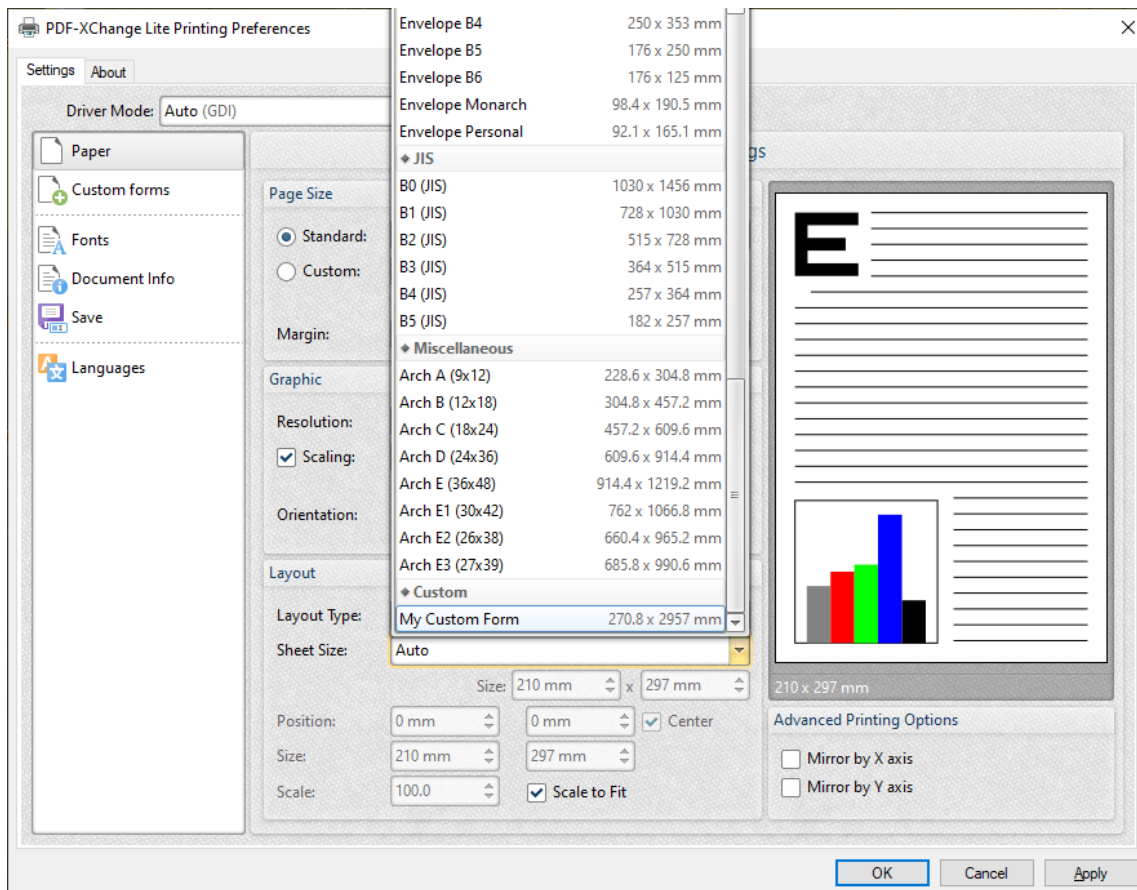

Figure 2. Add/Edit Custom Form Dialog Box

- Enter a name in the **Custom Form Name** text box to name the custom form.
- Enter dimensions in the **Width** and **Height** boxes and select a unit of measurement.

Click **OK** to save custom forms. They will then be detailed in the **Custom Forms** dialog box, and can also be selected in the **Sheet Size** dropdown menu in **Paper** settings:



**Figure 3.** Paper Settings Dialog Box, Sheet Size Dropdown Menu, Custom Forms

---



## 11.2.3 Fonts



## Fonts

The **Fonts** settings are used to determine font embedding options:

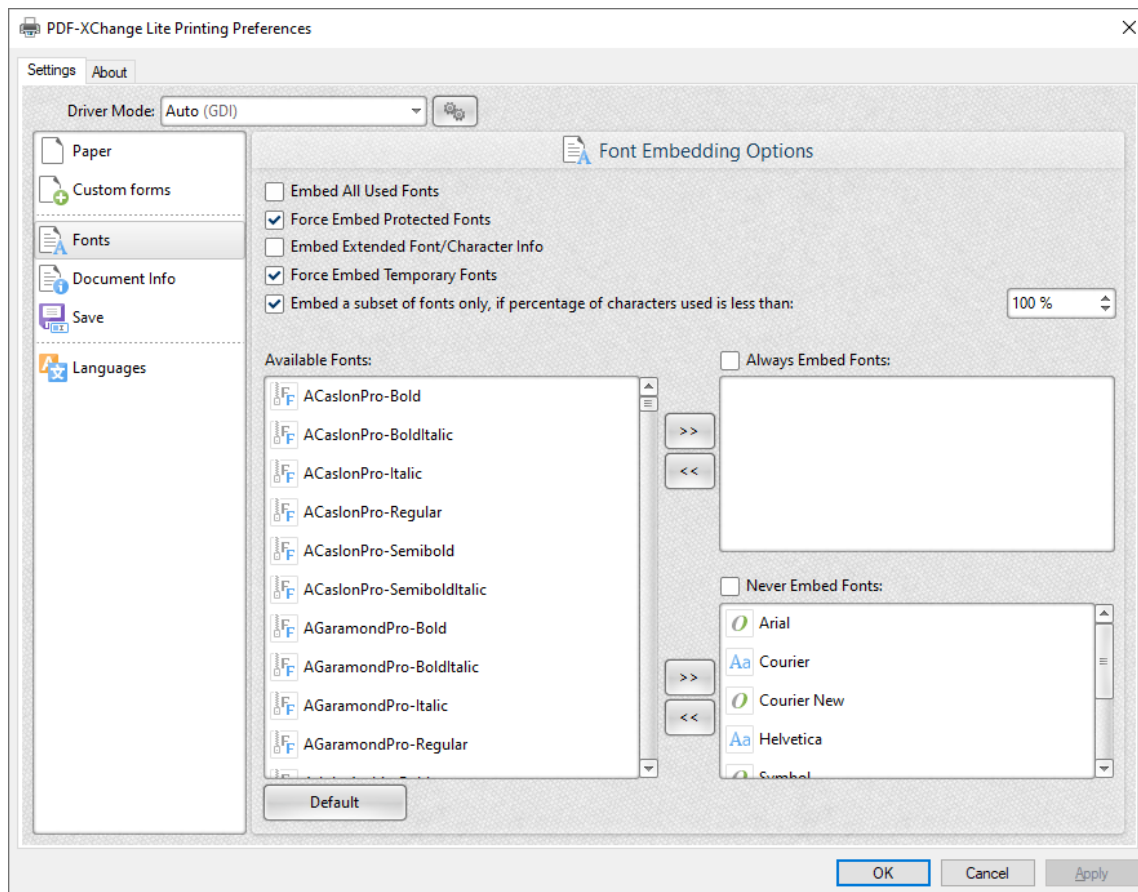

Figure 1. Font Embedding Options Dialog Box

- Select the **Embed All Used Fonts** box to embed all fonts. This increases the file size but ensures that fonts can be viewed on all machines.
- Select the **Force Embed Protected Fonts** box to force the inclusion of protected fonts in documents. Please note that some fonts are not licensed for widespread distribution and therefore it is necessary to check license permissions when this option is used.

- Select the **Embed Extended Font/Character Info** box to embed extended fonts and character information.
- Select the **Force Embed Temporary Fonts** box to force the inclusion of temporary fonts in documents.
- Select the **Embed a subset of fonts only, if percentage of characters used is less than** box to embed a subset of fonts when the percentage of total fonts they represent in files is less than the percentage entered into the adjacent number box. This optimizes the size of files as it saves a subset of fonts as opposed to the entire character set, but it should only be used when there is no intention to edit documents subsequently.
- The **Available Fonts** window displays all fonts available for embedding. Select fonts and then use the arrow icons to add them to the **Always Embed Fonts** or **Never Embed Fonts** panes. The best approach, in order to optimize file size, is to embed uncommon fonts and leave common fonts unembedded. This is because it is probable that common fonts will be available on the computers of subsequent users, and therefore embedding these fonts will increase the size of files unnecessarily.

Click **OK** to save settings.

---

## 11.2.4 Document Info



### Document Info

The **Document Info** settings are used to determine document information:

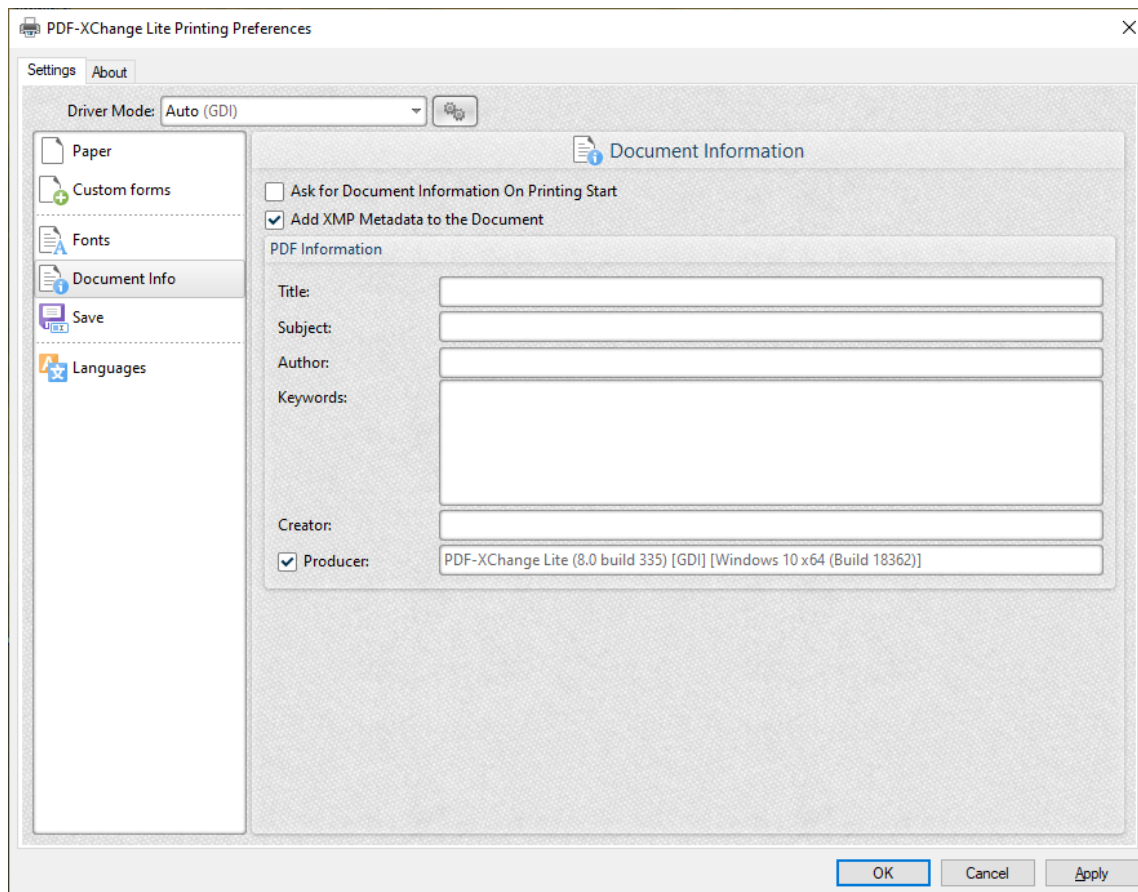

Figure 1. Document Information Dialog Box

- Select the **Ask For Document Information on Printing Start** box to enter document metadata when documents are printed.
- Select the **Add XMP Metadata to the Document** box to add the (**\*XMP**) extension to documents. See [here](#) for further information.
- Enter data in the **PDF information** text boxes as desired.

- Select the **Producer** box to add the PDF producer to the information of the document, or clear this box to exclude the PDF producer information from the document.

Click **OK** to save settings.

---

## 11.2.5 Save



The **Save** settings are used to determine how **PDF-XChange Lite** names and saves files:

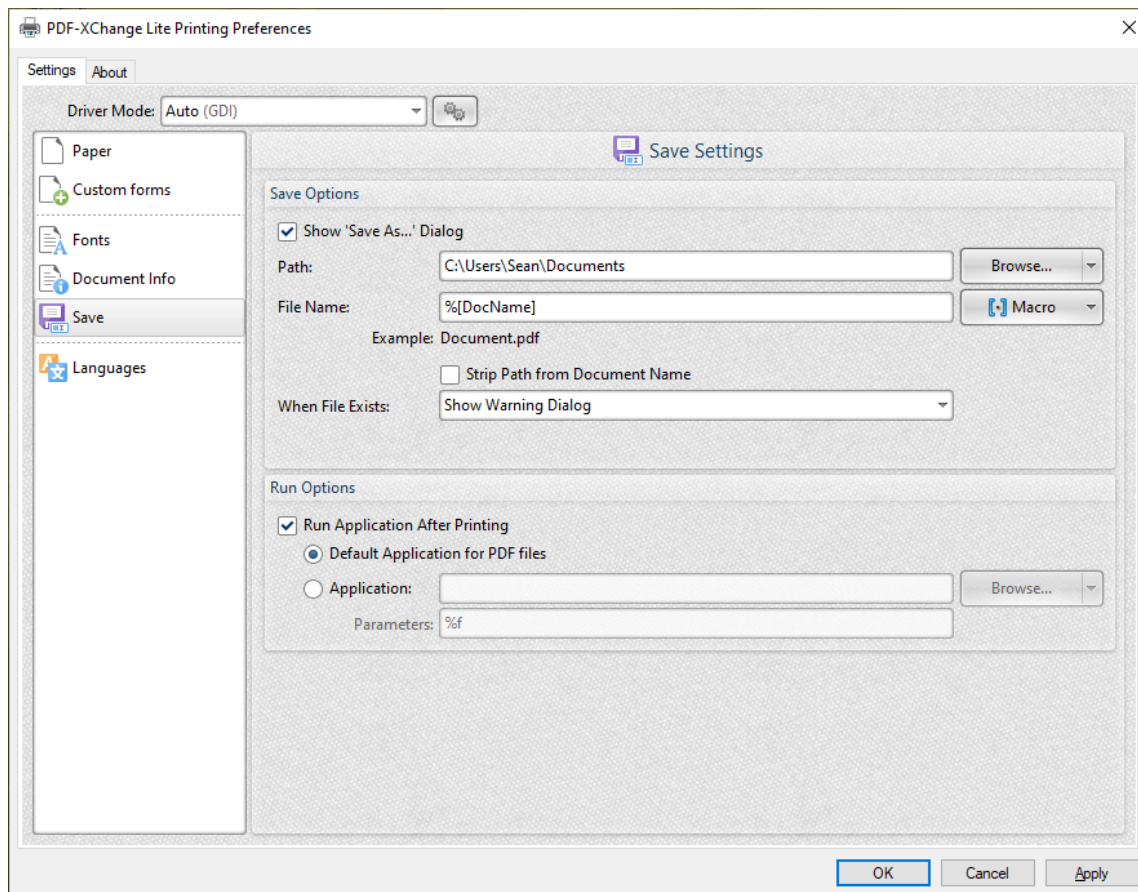



Figure 1. Save Settings Dialog Box

- Select the **Show Save As** box to view the **Save As** dialog box when files are saved. Use this option to update the filename when files are saved.
- Use the **Path** text box to determine the location of saved files. Click **Browse** to select a folder, or click the arrow to view/select common file locations such as **My Documents** or the desktop.

- Use the **File Name** text box to name files. Note that [macros](#)  as can be used in this text box.
- Select the **Strip Path From Document Name** box as desired.
- The **When File Already Exists** dropdown menu determines the action taken when entered file names are already in use:
  - **Show Warning Dialog** displays a warning and prompts the user for action.
  - **Always Overwrite** uses the new file to overwrite the existing file.
  - **Auto Number** uses the same file name and appends a number.
  - **Merge with Existing (Append To)** appends the new file to the existing file.
  - **Merge with Existing (Insert Before)** inserts the new file before the existing file.
  - **Ask for new file name** prompts for a new file name.
- Select the **Run Application After Printing** box to view printed documents when printing is complete.
- Select the **Default Application for PDF files** option button to view printed documents in the default PDF viewer.
- Select the **Application** option button to view printed documents in an alternative application. Enter the name of the application in the text box, or click **Browse** to select an application manually.
- Enter application parameters in the **Parameters** text box as desired.

Click **OK** to save settings.

---

### 11.2.5.1 Macros

---



## Macros

---

Macros can be used when saving files in **PDF-XChange Lite**. 'Macro' is an abbreviation of 'macroinstruction' - a term in computer science for a rule that specifies how input characters should be entered to create corresponding output. This means that components of the output process can be simplified during the input process, which makes the work involved less intensive and more dynamic. Use macros in the **Filename** when files are saved in **PDF-XChange Lite** to create the names of saved files. Note that multiple macros can be used simultaneously as desired. Click the macro button to view the list of macros, then click macros to add them to the text box. Macros can also be entered manually.

Please note that certain symbols are not compatible with macros and therefore are not permitted in document names. If inconsistencies are noticed between the name used when files are saved and the final file name then it is advised to change the name used when files are saved.

The format for macros is:

**%[<Macro Name>]** or, when it is customizable: **%[<Macro Name>:<Parameter>]**. The **<Parameter>** step is optional in all cases except for the **Environment Variable** macro.

An example of the filename that entered macros will create is displayed beneath the **File Name** text box. For example, if the **%[Docpath]** macro is entered, then the example displays the source path of the printed document:

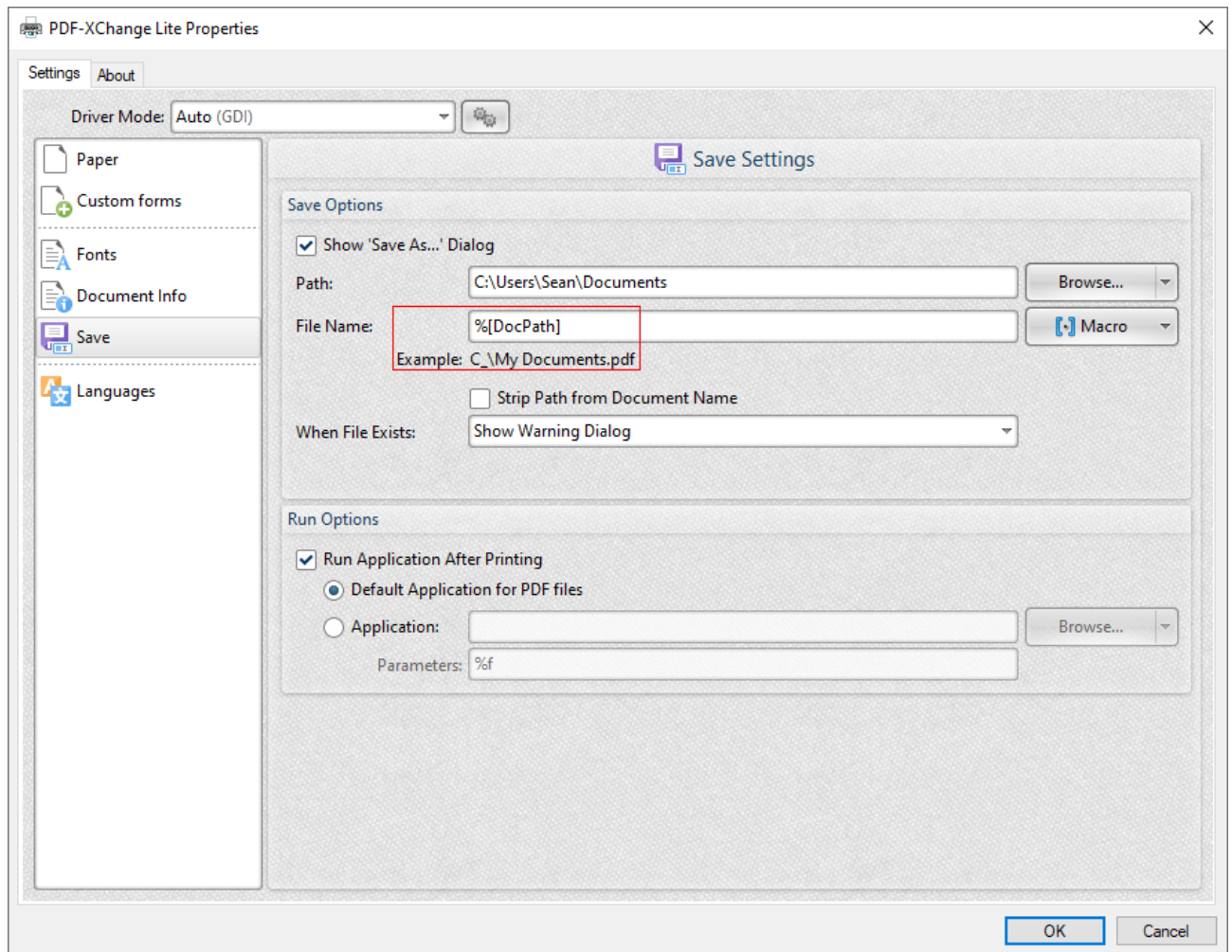

Figure 1. Example Macro

All macros are detailed below:

- **Application Name**, which uses the syntax % [AppName] and adds the executable filename extension of the application that calls **PDF-XChange Lite** to print the document. For example, if **Microsoft Word** is used then '**WINWORD**' is added.
- **Document Name**, which uses the syntax % [DocName] and adds the name of the document. Further information about this macro is detailed below.
- **Document Path**, which uses the syntax % [DocPath] and adds the path of the printed document.
- **Date**, which uses the syntax % [Date] and adds the current date. Multiple date formats are available, as detailed below. Please note that if parameters are not used in conjunction with this macro then the output will be different from what is expected. This is because the output from the default settings includes forwardslashes, which are not compatible with file names. **PDF-XChange Standard**, the 'full' version of **PDF-XChange Lite**, contains a range of features for the % [Date] macro. These features require the date in standard format, which is the reason for



the format of the default settings and why they do not create the expected output when saving files in **PDF-XChange Lite**.

- **Year**, which uses the syntax **%[Year]** adds the current year as a four-digit value.
- **Month**, which uses the syntax **%[Month]** and adds the current month as a numerical value from 1-12.
- **Day**, which uses the syntax **%[Day]** and adds the current day of the month as a two-digit value.
- **Time**, which uses the syntax **%[Time]** and adds the current time. Multiple time formats are available, as detailed below.
- **Hour**, which uses the syntax **%[Hour]** and adds the hour value from the current time.
- **Minute**, which uses the syntax **%[Minute]** and adds the minute value from the current time.
- **Seconds**, which uses the syntax **%[Second]** and adds the seconds value from the current time.
- **Computer Name**, which uses the syntax **%[Computer]** and adds the name of the local computer as defined by the **Windows Computer Name**.
- **User Name**, which uses the syntax **%[User]** and adds the name of the current user.
- **Page Number**, which uses the syntax **%[Page]** and adds the page number of source pages.
- **Pages Count**, which uses the syntax **%[Pages]** and adds the number of document pages.
- **Environment Variable**, which uses the syntax **%[Env]** and adds information taken from user-specified environment variables. This macro must be qualified with a parameter in order to return information. Available parameters are detailed below.

### **%[DocName]**

The **getDocumentName** function of the **titrules.js** JavaScript uses the document name at the time of printing to define this macro. This JavaScript is included to give **PDF-XChange Lite** priority over other applications when documents are saved. This is a necessary process because of the complicated manner in which **Microsoft** defines document names. Please note that modifying the **titrules.js** JavaScript is a complicated process that only experienced JavaScript programmers should perform. If assistance is required then please [Contact Us](#).

### **Available Parameters**

#### **%[Date]**

- **d** inserts the day of the month and omits the zero in cases of single-digit values.
- **dd** inserts the day of the month and includes a zero in cases of single-digit values.
- **ddd** inserts the day of the week as a three-letter abbreviation.
- **dddd** inserts the day of the week.
- **M** inserts the month as a numerical value and omits the zero in cases of single-digit values.

- **MM** inserts the month as a numerical value and includes a zero in cases of single-digit values.
- **MMM** inserts the month as a three-letter abbreviation.
- **MMMM** inserts the month.
- **yy** inserts the year as two digits and adds a zero in cases of values lower than 10.
- **yyyy** inserts the year.

Note that several parameters can be used in sequence in order to insert a customized date. For example, **%[Date:dddd, dd MMMM yyyy]** inserts the day of the week followed by the day of the month, the month name in full and the year as four digits:

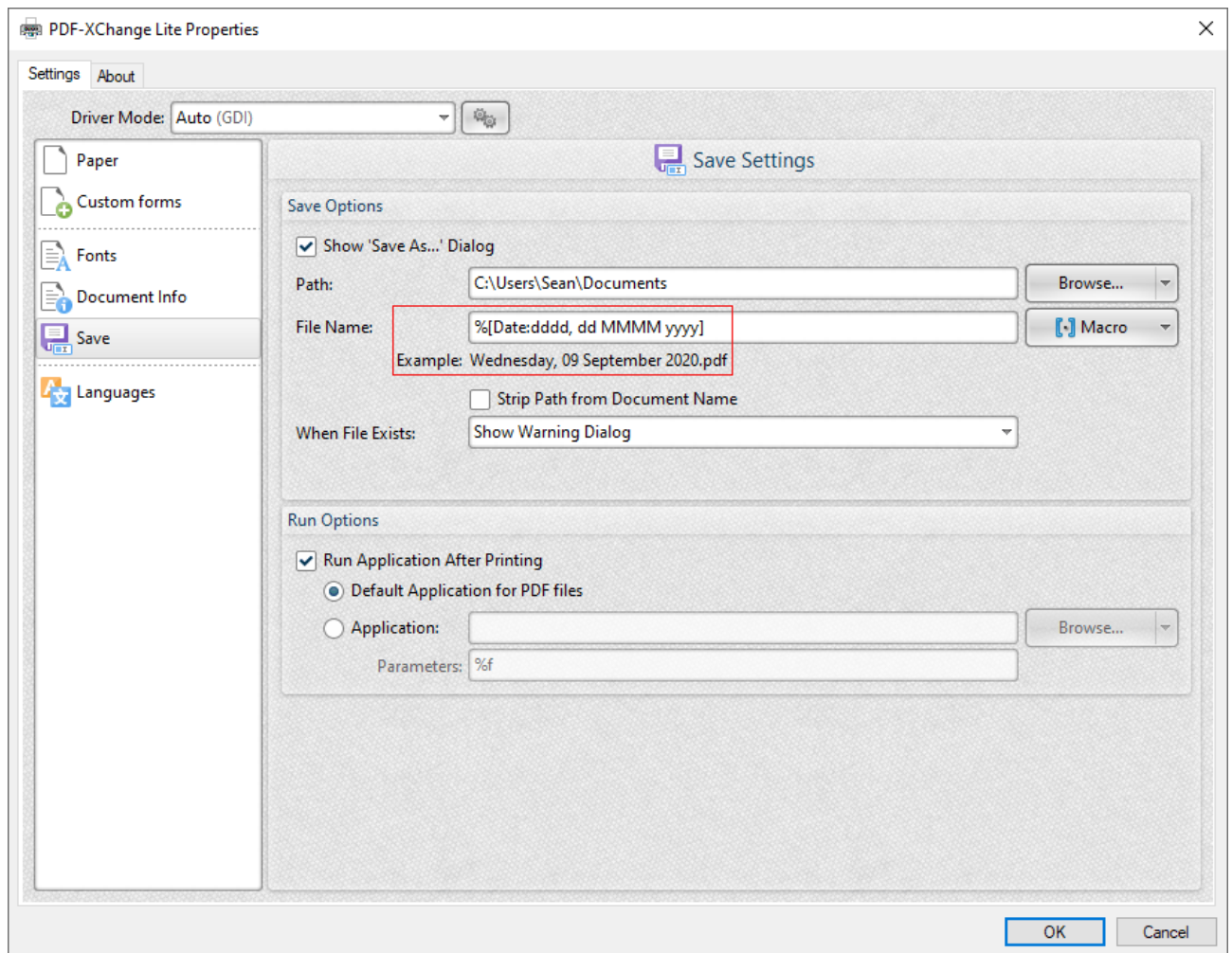

Figure 2. Example Date Macro

## %[Time]

- **h** inserts the hour and omits the zero in cases of single-digit values.
- **hh** inserts the hour and includes a zero in cases of single-digit values.
- **H** inserts the hour, includes a zero in cases of single-digit values and uses a 24 hour-clock.

- **m** inserts the minutes and omits the zero in cases of single-digit values.
- **mm** inserts the minutes and includes a zero in cases of single-digit values.
- **s** inserts the seconds and omits the zero in cases of single-digit values.
- **ss** inserts the seconds and includes a zero in cases single-digit values.
- **t** inserts a single character to reference the a.m./p.m. variable: **A** or **P**.
- **tt** inserts two characters to reference the a.m./p.m. variable: **AM** or **PM**.

Note that several parameters can be used in sequence in order to insert a customized time, and a range of delimiter options can be used. For example, **%[Time:h-mm tt]** inserts the current hour and minutes followed by two characters to reference the a.m./p.m. variable:

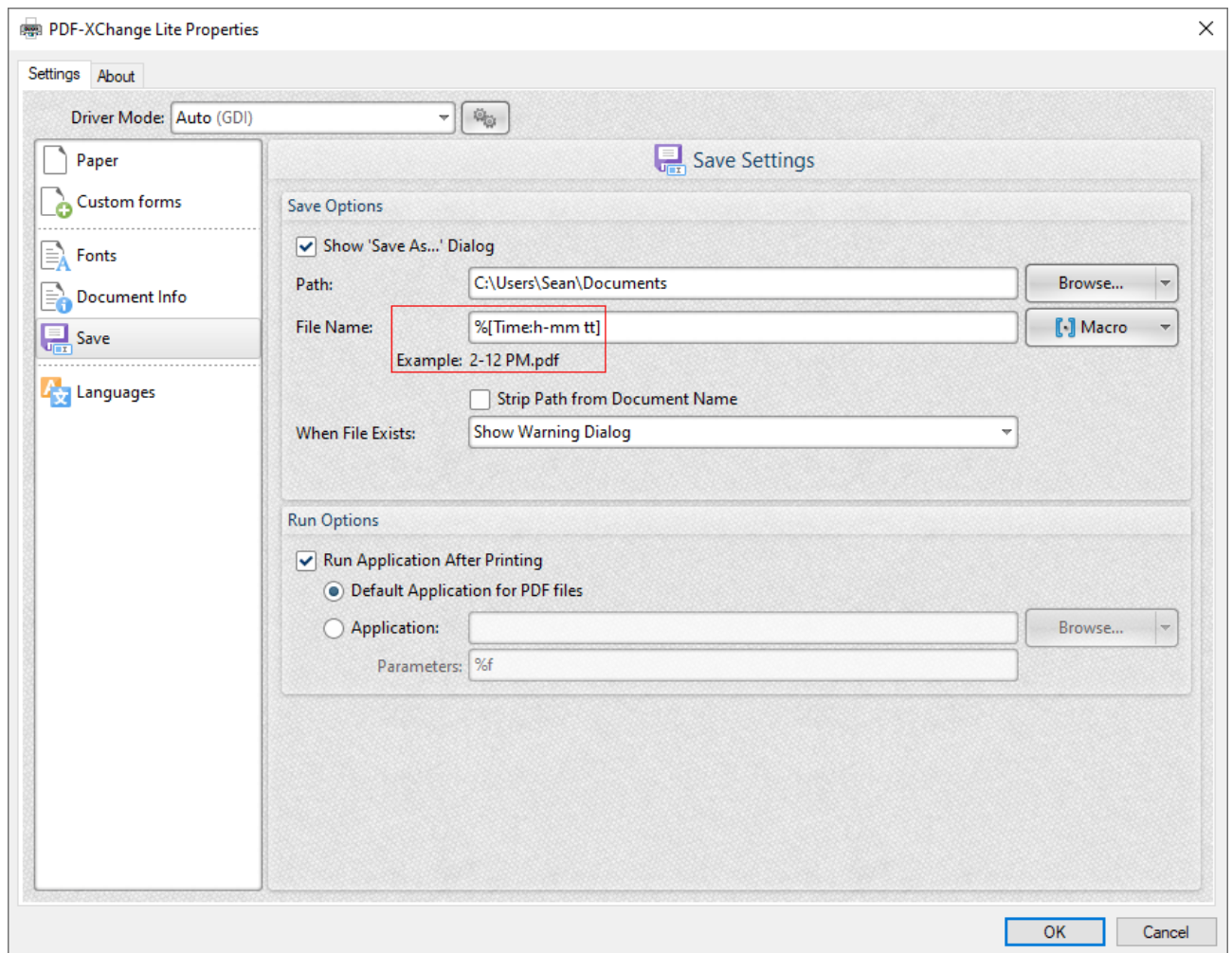

Figure 3. Example Time Macro

If parameters are not specified then output values revert to default, which is the time from the local computer in the format **hh\_mm\_ss AM/PM.pdf**

**%[Env]**

- **ALLUSERSPROFILE** inserts the full path to the *All Users* profile directory.
- **APPDATA** inserts the full path to the *Application Data* directory of the current user.
- **CommonProgramFiles** inserts the full path to the *Common Files* directory.
- **CommonProgramFiles(x86)** inserts the full path to the (*x86*) *Common Files* directory in 64-bit versions of **Windows**.
- **CommonProgramFilesW6432** inserts the full path to the *Common Files* directory in 64-bit versions of **Windows**.
- **COMPUTERNAME** inserts the computer name.
- **HOMEDRIVE** inserts the drive letter on the local computer that is connected to the user's home directory.
- **HOMEPATH** inserts the complete path of the current user's *Home* directory, as defined by the user's account properties.
- **LOCALAPPDATA** inserts the complete path to the current user's *Application Data* directory.
- **LOGONSERVER** inserts the name of the domain controller that authenticated the client's logon request.
- **OS** inserts the name of the operating system.
- **PROCESSOR\_ARCHITECTURE** inserts the chip architecture of the CPU.
- **ProgramData** inserts the full path to the *All Users* profile directory.
- **ProgramFiles** inserts the full path to the *Program Files* directory.
- **ProgramFiles(x86)** inserts the full path to the (*x86*) *Program Files* directory in 64-bit versions of **Windows**.
- **ProgramFilesW643** inserts the full path to the *Program Files* directory in 64-bit versions of **Windows**.
- **PUBLIC** inserts the full path to the *Public* directory.
- **SESSIONNAME** inserts the session name and number when a client is connected via a terminal server.
- **SystemDrive** inserts the name of the drive on which the system folder was placed.
- **SystemRoot** inserts the name of the system folder.
- **TEMP** inserts the name of the default temporary folder used by the operating system and applications available to the current user.
- **TMP** inserts the name of the default temporary folder used by the operating system and applications available to the current user. (Note that some applications require the **TEMP** environment variable, whilst others require **TMP**. The values for both should be identical).
- **USERDOMAIN** inserts the name of the user domain that contains the account of the current user.
- **USERDOMAIN\_ROAMINGPROFILE** inserts the name of the user domain for RDS or standard roaming profile paths.
- **USERNAME** inserts the name of the current user.
- **USERPROFILE** inserts the location of the current user's profile directory.
- **windir** inserts the full path to the *Windows* directory.

For example, the macro **%[Env:CommonProgramFiles]** inserts the full path to the *Common Files* directory:

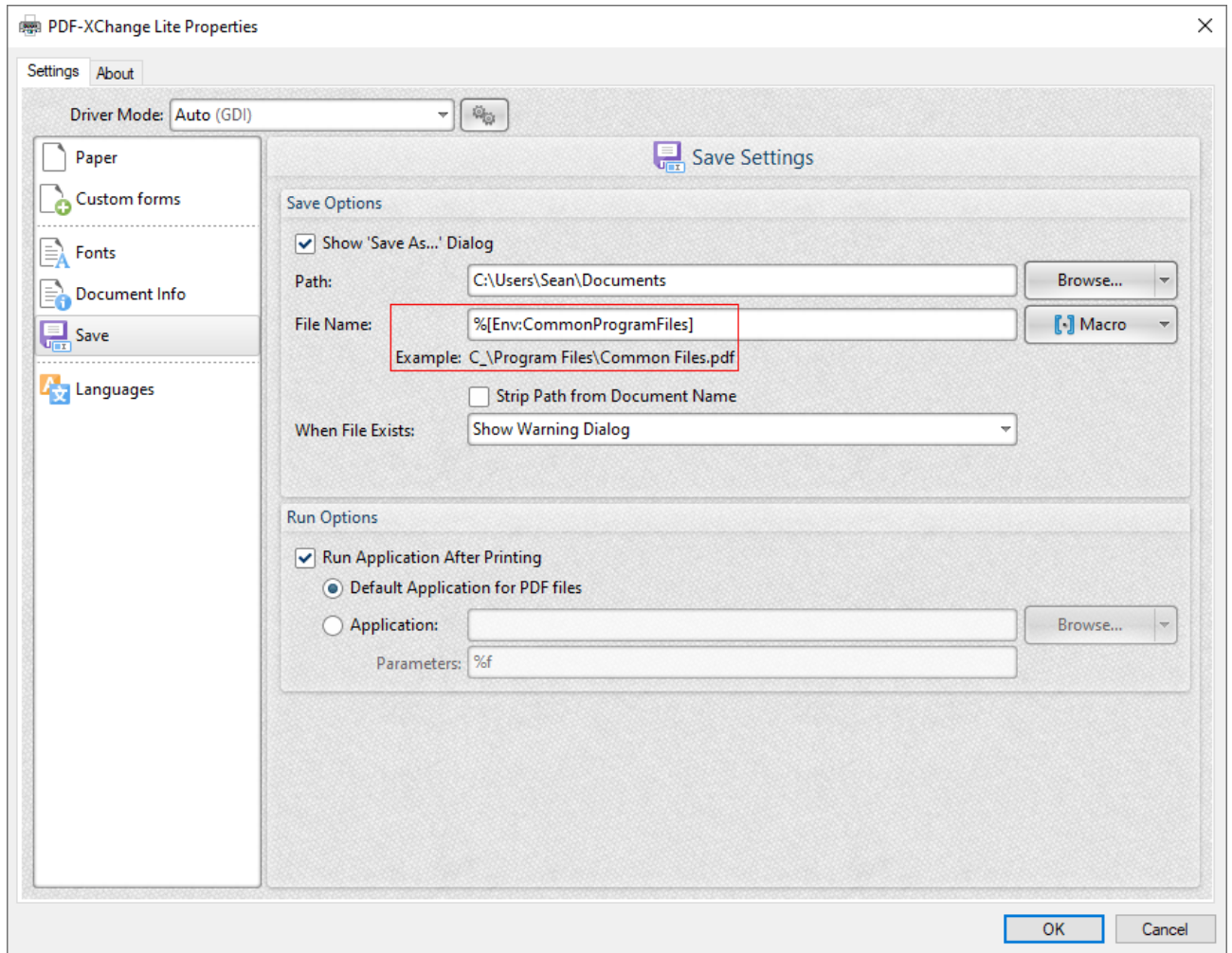

Figure 4. Example %[Env:CommonProgramFiles] Macro

## 11.2.6 Languages



## Languages

The **Languages** settings are used to determine the language of the user interface:

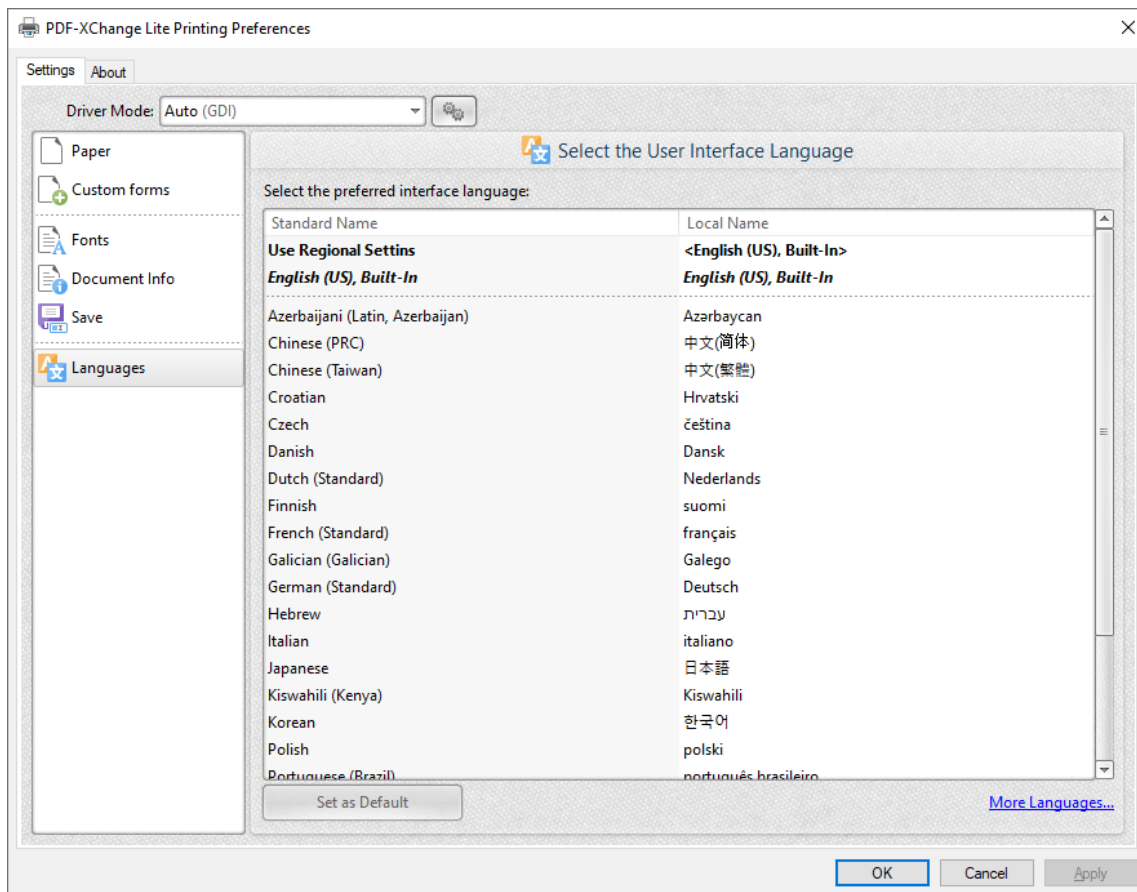

Figure 1. Choose Interface Language Dialog Box

Click **Use Regional Settings** to use the regional language of the local computer. Alternatively, click to select a language from the list of languages, then click **Set as Default** to enable it.

Click **OK** to save settings.



### 11.2.7 Driver Mode



## Driver Mode

The **Driver Mode** determines the print mode of **PDF-XChange Lite**:

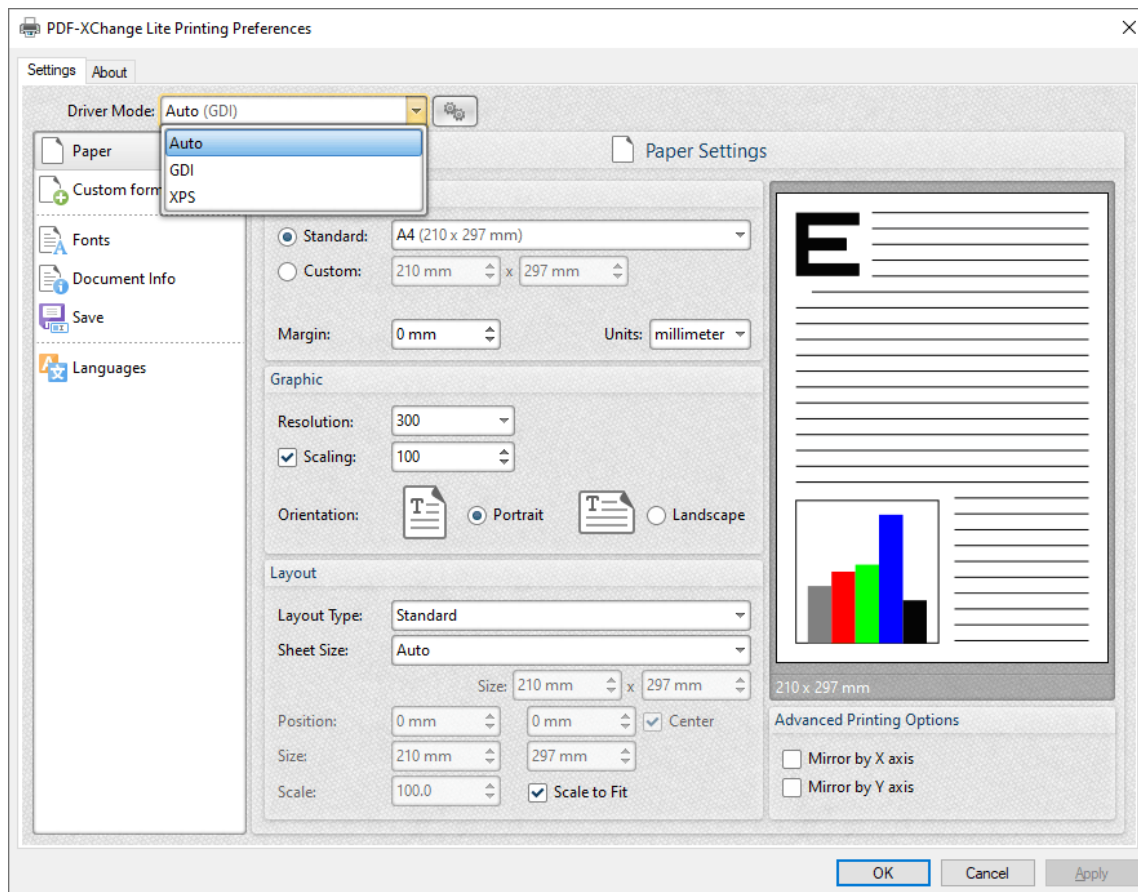

Figure 1. Driver Mode Options

Printer drivers on **Microsoft Windows** systems make use of **GDI** (**Unidrv** or **P-Script-based**) or **XPS** (**XPSPDrv**) in order to print documents. **PDF-XChange Lite** supports both of these modes, and the **Driver Mode** settings determine which mode is used:

- **Auto** allows **PDF-XChange Lite** to determine the print mode.
- **GDI** specifies **GDI** printing to **GDI**.



- XPS specifies XPS printing to XPS.

### Driver Mode Rules

The driver mode rules are used to set printing to **GDI** or **XPS** for specific applications. Click the icon next to the **Driver Mode** dropdown menu in order to specify driver mode rules:

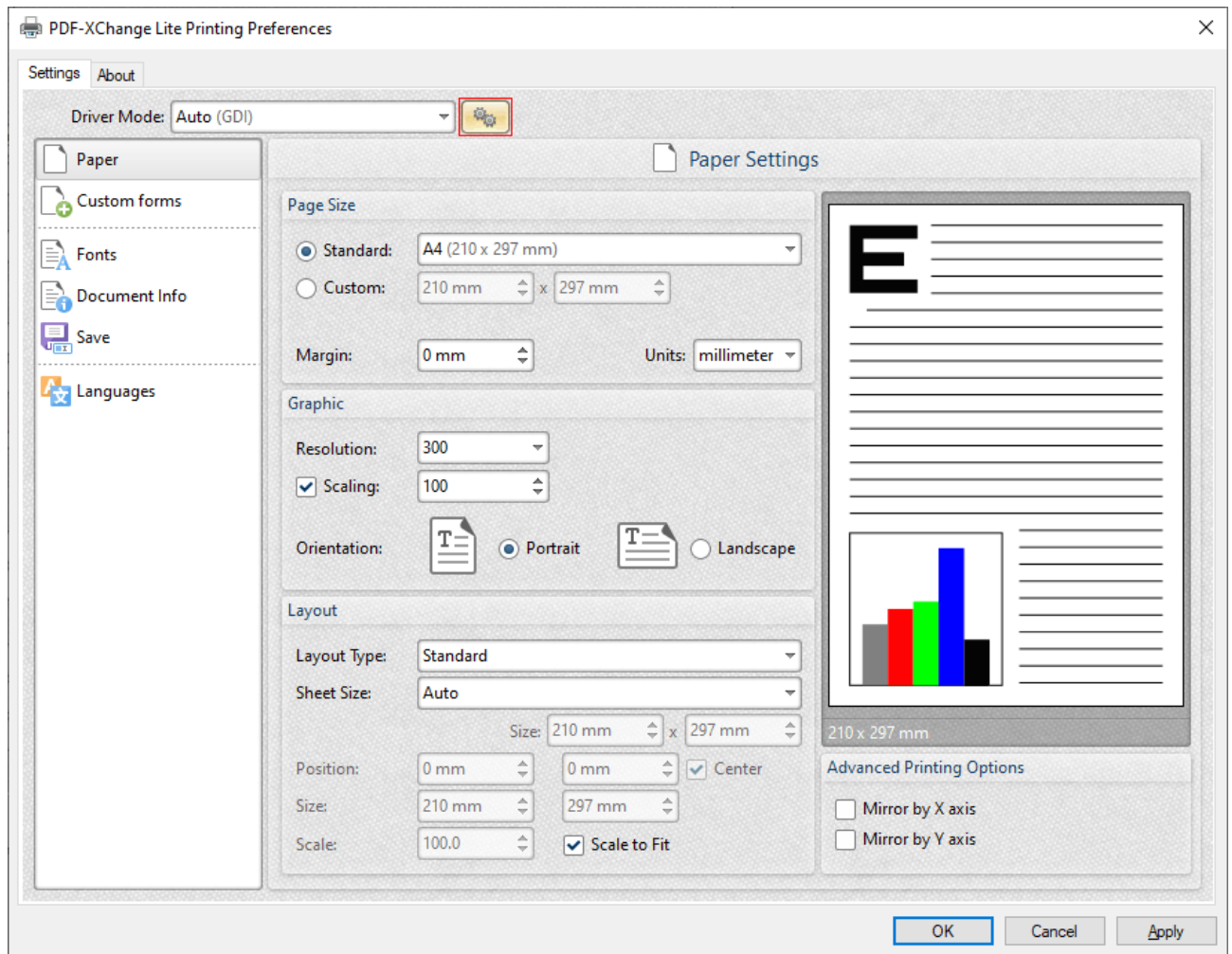

Figure 2. Driver Mode Rules Icon

The **Driver Mode Rules** dialog box will open:

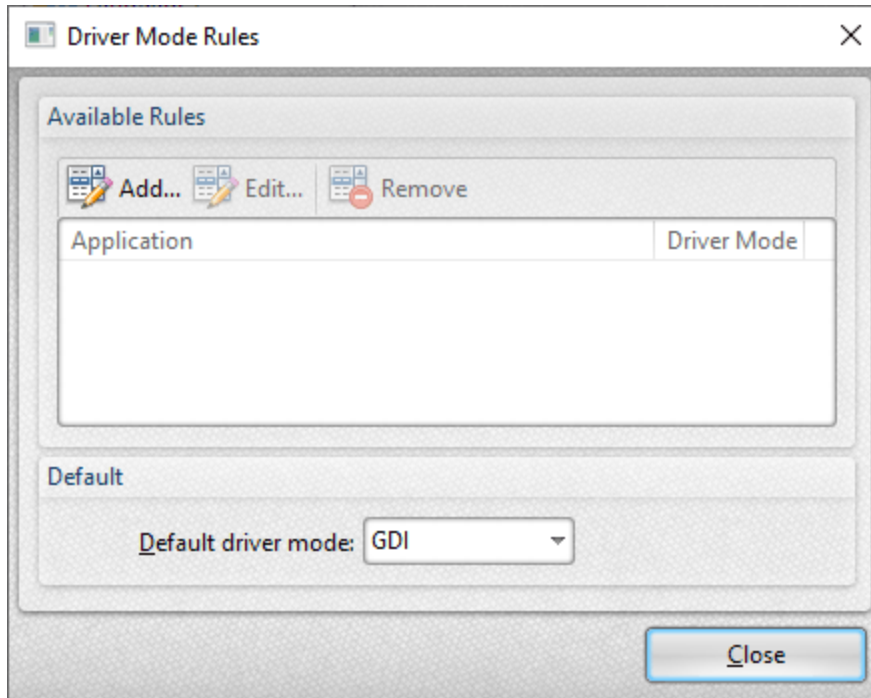

Figure 3. Driver Mode Rules Dialog Box

- Click **Add** to add applications to the list. The **Add/Edit Driver Mode** dialog box will open, as detailed below.
- Click **Edit/Remove** to edit/remove selected applications. The **Add/Edit Driver Mode** dialog box will open, as detailed below.
- Use the **Default driver mode** dropdown menu to determine the default driver mode in **PDF-XChange Lite**.

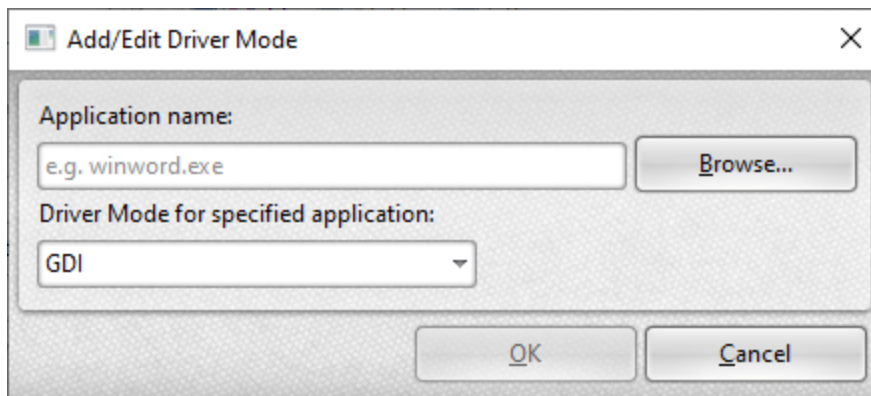

Figure 4. Add/Edit Driver Mode Dialog Box

- Enter the name of the application in the **Application name** text box. Note that the executable file of the application must be used. Alternatively, click **Browse** to select an application manually.
- Use the dropdown menu to determine the **Driver Mode** for the specified application. **PDF-XChange Lite** will then print in the specified mode when this application is used.

Click **OK** to save changes.

---

### 11.2.8 PDF Saver

---



### PDF Saver

---

The **PDF Saver** feature facilitates the combination of multiple print jobs into a single PDF document. This increases the speed at which files are generated, which allows users to queue new jobs before the final file assembly and generation.

Enter 'pdfsaver' in the **Windows Search Box** and click **PDF-XChange Lite pdfSaver** to view/edit the **PDF Saver** settings:

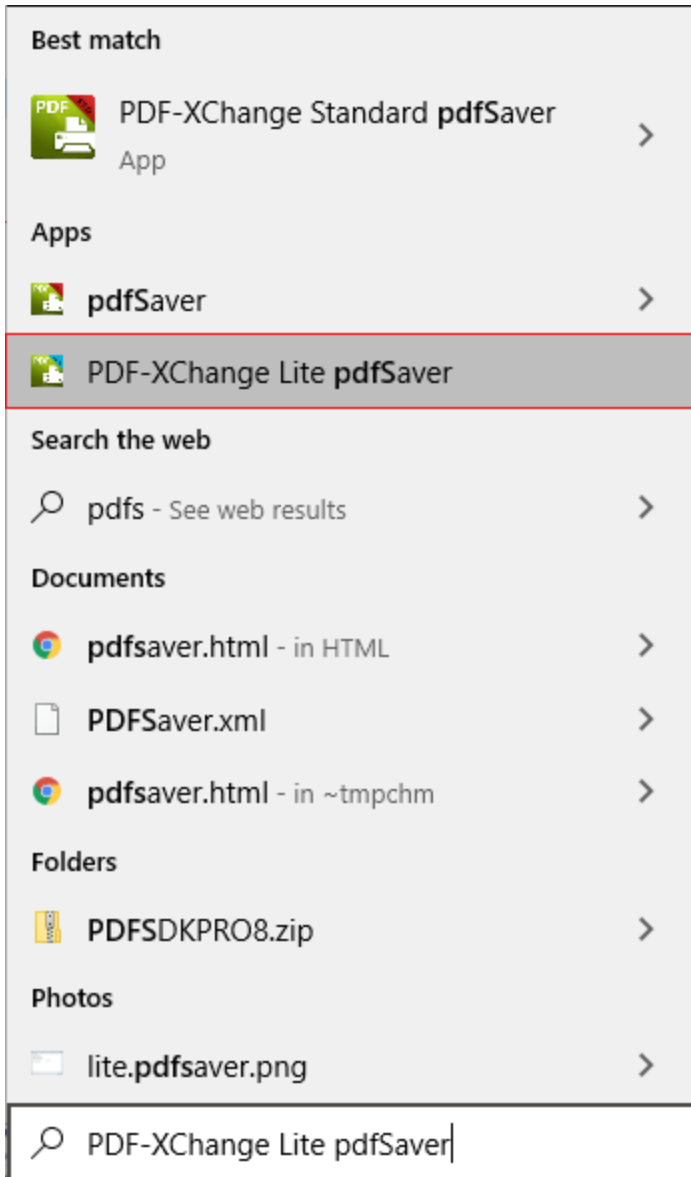

Figure 1. Windows Search Box Results

The **PDF-XChange Lite: pdfSaver** dialog box will open:

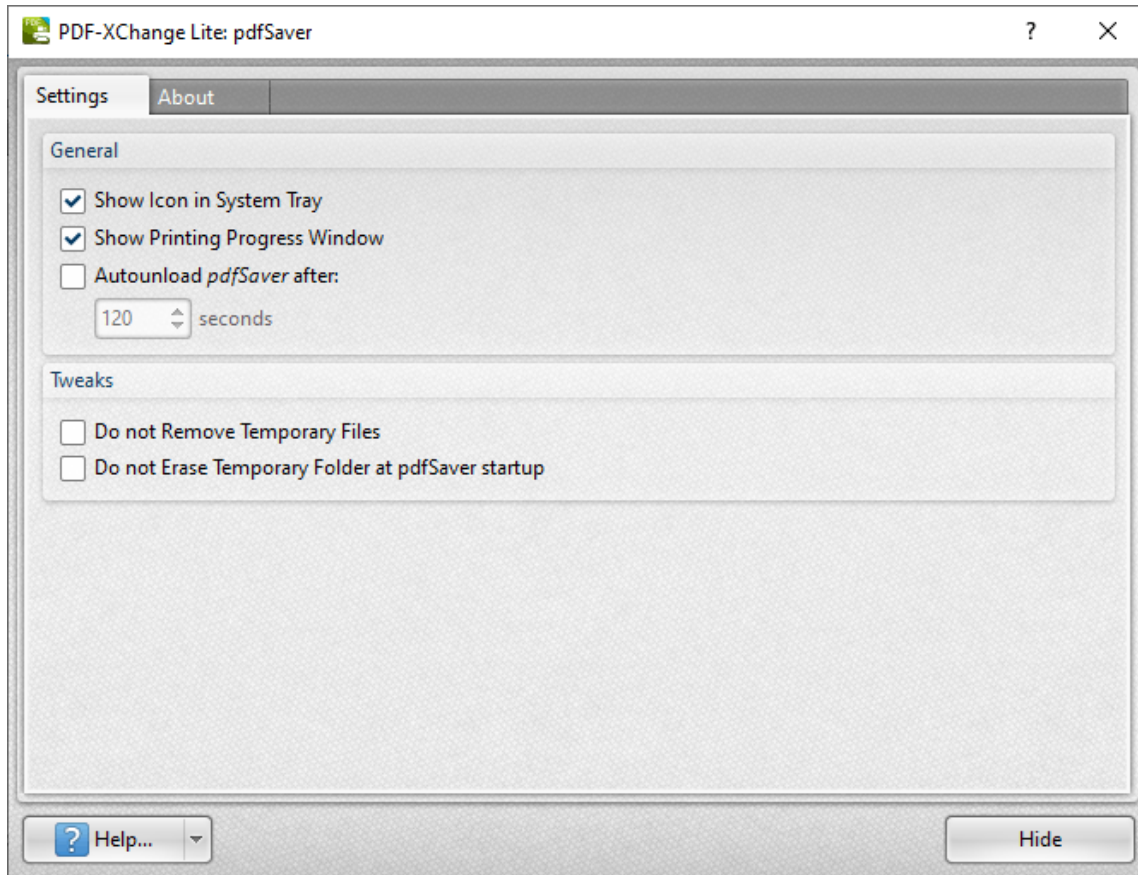

Figure 2. PDF-XChange Lite: pdfSaver Dialog Box

- Select the **Show Icon in System Tray** box to display an icon the taskbar when **PDF Saver** is open.
- Select the **Show Printing Progress Window** box to view the printing progress window when documents are printed.
- Select the **Autounload pdfSaver after** box to unload **PDF Saver** when printing is complete. Use the number box to determine the period after which **PDF Saver** closes.
- Select the **Do not Remove Temporary Files** box to retain temporary files after documents are printed.
- Select the **Do not Erase Temporary Folder at pdfSaver startup** box to retain the temporary folder when **PDF Saver** is launched.
- Use the **Help** dropdown menu to navigate to the **PDF-XChange Lite** online manual, the **PDF-XChange Lite** product page on the **PDF-XChange** website or the **Support Forums** as desired.
- Click **Hide** to minimize the window.
- Click the **About** tab to view build and version information about **PDF-XChange Lite**.

### 11.2.9 Features Added in Version 8

---



### Features Added in Version 8

---

The following features were added in **Version 8** of **PDF-XChange Lite**:

- PDF security settings added for the **IE** and **Outlook** plugins.
  - **Save Document** options added, as detailed [here](#).
  - Options added that enable the specification of the PDF-viewing application for **PDF-XChange Lite**.
  - Option to not store the **Producer** information in documents.
  - Improved optimization and document generation speed.
-







**- A -**

About 1596  
Accessibility Preferences 871  
Actions Library 76  
Add a Place 782  
Add Barcodes to Documents 1392  
Add Bates Numbering Action 188  
Add Bates Numbering Tool 331  
Add Buttons to Documents 1356  
Add Check Boxes to Documents 1293  
Add Date Fields to Documents 1409  
Add Digital Signature Action 272  
Add Digital Signature Fields to Documents 1374  
Add Digital Signature Tool 418  
Add Dropdown Menus to Documents 1329  
Add Header and Footer Action 192  
Add Header and Footer Tool 333  
Add List Boxes to Documents 1317  
Add Radion Buttons to Documents 1305  
Add Text Fields to Documents 1270  
Add Text to Bookmark Titles 1567  
Add Text Tool 1638  
Add Timestamp Action 276  
Add Watermark Tool 335  
Add Watermarks Action 196  
Add/Edit Content 1638  
Adding Dynamic Elements to Stamps 1188  
Advanced Actions 292  
Advanced Tools 459  
Annotations Guide 604  
AnnotationText Editing Options 1683  
Appendix for Editor 1633  
Appendix for PDF Tools 468  
Area Tool 1219  
Arrange Tab 1626  
Arrow Tool 1149,1156  
Art Box 482  
Attachments Pane 1014  
Available File Filters 469

**- B -**

Background 1494  
Bates Numbering 1500  
Bleed Box 482

Blend Mode 1659  
Booklet Layout 1802  
Bookmark Actions 144  
Bookmark Every Nth Page 1560  
Bookmark Properties 1593  
Bookmarks Guide 624  
Bookmarks in Editor 994  
Bookmarks Tab 1549  
Bookmarks Tools 402  
Build Table of Contents 1584  
Build Table of Contents Action 145  
Build Table of Contents Tool 403

**- C -**

Callout Tool 1099  
Certify Document Action 279  
Certify PDFs Tool 420  
Change Bookmark Case 1569  
Change Document Properties 292  
Change Document Properties Tool 460  
Change Page Background Action 200  
Check for Updates 1596  
Choose Input Files Action 128  
Clear All Digital Signatures Tool 422  
Clear Digital Signatures Action 283  
Clone Tool 71  
Cloud Tool 1183  
Color Management Preferences 873  
Combine Files Into A Single PDF 799  
Command Line Options 1669  
Comment Styles Palette 1242  
Comment Tab 1082  
Commenting Preferences 875  
Comments Actions 257  
Comments Pane 1007  
Comments Tools 389  
Content Editing Tools 1638  
Content Pane 1032  
Contents 1596  
Convert Colors 1529  
Convert Files to PDFs Action 79  
Convert Files to PDFs Tool 317  
Convert from PDF Preferences 877  
Convert Line Annotations to Distance Annotations 1149  
Convert Named Destinations to Regular Destinations 1573  
Convert Tab 1515  
Convert to Named Destinations 1590

Convert to PDF Preferences 877  
Convert to PDF/A Action 180  
Convert to PDF/A Tool 438  
Convert to PDF/X Action 182  
Convert to PDF/X Tool 440  
Create Documents 633  
Create Link 956  
Create Multiple Copies of Form Fields 1437  
Create PDF Actions 78  
Create PDF from Images Action 86  
Create PDF from Images Tool 319  
Create PDF from Text Action 93  
Create PDF from Text Tool 321  
Create PDF Tools 316  
Create Ribbon Tabs 1599  
Create Tool 65  
Create Weblinks Action 243  
Create Weblinks Tool 374  
Crop Box 482  
Crop Margins in Tools 482  
Crop Pages Action 204  
Crop Pages in Editor 1484  
Crop Pages Tool 337  
Custom Forms Settings 1806  
Customize the Workspace 751  
Customize Toolbars 1599  
Customize UI Preferences 879

## - D -

Default Tools 315  
Delete All Comments Action 258  
Delete All Comments Tool 390  
Delete Form Fields Action 250  
Delete Form Fields Tool 381  
Delete Links Action 245  
Delete Links Tool 376  
Delete Markup Annotations Action 260  
Delete Markup Annotations Tool 392  
Delete Pages 1459  
Delete Pages Action 207  
Delete Pages Tool 339  
Delete Weblinks Action 247  
Delete Weblinks Tool 378  
Digital Signatures 1248  
Discard Special PDF-Standard Action 184  
Discard Special PDF-Standard Tool 442  
Distance Tool 1208

Document Info 1811  
Document Info Bar Preferences 881  
Document Operations Guide 632  
Document Properties 843  
Document Recovery Pane 1059  
Documents Preferences 857  
Duplicate 950  
Duplicate Form Fields 1437  
Duplicate Pages 1465  
Duplicate Pages Action 209  
Duplicate Pages Tool 341

## - E -

Edit Content Tool 1638  
Edit Documents 643  
Edit Form 1682  
Edit Window 57  
Editing Document Pages 1682  
Editing Panes Guide 738  
Enhance Scanned Pages 1526  
Enhance Scanned Pages Action 167  
Enhanced OCR 1519  
Eraser Tool 1201  
Execute a Command 972  
Explore the User Interface 596  
Export 838  
Export Bookmarks Action 148  
Export Bookmarks to HTML 1592  
Export Bookmarks to Text File 1593  
Export Bookmarks to Text File Action 149  
Export Bookmarks to Text File Tool 407  
Export Bookmarks Tool 405  
Export Comments 1236  
Export PDF Actions 105  
Export PDF to Images Action 106  
Export PDF to Images Tool 447  
Export PDF to Microsoft Excel Spreadsheet Action 110  
Export PDF to Microsoft Excel Spreadsheet Tool 449  
Export PDF to Microsoft Microsoft Word Document Tool 453  
Export PDF to Microsoft Powerpoint Presentation Action 113  
Export PDF to Microsoft Powerpoint Presentation Tool 451  
Export PDF to Microsoft Word Document Action 117  
Export PDF to Plain Text Document Action 120  
Export PDF to Plain Text Tool 455  
Export PDF Tools 444  
Export to BMP 838  
Export to DCX 838

Export to GIF 838  
 Export to JBIG2 838  
 Export to JPEG 838  
 Export to JPEG2000 838  
 Export to Microsoft Powerpoint Presentation 838  
 Export to PBM 838  
 Export to PCX 838  
 Export to PGM 838  
 Export to PNG 838  
 Export to PPM 838  
 Export to TGA 838  
 Export to TIFF 838  
 Export to WBMP 838  
 Extract Images from PDF Action 122  
 Extract Images from PDF Tool 457  
 Extract Pages Action 97  
 Extract Pages in Editor 1462  
 Extract Pages Tool 323

**- F -**

Features Overview in Editor 593  
 Features Overview in Lite 1794  
 Features Overview in Tools 51  
 Fields Pane 1016  
 File Associations Preferences 883  
 File Attachment Tool 1110  
 File Separator 807  
 File Tab 772  
 Find 1688  
 Find and Replace Bookmark Text 1575  
 Fit Box by Text Content 1783  
 Flatten Comments 1239  
 Flatten Comments Action 264  
 Flatten Comments Tool 396  
 Folder Monitors 585  
 Font Embedding Options 1809  
 Font Options 486  
 Font Settings 1809  
 Form Tab 1265  
 Format Tab 1624  
 Forms Context Menu 1437  
 Forms Guide 744  
 Forms Preferences 885  
 From Image Files 819  
 From Rich Text Format 816  
 From Scanner 829  
 From Text Files 807

Full Screen Preferences 887  
 Functions 51

**- G -**

General Preferences 860  
 Generate Bookmarks from Page Text 1552  
 Generate Bookmarks from Page Text Action 154  
 Generate Bookmarks from Page Text Tool 411  
 Generate Bookmarks from Table of Contents 1562  
 Generate Bookmarks from Text File 1564  
 Get Images from Scanner Action 99  
 Go To a Page in an Embedded Document 965  
 Go To a Page in Another Document 965  
 Go To a Page in the Document 965  
 Go To Options 965

**- H -**

Header and Footer 1497  
 Help 1596  
 Help Tab 1596  
 Highlight Form Fields 1265  
 Highlight Text Tool 1120  
 History Pane 1061  
 Home Page 1596  
 Home Tab 938

**- I -**

Identity Preferences 889  
 iFilter 1781  
 Image Compression 819  
 Image Labels 819  
 Image Post-Processing 819  
 Image Processing 819  
 Images Layout Options 819  
 Import Bookmarks Action 162  
 Import Bookmarks from Text File Action 164  
 Import Bookmarks from Text File Tool 415  
 Import Bookmarks Tool 413  
 Import Comments 1234  
 Initial View 843  
 Input/Output Actions 127  
 Insert 1451  
 Insert Empty Pages Action 211  
 Insert Empty Pages Tool 343

Insert Pages Action 213  
Insert Pages Tool 345  
Installation 18

## - J -

Javascript 843  
Javascript Preferences 891

## - K -

Keyboard Shortcuts 1691

## - L -

Language Settings 1822  
Languages Preferences in Editor 893  
Launch Applications Preferences 895  
Layers Pane 1024  
License Key 1596  
Licensing 40  
Line Tool 1149, 1156

## - M -

Macros 1815  
Macros in Editor 1707  
Macros in Tools 488  
Main Window 57, 596  
Manage Form Data 1265  
Measurement Preferences 898  
Measuring Tools 1206  
Miscellaneous Document Operations 718  
Move Pages 1468  
Multiple Pages per Sheet 1804

## - N -

Named Destinations Pane 1036  
Navigate the Workspace 764  
New Document 795  
New Document from Selection 955  
New Page Options 807  
New Stamp from Selection 953  
Number Pages 1504

## - O -

OCR Pages Action 219  
OCR Pages in Editor 1519  
OCR Pages Tool 349  
OCR Selected Region 1519  
Open 775  
Open a File 970  
Open a Web Link 968  
Open Documents 715  
Operations Guide 603  
Optimize Document Action 170  
Optimize PDF Actions 166  
Optimize PDF Tool 435  
Optimize PDF Tools 432  
Organize Tab 1447  
Oval Tool 1167  
Overlay PDF Action 224  
Overlay PDF Tool 351

## - P -

Page Boxes 1770  
Page Display Preferences 863  
Page Range Options 552  
Page Range Settings 1773  
Page Text Preferences 867  
Page Transitions 1072  
Pages Actions 186  
Pages Tools 329  
Panels Layout 1662  
Paper Settings 1797  
Paragraph Options 486  
PDF Saver 1827  
PDF Standard Actions 179  
PDF Standard Tools 437  
PDF to Audio Action 124  
Pencil Tool 1201  
Performance Preferences 906  
Perimeter Tool 1214  
Play a Sound 979  
Plugins Preferences 910  
Polygon Line Tool 1172  
Polygon Tool 1178  
Portfolio 1630  
Preferences 554, 854

Print 833  
Protect Tab 1244  
Protection Actions 271  
Protection Tools 417

## - R -

Read an Article 985  
Read Out Loud Feature 1774  
Recent Files 777  
Rectangle Tool 1162  
Registration Preferences 869  
Remove Bates Numbering Action 226  
Remove Bates Numbering Tool 353  
Remove Headers and Footers Action 227  
Remove Headers and Footers Tool 355  
Remove Page Background Action 228  
Remove Pages Background Tool 357  
Remove Watermarks Action 229  
Remove Watermarks Tool 359  
Replace Pages 1470  
Replace Pages Action 230  
Replace Pages Tool 361  
Report a Problem 1596  
Reset a Form 974  
Reset Form 1265  
Resize Pages Action 232  
Resize Pages in Editor 1488  
Resize Pages Tool 363  
Resulting Appearance 1552  
Review Tab 1541  
Rotate Pages Action 235  
Rotate Pages in Editor 1482  
Rotate Pages Tool 365  
Run a JavaScript 963

## - S -

Save As Optimized 784  
Save Documents 735  
Save Documents Action 135  
Save Images Action 137  
Save Options 784  
Save Settings 1813  
Scan to PDF Tool 325  
Scanner Presets Preferences 912  
Scanner Settings in Editor 829

Search 1776  
Search Providers Preferences 914  
Secure Document Action 289  
Secure PDF Tool 428  
Security Preferences 916  
Select Comments 1087  
Send Mail Action 140  
Send Mail Preferences 919  
Sessions 779  
Set Page Transitions Tool 367  
Set Pages Background Tool 369  
Set Scale 1224  
Settings 1795  
Settings Options 933  
Setup Page Transitions Action 237  
Share 841  
Sharepoint 1537  
Shell Extensions 1781  
Show Comments 1237  
Show Comments List 1241  
Show Files Action 142  
Show/Hide a Field 983  
Signatures and Initials 1255  
Signatures Pane 1021  
Signatures Preferences 922  
Snapshot Tool Preferences 926  
Sort Bookmarks 1580  
Sound Tool 1115  
Speech Preferences 928  
Spell Check 1545  
Split Document 1473  
Split Pages 1473  
Split Pages Action 239  
Split Pages Tool 371  
Split/Merge Documents Action 103  
Split/Merge PDFs Tool 327  
Stamp Tool 1188  
Stamps Palette 1188  
Standard Layout 1800  
Sticky Note Tool 1105  
Strikeout Text Tool 1130  
Submit a Form 976  
Summarize Comments 1231  
Summarize Comments Action 268  
Summarize Comments Tool 400  
Support Forum 1596  
Swap Pages 1477  
Switches for EXE Installers 34

Switches for MSI Installers 22  
System Requirements 21

## - T -

Tab Order of Forms 1437  
Tabs Guide 770  
Text Box Tool 1094  
Text Format 807  
Text Matching Options 1552  
Thumbnails 1000  
Timestamp PDFs Tool 430  
Title Formatting 1552  
Tool Actions Sequence 57  
Tool Categories 57  
Tool Content Options 1783  
Tool Properties 1788  
Tools Preferences 930  
Transform 948  
Trim Box 482  
Typewriter Tool 1089

## - U -

Underline Text Tool 1125  
Update Preferences 932  
User Interface 57

## - V -

Validate Bookmarks 1582  
View Tab 986

## - W -

Watermarks in Editor 1491  
WebLinks 956  
With Blank Pages 797  
Workspace Guide 750

## - X -

XMP Metadata 843

## - Z -

Zoom In/Out Tool 1067